

TOSHIBA

HD-A2KU

HD DVD player

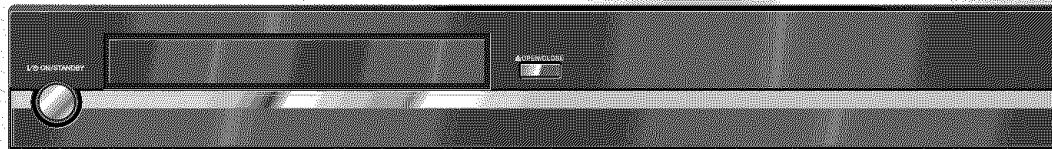

OWNER'S MANUAL

HD DVD

DVD
VIDEO

COMPACT
disc
DIGITAL AUDIO

DOLBY
DIGITAL • PLUS

DOLBY
TRUE HD

DIGITAL
dts
SURROUND

HDMI

SHARC
PROCESSOR
by Analog Devices

Introduction

Connections

(Basic)

(Advanced)

connection

Others

SAFETY PRECAUTIONS

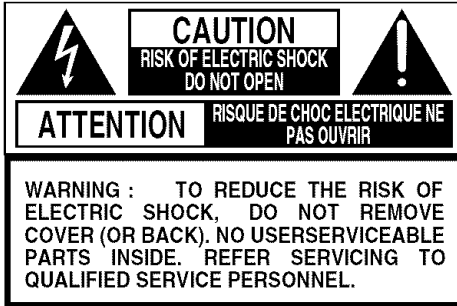

The lightning flash with arrowhead symbol, within an equilateral triangle, is intended to alert the user to the presence of uninsulated "dangerous voltage" within the product's enclosure that may be of sufficient magnitude to constitute a risk of electric shock to persons.



The exclamation point within an equilateral triangle is intended to alert the user to the presence of important operating and maintenance (servicing) instructions in the literature accompanying the appliance.

WARNING: TO REDUCE THE RISK OF FIRE OR ELECTRIC SHOCK, DO NOT EXPOSE THIS APPLIANCE TO RAIN OR MOISTURE. DANGEROUS HIGH VOLTAGES ARE PRESENT INSIDE THE ENCLOSURE. DO NOT OPEN THE CABINET. REFER SERVICING TO QUALIFIED PERSONNEL ONLY.

CAUTION: TO PREVENT ELECTRIC SHOCK, MATCH WIDE BLADE OF PLUG TO WIDE SLOT, FULLY INSERT.

ATTENTION: POUR EVITER LES CHOCS ELECTRIQUES, INTRODUIRE LA LAME LA PLUS LARGE DE LA FICHE DANS LA BORNE CORRESPONDANTE DE LA PRISE ET POUSSER JUSQU'AU FOND.

CAUTION: This HD DVD player employs a Laser System.
To ensure proper use of this product, please read this owner's manual carefully and retain for future reference. Should the unit require maintenance, contact an authorized service location - see service procedure.

Use of controls or adjustments or performance of procedures other than those specified herein may result in hazardous radiation exposure.

To prevent direct exposure to laser beam, do not try to open the enclosure.
Visible and invisible laser radiation when open and interlocks defeated.
DO NOT STARE INTO BEAM.

FCC NOTICE: This equipment has been tested and found to comply with the limits for a Class B digital device, pursuant to part 15 of the FCC Rule. These limits are designed to provide reasonable protection against harmful interference in a residential installation.

This equipment generates, uses, and can radiate radio frequency energy and, if not installed and used in accordance with the instructions, may cause harmful interference to radio communications.

However, there is no guarantee that interference will not occur in a particular installation. If this equipment does cause harmful interference to radio or television reception, which can be determined by turning the equipment off and on, the user is encouraged to try to correct the interference by one or more of the following measures:

- Reorient or relocate the receiving antenna.
- Increase the separation between the equipment and receiver.
- Connect the equipment into an outlet on a circuit different from that to which the receiver is connected.
- Consult the dealer or an experienced radio/TV technician for help.

WARNING: Changes or modifications made to this equipment, not expressly approved by Toshiba, or parties authorized by Toshiba, could void the user's authority to operate the equipment.

The instructions shall state that an ALL-POLE MAINS SWITCH with a contact separation of at least 3 mm in each pole shall be incorporated in the electrical installation of the building.

CAUTION: These servicing instructions are for use by qualified service personnel only. To reduce the risk of electric shock do not perform any servicing other than that contained in the operating instructions unless you are qualified to do so.

In the spaces provided below, record the Model and Serial No. located on the rear panel of your player.

Model No. _____ Serial No. _____

Retain this information for future reference.

Location of the required label

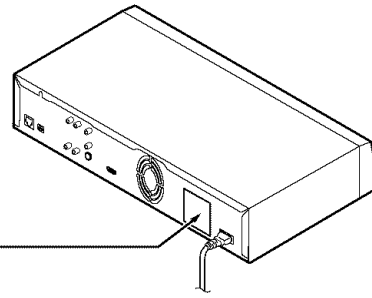

IMPORTANT SAFETY INSTRUCTIONS

1. Read these instructions.
2. Keep these instructions.
3. Heed all warnings.
4. Follow all instructions.
5. Do not use this apparatus near water.
6. Clean only with dry cloth.
7. Do not block any ventilation openings. Install in accordance with the manufacturer's instructions.
8. Do not install near any heat sources such as radiators, heat registers, stoves, or other apparatus (including amplifiers) that produce heat.
9. Do not defeat the safety purpose of the polarized or grounding-type plug. A polarized plug has two blades with one wider than the other. A grounding type plug has two blades and a third grounding prong. The wide blade or the third prong are provided for your safety. If the provided plug does not fit into your outlet, consult an electrician for replacement of the obsolete outlet.
10. Protect the power cord from being walked on or pinched particularly at plugs, convenience receptacles, and the point where they exit from the apparatus.
11. Only use attachments/accessories specified by the manufacturer.
12. Use only with the cart, stand, tripod, bracket, or table specified by the manufacturer, or sold with the apparatus. When a cart is used, use caution when moving the cart/apparatus combination to avoid injury from tip-over.
13. Unplug this apparatus during lightning storms or when unused for long periods of time.
14. Refer all servicing to qualified service personnel. Servicing is required when the apparatus has been damaged in any way, such as power-supply cord or plug is damaged, liquid has been spilled or objects have fallen into the apparatus, the apparatus has been exposed to rain or moisture, does not operate normally, or has been dropped.



ADDITIONAL SAFETY INSTRUCTIONS

15. Do not overload wall outlets; extension cords, or integral convenience receptacles as this can result in a risk of fire or electric shock.
16. Apparatus should not be exposed to dripping or splashing and no objects filled with liquids, such as vases, should not be placed on the apparatus.
17. Keep your fingers well clear of the disc tray as it is closing. Neglecting to do so may cause serious personal injury.
18. Do not place anything on top of this unit.
19. Do not place the apparatus on amplifiers or equipment that may produce heat.
20. Do not cover the ventilating holes for the inside cooling fan.
21. Do not use a cracked, deformed, or repaired disc. These discs are easily broken and may cause serious personal injury and apparatus malfunction.
22. If the apparatus should smoke or smell, immediately disconnect the power cord from the wall outlet. Wait until the smoke or smell stops, then ask your dealer for a check and repair. Neglecting to do so may cause fire.
23. During thunderstorms, do not touch the connecting cables or the apparatus.
24. Handling the cord on this product or cords associated with accessories sold with this product, will expose you to lead, a chemical known to the State of California to cause birth defects or other reproductive harm. Wash hands after handling.

Precautions

Notes on handling

- Never disconnect the power cord from a wall outlet while the player is turned on, unless it is in an emergency. Doing so may cause malfunction.
- When shipping the player, the original shipping carton and packing materials come in handy. For maximum protection, repack the unit as it was originally packed at the factory.
- Do not use volatile liquids, such as insect spray, near the player. Do not leave rubber or plastic products in contact with the player for a long time. They will leave marks on the finish.
- The top and rear panels of the player may become warm after a long period of use. This is not a malfunction.

When not in use

- For usual absence
Be sure to remove the disc from the player and turn off the power.
- Prolonged absence
Unplug the player from a wall outlet.

Notes on locating

- Place the player on a level surface. Do not use it on a shaky or unstable surface such as a wobbly table or inclined stand. The loaded disc may dislodge from its proper position and cause damage to the player.
Before placing the player, make sure that the surface can stand the weight of the player. Never place the player in a high location to avoid damage to the product or person by an accidental fall of the player.
- When you place this player near a TV, radio, or VCR, the playback picture may become poor and the sound may be distorted depending on the condition and location of said equipment. In such an event, place the player as far away much as possible from the TV, radio, or VCR.
- To avoid damage to this product, never place or store the unit in direct sunlight; hot, humid areas; or areas subject to excessive dust, oily smoke, cigarette smoke or vibration.

Notes on cleaning

Use a soft, dry cloth for cleaning.

- Do not use any type of solvent, such as thinner or benzene, as they may damage the surface of the player.

About the volume level

The volume level of some commercial DVD discs may seem lower than that of audio CDs, other software, etc. If you turn up the volume of the TV or amplifier to play such discs, be sure to turn it back down after playback finishes.

Playback restrictions

This owner's manual explains the basic instructions for this player. Some HD DVD discs or DVD video discs are produced in a manner that allows specific or limited operation during playback. As such, the player may not respond to all operating commands. This is not a defect in the player. Please refer to the notes on compatible discs later in this Introduction and to the discussion of DVD playback and features later in this manual.

“⊘” may appear on the TV screen during operation.

“⊘” means that the operation is not permitted by the player or the disc.

About software

Because of problems and errors that can occur during the creation of HD DVD, DVD and CD software and/or the manufacture of HD DVD, DVD and CD discs, Toshiba cannot assure that this player will successfully play every disc bearing the HD DVD, DVD and CD logos. If you happen to experience any difficulty playing an HD DVD, DVD and CD disc on this player, please contact Toshiba Customer Service.

Some differences

The HD DVD player operates more like a computer and differently than a standard DVD player. In addition to containing a microprocessor, it contains an operating system, random access memory (RAM), and an HD DVD drive. The operating system includes software that is transferred to the RAM when the machine is turned on and at other times during operation. This transfer can take time. Therefore, when you turn the HD DVD player on, it may take a little while before it is ready to use. Likewise, other functions may not be performed as quickly as they would on other AV equipment. Please take these factors into consideration as you use the HD DVD player.

Notes on moisture condensation

Moisture condensation damages the unit. Please read the following carefully.

Moisture condensation occurs, for example, when you pour a cold drink into a glass on a warm day. Drops of water form on the outside of the glass. In the same way, moisture may condense on the optical pick-up lens inside this unit, one of the most crucial internal parts of the unit.

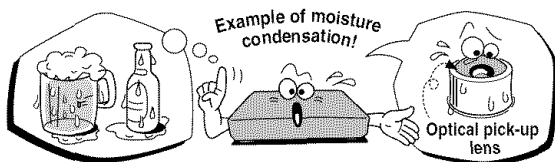

Moisture condensation occurs during the following cases.

- When you bring the unit directly from a cold place to a warm place.
- When you use the unit in a room where you just turned on the heater, or a place where the cold wind from the air conditioner directly hits the unit.
- In summer, when you use the unit in a hot and humid place just after you move the unit from an air conditioned room.
- When you use the unit in a humid place.

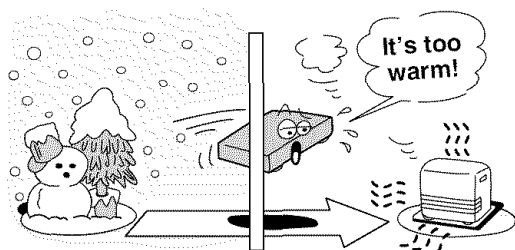

Do not use the unit when moisture condensation may occur.

If you use the unit in such a situation, it may damage discs and internal parts. Connect the power cord of the unit to the wall outlet, turn on the unit, remove the disc, and leave it for two or three hours. After two or three hours, the unit will have warmed up and evaporated any moisture. Keep the unit connected to the wall outlet and moisture condensation will seldom occur.

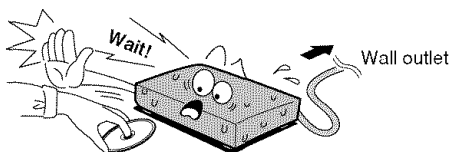

Notes on copyright

- The unauthorized recording, use, display, distribution, or revision of television programs, videotapes, HD DVDs, DVDs, CDs and other materials, is prohibited under the Copyright Laws of the United States and other countries, and may subject you to civil and/or criminal liability.
- This product incorporates copyright protection technology that is protected by method claims of certain U.S. patents and other intellectual property rights owned by Macrovision Corporation and other rights owners. Use of this copyright protection technology must be authorized by Macrovision Corporation, and is intended for home and other limited viewing uses only unless otherwise authorized by Macrovision Corporation. Reverse engineering or disassembly is prohibited.

Manufactured under license from Dolby Laboratories. Dolby and the double-D symbol are trademarks of Dolby Laboratories.

Manufactured under license from Digital Theater Systems, Inc. U.S. Pat. No's. 5,451,942; 5,956,674; 5,974,380; 5,978,762; 6,226,616; 6,487,535 and other U.S. and world-wide patents issued and pending. "DTS" and "DTS Digital Surround" are registered trademarks of Digital Theater Systems, Inc. Copyright 1996, 2003 Digital Theater Systems, Inc. All Rights Reserved.

HDMI, the HDMI logo and High-Definition Multimedia Interface are trademarks or registered trademarks of HDMI Licensing LLC.

SHARC is a registered trademark and Melody is a trademark of Analog Devices, Inc.

All other brand and product names mentioned in this manual are trademarks and/or registered trademarks of their respective holders.

Features

Playback of HD DVD video discs

HD DVD video discs are high-density, high-capacity discs.

- The HD DVD disc standard has been approved by the DVD forum.
- HD DVD (single layer): 15 GB
HD DVD (dual layer): Maximum capacity of 30 GB
A single layer single sided disc (15 GB) has capacity of about 8 hours in 1125 line high definition picture; about 48 hours in 525 line standard definition picture (depending on bitrate of pre-recorded contents).
*1GB means 1,000,000,000 bytes.
- HD DVD Twin Format Discs have both HD DVD and DVD layers on one side. HD DVD Combination DVD Discs have HD DVD material on one side and standard DVD material on the other side. Because both disc types are new, such discs may not operate properly in this player.
- To view high-definition picture in HD DVD discs, an HDTV display (720p, 1080i) is required.
- Connect an HDTV set to the COMPONENT OUTPUT jacks or the HDMI OUTPUT jack on this player.
- Some discs may require use of HDMI OUTPUT for viewing of high resolution material.

Compatible with multiple disc types

- Playback of commercial HD DVD video disc, DVD video, and Audio CD
- Playback of HD DVD-R (disc recorded in HDVideo mode), DVD-RW (disc recorded in DVD VR mode or DVD video mode), and DVD-R
- Playback of CD-RW and CD-R (Audio CD of CD-DA format)

Because HD DVD is a new format, disc compatibility issues with new and existing format discs are possible. Not all discs are compatible. If you experience compatibility problems, please contact Toshiba Customer Service.

Blu-ray Discs cannot be played on this player.

Internet connection feature (LAN port)

- Some HD DVD discs enable you to access special HD DVD sites. If an HD DVD site includes content such as movie trailers, you can watch the content on the player via the Internet if your internet connection provides sufficient bandwidth.

Compatibility notes

- For compatibility, see  page 28.

Various output jacks

- An HDMI jack for connecting a single cable to output video and audio signals
- Component jacks

Certain system requirements

For high definition video playback:

- High definition display (720p and 1080i input capable).
- HD DVD disc with high definition content.
- HDMI or HDCP capable DVI input on your display device required for some content (as specified by disc authors).
- For up-conversion of standard definition DVD, an HDMI or HDCP capable DVI input on your display device is required for copy protected content.

For Dolby® Digital Plus, Dolby TrueHD and DTS-HD (DTS core only) multi-channel audio playback:

- Receiver or processor/amp combination that has a decoder compatible with these sound systems or HDMI™ multi-channel LPCM capable audio input.
- Main, center, surround speakers and subwoofer as necessary for chosen format.

For on-line interactive features:

- Ethernet connection to customer supplied always-on broadband internet service.
- Some features may require higher bandwidth.

Customer support

To reach Toshiba Customer Support in the U.S., please call 1 (800) 319-6684 or visit www.tacp.com/customersupport.

To reach Toshiba Customer Support in Canada, please call 1 (800) 268-3404 or visit www.toshiba.ca and click on support.

This HD DVD player is manufactured under the HD DVD Format adopted by DVD Forum. DVD Forum approved AACSS (Advance Access Content System) as content protection system for HD DVD Format like it approved CSS (Content Scramble System) for DVD Format. Therefore, certain restrictions are imposed on play, analog signal output, etc. of AACSS protected contents.

When you use pre-recorded contents, the contents may designate whether or not to apply such restrictions.

As those restrictions may be adopted and/or changed and announced by AACSS after the production of this product, the operation of this product and restrictions thereon may vary depending on the time you purchase this product.

To obtain updated information about AACSS and this product, please contact the following:

*In the U.S., please call 1 (800) 319-6684 or visit www.tacp.com/customersupport.

*In Canada, please call 1 (800) 268-3404 or visit www.toshiba.ca and click on support.

Accessories

Accessories

Check that the following accessories are supplied.

Remote control
Batteries
(AAA)x2

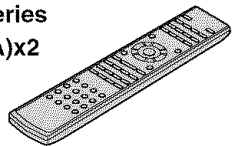

Audio/video cable

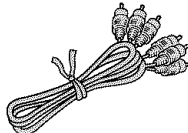

Power cord

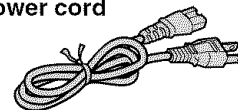

Caution

- Do not use this power cord with any device other than this player.

Table of Contents

1 Introduction	■ SAFETY PRECAUTIONS	2
	■ IMPORTANT SAFETY INSTRUCTIONS.....	4
	■ Precautions	6
	■ Features.....	8
	■ Accessories.....	9
	■ Index to parts and controls.....	12
	● Front panel	12
	● Rear panel.....	13
	● Display	14
	● Remote control	15
	■ Preparation of the remote control.....	16
	● Loading batteries	16
	● Operating with the remote control.....	16
	● Programming for TV control	17
● Operating your TV with the remote control.....	17	
■ Hint on reading this manual	18	
● Icons for disc compatibility	18	
● Instructions and actual buttons.....	18	
2 Connections	■ Connecting to a TV.....	20
	■ Connecting to an audio system	25
3 Playback (Basic)	■ Disc compatibility	28
	■ Powering on/Loading a disc	30
	■ Playing a disc.....	31
	● Stopping playback / Pausing playback	31
	● Playing from the top menu	32
	● Using A/B/C/D buttons.....	32
	● Playing from a menu in a recorded disc	32
	● Selecting the sound	33
	● Selecting the sound of a disc recorded in DVD VR mode	33
	● Selecting subtitles	34
	● Selecting the camera angle	34
■ Playing at various speeds.....	35	
● Locating by entering a section number	36	
● Locating by entering elapsed time	36	
● Resuming playback from the location last stopped (Title resume).....	36	

4 Playback (Advanced)	■ Playing repeatedly (Repeat playback)	38
	■ Using EXTENSION ports	39
	■ Using the cursor function	39
	■ Checking the current status and settings	40

5 Internet connection	■ Internet connection feature (Outline).....	42
	■ Internet connection feature (Preparation).....	44
	■ Internet connection feature (Operation)	47

9 Others	■ Customizing the function settings.....	50
	● Picture	52
	● Audio.....	53
	● Language.....	54
	● Ethernet.....	55
	● General.....	56
	● Firmware update	58
	■ Language code list	59
	■ Output sound conversion table.....	60
	■ License information on the software used in the TOSHIBA HD DVD player...	62
	■ Before calling service personnel	70
	■ Specification	71
	■ Limited United States Warranty.....	72
■ CANADIAN WARRANTY INFORMATION.....	74	
■ INFORMATION ON CUSTOMER SUPPORT	Back cover	

Index to parts and controls

See pages with arrows for details.

Front panel

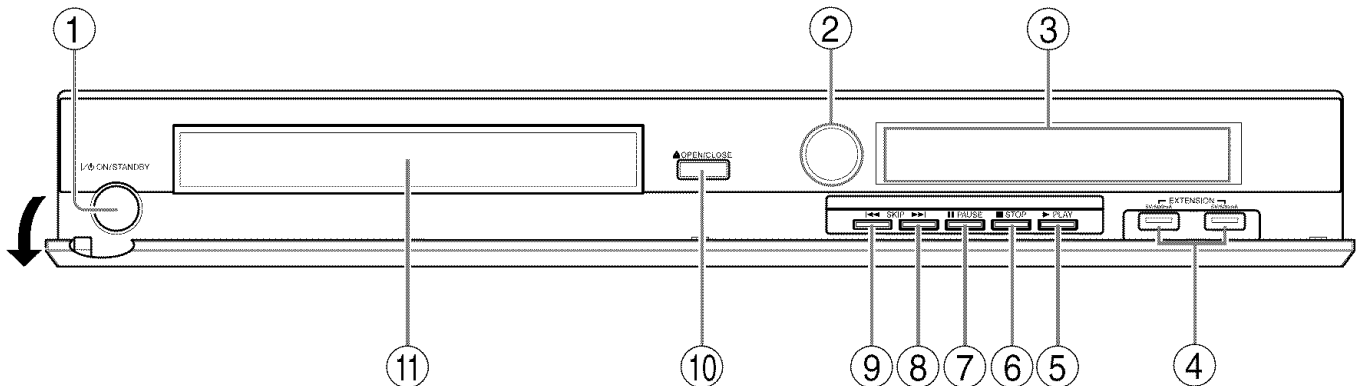

* The above illustration displays the front panel with the cover open.

Note

- Do not place a heavy object on the cover while it is open. Doing so may damage the player.

- | | |
|---|---|
| <p>① ON/STANDBY button / ON/STANDBY indicator
➡ page 30</p> <p>Turns the power on/restores the unit to the standby mode.</p> | <p>⑧ ▶▶ (SKIP) button ➡ page 35</p> <p>Skips to the next chapter or track.</p> |
| <p>② Remote sensor ➡ page 16</p> | <p>⑨ ◀◀ (SKIP) button ➡ page 35</p> <p>Skips to the previous chapter or track.</p> |
| <p>③ Front panel display ➡ page 14</p> | <p>⑩ OPEN/CLOSE button ➡ page 30</p> <p>Opens and closes the disc tray.</p> |
| <p>④ EXTENSION ports ➡ page 39</p> | <p>⑪ Disc tray ➡ page 30</p> <p>Loads a disc into the disc drive.</p> |
| <p>⑤ ▶ (PLAY) button ➡ page 31</p> <p>Starts playback.</p> | |
| <p>⑥ ■ (STOP) button ➡ page 31</p> <p>Stops playback.</p> | |
| <p>⑦ (PAUSE) button ➡ page 31</p> <p>Stops playback momentarily.</p> | |

Rear panel

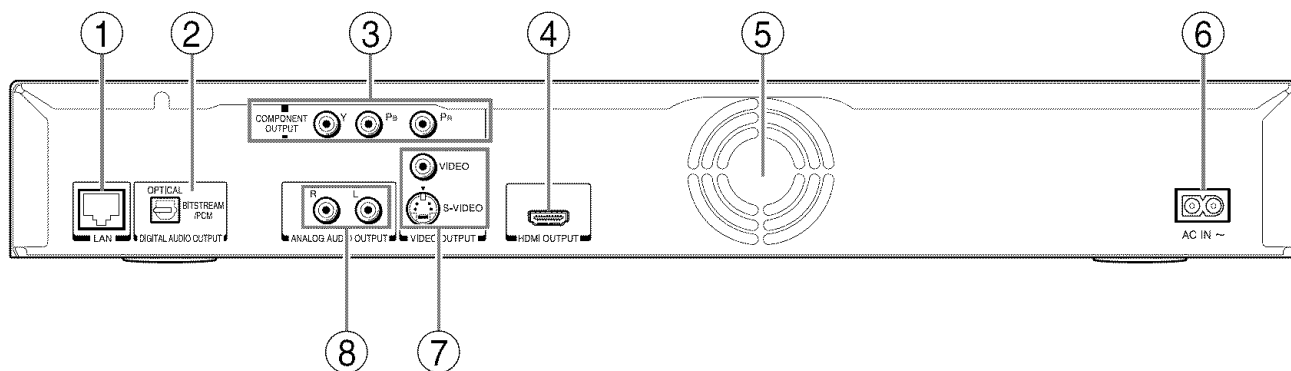

① LAN port ➔ page 44

Use this to connect to a network with an always-on broadband connection.

② DIGITAL AUDIO OUTPUT BITSTREAM/PCM OPTICAL jack ➔ page 25

Outputs digital audio signals.

Connect to a digital audio input on an amplifier equipped with digital audio decoder.

When connecting the optional digital cable, fit the connector into the jack firmly.

③ COMPONENT OUTPUT jacks ➔ page 22

Outputs video signals to a connected TV or monitor.

Connect to a TV or monitor equipped with component video jacks.

④ HDMI OUTPUT jack ➔ page 21

Outputs video/audio signals to a connected TV, monitor or AV amplifier.

Connect to a TV, monitor or AV amplifier equipped with HDMI input.

⑤ Ventilation fan

Do not cover the ventilation holes.

⑥ AC IN socket ➔ page 21, 22

Connect the supplied power cord.

⑦ VIDEO OUTPUT (VIDEO, S-VIDEO) ➔ page 22

Outputs video signals to a connected TV or amplifier.

⑧ ANALOG AUDIO OUTPUT jacks ➔ page 22

Outputs audio signals to a connected TV or AV amplifier.

Index to parts and controls (Continued)

Display

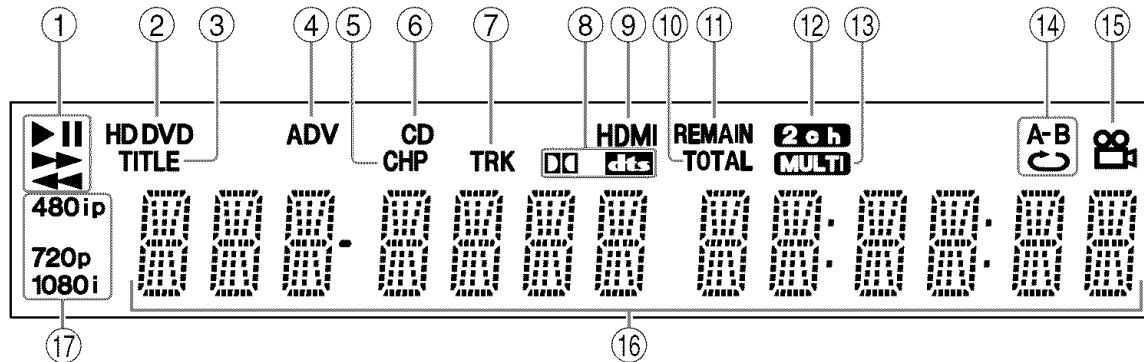
① **Status indicator**

- ▶ : Playing
- ⏸ : Pausing
- ⏩ : Fast forward playback
- ⏪ : Fast reverse playback

② **Disc indicator**

- HD DVD : Illuminates when an HD DVD disc is loaded.
- DVD : Illuminates when a DVD disc is loaded.

③ **TITLE indicator**

- Illuminates when a title number is displayed.

④ **ADV (Advanced) indicator**

- Illuminates when advanced content is played.

⑤ **CHP (Chapter) indicator**

- Illuminates when a chapter number is displayed.

⑥ **CD indicator**

- Illuminates when a CD is loaded.

⑦ **TRK (Track) indicator**

- Illuminates when a track number is displayed.

⑧ **Sound format indicator**

- ⓁⓁ : Illuminates when Dolby Digital sound is output.
- ⓁⓁⓁ : Illuminates when DTS sound is output.

⑨ **HDMI Indicator**

- Illuminates when HDMI connection is verified between the player and another device.

⑩ **TOTAL indicator**

- Illuminates when the total playing time of the disc is displayed.

⑪ **REMAIN (Remaining) indicator**

- Illuminates when a remaining playback time is displayed.

⑫ **2ch indicator**

- Illuminates when 2 channel (L/R) sound is output.

⑬ **MULTI indicator**

- Illuminates when 5.1 channel sound is output.

⑭ **Repeat mode indicator**

- Illuminates when playing in repeat mode.

⑮ **Angle icon indicator**

- Illuminates when playing a scene recorded with multi angles.

⑯ **Multi display**

- Displays the total playing time of the disc, elapsed time, remaining time, title number, chapter number or message, etc.

⑰ **Video output format indicator**

- Displays the video output format currently selected.
- 480i : 480 interlace
- 480p : 480 progressive
- 720p : 720 progressive
- 1080i : 1080 interlace

■ **Switching the display**

- DISPLAY Every time you press DISPLAY button on the remote control, the display changes the contents.
- The display may not change, depending on the disc conditions.

■ **Dimming the display**

- Pressing DIMMER button on the remote control changes the brightness of the display.

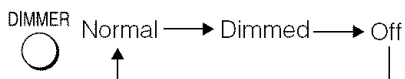

- Turning off the power resets this setting.

Remote control

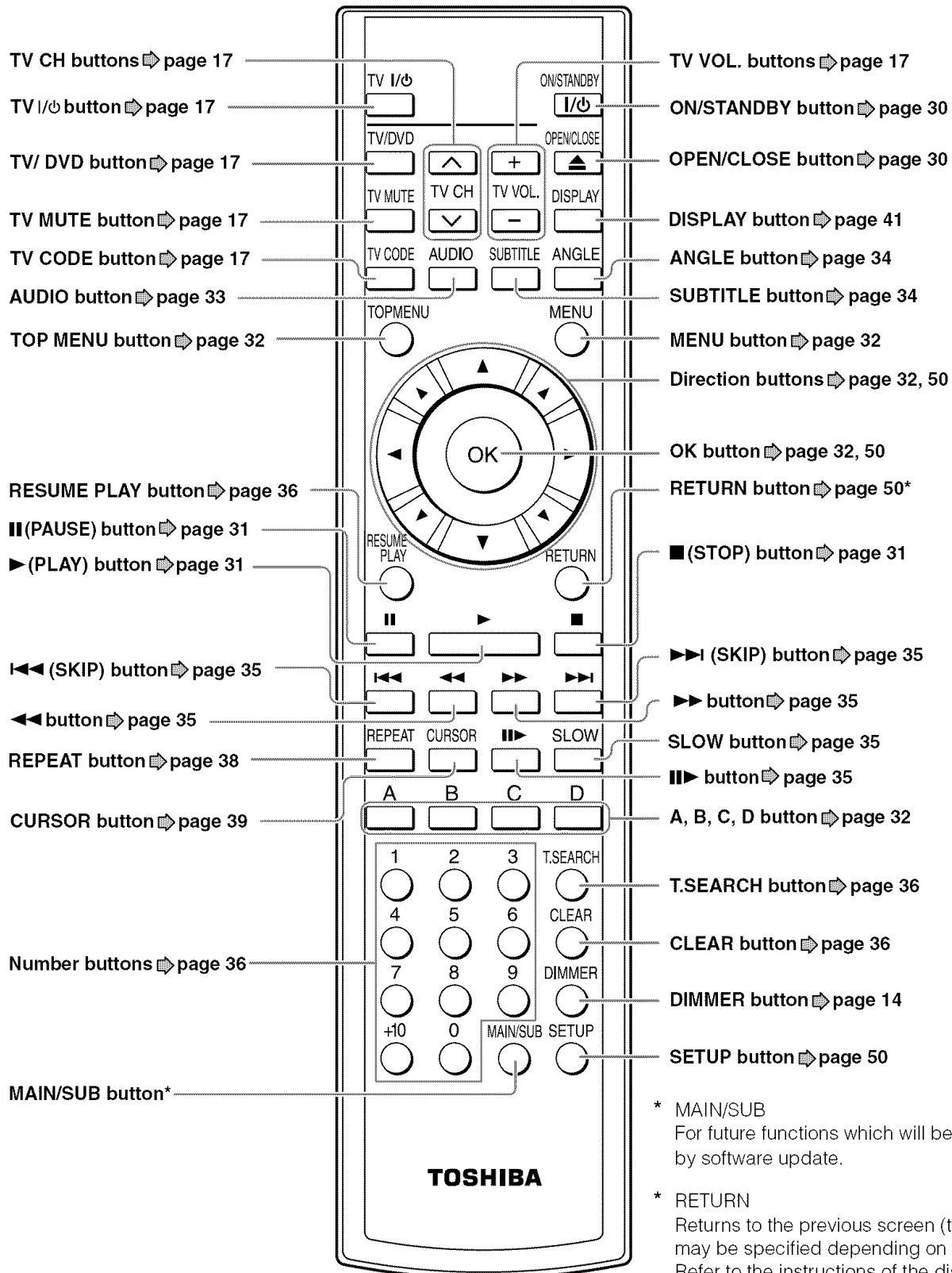

Preparation of the remote control

Set up the remote control to operate the player and your TV.

Loading batteries

1 Open the cover.

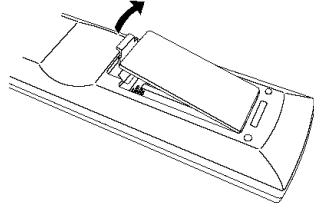

2 Insert batteries.

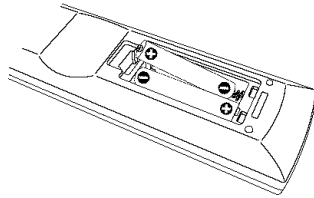

- Use 2 batteries (AAA sizes).
- Make sure to match the + and – on the batteries to the marks inside the battery compartment.

3 Close the cover.

Operating with the remote control

Point the remote control at the remote sensor and press the buttons.

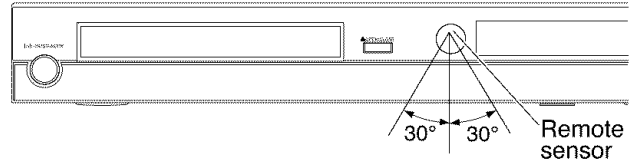

Distance: About 7 m (23 ft) from the front of the remote sensor

Angle : About 30° in each direction of the front of the remote sensor

Within about 7 m (23 ft)

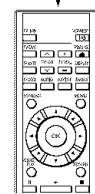

Notes

- Do not drop or give the remote control a shock.
- Do not leave the remote control near an extremely hot or humid place.
- Do not spill water or put anything wet on the remote control.
- Do not disassemble the remote control.
- Dispose of batteries in a designated disposal area.
- Batteries should always be disposed of with the environment in mind.
- Always dispose of batteries in accordance with applicable laws and regulations.
- If the remote control does not operate correctly, or if the operating range becomes reduced, replace all batteries with new ones.
- When necessary to replace batteries in the remote control, always replace all batteries with new ones. Never mix battery types or use new and used batteries in combination.
- Be sure to use AAA size batteries.
- Always remove batteries from remote control if they are dead or if the remote control is not be used for an extended period of time. This will prevent battery acid from leaking into the battery compartment.

Caution

- Never throw batteries into a fire.

Programming for TV control

1 While holding , press the number buttons to enter a corresponding brand code (see below) of your TV.

e.g. To enter 0001



Hold down.

- Some brands have several codes. Try one by one until the remote control can operate your TV.

2 Release .
The brand code is memorized.

Notes

- TOSHIBA code is already set when you operate this player for the first time.
- When replacing the batteries of the remote control, re-enter the brand code of your TV.

Operating your TV with the remote control

Point the remote control to your TV after you have entered the brand code. Operate your TV with the buttons below.

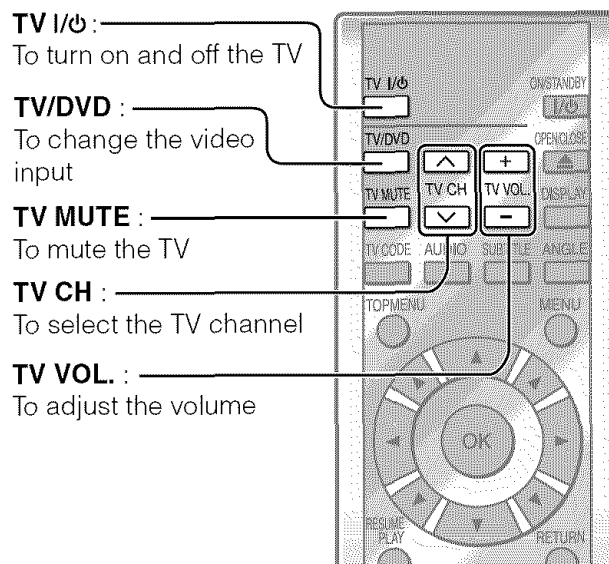

TV I/O :
To turn on and off the TV

TV/DVD :
To change the video input

TV MUTE :
To mute the TV

TV CH :
To select the TV channel

TV VOL. :
To adjust the volume

Notes

- For some TVs, pressing the volume button once may change the volume by more than one level.
- Even after the player's remote control is programmed, it may not operate some or all of the features on your other device.

If this happens and you wish to use those features, you will need to use the device's original remote control.

Brand code table

Brand name	Brand code						
Toshiba	0001	0021	0071	0411	0431	0831	
	0841	0851	0881	1341	1611	1621	
	1681	1781	1951	2121	2461	2491	
	4071	4371	5951	5971	6041	6101	
	6111	6121	6131	6141			
Bell & Howell	0081	0431					
Citizen	0051	0381	0471	0551	0621	0851	
	1561						
Curtis Mathes	0051	0391	0431	0531	0621	0851	
	1521	1561					
Emerson	0051	0111	0121	0141	0151	0161	
	0201	0211	0351	0381	0431	0521	
	0561	0571	0621	0691	1241	1291	
	1371	1561	2481	4871			
Fisher	0251	0401	0431	1151	2451	2461	
	0001	0041	0051	0091	0181	0321	
	0371	0391	0591	0621	0711	0741	
	1041	1471	1521	2481	4691	4881	
	4891						
GE							

Brand name	Brand code					
Goldstar	0051	0061	0161	0231	0451	0501
	0621	0661	0771	0961	1431	1561
	2491					
Hitachi	0031	0051	0161	0191	0301	0601
	0621	0641	0671	0811	0821	0951
	1011	1061	1241	1361	1651	1711
	1731	1741	1751	1761	2041	2051
	2131	2381	4121	4731	4901	4911
Infinity	4921	4931	4941	4951	4961	5631
	0631					
JBL	0631					
	0101	0161	0191	0241	0331	0511
JVC	0561	0601	0741	0991	1321	1421
	2161	2171	4341	4351	4701	4711
	4721	4741	4751	4761	4771	4781
	4791	4801	4811	4971	4981	4991
	5001	5011	5021	5031	5041	5051
	5061	5071	5081	5091	5101	5111
	5121	5131	5141	5151	5161	5171
	5181	5191	5201			

(Continued)

Preparation of the remote control (Continued)

Brand name	Brand code					
LXI	0311	0391	0411	0431	0621	0631
	0881	1041	1171	1521	2491	
Maganvox	0051	0271	0291	0341	0361	0421
	0551	0621	0631	0661	0971	0981
	1131	2221	5221	5231	5241	
Marantz	0051	0481	0621	0631	0641	2491
Memorex	0081	0431	0501	0621	2491	4421
	5251					
MGA	0051	0251	0261	0371	0501	0621
	0661	0761				
Mitsubishi	0051	0251	0261	0281	0371	0491
	0501	0621	0661	0761	2231	2241
	5261	5271				
MTC	0051	0501	0621	0851		
NAD	0311	0411	0621	0881	1061	
Optonica	0541	1101				
Panasonic	0631	0711	0741	1271	1351	1401
	1501	1701	1791	1801	2111	2151
	2301	2321	4101	5281	5291	5301
	5311	5321	5331	5341	5351	5361
	5371	5381	5391	5661		
Philco	0051	0161	0271	0291	0361	0421
	0501	0551	0621	0631	0661	0711
Philips	0051	0161	0271	0321	0361	0421
	0461	0551	0631	0661	0711	2141
	2351	5401	5411	5421	5431	5451
	5461	5471	5481	5491	5501	5531
	5541	5551	5601	5621		
Pioneer	0051	0621	0681	0721	0751	1061
	1241	1581	1971	4081	4111	
Proton	0051	0161	0621	0651	2491	
Quasar	0711	0741	0801	1401	2281	5651
	5661					
Radio Shack	0431	1521	2481			
Radio Shack/Realistic	0051	0161	0381	0391	0431	0541
	0621	1431	1561			
RCA	6641	0001	0051	0221	0391	0501
	0621	0661	0711	0871	0911	0921
	0941	1001	1041	1071	1091	1181
	1211	1241	1301	1461	1491	1521
	1531	2291	2481	4361	5671	5681
	5691	5701	5711	5721		









Brand name	Brand code					
Realistic	0431	1521				
Runco	0011					
Samsung	0051	0161	0501	0531	0621	0661
	0851	0931	1021	1141	1431	1561
	1591	1601	1771	1811	1821	1831
	1841	1851	1861	1931	2081	2101
	2311	4011	4061	5731		
Sanyo	0051	0261	0401	0431	0791	0901
	1151	2461				
Sears	0051	0151	0191	0251	0311	0331
	0391	0401	0411	0431	0621	0661
	0881	1041	1081	1151	1481	1521
	2461	2481				
Sharp	0051	0111	0161	0351	0541	0581
	0611	0621	0731	0891	1101	1561
	1721	1871	1881	1941	2181	2341
	5741	5751	5761	5771		
Sony	0441	1111	1231	1511	2401	2411
	2431	1891	1901	2061	2421	5781
	5791	5801	5811	5821	5831	5841
	5851	5861	5871	5881	5891	5901
	5911					
Soundesign	0051	0151	0381	0551	0621	2481
Sylvania	0051	0071	0271	0291	0341	0361
	0421	0551	0621	0631	0661	0861
	1441	2191	2201	4151	4441	5921
	5931					
Tandy	1101					
Technics	0741					
Teknika	0051	0081	0151	0161	0191	0341
	0381	0471	0501	0551	0621	0851
	1271	1401	1561	2481		
Wards	0051	0081	0141	0151	0181	0211
	0271	0321	0341	0361	0391	0421
	0501	0541	0621	0631	0661	1051
	1521	2491				
Zenith	0011	0051	0081	0781	1281	1571
	2091	2211	2251	2361	2391	2441
	4821	4831	4841	4851	6151	6161
	6171	6181				

Hint on reading this manual

Icons for function applicability

The following icons are used in this manual to indicate features and/or functions that are applicable to various types of discs.

(For disc compatibility information, see  page 28.)

Icon	Disc	Icon	Disc
	HD DVD video disc		DVD-R
	HD DVD-R (Video mode)		Audio CD
	DVD video disc		CD-RW (CD-DA format)
	DVD-RW		CD-R (CD-DA format)

Instructions and actual buttons

Most instructions are based on remote control operation, unless otherwise noted. You can use the buttons on the remote control and those on the main unit as well when they have the same function. Some functions are available only from the remote control.

2 Connections

Connect your player to your A/V system.

Connecting to a TV

Connecting to an audio system

Connecting to a TV

Connect the player to your TV to view pictures. Follow the steps 1 to 3 below to make your connection.

Step 1 Check the type of video input on your TV.

To view 480p, 720p, 1080i pictures, use the HDMI OUTPUT jack or the COMPONENT OUTPUT jacks to connect to a TV. Some discs may require use of the HDMI OUTPUT jack for viewing of high resolution material.

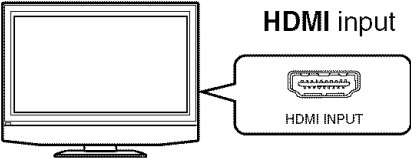
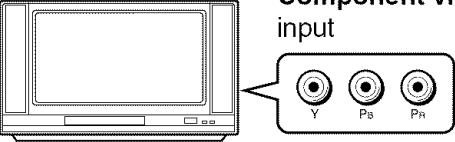
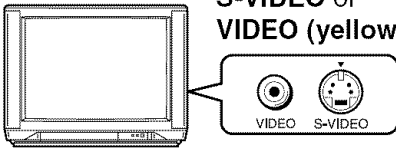
TV input	High definition video	Page
 <p>HDMI input</p> <p>Most recommended*</p>	Viewable.	21
 <p>Component video input</p>	Viewable. (Some discs may be down converted or require HDMI connection.)	22
 <p>S-VIDEO or VIDEO (yellow) input</p>	Down converted. (Some discs may require HDMI or component video connection.)	22

*Why HDMI connection is most recommended?

HD DVD and DVD video disc creators have the option to include copy protection instructions in their discs that prohibit the output of some standard video or high definition video (original 720p or 1080i or up-converted 480i or 480p) from the COMPONENT OUTPUT jacks. If such instructions are present in the disc you are playing, you must use the HDMI OUTPUT jack to view the disc in a high definition format and the COMPONENT OUTPUT jacks, if activated, will output video only in 480i or 480p resolution.

Caution on connection

- Do not power this player using any power cord other than the one supplied with this player.
- Do not use the supplied power cord with any device other than this player.

Notes on connection

- When you connect the player to your TV, be sure to turn off the power and unplug both units from the wall outlet before making any connections.
- Connect the player directly to your TV. If you connect the player to a VCR, TV/VCR combination, video selector or AV amplifier, the playback picture may be distorted due to copy protection.

Step 2 Connect the player to your TV.

Via HDMI input

HDMI stands for High Definition Multimedia Interface. HDMI transfers digital audio and uncompressed digital video on a single cable. As a result, audio cables and video cables don't need to be connected separately to a device.

The HDMI OUTPUT jack is designed to HDMI Version 1.2a.

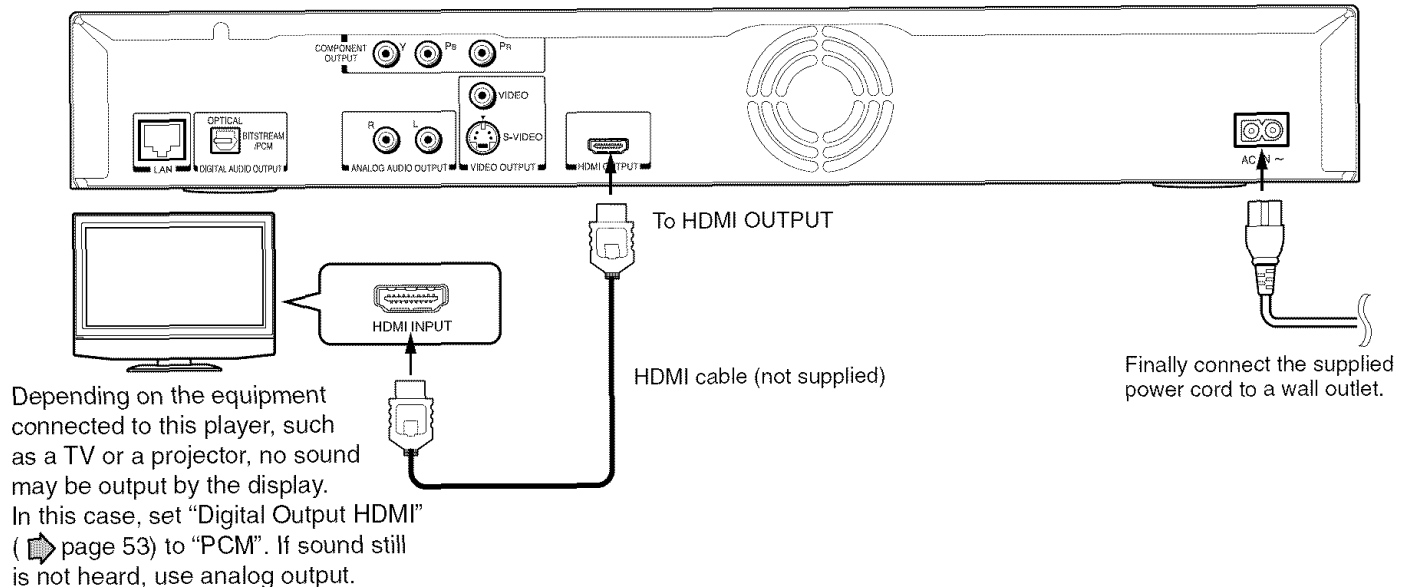

If you use both the HDMI OUTPUT jack and the COMPONENT OUTPUT jacks simultaneously, video output from the player to the TV connected via the COMPONENT OUTPUT jacks may be cut depending on the disc.

HDMI, the HDMI logo and High-Definition Multimedia Interface are trademarks or registered trademarks of HDMI Licensing LLC.

After completing the connection, proceed to ▶ page 23 to make the setting.

Notes

- Refer to the owner's manual for the TV to be connected to this player for more information concerning HDMI connections.
- When the HDMI connection is not verified, the error message appears on the front panel display. In this case, disconnect the HDMI cable then connect it again, or turn off the connected HDMI device then turn it on.
- HDMI output is digital only, DVI analog is not supported.
- HDMI is an evolving technology, so it is possible that some devices may not operate properly with this player.
- Be sure to use an HDMI cable with the HDMI logo (**HDMI**) to connect an HDMI device.
- If your display does not support multi-channel audio, to use multi-channel audio you will need to either use an AV receiver that supports multi-channel audio over HDMI (set "Digital Output HDMI" to "Auto" or to match the decoding capability of your equipment) or use a receiver that has an optical SPDIF digital audio input (set "Digital Output SPDIF" to match the decoding capability of your equipment).
- If you use also the ANALOG AUDIO OUTPUT jacks or the DIGITAL AUDIO OUTPUT BITSTREAM/PCM jack to obtain sounds, the output level from these jacks will be reduced when playing a disc recorded in multi channel while setting "Digital Output HDMI" (▶ page 53) to "Auto" or "PCM". In this case, the output level will be restored by setting to "Downmixed PCM".

Via component video input

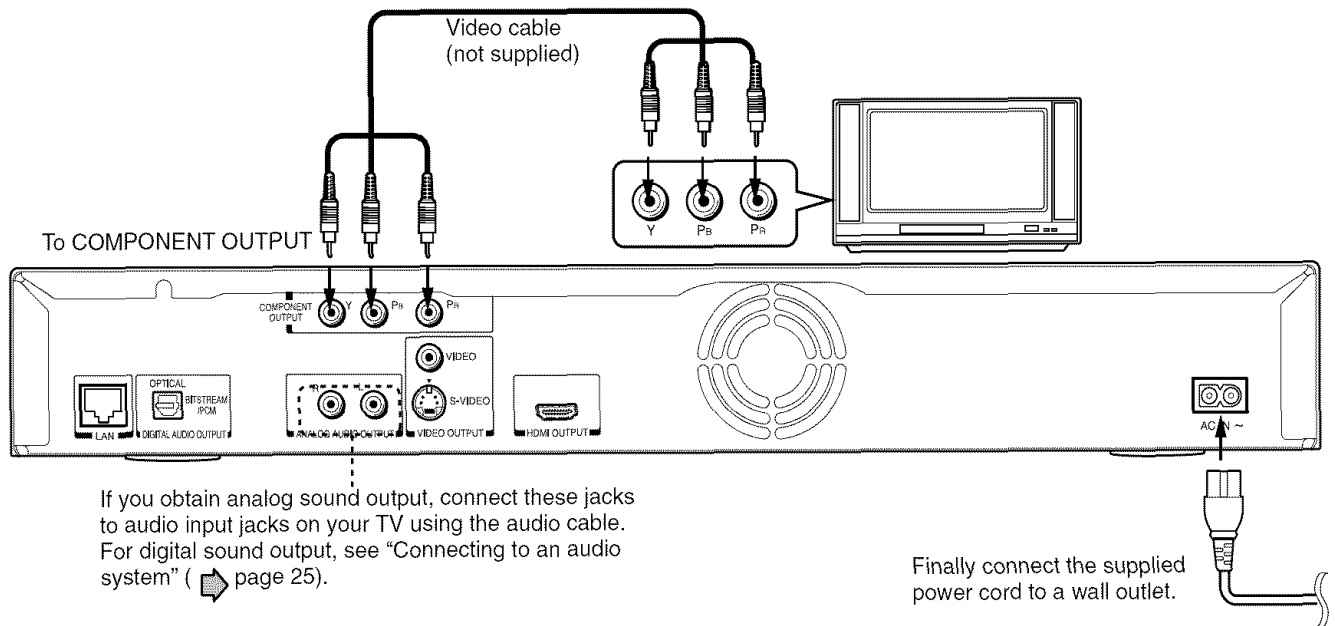

If you use both the HDMI OUTPUT jack and the COMPONENT OUTPUT jacks simultaneously, video output from the player to the TV connected via the COMPONENT OUTPUT jacks may be cut depending on the disc.

After completing the connection, proceed to ▶ page 23 to make the setting.

Via S-VIDEO or VIDEO (yellow) input

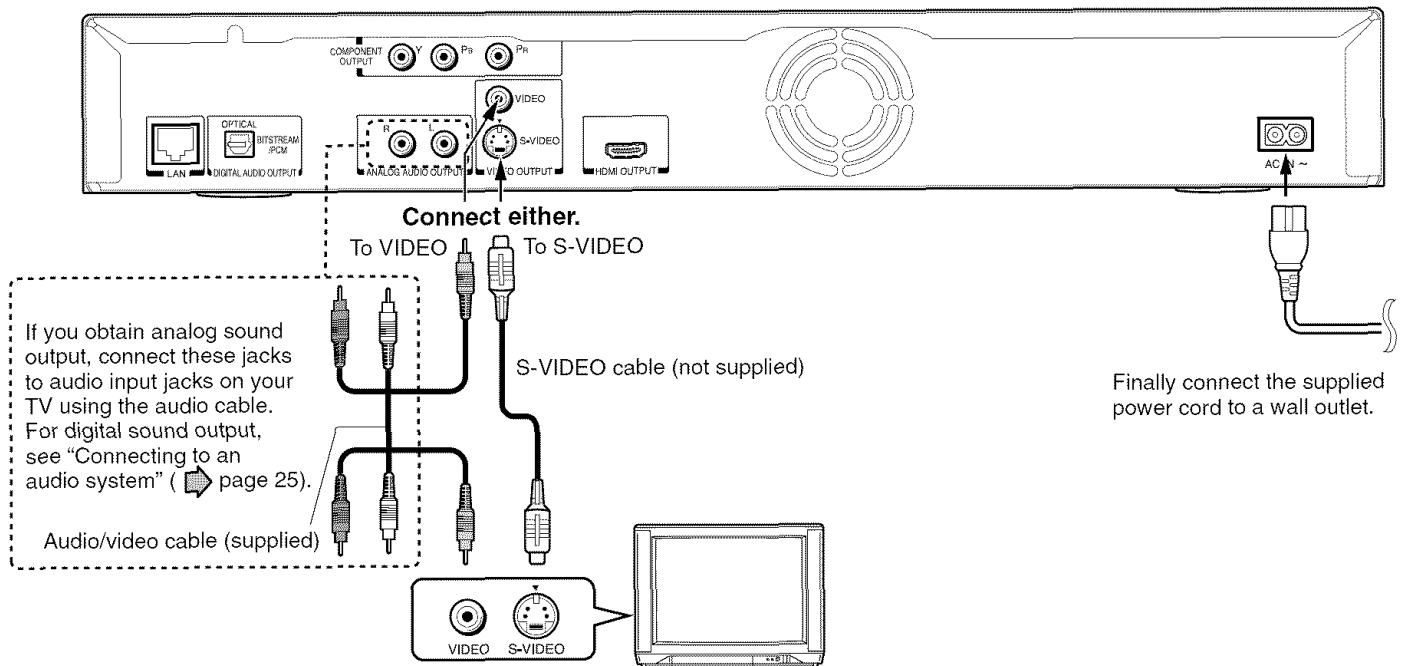

After completing the connection, proceed to ▶ page 23 to make the setting.

Step 3

Make the necessary setting.

Setting of video output resolution of this player

- 1 Turn on the connected TV and select the input from the player.
- 2 Press **ON/STANDBY** to turn on the player (➡ page 30).
- 3 Press **SETUP** to display “SETUP MENU”, if not displayed.

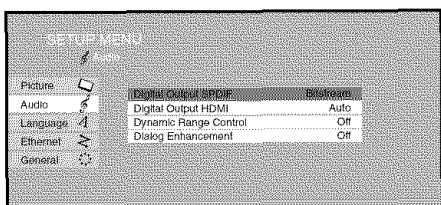
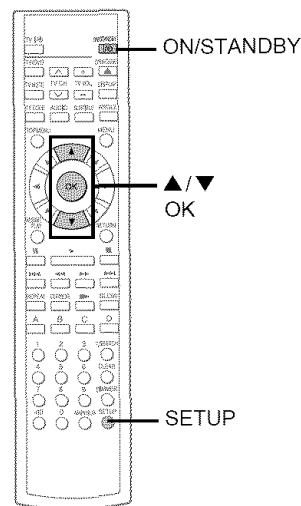
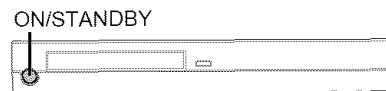

- 4 Press **▲ / ▼** to select “Picture” then press **OK**.
- 5 Press **▲ / ▼** to select “Resolution Setting”, then press **OK**.
- 6 Press **▲ / ▼** to select the resolution according to the performance of your TV as shown in the table below.



TV input	“Resolution Setting”																
<p>HDMI input</p>	<p>Select “up to 1080i”.</p> <ul style="list-style-type: none"> up to 480i up to 480p up to 720p up to 1080i 																
<p>Component video input</p>	<p>Select the resolution according to the performance of the connected TV.</p> <table border="1"> <tr> <td>up to 480i</td> <td>up to 480i</td> <td>up to 480i</td> <td>up to 480i</td> </tr> <tr> <td>up to 480p</td> <td>up to 480p</td> <td>up to 480p</td> <td>up to 480p</td> </tr> <tr> <td>up to 720p</td> <td>up to 720p</td> <td>up to 720p</td> <td>up to 720p</td> </tr> <tr> <td>up to 1080i</td> <td>up to 1080i</td> <td>up to 1080i</td> <td>up to 1080i</td> </tr> </table>	up to 480i	up to 480i	up to 480i	up to 480i	up to 480p	up to 480p	up to 480p	up to 480p	up to 720p	up to 720p	up to 720p	up to 720p	up to 1080i	up to 1080i	up to 1080i	up to 1080i
up to 480i	up to 480i	up to 480i	up to 480i														
up to 480p	up to 480p	up to 480p	up to 480p														
up to 720p	up to 720p	up to 720p	up to 720p														
up to 1080i	up to 1080i	up to 1080i	up to 1080i														
<p>S-VIDEO or VIDEO (yellow) input</p>	<p>No need to set.</p>																

- Refer to the table on the next page for actual resolution of the player par each setting.
- For best output, disc’s native resolution is also important. See the note on ➡ page 24.

- 7 Press **OK**.
- 8 Press **SETUP** to turn off “SETUP MENU”.

The necessary setting is complete. Now your player is ready. Proceed to ➡ page 30 to begin your operation.

■ Output resolution of the player

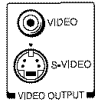
Output jacks on the player	Disc's resolution	“Resolution Setting” (▶ page 23)			
		up to 480i	up to 480p	up to 720p	up to 1080i
HDMI OUTPUT jack 	480i	480i	480p (maximum) ^{1*}	720p (maximum) ^{1*}	1080i (maximum) ^{1*}
	480p	480i	480p (maximum) ^{1*}	720p (maximum) ^{1*}	1080i (maximum) ^{1*}
	720p	480i	480p (maximum) ^{1*}	720p (maximum) ^{1*}	1080i (maximum) ^{1*}
	1080i	480i	480p (maximum) ^{1*}	720p (maximum) ^{1*}	1080i (maximum) ^{1*}
COMPONENT OUTPUT jacks 	480i	480i	480p ^{2*}	720p ^{2*}	1080i ^{2*}
	480p	480i	480p ^{2*}	720p ^{2*}	1080i ^{2*}
	720p	480i	480p ^{2*}	720p ^{2*}	1080i ^{2*}
	1080i	480i	480p ^{2*}	720p ^{2*}	1080i ^{2*}
S-VIDEO jack / VIDEO jack 	480i	480i			
	480p				
	720p				
	1080i				

^{1*} Maximum of the player's actual resolution according to a connected HDMI TV. The order of precedence is 1080i>720p>480p>480i. For example, if “up to 1080i” is set and the connected TV cannot receive 1080i resolution, the player automatically lower its output resolution to 720p, if not still received, to 480p, then 480i.

^{2*} Fixed. However, when an HDMI TV is also connected to the player, the player will select resolution in the same manner as in HDMI connection, i.e., ^{1*}.

Important information about setting and output resolution for HD performance (HDMI OUTPUT and COMPONENT OUTPUT)

To achieve high definition output when playing high definition material, it is necessary to set the output resolution of the player to match the native resolution of the disc. For example, when playing a disc with a native resolution of 720p, set the player output to 720p. For a disc with native resolution of 1080i, set the player to 1080i. Make sure that your HDTV or HD monitor input resolution will match the resolution you select for the player. In some cases such as with Toshiba HDTVs and HD displays, your HDTV or HD monitor will automatically switch input resolutions to match the output you select for the player. In other cases, a change in setting of the HDTV or HD display will be necessary. Please see owner's manual of your HDTV or HD monitor for details. If the disc does not provide information concerning its native resolution, you may need to try all HD output modes to determine which provides high definition playback.

You can enjoy multichannel Dolby® Digital and DTS® sound.

Via digital audio output

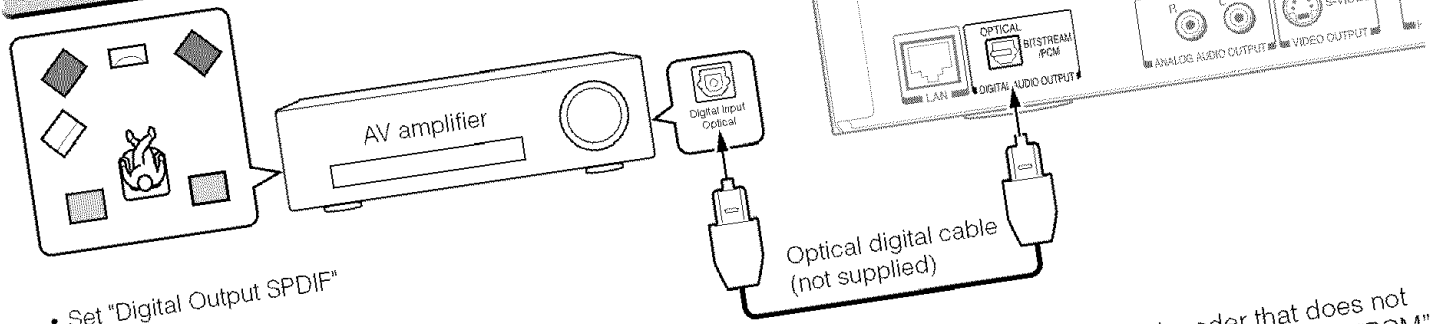

- Set "Digital Output SPDIF" (▶ page 53).

Caution

- When you are connecting (via the DIGITAL AUDIO OUTPUT BITSTREAM/PCM jack) an AV decoder that does not have Dolby Digital, DTS or MPEG decoding capability, be sure to set "Digital Output SPDIF" (▶ page 53) to "PCM". Otherwise, high volume sound may damage your hearing as well as the speakers.

Via HDMI output

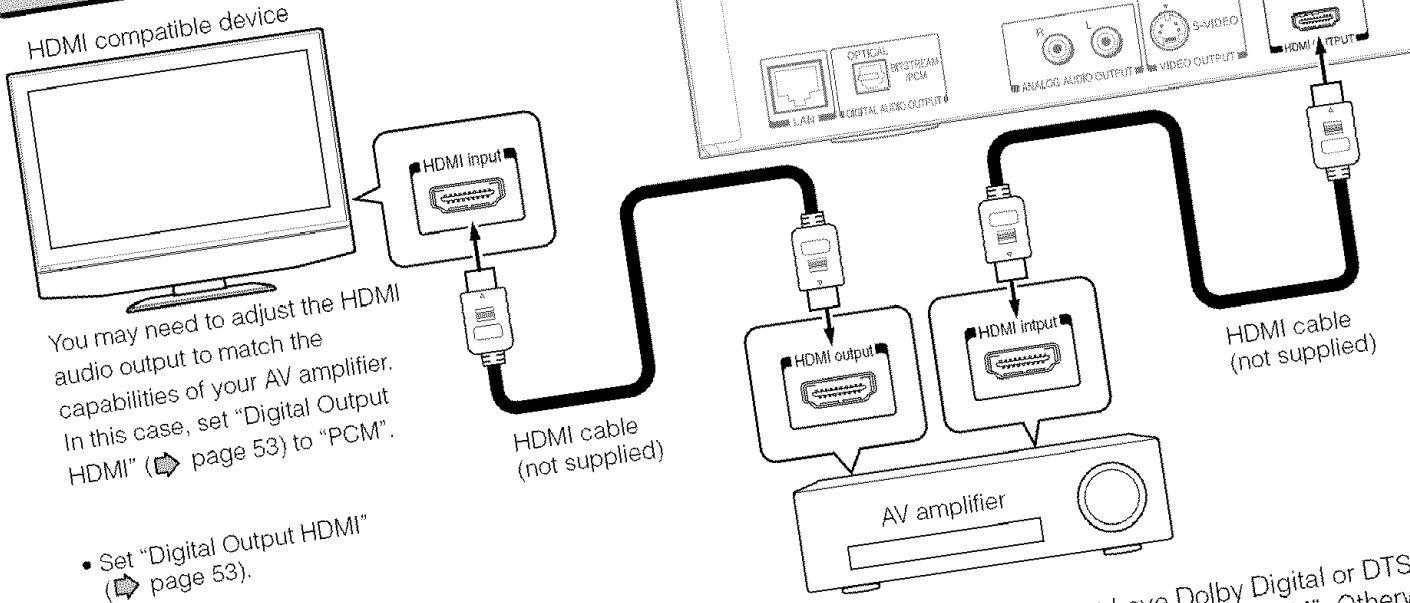

You may need to adjust the HDMI audio output to match the capabilities of your AV amplifier. In this case, set "Digital Output HDMI" (▶ page 53) to "PCM".

- Set "Digital Output HDMI" (▶ page 53).

Caution

- When you are connecting (via the HDMI OUTPUT jack) an AV decoder that does not have Dolby Digital or DTS decoding capability, be sure to set "Digital Output HDMI" (▶ page 53) to "PCM" or "Downmixed PCM". Otherwise, high volume sound may damage your hearing as well as the speakers.

Note about audio capabilities

- Dolby Digital Plus and DTS-HD (DTS core only) capability limited to 5.1 channels.
- DTS-HD processing of DTS core only. Full DTS-HD is not supported.

Playback (Basic)
 Playback (Advanced)
 Internet connectivity
 Other

Connecting to an audio system (Continued)

Manufactured under license from Dolby Laboratories. Dolby and the double-D symbol are trademarks of Dolby Laboratories.

Manufactured under license from Digital Theater Systems, Inc. U.S. Pat. No's. 5,451,942; 5,956,674; 5,974,380; 5,978,762; 6,226,616; 6,487,535 and other U.S. and world-wide patents issued and pending. "DTS" and "DTS Digital Surround" are registered trademarks of Digital Theater Systems, Inc. Copyright 1996, 2003 Digital Theater Systems, Inc. All Rights Reserved.

3 Playback (Basic)

Play your favorite disc.

Disc compatibility







Powering on/Loading a disc

Playing a disc



Playing at various speeds

Disc compatibility

Pre-recorded discs

Disc	Specification
HD DVD video disc 	<ul style="list-style-type: none"> • 12cm (4³/₄ in.)/ 8cm (3¹/₄ in.)
DVD video disc  	<ul style="list-style-type: none"> • 12cm (4³/₄ in.)/ 8cm (3¹/₄ in.) • Region number 1 or ALL <p>The region number of this HD DVD player is 1. If region numbers, corresponding to a specific playable area, are printed on your DVD video disc and you do not find  or , or the disc is encoded to permit playback only in regions other than Region 1, disc playback will not be allowed by the player.</p>
Audio CD 	<ul style="list-style-type: none"> • 12cm (4³/₄ in.)/ 8cm (3¹/₄ in.)

Recordable discs you can play on this player

Disc	Specification
HD DVD-R 	<ul style="list-style-type: none"> • HDVideo mode recording *Finalized discs only.
DVD-RW  Except Ver. 1.0	<ul style="list-style-type: none"> • DVD VR mode recording (CPRM compatible discs will be available in the future by software update.) • DVD Video mode recording *Finalized discs only.
DVD-R  DVD-R For DL	<ul style="list-style-type: none"> • DVD VR mode recording (CPRM compatible discs will be available in the future by software update.) • DVD Video mode recording • 4.7GB For General *Finalized discs only.

Disc	Specification
CD-RW	<ul style="list-style-type: none"> • CD-DA (audio CD) format *Finalized discs only.
CD-R	<ul style="list-style-type: none"> • CD-DA (audio CD) format *Finalized discs only.

Notes

- Because HD DVD is a new format, disc compatibility issues with new and existing format discs are possible. Not all discs are compatible. If you experience compatibility problems, please contact Toshiba Customer Service. See  page 8 for more information about disc compatibility.
- This player can play pictures of the NTSC color system only.
- You cannot play non-standardized discs even if they may be labeled as above.
- Discs other than the above cannot be played. Even some of the above discs may not be able to be played depending on their state.
- Blu-ray Discs cannot be played on this player.



is a trademark of DVD Format/Logo Licensing Corporation.

Compatibility notes

- Because HD DVD is a new format, certain disc, digital connection and other compatibility issues are possible. If you experience compatibility problems, please contact Toshiba Customer Service.
- Viewing high-definition content and up-converting standard DVD content may require an HDMI-capable input or HDCP-capable DVI input on your display device.
- Some HD DVD discs and DVD discs may restrict the use of some operation commands or features.
- Dolby Digital Plus and DTS-HD (DTS core only) capability limited to 5.1 channels.
- DTS-HD processing of DTS core only. Full DTS-HD is not supported.
- Dolby TrueHD processing of 48kHz in 5.1 channels, 96kHz/192kHz in 2 channels.
- Some DVD-R/DVD-RW and CD-R/CD-RW discs may be incompatible due to laser pick-up and disc design.
- CD-R/CD-RW discs must be recorded using CD-DA method for CD audio playback.
- The included remote control may not operate some or all features of your TV or monitor, so it may be necessary to use your original remote control.
- Certain features are subject to delayed availability.
- This product includes memory that is used to store some disc related information, including downloaded on-line content. The disc you are using will control how long this information is retained.

Note

- The firmware in this player can be updated.
See  page 58 for details.

On handling discs

- Do not touch the playback side of the disc.
- Do not stick paper or tape to discs.

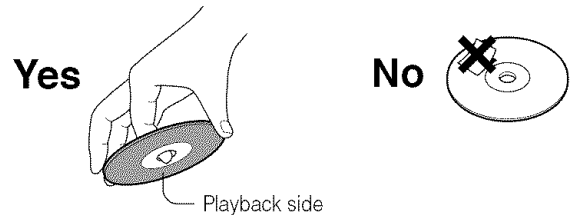

On cleaning discs

- Fingerprints and dust on the disc cause picture and sound deterioration. Wipe the disc from the center outwards with a soft cloth. Always keep the disc clean.





- Do not use any type of solvent such as thinner, benzene, commercially available cleaners or antistatic spray for vinyl LPs. It may damage the disc.
- Refer to the instructions of the disc as well.

On storing discs

- Do not store discs in a place subject to direct sunlight or near heat sources.
- Do not store discs in places subject to moisture and dust such as a bathroom or near a humidifier.
- Store discs vertically in a case. Stacking or placing objects on discs outside of their case may cause warping.
- Refer to the instructions of the disc as well.

Powering on/Loading a disc

Turning the power on

- 1** Press  (front panel) or  (remote control).

ON/STANDBY indicator ON/STANDBY button

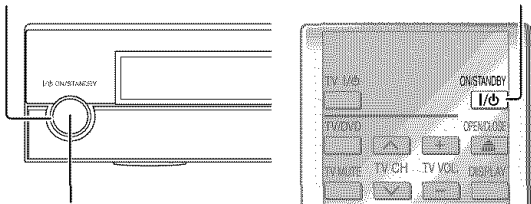

ON/STANDBY button

When the power turns on, ON/STANDBY indicator on the front panel changes color from red (standby mode) to green (operation).

Start up (and disc loading (see below)) may take time. Wait a while.

Turning the power off

- 1** Press **ON/STANDBY**.



The power turns off and ON/STANDBY indicator on the front panel turns red (standby mode).

When you power on this player for the first time, the setting screen will appear. Please refer to  page 50 and select "General" > "Clock Set". Check the date and time are set properly and correct them if necessary. When complete, press SETUP to exit. Your player is ready.

Note

- If the player freezes for about 15 minutes or more and will not respond to any buttons, holding down ON/STANDBY button on the front panel for about 10 seconds can force the player to turn off. However, this is an emergency measure, which may cause damage to the player. Avoid casual use of this measure.

Loading a disc

- 1** Press  (front panel) or  (remote control).

The player opens the disc tray.

- 2** Place a disc in the hollow of the disc tray with the playback side down.

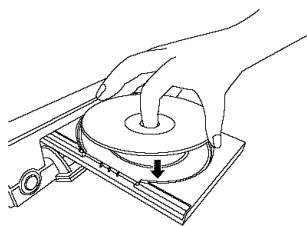

When using a double-sided disc, turn the label of the playing side up.

After placing a disc, press OPEN/CLOSE.

Notes

- Use the button on the front panel or the remote control to open and close the disc tray. Do not push or hold the disc tray while it is moving. Doing so may cause the player to malfunction.
- Do not load a disc which is unplayable, or any object other than a playable disc.
- Do not apply downforce to the disc tray. Doing so may cause the player to malfunction.
- If the disc tray stops while closing, the mechanical protection system of this player will open it. Do not force it to close. Doing so may damage the disc tray.
- If the disc tray will not open, turn the player off, and press OPEN/CLOSE on the front panel. This may turn the player on and open the disc tray. If it still won't open, contact your nearest TOSHIBA dealer.

Playing a disc

HD DVD	HD DVD-R	DVD-Video
DVD-RW	DVD-R	CD
CD-RW (CD-DA)	CD-R (CD-DA)	

Preparation

- 1 Turn on the TV or audio system and select the corresponding input source that the player is connected to.
- 2 Turn the power on. (▶ page 30)

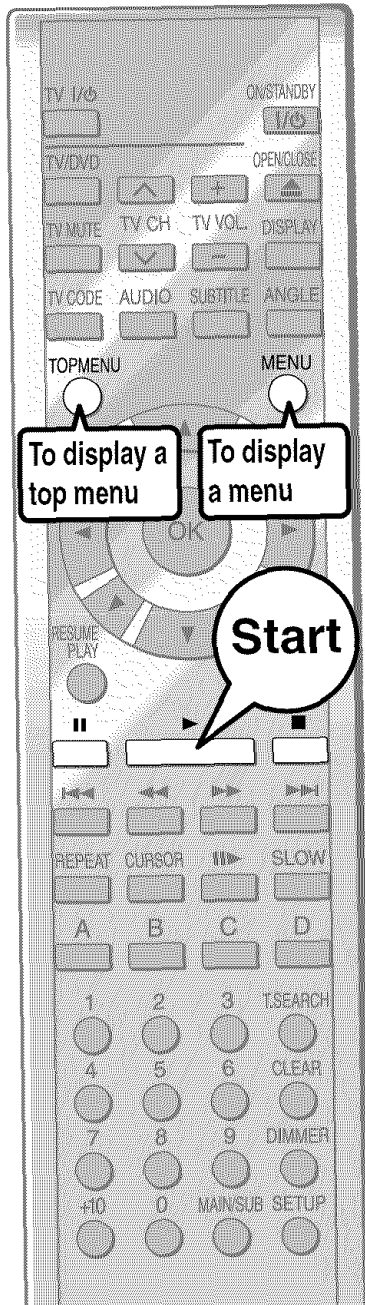

1

Load a disc and close the disc tray.

(▶ page 30)

Playback starts.

● If playback does not start

Press .

HD DVD DVD-Video

If a loaded disc contains a top menu, a top menu appears when you start playback.

Depending on the disc, you may need to press or to display a top menu.

("Playing from the top menu", ▶ page 32)

HD DVD-R DVD-RW DVD-R

If a loaded disc contains a title menu, you can display it to select a desired title.

("Playing from a recorded title menu", ▶ page 32)

CD CD-RW (CD-DA) CD-R (CD-DA)

Playback starts automatically.

Stopping playback / Pausing playback

Press .

Playback stops.

During playback, press .

Playback pauses.

To resume, press .

Note

- HD DVD discs or DVD video discs provide high resolution pictures and a lot of information. Because of this, you may notice some fine picture noise on the TV screen, which you have never seen with a regular broadcast TV program. While the amount of noise depends on the TV you use with the player, you should generally reduce the sharpness adjustment on your TV when viewing HD DVD or DVD video discs.

Playing a disc (Continued)

Playing from the top menu

HD DVD DVD-Video

Some discs may include a top menu, on which you can view the structure of contents or select a scene.

1 Press  .

A top menu appears.

2 Press  to select the title you want.

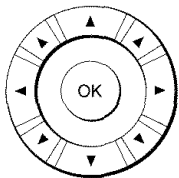

If the titles in the top menu are assigned a number, you can directly locate a specific title by pressing its designated number with the number buttons.

3 Press  .

Playback starts from chapter 1 of the selected title.

Notes

- The instructions above describe basic procedures which may vary depending on the contents of a disc. If different instructions appear on the TV screen, follow those instructions.
- If you display the top menu during playback and press TOP MENU button again without selecting any title, the player may resume playback from the point where you first pressed TOP MENU button (depending on the actual disc.)
- This method of locating a title is available only on a disc that contains a top menu.
- Instruction notes of discs may refer to the button that displays the top menu as TITLE button.
- Depending on a disc, MENU button may have to be pressed instead of TOP MENU button to display the top menu.

Using A/B/C/D buttons

HD DVD

Use these buttons as indicated by the video display during HD DVD disc playback. Depending on the disc contents, the functions of each button may differ.

Playing from a menu in a recorded disc

HD DVD-R DVD-RW DVD-R

Discs recorded on personal devices such as DVD recorders may contain menus, on which items can be easily selected.

1 Press  .

Recorded contents are displayed.

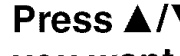
2 Press  to select the item you want.

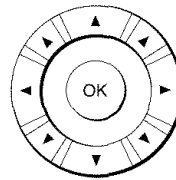

3 Press  .

Playback of the selected item starts.

Notes

- Disc menus vary depending on the disc or the recording device. Some discs may not contain a disc menu.
- Discs recorded in DVD VR mode display the recorded contents not in thumbnails but in a list. Select an item on the list and press OK button.

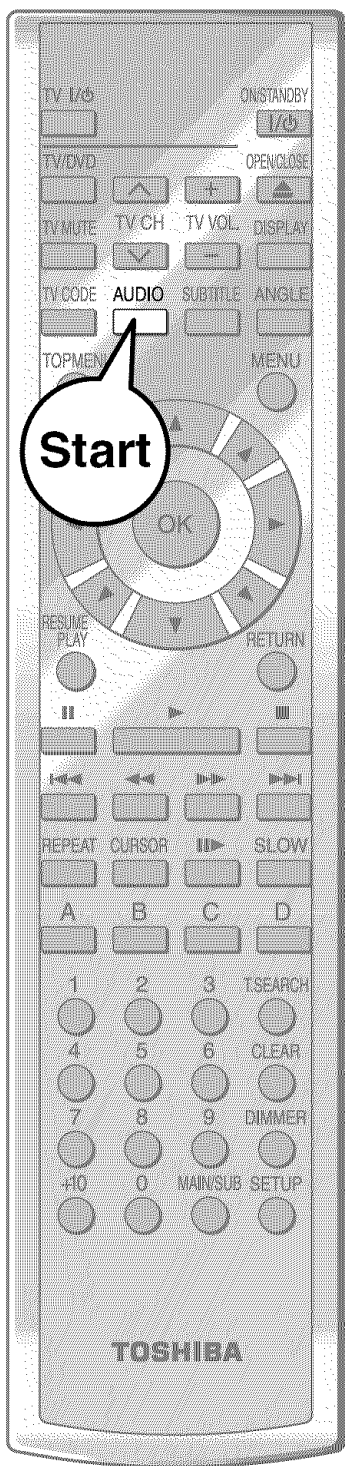

Selecting the sound

HD DVD **HD-DVD-R** **DVD-Video** **DVD-RW** **DVD-R**

If a disc contains several languages, you can select a preferred language from them to hear.

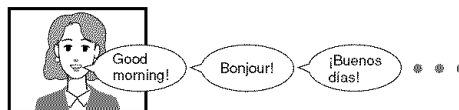

1

During playback, press **AUDIO**.

e.g.

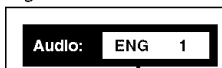

Language code (page 59)

Some HD DVD video discs may not display this window.

2

Press **AUDIO** while the audio setting is displayed on the TV screen.

Notes

- Some discs allow you to change audio selections only via the disc menu. If this is the case, press MENU button and choose the appropriate language from the selections on the disc menu.
- When you turn on the player or replace a disc, the player returns to the initial default setting (page 54). Depending on a disc, a specific type of audio the disc has is output.

Selecting the sound of a disc recorded in DVD VR mode

DVD-RW **DVD-R** (DVD VR mode)

When playing a disc recorded in DVD VR mode, select the sound as follows.

1

During playback, press **AUDIO**.

- The current audio setting appears.
- The language code appears instead of the language name. Refer to the list of languages and their abbreviations. (page 59)

2

Press **AUDIO** while the audio setting is displayed on the TV screen.

Depending on the disc or the type of broadcast, variation of sound differs.

● **DVD-RW** **DVD-R**

Stereo sound contents

"Stereo" or "LR" (Left main channel and right sub channel) → "L" (Left main channel) → "R" (Right sub channel) → Back to "Stereo" or "LR".

SAP sound contents

"Main" → "Sub" → "Main and Sub" → Back to "Main".

Playing a disc (Continued)

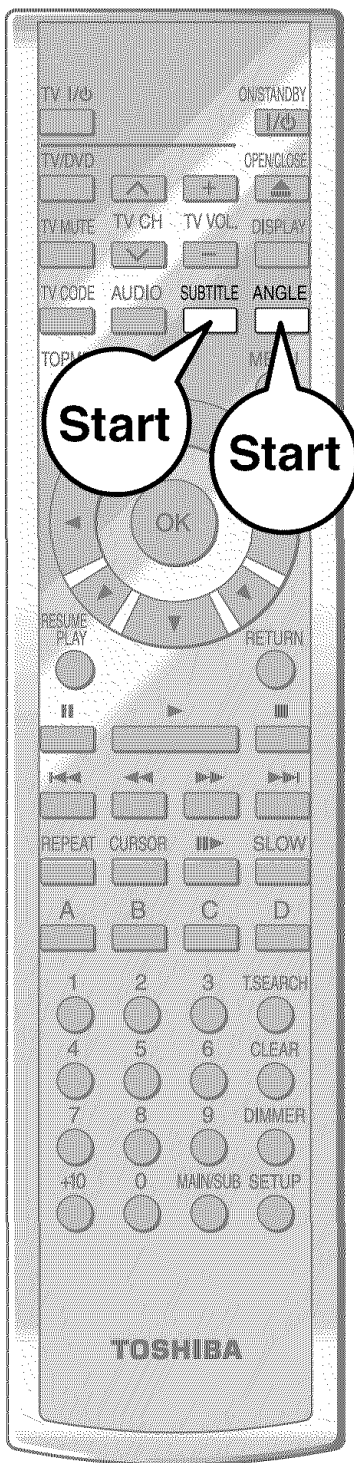

Selecting subtitles

HD DVD DVD-Video

You can display subtitles on the TV and select a subtitle language from those included on the disc.

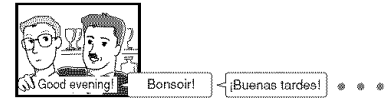

1 Press during playback.

The current subtitle setting appears.

e.g.

Subtitle: ENG 1

Language code (▶ page 59)

Some HD DVD video discs may not display this window.

Each time you press ◀▶, "On" and "Off" alternate. Select "On" to view subtitles.

2 Press while the subtitle setting is displayed on the TV screen.

Subtitle languages which do not appear in the setting are not included in the disc.

Notes

- Some discs are set to display subtitles automatically.
- Depending on the scene, subtitles may not appear immediately after you set the subtitle function to on.
- Some discs will allow you to change subtitle languages and turn subtitles on or off only via the disc menu.
- When you turn on the player or replace a disc, the player returns to the initial default setting (▶ page 54). Depending on a disc, a specific type of subtitles the disc has is output.
- Depending on the scene, the subtitle language may not change immediately after selected.

Selecting the camera angle

HD DVD DVD-Video

If the scene was recorded with multiple angles, you can easily change the camera angle of the scene you are watching.

1 Press while playing a scene recorded with multiple angles.

While playing a scene recorded with multiple angles, the angle icon appears on the TV screen and on the front panel. Press ANGLE button while the angle icon is displayed.

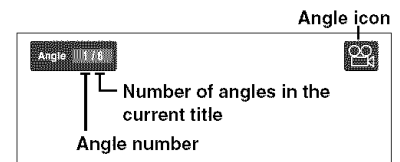

2 While the angle number is displayed, press repeatedly to select the angle number.

Notes

- You can also change the camera angle during still playback. The camera angle changes to the new setting when you resume normal playback.
- If you pause a picture immediately after changing a camera angle, the resumed playback picture may not display the new camera angle.

Playing at various speeds

HD DVD	HD DVD-R	DVD-Video
DVD-RW	DVD-R	CD
CD-RW (CD-DA)	CD-R (CD-DA)	

Skipping chapters or tracks

Playback starts from the beginning of the current chapter or track. When you press twice, playback starts from the beginning of the previous chapter or track.

➔ Page 36

Playing frame by frame



During playback, press .



Picture pauses.

If you press  while a picture is paused, you can play the picture frame by frame.

- To resume normal playback, press .
- Some discs may not permit this operation.

Playing in fast reverse or fast forward

During normal playback, press  / .

-  : Fast reverse playback
-  : Fast forward playback
- Each time you press the button, the playback speed changes.
- To resume normal playback, press .

Skipping chapters or tracks

Playback starts from the beginning of the next chapter or track.

Playing in slow-motion

Press  during playback.

- Picture is played forward in slow-motion.
- Each time you press the button, the slow-motion speed changes.
 - To resume normal playback, press .
 - Not available in CD playback.

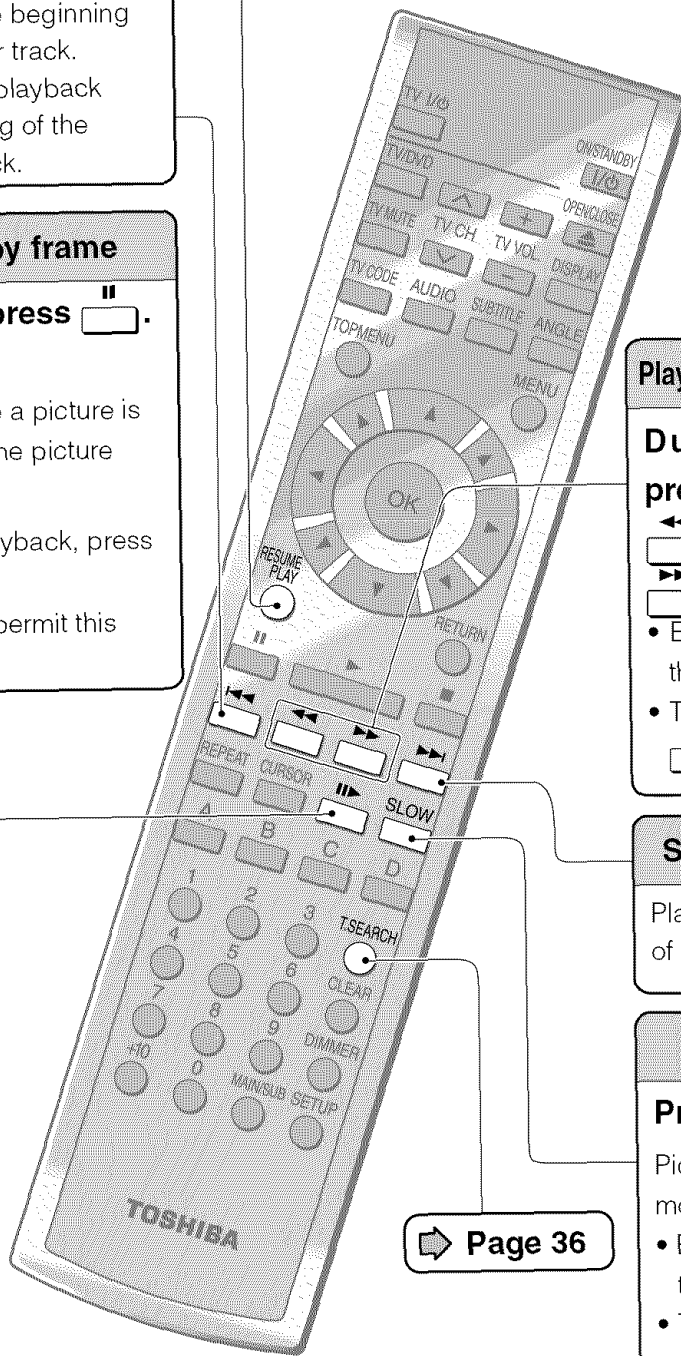

➔ Page 36

Production
Connections
Playback (Basic)
Playback (Advanced)
Internet connection
Others

Playing at various speeds (Continued)

Locating by entering a section number

HD DVD	HD DVD-R	DVD-Video	DVD-RW	DVD-R	CD
CD-RW (CD-DA)	CD-R (CD-DA)				

Normally titles, chapters, and tracks are numbered. By entering these numbers, you can access a desired section.

1 Press repeatedly to select the area you want to input.

e.g.

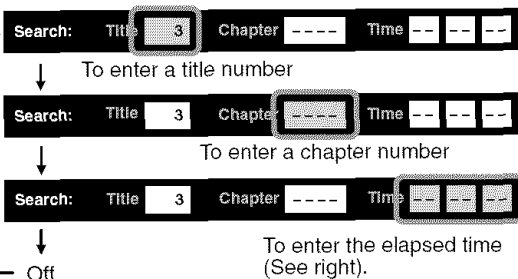

- The actual display may vary depending on the disc.

The cursor shifts also by ◀/▶.

2 Press the number buttons to enter a number of the section.

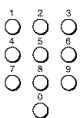

e.g. To enter chapter/track 25:

Press , then press .

- Pressing CLEAR resets the numbers. To turn off the display, press T.SEARCH several times (depending on the disc).

3 Press .

Playback starts from the selected section.

Note

- Some discs may not permit these operations.

Resuming playback from the location last stopped (Title resume)

HD DVD

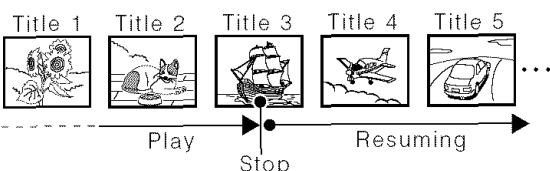

You can resume playback from the location last stopped.

If you press  after stopping playback, playback starts from the location last stopped.

If you press  after stopping playback, the resume feature is canceled.

Locating by entering elapsed time

HD DVD	HD DVD-R	DVD-Video	DVD-RW	DVD-R	CD
CD-RW (CD-DA)	CD-R (CD-DA)				

1 Press .

You may have to press repeatedly, depending on a disc. Press the button until the cursor moves to "-- -- --" area.

e.g.



2 Press the number buttons to enter the desired time location on the disc.

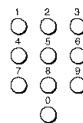

e.g. To enter 1 hour, 25 minutes, and 30 seconds

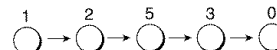

- Pressing CLEAR resets the numbers.

3 Press .

Playback starts from the specified location.

Notes

- Resume feature cannot function when:
 - you select a disc menu language (▶ page 54) or change the parental lock setting (▶ page 56).
 - you open the disc tray.
- There may be a difference in the location where playback resumes depending on the disc.
- It is possible to change the setting from the setup menu while the player retains a location in memory, however, the new setting can be valid only after the player clears the location memory, i.e., starts resume playback.
- Some discs or scenes may not permit this operation.

4 Playback (Advanced)

Playback variations and other functions.

Playing repeatedly (Repeat playback)

Using EXTENSION ports

Using the cursor function

Checking the current status and settings

Playing repeatedly (Repeat playback)

		DVD-Video
DVD-RW	DVD-R	CD
CD-RW (CD-DA)	CD-R (CD-DA)	

You can repeat a desired section.

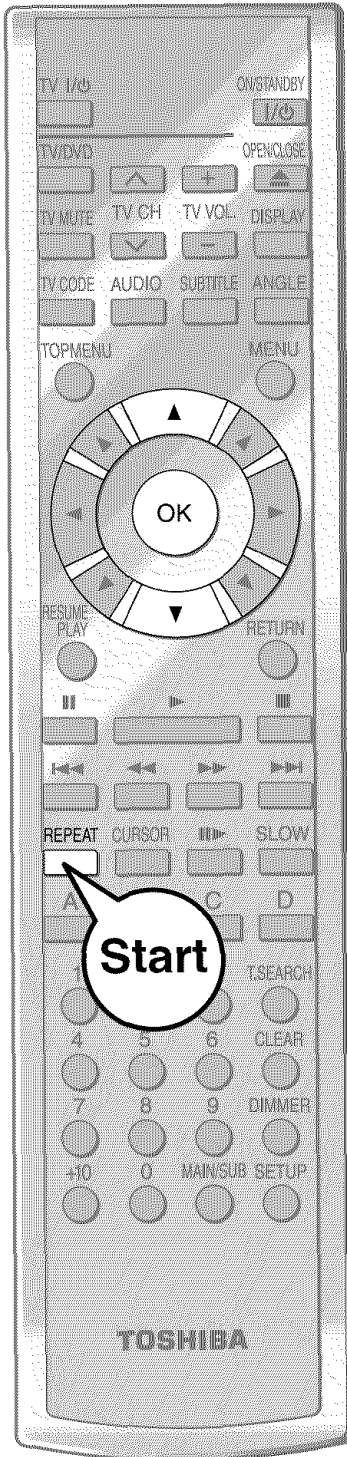
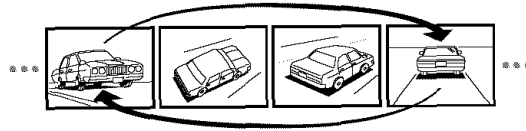

1

Press .

The repeat modes are listed.

2

Press / to select the repeat mode.

(The selections on the list vary depending on category or status of a disc.)

e.g.

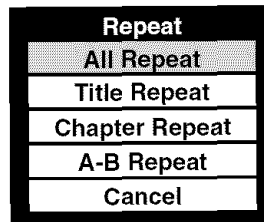

All Repeat:

Repeats the entire disc.

(Not available in playback of a disc recorded in DVD VR mode.)

Title Repeat:

Repeats the same title.

Chapter Repeat:

Repeats the same chapter.

Track Repeat:

Repeats the same track.

Disc Repeat:

Repeats the entire disc.

A-B Repeat:

Repeats the specified segment.

Select and press OK.

Perform step 1) and 2) below and skip step 3.



1) While the above display appears, press OK at a start point of a segment where you want to repeat.

The display changes to "B Point".



2) Press OK at an end point of a segment where you want to repeat.

Playback returns to the point A and repeats between A and B.

3

Press .

Repeat playback starts.

Notes

- Some discs may not permit repeat playback operation.
- You can cancel repeat playback also by pressing .

Using EXTENSION ports

HD DVD

Depending on the features of the disc you are using, you may be able to connect USB game controllers to the EXTENSION ports to use some interactive features. Additional features may be supported in the future.

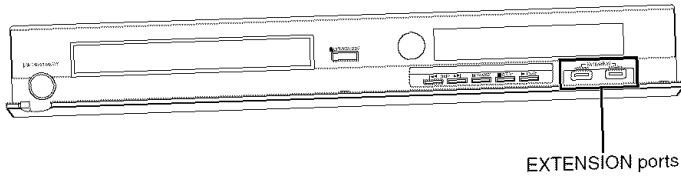

Using the cursor function

HD DVD

Available commercial HD DVD discs include game software and drawing software. You can use the cursor function for some software.

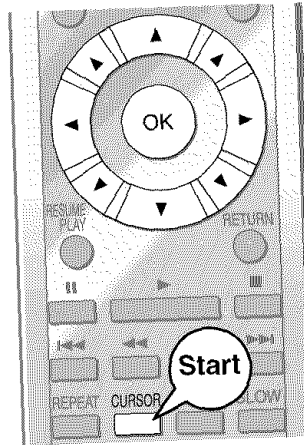

- 1 Press **CURSOR** while a disc with support for cursor use is playing.
- 2 Use the eight direction buttons to move the cursor.

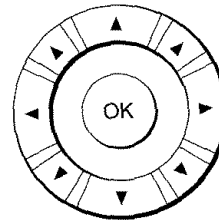

Example: Game/drawing software

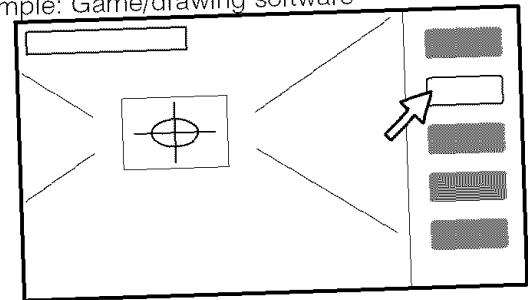

Move the cursor to select the game target or selection item. For details on actual operations, also refer to the operations guide for the disc.

Checking the current status and settings

You can confirm operational status and setting details.

HD DVD	HD DVD-R	DVD-Video
DVD-RW	DVD-R	CD
CD-RW (CD-DA)	CD-R (CD-DA)	

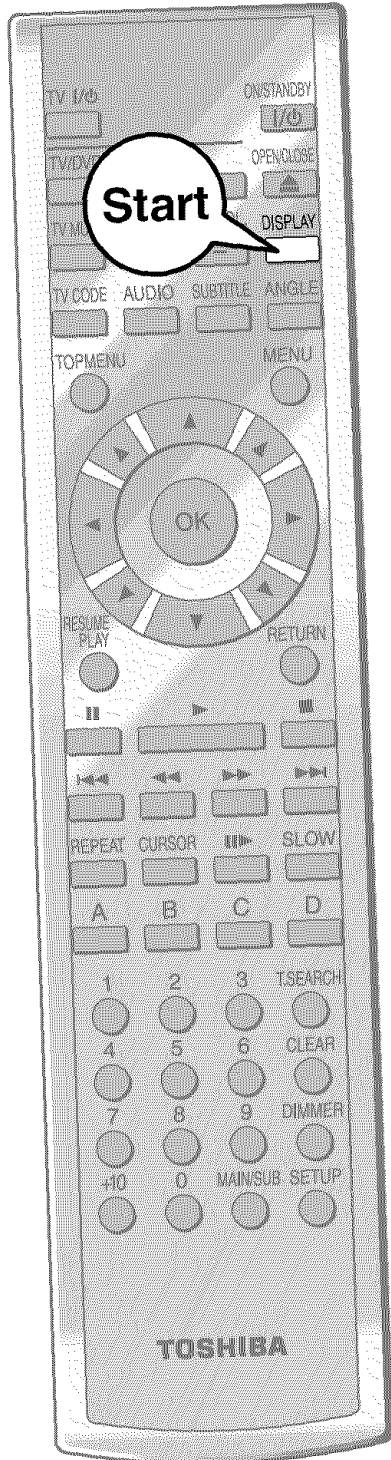

1

Press .

The following on-screen display appears.
(The actual display varies depending on the disc.)

HD DVD	HD DVD-R	DVD-Video	DVD-RW	DVD-R
--------	----------	-----------	--------	-------

e.g.

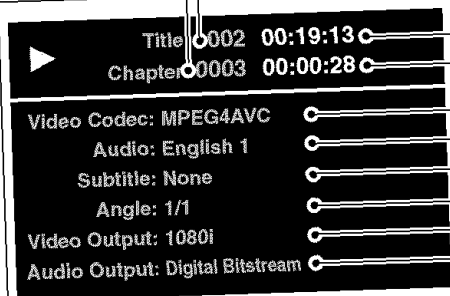

- Chapter number
- Title number
- Elapsed time of a title
- Elapsed time of a chapter
- Video codec
- Language setting
- Subtitle setting
- Angle number
- Definition
- Sound output setting

*The subtitle setting shows a language code (▶ page 59).

CD	CD-RW (CD-DA)	CD-R (CD-DA)
----	------------------	-----------------

e.g.

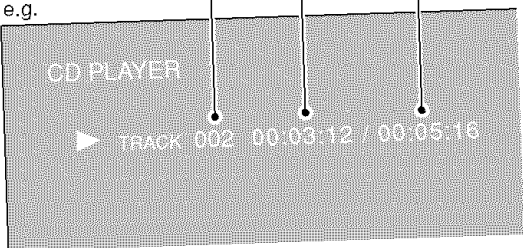

- Track number
- Elapsed time of a track
- Total time of a track

5 Internet connection

Connect to a network with an always-on broadband connection and use special content.

Internet connection feature (Outline)

Internet connection feature (Preparation)

Internet connection feature (Operation)

Introduction

Connections

Playback
(Basic)

Playback
(Advanced)

Internet
connection

Others

Internet connection feature (Outline)

If you connect the player to the Internet via an always-on broadband connection, some HD DVD discs enable you to access special HD DVD sites, etc. For example, if an HD DVD site includes content such as movie trailers, you can watch the content on the player via the Internet. On such sites, downloading service of the control program (firmware) updates of the player is also available.

You do not need to connect to a PC to use this function.

You may also use the internet connection feature to update the player's firmware. See  page 58.

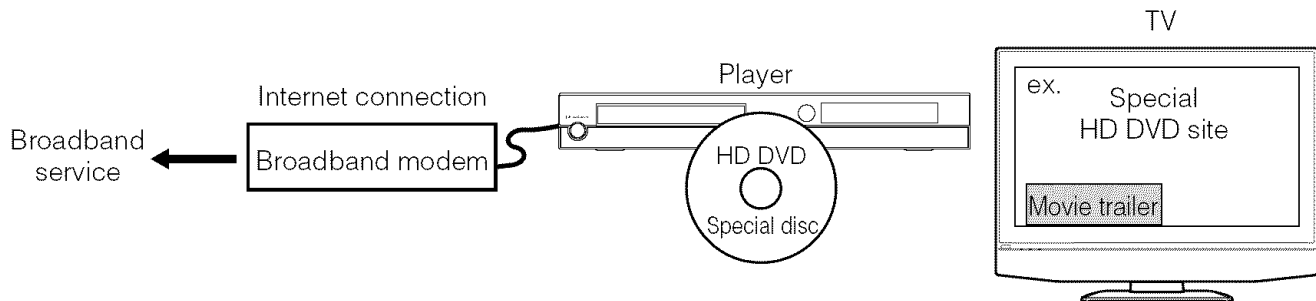

Before using

- Before using this feature, please read and understand the important information in "Notes".
- This feature requires always-on broadband internet connection.
- An HD DVD disc compatible with this feature (commercially available) is required. Not all HD DVD discs are compatible.

Connection requirement

Always-on internet broadband internet connection.

Note

- The above requirement may change without advance notice. In addition, all operations are not guaranteed.

Notes

- Toshiba is not responsible for any malfunction of the player and/or the internet connection feature due to communication errors/malfunctions associated with your broadband internet connection, or other connected equipment.
- Toshiba is not responsible for any trouble in your internet connection.
- If you use a wireless ethernet network, you will need to use a wireless LAN ethernet adapter to connect the player to the network.
- The features of HD DVD discs made available through the Internet Connection feature are not created or provided by Toshiba, and Toshiba is not responsible for their functionality or continued availability. Some disc related material available by the Internet Connection may not be compatible with this player. If you have questions about such content, please contact the producer of the disc.
- Some internet contents may require a higher bandwidth connection.

- Even if the player is properly connected and configured, some internet contents may not operate properly because of internet congestion, the quality or bandwidth of your internet service, problems at the provider of the content or compatibility issues.
- The communication features of this player comply with the Institute of Electrical and Electronic Engineers (IEEE) 802.3.
- Some internet connection operations may not be possible due to certain restrictions set by the Internet service provider (ISP) supplying your broadband Internet connection.
- Any fees charged by an ISP including, without limitation, connection charges are your responsibility.
- A 10 Base-T or 100 Base-TX LAN port is required for connection to this player. If your internet service does not allow for such a connection, you will not be able to connect the player.
- ADSL modem is required to use DSL service and a cable modem is required to use cable modem service. Depending on the access method of and subscriber agreement with your ISP, you may not be able to use the internet connection feature contained in this player or you may be limited to the number of devices you can connect at the same time. (If your ISP limits subscription to one device, this player may not be allowed to connect when a PC is already connected.)
- The use of a "Router" may not be allowed or its usage may be limited depending on the policies and restrictions of your ISP. For details, contact your ISP directly.

Internet connection feature (Preparation)

HD DVD

Connect the player to the Internet via an always-on broadband connection. In addition to accessing special HD DVD sites, this function is used when updates are available for the control program (firmware) of the player.

Connection

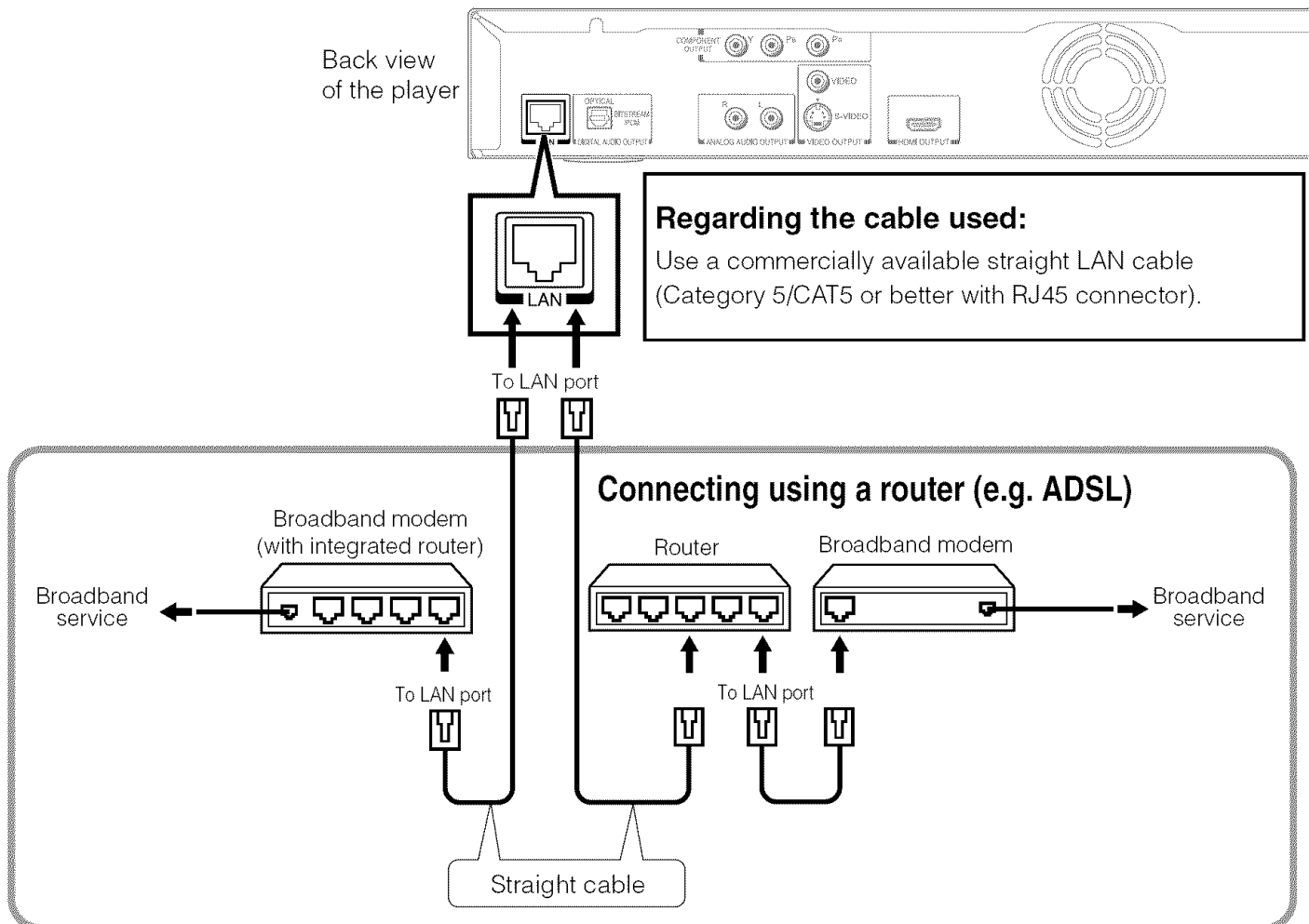

Caution

- When plugging or unplugging the LAN cable, hold the plug portion of the cable. When unplugging, do not pull on the LAN cable but unplug while pressing down on the lock.
- Do not connect the modular phone cable to the LAN port.
- Since there are various connection configurations, please follow the specifications of your telecommunication carrier or internet service provider.

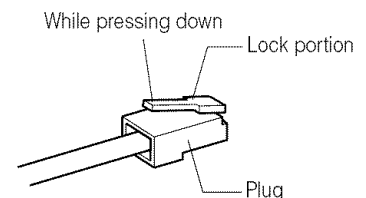

Note

- Depending on the internet service provider (ISP), the number of devices that can receive internet service may be limited by the applicable terms of service. For details, contact your ISP.

Internet connection setting procedure (Outline)

1st DHCP setting

- Set "DHCP" to "On".
The network information is automatically set.
- Set "DNS" to "On".
The DNS server is obtained automatically from the DHCP server.

If a connection cannot be established even if "DHCP" is set to "On".

- Set "DHCP" to "Off".
Set "IP Address", "Subnet Mask", and "Gateway" manually.
- Set "DNS" to "Off".
Set the DNS server address manually.

2nd Proxy setting

If the provider you are using requires a proxy setting to be configured, set the corresponding proxy server address.

3rd NTP Server setting

The player automatically accesses an internet server to adjust its clock via the network time protocol.

4th Network Speed setting

Select the speed according to the specification of your LAN.

5th Cookie setting

Select whether you accept cookies or not.

1st DHCP setting

- 1 Press SETUP button.
"SETUP MENU" appears.
- 2 Press ▲/▼ buttons to select "Ethernet", then press OK button.
- 3 On "Ethernet" menu, press ▲/▼ buttons to select "DHCP" then press OK button.
- 4 Set "DHCP" to "On", then press OK button.

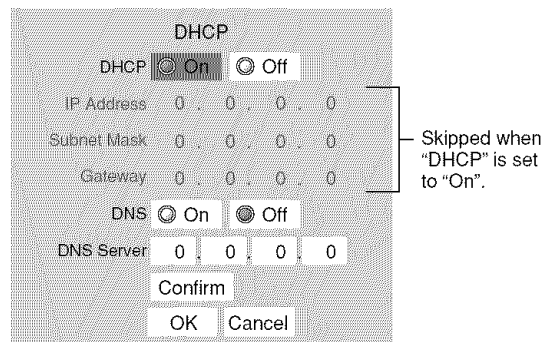

- 5 Set "DNS" to "On", then press OK button.

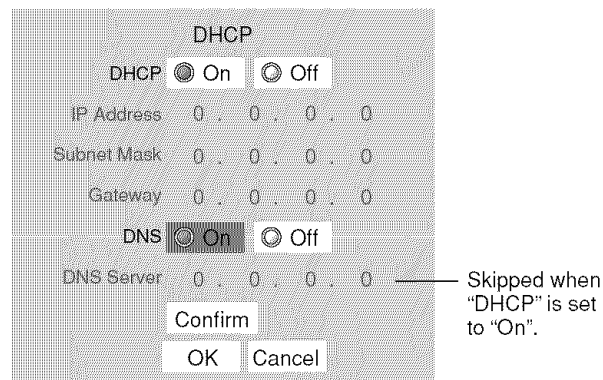

- 6 Select "Confirm", then press OK button.
Confirming starts.
If the setup is successful, an IP address appears.
Press OK button.

If the setup is not successful:

- a) Set "DHCP" to "Off" then press OK button.
- b) Input the addresses into "IP Address", "Subnet Mask" and "Gateway" using the number buttons.

IP Address	This sets a different address within the same subnet of the PC on your network. e.g.: If the IP address of the PC is 192.168.1.10, set 192.168.1.15 (or some other unused address).
Subnet Mask	This sets the subnet mask of the network environment that will be connected. e.g.: 255.255.255.0
Gateway	This sets the gateway used by the player (e.g.: 192.168.1.1).

- c) Set "DNS" to "Off" then press OK button.
- d) Input the address into "DNS Server".
This sets the DNS server to be used by the player.
e.g.: 192.168.1.1
- e) Press OK button.

Internet connection feature (Preparation) (Continued)

2nd Proxy Setting

Enter the proxy server address when your provider requires proxy setting.

- 1 On "Ethernet" menu, press ▲/▼ buttons to select "Proxy setting" then press OK button.
- 2 Set "Proxy" to "On" then press OK button.

- 3 Press ▲/▼/◀/▶ buttons to input.
 Server: Enter the specified data from the provider.
 Port: Enter the specified data from the provider.
 User: Enter the specified data from the provider.
 Password: Enter the specified data from the provider.
- 4 Select "OK" then press OK button.

3rd NTP Server setting (Clock adjustment setting)

- 1 On "Ethernet" menu, press ▲/▼ buttons to select "NTP Server" then press OK button.
- 2 Select "On" or "Off" by pressing ▲/▼ buttons.

On	The player automatically accesses an internet server to adjust time protocol.
Off	The player does not access an internet server to adjust its clock.

- 3 Select "OK" then press OK button.

4th Network Speed setting

Select your network speed.

- 1 On "Ethernet" menu, press ▲/▼ buttons to select "Network Speed" then press OK button.
- 2 Select the speed by pressing ▲/▼ buttons.
- 3 Select "OK" then press OK button.

5th Cookie Setting

Select whether you accept cookies or not.

- 1 On "Ethernet" menu, press ▲/▼ buttons to select "Cookie Setting" then press OK button.
- 2 Select "Accept" or "Not Accept" by pressing ▲/▼ buttons.

Accept	Cookies are accepted.
Not Accept	Cookies are rejected. This may disable some services on web pages.

- 3 Select "OK" then press OK button.

User information setting

Although not directly related to the Internet connection, some HD DVD discs may require the following settings to be configured.

- 1 On "Ethernet" menu, press ▲/▼ buttons to select "User Information" then press OK button.

- 2 Select "User" then press OK button.
 - 3 Input characters by pressing ▲/▼ buttons.
To shift the position, press ◀/▶ buttons.
Press OK button.
 - 4 Select "Password" then press OK button.
Input your password in the same manner as step 3.
Press OK button.
 - 5 Select "OK" then press OK button.
- Use a password that others cannot easily guess.

Mac Address

Displays the MAC address of the player.
It cannot be changed.

- 1 On "Ethernet" menu, press ▲/▼ buttons to select "Mac Address" then press OK button.
The MAC address appears.

Notes

- Please contact the router manufacturer when the router DHCP feature is not operating properly (in such a case, an error will occur since the default gateway and the DNS server IP address cannot be obtained).
- The firmware in this player is updateable. See page 58 for information.

Internet connection feature (Operation)

HD DVD

Some HD DVD discs enable you to access special HD DVD sites. If an HD DVD site includes content such as movie trailers, you can watch the content on the player via the Internet if your internet connection provides sufficient bandwidth.

Preparation

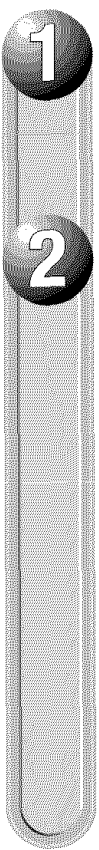
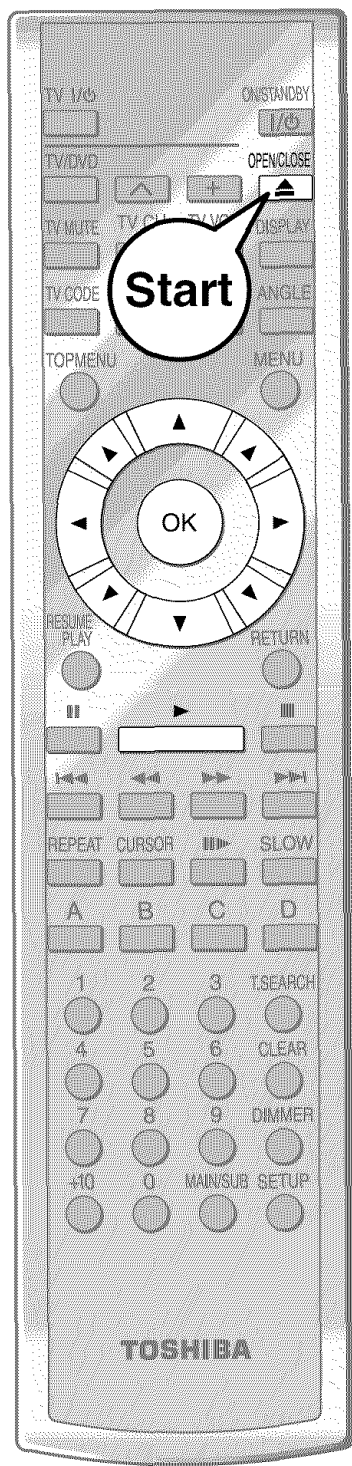

Connect and configure the player to access the Internet beforehand (➡ pages 44 to 46).



1 Insert the HD DVD disc and close the tray.

The disc begins to play.
If the disc does not begin to play, press .

2 Select an item from the menu.

- If the menu does not appear, press  or .
- To select an item, use the direction buttons to select the item and press .
- Use the cursor function for some discs (➡ page 39).

For example, you can watch the latest trailers on the player via the Internet.

For details on actual operations, also refer to the operations guide for the disc.

6 Others

This chapter includes details on setting items and information on troubleshooting problems.

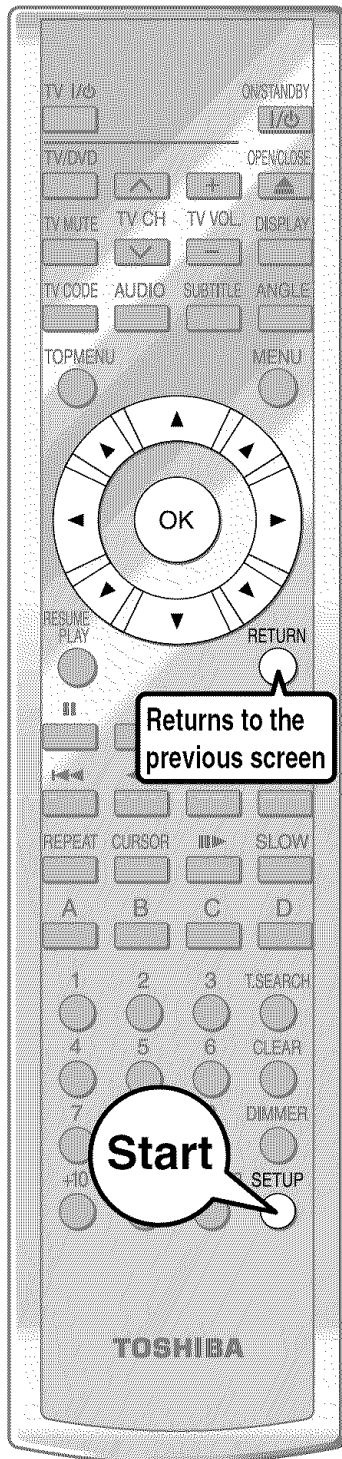

Customizing the function settings	10
Language code list	11
Output sound conversion table	12
License information on the software used in the TOSHIBA HD DVD player	13
Before calling service personnel	14
Specification	15
Limited United States Warranty	16
CANADIAN WARRANTY INFORMATION	17
INFORMATION ON CUSTOMER SUPPORT	18

Customizing the function settings





You can change the default settings to customize performance to your preference.

1 During stop, press .
"SETUP MENU" appears.

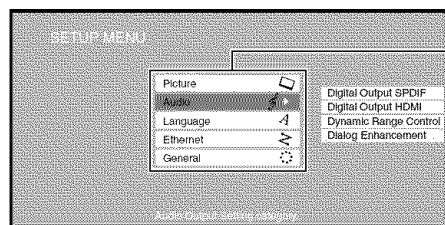
2 Press / to select the group that contains a desired item, then press .



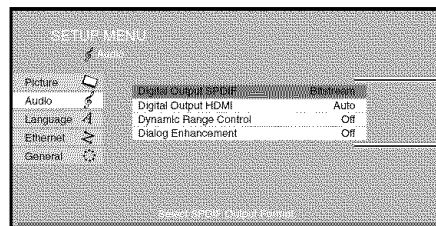

Group

3 Press / to select the setting item, then press .



Setting item

4 Refer to the explanations on pages beginning from 52, to change the selection by / or other buttons, then press .

5 Repeat step 3 and 4 to set other items if necessary.

6 Press .
"SETUP MENU" disappears and the setting is completed.

Group	Setting	Disc				Details	Page
Picture	TV Shape	HD DVD	HD DVD-R	DVD Video	DVD-RW	To select a picture size according to the aspect ratio of your TV.	52
		DVD-R	CD				
	Enhanced Black Level	HD DVD	HD DVD-R	DVD Video	DVD-RW	To select the black level of playback pictures.	52
		DVD-R					
Picture Mode	HD DVD	HD DVD-R	DVD Video	DVD-RW	To select the system of output signal corresponding to playback source. (Only when connected to a PROGRESSIVE TV.)	52	
	DVD-R						
	Resolution Setting	HD DVD	HD DVD-R	DVD Video	DVD-RW	To select the resolution of the player's output, according to the connected TV.	23
		DVD-R					
Audio	Digital Output SPDIF	HD DVD	HD DVD-R	DVD Video	DVD-RW	To select the output sound format when connecting the DIGITAL AUDIO OUTPUT jack.	53
		DVD-R	CD	CD-RW (CD-DA)	CD-R (CD-DA)		
	Digital Output HDMI	HD DVD	HD DVD-R	DVD Video	DVD-RW	To select the output sound format when connecting the HDMI OUTPUT jack.	53
		DVD-R	CD	CD-RW (CD-DA)	CD-R (CD-DA)		
Dynamic Range Control	HD DVD	HD DVD-R	DVD Video	DVD-RW	To turn on or off a function that makes faint sounds easier to hear even if you lower the volume during late-hour playback.	53	
	DVD-R						
	Dialog Enhancement	HD DVD	HD DVD-R	DVD Video	DVD-RW	To turn on or off a function that increases dialog volume of a DVD video disc playback.	53
		DVD-R	CD	CD-RW (CD-DA)	CD-R (CD-DA)		
Language	Disc Menu Language	HD DVD	HD DVD-R	DVD Video		To select a preferred language for disc menus.	54
	Subtitle Language	HD DVD	HD DVD-R	DVD Video		To select a preferred language for subtitles.	54
	Audio Language	HD DVD	HD DVD-R	DVD Video		To select a preferred language for the sound track.	54
	On Screen Language	HD DVD	HD DVD-R	DVD Video	DVD-RW	To select a preferred language for on-screen displays.	55
	DVD-R	CD	CD-RW (CD-DA)	CD-R (CD-DA)			
Ethernet		HD DVD				To set up the player for internet connection feature.	45
General	Parental Lock	HD DVD	HD DVD-R	DVD Video		To turn the parental lock function on or off.	56
	Clock Set	HD DVD	HD DVD-R	DVD Video	DVD-RW	To set the clock of the player.	57
		DVD-R	CD	CD-RW (CD-DA)	CD-R (CD-DA)		
	OSD On/Off	HD DVD	HD DVD-R	DVD Video	DVD-RW	To activate or deactivate the operational status display on the TV screen.	57
		DVD-R	CD	CD-RW (CD-DA)	CD-R (CD-DA)		
	Remote Controller Sound	HD DVD	HD DVD-R	DVD Video	DVD-RW	To turn on or off the confirmation beeper announcing when each remote command is received.	57
		DVD-R	CD	CD-RW (CD-DA)	CD-R (CD-DA)		
Screen Saver		HD DVD-R	DVD Video	DVD-RW	To turn on or off the screen saver (screen protection to prevent image burn).	57	
	DVD-R	CD	CD-RW (CD-DA)	CD-R (CD-DA)			
	Maintenance	HD DVD	HD DVD-R	DVD Video	DVD-RW	To select the player conditioning options, such as initializing of settings or firmware download.	58
		DVD-R	CD	CD-RW (CD-DA)	CD-R (CD-DA)		
	Twin Format Disc	HD DVD				To select the layer to play of an HD DVD Twin Format Disc.	58

Customizing the function settings (Continued)

Picture

TV Shape

16:9

Select when a 16:9 wide TV is connected.

4:3

Select when a standard 4:3 TV is connected.

Displays pictures cropped to fill your TV screen. Either or both of the picture's sides are cut off.

4:3Letter Box

Select when a standard 4:3 TV is connected.

Displays theatrical images with masking bars above and below the picture.

Notes

- When an HD DVD disc or a DVD video disc has a particular available picture shape, the contents may not be compatible with other picture shapes.
- DVD video discs containing 4:3 picture only always display 4:3 pictures regardless of this setting.
- If "16:9" is selected while connecting a 4:3 TV, playback pictures may be distorted horizontally or shrink vertically. Make this setting according to your TV shape.
- Actual picture shape may depend on signal types of broadcasts or input sources, or settings on the connected TV. Refer to the owner's manual of your TV.

Enhanced Black Level

You can adjust the black level of the output signal.

On

To display deeper, richer black than in "Off" setting. (0 IRE)

Off

Normal black level. (7.5 IRE)

Picture Mode

There are two types of source content in pictures recorded in DVD video discs: film content (pictures recorded from films at 24 frames per second) and video content (video signals recorded at 30 frames per second). Make this selection according to the type of content being viewed.

Film

The player converts film content pictures in the progressive output format appropriately. Suitable for playback of film content pictures.

Video

The player filters video signal, and converts it in the progressive output format appropriately. Suitable for playback of video content pictures.

Auto

Select this position normally. The player automatically detects source content, film or video, of playback source, and converts that signal in the progressive output format in an appropriate method.

Note

- Depending on a disc, "Auto" setting may not be able to detect source content. If pictures may be doubled, roughened, or may show other abnormality, "Film" or "Video" selection is recommended for possible improvement.

Resolution Setting

See ➡ page 23.

Audio

Digital Output SPDIF

Selects the output sound format when an audio device such as an amplifier to the DIGITAL AUDIO OUTPUT BITSTREAM/PCM jack on this player.

For details about output sound selection, see ➡ page 60.

Bitstream

Select this when an amplifier equipped with built-in Dolby Digital, DTS or MPEG decoder is connected to this player. When you play a disc recorded in Dolby Digital or DTS format, digital audio signal (bitstream audio) is output.

PCM

Select this when a 2 channel digital stereo amplifier is connected to this player.

When you play an HD DVD or DVD video disc recorded in Dolby Digital, Dolby Digital Plus, Dolby TrueHD, DTS or DTS-HD format, sound is converted into PCM (2 channel) format to output.

Digital Output HDMI

Select the output sound format when a device equipped with an HDMI terminal is connected to the HDMI OUTPUT jack on this player.

For details about output sound selection, see ➡ page 60.

Auto

Select this when an HDMI device equipped with built-in Dolby Digital, DTS, MPEG or linear PCM decoder is connected to this player.

When you play a disc recorded in Dolby Digital or DTS format, digital audio signal (bitstream audio) is output.

If a connected HDMI device does not support Dolby Digital, DTS or MPEG, sound is converted into linear PCM to output.

PCM

Select this when an HDMI device which has multi channel output is connected to this player.

When you play an HD DVD or DVD video disc recorded in multi channel in Dolby Digital, Dolby Digital Plus, Dolby TrueHD, DTS or DTS-HD format, the sound is decoded and output in multi channel in linear PCM format.

Downmixed PCM

Select this when a 2 channel digital stereo amplifier is connected to this player.

When you play a DVD video disc recorded in Dolby Digital, DTS, MPEG1 or MPEG2 format, sound is converted into PCM (2 channel) format to output.

Note

- Setting "Auto" or "PCM" will reduce output level of multi channel sound from the ANALOG AUDIO OUTPUT jacks and the DIGITAL AUDIO OUTPUT BITSTREAM/PCM jack if you:
 - view the playback picture on an HDMI TV connected to this player.
 - play an HD DVD video disc of a certain type, recorded in linear PCM format.

In this case, the output level will be restored by setting to "Downmixed PCM".

Dynamic Range Control

To turn on or off a function that makes faint sounds easier to hear even if you lower the volume during late-hour playback.

Auto

This function is activated.

While playing an HD DVD video disc recorded in Dolby TrueHD format, "On" or "Off" will be automatically selected.

On

This function is activated.

Off

This function is disabled.

Notes

- This function is effective only in playback of HD DVD or DVD video discs recorded in Dolby Digital, Dolby Digital Plus or Dolby TrueHD format.
- The effect level of this function vary depending on the disc.

Dialog Enhancement

To turn on or off a function that increases dialog volume of a DVD video disc playback.

On

This function is activated.

Off

This function is disabled.

Notes

- This function is effective only in playback of Dolby Digital recorded HD DVD or DVD video discs.
- The effect level of this function vary depending on the disc.

Customizing the function settings (Continued)

Language

Disc Menu Language

To select a preferred language for disc menus.

English

To display disc menus in English.

French

To display disc menus in French.

Japanese

To display disc menus in Japanese.

German

To display disc menus in German.

Others

To make a further language choice.

After pressing OK button, follow steps 1) – 4) below.

- 1) Obtain the language code of the preferred language from the Language code list (▶ page 59).
- 2) Select the first character by pressing ▲/▼ buttons.
- 3) Press ◀/▶ buttons to shift. Select the second character by pressing ▲/▼ buttons.
- 4) Select “OK” and press OK button.

Note

- Some discs may be played in a different language from that you selected. A prior language may be programmed by the disc.

Subtitle Language

To select a preferred language for subtitles.

None

To disable subtitles.

English

To display subtitles in English.

French

To display subtitles in French.

Japanese

To display subtitles in Japanese.

German

To display subtitles in German.

Others

To make a further language choice.

After pressing OK button, follow steps 1) – 4) below.

- 1) Obtain the language code of the preferred language from the Language code list (▶ page 59).
- 2) Select the first character by pressing ▲/▼ buttons.
- 3) Press ◀/▶ buttons to shift. Select the second character by pressing ▲/▼ buttons.
- 4) Select “OK” and press OK button.

Notes

- Some discs may be set to display subtitles in a different language from that you selected. A prior subtitle language may be programmed by the disc.
- Some discs allow you to change subtitle selections only via the disc menu. In this case, press MENU button and choose the appropriate subtitle language from the selection on the disc menu.

Audio Language

To select a preferred language for the sound track.

English

To display sound tracks recorded in English.

French

To display sound tracks recorded in French.

Japanese

To display sound tracks recorded in Japanese.

German

To display sound tracks recorded in German.

Others

To make a further language choice.

After pressing OK button, follow steps 1) – 4) below.

- 1) Obtain the language code of the preferred language from the Language code list (▶ page 59).
- 2) Select the first character by pressing ▲/▼ buttons.
- 3) Press ◀/▶ buttons to shift. Select the second character by pressing ▲/▼ buttons.
- 4) Select “OK” and press OK button.

Note

- Some discs may be played in a different language from that you selected. A prior language may be programmed by the disc.

Ethernet

See the "Internet connection" chapter (➡ page 42).

On Screen Language

To select a preferred language for on-screen displays.

English

To view on-screen display in English.

French

To view on-screen display in French.

Japanese

To view on-screen display in Japanese.

German

To view on-screen display in German.

Customizing the function settings (Continued)

General

Parental Lock

HD DVD and DVD video discs equipped with the Parental Lock function have a predetermined limitation level. The limitation level or limitation method may differ depending on the disc. For example the whole contents of a disc may not be played back, or an extreme violent scene may be cut or replaced automatically by another scene.

Important

Depending on discs, it may not be evident whether the disc is compatible with Parental Lock function. Make sure that Parental Lock function you set is activated correctly.

- 1 Enter a 4-digit password by using the number buttons, then press OK button.**

When you use the player for the first time, set a new password of 4-digit. If you make a mistake entering your password, press CLEAR button before pressing OK button, and re-enter the correct password.

- 2 Set the details.**

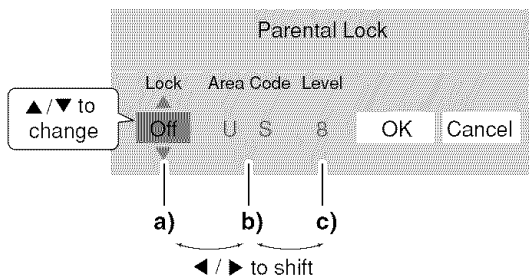

- a) Select "On" or "Off" by pressing ▲/▼ buttons.**

On

Select this to activate Parental Lock function or to change the setting.

Off

Deactivate the Parental Lock function.
Skip step 3.

- b) Press ▲/▼ buttons to enter the code of a country/area whose standards were used to rate a disc, referring to the list below.**

Country/Area	Code
AUSTRALIA	AU
BELGIUM	BE
CANADA	CA
CHINA	CN
CHINA HONG KONG	HK
DENMARK	DK
FINLAND	FI

FRANCE	FR
GERMANY	DE
INDONESIA	ID
ITALY	IT
JAPAN	JP
MALAYSIA	MY
NETHERLANDS	NL
NORWAY	NO
PHILIPPINES	PH
RUSSIAN FEDERATION	RU
SINGAPORE	SG
SPAIN	ES
SWEDEN	SE
SWITZERLAND	CH
TAIWAN	TW
THAILAND	TH
UNITED KINGDOM	GB
UNITED STATES	US

- c) Select the desired limitation level by pressing ◀/▶ buttons.**

Unless the Parental Lock function is set to "Off", a disc that has a higher limitation level than your selected limitation level cannot be played back. For example, if you select level 7, discs exceeding level 8 are locked and cannot be played back.

When "US" is selected, its limitation level corresponds to the following settings.

Level 7 : NC-17	Level 3 : PG
Level 6 : R	Level 1 : G
Level 4 : PG13	

- 4 Select "OK" then press OK button.**

■ To change the limitation level of Parental Lock function

Follow step 1 - 3 above.

■ To change the password

- 1 At step 1, press STOP button 4 times then press OK button.**

The password is cleared.

- 2 Enter a new 4-digit password by using the number buttons.**
- 3 Press OK button.**

Clock Set

To set the clock of the player.

- 1 Press ▲/▼ buttons to select the input area.

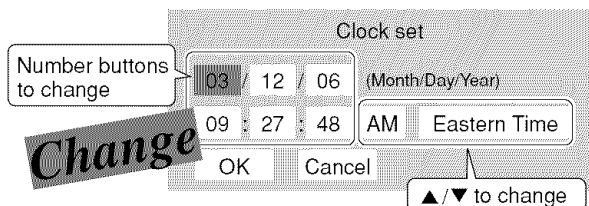

- 2 Press the number buttons to change the digit to set the date and time.
- 3 Press ▲/▼ buttons to select "AM" or "PM" and your time zone.
- 4 Select "OK" and press OK button.

The clock starts.

OSD On/Off

To activate or deactivate the operational status display on the TV screen.

On

Activates the operational status display (e.g., ►) on the TV screen.

Off

Deactivates the operational status display (e.g., ►) on the TV screen.

Remote Controller Sound

To turn on or off the confirmation beeper announcing when each remote command is received.

On

Turns on the beep sound.

Off

Turns off the beep sound.

Screen Saver

To turn on or off the screen protection function to prevent image burn caused by prolonged still picture.

Auto Power Off

Turns the player off if picture pausing continues for about 20 minutes.

On

Activates the screen saver if picture pausing continues for about 20 minutes.

Off

Deactivates the screen saver.

Notes

- Toshiba does not guarantee that this function protects the TV screen by all means.
- To close the screen saver, press any button on the player or the remote control.

Time zone map

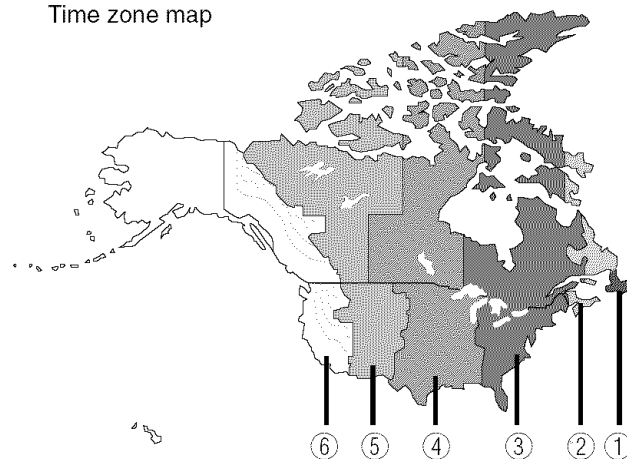

- ① Newfoundland Time
- ② Atlantic Time
- ③ Eastern Time
- ④ Central Time
- ⑤ Mountain Time
- ⑥ Pacific Time

Customizing the function settings (Continued)**General****Maintenance (including internet firmware update)****Initialize**

To reset all the settings listed on  page 53 to factory set default.

Press ◀/▶ buttons to select "Yes" then press OK button.

Update (Firmware update)

To determine the current firmware version.

Or

To download the latest firmware from the Toshiba server.

Before you can use this function, the player needs to be connected to the Internet via an always-on broadband connection. For details on connecting, refer to the "Internet connection" chapter. Also, the player needs to be loaded no disc. Eject a disc beforehand.

To update the firmware, press SETUP button. Operate following the instructions displayed on your screen. If there is no update available (in which case your player likely has the latest firmware), a message appears and the process is canceled. Please check the support section of the Toshiba website for information about firmware updates (including information on how to obtain updates on disc rather than using the Internet Connection feature of the player).

Persistent Storage

To open the menu to control player's memory allocated for content.

The menu selections will vary depending on the content.

Operate following the instructions displayed on your screen.

Caution

- Do not unplug, turn off or use any other feature of the player during the download. The writing of the software being downloaded will be halted and the player may no longer work properly. If the player stops working, contact Toshiba Customer Service.

Twin Format Disc

To select a layer to play, HD DVD or DVD of an HD DVD Twin Format Disc.

HD DVD

Only the HD DVD layer is played.

DVD

Only the DVD layer is played.

Language code list

Abbreviation	Language
---	No alternate language
CHI (ZH)	Chinese
DUT (NL)	Dutch
ENG (EN)	English
FRE (FR)	French
GER (DE)	German
ITA (IT)	Italian
JPN (JA)	Japanese
KOR (KO)	Korean
MAY (MS)	Malay
SPA (ES)	Spanish
AA	Afar
AB	Abkhazian
AF	Afrikaans
AM	Amharic
AR	Arabic
AS	Assamese
AY	Aymara
AZ	Azerbaijani
BA	Bashkir
BE	Belorussian
BG	Bulgarian
BH	Bihari
BI	Bislama
BN	Bengali, Bangla
BO	Tibetan
BR	Breton
CA	Catalan
CO	Corsican
CS	Czech
CY	Welsh
DA	Danish
DZ	Bhutani
EL	Greek
EO	Esperanto
ET	Estonian
EU	Basque
FA	Persian
FI	Finnish
FJ	Fiji
FO	Faroese
FY	Frisian
GA	Irish
GD	Scottish Gaelic
GL	Galician

Abbreviation	Language
GN	Guarani
GU	Gujarati
HA	Hausa
HI	Hindi
HR	Croatian
HU	Hungarian
HY	Armenian
IA	Interlingua
IE	Interlingue
IK	Inupiak
IN	Indonesian
IS	Icelandic
IW	Hebrew
JI	Yiddish
JW	Javanese
KA	Georgian
KK	Kazakh
KL	Greenlandic
KM	Cambodian
KN	Kannada
KS	Kashmiri
KU	Kurdish
KY	Kirghiz
LA	Latin
LN	Lingala
LO	Laotian
LT	Lithuanian
LV	Latvian, Lettish
MG	Malagasy
MI	Maori
MK	Macedonian
ML	Malayalam
MN	Mongolian
MO	Moldavian
MR	Marathi
MT	Maltese
MY	Burmese
NA	Nauru
NE	Nepali
NO	Norwegian
OC	Occitan
OM	(Afan) Oromo
OR	Oriya
PA	Panjabi
PL	Polish
PS	Pashto, Pushto

Abbreviation	Language
PT	Portuguese
QU	Quechua
RM	Rhaeto-Romance
RN	Kirundi
RO	Rumanian
RU	Russian
RW	Kinyarwanda
SA	Sanskrit
SD	Sindhi
SG	Sango
SH	Serbo-Croatian
SI	Singhalese
SK	Slovak
SL	Slovenian
SM	Samoan
SN	Shona
SO	Somali
SQ	Albanian
SR	Serbian
SS	Siswati
ST	Sesotho
SU	Sundanese
SV	Swedish
SW	Swahili
TA	Tamil
TE	Telugu
TG	Tajik
TH	Thai
TI	Tigrinya
TK	Turkmen
TL	Tagalog
TN	Setswana
TO	Tongan
TR	Turkish
TS	Tsonga
TT	Tatar
TW	Twi
UK	Ukrainian
UR	Urdu
UZ	Uzbek
VI	Vietnamese
VO	Volapük
WO	Wolof
XH	Xhosa
YO	Yoruba
ZU	Zulu

Output sound conversion table

Disc	Audio Format		Digital Output SPDIF	
			Bitstream	PCM
HD DVD Video Standard contents	DD plus		Bitstream	2ch PCM
	True HD	48kHz	2ch PCM	2ch PCM
		96kHz	2ch PCM*1	2ch PCM*1
		192kHz	2ch PCM*1	2ch PCM*1
	dts-HD		Bitstream	2ch PCM
	L-PCM	48k	2ch PCM	2ch PCM
		96k	2ch PCM*1	2ch PCM*1
192k		2ch PCM*1	2ch PCM*1	
Advanced con.			DTS Bitstream	2ch PCM
HD DVD-R	DD		Bitstream	2ch PCM
	L-PCM		2ch PCM	2ch PCM
	MPEG		Bitstream	2ch PCM
DVD-Video	DD		Bitstream	2ch PCM
	L-PCM	48k	2ch PCM	2ch PCM
		96k	2ch PCM*1	2ch PCM*1
	dts		Bitstream	2ch PCM
	MPEG		Bitstream	2ch PCM
CD	L-PCM	44.1kHz	2ch PCM	2ch PCM
	dts	44.1kHz	Bitstream	2ch PCM
DVD-VR	DD		Bitstream	2ch PCM
	L-PCM		2ch PCM	2ch PCM
	MPEG		Bitstream	2ch PCM

Disc	Audio Format		Digital Output HDMI		
			Auto	PCM	Downmixed PCM
HD DVD Video Standard contents	DD plus		Depend on HDMI receiver	upto 5.1ch PCM*3	2ch PCM
	True HD	48kHz	Depend on HDMI receiver	Multi PCM	2ch PCM
		96kHz	Depend on HDMI receiver	Multi PCM	2ch PCM*1
		192kHz	Depend on HDMI receiver	2ch PCM*1	2ch PCM*1
	dts-HD		Depend on HDMI receiver	upto 5.1ch PCM*3	2ch PCM
	L-PCM	48kHz	Depend on HDMI receiver	Multi PCM	2ch PCM
		96kHz	Depend on HDMI receiver	Multi PCM*4	2ch PCM*1
192kHz		Depend on HDMI receiver	2ch PCM*4	2ch PCM*1	
MPEG		Depend on HDMI receiver	2ch PCM	2ch PCM	
Advanced con.	Depends on contents.		Depend on HDMI receiver	Multi PCM*4	2ch PCM*1
HD DVD-R	DD		Depend on HDMI receiver	2ch PCM	2ch PCM
	L-PCM		2ch PCM	2ch PCM	2ch PCM
	MPEG		Depend on HDMI receiver	2ch PCM	2ch PCM
DVD-Video	DD		Depend on HDMI receiver	Multi PCM	2ch PCM
	L-PCM	48kHz	2ch PCM	2ch PCM	2ch PCM
		96kHz	2ch PCM	2ch PCM*4	2ch PCM*1
	dts		Depend on HDMI receiver	Multi PCM	2ch PCM
MPEG		Depend on HDMI receiver	2ch PCM	2ch PCM	
CD	L-PCM	44.1kHz	2ch PCM	2ch PCM	2ch PCM
	dts	44.1kHz	Depend on HDMI receiver	Multi PCM	2ch PCM
DVD-VR	DD		Depend on HDMI receiver	2ch PCM	2ch PCM
	L-PCM		2ch PCM	2ch PCM	2ch PCM
	MPEG		Depend on HDMI receiver	2ch PCM	2ch PCM

*1: Downsampling PCM.

*2: Bitstream audio output is possible only when the connected HDMI device has bitstream decoding function. If not, sound is output in PCM (48kHz) format.

*3: Multi channel PCM audio output is possible only when the connected HDMI device has multi channel decoding function.

*4: This output format is possible when the resolution setting is "720p" or "1080i". This will be 48kHz 2ch PCM output when the setting is "480i". When the resolution setting is set to "480p", this output format depends on HDMI receiver.

Notes

- Some discs allow you to change audio selections only via the disc menu. If this is the case, press MENU button and choose the appropriate language from the selections on the disc menu.
- When you turn on the player or replace a disc, the player returns to the initial default setting. (➡ page 54)
Depending on a disc, a specific type of audio the disc has is output.
- Immediately after you have switched sounds, there may be a temporary discrepancy between the display and actual sound.
- The BITSTREAM/PCM jack may not output SAP sound you select. In this instance, set "Digital Output SPDIF" to "PCM".
- The ANALOG AUDIO OUTPUT jacks always output 2ch sound only.

License information on the software used in the TOSHIBA HD DVD player

This document is statement purpose only. Not concerned with operation of this product.

The software pre-installed in the TOSHIBA HD DVD player consists of multiple, independent software components. Each software component is copyrighted by TOSHIBA or a third party.

The TOSHIBA HD DVD player uses software components that are distributed as freeware under a third-party end-user license agreement or copyright notice (hereinafter referred to as a "EULA").

Some EULAs require that the source code of the applicable component be disclosed as the condition for distributing the software component in executable format. You can check the software components subject to such EULA requirements on the following phone number:

Phone number: 1-800-631-3811

The software components of the TOSHIBA HD DVD player also include software developed or created independently by TOSHIBA. Such software and accompanying documents are owned by TOSHIBA and protected under copyright laws, international treaty provisions and other governing laws. See the attached "Software License Agreement" for the terms and conditions governing the use of software components owned by TOSHIBA. Source code is not disclosed for the software components developed or created independently by TOSHIBA that are not subject to any EULA.

TOSHIBA provides a warranty for the TOSHIBA HD DVD player you have purchased under conditions set forth by TOSHIBA.

However, some of the software components distributed under an EULA are made available for use by the user on the assumption that they are not copyrighted or warranted by TOSHIBA or any third party. These software components are licensed to the user free of charge and therefore not covered by any warranty within the scope of the applicable laws. These software components are not subject to any copyrights or other third-party rights and are provided in "as is" condition without any warranty, whether express or implied. "Warranty" here includes, but not limited to, an implied warranty for marketability or fitness for specific uses. All risks associated with the quality or performance of these software components are assumed by the user. TOSHIBA shall not be liable whatsoever for any cost of repair or correction or other incidental expense incurred in connection with a defect found in any of these software components. Unless specified under the applicable laws or in a written agreement, a party who changes or redistributes the software with consent from the copyright holders or based on the aforementioned licenses shall not be held liable whatsoever for any loss arising from the use of or inability to use such software components. The same applies even when the copyright holders or relevant third parties have been informed of the possibility of such loss. "Loss" here includes normal, special, incidental and indirect loss (including, but not limited to, the loss of data or its accuracy; loss incurred by the user or any third party; and interface incompatibility with other software). Please read each EULA for details on the use conditions and items that must be observed regarding these software components.

The table below lists the software components pre-installed in the TOSHIBA HD DVD player, which are subject to EULAs. The user should read the applicable EULAs carefully before using these software components. The EULAs are exhibited in their original text (English) as exactly written by the respective parties other than TOSHIBA

Pre-installed software	EULA	Pre-installed software	EULA
Linux Kernel	Exhibit A	OpenSSL	Exhibit C
Busybox		libpng	Exhibit D
glibc	Exhibit B	freetype	Exhibit E
gcc			
libcdaudio			
mpeg123			

Exhibit A

GNU GENERAL PUBLIC LICENSE Version 2, June 1991

Copyright © 1989, 1991 Free Software Foundation, Inc.
59 Temple Place, Suite 330, Boston, MA 02111-1307 USA

Everyone is permitted to copy and distribute verbatim copies of this license document, but changing it is not allowed.

Exhibit A

GNU GENERAL PUBLIC LICENSE Version 2, June 1991

Copyright © 1989, 1991 Free Software Foundation, Inc.
59 Temple Place, Suite 330, Boston, MA 02111-1307
USA

Everyone is permitted to copy and distribute verbatim copies of this license document, but changing it is not allowed.

Preamble

The licenses for most software are designed to take away your freedom to share and change it. By contrast, the GNU General Public License is intended to guarantee your freedom to share and change free software – to make sure the software is free for all its users. This General Public License applies to most of the Free Software

Foundation's software and to any other program whose authors commit to using it. (Some other Free Software Foundation software is covered by the GNU Library General Public License instead.) You can apply it to your programs, too.

When we speak of free software, we are referring to freedom, not price. Our General Public Licenses are designed to make sure that you have the freedom to distribute copies of free software (and charge for this service if you wish), that you receive source code or can get it if you want it, that you can change the software or use pieces of it in new free programs; and that you know you can do these things.

To protect your rights, we need to make restrictions that forbid anyone to deny you these rights or to ask you to surrender the rights. These restrictions translate to certain responsibilities for you if you distribute copies of the software, or if you modify it.

For example, if you distribute copies of such a program, whether gratis or for a fee, you must give the recipients all the rights that you have. You must make sure that they, too, receive or can get the source code. And you must show them these terms so they know their rights.

We protect your rights with two steps: (1) copyright the software, and (2) offer you this license which gives you legal permission to copy, distribute and/or modify the software.

Also, for each author's protection and ours, we want to make certain that everyone understands that there is no warranty for this free software. If the software is modified by someone else and passed on, we want its recipients to know that what they have is not the original, so that any problems introduced by others will not reflect on the original authors' reputations.

Finally, any free program is threatened constantly by software patents. We wish to avoid the danger that redistributors of a free program will individually obtain patent licenses, in effect making the program proprietary. To prevent this, we have made it clear that any patent must be licensed for everyone's free use or not licensed at all.

The precise terms and conditions for copying, distribution and modification follow.

GNU GENERAL PUBLIC LICENSE TERMS AND CONDITIONS FOR COPYING, DISTRIBUTION AND MODIFICATION

0. This License applies to any program or other work which contains a notice placed by the copyright holder saying it may be distributed under the terms of this General Public License. The "Program", below, refers to any such program or work, and a "work based on the Program" means either the Program or any derivative work under copyright law: that is to say, a work containing the Program or a portion of it, either verbatim or with modifications and/or translated into another language. (Hereinafter, translation is included without limitation in the term "modification".) Each licensee is addressed as "you".

Activities other than copying, distribution and modification are not covered by this License; they are outside its scope. The act of running the Program is not restricted, and the output from the Program is covered only if its contents constitute a work based on the Program (independent of having been made by running the Program). Whether that is true depends on what the Program does.

1. You may copy and distribute verbatim copies of the Program's source code as you receive it, in any medium, provided that you conspicuously and appropriately publish on each copy an appropriate copyright notice and disclaimer of warranty; keep intact all the notices that refer to this License and to the absence of any warranty; and give any other recipients of the Program a copy of this License along with the Program.

You may charge a fee for the physical act of transferring a copy, and you may at your option offer warranty protection in exchange for a fee.

2. You may modify your copy or copies of the Program or any portion of it, thus forming a work based on the Program, and copy and distribute such modifications or work under the terms of Section 1 above, provided that you also meet all of these conditions:

- a) You must cause the modified files to carry prominent notices stating that you changed the files and the date of any change.
- b) You must cause any work that you distribute or publish, that in whole or in part contains or is derived from the Program or any part thereof, to be licensed as a whole at no charge to all third parties under the terms of this License.
- c) If the modified program normally reads commands interactively when run, you must cause it, when started running for such interactive use in the most ordinary way, to print or display an announcement including an appropriate copyright notice and a notice that there is no warranty (or else, saying that you provide a warranty) and that users may redistribute the program under these conditions, and telling the user how to view a copy of this License.

(Exception: if the Program itself is interactive but does not normally print such an announcement, your work based on

the Program is not required to print an announcement.)

These requirements apply to the modified work as a whole. If identifiable sections of that work are not derived from the Program, and can be reasonably considered independent and separate works in themselves, then this License, and its terms, do not apply to those sections when you distribute them as separate works. But when you distribute the same sections as part of a whole which is a work based on the Program, the distribution of the whole must be on the terms of this License, whose permissions for other licensees extend to the entire whole, and thus to each and every part regardless of who wrote it.

Thus, it is not the intent of this section to claim rights or contest your rights to work written entirely by you; rather, the intent is to exercise the right to control the distribution of derivative or collective works based on the Program.

In addition, mere aggregation of another work not based on the Program with the Program (or with a work based on the Program) on a volume of a storage or distribution medium does not bring the other work under the scope of this License.

3. You may copy and distribute the Program (or a work based on it, under Section 2) in object code or executable form under the terms of Sections 1 and 2 above provided that you also do one of the following:

- a) Accompany it with the complete corresponding machine-readable source code, which must be distributed under the terms of Sections 1 and 2 above on a medium customarily used for software interchange; or,
- b) Accompany it with a written offer, valid for at least three years, to give any third party, for a charge no more than your cost of physically performing source distribution, a complete machine-readable copy of the corresponding source code, to be distributed under the terms of Sections 1 and 2 above on a medium customarily used for software interchange; or,
- c) Accompany it with the information you received as to the offer to distribute corresponding source code. (This alternative is allowed only for noncommercial distribution and only if you received the program in object code or executable form with such an offer, in accord with Subsection b above.)

The source code for a work means the preferred form of the work for making modifications to it. For an executable work, complete source code means all the source code for all modules it contains, plus any associated interface definition files, plus the scripts used to control compilation and installation of the executable. However, as a special exception, the source code distributed need not include anything that is normally distributed (in either source or binary form) with the major components (compiler, kernel, and so on) of the operating system on which the executable runs, unless that component itself accompanies the executable.

If distribution of executable or object code is made by offering access to copy from a designated place, then offering equivalent access to copy the source code from the same place counts as distribution of the source code, even though third parties are not compelled to copy the source along with the object code.

4. You may not copy, modify, sublicense, or distribute the Program except as expressly provided under this License. Any attempt otherwise to copy, modify, sublicense or distribute the Program is void, and will automatically terminate your rights under this License. However, parties who have received copies, or rights, from you under this License will not have their licenses terminated so long as such parties remain in full compliance.

5. You are not required to accept this License, since you have not signed it. However, nothing else grants you permission to modify or distribute the Program or its derivative works. These actions are prohibited by law if you do not accept this License. Therefore, by modifying or distributing the Program (or any work based on the Program), you indicate your acceptance of this License to do so, and all its terms and conditions for copying, distributing or modifying the Program or works based on it.

6. Each time you redistribute the Program (or any work based on the Program), the recipient automatically receives a license from the

Licence information on the software used in the TOSHIBA HD DVD player (Continued)

original licensor to copy, distribute or modify the Program subject to these terms and conditions. You may not impose any further restrictions on the recipients' exercise of the rights granted herein. You are not responsible for enforcing compliance by third parties to this License.

7.If as a consequence of a court judgment or allegation of patent infringement or for any other reason (not limited to patent issues), conditions are imposed on you (whether by court order, agreement or otherwise) that contradict the conditions of this License, they do not excuse you from the conditions of this License. If you cannot distribute so as to satisfy simultaneously your obligations under this License and any other pertinent obligations, then as a consequence you may not distribute the Program at all.

For example, if a patent license would not permit royalty-free redistribution of the Program by all those who receive copies directly or indirectly through you, then the only way you could satisfy both it and this License would be to refrain entirely from distribution of the Program. If any portion of this section is held invalid or unenforceable under any particular circumstance, the balance of the section is intended to apply and the section as a whole is intended to apply in other circumstances.

It is not the purpose of this section to induce you to infringe any patents or other property right claims or to contest validity of any such claims; this section has the sole purpose of protecting the integrity of the free software distribution system, which is implemented by public license practices. Many people have made generous contributions to the wide range of software distributed through that system in reliance on consistent application of that system; it is up to the author/donor to decide if he or she is willing to distribute software through any other system and a licensee cannot impose that choice.

This section is intended to make thoroughly clear what is believed to be a consequence of the rest of this License.

8.If the distribution and/or use of the Program is restricted in certain countries either by patents or by copyrighted interfaces, the original copyright holder who places the Program under this License may add an explicit geographical distribution limitation excluding those countries, so that distribution is permitted only in or among countries not thus excluded. In such case, this License incorporates the limitation as if written in the body of this License.

9.The Free Software Foundation may publish revised and/or new versions of the General Public License from time to time. Such new versions will be similar in spirit to the present version, but may differ in detail to address new problems or concerns.

Each version is given a distinguishing version number. If the Program specifies a version number of this License which applies to it and "any later version", you have the option of following the terms and conditions either of that version or of any later version published by the Free Software Foundation. If the Program does not specify a version number of this License, you may choose any version ever published by the Free Software Foundation.

10.If you wish to incorporate parts of the Program into other free programs whose distribution conditions are different, write to the author to ask for permission. For software which is copyrighted by the Free Software Foundation, write to the Free Software Foundation; we sometimes make exceptions for this. Our decision will be guided by the two goals of preserving the free status of all derivatives of our free software and of promoting the sharing and reuse of software generally.

NO WARRANTY

11.BECAUSE THE PROGRAM IS LICENSED FREE OF CHARGE, THERE IS NO WARRANTY FOR THE PROGRAM, TO THE EXTENT PERMITTED BY APPLICABLE LAW. EXCEPT WHEN OTHERWISE STATED IN WRITING THE COPYRIGHT HOLDERS AND/OR OTHER PARTIES PROVIDE THE PROGRAM "AS IS" WITHOUT WARRANTY OF ANY KIND, EITHER EXPRESSED OR IMPLIED, INCLUDING, BUT NOT LIMITED TO, THE IMPLIED WARRANTIES OF MERCHANTABILITY AND FITNESS FOR A PARTICULAR PURPOSE. THE ENTIRE RISK AS TO THE QUALITY AND PERFORMANCE OF

THE PROGRAM IS WITH YOU. SHOULD THE PROGRAM PROVE DEFECTIVE, YOU ASSUME THE COST OF ALL NECESSARY SERVICING, REPAIR OR CORRECTION.

12.IN NO EVENT UNLESS REQUIRED BY APPLICABLE LAW OR AGREED TO IN WRITING WILL ANY COPYRIGHT HOLDER, OR ANY OTHER PARTY WHO MAY MODIFY AND/OR REDISTRIBUTE THE PROGRAM AS PERMITTED ABOVE, BE LIABLE TO YOU FOR DAMAGES, INCLUDING ANY GENERAL, SPECIAL, INCIDENTAL OR CONSEQUENTIAL DAMAGES ARISING OUT OF THE USE OR INABILITY TO USE THE PROGRAM (INCLUDING BUT NOT LIMITED TO LOSS OF DATA OR DATA BEING RENDERED INACCURATE OR LOSSES SUSTAINED BY YOU OR THIRD PARTIES OR A FAILURE OF THE PROGRAM TO OPERATE WITH ANY OTHER PROGRAMS), EVEN IF SUCH HOLDER OR OTHER PARTY HAS BEEN ADVISED OF THE POSSIBILITY OF SUCH DAMAGES.

END OF TERMS AND CONDITIONS

How to Apply These Terms to Your New Programs

If you develop a new program, and you want it to be of the greatest possible use to the public, the best way to achieve this is to make it free software which everyone can redistribute and change under these terms.

To do so, attach the following notices to the program. It is safest to attach them to the start of each source file to most effectively convey the exclusion of warranty; and each file should have at least the "copyright" line and a pointer to where the full notice is found.

<One line to give the program's name and a brief idea of what it does.>

Copyright © 19yy <name of author>

This program is free software; you can redistribute it and/or modify it under the terms of the GNU General Public License as published by the Free Software Foundation; either version 2 of the License, or (at your option) any later version.

This program is distributed in the hope that it will be useful, but WITHOUT ANY WARRANTY; without even the implied warranty of MERCHANTABILITY or FITNESS FOR A PARTICULAR PURPOSE. See the GNU General Public License for more details.

You should have received a copy of the GNU General Public License along with this program; if not, write to the Free Software Foundation, Inc., 59 Temple Place, Suite 330, Boston, MA 02111-1307 USA

Also add information on how to contact you by electronic and paper mail.

If the program is interactive, make it output a short notice like this when it starts in an interactive mode:

```
Gnomovision version 69, Copyright © 19yy name of author
Gnomovision comes with ABSOLUTELY NO WARRANTY;
for details type `show w'. This is free software, and you are
welcome to redistribute it under certain conditions; type `show
c' for details.
```

The hypothetical commands `show w' and `show c' should show the appropriate parts of the General Public License. Of course, the commands you use may be called something other than `show w' and `show c'; they could even be mouse-clicks or menu items – whatever suits your program.

You should also get your employer (if you work as a programmer) or your school, if any, to sign a "copyright disclaimer" for the program; if necessary. Here is a sample; alter the names:

```
Yoyodyne, Inc., hereby disclaims all copyright interest in the
program `Gnomovision' (which makes passes at compilers)
written by James Hacker.

<signature of Ty Coon>, 1 April 1989 Ty Coon, President of
Vice
```

This General Public License does not permit incorporating your program into proprietary programs. If your program is a subroutine library, you may consider it more useful to permit linking proprietary applications with the library. If this is what you want to do, use the GNU Library General Public License instead of this License

Exhibit B

GNU LESSER GENERAL PUBLIC LICENSE Version 2.1, February 1999

Copyright © 1991, 1999 Free Software Foundation, Inc. 59 Temple Place, Suite 330, Boston, MA 02111-1307 USA Everyone is permitted to copy and distribute verbatim copies of this license document, but changing it is not allowed.

[This is the first released version of the Lesser GPL. It also counts as the successor of the GNU Library Public License, version 2, hence the version number 2.1.]

Preamble

The licenses for most software are designed to take away your freedom to share and change it. By contrast, the GNU General Public Licenses are intended to guarantee your freedom to share and change free software – to make sure the software is free for all its users.

This license, the Lesser General Public License, applies to some specially designated software packages – typically libraries – of the Free Software Foundation and other authors who decide to use it. You can use it too, but we suggest you first think carefully about whether this license or the ordinary General Public License is the better strategy to use in any particular case, based on the explanations below.

When we speak of free software, we are referring to freedom of use, not price. Our General Public Licenses are designed to make sure that you have the freedom to distribute copies of free software (and charge for this service if you wish); that you receive source code or can get it if you want it; that you can change the software and use pieces of it in new free programs; and that you are informed that you can do these things.

To protect your rights, we need to make restrictions that forbid distributors to deny you these rights or to ask you to surrender these rights. These restrictions translate to certain responsibilities for you if you distribute copies of the library or if you modify it.

For example, if you distribute copies of the library, whether gratis or for a fee, you must give the recipients all the rights that we gave you. You must make sure that they, too, receive or can get the source code. If you link other code with the library, you must provide complete object files to the recipients, so that they can relink them with the library after making changes to the library and recompiling it. And you must show them these terms so they know their rights.

We protect your rights with a two-step method: (1) we copyright the library, and (2) we offer you this license, which gives you legal permission to copy, distribute and/ or modify the library.

To protect each distributor, we want to make it very clear that there is no warranty for the free library. Also, if the library is modified by someone else and passed on, the recipients should know that what they have is not the original version, so that the original author's reputation will not be affected by problems that might be introduced by others.

Finally, software patents pose a constant threat to the existence of any free program. We wish to make sure that a company cannot effectively restrict the users of a free program by obtaining a restrictive license from a patent holder. Therefore, we insist that any patent license obtained for a version of the library must be consistent with the full freedom of use specified in this license.

Most GNU software, including some libraries, is covered by the ordinary GNU General Public License. This license, the GNU Lesser General Public License, applies to certain designated libraries, and is quite different from the ordinary General Public License. We use this license for certain libraries in order to permit linking those libraries into non-free programs.

When a program is linked with a library, whether statically or using a shared library, the combination of the two is legally speaking a combined work, a derivative of the original library. The ordinary General Public License therefore permits such linking only if the entire combination fits its criteria of freedom. The Lesser General Public License permits more lax criteria for linking other code with the library.

We call this license the "Lesser" General Public License because it does Less to protect the user's freedom than the ordinary General Public License. It also provides other free software developers Less of an advantage over competing non-free programs. These disadvantages are the reason we use the ordinary General Public License for many libraries. However, the Lesser license provides advantages in certain special circumstances.

For example, on rare occasions, there may be a special need to encourage the widest possible use of a certain library, so that it becomes a de-facto standard. To achieve this, non-free programs must be allowed to use the library. A more frequent case is that a free library does the same job as widely used non-free libraries. In this case, there is little to gain by limiting the free library to free software only, so we use the Lesser General Public License.

In other cases, permission to use a particular library in non-free programs enables a greater number of people to use a large body of free software. For example, permission to use the GNU C Library in non-free programs enables many more people to use the whole GNU operating system, as well as its variant, the GNU/Linux operating system.

Although the Lesser General Public License is Less protective of the users' freedom, it does ensure that the user of a program that is linked with the Library has the freedom and the wherewithal to run that program using a modified version of the Library.

The precise terms and conditions for copying, distribution and modification follow. Pay close attention to the difference between a "work based on the library" and a "work that uses the library". The former contains code derived from the library, whereas the latter must be combined with the library in order to run.

GNU LESSER GENERAL PUBLIC LICENSE TERMS AND CONDITIONS FOR COPYING, DISTRIBUTION AND MODIFICATION

0. This License Agreement applies to any software library or other program which contains a notice placed by the copyright holder or other authorized party saying it may be distributed under the terms of this Lesser General Public License (also called "this License"). Each licensee is addressed as "you".

A "library" means a collection of software functions and/ or data prepared so as to be conveniently linked with application programs (which use some of those functions and data) to form executables.

The "Library", below, refers to any such software library or work which has been distributed under these terms. A "work based on the Library" means either the Library or any derivative work under copyright law: that is to say, a work containing the Library or a portion of it, either verbatim or with modifications and/ or translated straightforwardly into another language. (Hereinafter, translation is included without limitation in the term "modification".)

"Source code" for a work means the preferred form of the work for making modifications to it. For a library, complete source code means all the source code for all modules it contains, plus any associated interface definition files, plus the scripts used to control compilation and installation of the library.

Activities other than copying, distribution and modification are not covered by this License; they are outside its scope. The act of running a program using the Library is not restricted, and output from such a program is covered only if its contents constitute a work based on the Library (independent of the use of the Library in a tool for writing it). Whether that is true depends on what the Library does and what the program that is true depends on what the Library does and what the program that uses the Library does.

1. You may copy and distribute verbatim copies of the Library's complete source code as you receive it, in any medium, provided that you conspicuously and appropriately publish on each copy an appropriate copyright notice and disclaimer of warranty; keep intact all the notices that refer to this License and to the absence of any warranty; and distribute a copy of this License along with the Library.

You may charge a fee for the physical act of transferring a copy, and you may at your option offer warranty protection in exchange for a fee.

2. You may modify your copy or copies of the Library or any portion of it, thus forming a work based on the Library, and copy and distribute

Licence information on the software used in the TOSHIBA HD DVD player (Continued)

such modifications or work under the terms of Section 1 above, provided that you also meet all of these conditions:

- a) The modified work must itself be a software library.
- b) You must cause the files modified to carry prominent notices stating that you changed the files and the date of any change.
- c) You must cause the whole of the work to be licensed at no charge to all third parties under the terms of this License.
- d) If a facility in the modified Library refers to a function or a table of data to be supplied by an application program that uses the facility, other than as an argument passed when the facility is invoked, then you must make a good faith effort to ensure that, in the event an application does not supply such function or table, the facility still operates, and performs whatever part of its purpose remains meaningful.
(For example, a function in a library to compute square roots has a purpose that is entirely well-defined independent of the application. Therefore, Subsection 2d requires that any applications-supplied function or table used by this function must be optional: if the application does not supply it, the square root function must still compute square roots.)

These requirements apply to the modified work as a whole. If identifiable sections of that work are not derived from the Library, and can be reasonably considered independent and separate works in themselves, then this License, and its terms, do not apply to those sections when you distribute them as separate works. But when you distribute the same sections as part of a whole which is a work based on the Library, the distribution of the whole must be on the terms of this License, whose permissions for other licensees extend to the entire whole, and thus to each and every part regardless of who wrote it.

Thus, it is not the intent of this section to claim rights or contest your rights to work written entirely by you; rather, the intent is to exercise the right to control the distribution of derivative or collective works based on the Library.

In addition, mere aggregation of another work not based on the Library with the Library (or with a work based on the Library) on a volume of a storage or distribution medium does not bring the other work under the scope of this License.

3. You may opt to apply the terms of the ordinary GNU General Public License instead of this License to a given copy of the Library. To do this, you must alter all the notices that refer to this License, so that they refer to the ordinary GNU General Public License, version 2, instead of to this License. (If a newer version than version 2 of the ordinary GNU General Public License has appeared, then you can specify that version instead if you wish.) Do not make any other change in these notices.

Once this change is made in a given copy, it is irreversible for that copy, so the ordinary GNU General Public License applies to all subsequent copies and derivative works made from that copy.

This option is useful when you wish to copy part of the code of the Library into a program that is not a library.

4. You may copy and distribute the Library (or a portion or derivative of it, under Section 2) in object code or executable form under the terms of Sections 1 and 2 above provided that you accompany it with the complete corresponding machine-readable source code, which must be distributed under the terms of Sections 1 and 2 above on a medium customarily used for software interchange.

If distribution of object code is made by offering access to copy from a designated place, then offering equivalent access to copy the source code from the same place satisfies the requirement to distribute the source code, even though third parties are not compelled to copy the source along with the object code.

5. A program that contains no derivative of any portion of the Library, but is designed to work with the Library by being compiled or linked with it, is called a "work that uses the Library". Such a work, in isolation, is not a derivative work of the Library, and therefore falls outside the scope of this License.

However, linking a "work that uses the Library" with the Library creates an executable that is a derivative of the Library (because it contains portions of the Library), rather than a "work that uses the library". The executable is therefore covered by this License. Section 6 states terms for distribution of such executables.

When a "work that uses the Library" uses material from a header file that is part of the Library, the object code for the work may be a derivative work of the Library even though the source code is not. Whether this is true is especially significant if the work can be linked without the Library, or if the work is itself a library. The threshold for this to be true is not precisely defined by law.

If such an object file uses only numerical parameters, data structure layouts and accessors, and small macros and small inline functions (ten lines or less in length), then the use of the object file is unrestricted, regardless of whether it is legally a derivative work. (Executables containing this object code plus portions of the Library will still fall under Section 6.)

Otherwise, if the work is a derivative of the Library, you may distribute the object code for the work under the terms of Section 6. Any executables containing that work also fall under Section 6, whether or not they are linked directly with the Library itself.

6. As an exception to the Sections above, you may also combine or link a "work that uses the Library" with the Library to produce a work containing portions of the Library, and distribute that work under terms of your choice, provided that the terms permit modification of the work for the customer's own use and reverse engineering for debugging such modifications.

You must give prominent notice with each copy of the work that the Library is used in it and that the Library and its use are covered by this License. You must supply a copy of this License. If the work during execution displays copyright notices, you must include the copyright notice for the Library among them, as well as a reference directing the user to the copy of this License. Also, you must do one of these things:

- a) Accompany the work with the complete corresponding machine-readable source code for the Library including whatever changes were used in the work (which must be distributed under Sections 1 and 2 above); and, if the work is an executable linked with the Library, with the complete machine-readable "work that uses the Library", as object code and/or source code, so that the user can modify the Library and then relink to produce a modified executable containing the modified Library. (It is understood that the user who changes the contents of definitions files in the Library will not necessarily be able to recompile the application to use the modified definitions.)
- b) Use a suitable shared library mechanism for linking with the Library. A suitable mechanism is one that (1) uses at run time a copy of the library already present on the user's computer system, rather than copying library functions into the executable, and (2) will operate properly with a modified version of the library, if the user installs one, as long as the modified version is interface-compatible with the version that the work was made with.
- c) Accompany the work with a written offer, valid for at least three years, to give the same user the materials specified in Subsection 6a, above, for a charge no more than the cost of performing this distribution.
- d) If distribution of the work is made by offering access to copy from a designated place, offer equivalent access to copy the above specified materials from the same place.
- e) Verify that the user has already received a copy of these materials or that you have already sent this user a copy.

For an executable, the required form of the "work that uses the Library" must include any data and utility programs needed for reproducing the executable from it. However, as a special exception, the materials to be distributed need not include anything that is normally distributed (in either source or binary form) with the major components (compiler, kernel, and so on) of the operating system on which the executable runs, unless that component itself accompanies the executable.

It may happen that this requirement contradicts the license restrictions of other proprietary libraries that do not normally accompany the operating system. Such a contradiction means you cannot use both them and the Library together in an executable that you distribute.

7. You may place library facilities that are a work based on the Library side-by-side in a single library together with other library facilities not covered by this License, and distribute such a combined library, provided that the separate distribution of the work based on the Library

and of the other library facilities is otherwise permitted, and provided that you do these two things:

- a) Accompany the combined library with a copy of the same work based on the Library, uncombined with any other library facilities. This must be distributed under the terms of the Sections above.
- b) Give prominent notice with the combined library of the fact that part of it is a work based on the Library, and explaining where to find the accompanying uncombined form of the same work.

8.You may not copy, modify, sublicense, link with, or distribute the Library except as expressly provided under this License. Any attempt otherwise to copy, modify, sublicense, link with, or distribute the Library is void, and will automatically terminate your rights under this License. However, parties who have received copies, or rights, from you under this License will not have their licenses terminated so long as such parties remain in full compliance.

9.You are not required to accept this License, since you have not signed it. However, nothing else grants you permission to modify or distribute the Library or its derivative works. These actions are prohibited by law if you do not accept this License. Therefore, by modifying or distributing the Library (or any work based on the Library), you indicate your acceptance of this License to do so, and all its terms and conditions for copying, distributing or modifying the Library or works based on it.

10.Each time you redistribute the Library (or any work based on the Library", the recipient automatically receives a license from the original licensor to copy, distribute, link with or modify the Library subject to these terms and conditions. You may not impose any further restrictions on the recipients' exercise of the rights granted herein. You are not responsible for enforcing compliance by third parties with this License.

11.If, as a consequence of a court judgment or allegation of patent infringement or for any other reason (not limited to patent issues), conditions are imposed on you (whether by court order, agreement or otherwise) that contradict the conditions of this License, they do not excuse you from the conditions of this License. If you cannot distribute so as to satisfy simultaneously your obligations under this License and any other pertinent obligations, then as a consequence you may not distribute the Library at all. For example, if a patent license would not permit royalty-free redistribution of the Library by all those who receive copies directly or indirectly through you, then the only way you could satisfy both it and this License would be to refrain entirely from distribution of the Library.

If any portion of this section is held invalid or unenforceable under any particular circumstance, the balance of the section is intended to apply, and the section as a whole is intended to apply in other circumstances.

It is not the purpose of this section to induce you to infringe any patents or other property right claims or to contest validity of any such claims; this section has the sole purpose of protecting the integrity of the free software distribution system which is implemented by public license practices. Many people have made generous contributions to the wide range of software distributed through that system in reliance on consistent application of that system; it is up to the author/donor to decide if he or she is willing to distribute software through any other system and a licensee cannot impose that choice.

This section is intended to make thoroughly clear what is believed to be a consequence of the rest of this License.

12.If the distribution and/or use of the Library is restricted in certain countries either by patents or by copyrighted interfaces, the original copyright holder who places the Library under this License may add an explicit geographical distribution limitation excluding those countries, so that distribution is permitted only in or among countries not thus excluded. In such case, this License incorporates the limitation as if written in the body of this License.

13.The Free Software Foundation may publish revised and/or new versions of the Lesser General Public License from time to time. Such new versions will be similar in spirit to the present version, but may differ in detail to address new problems or concerns. Each version is given a distinguishing version number. If the Library specifies a version number of this License which applies to it and "any later version", you have the option of following the terms and conditions either of that version or of any later version published by the Free Software Foundation. If the Library does not specify a license version number, you may choose any

version ever published by the Free Software Foundation.

14.If you wish to incorporate parts of the Library into other free programs whose distribution conditions are incompatible with these, write to the author to ask for permission. For software which is copyrighted by the Free Software Foundation, write to the Free Software Foundation; we sometimes make exceptions for this. Our decision will be guided by the two goals of preserving the free status of all derivatives of our free software and of promoting the sharing and reuse of software generally.

NO WARRANTY

15.BECAUSE THE LIBRARY IS LICENSED FREE OF CHARGE, THERE IS NO WARRANTY FOR THE LIBRARY, TO THE EXTENT PERMITTED BY APPLICABLE LAW. EXCEPT WHEN OTHERWISE STATED IN WRITING THE COPYRIGHT HOLDERS AND/OR OTHER PARTIES PROVIDE THE LIBRARY "AS IS" WITHOUT WARRANTY OF ANY KIND, EITHER EXPRESSED OR IMPLIED, INCLUDING, BUT NOT LIMITED TO, THE IMPLIED WARRANTIES OF MERCHANTABILITY AND FITNESS FOR A PARTICULAR PURPOSE. THE ENTIRE RISK AS TO THE QUALITY AND PERFORMANCE OF THE LIBRARY IS WITH YOU. SHOULD THE LIBRARY PROVE DEFECTIVE, YOU ASSUME THE COST OF ALL NECESSARY SERVICING, REPAIR OR CORRECTION.

16.IN NO EVENT UNLESS REQUIRED BY APPLICABLE LAW OR AGREED TO IN WRITING WILL ANY COPYRIGHT HOLDER, OR ANY OTHER PARTY WHO MAY MODIFY AND/OR REDISTRIBUTE THE LIBRARY AS PERMITTED ABOVE, BE LIABLE TO YOU FOR DAMAGES, INCLUDING ANY GENERAL, SPECIAL, INCIDENTAL OR CONSEQUENTIAL DAMAGES ARISING OUT OF THE USE OR INABILITY TO USE THE LIBRARY (INCLUDING BUT NOT LIMITED TO LOSS OF DATA OR DATA BEING RENDERED INACCURATE OR LOSSES SUSTAINED BY YOU OR THIRD PARTIES OR A FAILURE OF THE LIBRARY TO OPERATE WITH ANY OTHER SOFTWARE), EVEN IF SUCH HOLDER OR OTHER PARTY HAS BEEN ADVISED OF THE POSSIBILITY OF SUCH DAMAGES.

END OF TERMS AND CONDITIONS

How to Apply These Terms to Your New Libraries

If you develop a new library, and you want it to be of the greatest possible use to the public, we recommend making it free software that everyone can redistribute and change. You can do so by permitting redistribution under these terms (or, alternatively, under the terms of the ordinary General Public License).

To apply these terms, attach the following notices to the library. It is safest to attach them to the start of each source file to most effectively convey the exclusion of warranty; and each file should have at least the "copyright" line and a pointer to where the full notice is found.

<one line to give the library's name and a brief idea of what it does.>

Copyright © <year> <name of author>

This library is free software; you can redistribute it and/or modify it under the terms of the GNU Lesser General Public License as published by the Free Software Foundation; either version 2 of the License, or (at your option) any later version.

This library is distributed in the hope that it will be useful, but WITHOUT ANY WARRANTY; without even the implied warranty of MERCHANTABILITY or FITNESS FOR A PARTICULAR PURPOSE. See the GNU Lesser General Public License for more details.

You should have received a copy of the GNU Lesser General Public License along with this library; if not, write to the Free Software Foundation, Inc., 59 Temple Place, Suite 330, Boston, MA 02111-1307 USA

Also add information on how to contact you by electronic and paper mail.

You should also get your employer (if you work as a programmer) or your school, if any, to sign a "copyright disclaimer" for the library, if necessary. Here is a sample; alter the names: Yoyodyne, Inc., hereby disclaims all copyright interest in the library 'Frob' (a library for tweaking knobs) written by James Random Hacker.

<signature of Ty Coon>, 1 April 1990

Ty Coon, President of Vice

That's all there is to it!

Licence information on the software used in the TOSHIBA HD DVD player (Continued)

Exhibit C**LICENSE ISSUES**

The OpenSSL toolkit stays under a dual license, i.e. both the conditions of the OpenSSL License and the original SSLeay license apply to the toolkit.

See below for the actual license texts. Actually both licenses are BSD-style Open Source licenses. In case of any license issues related to OpenSSL please contact openssl-core@openssl.org.

OpenSSL License

Copyright © 1998-2002 The OpenSSL Project. All rights reserved.

Redistribution and use in source and binary forms, with or without modification, are permitted provided that the following conditions are met:

1. Redistributions of source code must retain the above copyright notice, this list of conditions and the following disclaimer.
2. Redistributions in binary form must reproduce the above copyright notice, this list of conditions and the following disclaimer in the documentation and/or other materials provided with the distribution.
3. All advertising materials mentioning features or use of this software must display the following acknowledgment:

"This product includes software developed by the OpenSSL Project for use in the OpenSSL Toolkit. (<http://www.openssl.org/>)"

4. The names "OpenSSL Toolkit" and "OpenSSL Project" must not be used to endorse or promote products derived from this software without prior written permission. For written permission, please contact openssl-core@openssl.org.

5. Products derived from this software may not be called "OpenSSL" nor may "OpenSSL" appear in their names without prior written permission of the OpenSSL Project.

6. Redistributions of any form whatsoever must retain the following acknowledgment:

"This product includes software developed by the OpenSSL Project for use in the OpenSSL Toolkit (<http://www.openssl.org/>)"

THIS SOFTWARE IS PROVIDED BY THE OpenSSL PROJECT "AS IS" AND ANY EXPRESSED OR IMPLIED WARRANTIES, INCLUDING, BUT NOT LIMITED TO, THE IMPLIED WARRANTIES OF MERCHANTABILITY AND FITNESS FOR A PARTICULAR PURPOSE ARE DISCLAIMED. IN NO EVENT SHALL THE OpenSSL PROJECT OR ITS CONTRIBUTORS BE LIABLE FOR ANY DIRECT, INDIRECT, INCIDENTAL, SPECIAL, EXEMPLARY, OR CONSEQUENTIAL DAMAGES (INCLUDING, BUT NOT LIMITED TO, PROCUREMENT OF SUBSTITUTE GOODS OR SERVICES; LOSS OF USE, DATA, OR PROFITS; OR BUSINESS INTERRUPTION)

HOWEVER CAUSED AND ON ANY THEORY OF LIABILITY, WHETHER IN CONTRACT, STRICT LIABILITY, OR TORT (INCLUDING NEGLIGENCE OR OTHERWISE) ARISING IN ANY WAY OUT OF THE USE OF THIS SOFTWARE, EVEN IF ADVISED OF THE POSSIBILITY OF SUCH DAMAGE.

This product includes cryptographic software written by Eric Young (eay@cryptsoft.com). This product includes software written by Tim Hudson (tjh@cryptsoft.com).

Original SSLeay License

Copyright © 1995-1998 Eric Young (eay@cryptsoft.com) All rights reserved.

This package is an SSL implementation written by Eric Young (eay@cryptsoft.com).

The implementation was written so as to conform with Netscapes SSL.

This library is free for commercial and non-commercial use as long as the following conditions are adhered to. The following conditions apply to all code found in this distribution, be it the RC4, RSA, lhash, DES, etc., code; not just the SSL code. The SSL documentation included with this distribution is covered by the same copyright terms except that the holder is Tim Hudson (tjh@cryptsoft.com). Copyright remains Eric Young's, and as such any Copyright notices in the code are not to be removed.

If this package is used in a product, Eric Young should be given attribution as the author of the parts of the library used.

This can be in the form of a textual message at program startup or in documentation (online or textual) provided with the package.

Redistribution and use in source and binary forms, with or without modification, are permitted provided that the following conditions are met:

1. Redistributions of source code must retain the copyright notice, this list of conditions and the following disclaimer.

2. Redistributions in binary form must reproduce the above copyright notice, this list of conditions and the following disclaimer in the documentation and/or other materials provided with the distribution.

3. All advertising materials mentioning features or use of this software must display the following acknowledgement:

"This product includes cryptographic software written by Eric Young (eay@cryptsoft.com)"

The word 'cryptographic' can be left out if the routines from the library being used are not cryptographic related :-).

4. If you include any Windows specific code (or a derivative thereof) from the apps directory (application code) you must include an acknowledgement:

"This product includes software written by Tim Hudson (tjh@cryptsoft.com)"

THIS SOFTWARE IS PROVIDED BY ERIC YOUNG "AS IS" AND ANY EXPRESS OR IMPLIED WARRANTIES, INCLUDING, BUT NOT LIMITED TO, THE IMPLIED WARRANTIES OF MERCHANTABILITY AND FITNESS FOR A PARTICULAR PURPOSE ARE DISCLAIMED. IN NO EVENT SHALL THE AUTHOR OR CONTRIBUTORS BE LIABLE FOR ANY DIRECT, INDIRECT, INCIDENTAL, SPECIAL, EXEMPLARY, OR CONSEQUENTIAL DAMAGES (INCLUDING, BUT NOT LIMITED TO, PROCUREMENT OF SUBSTITUTE GOODS OR SERVICES; LOSS OF USE, DATA, OR PROFITS; OR BUSINESS INTERRUPTION) HOWEVER CAUSED AND ON ANY THEORY OF LIABILITY, WHETHER IN CONTRACT, STRICT LIABILITY, OR TORT (INCLUDING NEGLIGENCE OR OTHERWISE) ARISING IN ANY WAY OUT OF THE USE OF THIS SOFTWARE, EVEN IF ADVISED OF THE POSSIBILITY OF SUCH DAMAGE.

The licence and distribution terms for any publically available version or derivative of this code cannot be changed. i.e. this code cannot simply be copied and put under another distribution licence [including the GNU Public Licence.]

Exhibit D

This copy of the libpng notices is provided for your convenience. In case of any discrepancy between this copy and the notices in the file png.h that is included in the libpng distribution, the latter shall prevail.

COPYRIGHT NOTICE, DISCLAIMER, and LICENSE:

If you modify libpng you may insert additional notices immediately following this sentence.

libpng version 1.2.6, December 3, 2004, is

Copyright © 2004 Glenn Randers-Pehrson, and is distributed according to the same disclaimer and license as libpng-1.2.5 with the following individual added to the list of Contributing Authors

Cosmin Truta

libpng versions 1.0.7, July 1, 2000, through 1.2.5 - October 3, 2002, are Copyright © 2000-2002 Glenn Randers-Pehrson, and are distributed according to the same disclaimer and license as libpng-1.0.6 with the following individuals added to the list of Contributing Authors

Simon-Pierre Cadieux

Eric S. Raymond

Gilles Vollant

and with the following additions to the disclaimer:

There is no warranty against interference with your enjoyment of the library or against infringement. There is no warranty that our efforts or the library will fulfill any of your particular purposes or needs. This library is provided with all faults, and the entire risk of satisfactory quality, performance, accuracy, and effort is with the user.

libpng versions 0.97, January 1998, through 1.0.6, March 20, 2000, are Copyright © 1998, 1999 Glenn Randers-Pehrson, and are distributed according to the same disclaimer and license as libpng-0.96, with the following individuals added to the list of Contributing Authors:

Tom Lane

Glenn Randers-Pehrson

Willem van Schaik

libpng versions 0.89, June 1996, through 0.96, May 1997, are Copyright © 1996, 1997 Andreas Dilger

Distributed according to the same disclaimer and license as libpng-0.88, with the following individuals added to the list of Contributing Authors:

John Bowler

Kevin Bracey

Sam Bushell

Magnus Holmgren

Greg Roelofs

Tom Tanner

libpng versions 0.5, May 1995, through 0.88, January 1996, are Copyright © 1995, 1996 Guy Eric Schalnat, Group 42, Inc.

For the purposes of this copyright and license, "Contributing Authors" is defined as the following set of individuals:

Andreas Dilger

Dave Martindale

Guy Eric Schalnat

Paul Schmidt

Tim Wegner

The PNG Reference Library is supplied "AS IS". The Contributing Authors and Group 42, Inc. disclaim all warranties, expressed or implied, including, without limitation, the warranties of merchantability and of fitness for any purpose. The Contributing Authors and Group 42, Inc. assume no liability for direct, indirect, incidental, special, exemplary, or consequential damages, which may result from the use of the PNG Reference Library, even if advised of the possibility of such damage.

Permission is hereby granted to use, copy, modify, and distribute this source code, or portions hereof, for any purpose, without fee, subject to the following restrictions:

1. The origin of this source code must not be misrepresented.
2. Altered versions must be plainly marked as such and must not be misrepresented as being the original source.
3. This Copyright notice may not be removed or altered from any source or altered source distribution.

The Contributing Authors and Group 42, Inc. specifically permit, without fee, and encourage the use of this source code as a component to supporting the PNG file format in commercial products. If you use this source code in a product, acknowledgment is not required but would be appreciated.

A "png_get_copyright" function is available, for convenient use in "about" boxes and the like:

```
printf("%s",png_get_copyright(NULL));
```

Also, the PNG logo (in PNG format, of course) is supplied in the files "pngbar.png" and "pngbar.jpg" (88x31) and "pngnow.png" (98x31).

Libpng is OSI Certified Open Source Software. OSI Certified Open Source is a certification mark of the Open Source Initiative.

Glenn Randers-Pehrson

glennrp at users.sourceforge.net

3-Dec-04

Exhibit E

Portions of this software are copyright © 2005 The FreeType Project (www.freetype.org). All rights reserved.

- This product includes software developed by the OpenSSL project.
- This product includes software that uses the IJG code.
- Reverse engineering, disassembling, decompiling, dismantling, or otherwise attempting to analyze or modify the software included in this product is prohibited.

Before calling service personnel

If you experience any of the following difficulties while using this unit, check the list below before consulting your nearest Toshiba dealer.

Symptom	Remedy
■ No power.	→ Is the power plug disconnected? Check the power connection.
■ No picture.	→ Is the cable for connecting the player and TV disconnected or not connected properly? Check the connections (➡ page 21 – 22) → Switch the input of the connected TV to the signal from the player. → Are both the HDMI OUTPUT jack and the COMPONENT OUTPUT jacks connected simultaneously? Select either connection and make the appropriate setting. (➡ page 21 – 24)
■ No sound.	→ Is the audio cable disconnected? (➡ page 22) → Is the volume of the device turned down to the minimum level? Check the volume. → Switch the audio input of the device connected by the audio cable to the input from the player. → Set “Digital Output SPDIF” or “Digital Output HDMI” (➡ page 53) properly in accordance with the connected device and connection procedure. → Change the output resolution (➡ page 23) so that sound can be heard.
■ The disc does not play.	→ Make sure the disc type can be played with the player (➡ page 28). → Is the disc dirty or scratched? Check or clean the disc. (➡ page 29) → If the disc is an HD DVD-R, DVD-RW or DVD-R disc, finalize the disc before attempting to play it with the player. → If the disc includes parent lock support, playback is restricted while the parent lock of the player is set. Cancel Parental Lock (➡ page 56) or change the restriction level.
■ Playback picture has noise.	→ If video from the player is watched via a video recorder or on a TV with a built-in video recorder, the copy guard may prevent images from being displayed properly. Be sure to connect the player directly to the TV.
■ The remote control does not work.	→ Are the batteries of the remote control dead? Replace the batteries. (➡ page 16) → Make sure the remote control is within range and pointed in the correct direction.
■ Screen freezes and no buttons work.	→ Pressing ON/STANDBY button on the player for approximately ten seconds forces the player to turn off. Turn the player off and then on again.

Specification

■ Power requirement

???.?W

■ Power supply

120V AC 60Hz

■ Mass

?.?kg

■ External dimension

Width ??? x Height ??? x Depth ???mm

■ Signal system

Standard NTSC Color TV system

■ Laser

Semiconductor laser, Wavelength: 405nm/650nm/
780nm

■ VIDEO output

1.0Vp-p (75Ω), Sync signal negative,

Pin jack x 1 system

■ S-VIDEO output

(Y) 1.0Vp-p (75Ω), Sync signal negative,

(C) 0.286Vp-p (75Ω), 1 at rear

Mini DIN4 Pin x 1 systems

■ Component output (Y, P_B P_R)

Y output (green), 1.0Vp-p (75Ω),

Sync signal negative, Pin jack x 1 system

P_B, P_R output (blue, red), 0.7Vp-p (75Ω),

Pin jack x 1 system each

■ Analog audio output

2.0V (rms), 2.2kΩ or below, pin jack

(L, R) x 2 systems

■ Digital audio output (BITSTREAM/PCM jack)

Optical connector x 1 system

■ LAN port

100BASE-TX/10BASE-T x 1

■ EXTENSION port

EXTENSION port x 2 systems

■ HDMI output

19 pin

■ Remote control

Wireless remote control (SE-R0252)

■ Operating conditions

Temperature: 41°F ~ 95°F (5°C ~ 35°C),

Position: Horizontal

■ Clock accuracy

Quartz (monthly deviation: approximately ±30 seconds)

- This model complies with the above specifications.
- Designs and specifications are subject to change without notice.
- This model may not be compatible with features and/or specifications that may be added in the future.
- The Illustrations and screens described in this manual may be exaggerated or simplified for easy recognition and may be slightly different from the actual unit.

Limited United States Warranty

Digital Audio Video ("DAV") Product-Depot Repair Warranty

Toshiba America Consumer Products, L.L.C., ("TACP") makes the following limited warranties to original consumers in the United States. THESE LIMITED WARRANTIES EXTEND TO THE ORIGINAL CONSUMER PURCHASER OR ANY PERSON RECEIVING THIS DAV PRODUCT AS A GIFT FROM THE ORIGINAL CONSUMER PURCHASER AND TO NO OTHER PURCHASER OR TRANSFEREE.

DAV PRODUCTS PURCHASED IN THE U.S.A. AND USED ANYWHERE OUTSIDE OF THE U.S.A., INCLUDING, WITHOUT LIMITATION, CANADA AND MEXICO, ARE NOT COVERED BY THESE WARRANTIES.

DAV PRODUCTS PURCHASED ANYWHERE OUTSIDE OF THE U.S.A., INCLUDING, WITHOUT LIMITATION, CANADA AND MEXICO, AND USED IN THE U.S.A., ARE NOT COVERED BY THESE WARRANTIES.

Limited Ninety (90) Day Warranty on Labor*

TACP warrants this DAV Product and its parts against defects in materials or workmanship for a period of ninety (90) days after the date of original retail purchase. DURING THIS PERIOD, TACP WILL, AT TACP'S OPTION, REPAIR OR REPLACE A DEFECTIVE PART WITH A NEW OR REFURBISHED PART WITHOUT CHARGE TO YOU FOR PARTS OR LABOR.

Limited One (1) Year Warranty on Parts*

TACP further warrants the parts in this DAV Product against defects in materials or workmanship for a period of one (1) year after the date of original retail purchase. DURING THIS PERIOD, TACP WILL, AT TACP'S OPTION, REPAIR OR REPLACE A DEFECTIVE PART WITH A NEW OR REFURBISHED PART WITHOUT CHARGE TO YOU FOR THE PART, PROVIDED THAT IF A DEFECTIVE PART IS REPAIRED OR REPLACED AFTER NINETY (90) DAYS FROM THE DATE OF ORIGINAL RETAIL PURCHASE, THE CONSUMER SHALL PAY ALL LABOR CHARGES INVOLVED IN THE REPAIR OR REPLACEMENT THEREOF.

*Rental Units

The warranty for DAV Product rental units begins on the date of the first rental or thirty (30) days after the date of shipment to the rental firm, whichever comes first.

*Commercial Units

DAV Products sold and used for commercial purposes have a limited warranty for all parts and labor, which warranty begins on the date of original retail purchase and ends on the date that is ninety (90) days thereafter.

Owner's Manual and Product Registration Card

Read this owner's manual thoroughly before operating this DAV Product.

Complete and mail the enclosed product registration card or register your DAV Product on-line at www.tacp.toshiba.com/service as soon as possible. By registering your DAV Product you will enable TACP to bring you new products specifically designed to meet your needs and help us to contact you in the unlikely event a safety notification is required under the Consumer Product Safety Act. Failure to complete and return the product registration card does not diminish your warranty rights.

Your Responsibility

THE ABOVE WARRANTIES ARE SUBJECT TO THE FOLLOWING CONDITIONS:

- (1) You must retain your bill of sale or provide other proof of purchase.
- (2) All warranty servicing of this DAV Product must be made by the Depot Warranty Repair Center specified by the TACP Consumer Solutions Center.
- (3) The warranties from TACP are effective only if the DAV Product is purchased and operated in the United States or Puerto Rico.
- (4) Labor service charges for set installation, setup, adjustment of customer controls and installation or repair of antenna systems are not covered by this warranty. Reception problems caused by inadequate antenna systems are your responsibility.
- (5) Warranties extend only to defects in materials or workmanship as limited above and do not extend to any DAV Product or parts that have been lost or discarded by you or to damage to DAV Product or parts caused by fires, misuse, accident, Acts of God, such as lightning or fluctuations in electric power, improper installation, improper maintenance or use in violation of instructions furnished by TACP; use or malfunction through simultaneous use of this DAV Product and connected equipment; or to units that have been modified or had the serial number removed, altered, defaced, or rendered illegible.

How to Obtain Warranty Services

If, after following all of the operating instructions in this manual and checking the section "Before calling service personnel", you find that service is needed:

- (1) For instructions on how to obtain warranty service for your DAV Product, contact TACP's Consumer Solution Center toll-free at 1-800-319-6684.
- (2) You must include a copy of original bill of sale or other proof of purchase along with the entire DAV Product to the Depot Warranty Repair Center specified by the TACP Consumer Solutions Center. You are responsible for all inbound transportation and insurance charges for the DAV Product to the Depot Warranty Repair Center specified by the TACP Consumer Solutions Center.

For additional information, visit TACP's web site:
www.tacp.toshiba.com.

ALL WARRANTIES IMPLIED BY THE LAW OF ANY STATE OF THE U.S.A., INCLUDING THE IMPLIED WARRANTIES OF MERCHANTABILITY AND FITNESS FOR A PARTICULAR PURPOSE, ARE EXPRESSLY LIMITED TO THE DURATION OF THE LIMITED WARRANTIES SET FORTH ABOVE. WITH THE EXCEPTION OF ANY WARRANTIES IMPLIED BY THE LAW OF ANY STATE OF THE U.S.A. AS HEREBY LIMITED, THE FOREGOING WARRANTY IS EXCLUSIVE AND IN LIEU OF ALL OTHER WARRANTIES, GUARANTEES, AGREEMENTS, AND SIMILAR OBLIGATIONS OF TACP WITH RESPECT TO THE REPAIR OR REPLACEMENT OF ANY PARTS. IN NO EVENT SHALL TACP BE LIABLE FOR CONSEQUENTIAL OR INCIDENTAL DAMAGES (INCLUDING, BUT NOT LIMITED TO, LOST PROFITS, BUSINESS INTERRUPTION, OR MODIFICATION OR ERASURE OF RECORDED DATA CAUSED BY USE, MISUSE OR INABILITY TO USE THIS DAV PRODUCT).

No person, agent, distributor, dealer or company is authorized to change, modify or extend the terms of these warranties in any manner whatsoever. The time within which an action must be commenced to enforce any obligation of TACP arising under the warranty or under any statute, or law of the United States or of any state thereof, is hereby limited to ninety (90) days from the date you discovered or should have discovered, the defect. This limitation does not apply to implied warranties arising under state law.

THIS WARRANTY GIVES YOU SPECIFIC LEGAL RIGHTS AND YOU MAY ALSO HAVE OTHER RIGHTS WHICH MAY VARY FROM STATE TO STATE IN THE U.S.A. SOME STATES OF THE U.S.A. DO NOT ALLOW LIMITATIONS ON HOW LONG AN IMPLIED WARRANTY LASTS, WHEN AN ACTION MAY BE BROUGHT, OR THE EXCLUSION OR LIMITATION OF INCIDENTAL OR CONSEQUENTIAL DAMAGES, SO THE ABOVE PROVISIONS MAY NOT APPLY TO YOU UNDER SUCH CIRCUMSTANCES.



- IMPORTANT - CANADIAN WARRANTY INFORMATION GARANTIE CANADIENNE

STANDARD WARRANTY TYPE OF SET

DVD Player
DVD/VCR Combination
Home Theatre in a Box
DVD Recorder
Portable DVD

WARRANTY PERIOD

12 MONTHS

GARANTIE NORMALE TYPE D'APPAREIL

Lecteur DVD
DVD/magnétoscope combo
Cinéma maison dans une boîte
Enregistreur DVD
DVD Portatif

DURÉE DE LA GARANTIE: 12 MOIS

CANADIAN WARRANTY

Toshiba of Canada Limited (TCL) makes the following limited warranties to original consumers in Canada.

Please retain your "Bill of Sale" as proof of purchase.

To obtain a "Canadian Warranty" please register online at www.toshiba.ca.

GARANTIE CANADIENNE

1) Toshiba du Canada Limitée (TCL) offre au Canada les garanties limitées suivantes aux consommateurs originaux. Veuillez conserver votre « facture » comme preuve d'achat.

Pour obtenir une garantie canadienne, veuillez vous inscrire en ligne à www.toshiba.ca

Canadian Warranty Information

Should service be required on this unit during the one year warranty period, TCL's option will be to repair or exchange the defective unit. It will be necessary to follow this procedure:

Contact: Toshiba of Canada Limited at the Consumer Electronics Group, customer support line.

Phone: 1-800-268-3404

Email: ceg_customer_support@toshiba.ca

All in-warranty repairs must be made by an authorized TCL service centre.

For service exchange TCL will arrange to have the unit picked up by courier and a replacement unit will be returned via same courier. (Note: A major credit card number will be required as a charge of \$25.00 will apply if no fault is found with the unit.)

During the first 3 months of ownership, a new unit will be supplied as a replacement. During the remainder of the warranty period a service-renewed unit will be supplied. The original "Bill of Sale" must be provided as proof of purchase (it will be returned with the replacement unit.)

This 12-month warranty will be strictly adhered to.

Out of warranty units should be repaired by a TCL authorized service centre.

Note: It is the responsibility of the owner to ensure proper packaging. Should damage in shipping occur, due to poor packaging, a charge back for the repair will result. This warranty applies to the original purchaser only and is not transferable.

This warranty does not apply to sets that have been subjected to misuse, neglect, accident, physical damage or acts of nature.

Sets with the serial number removed, altered, replaced or defaced will not be covered by this warranty.

The warranties from TCL are effective only if the product is purchased in Canada from an authorized TCL dealer and operated in Canada.

Products utilized for rental or commercial purposes are not covered by this warranty.

This warranty is in lieu of all other warranties, guaranties or agreements, whether expressed or implied, and no person, agent distributor, dealer, service centre or company is authorized to change, modify or extend its terms in any manner whatsoever.

Information sur la garantie Canadienne

Si vous avez besoin de service sur cet appareil au cours de l'année de garantie, Toshiba du Canada Limitée aura l'option de réparer ou échanger l'appareil défectueux. Vous devrez suivre la procédure suivante:

Contact: Toshiba du Canada Limitée au Groupe Électronique aux consommateurs, service à la clientèle.

Tél: 1-800-268-3404

Courriel: ceg_customer_support@toshiba.ca

Toutes les réparations au cours de la garantie doivent être faites par un centre de service autorisé Toshiba.

Pour un échange TCL s'assurera qu'un service de courrier ramassera l'unité et qu'un appareil de remplacement soit expédié par le même service de courrier.

(Note: Un numéro de carte de crédit sera requis car une charge de 25,00\$ sera appliquée si toutefois l'appareil n'avait aucun problème de fonctionnement.)

Une nouvelle unité sera fournie comme remplacement durant les premiers 3 mois de propriété. Par contre durant la balance de la garantie une unité remise à neuf sera fournie.

La «facture originale doit être fournie comme preuve d'achat (elle vous sera retournée avec l'unité de remplacement.)

Cette garantie de 12 mois sera strictement adhéree.

Les unités hors de garantie devraient être réparées par un centre de service autorisé Toshiba.

Note: C'est la responsabilité du propriétaire de s'assurer que l'emballage est adéquat. Vous serez facturé pour toutes réparations causées par des dommages encourus à cause d'un emballage non adéquat.

Cette garantie est octroyée à l'acheteur initial et n'est pas transférable. Cette garantie ne s'applique pas aux appareils qui ont été sujets aux abus, négligences, accidents, dommages physiques ou actes naturels.

Les appareils dont le numéro de série a été enlevé, altéré, remplacé ou barbouillé ne sont pas couverts par cette garantie. Les garanties de TCL sont valides seulement sur les unités qui sont achetées et utilisées au Canada d'un marchand autorisé TCL.

Cette garantie ne couvre pas les produits de location ou à usage commercial. Cette garantie remplace toutes autres garanties ou ententes exprimées ou sous-entendues. Aucune personne, agent, distributeur, concessionnaire ou compagnie n'est autorisé à changer, modifier ou prolonger les termes de cette garantie de quelque façon que ce soit.

INFORMATION ON CUSTOMER SUPPORT

HD DVD is a new and evolving format, so changes and improvements are possible. To obtain updated information about HD DVD and this product, as well as customer support information about this product, please contact Toshiba Customer Support:

* In the U.S., please call 1 (800) 319-6684 or visit www.tacp.com/customersupport.

* In Canada, please call 1 (800) 268-3404 or visit www.toshiba.ca and click on support.

TOSHIBA



Printed on 100% Recycled Paper

ⓂPM0025988010