

# PERFORMAX<sup>®</sup>

**WMH TOOL GROUP**

Operating Instructions and Parts Manual  
Drum Sander  
Model: 10-20 PLUS



(shown with optional accessories)

**WMH Tool Group**  
2420 Vantage Drive  
Elgin, Illinois 60123  
Phone: 800-274-6848  
[www.wmhtoolgroup.com](http://www.wmhtoolgroup.com)

**Part No.: M-628900**  
Revision: B 11/03  
Copyright © WMH Tool Group

This manual has been prepared for the owner and operators of a Performax 10-20 Drum Sander. Its purpose, aside from machine operation, is to promote safety using accepted operating and maintenance procedures. To obtain maximum life and efficiency from your Drum Sander and to aid in using it safely, please read this manual thoroughly and follow instructions carefully.

## **Warranty & Service**

WMH Tool Group warrants every product it sells. If one of our tools needs service or repair, one of our Authorized Repair Stations located throughout the United States can provide quick service or information.

In most cases, a WMH Tool Group Repair Station can assist in authorizing repair work, obtaining parts, or perform routine or major maintenance repair on your Performax product.

For the name of an Authorized Repair Station in your area, please call 1-800-274-6848, or visit our web site at [www.wmhtoolgroup.com](http://www.wmhtoolgroup.com)

## **More Information**

Remember, WMH Tool Group is consistently adding new products to the line. For complete, up-to-date product information, check with your local WMH Tool Group distributor, or visit our web site at [www.wmhtoolgroup.com](http://www.wmhtoolgroup.com)

## **WMH Tool Group Warranty**

WMH Tool Group makes every effort to assure that its products meet high quality and durability standards and warrants to the original retail consumer/purchaser of our products that each product be free from defects in materials and workmanship as follows: 1 YEAR LIMITED WARRANTY ON ALL PRODUCTS UNLESS SPECIFIED OTHERWISE. This Warranty does not apply to defects due directly or indirectly to misuse, abuse, negligence or accidents, normal wear-and-tear, repair or alterations outside our facilities, or to a lack of maintenance.

WMH TOOL GROUP LIMITS ALL IMPLIED WARRANTIES TO THE PERIOD SPECIFIED ABOVE, BEGINNING FROM THE DATE THE PRODUCT WAS PURCHASED AT RETAIL. EXCEPT AS STATED HEREIN, ANY IMPLIED WARRANTIES OR MERCHANTABILITY AND FITNESS ARE EXCLUDED. SOME STATES DO NOT ALLOW LIMITATIONS ON HOW LONG THE IMPLIED WARRANTY LASTS, SO THE ABOVE LIMITATION MAY NOT APPLY TO YOU. IN NO EVENT SHALL WMH TOOL GROUP BE LIABLE FOR DEATH, INJURIES TO PERSONS OR PROPERTY, OR FOR INCIDENTAL, CONTINGENT, SPECIAL, OR CONSEQUENTIAL DAMAGES ARISING FROM THE USE OF OUR PRODUCTS. SOME STATES DO NOT ALLOW THE EXCLUSION OR LIMITATION OF INCIDENTAL OR CONSEQUENTIAL DAMAGES, SO THE ABOVE LIMITATION OR EXCLUSION MAY NOT APPLY TO YOU.

To take advantage of this warranty, the product or part must be returned for examination, postage prepaid, to an Authorized Repair Station designated by our office. Proof of purchase date and an explanation of the complaint must accompany the merchandise. If our inspection discloses a defect, we will either repair or replace the product at our discretion, or refund the purchase price if we cannot readily and quickly provide a repair or replacement. We will return the repaired product or replacement at WMH Tool Group's expense, but if it is determined there is no defect, or that the defect resulted from causes not within the scope of WMH Tool Group's warranty, then the user must bear the cost of storing and returning the product. This warranty gives you specific legal rights; you may also have other rights, which vary from state to state.

WMH Tool Group sells through distributors only. Members of the WMH Tool Group reserve the right to effect at any time, without prior notice, alterations to parts, fittings and accessory equipment, which they may deem necessary for any reason whatsoever.

## Table of Contents

Warranty & Service.....	2
More Information.....	2
WMH Tool Group Warranty.....	2
Table of Contents.....	3
Introduction.....	6
Specifications.....	6
Grounding Instructions.....	7
115 Volt Operation.....	7
Contents of the Shipping Carton.....	8
Unpacking.....	8
Assembly and Setup.....	8
Performax 10-20 Accessories.....	8
On/Off Switch.....	9
Switch Lock.....	9
Circuit Breaker.....	9
Conveyor Belt Tracking.....	11
Conveyor Belt Tension.....	11
Drum Height Control.....	11
Checking Drum Alignment.....	12
Aligning the Drum.....	12
Fine Tuning Drum Alignment.....	12
Wrapping Abrasive Strips.....	13
Using the TUF Tool™.....	14
Connecting Sander to a Dust Collector.....	15
Setting the Depth Gauge.....	15
Setting the Depth of Cut.....	15
Establishing the Proper Drum Height.....	15
Abrasives.....	16
Selecting Drum Abrasives.....	16
Selecting Abrasive Grits.....	16
Cleaning Abrasive Strips.....	16
Stretching Abrasive Life.....	16
Performax 10-20 Abrasives.....	17
Ready-to-Wrap.....	17
Ready-to-Cut (Aluminum oxide).....	17
Ready-to-Cut “Blue” (longer life).....	17
Stock Feeding Angle.....	17
Multiple-Piece Sanding Runs.....	17
Edge Sanding.....	17
Sanding Imperfect Stock.....	17
Face Frames and Raised Panel Doors.....	17
Monthly Maintenance.....	17
Conveyor Belt Replacement.....	18
Tension Roller Alignment.....	18
Tension Roller Pressure Adjustment.....	18
Drum Height Control Adjustment.....	18
Troubleshooting Guide.....	19
Exploded View – 10-20 PLUS Sander.....	20
Parts List for the 10-20 PLUS Sander.....	21
Wiring Diagram.....	23



# Warnings

1. Read and understand the entire owners manual before attempting assembly or operation.
2. Read and understand the warnings posted on the machine and in this manual. Failure to comply with all of these warnings may cause serious injury.
3. Replace the warning labels if they become obscured or removed.
4. This drum sander is designed and intended for use by properly trained and experienced personnel only. If you are not familiar with the proper and safe operation of a drum sander, do not use until proper training and knowledge have been obtained.
5. Do not use this machine for other than its intended use. If used for other purposes, WMH Tool Group disclaims any real or implied warranty and holds itself harmless from any injury that may result from that use.
6. Always wear approved safety glasses/face shields while using this machine. Everyday eyeglasses only have impact resistant lenses; they are not safety glasses.
7. Before operating this machine, remove tie, rings, watches and other jewelry, and roll sleeves up past the elbows. Remove all loose clothing and confine long hair. Non-slip footwear is recommended.
8. Wear ear protectors (plugs or muffs) during extended periods of operation.
9. This drum sander is to be used with wood and wood products only. Use of this drum sander and a dust collector with metal products is a potential fire hazard.
10. Some dust created by power sanding, sawing, grinding, drilling and other construction activities contain chemicals known to cause cancer, birth defects or other reproductive harm. Some examples of these chemicals are:
  - Lead from lead based paint.
  - Crystalline silica from bricks, cement and other masonry products.
  - Arsenic and chromium from chemically treated lumber.Your risk of exposure varies, depending on how often you do this type of work. To reduce your exposure to these chemicals: work in a well-ventilated area and work with approved safety equipment, such as face or dust masks that are specifically designed to filter out microscopic particles.
11. Do not operate this sander while tired or under the influence of drugs, alcohol or any medication.
12. Make certain the switch is in the **OFF** position before connecting the machine to the power supply.
13. Always sand with the grain of the wood.
14. Always feed stock against the rotation of the drum.
15. Do not sand pieces of material that are too small to be safely supported.
16. When sanding a large piece, provide additional support at table height.
17. Always connect and use a dust collector to the drum sander while operating.
18. Make certain the machine is properly grounded.
19. Make all machine adjustments or maintenance with the machine unplugged from the power source.
20. Remove adjusting keys and wrenches. Form a habit of checking to see that keys and adjusting wrenches are removed from the machine before turning it on.
21. Keep machine guards in place at all times when the machine is in use. If removed for maintenance purposes, use extreme caution and replace the guards immediately.
22. Make sure the drum sander is firmly secured to the stand or bench before use.
23. Check damaged parts. Before further use of the machine, a guard or other part that is damaged should be carefully checked to determine that it will operate properly and perform its intended function – check for alignment of moving parts, binding of moving parts, breakage of parts, mounting, and any other conditions that may affect its operation. A guard or other part that is damaged should be properly repaired or replaced.
24. Provide for adequate space surrounding work area and non-glare, overhead lighting.
25. Keep the floor around the machine clean and free of scrap material, oil and grease.
26. Keep visitors a safe distance from the work area. **Keep children away.**
27. Make your workshop child proof with padlocks, master switches or by removing starter keys.
28. Give your work undivided attention. Looking around, carrying on a conversation and “horse-play” are careless acts that can result in serious injury.

# Warnings

29. Stand to one side of the conveyor and make sure no one else is standing in line with the conveyor while feeding into the machine. The drum sander operates at high speed and should a part slip, it will exit the machine at a high rate of speed and may result in injuries to anyone standing directly in front of the infeed. (Keep the conveyor belt clean and check pin-roll adjustments). Maintain a balanced stance at all times so that you do not fall or lean against the sanding drum or other moving parts. Do not overreach or use excessive force to perform any machine operation.
  30. Use the right tool. Don't force a tool or attachment to do a job for which it was not designed. The right tool will do the job better and safer at the rate for which it was designed.
  31. Use recommended accessories; improper accessories may be hazardous.
  32. Maintain tools with care. Keep tools sharp and clean for the best and safest performance. Follow instructions for lubricating and changing accessories.
  33. Never brush away sawdust while the machine is running. Use the correct speed and feed for the tool. Be sure that the tool is the correct one for your operation.
  34. Never stand on a machine. Serious injury could occur if the machine tipped or if the sanding drum is unintentionally contacted.
  35. Never leave the machine running unattended. Turn the power off and don't leave the machine until it comes to a complete stop.
  36. All doors should be closed, all panels replaced and other safety guards should be in place before the machine is started or operated.
  37. Keep your hands clear when feeding parts onto the conveyor. The part will be forced down as it begins to feed into the machine, causing a pinching action between the part and the table. Use caution! Hands should be clear of the stock and the table to avoid pinching. Never reach into a running machine. Turn off the electrical power and stop the machine before attempting to retrieve parts from within it. Keep your hands away from the sanding area. Contact with internal moving parts can result in the loss or injury to fingers, hands and arms.
  38. Remove loose items and unnecessary work pieces from the area before starting the machine.
- **ADDITIONAL INFORMATION** regarding the safe and proper operation of this product is available from the National Safety Council, 1121 Spring Lake Drive, Itasca, IL 60143-3201, in the Accident Prevention Manual for Industrial Operations and in the safety Data Sheets provided by the NSC. Please also refer to the American National Standards Institute ANSI 01.1 Safety Requirements for Woodworking Machinery and the U.S. Department of Labor OSHA 1910.213 Regulations.

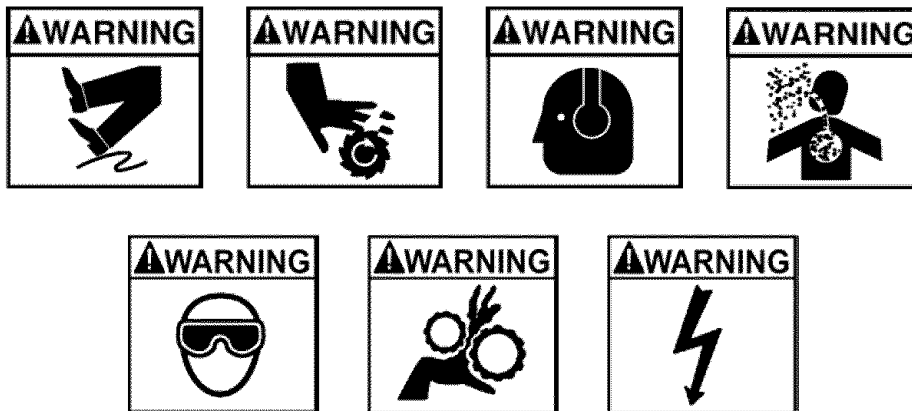

- - SAVE THESE INSTRUCTIONS - -

## Introduction

This manual is provided by Performax covering the safe operation and maintenance procedures for a Model 10-20 Plus Drum Sander. This manual contains instructions on installation, safety precautions, general operating procedures, maintenance instructions and parts breakdown. This machine has been designed and constructed to provide years of trouble free operation if used in accordance to instructions set forth in this manual. If there are any questions or comments, please contact either your local supplier or WMH Tool Group. WMH Tool Group can also be reached at our web site: [www.wmhtoolgroup.com](http://www.wmhtoolgroup.com).

## Specifications

Stock Number .....	628900
Max. Width (in) .....	20 (Two Passes)
Min. Length (in) .....	2-1/4
Max. Thickness (in) .....	3
Min. Thickness (in) .....	1/32
Drum (in) .....	5 x 10 Extruded Aluminum
Drum Speed (RPM).....	1700
Dust Chute (in) .....	4
Conveyor Motor.....	.43 inch-lb Torque, Direct Drive, D.C.
Conveyor Variable Feed Rate (FPM).....	0-12
Motor (TEFC) .....	1 HP, 1Ph, 115V only
Net Weight (lbs) .....	74

The specifications in this manual are given as general information only, and they are not binding. WMH Tool Group reserves the right to effect, at any time and without prior notice, changes or alterations to parts, fittings and accessory equipment deemed necessary for any reason whatsoever.

## Grounding Instructions

**CAUTION** This tool must be grounded while in use to protect the operator from electric shock.

In the event of a malfunction or breakdown, grounding provides a path of least resistance for electric current to reduce the risk of electric shock. This tool is equipped with an electric cord having an equipment-grounding conductor and a grounding plug. The plug must be plugged into a matching outlet that is properly installed and grounded in accordance with all local codes and ordinances.

Do not modify the plug provided. If it will not fit the outlet, have the proper outlet installed by a qualified electrician.

Improper connection of the equipment-grounding conductor can result in a risk of electric shock. The conductor, with insulation having an outer surface that is green with or without yellow stripes, is the equipment-grounding conductor. If repair or replacement of the electric cord or plug is necessary, do not connect the equipment-grounding conductor to a live terminal.

Check with a qualified electrician or service personnel if the grounding instructions are not completely understood, or if in doubt as to whether the tool is properly grounded. Use only three wire extension cords that have three-prong grounding plugs and three-pole receptacles that accept the tool's plug.

Repair or replace a damaged or worn cord immediately.

### 115 Volt Operation

As received from the factory, your sander is ready to run at 115-volt operation. This sander, when wired for 115 volts, is intended for use on a circuit that has an outlet and a plug that looks the one illustrated in Figure A. A temporary adapter, which looks like the adapter as illustrated in Figure B, may be used to connect this plug to a two-pole receptacle, as shown in Figure B if a properly grounded outlet is not available. The temporary adapter should only be used until a properly grounded outlet can be installed by a qualified electrician. **This adapter is not applicable in Canada.** The green colored rigid ear, lug, or tab, extending from the adapter, must be connected to a permanent ground such as a properly grounded outlet box, as shown in Figure B.

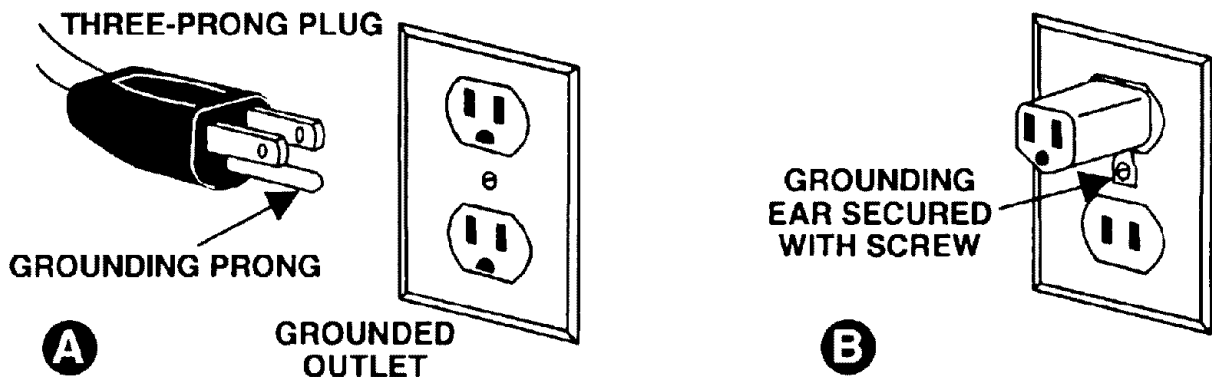

The use of an extension cord is not recommended. However, if you must use one make sure your extension cord is in good condition. Be sure to use one heavy enough to carry the current your machine will draw. An undersized cord will cause a drop in the line voltage resulting in power loss and overheating. The following table shows the correct size to use depending on the cord length needed and the nameplate ampere rating. If in doubt, use the next heavier gauge. Remember, the smaller the gauge number, the heavier the cord.

Volts	Total Length of Cord in Feet			
	25	50	100	150
<b>AWG</b>				
12-16 Amps	14	12	Not Recommended	

## Contents of the Shipping Carton

1. Sander Assembly
1. Handwheel with Handle
1. TUF Tool
1. Abrasive Strip (wrapped on the drum)
1. Conveyor Belt (attached to the base)
1. Owner's Manual
1. Warranty Card
1. Hardware Bag (for attaching the Sander to the Optional Open Stand) — containing:
  4. 3/8"-16x5/8" Hex Cap Screws
  4. 3/8" Flat Washers

### **WARNING**

Read and understand the entire contents of this manual before attempting assembly or operation of this drum sander. Failure to comply may cause serious injury.

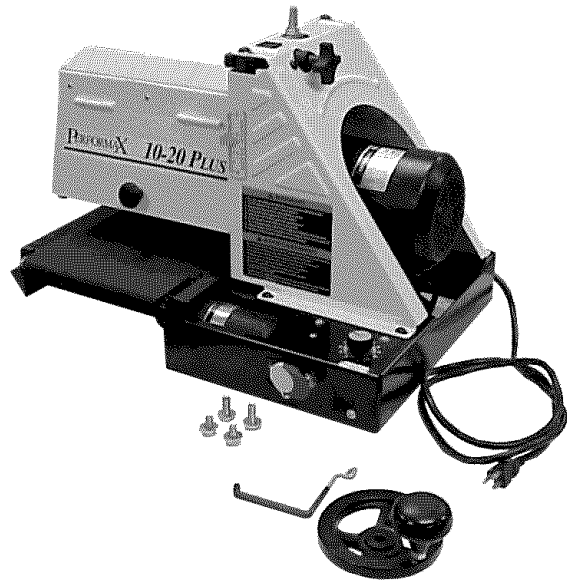

## Unpacking

1. Remove all the contents from the shipping carton.
2. Report any damage to your distributor.
3. Do not discard any shipping material until the sander has been assembled and is running properly.

## Assembly and Setup

If you purchased the optional Performax 10-20 Stand, refer to its assembly instructions before proceeding with the drum and conveyor assembly. **Note:** The figures shown in this manual may display the Performax 10-20-Plus Drum Sander with several optional accessories. To purchase any of these accessories contact your dealer.

1. Attach the handwheel (Figure 1, Item A) to the height adjustment screw and tighten.

## Performax 10-20 Accessories

Stock #	Description
638004	Open Stand with Shelf
608005	Infeed/Outfeed Tables
98-0130	Caster Set (4) for Open Stand
60-0505	Abrasive cleaning stick

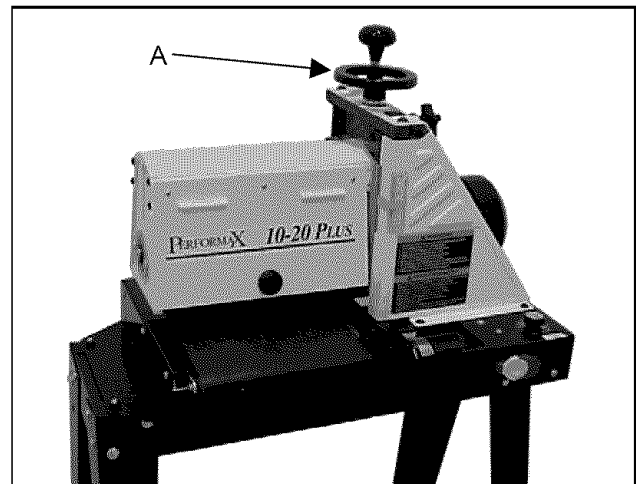

Figure 1



## On/Off Switch

### **▲WARNING**

Before powering up the unit, make sure all of the tools used to assemble and adjust the unit are removed and accounted for. Make sure your hands, loose clothing and any other items that may get caught are safely away from the unit.

The On/Off Switch (Figure 2, Item A) is located on the front of the sander. To turn the sander on, pull the switch to the on position. To turn the sander off, push the switch to the off position.

### Switch Lock

The sander can be locked from unauthorized use by locking the switch. To lock the switch:

1. Turn the switch to the off position and disconnect the sander from the power source.
2. Pull the key (Figure 2, Item B) out. The switch cannot be turned on with the key removed.

### **IMPORTANT**

Should the key be removed from the switch in the on position, the switch can be turned off but cannot be turned back on.

3. To replace the key, slide the key into the slot on the switch until it snaps.

### Circuit Breaker

The sander is equipped with a motor protective device (circuit breaker). The breaker will automatically shut the sander off when excessive current is consumed.

If the breaker is tripped, turn the sander off and reset the circuit breaker by pressing the button (Figure 2, Item C).

### **▲WARNING**

Be sure to turn the sander off before resetting the circuit breaker to avoid unintentionally starting the sander

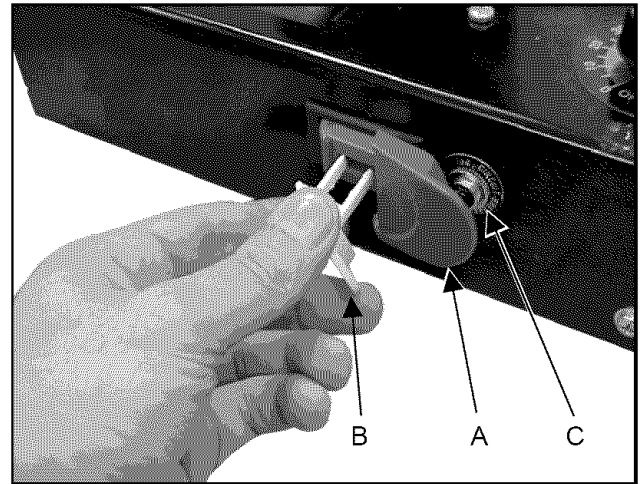

Figure 2

**This Page Intentionally Left Blank**

## Conveyor Belt Tracking

Belt tracking adjustment may be necessary during the break-in period and normal operation to compensate for belt stretching.

Abrasive belt tension must be properly adjusted before adjusting the tracking. Adjust the belt tracking while the conveyor belt is running at its fastest speed.

Tighten the hex nut (Figure 5, Item B) on the side the belt is drifting towards, and loosen the hex nut on the opposite side. Use the attached wrenches (Figure 5, Item C) to adjust the hex nuts.

**Note:** Adjustment should be made in 1/4 turns of the hex nut. Allow time for the belt to react to the adjustment. Do not over adjust.

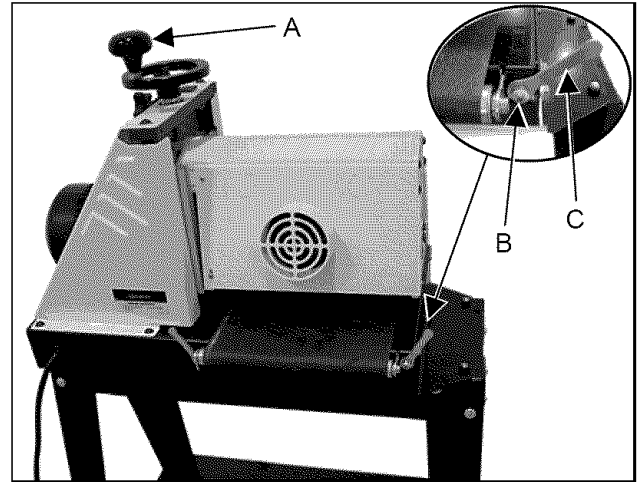

Figure 5

## Conveyor Belt Tension

Conveyor belt tension adjustment may be necessary during the break in period to compensate for belt stretching.

If the conveyor belt can be stopped by hand pressure applied directly to the top of the conveyor bed, the belt is too loose. Insufficient belt tension will cause slippage of the conveyor belt on the drive roller during sanding operations.

Excessive belt tension can cause tracking problems and result in bent rollers, bent take-up brackets and premature conveyor belt wear.

Adjust the hex nuts (Figure 5, Item B) on both sides of the conveyor to obtain a tight, and equally tensioned, conveyor belt. Use the attached wrenches (Figure 5, Item C) to adjust the hex nuts.

## Drum Height Control

Drum height is controlled by the height adjustment handle (Figure 5, Item A). Turning the handwheel in a counterclockwise direction lowers the drum.

Turning the height adjustment handwheel one revolution lowers the drum approximately 1/16".

## Checking Drum Alignment

The sanding drum comes preset from the factory. If a problem with the drum alignment occurs, follow the instructions listed below.

1. Lift the knob (Figure 6, Item A) to open the dust cover and remove the abrasive strip. If you are unsure how to do this, see the "Wrapping Abrasive Strips" section in this manual.
2. Using a metal straight edge, or ruler, as a thickness gauge (Figure 6, Item B), insert the gauge between the drum and the conveyor bed on the outer end of the drum.
3. Open the dust cover and lower the sanding drum while slowly rotating the drum by hand until the drum lightly contacts the thickness gauge.
4. Remove the thickness gauge and place it under the drum at the opposite end. If the drum does not contact the thickness gauge to the same degree as the other end of the drum, alignment is necessary.

## Aligning the Drum

1. Loosen the two hex cap bolts (Figure 7, Item C).
2. Lay the thickness gauge under the drum lengthwise.
3. Adjust the knob, (Figure 7, Item D) until the drum contacts the gauge equally along its entire surface. Turn the adjusting knob clockwise to lower the outboard end of the drum, and counterclockwise to raise the outboard end of the drum.
4. When the drum is parallel to the conveyor, tighten the two hex cap bolts.

## Fine Tuning Drum Alignment

When sanding boards wider than the drum, drum alignment is critical and must be adjusted slightly higher on the outboard end. This will prevent any ridges from developing in the stock. Always check it on a piece of scrap wood, as follows, before sanding the work piece.

Run a piece of scrap wood approximately 6" wide by 16" to 18" long through the sander sideways so that the end of the board extends past the end of the drum.

Turn the board 180 degrees and sand the same side without changing the sanding height.

If a ridge is visible where the drum overlaps, loosen the two hex cap bolts (Figure 7, Item C) and turn the adjusting knob (Figure 7, Item D) slightly. Turn the adjusting knob clockwise to lower the outboard end of the drum and counterclockwise to raise it. Tighten the two hex cap bolts. Repeat this process until the ridge is gone and the entire board is sanded.

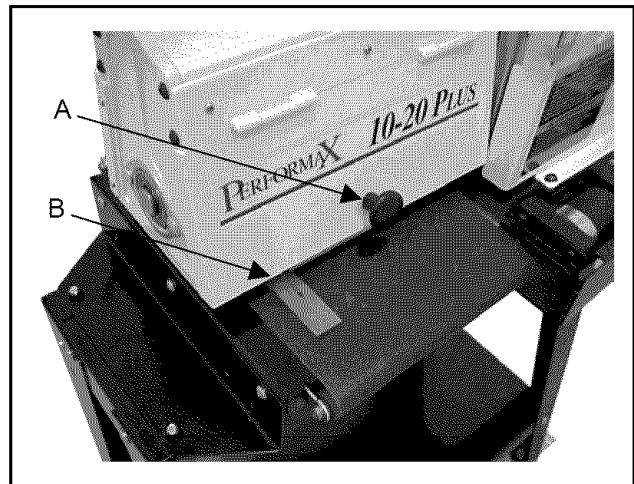

Figure 6

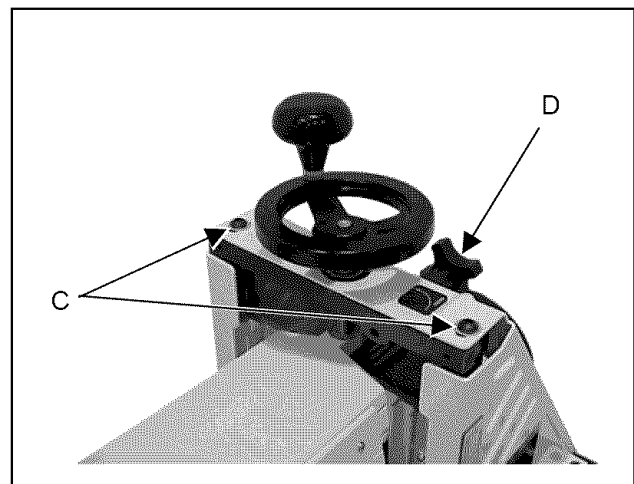

Figure 7

## Wrapping Abrasive Strips

**Note:** When using Performax “Ready to Wrap” and “Ready to Cut” abrasives, not all of the steps below are necessary. You can use the original abrasive belt that came with the sander as a template for cutting your own strips.

1. Mark and cut a taper at one end of the roll, as shown in Figure 8.
2. Square off the end of the taper, as shown in Figure 8.
3. Squeeze the fastener lever (Figure 9, Item A) on the outboard end of drum, and insert the tapered end of the abrasive (Figure 9, Item B) so that it uses most of the width of the slot. Release the fastener lever to securely hold the strip end to the fastener.
4. The square edge of the abrasive strip should follow the edge of the drum, as shown in Figure 9.
5. Wrap the abrasive strip around the drum, being careful not to overlap the windings, as shown in Figure 10.
6. Mark the trailing end of the strip where it crosses the inboard end of drum (Figure 11, Item C).
7. Remove the abrasive strip and cut a taper as was done with the starting edge, (See Figure 8). **Note:** The taper on the remaining roll can be used as the taper for the starting edge of the next strip to be cut.
8. Rewrap the drum starting at the left side as described in steps 3-5.
9. Squeeze the fastener lever on the inboard end of the drum, and insert the tapered end of the abrasive strip through the slot into the take-up fastener.

### IMPORTANT

Position the abrasive strip with sufficient room between the inside of the slot and the tapered end of the strip to allow it to be pulled into the drum as needed, (See Figure 12).

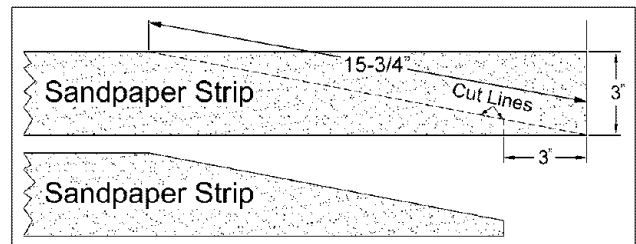

Figure 8

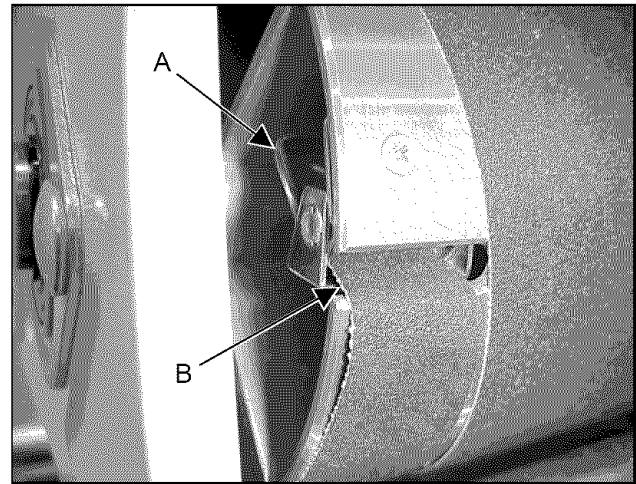

Figure 9

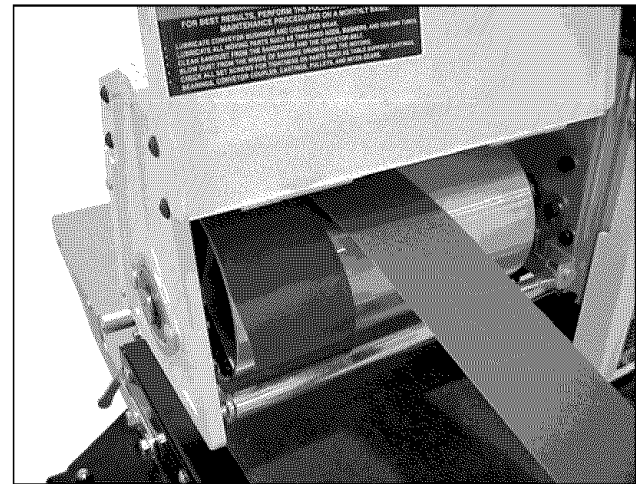

Figure 10

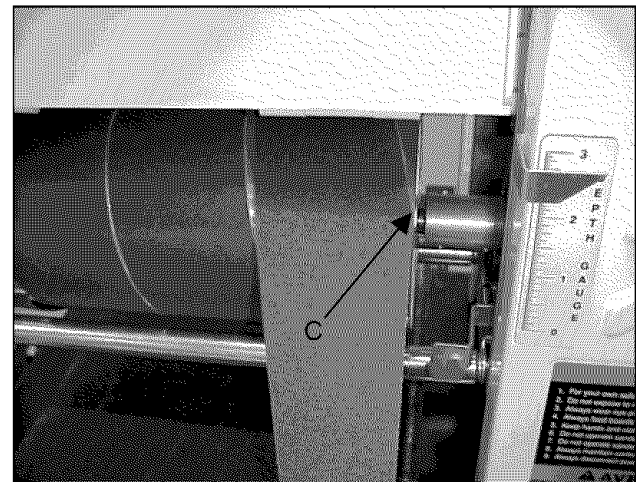

Figure 11

## Using the TUF Tool™

The Tuf Tool (Figure 13) can also be used to hold the take-up fastener in place while you feed the sandpaper through the slot.

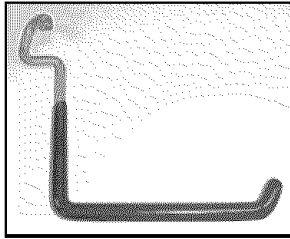

Figure 13

1. Clip the sandpaper into the outboard fastener. Wrap the drum, being careful not to overlap the windings. Hold the sandpaper over the inboard slot with the left hand.
2. Hold the TUF Tool with the red end of the tool pointing away from you (Figure 14). Insert the hook into the hole in the end of the take-up lever of the fastener (Figure 14).
3. Lift the lever with the TUF Tool, pulling the lever up until it touches the inside of the drum. Turn the TUF Tool counterclockwise and lower it onto the sandpaper, making sure it is holding the sandpaper tight and opening the throat of the fastener (Figure 15).
4. Insert the tapered end of the paper into the slot and the fastener. It may be necessary to trim the tapered end of the paper so it does not “bottom out” against the inside of the drum. Be sure to leave a gap of at least 1/8” between the tapered strip and the closed end of the slot to allow the strip to be pulled into the fastener as needed (Figure 15). If necessary trim the outside edge of the paper.
5. Hold the sandpaper in place with your left hand. Rotate the drum toward you slightly. Pull up on the TUF Tool and turn the handle clockwise while maintaining upward pressure. Slowly move the TUF Tool away from you slightly, then down, while easing it out of the hole. This releases the lever into its proper position. (Figure 16).

All abrasive strips will stretch with use and may stretch enough to allow the take-up lever to reach its lowest position so it cannot maintain tension on the strip. If this occurs, follow the above procedures to reset the take-up lever.

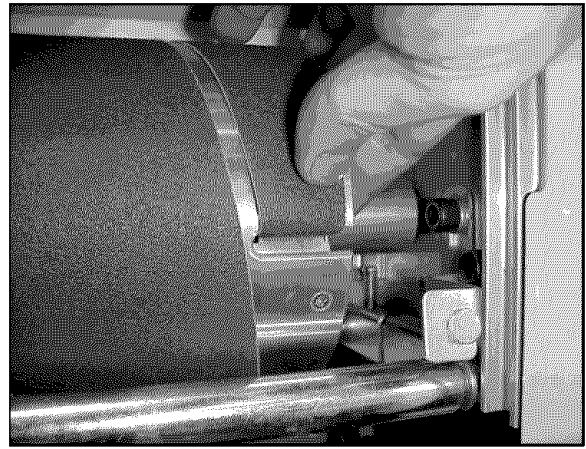

Figure 12

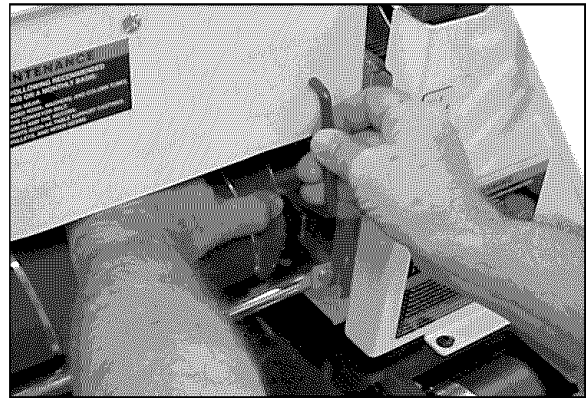

Figure 14



Figure 15

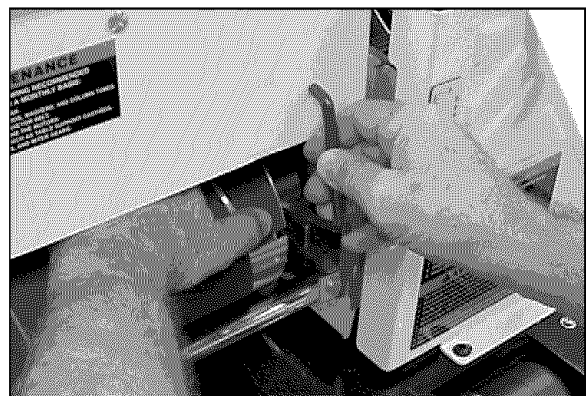

Figure 16

## Connecting Sander to a Dust Collector

Dust collection is necessary for all drum sanders. The Performax 10-20 is equipped with a 4" dust collection port in the back of the dust cover, and is designed to be used with a standard dust collector as shown in Figure 17.

JET offers a variety of Dust Collectors and Air Filtration Units that will work nicely with your new sander. Contact your local distributor for more information.

## Setting the Depth Gauge

The depth gauge indicates the distance from the bottom of the drum to the top of the conveyor.

1. Lower the drum, with the sandpaper installed, until it touches the conveyor.
2. Loosen the screw (Figure 18, Item B).
3. Adjust the pointer (Figure 18, Item C) to read zero and tighten the screw.

**Note:** depending on the desired accuracy, you may need to repeat this process when installing different sandpaper grits.

## Setting the Depth of Cut

Adjusting the Performax 10-20 for proper contact between the abrasive and the stock is the most important set-up procedure before operating the sander. It may take some experimentation to determine the proper depth of cut, given the variables of abrasive grit and types of wood. For best results, use scrap wood to practice sanding and to develop your skills and familiarity with the machine before doing any finish work.

A good rule of thumb when sanding with grits finer than 80 is lower the drum so that it contacts the work piece but can still be rotated by hand. When using grits coarser than 80 grit, you can lower the drum slightly more. However, a combination of several variables will determine the proper depth of cut to use, including the following:

- Abrasive type and grit size.
- Width of the piece being sanded.
- Hardness of the piece being sanded.
- Feed rate of the piece being sanded.

## Establishing the Proper Drum Height

To establish the proper drum height, place the board to be sanded under the drum and lower the drum until it just touches the board. **Note:** The sanding drum should still rotate by hand. Without changing the drum height, finish feeding the stock under the sander. Start the sanding drum and sand the board at that same position.

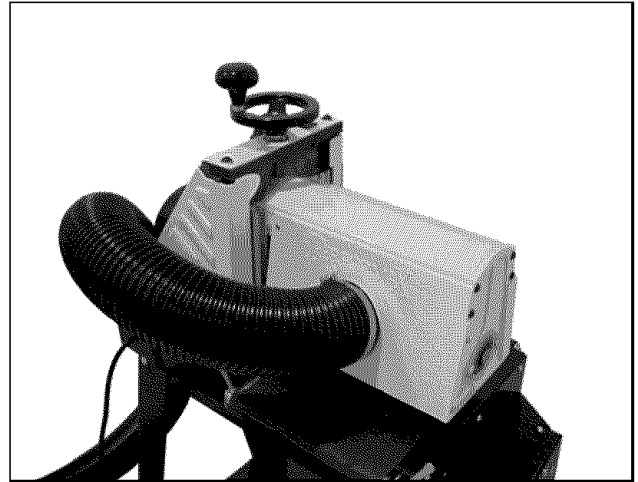

Figure 17

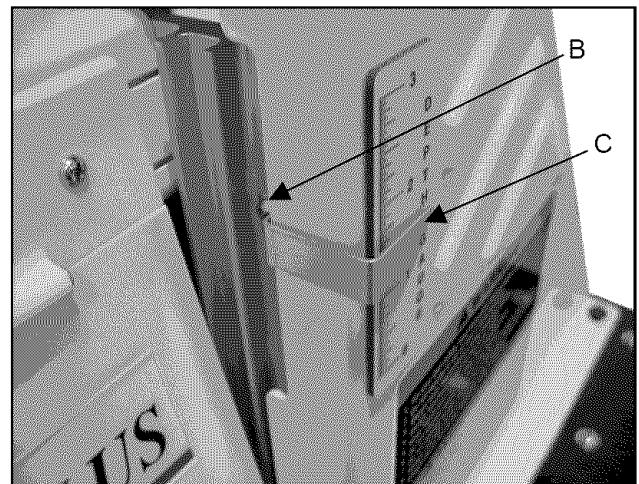

Figure 18

## Abrasives

The abrasive material you choose will have a substantial effect on the performance of your sander. Variations in paper type, weight, coating and durability all contribute to achieving your desired finish. For the best sanding results, Performax offers premium abrasives that have been tested and certified for lowest overall cost and maximum performance. Genuine Performax abrasives are available in pre-cut "Ready-to-Wrap" lengths or in the convenient pre-marked "Ready-to-Cut" box.

### Selecting Drum Abrasives

To achieve maximum sanding results, it is important to select the proper grit of abrasive for the type of sanding being performed. As with any sanding operation, first begin sanding with a coarser grit, depending on the roughness of the stock, or the amount of stock to be removed. Then progressively work toward finer grits. The chart below shows the general uses for the various grits. Performax offers strip rolls in the nine different abrasive grits shown.

Grit	Common Application
24 Grit	Abrasive planing, surfacing rough-sawn boards, maximum stock removal, glue removal.
36 Grit	Abrasive planing, surfacing rough sawn boards, maximum stock removal, glue removal.
60 Grit	Surfacing and dimensioning boards, truing warped boards
80 Grit	Surfacing, light dimensioning, removing planer ripples.
100 Grit	Light surfacing, removing light planer ripples.
120 Grit	Light surfacing, minimal stock removal.
150 Grit	Finish sanding, minimal stock removal.
180 Grit	Finish sanding only, not for stock removal.
220 Grit	Finish sanding only, not for stock removal.

### Selecting Abrasive Grits

The amount of stock to be removed is a major consideration when choosing the grit grade to start with. Grits of 24, 36, 50, 60 and 80 are primarily designed for stock removal. Grits of 24 and 36 will remove the most material in one

pass, whether you are doing abrasive planing, cleaning up glued panels or flattening stock. Grits from 100 through 220 are primarily finishing grits designed to remove the scratch pattern from the previous grit used. For best results, never skip more than one grit grade when progressing through a sanding sequence.

For fine work, such as furniture, try not to skip any grit grades during the sanding process. In general, premium quality abrasives such as genuine Performax abrasives will produce a better finish with a less noticeable scratch pattern. **Note:** Grits that are too fine can sometimes burnish the wood and leave a glossy surface that will not accept stains evenly. This will vary by the type of wood. Oak, for example, is susceptible to burnishing because of its open pores.

### Cleaning Abrasive Strips

A sandpaper cleaning stick may be used to remove deposits and help extend sandpaper life. To use, operate the sanding drum with the dust cover open.



For your own safety, always wear eye protection while performing sandpaper cleaning, and take all precautions to avoid any contact of hands or clothing with uncovered drums. Hold the cleaning stick against the rotating drum and move it along the drum surface. It is a good idea to use a shop brush or air nozzle to remove any cleaning stick crumbs from the drums before resuming sanding operations.

Cloth-backed abrasives can be cleaned by soaking in paint thinner or mineral spirits for 20 minutes to one hour. Then use a nylon brush to remove any buildup.

### Stretching Abrasive Life

Abrasive life can also be increased by removing the abrasive strip from the drum and reversing it. To do this, remove the strip and use what was the trailing end as the starting end on the left (outboard) side of the drum. Reversing the strip will provide a fresh set of cutting edges on the drum.



## Performax 10-20 Abrasives

“Ready-to-Wrap” 24-220 Grit contains six pre-cut wraps.

### Ready-to-Wrap

60-1024 .....	24 Grit	60-1120 .....	120 Grit
60-1036 .....	36 Grit	60-1150 .....	150 Grit
60-1060 .....	60 Grit	60-1180 .....	180 Grit
60-1080 .....	80 Grit	60-1000 .....	220 Grit
60-1100 .....	100 Grit		

### Ready-to-Cut (Aluminum oxide)

60-9036 .....	36 Grit	60-9120 .....	120 Grit
60-9060 .....	60 Grit	60-9150 .....	150 Grit
60-9080 .....	80 Grit	60-9180 .....	180 Grit
60-9100 .....	100 Grit	60-9220 .....	220 Grit

### Ready-to-Cut “Blue” (longer life)

60-8024 .....	24 Grit	60-8080 .....	80 Grit
60-8036 .....	36 Grit	60-8100 .....	100 Grit
60-8050 .....	50 Grit	60-8120 .....	120 Grit
60-8060 .....	60 Grit		

## Stock Feeding Angle

The optimum stock feeding angle, when sanding, is at a 60-degree angle. However, even a slight stock feeding angle will provide more effective stock removal, less loading of abrasives, longer abrasive life, potentially faster feed rates and reduced motor loads.

When finish sanding, the work piece should be fed through in line with the grain on the final one or two passes for the optimum finish.

## Multiple-Piece Sanding Runs

When abrasive planing (or thickness sanding) a run of similar pieces that you want to have the same thickness, it is best to sand all the pieces at the same time. This way you will be able to determine the thickness of the thinnest piece and process all pieces to that same thickness. Be aware that the sander will remove cups and crowns in the work piece; consider this when measuring the processing stock to the same thickness.

## Edge Sanding

When edge sanding, the Performax sander will mimic the opposite edge of the stock which is lying on the conveyor belt. Because of this, it is important for the stock edge to have been ripped at the proper angle to the face before the sanding process. When edge sanding stock that is less than 3/4” wide, or more than 2” high, it is

good procedure to stack and clamp several pieces together to prevent them from slipping, or tipping.

## Sanding Imperfect Stock

When sanding stock with a cup or crown, place the crown up. This will stabilize the stock to help prevent tipping or rocking during sanding. (After the crown has been removed and the top is flat, turn the stock over and sand the opposite side.) To avoid personal injury, take special care when sanding stock that is twisted, bowed or otherwise varies in thickness from end to end. If possible, support such stock as it is being sanded to keep it from slipping, or tipping. Use extra roller stands, help from another person, or hand pressure on the stock to minimize potentially hazardous situations.

## Face Frames and Raised Panel Doors

It is very important to have the proper abrasive contact when doing this type of sanding. If the sander is set to take an excessive depth of cut, the result can be a gouge, or dip as the drum goes from sanding the rails at full width to sanding just a few inches of width on the stiles. To prevent this problem, make sure that when using abrasives finer than 80 grit, the drum is in contact with the wood but can still be spun by hand.

## Monthly Maintenance

For best results, perform the following recommended maintenance procedures on a monthly basis:

- Lubricate the conveyor bushings and check for wear.
- Lubricate all moving parts, such as threaded rods, washers and bushings.
- Clean the sawdust from the conveyor belt and sanding drum.
- Blow the dust from the motors and switches. Blow the dust from the inside of the sanding drum to prevent vibration. Be careful not to disturb the drum balancing weights.
- Check all the setscrews for tightness on parts such as bearings, the conveyor and couplings.

## Conveyor Belt Replacement

To replace the conveyor belt:

1. Disconnect the machine from the power source.
2. Raise the drum to its highest position using the handwheel (Figure 19, Item A).
3. Remove the belt tension by loosening both take-up nuts (Figure 19, Item B).
4. Unscrew the three screws (Figure 19, Item C) that attach the conveyor to the bracket.
5. Unbolt the two hex head bolts (Figure 19, Item D) that hold the bracket to the bench or stand.
6. Slide the conveyor belt off the conveyor and replace it with a new belt.
7. Reverse the procedure for installation.

## Tension Roller Alignment

1. Remove the abrasive strip (Figure 20 Item E) from the drum.
2. Loosen the two bearing hex nuts (Figure 20, Item F) on the outboard side of the drum and two cap screws on the inboard side (Figure 20, Item G).
3. This will allow the tension rollers to drop to their lowest position.
4. Lower the sanding drum so that it just touches the conveyor bed.
5. Turn the drum height handle one complete revolution to raise the drum.
6. Retighten the bearing hex nuts and the cap screws.

## Tension Roller Pressure Adjustment

You can also adjust the spring-loaded screws (Figure 20, Item H) found on the pressure roller brackets, to increase or decrease roller pressure. If you are getting snipe marks at the leading end of the board adjust the outfeed roller pressure. If the snipe marks occur on the trailing end of the board, adjust the infeed roller pressure.

## Drum Height Control Adjustment

If the height control mechanism does not operate easily or smoothly, or there is excessive vertical movement of the drum carriage, perform the following adjustments.

1. To reduce the handwheel backlash, tighten the locknut on the height adjustment screw (Figure 21, Item J).
2. Thoroughly lubricate all mating surfaces and height adjustment screw (Figure 21, Item K).

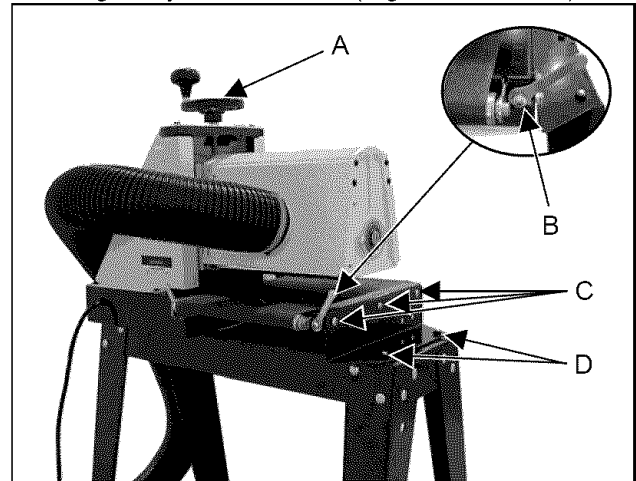

Figure 19

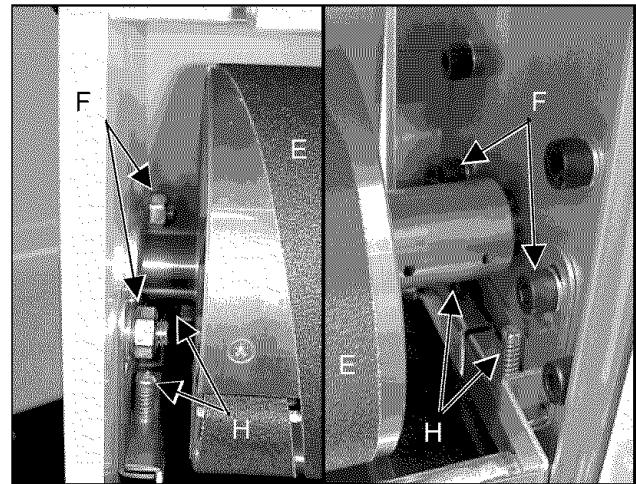

Figure 20

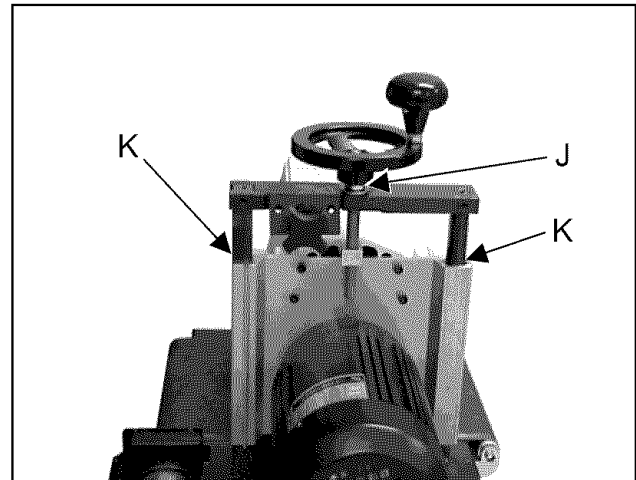

Figure 21

## Troubleshooting Guide

Problem	Possible Cause	Solution
Conveyor belt does not move.	Shaft coupler is not attached.	Attach the shaft coupler.
Conveyor rollers run intermittently.	Shaft coupling is loose.	Align the shaft flats of the gear motor and the drive roller and tighten the shaft-coupling setscrews.
Abrasive strip comes off drum.	<ol style="list-style-type: none"> <li>Slack in abrasive strip on drum.</li> <li>Abrasive improperly wrapped.</li> </ol>	<ol style="list-style-type: none"> <li>Remove the slack in the strip.</li> <li>Read the section on wrapping abrasive strips.</li> </ol>
Abrasive strip is loose.	<ol style="list-style-type: none"> <li>Strip caught on inside edge of slot, or on inboard side of drum.</li> <li>Strip not cut properly.</li> </ol>	<ol style="list-style-type: none"> <li>Re-adjust the strip end in the slot and/or trim the abrasive edge.</li> <li>Re-cut and re-install the abrasive strip.</li> </ol>
Abrasive loads up prematurely.	<ol style="list-style-type: none"> <li>Excessive depth of cut.</li> <li>Excessive feed rate.</li> <li>Inadequate dust collection.</li> <li>Inadequate abrasive.</li> </ol>	<ol style="list-style-type: none"> <li>Reduce the depth of cut.</li> <li>Use a slower feed rate.</li> <li>Increase airflow at the dust ports.</li> <li>Use an open-coat abrasive.</li> </ol>
Line or groove in stock.	<ol style="list-style-type: none"> <li>Inconsistent feed rate.</li> </ol>	<ol style="list-style-type: none"> <li>Do not stop or change the feed rate.</li> </ol>
Wood burns.	<ol style="list-style-type: none"> <li>Abrasive strip is overlapped.</li> <li>Excessive depth of cut.</li> <li>Excessive depth of cut for fine grit.</li> <li>Feed rate is too slow.</li> <li>Abrasive is loaded.</li> <li>Worn abrasives.</li> </ol>	<ol style="list-style-type: none"> <li>Re-wrap the abrasive strip.</li> <li>Reduce the depth of cut.</li> <li>Use a coarser grit or reduce the depth of cut.</li> <li>Increase the feed rate.</li> <li>Clean the abrasives.</li> <li>Replace the abrasives.</li> </ol>
Board slips on conveyor belt.	<ol style="list-style-type: none"> <li>Tension rollers are too high.</li> <li>Excessive feed rate.</li> <li>Dirty or worn conveyor belt.</li> </ol>	<ol style="list-style-type: none"> <li>Lower the tension rollers.</li> <li>Reduce the feed rate.</li> <li>Replace the conveyor belt.</li> </ol>
Sander motor slows or stalls	<ol style="list-style-type: none"> <li>Improper conveyor belt tension.</li> <li>Excessive depth of cut.</li> <li>Excessive feed rate.</li> </ol>	<ol style="list-style-type: none"> <li>Adjust the belt tension.</li> <li>Reduce the depth of cut.</li> <li>Reduce the feed rate.</li> </ol>
Rippled sanded surface A. Non-uniformly spaced ripples.  B. Uniformly spaced ripples.	<p>A. Uneven feed rate.</p> <p>B. Conveyor bed flexing or vibration.</p>	<p>A1. Conveyor belt slipping, see above.</p> <p>A2. Board slips on conveyor, see above.</p> <p>A3. Power feed gear motor stalls, see above.</p> <p>B1. Reduce the depth of cut.</p> <p>B2. Reduce the feed rate.</p> <p>B3. Check for loose bolts, shaft-coupling setscrews or out of balance drum.</p>
Gouging of the wood.	<ol style="list-style-type: none"> <li>Inconsistent feed rate.</li> <li>Stock slipping on conveyor.</li> <li>Work piece not properly supported.</li> </ol>	<ol style="list-style-type: none"> <li>Maintain constant feed rate (by hand).</li> <li>Excessive depth of cut (PowerFeed) or inadequate hold down pressure.</li> <li>Add work supports for long work pieces.</li> </ol>
Snipes	<ol style="list-style-type: none"> <li>Improper tension on rollers</li> </ol>	<ol style="list-style-type: none"> <li>See tension roller adjustment.</li> </ol>
Motor overload protector trips or shop wiring breaker trips.	<ol style="list-style-type: none"> <li>Excessive load on sanding drum and motor.</li> <li>Too many tools on circuit.</li> <li>Excessive length or inadequate size extension cord.</li> </ol>	<ol style="list-style-type: none"> <li>Allow motor to cool and reset overload button.</li> <li>Have a certified electrician correct the shop-wiring problem.</li> <li>Use a shorter, heavier gauge extension cord.</li> </ol>



Parts List for the 10-20 PLUS Sander				
Item No.	Part No.	Description	Size	Qty
1	1020-101	Handwheel, Height Adjustment		1
2	1020-102	Socket Head Button Screw	5/16-18UNCx3/4	2
3	TS-0680031	Flat Washer	5/16	8
4	1020-104	Main Support		1
5	1020-105	Lock Nut	1/2-20UNF	1
6	TS-0680061	Flat Washer	1/2	1
7	1020-107	Nylon Washer		1
8	1020-108	Washer, Oilite		1
9	TS-0267051	Set Screw	1/4-20UNCx1/2	2
10	1020-110	Bracket, Drum Height Control		1
11	1020-111	Height Adjusting Screw		1
12	1020-112	Bushing, Oilite		2
13	1020-113	Slide Plate, Motor Mount		1
14	1020-114	Arm		1
15	TS-081B03	Pan Head Machine Screw	#8-32UNCx1/2	7
16	1020-116	Dust Cover		1
17	1020-117	Plate, Outboard		1
18	1020-118	Hex Socket Round Head Screw	1/4-20UNCx3/4	4
19	TS-0720071	Lock Washer	1/4	4
20	50-3089	Bearing Assembly, Drum		1
21	TS-0152011	Bolt, Carriage Head	5/16-18UNCx1	2
22	TS-0561021	Hex Nut	5/16-18UNC	2
23	60-0310-P	Conveyor Belt		1
24	20-0778	Retaining Ring	STW25	1
25	1020-125	Drum		1
26	1020-126	Main Coupler		1
27	1020-127	Socket Head Cap Screw	#8-32UNCx3/8	2
28	TS-0208041	Socket Head Cap Screw	5/16-18UNCx3/4	4
29	TS-0720081	Lock Washer	5/16	6
30	10-4008-16	Screw, Fillister Head-Phillip	#8-32UNCx1	4
31	20-3211	Spring, Tension Rollers		4
32	40-0304	Bracket, Tension Rollers		1
33	40-0308-01	Bracket, Right Tension Roller Suspension		2
34	40-0308-02	Bracket, Left Tension Roller Suspension		2
35	80-1060	Pad, Bracket-Tension Roller		2
36	1020-136	Roller, Tension		2
37	TS-0208021	Socket Head Cap Screw	5/16-18UNCx1/2	2
38	1020-138	Motor Cord		1
39	1020-139	Bracket, Inboard Tension Roller		1
40	1020-140	Rod, Side Plate		1
41	1020-141	Rod, Square-Slide Plate		1
42	1020-142	Conveyor adjusting screw		2
43	1020-143	Bracket, Right Take-Up		1
44	50-3105	Bushing, Oilite	...	7
45	1020-145	Driven Roller		1
46	1020-146	Bracket, Left Take-Up		1
47	TS-0733041	Lock Washer, External Tooth	1/4	4
48	TS-0561011	Hex Nut	1/4-20UNC	6
49	TS-0813021	Screw	1/4-20UNCx3/8	3
50	1020-150	Foot Plate		1
51	1020-151	Drive Roller Support		1
52	1020-152	Drive Roller		1

Parts List for the 10-20 PLUS Sander				
Item No.	Part No.	Description	Size	Qty
53	10-4010-04	Set Screw	#10-32UNFx1/4	1
54	1020-154	Guide Plate		1
55	10-4010-08	Socket Head Cap Screw	#10-32UNFx1/2	4
56	3237359	Conveyer Gear Motor		1
57	1020-157	Cover, Base-Control Housing		1
58	72-2004	Switch, On/Off-Drum		1
59	1020-159	Overload		1
60	1020-160	Pan Head Machine Screw	#10-32UNFx1/2	5
61	12-9001	Lock Nut	#6-32UNC	2
62	72-6101	Strain Relief, DC-Motor Cord	6N-4	1
63	1020-163	Base Assembly		1
64	73-1255	Controller, Conveyer-Variable Speed		1
65	80-3137	Knob, Dust Cover		1
66	1020-166	Dust Hood, Door		1
67	20-0775	Hinge Pin		2
68	1020-168	Dust Hood, Hinge		1
69	1020-169	Needle, Depth Gauge		1
70	1020-170	Round Head Machine Screw	#10-24UNCx3/8	1
71	20-0762-02	Key	3/16SQx3/4"	2
72	1020-172	Main Drum Motor		1
73	1020-173	Spring		1
74	1020-174	Adjustment Bracket		1
75	1020-175	Socket Head Button Screw	5/16-24UNFx1/2	4
76	1020-176	Power Cord		1
77	1020-177	Strain Relief, Power Cord and Motor Cord	6N3-4	2
78	94-1670	Label, Depth Gauge		1
79	1020-179	Socket Head Button Screw	5/16-18UNCx1/2	2
80	21-1173	Fastener, Abrasive-Outboard		1
81	1020-181	Knob, Adjusting		1
82	TS-0207041	Socket Head Cap Screw	1/4-20UNCx3/4	4
83	1020-183	Label, Height-Direction		1
84	1020-184	Set Screw	1/4-20UNCx1/4	2
85	80-3131	Knob, 2 pc Swivel Handle		1
86	40-0260	Wrench		2
88	1020-188	Shoulder Screw		2
89	TS-0733061	Lock Washer, External Tooth	3/8	2
90	10-4009-06	Flat Head-Machine Screw	#6-32UNCx3/8	2
91	1020-191	Strain Relief	6P3-4	1
92	21-1172	Fastener, Abrasive-Inboard		1
93	TS-0680042	Flat Washer	3/8	6
94	1020-194	Machine Screw	1/4-20UNCx5/8	1
95	TS-0680011	Flat Washer	3/16	4
96	1020-196	Hex Head Screw	3/8-16UNCx5/8	4

# Wiring Diagram

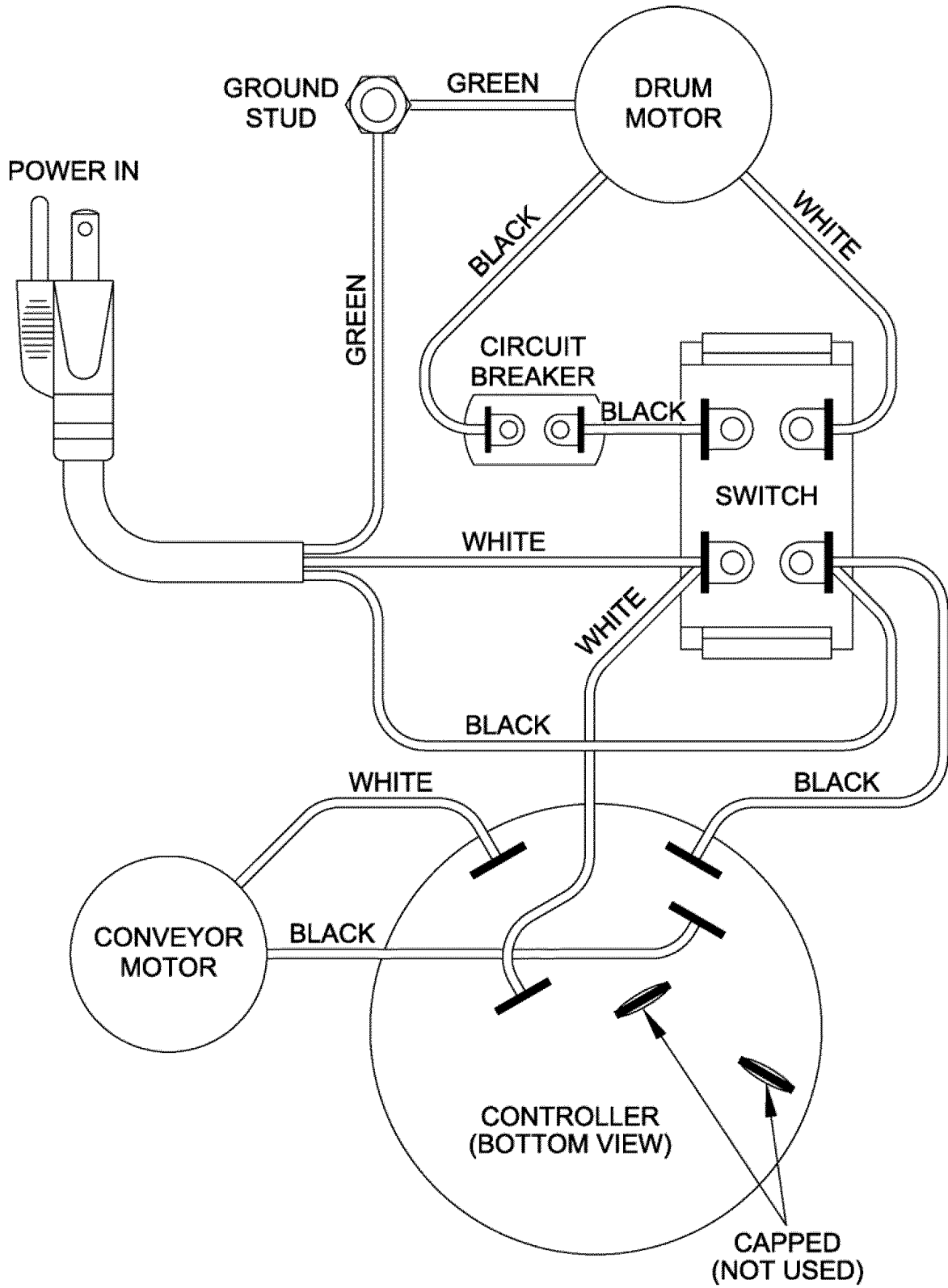

**PERFORMAX<sup>®</sup>**

**WMH Tool Group**

2420 Vantage Drive

Elgin, Illinois 60123

Phone: 800-274-6848

[www.wmhtoolgroup.com](http://www.wmhtoolgroup.com).