



LCD Digital Color TV

Operating Instructions

BRAVIA

KDL-V32XBR2

Owner's Record

The model and serial numbers are located at the rear of the TV. Record these numbers in the spaces provided below. Refer to them whenever you call upon your Sony dealer regarding this product.

Model No. _____

Serial No. _____

For Your Convenience

Please contact Sony directly if you:

- Have questions on the use of your television after reading your manual
- Experience difficulty operating your television

Contact Sony Customer Support at:

<http://www.sony.com/tvsupport>

or to speak with a support representative:

United States

1-800-222-SONY (7669)

8:00 AM – 10:00 PM (EST) Mon–Fri

10:30 AM – 7:15 PM (EST) Sat–Sun

Canada

1-877-899-SONY (7669)

8:00 AM – 6:00 PM (Eastern)

8:00 AM – 5:00 PM (Western)

Sony will work to resolve your questions more quickly than your retailer or place of purchase.

Please Do Not Return the Product to the Store

WARNING

To reduce the risk of fire or electric shock, do not expose this apparatus to rain or moisture.



This symbol is intended to alert the user to the presence of uninsulated "dangerous voltage" within the product's enclosure that may be of sufficient magnitude to constitute a risk of electric shock to persons.



This symbol is intended to alert the user to the presence of important operating and maintenance (servicing) instructions in the literature accompanying the appliance.

The apparatus shall not be exposed to dripping or splashing and no objects filled with liquids, such as vases, shall be placed on the apparatus.

CAUTION

To prevent electric shock, do not use this polarized AC plug with an extension cord, receptacle or other outlet unless the blades can be fully inserted to prevent blade exposure.

Note on Caption Vision

This TV provides display of TV closed captioning in accordance with §15.119 of the FCC rules.

Declaration of Conformity

Trade Name: SONY
Model: KDL-V32XBR2
Responsible Party: Sony Electronics Inc.
Address: 16530 Via Esprillo
San Diego, CA 92127 U.S.A.
Telephone Number: 858-942-2230

This device complies with part 15 of the FCC rules. Operation is subject to the following two conditions: (1) This device may not cause harmful interference, and (2) this device must accept any interference received, including interference that may cause undesired operation.

NOTIFICATION

This equipment has been tested and found to comply with the limits for a Class B digital device, pursuant to Part 15 of the FCC Rules. These limits are designed to provide reasonable protection against harmful interference in a residential installation. This equipment generates, uses and can radiate radio frequency energy and, if not installed and used in accordance with the instructions, may cause harmful interference to radio communications. However, there is no guarantee that interference will not occur in a particular installation. If this equipment does cause harmful interference to radio or television reception, which can be determined by turning the equipment off and on, the user is encouraged to try to correct the interference by one or more of the following measures:

- Reorient or relocate the receiving antenna.
- Increase the separation between the equipment and receiver.
- Connect the equipment into an outlet on a circuit different from that to which the receiver is connected.
- Consult the dealer or an experienced radio/TV technician for help.

Pursuant to FCC regulations, you are cautioned that any changes or modifications not expressly approved in this manual could void your authority to operate this equipment.

For Customers in Canada

This Class B digital apparatus complies with Canadian ICES-003.

Safety

- Operate the TV only on 120-240 V AC.
- Use the AC power cord specified by Sony and suitable for the voltage where you use it.
- The plug is designed, for safety purposes, to fit into the wall outlet only one way. If you are unable to insert the plug fully into the outlet, contact your dealer.
- If any liquid or solid object should fall inside the cabinet, unplug the TV immediately and have it checked by qualified service personnel before operating it further.
- If you will not be using the TV for several days, disconnect the power by pulling the plug itself. Never pull on the cord.
- For details concerning safety precautions, see "Important Safety Instructions" on page 4.

Installing

- The TV should be installed near an easily accessible power outlet.
- To prevent internal heat buildup, do not block the ventilation openings.

- Do not install the TV in a hot or humid place, or in a place subject to excessive dust or mechanical vibration.
- Avoid operating the TV at temperatures below 41°F (5°C).
- If the TV is transported directly from a cold to a warm location, or if the room temperature changes suddenly, the picture may be blurred or show poor color due to moisture condensation. In this case, please wait a few hours to let the moisture evaporate before turning on the TV.
- To obtain the best picture, do not expose the screen to direct illumination or direct sunlight. It is recommended to use spot lighting directed down from the ceiling or to cover the windows that face the screen with opaque drapery. It is desirable to install the TV in a room where the floor and walls are not of a reflective material.

CAUTION

Use the following Sony appliance(s) only with the following WALL-MOUNT BRACKET.

	Sony Appliance Model No.
	KDL-V32XBR2
Sony Wall-Mount Bracket Model No.	SU-WL31

Use with other WALL-MOUNT BRACKET may cause injury (see page 43).

To Customers

Sufficient expertise is required for installing the specified product. Be sure to subcontract the installation to Sony dealers or licensed contractors and pay adequate attention to safety during the installation.

For Customers in the United States

This product contains mercury. Disposal of this product may be regulated if sold in the United States. For disposal or recycling information, please contact your local authorities or the Electronics Industries Alliance (<http://www.eiae.org>).

Note

This television includes a QAM demodulator which should allow you to receive unscrambled digital cable television programming via subscription service to a cable service provider. Availability of digital cable television programming in your area depends on the type of programming and signal provided by your cable service provider.

(Continued)

Trademark Information

TruSurround XT, SRS and (●) symbol are trademarks of SRS Labs, Inc. TruSurround XT technology is incorporated under license from SRS Labs, Inc.

Manufactured under license from BBE Sound, Inc. Licensed by BBE Sound, Inc. under one or more of the following US patents: 5510752, 5736897. BBE and BBE symbol are registered trademarks of BBE Sound, Inc.

Macintosh is a trademark licensed to Apple Computer, Inc., registered in the U.S.A and other countries.



“BRAVIA” and BRAVIA are trademarks of Sony Corporation.

This TV incorporates High-Definition Multimedia Interface (HDMI™) technology. HDMI, the HDMI logo and High-Definition Multimedia Interface are trademarks or registered trademarks of HDMI Licensing LLC.

 Manufactured under license from Dolby Laboratories. “Dolby” and the double-D symbol are trademarks of Dolby Laboratories.



Important Safety Instructions

- 1) Read these instructions.
- 2) Keep these instructions.
- 3) Heed all warnings.
- 4) Follow all instructions.
- 5) Do not use this apparatus near water.
- 6) Clean only with dry cloth.
- 7) Do not block any ventilation openings. Install in accordance with the manufacturer's instructions.
- 8) Do not install near any heat sources such as radiators, heat registers, stoves, or other apparatus (including amplifiers) that produce heat. 
- 9) Do not defeat the safety purpose of the polarized or grounding-type plug. A polarized plug has two blades with one wider than the other. A grounding type plug has two blades and a third grounding prong. The wide blade or the third prong are provided for your safety. If the provided plug does not fit into your outlet, consult an electrician for replacement of the obsolete outlet.
- 10) Protect the power cord from being walked on or pinched particularly at plugs, convenience receptacles, and the point where they exit from the apparatus.
- 11) Only use attachments/accessories specified by the manufacturer.
- 12) Use only with the cart, stand, tripod, bracket, or table specified by the manufacturer, or sold with the apparatus. When a cart is used, use caution when moving the cart/apparatus combination to avoid injury from tip-over. 
- 13) Unplug this apparatus during lightning storms or when unused for long periods of time.
- 14) Refer all servicing to qualified service personnel. Servicing is required when the apparatus has been damaged in any way, such as power-supply cord or plug is damaged, liquid has been spilled or objects have fallen into the apparatus, the apparatus has been exposed to rain or moisture, does not operate normally, or has been dropped.

USE

For the TV with a three-wire grounding type AC power cord plug (Class 1 unit)

This TV must be connected to an AC power outlet with a protective earthing connection.

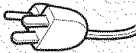

AC power cord

If you damage the AC power cord, it may result in a fire or an electric shock. If the AC power cord is damaged, stop using it and ask your dealer or Sony service center to exchange it.

- Do not place the TV where the power cord is subject to wear or abuse.
- Do not pinch, bend, or twist the cord excessively. The core lines may be bared and cut, and cause a short-circuit, resulting in a fire or an electric shock.
- Do not convert or damage the power cord.
- Do not allow anything to rest on or roll over the power cord.
- Do not pull the power cord.
- Do not move the TV with the power cord plugged in.
- Keep the power cord away from heat sources.
- Be sure to grasp the plug when disconnecting the power cord.

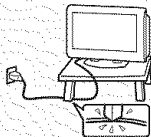

Wall outlet

Do not use a poor fitting outlet.

Insert the plug fully into the outlet. If it is loose, it may cause arcing and result in a fire.

Contact your electrician to have the outlet changed.

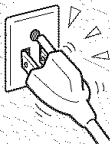

Wiring

For your safety, unplug the AC power cord when wiring cables.

Cable wiring

Take care not to catch your feet on the cables. It may damage the TV.

Electric shock

Do not touch the AC power cord or the TV with a wet hand. If you plug/unplug the AC power cord from the TV with a wet hand, it may cause electric shock.

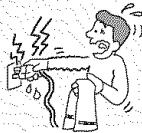

Lightning

For added protection for this TV during a lightning storm, or when it is left unattended and unused for long periods of time, unplug it from the wall outlet and disconnect the antenna. This will prevent damage to the TV due to lightning and power line surges.

ANTENNA

Outdoor Antenna Grounding

If an outdoor antenna is installed, follow the precautions below. An outdoor antenna system should not be located in the vicinity of overhead power lines or other electric light or power circuits, or where it can come in contact with such power lines or circuits.

WHEN INSTALLING AN OUTDOOR ANTENNA SYSTEM, EXTREME CARE SHOULD BE TAKEN TO KEEP FROM CONTACTING SUCH POWER LINES OR CIRCUITS AS CONTACT WITH THEM IS ALMOST INVARIABLY FATAL.

Be sure the antenna system is grounded so as to provide some protection against voltage surges and built-up static charges.

Section 810 of the National Electrical Code (NEC) in the USA and Section 54 of the Canadian Electrical Code in Canada provides information with respect to proper grounding of the mast and supporting structure, grounding of the lead-in wire to an antenna discharge unit, size of

grounding conductors, location of antenna discharge unit, connection to grounding electrodes, and requirements for the grounding electrode.

Antenna Grounding According to the National Electrical Code, ANSI/NFPA 70

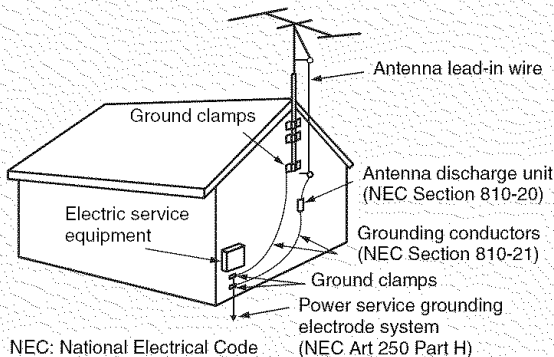

BATTERIES

- Do not dispose of batteries in a fire.
- Do not short circuit, disassemble or overheat the batteries.
- Danger of explosion if battery is incorrectly replaced. Replace only with the same or equivalent type.

Disposal of used batteries

To preserve our environment, dispose of used batteries according to your local laws or regulations.

CLEANING

- Clean the AC power plug regularly. If the plug is covered with dust and it picks up moisture, its insulation may deteriorate and result in a fire. Unplug the AC power plug and clean it regularly.
- Unplug the AC power cord when cleaning this TV. If not, it may result in electric shock.
- Clean the cabinet of the TV with a dry soft cloth. To remove dust from the screen, wipe it gently with a soft cloth. Stubborn stains may be removed with a cloth slightly dampened with a solution of mild soap and warm water. Never use strong solvents such as thinner or benzene for cleaning.
- If using a chemically pretreated cloth, please follow the instruction provided on the package.

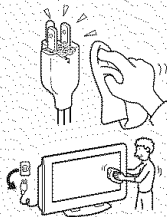

MAGNETIC INFLUENCE

This TV contains a strong magnet in the speaker unit that generates a magnetic field. Keep any items susceptible to magnetic fields away from the speaker.

SOUND

If a snapping or popping sound from the TV is continuous or frequent while the TV is operating, unplug the TV and consult your dealer or service technician. It is normal for some TVs to make occasional snapping or popping sounds, particularly when being turned on or off.

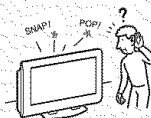

(Continued)

VENTILATION

The slots and openings in the TV are provided for necessary ventilation. To ensure reliable operation of the TV, and to protect it from overheating, these slots and openings must never be blocked or covered.

Unless proper ventilation is provided, the TV may gather dust and get dirty. For proper ventilation, observe the following:

- Do not install the TV face up or down or sideways.
- Do not install the TV turned over or upside down.
- Never cover the slots and openings with a cloth or other materials.

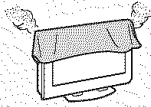

- Never block the slots and openings by placing the TV on a bed, sofa, rug or other similar surface.

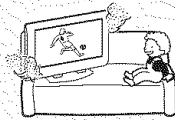

- Never place the TV in a confined space, such as a bookcase or built-in cabinet, unless proper ventilation is provided.

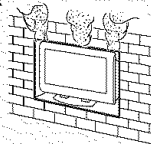

When installing the TV on a wall, allow this much space:

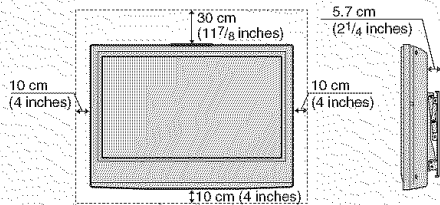

When installing the TV using a stand, allow this much space:

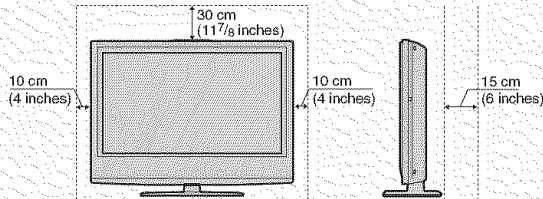

Never install the TV as follows:

Air circulation is blocked.

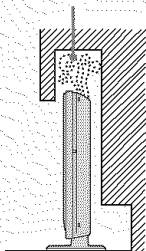

Air circulation is blocked.

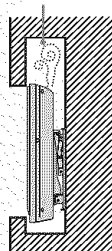

Objects and ventilation holes

Never push objects of any kind into the TV through the cabinet slots as they may touch dangerous voltage points or short out parts that could result in a fire or an electric shock. Never spill liquid of any kind on the TV.

Do not place any objects on the TV.

The TV shall not be exposed to dripping or splashing and no objects filled with liquids, such as vases, shall be placed on the TV.

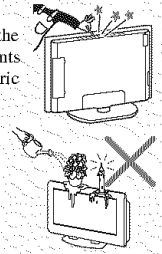

MOISTURE

Moisture and flammable objects

- Do not use power-line operated sets near water — for example, near a bathtub, washbowl, kitchen sink, or laundry tub, in a wet basement, or near a swimming pool, etc. It may result in a fire or an electric shock.
- Do not let this TV get wet. Never spill liquid of any kind on the TV. If any liquid or solid object does fall through, do not operate the TV. It may result in electric shock or damage to the TV. Have it checked immediately by qualified personnel.
- To prevent fire, keep flammable objects or open flame (e.g. candles) away from the TV.

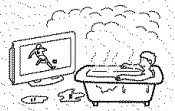

CARRYING THE TV

Carry the TV in the specified manner

Carrying the TV requires at least two people.

If you carry the TV in a manner other than that specified and without the specified number of persons, it may drop and serious injury may result.

- Carry the TV with the specified number of people.
- Carry the TV holding the upper and bottom frames of the TV as illustrated.
- Hold the TV securely when carrying it. As the glass surface of the TV has a special coating, be careful to avoid touching the glass surface as much as possible.
- When transporting, do not subject the TV to shocks or vibration, or excessive force.
- When lifting or moving the TV, be sure to hold the panel firmly as illustrated. Place your palm directly under the panel, from the rear of the TV.

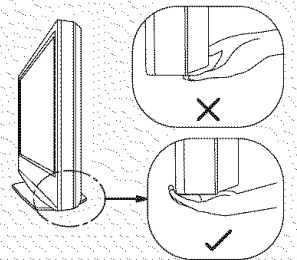
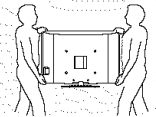

INSTALLATION

When installing or removing the TV, using the Wall-Mount Bracket, be sure to use qualified contractors. Wall mount installation requires the use of a Wall-Mount Bracket. If not properly secured during installation or removal from the Wall-Mount Bracket, the TV may fall and cause serious injury. Please use a qualified contractor when installing or removing.

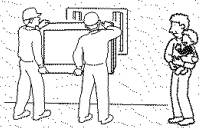

Placement for viewing

It is recommended to watch the TV at a distance of 3 - 7 times that of the screen height, and in moderate brightness. Watching the TV for too long or in a dark room may cause eye fatigue.

Optional wall mount

Observe the following when installing the TV using a wall-mount bracket. If the TV is not secured properly, it may fall and cause injury.

- Be sure to follow the operating instructions supplied with the wall-mount bracket when installing the TV.
- Be sure to attach the brackets supplied with the wall-mount bracket.
- Do not hang the TV from the ceiling. It may fall and cause serious injury.



Outdoor use

Do not install this TV outdoors. If the TV is exposed to rain, it may result in a fire or an electric shock. If the TV is exposed to direct sunlight, the TV may heat up and cause damage to the TV.

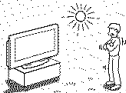

Vehicle

Do not install this TV in a vehicle.

Bumping of the vehicle may cause the TV to fall down and cause injury.



Ship and vessel

Do not install this TV in a ship or vessel. If the TV is exposed to seawater, it may cause a fire or damage the TV.

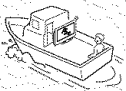

Corrosion

If you use this TV near the seashore, salt may corrode metal parts of the TV and cause internal damage or fire.

It may also shorten the life of the TV.

Oils

Do not install this TV in restaurants where oily vapors occur. Dust absorbing oil may enter and damage the TV.

Medical institution

Do not place this TV in a place where medical equipment is in use.

It may cause a malfunction of medical instruments.

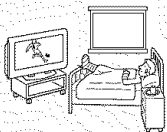

Preventing the TV from toppling over

Take measures to prevent the TV from toppling over and causing injury. To prevent the TV from toppling over, secure the TV to a wall or pillar.

Installing on a level surface

If you install the TV on an inclined surface, the TV may fall or drop and cause injury or damage.



Placing on a stable surface

If you place the TV on an unstable surface, the TV may fall and cause injury or damage.



Fall

Do not hang anything on the TV.

The TV may fall from the stand or wall-mount, causing damage or serious injury.



Attachments

Do not use attachments not recommended by the manufacturer, as they may cause hazards.

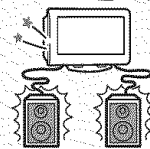

VOLUME ADJUSTMENT

- Adjust the volume so as not to trouble your neighbors. Sound carries very easily at night. Therefore, closing the windows or using headphones is suggested.
- When using headphones, adjust the volume so as to avoid excessive levels, as hearing damage may result.

LCD SCREEN

- Although the LCD screen is made with high-precision technology and has effective pixels of 99.99% or more, black dots or bright points of light (red, blue, or green) may appear constantly on the LCD screen. This is a structural property of the LCD panel and is not a malfunction.
- Do not expose the LCD screen surface to direct sun light. Doing so may damage the LCD panel.
- Do not push or scratch the LCD screen, or place objects on top of the TV. The image may be uneven or the LCD panel may be damaged.
- If the TV is used in a cold place, a smear may occur in the picture or the picture may become dark. This does not indicate a failure. These phenomenon improve as the temperature rises.
- Ghosting may occur when still pictures are displayed continuously. It should disappear after a few moments.
- The screen and cabinet get warm when the TV is in use. This is not a malfunction.
- Avoid spraying insect repellent with volatile material on the screen.
- Avoid prolonged contact with rubber or plastic made material.

Broken pieces

Do not throw anything at the TV.

The screen glass may break by the impact and cause serious injury.

Handling of broken glass and liquid crystal leakage

If the LCD panel gets damaged, crystalline liquid leakage may occur, or scattered broken glass may result. Do not touch broken glass or crystalline liquid (which is toxic), with bare hands as cuts or poisoning/skin irritation may occur. Also, do not let glass fragments or leaked crystalline liquid get into your eyes or mouth. Should either contact your eyes or mouth, rinse the contacted area thoroughly with water and consult your doctor.

(Continued)

SERVICING

Damage requiring service

If the surface of the TV cracks, do not touch the TV until you unplug the AC power cord.

Otherwise electric shock may result.

Servicing

Do not attempt to service the TV yourself since opening the cabinet may expose you to dangerous voltage or other hazards. Refer all servicing to qualified service personnel.

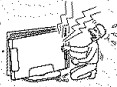

Replacement parts

When replacement parts are required, be sure the service technician certifies in writing that he/she has used replacement parts specified by the manufacturer that have the same characteristics as the original parts.

Unauthorized substitutions may result in a fire, an electric shock or other hazards.



Safety check

Upon completion of any service or repairs to the TV, ask the service technician to perform routine safety checks (as specified by the manufacturer) to determine that the TV is in safe operating condition, and to so certify.

Should the TV not be repairable, ask a qualified service technician to dispose of the TV.



DISPOSAL OF THE TV

- Do not dispose of the TV with general household waste.
- The LCD contains a small amount of liquid crystal. The fluorescent tube used in this display also contains mercury. Follow your local ordinances and regulations for disposal.

Contents

Getting Started

Welcome to the World of BRAVIA™	11
Connecting the TV	11
Cable System and/or VHF/UHF Antenna System	11
HD Cable Box/HD Satellite Box	12
Satellite Receiver and Cable/Antenna	13
VCR, Cable and Antenna	13
When Connecting to Optional Equipment	14
Installing the TV	16
Preventing the TV from Toppling Over	16
Bundling the Connecting Cables	17
Adjusting the Viewing Angle of the TV	17
Setting Up the Channel List - Initial Setup	18

Basic Operations

Remote Control	19
TV Controls	22

Using the Menu

Overview of MENU	23
Using the Picture Settings	26
Using the Sound Settings	28
Using the Screen Settings	29
Using the Setup Settings	31
Using the PC Settings	36
Using the Analog Setup Settings	37
Using the Digital Setup Settings	38

Other Information

Troubleshooting	41
Preparation for Wall Mounting Your TV	43
PC Input Signal Reference Chart	44
Specifications	45
Index	47

Welcome to the World of BRAVIA™

Thank you for purchasing this Sony LCD Digital Color Television. This manual is for model KDL-V32XBR2. The packing box contains accessories that are listed on page 45.

For optimum picture performance, your new BRAVIA TV is capable of receiving high definition programming through its integrated tuner. It is also capable of receiving HDTV content from a cable or satellite box via the video inputs (HDMI and Y/PB/PR component video; see page 15).

Connecting the TV

To display clear, crisp pictures, your TV must be connected properly. To properly connect your TV, follow the basic connections provided in this section. Advanced connection examples are provided in the separate Quick Setup Guide accompanied with your TV. The Quick Setup Guide provides a variety of optional equipment connection diagrams.

It is strongly recommended that you connect the antenna/cable input using the supplied 75-ohm coaxial cable to receive optimum picture quality. A 300-ohm twin lead cable can be easily affected by radio frequency, resulting in signal deterioration.

When the antenna/cable connection is done, you must perform an Initial Setup so your TV will create a list of channels you can view (see page 18). After you can receive and view programming you should select the proper Wide Mode setting to display the picture in your preferred aspect ratio. See "Changing the Wide Screen Mode" on pages 21 and 29.

Cable System and/or VHF/UHF Antenna System

Connecting a cable system or an external VHF/UHF antenna to the VHF/UHF input will allow you to enjoy high definition and standard definition digital programming (if available in your area) along with the standard definition analog programming.

 This TV is capable of receiving unscrambled digital programming for both cable (QAM and 8VSB) and external VHF/UHF antenna (ATSC).

Cable or VHF/UHF (or VHF only)

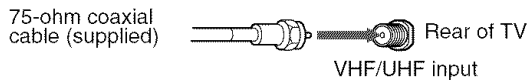

Cable and VHF/UHF (or VHF only)

If you want to watch both cable and antenna (over-the-air) programming, you will need to use an optional A-B RF Switch (not supplied) to switch between the cable and over-the air antenna programming, as shown.

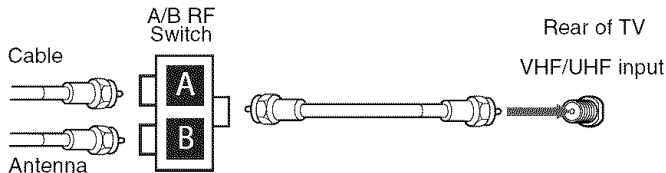

Be sure to set Cable setting option to Cable On or Cable Off in Setup settings for the type of input signal you choose (see page 34).

**HD Cable Box/
HD Satellite Box**

You can also enjoy high definition programming by subscribing to high definition cable service or high definition satellite service. For the best possible picture, connect these components to your TV via the HDMI or component video (with audio) input on the back of your TV.

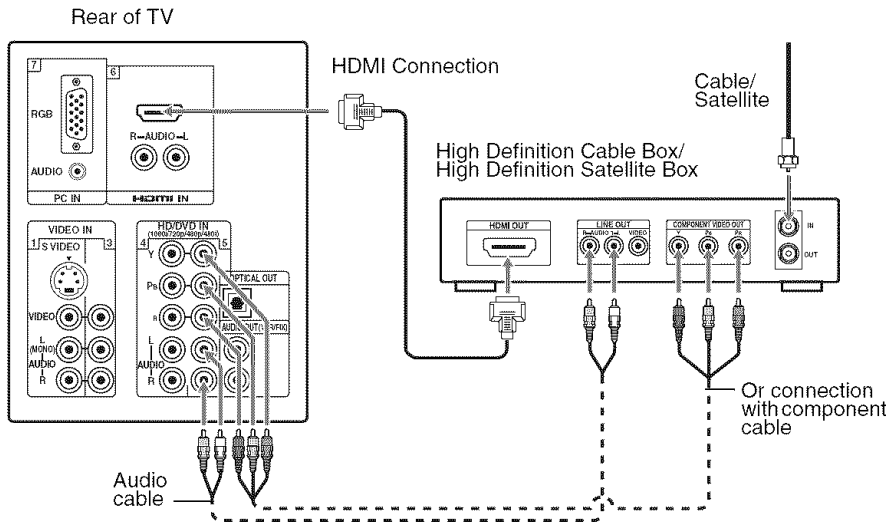

Component video (Y, PB, PR) or HDMI connection is necessary to view 480i, 480p, 720p and 1080i formats. Note that this TV displays all format types of picture in its native resolution of 1,366 dots x 768 lines.

Satellite Receiver and Cable/Antenna

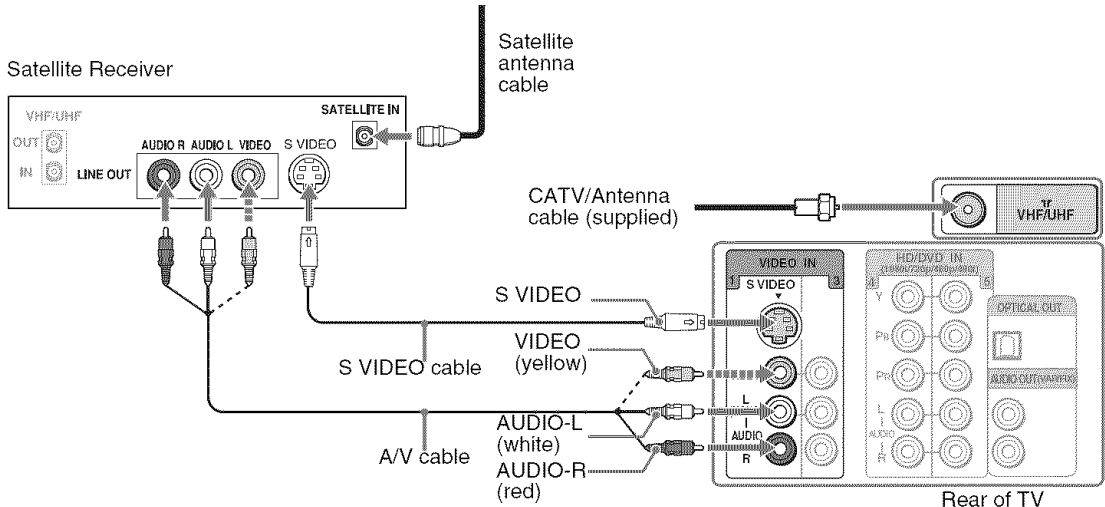

⚡ If your satellite receiver is not equipped with S VIDEO, use a VIDEO cable (yellow) instead of the S VIDEO cable.

⚡ Run the Initial Setup program, as described in "Setting Up the Channel List" on page 18 after completing your connections.

VCR, Cable and Antenna

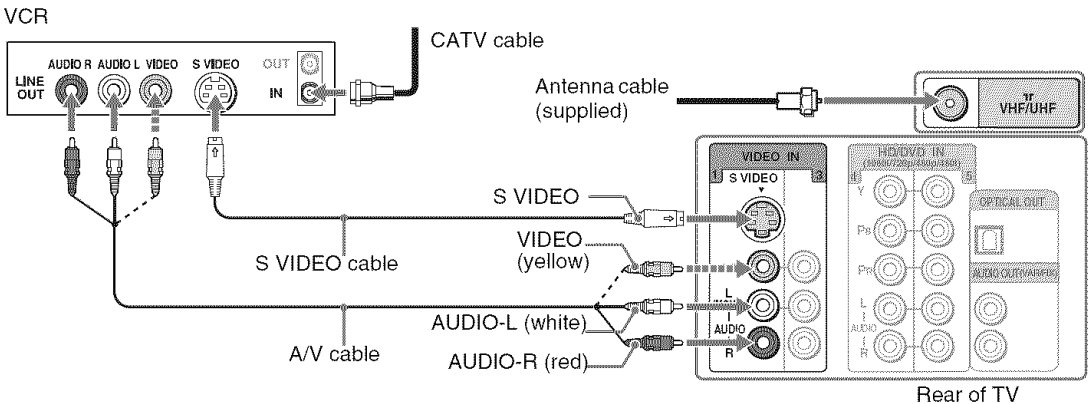

⚡ If your VCR is not equipped with S VIDEO, use a VIDEO cable (yellow) instead of the S VIDEO cable.

⚡ Run the Initial Setup program, as described in "Setting Up the Channel List" on page 18 after completing your connections.

When Connecting to Optional Equipment

Left side

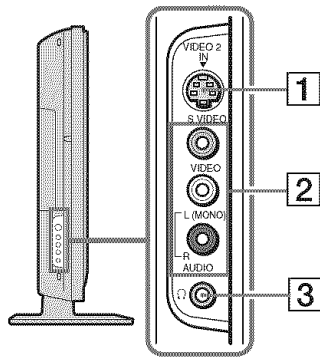

Rear

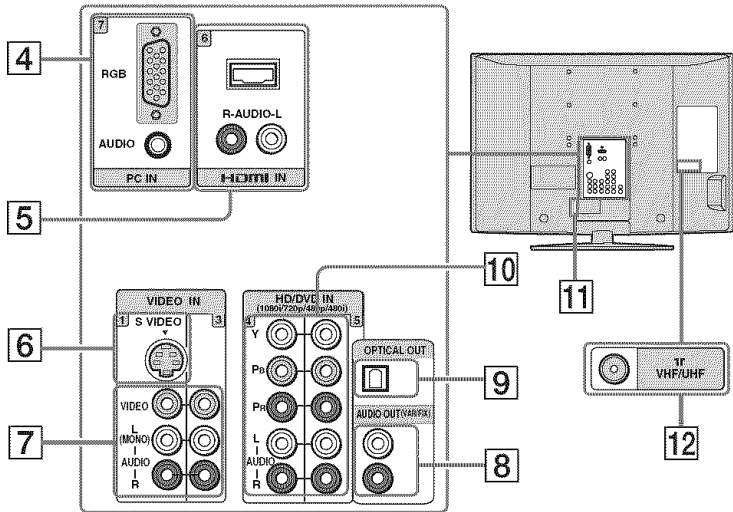

Item	Description
1	VIDEO 2 IN S VIDEO Connects to the S VIDEO output jack on your camcorder or other video equipment that has S VIDEO. Provides better picture quality than composite video (2). (See Auto YC on page 33.)
2	VIDEO 2 IN VIDEO/ L (MONO)- R AUDIO Connect to the composite video and audio output jacks on your camcorder or other video equipment such as video game equipment. ⚠ If you have mono equipment, connect its audio output jack to the TV's L (MONO) audio input jack.
3	Headphones jack Connects to your headphones. If your headphones do not match the jack, use a suitable plug adapter (not supplied). ⚠ While headphones are connected, the TV speakers turn off, and volume control affects headphone volume only. Sound Setting options, on page 28, have no effect while using headphones.
4	PC IN 7 (RGB/AUDIO) Connect to a personal computer's video output connector using HD15-HD15 cable (analog RGB, supplied). See "PC Input Signal Reference Chart" on page 44 for the signals that can be displayed. ⚠ For some Apple Macintosh computers, it may be necessary to use an adapter (not supplied). If this is the case, connect the adapter to the computer before connecting the HD15-HD15 cable. ⚠ If the picture is noisy, flickering or not clear, adjust the Phase and Pitch of the PC Settings see page 36.

Item	Description
5	<p>HDMI IN 6 HDMI/ R-AUDIO-L</p> <p>HDMI (High-Definition Multimedia Interface) provides an uncompressed, all-digital audio/video interface between this TV and any HDMI-equipped audio/video equipment, such as a set-top box, DVD player, and A/V receiver. HDMI supports enhanced, or high-definition video, plus digital audio.</p> <p>If the equipment has a DVI connector and not an HDMI connector, connect the DVI connector to the HDMI IN (with HDMI-to-DVI cable or adapter) connector, and connect the audio jacks to the AUDIO IN(L/R) jacks of HDMI IN. (DVI connector is for video signals only.)</p>



HDMI-to-DVI cable



HDMI-to-DVI adapter



Audio cable

 Do not connect a PC to the TV's HDMI input. Use the PC IN (RGB IN) input instead when connecting a PC.

6	<p>VIDEO IN 1 S VIDEO</p> <p>Connects to the S VIDEO output jack of your VCR or other video equipment that has S VIDEO. S VIDEO provides better picture quality than composite video (7).</p>
7	<p>VIDEO IN 1/3 VIDEO/ L(MONO)- AUDIO-R</p> <p>Connect to the composite video and audio output jacks on your A/V equipment such as a VCR or other video equipment. A third composite video and audio (VIDEO 2) input is located on the left side panel of the TV.</p>
8	<p>AUDIO OUT (VAR/FIX)</p> <p>Connect to the left and right audio input jacks of your audio or video equipment. You can use these outputs to listen to your TV's audio through your stereo system.</p>
9	<p>OPTICAL OUT (PCM/DOLBY* DIGITAL)</p> <p>Connects to the optical audio input of a digital audio equipment that is PCM/Dolby digital compatible. (OPTICAL OUT is only available for digital channels.)</p>
10	<p>HD/DVD IN 4/5 (1080i/720p/ 480p/480i)/ L-AUDIO-R</p> <p>Connect to your DVD player's or digital set-top box's component video (YPBPR) and audio (L/R) jacks. Component video provides better picture quality than the S VIDEO (6) or the composite video (7) connections.</p>
11	<p>AC IN</p> <p>Connects the supplied AC power cord.</p>
12	<p>VHF/UHF</p> <p>RF input that connects to your Cable or VHF/UHF antenna.</p>

* Manufactured under license from Dolby Laboratories. "Dolby" and the double-D symbol are trademarks of Dolby Laboratories.

 Component video (YPBPR) or HDMI connection is necessary to view 480i, 480p, 720p, and 1080i formats. Note that this TV displays all format types of picture in its native resolution of 1,366 dots × 768 lines.

Installing the TV

Preventing the TV from Toppling Over

Attaching the Support Belt

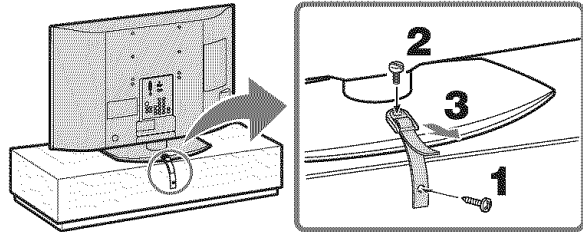

- 1** Screw the support belt (supplied) to the TV stand with a wood screw (supplied).
- 2** Attach the support belt to the stand with the securing screw (supplied) using a coin, etc.
- 3** Adjust the length by pulling the support belt towards you while holding the TV stand.

- ⚠ Be sure to take measures to prevent the TV from toppling over and causing injury.
- ⚠ The supplied wood screw may not be used depending on the type of TV stand. In this case, or when the securing strength is not enough, prepare commercial screws to fit to the TV stand. Use commercial screws of 3 to 4 mm (1/8 to 3/16 inches) diameter. Consult your dealer about the types of screw.

When Installing on a Wall

Be sure to use the specified Wall-Mount Bracket (see page 3) when installing the TV on a wall. Refer to the Instruction Guide supplied with the Wall-Mount Bracket (sold separately).

(See page 43 for Table-Top Stand removal.)

Bundling the Connecting Cables

You can bundle the connecting cables as illustrated below.

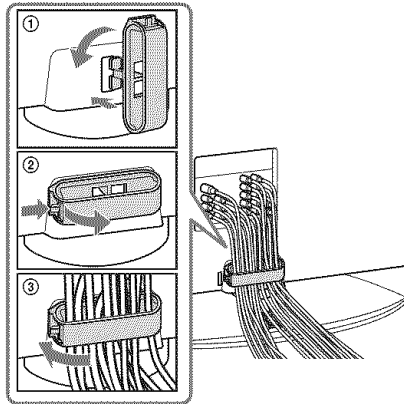



 Do not bundle the AC power cord with other connecting cables.

Adjusting the Viewing Angle of the TV

This TV can be adjusted within the angles shown below.

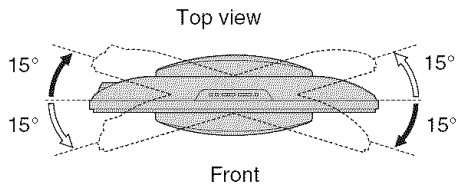
Adjust the angle left and right









 When adjusting the angle, hold the stand with one hand to avoid slipping or tipping the TV.

Setting Up the Channel List - Initial Setup

After you finish connecting your TV, you need to run Initial Setup, which automatically sets up available channels. The Initial Setup screen appears when you turn on your TV for the first time. If you do not want to set up the channels at this time, you can do it later by selecting the Auto Program option in the Analog and Digital Setup settings (see pages 37 and 38).

- 1 Press  to turn on the TV.
The Initial Setup screen appears.



- 2 Press  to highlight the on-screen display language. Then press .
The message “First please connect cable/antenna. Do you want to start Auto Program?” appears.
- 3 Press  to highlight “OK” then press .
The message “Auto Program” appears. Then the message “Continue programming digital channels?” appears. This may require 50+ minutes for completion.
- 4 Press  to highlight “OK” then press .

To run Auto Program again at a later time

- Use the Auto Program feature as described on pages 37 and 38.

To add individual digital channels

- Use the Digital Channels Add feature as described on page 38.

Basic Operations

Remote Control

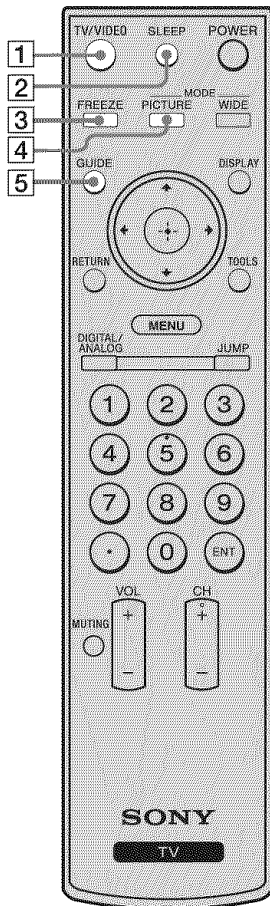

💡 The 5 and CH + buttons have a tactile dot. Use them as a reference when operating the TV.

Button	Description
1 TV/VIDEO	Press repeatedly to cycle through the video inputs. 🔍 See page 32 on setting up the video input labels, including the Skip function.
2 SLEEP	Press repeatedly until the TV displays the time in minutes (Off, 15, 30, 45, 60, 90 or 120) that you want the TV to remain on before shutting off. To cancel Sleep Timer, press SLEEP repeatedly until Sleep Off appears.
3 FREEZE	Press once to display a frozen image of the current program in a window. Press again to show only the frozen image. Press again to return to the program.
4 PICTURE	Press repeatedly to cycle through the available picture modes: Vivid, Standard, Custom. The picture modes can be also accessed in the Picture settings. For details, see “Using the Picture Settings” on page 26.
5 GUIDE (Digital channels only)	Press to display the Guide when you are watching digital channels (if it is available from the station).



Current program ————— Frozen picture

Move the sub screen with **▲ ▼ ◀ ▶**.

🔍 With Freeze function active, some functions are unavailable, such as MENU.

Using the Guide

The Guide allows you to select the channels from a channel list. The Guide also provides information about the current program being shown on each channel.



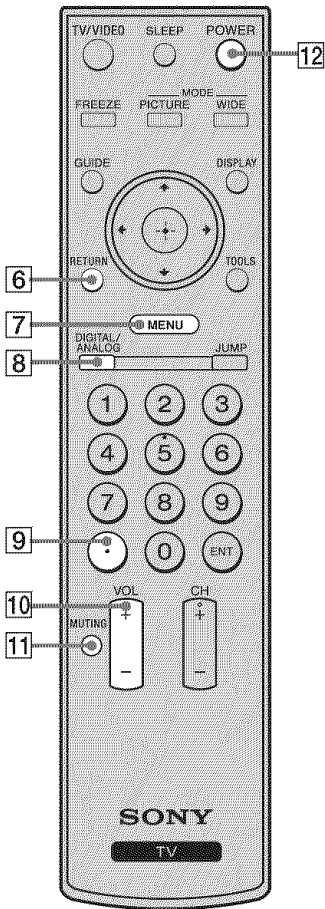

Button	Description
	Program information in the guide is provided by the broadcasters. As a result, it may sometimes include only the channel number, without a program title or description.
Using the Program Options Setting	
The Program Options setting allows you to customize the program settings on the currently tuned channel.	
Alternate Audio (When available)	Each program has a main video and audio stream (the video or audio that you see or hear when the channel is first tuned), and may have alternate streams. This option allows you to select from the alternate audio streams, when the broadcaster provides an alternate audio stream (for instance, the audio may contain a different language).
6 RETURN	Press to go back to the previous screen when displaying MENU items and settings.
7 MENU	Press to display the MENU with TV functions and settings. See "Overview of MENU" on page 23.
8 DIGITAL/ANALOG	Press to switch between analog and digital channels. To enjoy the digital features of this TV, press DIGITAL/ANALOG.
9	Use with 0-9 and ENT buttons to select digital channels. For example, to enter 2.1, press ②, , ① and ENT.
10 VOL +/-	Press to adjust the volume.
11 MUTING	Press to mute the sound. Press again or press VOL + to restore the sound.
12 POWER	Press to turn on and off the TV.

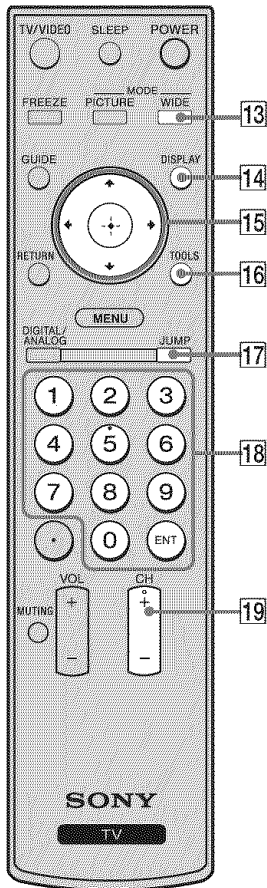

Button	Description										
13 WIDE	Press repeatedly to step through the Wide Mode settings: Wide Zoom, Normal, Full, Zoom. The Wide Mode settings can be also accessed in the Screen settings. See page 29.										
<p>Changing the Wide Screen Mode (see page 29 for details)</p> <table border="1"> <tr> <td> <p>4:3 Original source Standard definition source</p> </td> <td> <p>16:9 Original source High definition source</p> </td> </tr> <tr> <td> <p>Wide Zoom</p> </td> <td> <p>Wide Zoom</p> </td> </tr> <tr> <td> <p>Normal</p> </td> <td> <p>Normal</p> <p>This mode is not available</p> </td> </tr> <tr> <td> <p>Full</p> </td> <td> <p>Full</p> </td> </tr> <tr> <td> <p>Zoom</p> </td> <td> <p>Zoom</p> </td> </tr> </table> <p> When the TV receives a 720p or 1080i signal, Normal cannot be selected.</p>		<p>4:3 Original source Standard definition source</p>	<p>16:9 Original source High definition source</p>	<p>Wide Zoom</p>	<p>Wide Zoom</p>	<p>Normal</p>	<p>Normal</p> <p>This mode is not available</p>	<p>Full</p>	<p>Full</p>	<p>Zoom</p>	<p>Zoom</p>
<p>4:3 Original source Standard definition source</p>	<p>16:9 Original source High definition source</p>										
<p>Wide Zoom</p>	<p>Wide Zoom</p>										
<p>Normal</p>	<p>Normal</p> <p>This mode is not available</p>										
<p>Full</p>	<p>Full</p>										
<p>Zoom</p>	<p>Zoom</p>										
14 DISPLAY	Press once to display the current channel number, channel label, time and Wide Mode settings. The on screen display (OSD) will turn off after a few seconds or press again to immediately turn off the display.										
15	Press to move the on-screen cursor. Press to select/confirm an item.										
16 TOOLS	Press to display the Tools Menu that is associated with your current input: Analog TV, Digital TV, or External Inputs. (See page 26, 28, 31, 36 and 37.)										
17 JUMP	Press to jump back and forth between two channels. The TV alternates between the current channel and the last channel that was selected among the digital or analog channels. It will not cross over from digital to analog, or from analog to digital.										
18 0 - 9 ENT	Press 0 - 9 to select a channel; the channel changes after two seconds. Press ENT to change channels immediately.										
19 CH +/-	Press to scan through channels. To scan quickly through channels, press and hold down either +/-.										

Insert two size AA batteries (supplied) by matching the and on the batteries to the diagram inside the remote control's battery compartment.

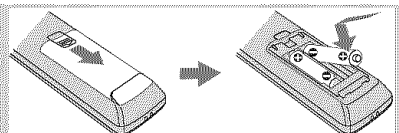

TV Controls

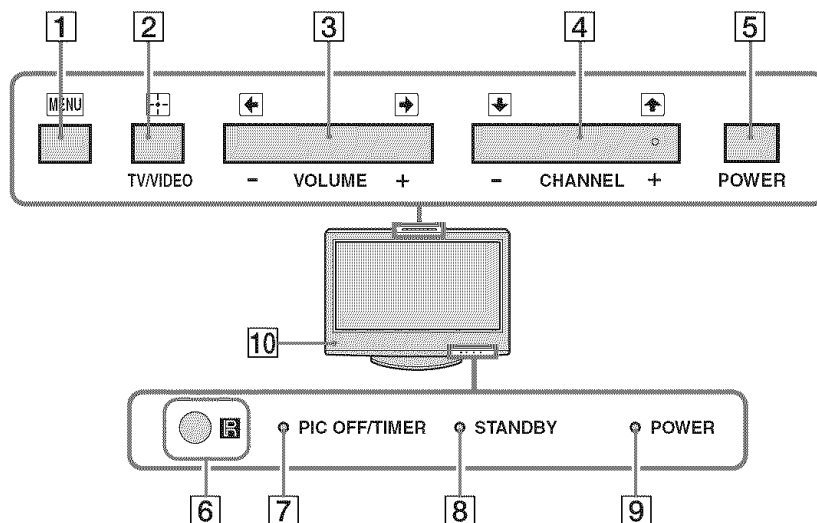

Item	Description
1	MENU Press to display MENU with TV functions and settings (see “Overview of MENU” on page 23).
2	+/- TV/VIDEO Press to cycle through the video inputs. If you set a certain input to Skip in Label Video Inputs, then the input will not appear. In the MENU screen, this button serves as confirming the selection or setting.
3	← → - VOLUME + Press to adjust the volume. In the MENU screen, these buttons serve as left/right buttons.
4	↓ ↑ - CHANNEL + Press to scan through channels. To scan quickly through channels, press and hold down either -/+. In the MENU screen, these buttons serve as up/down buttons.
5	POWER Press to turn on and off the TV.
6	(IR) Infrared Receiver/ Light Sensor Receives IR signals from the remote control. Senses room light level and adjusts the screen brightness accordingly (see page 33 for details). Do not put anything near the sensor, as its function may be affected.
7	PIC OFF/ TIMER LED Lights up in green when the Picture Off feature is activated. Lights up in orange when the timer is set. When the timer is set, this LED will remain lit even if the TV is turned off. For details, see page 33.
8	STANDBY LED Lights up in red when your TV is in PC power saving mode. If the LED blinks in red continuously, this may indicate the TV needs servicing (see “For Your Convenience” on page 2).
9	POWER LED Lights up in green when the TV is turned on.
10	Speaker Outputs audio signal.

⚠ The CHANNEL + button has a tactile dot. Use it as a reference when operating the TV.

⚠ Make sure that the TV is turned off before unplugging the power cord. Unplugging the power cord while the TV is turned on may cause the Power LED to remain lit for up to 20 seconds or may cause the TV to malfunction.

Using the Menus

Overview of MENU

MENU provides one button access for controlling your TV. It enables you to perform a variety of tasks intuitively with a control panel on the screen rather than a variety of remote control button presses.

When you press the MENU button, you can easily perform basic TV functions such as: switching between external inputs, viewing your favorite analog/digital stations, switching between analog and digital channels, and changing or customizing your TV settings.

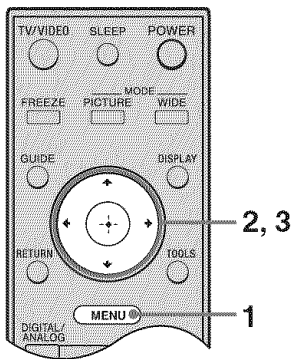

- 1 Press MENU on the remote. MENU control panel appears.
- 2 Press \uparrow/\downarrow to highlight the item.
- 3 Press \odot to select an option. Press MENU to exit.

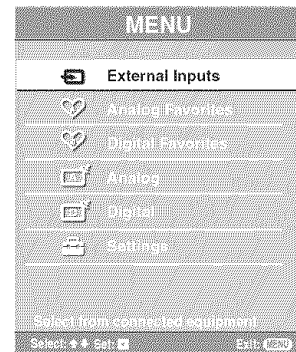

MENU Allows you to

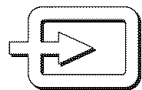

External Inputs

The External Inputs feature lets you select the external inputs connected to your TV. You can also assign a label using Label Video Inputs in the Setup settings. (see page 32)

- 1 Highlight External Inputs on the MENU control panel and press (+).
- 2 Press ▲/▼ to highlight the desired external input and press (+).

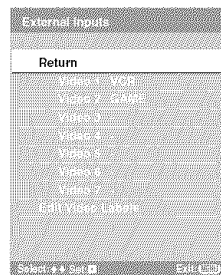

Analog Favorites

The Analog Favorites feature lets you select programs from a list of up to 16 favorite channels that you specify.

- 1 Highlight Analog Favorites on the MENU control panel and press (+).
- 2 Make your selection by pressing ▲/▼ to highlight the desired channel then press (+).
To add the current channel to the list of Favorite Channels, follow step 1 above then highlight and select Add to Favorites or while viewing a program simply press TOOLS button then select Add to Favorites and press (+).
To manually edit your list of favorite channels, select Edit Favorites. For more information, see page 37.

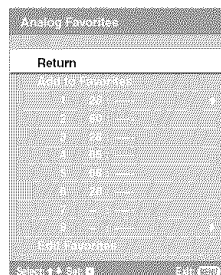

Digital Favorites

The Digital Favorites feature lets you create a list of up to 16 favorite channels that you specify.

- 1 Highlight Favorites from the MENU control panel and press (+).
- 2 Make your selection by pressing ▲/▼ to highlight the desired channel then press (+).
To add the current channel to the list of Favorite Channels, follow step 1 above then highlight Add to Favorites and press (+).
To edit your list of favorite channels, follow step 1 above then highlight and select Edit Favorites.

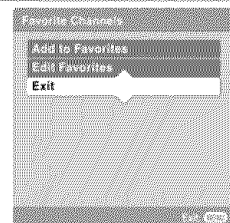

Analog

The Analog feature takes you to the most recently viewed analog channel. When tuned to the channel, Channel number will be displayed.

Highlight Analog on the MENU control panel and press (+).



Digital

The Digital feature takes you to the most recently viewed digital channel. When tuned to the channel, the Program Banner and Channel number will be displayed.

Highlight Digital on the MENU control panel and press (+).

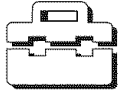

MENU**Allows you to**

Settings

The Settings feature lets you enter the settings screen. Settings and adjustments can be performed from the Settings menu. The information on various settings starts from page 26.

Navigating Through Settings

The Settings screen provides access to the features:

- 1** Press MENU.
- 2** Select .
- 3** Highlight the item: Picture, Sound, Screen, Setup, PC Settings, Analog Setup, Digital Setup.
- 4** Press  to select an option.



To exit Settings, press MENU.

 The options you can adjust vary depending on the situation. Unavailable options are grayed out.

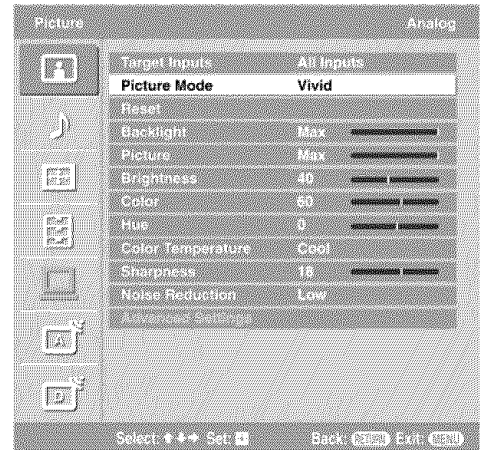
Using the Picture Settings



Option	Description
Target Inputs	Determines whether to apply Picture Settings to current input only, or to all inputs. All Inputs Settings will be applied to “All Inputs” (ex: TV is showing Video 1. Changes to the picture settings affect TV, Video1 - Video7) <i>⏏</i> “All Inputs” will override any settings set by “Current Input.” Current Input Settings will be applied to only the “Current Input” (ex: TV is showing Video 1. Changes to picture settings affect only Video 1)
Picture Mode <i>Customized picture viewing</i>	Vivid Select for enhanced picture contrast and sharpness. Standard Select for standard picture settings. Recommended for home entertainment. Custom Allows you to store your preferred settings. <i>⏏</i> Picture Mode can also be accessed using the TOOLS button on the remote control when in Analog TV, Digital TV and External Inputs.
Reset	Resets the current Picture Mode setting to the default values.
Backlight	Adjust to brighten or darken the backlight.
Picture	Adjust to increase or decrease picture contrast.
Brightness	Adjust to brighten or darken the picture.
Color	Adjust to increase or decrease color intensity.
Hue	Adjust to increase or decrease the green tones.
Color Temperature <i>White adjustment</i>	Cool Select to give the white colors a bluish tint. Neutral Select to give the white colors a neutral tint. Warm 1,2 Select to give the white colors a reddish tint. Available only when Picture Mode is set to Custom.
Sharpness	Adjust to sharpen or soften the picture.
Noise Reduction	Select to reduce the noise level of connected equipment, and the VHF/UHF input. Select from Auto, High, Medium, Low and Off. <i>⏏</i> Auto is only available when you are watching analog channels. It is not available when Target Input is set to All Inputs.

Option	Description	
Advanced Settings <i>Only available in "Custom Picture Mode"</i>	Reset	Resets all the advanced settings to the default settings.
	Black Corrector	Enhances black areas of the picture for stronger contrast.
	Contrast Enhancer	Automatically optimizes the contrast. This setting is especially effective for dark images which increases the vibrancy of the picture.
	Gamma	Adjusts the balance between the light and dark areas of the picture.
	Clear White	Emphasizes white and light colors.
	Live Color	Makes colors more vivid. To enjoy this option you must set Color Space to Wide.
	Color Space	Use to select the range of color reproduction from Normal to Wide.
	 To enjoy the full advantage of the WCG3 FL LCD panel, set the Color Space to Wide. The greens will be deeper green.	
	MPEG Noise Reduction	Reduces the mosaic effect in MPEG-compressed video. Effective for Digital TV programs.
	 If the function is set to High, it will reduce the sharpness of the pictures.	

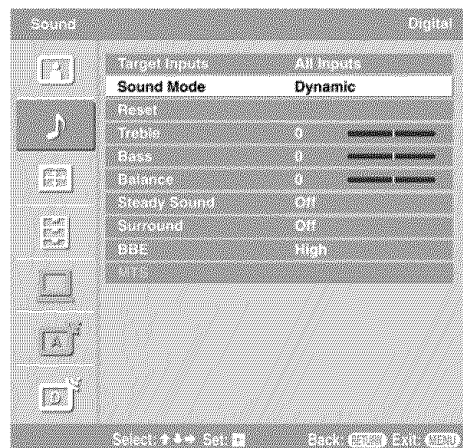

♪ Using the Sound Settings



Option	Description
Target Inputs	Determines whether to apply Sound Settings to current input only, or to all inputs.
	All Inputs Settings will be applied to "All Inputs" (ex: TV is showing Video 1. Changes to the picture settings affect TV, Video1 - Video7)
	"All Inputs" will override any settings set by "Current Input."
Sound Mode	Dynamic Select to enhance treble and bass.
	Standard Suitable for spoken dialog.
	Custom Flat setting. Allows you to store your preferred settings.
<i>Customized sound listening</i>	Sound Mode can also be accessed using the TOOLS button on the remote control when in Analog TV, Digital TV and External Inputs.
	Reset Resets the current Sound Mode setting to the default values, except MTS.
	Treble Adjust to increase or decrease higher-pitched sounds.
Bass Adjust to increase or decrease lower-pitched sounds.	
Balance Adjust to emphasize left or right speaker balance.	
Steady Sound	On Select to stabilize the volume across all programs and commercials.
	Off Select to turn off Steady Sound.
Surround	TruSurround XT Select for surround sound (for stereo programs only).
	Simulated Stereo Adds a surround-like effect to mono programs.
	Off Select for normal stereo or mono reception.
BBE	Select to give sound more impact by compensating for phase effects in speakers. Select from High, Low, and Off.
MTS <i>Enjoy stereo, bilingual and mono programs</i>	Stereo Select for stereo reception when viewing a program broadcast in stereo.
	Auto SAP Select to automatically switch the TV to second audio programs when a signal is received. If no SAP signal is present, the TV remains in Stereo mode.
	Mono Select for mono reception. Use to reduce noise during weak stereo broadcasts.
	MTS is only available for analog programs.

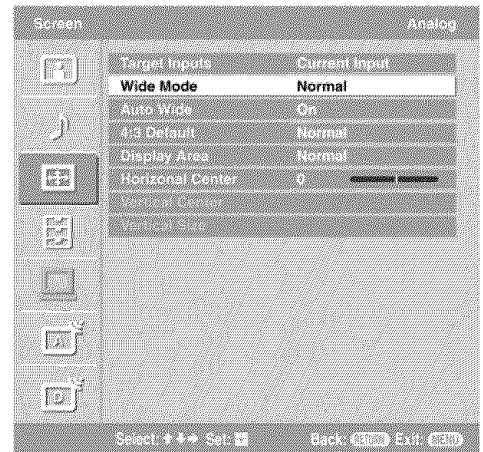









Using the Screen Settings



Option	Description
Target Inputs	Determines whether to apply Screen Settings to current input only, or to all inputs.
	<p>All Inputs Settings will be applied to “All Inputs” (ex: TV is showing Video 1. Changes to the picture settings affect TV, Video1 - Video7)</p> <p> “All Inputs” will override any settings set by “Current Input.”</p>
	<p>Current Input Settings will be applied to only the “Current Input” (ex: TV is showing Video 1. Changes to picture settings affect only Video 1)</p>
Wide Mode	Wide Zoom Select to fill screen with minimum distortion.
	<p>Normal Select to display 4:3 picture in original size when the original source is 4:3.</p> <p> Normal is not available when you are watching 720p or 1080i sources.</p>
	Full Select to enlarge the picture horizontally to fill the screen when the original source is 4:3 (Standard definition source). When the original source is 16:9 (High definition source), select this mode to display 16:9 picture in original size.
	Zoom Select to enlarge the original picture without distorting the aspect ratio.
Auto Wide	On Select to have the screen automatically change to the screen mode based upon program’s content. If frequent screen changes are disturbing to you, select Off.
	Off Select to turn off the Auto Wide option. Choose a screen mode from the Wide Mode option.

(Continued)

Using the Menus

Option	Description
4:3 Default	Wide Zoom Select to enlarge the 4:3 picture to fill the 16:9 screen, keeping the original image as much as possible, with minimal distortion.
Select the default	Normal Select to display the 4:3 picture in its original size.
Screen Mode to use for 4:3 sources	Off Select to continue using the current Wide Mode setting when the channel or input is changed.
	 If 4:3 Default is set to anything but Off, the Wide Mode setting changes only for the current channel. When you change channels (or inputs), Wide Mode is automatically replaced with the 4:3 Default setting for 4:3 sources. To retain the current Wide Mode setting as channels and inputs are changed, set 4:3 Default to Off.
Display Area	Select Normal to return to the default display area. Select -1 or -2 to enlarge the picture so that the edges are outside the visible portion of the screen.
Horizontal Center	Allows you to move the position of the picture left and right. Press  /  and press  to choose a correction between Min, -4 to +4 and Max.  Horizontal Center feature is useful if TV is connected to game equipment.
Vertical Center	Allows you to move the position of the picture up and down. Available only in Zoom mode. Press  /  and press  to choose a correction between Min, -4 to +4 and Max.
Vertical Size	Allows you to adjust the vertical size of the picture. (Available only in Wide Zoom and Zoom modes.) Press  /  and press  to choose a correction between Min, -4 to +4 and Max.

Using the Setup Settings

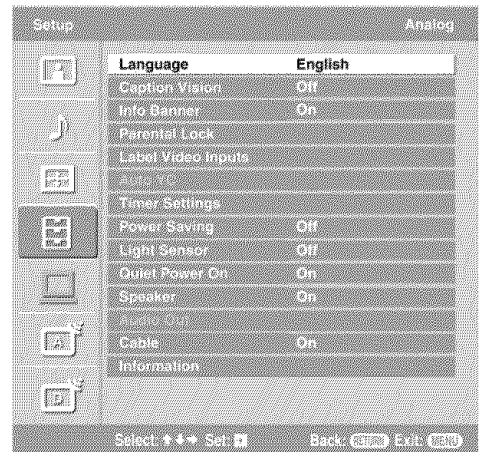

Option	Description
Language	Select to display all on-screen settings in your language of choice: English, Español, Français.
Caption Vision	Allows you to select from several closed caption modes (for programs that are broadcast with closed captioning). Some caption modes for digital channels are only accessible from the Digital Setup setting. For details, see page 39.
	Off Caption Vision is turned off.
	CC1, CC2, CC3, CC4 Displays a printed version of the dialog or sound effects of a program. (Should be set to CC1 for most programs.)
	Text1, Text2, Text3, Text4 Displays network/station information presented using either half or the whole screen (if available).
	 Caption Vision can also be accessed using the TOOLS button on the remote control when in Analog TV, Digital TV and External Inputs (with the exception of PC input).
Info Banner	Set to On or Off. When on, displays the program name and the remaining time (if the broadcaster offers this service). Displays for a few seconds when the channel is changed or the DISPLAY button is pressed.

(Continued)

Option	Description
Parental Lock	The Parental Lock settings allows you to set up the TV to block programs according to their content and rating levels. Use 0-9 on the remote control to enter a four-digit password. The first time you create a password, confirm the password by entering it again.
Lock	<p>Off Turn Parental Lock off. No programs are blocked from viewing.</p> <p>Child Maximum ratings permitted are: U.S.: TV-Y, TV-G, G Canada: C, G, TV-Y</p> <p>Youth Maximum ratings permitted are: U.S.: TV-PG, PG Canada: C8+, PG, 8 ans+, TV-PG</p> <p>Young Adult Maximum ratings permitted are: U.S.: TV-14, PG-13 Canada: 14+, 13 ans+, TV-14</p> <p>Custom Select to set ratings manually. U.S.: See page 34 for details. Canada: See page 35 for details.</p>





 If you are not familiar with the Parental Guideline rating system, you should select Child, Youth, or Young Adult to help simplify the rating selection. To set more specific ratings, select Custom.

Change Password Select to change your password.

 You need your password for any future access into the Parental Lock settings. If you lose your password, see "Lost password," on page 42.

Select Country	U.S.A.	Select to use U.S.A. ratings (see page 34).
	Canada	Select to use Canadian ratings (see page 35).

Label Video Inputs Allows you to identify A/V equipment you connected to the TV, such as a VCR, DVD, etc. For example, if you have a DVD player connected to the VIDEO 4 jack, you can select the label DVD for the Video 4 input. Then when you press TV/VIDEO to change inputs, the Video Label you assigned to that input appears on screen.

- 1 Press  to highlight the video input (Video 1-7) to which you want to assign a label. Then press  to select the input.
- 2 Press  to highlight one of the displayed labels. Then press  to select the label.





You can select from the following labels for each input:

Video 1-6	-, RECEIVER, SATELLITE, CABLE BOX, VCR, DVD, DVR, HD, GAME, CAMCORDER, Edit., Skip
Video 7	-, PC, Edit., Skip

 Edit: allows you to create a custom five character label.

 If you select Skip, your TV skips this input when you press the TV/VIDEO button.

 The Skip label is useful for inputs to which no equipment is connected.

Option	Description
Auto YC	<p>Both composite video and S Video can be connected to VIDEO 1 and VIDEO 2. Your TV by default will automatically select to receive input signal from the S Video. Use this option when you want to receive the input signal from the composite video.</p> <ol style="list-style-type: none"> 1 Press TV/VIDEO repeatedly until the desired video input appears. 2 After selecting the Auto YC option, to watch the pictures input from the S VIDEO input jack: Press $\blacktriangle/\blacktriangledown$ to highlight On, then press \odot. To watch the pictures input from the VIDEO input jack: Press $\blacktriangle/\blacktriangledown$ to highlight Off, then press \odot.
Timer Settings	<p>Sleep Timer Set the time in minutes (Off, 15 min, 30 min, 45 min, 60 min, 90 min, or 120 min) that you want the TV to remain on before shutting off automatically.</p> <p>Timer You can use the Timer to program the TV to turn and off, and to tune to a specific channel at a scheduled time. Timer feature will not be available until you set the Current Time.</p> <ol style="list-style-type: none"> 1 Press $\blacktriangle/\blacktriangledown$ to highlight one of the following options, then press \odot. Set: Select to set the timer by Day, Time, Duration, Channel and Volume Setup. Off: Select to turn off the timer. (Your previous settings are saved.) 2 If you selected Set in step 1, press $\blacktriangle/\blacktriangledown/\blacktriangleleft/\blacktriangleright$ to set the day(s), hour, minute, AM/PM, duration, channel number (VHF/UHF, CATV or Digital), and volume. When Digital is selected, the last digital channel you viewed will automatically show when the TV is turned on. 3 Press MENU to exit Settings. <p> To return to the Timer Settings after programming the Timer or Current Time, press \leftarrow.</p> <p> Timer will be set to Off when: - Auto Program for analog channels is executed. - the AC power cord is disconnected and then reconnected to turn the TV on and the Current Time is displayed as --:-- --.</p> <p>Current Time Select to set the current time (day, hour, minute, and AM/PM).</p> <ol style="list-style-type: none"> 1 Press \odot to select Current Time. 2 Press $\blacktriangle/\blacktriangledown/\blacktriangleleft/\blacktriangleright$ to set the current time (day, hour, minute, and AM/PM). 3 Press MENU to exit Settings.
Power Saving	Select to reduce the power consumption by adjusting the backlight brightness. This also enhances the black level. Select from Off, Low, High and Picture Off.
Light Sensor	Select On to enable the automatic picture (screen) brightness control. The light sensor measures the room brightness which allows the TV to automatically adjust the backlight brightness based on the picture settings and the ambient room light conditions.
	<p> Be sure not to put anything around the sensor, as its function may be affected.</p> <p> In low light the range of the backlight control is reduced when Light Sensor is set to On.</p>
Quiet Power On	Select to have the TV volume start at the minimum volume and gradually change to the set level when you turn it on.



(Continued)

Using the Menus

Option	Description	
Speaker	On	Select to turn on the TV speakers.
	Off	Select to turn off the TV speakers and listen to the TV's sound only through your external audio receiver and speakers.
Audio Out <i>Easy control of volume adjustments</i>	Variable	When Speaker is set to Off, the audio output from your audio system can be controlled by the TV's remote control.
	Fixed	When Speaker is set to Off, the audio output of the TV is fixed. Use your audio receiver's remote control to adjust the volume (and other audio settings) through your audio system.
Cable	On	Select if you are receiving cable channels via Cable TV provider.
	Off	Select if you are using an antenna.
	 You should run Auto Program after changing the Cable setting.	
Information	Select to display the equipment information of your TV.	

US Models: Selecting Custom Parental Lock Rating Options

To select custom rating options for the U.S., select U.S.A. in the Select Country setting (see page 32).

Option	Description	
Movie Rating	G	All children and general audience.
	PG	Parental guidance suggested.
	PG-13	Parental guidance for children under 13.
	R	Restricted viewing, parental guidance is suggested for children under 17.
	NC-17 and X	No one 17 or under allowed.
TV Rating <i>Block programs by their rating, content or both</i>	Age-Based Ratings	
	TV-Y	All children.
	TV-Y7	Directed to children age 7 and older.
	TV-G	General audience.
	TV-PG	Parental guidance suggested.
	TV-14	Parents strongly cautioned.
	TV-MA	Mature audience only.
	Content-Based Ratings	
	FV	Fantasy violence.
	D	Suggestive dialogue.
	L	Strong language.
	S	Sexual situations.
	V	Violence.
		 To ensure maximum blocking capability, set the Age-Based Ratings.
	Unrated <i>Block programs or movies that are broadcast without a rating</i>	Allow
Block		Blocks all programs and movies that are broadcast without a rating.
	 If you block unrated TV programs, be aware that the following types of programs may be blocked: programs broadcast from another public country, emergency broadcasts, political programs, sports, news, public service announcements, religious programs and weather.	

Canadian Models: Selecting Custom Parental Lock Rating Options

To select custom rating options for Canada, select Canada in the Select Country setting (see page 32).

<i>Option</i>	<i>Description</i>	
English Rating	C	All children.
	C8+	Children 8 years and older.
	G	General programming.
	PG	Parental guidance.
	14+	Viewers 14 and older.
French Rating	18+	Adult programming.
	G	General programming.
	8 ans+	Not recommended for young children.
	13 ans+	Not recommended for ages under 13.
U.S.A. Rating	16 ans+	Not recommended for ages under 16.
	18 ans+	Programming restricted to adults.
	See "US Models" on page 34 for details.	

Viewing Blocked Programs

You can view blocked programs by entering the password. Press **ENT** when tuned to a blocked program, then enter the password. This temporarily turns the parental control feature off. To reactivate the Parental Lock settings, turn off the TV. When the TV is turned on again, your Parental Lock settings are reactivated.

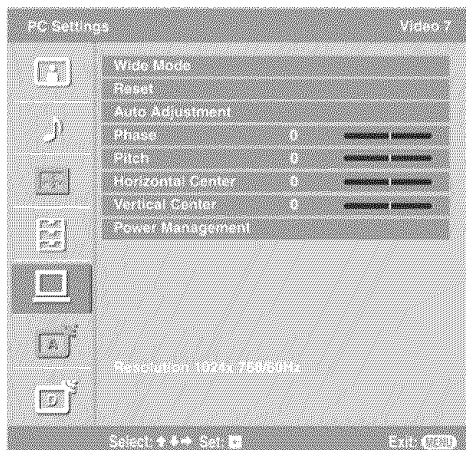

□ Using the PC Settings



Option	Description
Wide Mode	Normal Select to display in the original resolution.
	Full1 Select to enlarge the picture to fill the display area, keeping its original aspect ratio.
	Full2 Select to enlarge the picture to fill the display area.
Reset	Resets the current setting to the default values, except Wide Mode and Power Management .
Auto Adjustment	Select to automatically adjust the display position and phase of the picture when the TV receives an input signal from the connected PC. Note that Auto Adjustment may not work well with certain input signals. In such cases, manually adjust the options below. ✎ Auto Adjustment for PC can also be set using the TOOLS button on the remote control.
Phase	Adjust after Pitch to fine tune overall sharpness.
Pitch	Adjust uneven sharpness on screen. ✎ For the PC Input Signal Reference Chart, see page 44.
Horizontal Center	Allows you to move the position of the picture left and right. Press ←/→ and press (+) to choose a correction between Min, -49 to +49 and Max.
Vertical Center	Allows you to move the position of the picture up and down. Press ▲/▼ and press (+) to choose a correction between Min, -49 to +49 and Max.
Power Management	On Select to automatically switch to the power saving mode when there is no signal input for 30 seconds.
	Off Select to turn off Power Management. ✎ Power Management is not VESA-compliant.

Using the Analog Setup Settings



Option	Description
Favorite Channels	<p>Lets you set up a list of up to 16 of your favorite channels.</p> <ol style="list-style-type: none"> 1 Press ▲/▼ to highlight a Favorite Channel number (1-16) which you want to make your Favorite Channel, then press (+) to select it. 2 Press ▲/▼ to scroll through the channels until you find the channel that you would like to add and then press (+) to select it. <p>To add other Favorite Channel numbers, repeat steps 1-2.</p> <p> To select Favorite Channel numbers that you specified, see page 24.</p> <p> Favorite Channels for Analog TV can also be set using the TOOLS button on the remote control.</p>
Auto Program	<p>Automatically sets up the channel list on the TV for all receivable analog channels.</p> <ol style="list-style-type: none"> 1 Select Auto Program. 2 Select OK to start Auto Program. When Auto Program is done, the Show/Hide Channels screen will appear. (See below)
Show/Hide Channels	<p>Allows you to show or hide channels that appear when you use the CH +/- buttons.</p> <ol style="list-style-type: none"> 1 Press ▲/▼ to scroll through the channels until you find the channel you want to show or hide. Then press (+) to select it. 2 Press ▲/▼ to determine if the channel will be shown or hidden. <p>To show or hide more channels, repeat steps 1-2.</p> <p> Channels that you set to be hidden can be accessed only with the 0-9 buttons.</p>
Label Channels	<p>Allows you to assign labels (such as station call letters) to channel numbers.</p> <ol style="list-style-type: none"> 1 Press ▲/▼ to scroll through the channel numbers. Then press (+) to select the channel number that you want to assign a label. 2 Press ▲/▼ to scroll through the label characters (A-Z, 0-9, etc.). Press ▶ to move to the next character. Repeat to add up to 5 characters to the label. Press ▶ to highlight OK and press (+) to set. <p>To assign labels to more channels, repeat steps 1-2.</p>



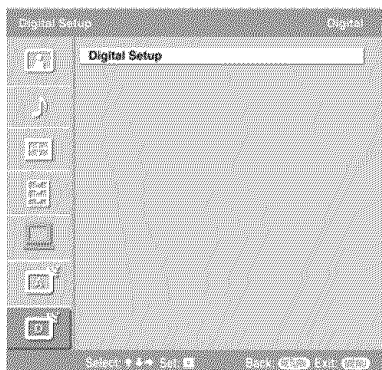



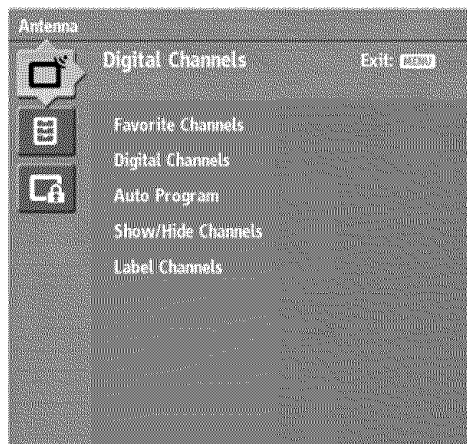

Using the Digital Setup Settings





Highlight Digital Setup and press .

The Digital Setup option appears.



Option	Description
Digital Channels	<p>Favorite Channels Lets you set up a list of up to 16 of your favorite channels.</p> <ol style="list-style-type: none"> 1 Press  to highlight a Favorite Channel number (1-16) which you want to make your Favorite Channel. 2 Enter the number you wish to assign to the channel. Reset will remove the existing Favorite Channel and Surf will take you to the Favorite Channel list. <p>To select other Favorite Channel numbers, repeat steps 1-2.</p>
Digital Channels	<p>Add Select to add digital channels without replacing the original Channel List. This option is useful for antenna installations.</p>
Auto Program	<p>Automatically sets up the channel list on the TV for all receivable digital channels.</p> <ol style="list-style-type: none"> 1 Select Auto Program then Start. 2 Select OK to start Auto Program. When Auto Program is done, select OK.
Show/Hide Channels	<p>Allows you to show or hide channels that appear when you use the CH +/- buttons.</p> <ol style="list-style-type: none"> 1 Press  to scroll through the channels until you find the channel you want to show or hide. 2 Press  to determine if the channel will be shown or hidden. <p>To show or hide more channels, repeat steps 1-2.</p>
<p> Channels that you set to be hidden can be accessed only with the 0-9 buttons.</p>	
Label Channels	<p>Allows you to assign labels (such as station call letters) to channel numbers.</p> <ol style="list-style-type: none"> 1 Press  to scroll through the channel numbers. Then press  to select the channel number that you want to assign a label. 2 Press  to scroll through the label characters (A-Z, 0-9, etc.). Press  to move to the next character. Repeat to add up to 7 characters to the label. Then press  to set it. <p>To assign labels to more channels, repeat steps 1-2.</p>

Option	Description		
Digital Setup	Caption Vision	Allows you to select from several closed-caption modes for digital channels. To set Caption Vision for analog channels, see page 31.	
	On	Caption Vision is turned on.	
	Off	Caption Vision is turned off.	
	Program	Allows you to set basic and advanced Caption Vision options. See “Programming Caption Vision” below.	
A/V Sync	Off/1/2/3	Use this option to make adjustments to audio and video synchronization when you have external equipment connected to OPTICAL OUT of the TV. Select Off (default setting) to make no adjustments. Select 1, 2 or 3 to adjust so that the video and audio from your connected external equipment are synchronized.	
Diagnostics		Display diagnostics information about the TV. This can be useful in providing information to an authorized technician or repair person.	
Parental Lock	The Parental Lock option in the Digital Setup settings allows you to set up the TV to block digital programs that contain digital ratings.		
	 This setting is only available if digital ratings have been downloaded by your TV and ratings have been set for U.S.A. in the Setup settings (see page 31).		
	Password	If the password has not been set, or to change the password, use Change Password option in the Setup settings (see page 32).	
	Digital Rating	Off	Turn Parental Lock off. No programs that contain downloadable ratings are blocked from viewing.
		Custom...	Select to block programs based on downloadable ratings.
Clear All		Select to clear the entire downloadable rating system.	
 This action will delete the current Digital Rating menu and the menu will no longer be available until the TV is tuned to a channel that contains downloadable ratings.			

Programming Caption Vision

If you selected the Program option under Caption Vision, you can change the following settings:

Option	Description	
Basic	Allows you to select basic analog (EIA-608) closed caption options.	
	CC1, CC2, CC3, CC4	See Caption Vision in the Setup setting on page 31.
	Text1, Text2, Text3, Text4	See Caption Vision in the Setup setting on page 31.
Digital CC	Allows you to set digital closed captioning to Basic (digital EIA-608) or Advanced (digital EIA-708).	
Advanced	Allows you to select advanced digital (EIA-708) closed caption options. Select from the available options.	

(Continued)

Using the Menus

<i>Option</i>	<i>Description</i>
Advanced Settings	Allows you to make additional settings for digital (EIA-708) closed caption options. Select from As Broadcast, Small Text, Large Text and Custom.
Custom...	Allows you to customize the following settings:
Character Size	Small, Standard, Large
Character Style	Style 1-7
Character Color	Color 1-8
Character Opacity	Solid, Translucent
Edge Color	Color 1-8
Edge Type	None, Raised, Depressed, Outline, Left Shadow, Right Shadow
Background Color	None, Color 1-8
Background Opacity	Solid, Translucent
Window Color	None, Color 1-8
Window Opacity	Solid, Translucent

Other Information

Troubleshooting

If you have additional questions, service needs, or required technical assistance related to the use of your Sony TV, please visit our website or call one of the following numbers:

<http://www.sony.com/TVsupport>

1-800-222-SONY(7669) for US Residents

1-877-899-SONY(7669) for Canadian Residents

Problem	Possible Remedies
No picture.	
No picture.	<input type="checkbox"/> Check Power Saving settings (page 33).
Cannot receive any channels.	<input type="checkbox"/> Make sure the power cord is connected securely.
	<input type="checkbox"/> Turn on the power of the TV.
	<input type="checkbox"/> Check antenna/cable connections.
TV is locked to one channel.	<input type="checkbox"/> Perform Auto Program to add receivable channels that are not presently in the TV's memory (pages 37 and 38).
Cannot receive or select channels.	<input type="checkbox"/> Perform Auto Program to add receivable channels that are not presently in the TV's memory (pages 37 and 38).
	<input type="checkbox"/> To receive or select cable channels, make sure that Cable in the Setup settings is set to On (page 34). To receive or select UHF channels over an antenna, make sure Cable is set to Off .
The TV turns off automatically.	<input type="checkbox"/> Check if the Sleep Timer is activated, or confirm the Duration setting of Timer . (page 33).
	<input type="checkbox"/> Check Power Management in the PC Settings . (page 36)
No picture from some video sources.	<input type="checkbox"/> Check the connection between the optional video equipment and the TV.
	<input type="checkbox"/> Press TV/VIDEO on the remote control (page 19).
	<input type="checkbox"/> If you connect video equipment to the S VIDEO input of the TV, set Auto YC to On in the Setup settings (page 33).
	<input type="checkbox"/> Press MENU on the remote control. Select your desired input from the External Inputs list.
Poor picture.	
Double images or ghosts.	<input type="checkbox"/> Check antenna/cable connections.
	<input type="checkbox"/> Check the antenna location and direction.
Only snow and noise appear on the screen.	<input type="checkbox"/> Check if the antenna is broken or bent.
	<input type="checkbox"/> Check if the antenna has reached the end of its serviceable life. (3-5 years in normal use, 1-2 years at the seaside.)
Dotted lines or stripes.	<input type="checkbox"/> Keep the TV away from noise sources such as cars, motorcycles, or hair-dryers.
	<input type="checkbox"/> If using 300 ohm twin lead, move the excess lead away from the TV or try using 75 ohm coaxial cable instead.
No color/Dark picture/Color is not correct/The picture is too bright.	<input type="checkbox"/> Press PICTURE to select the desired picture mode (page 19).
	<input type="checkbox"/> Adjust the Picture Mode options in the Picture settings (page 26).
	<input type="checkbox"/> If you set the Power Saving mode to Low or High , it will enhance the black level.
Noisy picture.	<input type="checkbox"/> Make sure that the antenna is connected using the supplied 75-ohm coaxial cable.
	<input type="checkbox"/> Keep the antenna cable away from other connecting cords.
	<input type="checkbox"/> To avoid TV interference, make sure to use an undamaged antenna cable.

Other Information

Problem	Possible Remedies
No sound/Noisy sound	
Good picture, no sound.	<ul style="list-style-type: none"><input type="checkbox"/> Check the volume control.<input type="checkbox"/> Press MUTING or VOL + so that "Muting" disappears from the screen (page 20).<input type="checkbox"/> Disconnect your headphones.<input type="checkbox"/> Set Speaker to On in the Setup settings (page 34). If it is set to Off, sound is not output from the TV's speakers regardless of the TV's volume control.
Audio noise.	<ul style="list-style-type: none"><input type="checkbox"/> Make sure that the antenna is connected using the supplied 75-ohm coaxial cable.<input type="checkbox"/> Keep the antenna cable away from other connecting cords.<input type="checkbox"/> To avoid TV interference, make sure to use an undamaged antenna cable.
Wide Mode changes automatically.	<ul style="list-style-type: none"><input type="checkbox"/> The current Wide Mode setting is automatically replaced with the 4:3 Default setting when you change the channel or video input, if 4:3 Default in the Screen settings is set to other than Off. If you want to lock in the Wide Mode selected with the WIDE button, set 4:3 Default to Off in the Screen settings (page 30).<input type="checkbox"/> Check the Auto Wide option in the Screen settings (page 29).
"Black box" on screen.	<ul style="list-style-type: none"><input type="checkbox"/> You have selected a text option in the Setup/Digital Setup setting and no text is available. (See pages 31 and 39 to reset Setup selections.) To turn off this feature, set the Caption Vision option to Off. If you were trying to select closed captioning, select CC1 instead of Text1-4.
Black bands appear at the top and bottom of the screen.	<ul style="list-style-type: none"><input type="checkbox"/> Some wide screen programs are filmed in aspect ratios that are greater than 16:9 (this is especially common with theatrical releases). Your TV will show these programs with black bands at the top and bottom of the screen. For more details, check the documentation that came with your DVD (or contact your program provider).
Certain programs on DVD or other digital sources display a loss of detail, especially during fast-motion or dark scenes.	<ul style="list-style-type: none"><input type="checkbox"/> The compression used by certain digital broadcasts and DVDs may cause your TV's screen to display less detail than usual, or cause artifacts (small blocks or dots, pixelations) to appear on your screen. This is due to your TV's large screen and ability to show very fine detail, and is normal for certain digitally recorded programs.
Remote control does not operate.	<ul style="list-style-type: none"><input type="checkbox"/> Check the polarity of the batteries or replace the batteries.<input type="checkbox"/> Point the remote control at the remote control sensor of the TV.<input type="checkbox"/> Florescent lamps can interfere with your remote control operation; try turning off the florescent lamps.<input type="checkbox"/> Keep the remote control sensor area clear from obstacles.
Some digital cable channels are not being displayed.	<ul style="list-style-type: none"><input type="checkbox"/> Certain cable companies have limitations on the broadcast of digital cable channels. Check with your cable company for more information.<input type="checkbox"/> The digital cable channel may be set to Hidden in the Show/Hide Channels setting (see page 38).
Lost password.	<ul style="list-style-type: none"><input type="checkbox"/> Select the Parental Lock settings on the settings screen, then enter the following master password: 4357. The master password clears your previous password and allows you to enter a new password (page 32).
How to reset the TV to factory settings.	<ul style="list-style-type: none"><input type="checkbox"/> Turn on the TV. While holding down the ▲ button on the remote control, press the POWER button on the TV. (The TV will turn itself off, then back on again.) Release the ▲ button. WARNING: The Reset will clear all of your customized settings including Parental Lock setting.

Preparation for Wall Mounting Your TV

This TV can be installed on a wall by using a wall-mount bracket (sold separately). Before mounting the TV on a wall, the Table-Top Stand must be removed from the TV.

 Do not remove the Table-Top Stand for any reason other than to wall-mount the TV.

Follow the simple steps below to remove the Table-Top Stand:

Sony Wall-Mount Bracket Model SU-WL31

- 1** Disconnect all the cables from the TV.
- 2** Cover a level and stable surface with a thick and soft cloth.
- 3** Gently lay the TV, face down, onto the cloth. Make sure the Table-Top Stand is hanging over the edge.
- 4** Rotate the cable holder 90 degrees, and pull it out completely. [See illustration A]
- 5** Remove the screws and detach the Table-Top Stand from the TV. [See illustration B] Be sure to hold the Table-Top Stand firmly while removing the last screw.
- 6** Do not remove any other screws from the TV.



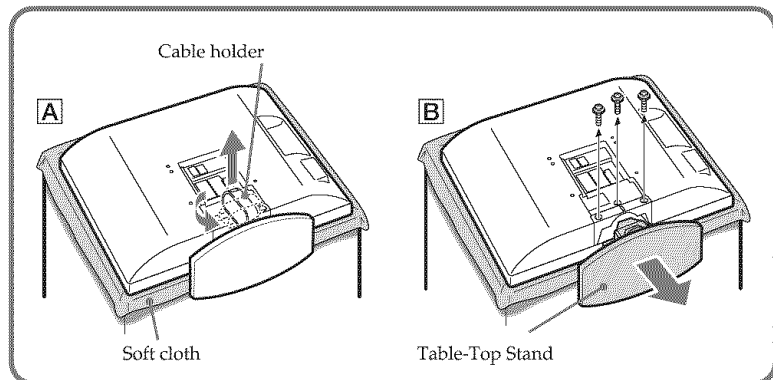

For bracket installation, refer to the instruction guide provided by the Wall-Mount Bracket model for your TV. Sufficient expertise is required in installing this TV, especially to determine the strength of the wall for withstanding the TV's weight. **For product protection and safety reasons, Sony strongly recommends that you use the Wall-Mount Bracket model designed for your TV and the wall-mounting of your TV should be performed by Sony dealers or licensed contractors.**



 Be sure to store the removed screws and Table-Top Stand in a safe place until you are ready to reattach the Table-Top Stand. Keep the screws away from small children.

PC Input Signal Reference Chart

Resolution Signals	Horizontal (Pixel)	×	Vertical (Line)	Horizontal frequency (kHz)	Vertical frequency (Hz)	Standard
VGA	640	×	480	31.5	60	VGA
	640	×	480	37.5	75	VESA
	720	×	400	31.5	70	VGA-T
SVGA	800	×	600	37.9	60	VESA Guidelines
	800	×	600	46.9	75	VESA
XGA	1024	×	768	48.4	60	VESA Guidelines
	1024	×	768	56.5	70	VESA
	1024	×	768	60.0	75	VESA
WXGA	1280	×	768	47.4	60	VESA
	1280	×	768	47.8	60	VESA
	1360	×	768	47.7	60	VESA

-  This TV's PC Input does not support Sync on Green or Composite Sync.
-  This TV's PC Input does not support interlaced signals.
-  This TV's PC Input supports signals in the above chart with a 60Hz vertical frequency.
-  For the best picture quality, it is recommended to use signals with a 60Hz vertical frequency from a personal computer. In plug and play, signals with 60Hz vertical frequency will be selected automatically.

Specifications

KDL-V32XBR2

Television system:

NTSC	American TV standard
ATSC (8VSB terrestrial)	ATSC compliant 8VSB ANSI/SCTE 07 2000
QAM on cable	(Does not include CableCARD functionality)

Channel coverage:

Terrestrial	Analog	Digital
Cable	2-69	2-69
	1-125	1-135

Antenna: 75-ohm external terminal for VHF/UHF

Panel System:

LCD (Liquid Crystal Display) Panel

Display resolution (horizontal × vertical):

1,366 dots × 768 lines

Screen Size (in inches):

32

VIDEO IN 1/2/3:

S VIDEO (4-pin mini DIN) (VIDEO 1/2 only):

Y: 1.0 Vp-p, 75 ohms unbalanced, sync negative

C: 0.286 Vp-p (Burst signal), 75 ohms

VIDEO: 1 Vp-p, 75 ohms unbalanced, sync negative

AUDIO: 500 mVrms (100% modulation)

Impedance: 47 kilohms

HD/DVD IN 4/5:

YPbPr (Component Video):

Y: 1.0 Vp-p, 75 ohms unbalanced,
sync negative

PB: 0.7 Vp-p, 75 ohms

PR: 0.7 Vp-p, 75 ohms

Signal format: 480i, 480p, 720p, 1080i

AUDIO: 500 mVrms (100% modulation)

Impedance: 47 kilohms

HDMI IN 6:

HDMI: Video: 480i, 480p, 720p, 1080i

Audio: Two channel linear PCM 32, 44.1 and
48 kHz, 16, 20 and 24 bits

AUDIO: 500 mVrms (100% modulation)

Impedance: 47 kilohms

AUDIO OUT:

500 mVrms (100% modulation)

More than 1 Vrms at the maximum volume setting (Variable)

More than 500 mVrms (Fixed)

PC IN 7:

D-sub 15-pin, analog RGB, 0.7 Vp-p, 75 ohms, positive

See the PC Input Signal Reference Chart on page 44

PC AUDIO INPUT:

Stereo mini jack, 0.5 Vrms, 1 kilohm

Headphones:

Stereo mini jack

Impedance: 16 ohms

Speaker/Full range (2):

Speaker output 10 + 10W

Speaker size 42 × 150 mm (1 11/16 × 6 in)

Power Requirement:

120 V-240 V AC, 50/60 Hz

Power Consumption:

In use 180W

In standby 0.1W

Dimensions:

With stand 792 × 593 × 219 mm (31 1/4 × 23 3/8 × 8 5/8 in.)

Without stand 792 × 546 × 99 mm (31 1/4 × 21 1/2 × 4 in.)

Mass:

With stand 16.4 kg (36.1 pounds)

Without stand 14.45 kg (31.8 pounds)

Supplied accessories:

Remote control RM-YD012 (1)

Size AA batteries (2)

75-ohm coaxial cable (1)

AC power cord (1)

HD15-HD15 cable (1)

Support belt (1), securing screw (1) and wood screw (1)

Cable holder (1)

Operating Instructions (1)

Quick Setup Guide (1)

Warranty Card (1)

Online Registration Card (U.S.A. only) (1)

Optional accessories:

Headphones plug adapter

Connecting cables

Wall-Mount Bracket: SU-WL31

 Optional accessories availability depends on its stock.

Index

4:3 Default 30

A

A/V Sync 39
AC IN 15
Advanced Settings 27
Alternate Audio 20
Alternate Video 20
Audio Out 34
AUDIO OUT jack, described 15
Auto Adjustment 36
Auto Program 18, 37, 38
Auto SAP, MTS setting 28
Auto Wide 29
Auto YC 33

B

Backlight 26
Balance 28
Bass 28
BBE 28
Bilingual audio 28
Brightness 26

C

Cable
 with VCR, connecting 13
Caption Vision 31, 39
CH+/- button 21, 22
Channels
 Creating labels 37, 38
 Setting up 18
Closed caption modes 31
Color 26
Color Temperature 26
Current Time 33

D

Diagnostics 39
Digital Channels 38
Digital Setup 39
DIGITAL/ANALOG button 20
Display Area 30
DISPLAY button 21
Dynamic, Sound Mode 28

E

English Rating 35
ENT button 21

F

Favorite Channels 37, 38
FREEZE button 19
French Rating 35

G

GUIDE button 19

H

HD/DVD IN jack (1080i/720p/480p/480i), described 15
HDMI IN jack, described 15
Headphones jack, described 14
Horizontal Center 30, 36
Hue 26

I

Info Banner 31
Information 34
Infrared Receiver (IR) 22
Installing the TV on a wall 43

J, K

JUMP button 21

L

Label Channels 37, 38
Label Video Inputs 32
Language 31
Light Sensor
 Described 22
 Setting 33

M

MENU
 Analog 24
 Analog Favorites 24
 Digital 24
 Digital Favorites 24
 Settings 25
MENU button 20, 22
Mono, MTS setting 28
Movie Rating 34
MTS 28
MUTING button 20

N

Noise Reduction 26

O

OPTICAL OUT 15

P, Q

Parental Lock 32, 39
PC IN 14
Phase 36
PIC OFF LED 22
Picture 26
PICTURE button 19
Picture Mode 26
Pitch 36
POWER button 20, 22
POWER LED 22
Power Management 36
Power Saving 33
Preparation 43
Problems, troubleshooting 41, 42
Program Options 20
Quiet Power On 33

R

Reset 26, 28, 36, 42
RETURN button 20

S

S VIDEO jack, described 14, 15
Setting up channels 18
Settings
 Analog Setup 37
 Digital Setup 38
 PC 36
 Picture 26
 Screen 29
 Setup 31
 Sound 28
Sharpness 26
Show/Hide Channels 37, 38
SLEEP button 19
Sound Mode 28
Speaker 34
STANDBY LED 22
Steady Sound 28
Stereo, MTS setting 28
Support Belt 16
Surround 28

T, U

Target Inputs 26, 28, 29
TIMER LED 22
Timer Settings 33
TOOLS button 21
Treble 28
Troubleshooting 41, 42
TruSurround XT 28
Turning on/off the TV 22
TV Rating 34
TV/VIDEO button 19
Unrated 34
US Models 34

V

VCR
 With cable, connecting 13
Vertical Center 30, 36
Vertical Size 30
VHF/UHF input, described 15
VIDEO/AUDIO (L/R) jacks, described 14, 15
Viewing Blocked Programs 35
VOL+/- button 20, 22

W, X, Y

WIDE button 21
Wide Mode 29, 36

For Your Convenience

Please contact Sony directly if you:

- Have questions on the use of your television after reading your manual
- Experience difficulty operating your television

Contact Sony Customer Support at:

<http://www.sony.com/tvsupport>

or to speak with a support representative:

United States

1-800-222-SONY (7669)

8:00 AM – 10:00 PM (EST) Mon–Fri

10:30 AM – 7:15 PM (EST) Sat–Sun

Canada

1-877-899-SONY (7669)

8:00 AM – 6:00 PM (Eastern)

8:00 AM – 5:00 PM (Western)

Sony will work to resolve your questions more quickly than your retailer or place of purchase.

Please Do Not Return the Product to the Store

HDMI

HDTV
HIGH-DEFINITION TELEVISION

BBE
DIGITAL

DOLBY
DIGITAL

SRS
TruSurroundXT



2699535111

<http://www.sony.net/>

Printed in U.S.A.