

SONY[®]

2-681-559-13(1)

GRAND WEGA[™]

LCD Projection TV
HD-TV
Operating Instructions

KDF-42E2000
KDF-46E2000
KDF-50E2000
KDF-55E2000



Owner's Record

The model and serial numbers are located at the rear of the TV. Record these numbers in the spaces provided below. Refer to them whenever you call upon your Sony dealer regarding this product.

Model No. _____

Serial No. _____

For Your Convenience

Please contact Sony directly if you:

- Have questions on the use of your television after reading your manual
- Experience difficulty operating your television

Contact Sony Customer Support at:

 <http://www.sony.com/tvsupport> 

or to speak with a support representative:

United States

1-800-222-SONY (7669)

8:00 AM - 10:00 PM (EST) Mon - Fri

10:30 AM - 7:15 PM (EST) Sat - Sun

Canada

1-877-899-SONY (7669)

8:00 AM - 6:00 PM (Eastern)

8:00 AM - 5:00 PM (Western)

Sony will work to resolve your questions more quickly than your retailer or place of purchase.

Please Do Not Return the Product to the Store

WARNING

To reduce the risk of fire or electric shock, do not expose this apparatus to rain or moisture.

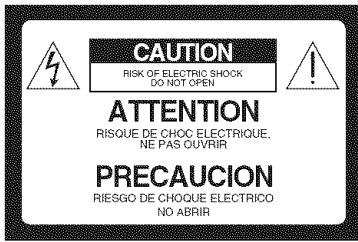

This symbol is intended to alert the user to the presence of uninsulated “dangerous voltage” within the product’s enclosure that may be of sufficient magnitude to constitute a risk of electric shock to persons.



This symbol is intended to alert the user to the presence of important operating and maintenance (servicing) instructions in the literature accompanying the appliance.

The apparatus shall not be exposed to dripping or splashing and no objects filled with liquids, such as vases, shall be placed on the apparatus.

CAUTION

To prevent electric shock, do not use this polarized AC plug with an extension cord, receptacle or other outlet unless the blades can be fully inserted to prevent blade exposure.

Note on Caption Vision

This TV provides display of TV closed captioning in accordance with §15.119 of the FCC rules.

NOTIFICATION

This equipment has been tested and found to comply with the limits for a Class B digital device, pursuant to Part 15 of the FCC Rules. These limits are designed to provide reasonable protection against harmful interference in a residential installation. This equipment generates, uses and can radiate radio frequency energy and, if not installed and used in accordance with the instructions, may cause harmful interference to radio communications. However, there is no guarantee that interference will not occur in a particular installation. If this equipment does cause harmful interference to radio or television reception, which can be determined by turning the equipment off and on, the user is encouraged to try to correct the interference by one or more of the following measures:

- Reorient or relocate the receiving antenna.
- Increase the separation between the equipment and receiver.
- Connect the equipment into an outlet on a circuit different from that to which the receiver is connected.
- Consult the dealer or an experienced radio/TV technician for help.

Persuant to FCC regulations, you are cautioned that any changes or modifications not expressly approved in this manual could void your authority to operate this equipment.

Safety

- Operate the TV only on 120 V AC.
- The plug is designed, for safety purposes, to fit into the wall outlet only one way. If you are unable to insert the plug fully into the outlet, contact your dealer.
- If any liquid or solid object should fall inside the cabinet, unplug the TV immediately and have it checked by qualified service personnel before operating it further.
- If you will not be using the TV for several days, disconnect the power by pulling the plug itself. Never pull on the cord.
- For details concerning safety precautions, see “Important Safety Instructions” on page 5.

Installing

- The TV should be installed near an easily accessible power outlet.
- To prevent internal heat buildup, do not block the ventilation openings.
- Do not install the TV in a hot or humid place, or in a place subject to excessive dust or mechanical vibration.
- Avoid operating the TV at temperatures below 41°F (5°C).
- If the TV is transported directly from a cold to a warm location, or if the room temperature changes suddenly, the picture may be blurred or show poor color due to moisture condensation. In this case, please wait a few hours to let the moisture evaporate before turning on the TV.
- To obtain the best picture, do not expose the screen to direct illumination or direct sunlight. It is recommended to use spot lighting directed down from the ceiling or to cover the windows that face the screen with opaque drapery. It is desirable to install the TV in a room where the floor and walls are not of a reflective material.
- See pages 13 and 14 for more information on the installation.

CAUTION

Use the following Sony appliance(s) only with the following TV STAND.

SONY APPLIANCE MODEL NO.			
	KDF-42E2000	KDF-46E2000	KDF-50E2000 KDF-55E2000
SONY TV STAND MODEL NO.	SU-RG11S	SU-RG12S	SU-RG12L

Use with other TV STAND may cause instability and possibly result in injury.

To Customers

Sufficient expertise is required for installing the specified product. Be sure to subcontract the installation to Sony dealers or licensed contractors and pay adequate attention to safety during the installation.

(Continued)

For Customers in the United States

This product contains mercury. Disposal of this product may be regulated if sold in the United States. For disposal or recycling information, please contact your local authorities or the Electronics Industries Alliance (<http://www.eiae.org>).

Note

This digital television is capable of receiving analog basic and digital basic television programming by direct connection to a cable system providing such programming. Certain premium, advanced and interactive digital cable services such as video-on-demand, a cable operator's enhanced program guide and data-enhanced television services may require the use of a set-top box. For more information call your local cable operator.

This television includes a QAM demodulator which should allow you to receive unscrambled digital cable television programming via subscription service to a cable service provider. Availability of digital cable television programming in your area depends on the type of programming and signal provided by your cable service provider.

Trademark Information

TruSurround XT, SRS and the  symbol are trademarks of SRS Labs, Inc. TruSurround XT technology is incorporated under license from SRS Labs, Inc.

Licensed by BBE Sound, Inc. under one or more of the following US patents: 5510752, 5736897. BBE and BBE symbol are registered trademarks of BBE Sound, Inc.

Macintosh is a trademark licensed to Apple Computer, Inc., registered in the U.S.A and other countries.

Blu-ray Disc is a trademark.

WEGA, Grand WEGA, Steady Sound, Digital Reality Creation and CineMotion are registered trademarks of Sony Corporation.



This TV is manufactured under license from Dolby Laboratories. "Dolby" and the double-D symbol are trademarks of Dolby Laboratories.



This TV incorporates High-Definition Multimedia Interface (HDMI™) technology.

HDMI, the HDMI logo and High-Definition Multimedia Interface are trademarks or registered trademarks of HDMI Licensing LLC.



Important Safety Instructions

- 1) Read these instructions.
- 2) Keep these instructions.
- 3) Heed all warnings.
- 4) Follow all instructions.
- 5) Do not use this apparatus near water.

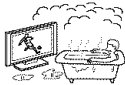

- 6) Clean only with dry cloth.



- 7) Do not block any ventilation openings. Install in accordance with the manufacturer's instructions.

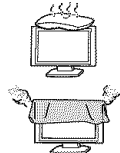

- 8) Do not install near any heat sources such as radiators, heat registers, stoves, or other apparatus (including amplifiers) that produce heat.

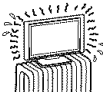

- 9) Do not defeat the safety purpose of the polarized or grounding-type plug. A polarized plug has two blades with one wider than the other. A grounding type plug has two blades and a third grounding prong. The wide blade or the third prong are provided for your safety. If the provided plug does not fit into your outlet, consult an electrician for replacement of the obsolete outlet.

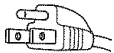
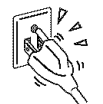

- 10) Protect the power cord from being walked on or pinched particularly at plugs, convenience receptacles, and the point where they exit from the apparatus.

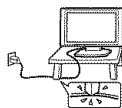

- 11) Only use attachments/accessories specified by the manufacturer.



- 12) Use only with the cart, stand, tripod, bracket, or table specified by the manufacturer, or sold with the apparatus. When a cart is used, use caution when moving the cart/apparatus combination to avoid injury from tip-over.



- 13) Unplug this apparatus during lightning storms or when unused for long periods of time.



- 14) Refer all servicing to qualified service personnel. Servicing is required when the apparatus has been damaged in any way, such as power-supply cord or plug is damaged, liquid has been spilled or objects have fallen into the apparatus, the apparatus has been exposed to rain or moisture, does not operate normally, or has been dropped.

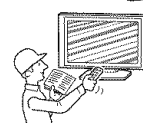

- Be sure to observe the TV's "For Safety" section on page 6.

Antennas

Outdoor Antenna Grounding

If an outdoor antenna is installed, follow the precautions below. An outdoor antenna system should not be located in the vicinity of overhead power lines or other electric light or power circuits, or where it can come in contact with such power lines or circuits.

WHEN INSTALLING AN OUTDOOR ANTENNA SYSTEM, EXTREME CARE SHOULD BE TAKEN TO KEEP FROM CONTACTING SUCH POWER LINES OR CIRCUITS AS CONTACT WITH THEM IS ALMOST INVARIABLY FATAL.

Be sure the antenna system is grounded so as to provide some protection against voltage surges and built-up static charges.

Section 810 of the National Electrical Code (NEC) in USA and Section 54 of the Canadian Electrical Code in Canada provides information with respect to proper grounding of the mast and supporting structure, grounding of the lead-in wire to an antenna discharge unit, size of grounding conductors, location of antenna discharge unit, connection to grounding electrodes, and requirements for the grounding electrode.

(Continued)

Antenna Grounding According to the NEC

Refer to section 54-300 of Canadian Electrical Code for Antenna Grounding.

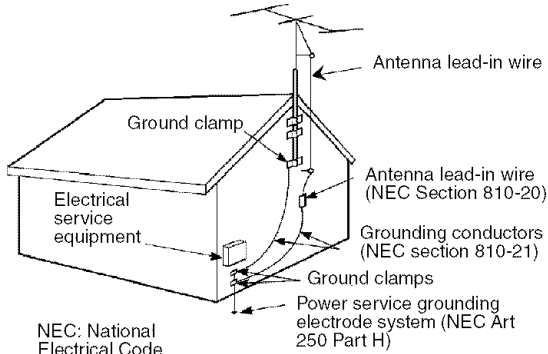

Cleaning

- Clean the rear cover area of the TV regularly. Dust in the rear cover area may cause a problem with the cooling system of the TV set.
- Clean the cabinet of the TV with a dry soft cloth. To remove dust from the screen, wipe it gently with a soft cloth. Stubborn stains may be removed with a cloth slightly dampened with solution of mild soap and warm water. Never use strong solvents such as thinner or benzine for cleaning. If the picture becomes dark after using the TV for a long period of time, it may be necessary to clean the inside of the TV. Consult qualified service personnel.
- Unplug the AC power cord when cleaning this unit. Cleaning this unit with a plugged AC power cord may result in electric shock.



On Contamination on the Screen Surface

The screen surface has a special coating to reduce reflections. To prevent screen damage, clean the screen as follows:

- Clean the screen with a soft cloth.
- To remove hard contamination, use a cloth moistened with a solution of mild detergent and water. Do not spray cleaning solution directly onto the TV. It should only be sprayed to moisten the cleaning cloth.
- Do not use any type of abrasive pad, alkaline cleaner, acid cleaner, scouring powder, chemical cloth, or solvent such as alcohol, benzene or thinner, as these may scratch the screen's coating.

Service

Damage Requiring Service

Do not attempt to service the set by yourself since opening the cabinet may expose you to dangerous voltage or other hazards.

Unplug the set from the wall outlet and refer servicing to qualified service personnel.

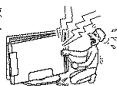

Replacement Parts

When replacement parts are required, be sure the service technician certifies in writing that he has used replacement parts specified by the manufacturer that have the same characteristics as the original parts.

Unauthorized substitutions may result in fire, electric shock or other hazards.

See "Replacing the Lamp" on page 76.

For Safety

Be Careful When Moving the TV

When you place the TV in position, be careful not to drop it on your foot or fingers.

Watch your footing while installing the TV.

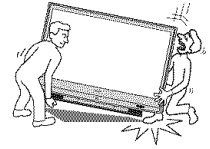

Carry the TV in the Specified Manner

If you carry the TV in a manner other than the specified manner and without the specified number of persons, it may drop and a serious injury may be caused. Be sure to follow the instructions mentioned below.

- Carry the TV with the specified number of persons (see page 13).
- Hold the TV tightly when carrying it.
- Before carrying the TV, disconnect any accessories or cables.

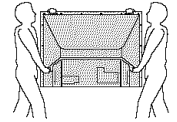

About the TV

Although the TV is made with high-precision technology, black dots may appear or bright points of light (red, blue, or green) may appear constantly on the screen. This is a structural property of the panel and is not a defect.

Installation

- If direct sunlight or other strong illumination shines on the screen, part of the screen may appear white due to reflections from behind the screen. This is a structural property of the TV. Do not expose the screen to direct illumination or direct sunlight.
- The picture quality may be affected by your viewing position. For the best picture quality, install your TV according to "Recommended Viewing Area" on page 15.
- When installing your TV against a wall, keep it at least 4 inches (10 cm) away from the wall.

Projection Lamp

- Your TV uses a projection lamp as its light source. It is time to replace the lamp with a new one (not supplied) when:
 - the message, "Projection lamp is nearing end of life. Please replace the lamp," appeared on the screen,
 - the lamp replacement indicator on the front panel blinks in red,
 - screen images become dark,
 - no image appears on the display after prolonged use.
- In rare instances, the bulb may pop inside the lamp unit, but the lamp unit is designed to contain all of broken glass pieces inside the lamp unit. (See "Replacing the Lamp" on page 76.)
- When the lamp eventually burns out, you may hear a noticeable pop sound. This is normal and is inherent in this type of lamp.

Cooling Fan

This TV uses a cooling fan. You may hear the noise of fan running, depending on the placement of your TV. The noise may be more noticeable during the night or when the background noise level is low.

Disposal of Used Batteries

To preserve our environment, dispose of used batteries according to your local laws or regulations.

Contents

Introducing the TV

Welcome	9
Package Contents.....	9
Features.....	9
Enjoying Your TV	11
Notes on the TV.....	11
Screen.....	11
Indicators.....	12
Projection Lamp.....	12
Installing the TV	13
Carrying Your TV.....	13
Take Precaution during Installation.....	13
Preventing the TV from Toppling Over.....	14
When Installing Your TV against a Wall.....	14
Recommended Viewing Area.....	15
TV Controls and Connectors	16
Front Panel.....	16
Side and Rear Panel.....	18

Connecting the TV

Overview	20
Making Video and Audio Connections.....	20
About Using HDMI to DVI Adapter.....	21
About Using S VIDEO.....	21
Basic Connections	22
Cable System and/or VHF/UHF Antenna System.....	23
HD Cable Box/ HD Satellite Box.....	24
Equipment with DVI Connection.....	25
Satellite Receiver and Cable/Antenna.....	26
Equipment with Digital Audio (Optical).....	27
Setting Up the Channel List	28
Using Initial Setup.....	28
Connecting Optional Equipment	29
VCR and Cable.....	30
VCR and Cable Box.....	31
DVD Player with Component Video Connectors.....	33
DVD Player with S VIDEO and Audio Connectors.....	34

Personal Computer.....	35
Camcorder or Video Game Equipment.....	36
Audio Receiver.....	37

Watching the TV

Overview	38
Inserting Batteries into the Remote Control ..	38
Button Descriptions	39
Programming the Remote Control	41
Using Other Equipment with Your Remote Control	43
Special Buttons on the Remote Control	46
Using the TOOLS Button.....	46
Using the TOOLS Button in PC Mode.....	46
Using the JUMP Button.....	47
Using the FREEZE Button.....	47
Using the GUIDE Button.....	48
Using the WIDE Button.....	49
Using the WIDE Button in PC Mode.....	50
Using the WIDE Button in PC Mode continued.	51

Using the Menus

Overview of MENU	52
Navigating and Selecting Items	54
Using External Inputs in MENU	54
Using Favorites in MENU	54
Using Cable in MENU	55
Using Antenna in MENU	55
Using Settings in MENU	56

Using the Settings

Overview	57
Accessing the Picture Settings	59
Selecting Picture Options.....	59
Accessing the Sound Settings	62
Selecting Sound Options.....	62
Accessing the Screen Settings	64
Selecting Screen Options.....	64
Accessing the Channel Settings	66
Selecting Channel Options.....	66
Accessing the Parental Lock Settings	68

Selecting Parental Lock Options	68
Viewing Blocked Programs	69
Selecting Custom Rating Options	69
Accessing the Setup Settings	71
Selecting Setup Options	71
Programming Caption Vision (CC).....	74

Other Information

Overview.....	75
Contacting Sony	75
Replacing the Lamp.....	76
How to Replace the Lamp.....	76
Troubleshooting	80
Remote Control.....	80
Picture	81
Sound.....	82
Channels.....	82
General	83
PC Input Signal Compatibility Chart.....	85
Specifications	86

Index

Index	88
--------------------	-----------

Introducing the TV

Welcome

Thank you for purchasing this Sony's *HD* LCD projection TV. This manual is for models KDF-42E2000 (US model only), KDF-46E2000, KDF-50E2000 and KDF-55E2000.

Package Contents

Along with your new TV, the packing box contains a remote control and two AA (R6) batteries. See page 87 for the complete list of packaging contents.

Features

Some of the features that you will enjoy with your new TV include:

- ❑ **WEGA Engine:** Delivers superb picture quality from any video source by minimizing the signal deterioration caused by digital-to-analog conversion and stabilizing the signal processing. This engine features unique Sony technology, including:
 - **DRC[®] (Digital Reality Creation)-MF V1:** Unlike conventional line doublers, the DRC Multifunction feature replaces the signal's NTSC waveform with the near-HD equivalent by digital mapping processing. The DRC Palette option lets you customize the level of detail (Reality) and smoothness (Clarity).
- ❑ **Integrated HDTV:** You can watch digital televised programs and enjoy the improved audio/video quality offered by these programs.
- ❑ **Advanced Iris:** Automatically detects the brightness of the screen. By adjusting the iris shutter, this feature can provide you with the best contrast and brightness from one scene to the next for your TV viewing.
- ❑ **MENU:** Sony's unique user interface provides easy access to useful TV functions such as external inputs (switch among connected equipments), favorite channels (create a list of your favorite channels), cable channels (view cable channels), antenna channels (view antenna channels) or to customize your TV settings.
- ❑ **Wide Screen Mode:** Allows you to watch 4:3 normal broadcasts in wide screen mode (16:9 aspect ratio).
- ❑ **CineMotion[®]:** Using the reverse 3-2 pull down technology, the CineMotion feature provides smoother picture movement when playing back movies or other video sources on film.
- ❑ **Parental Control:** Downloadable digital rating and V-Chip technology allows parents to block unsuitable programming from younger viewers.
- ❑ **HDMI (High-Definition Multimedia Interface) Inputs:** Provide an uncompressed, all-digital audio/video interface between this TV and any HDMI-equipped audio/video component, such as a set-top box, Blu-ray Disc™ player, DVD player, and A/V receiver. Your personal

(Continued)

computer can be connected to this TV with HDMI Input (see page 35). HDMI supports enhanced, or high-definition video, plus two-channel digital audio.

- ❑ **Component Video Inputs:** Offers a high-quality video for DVD (480p, 480i) and digital set-top box (1080i, 720p, 480p, 480i) connections.
- ❑ **S VIDEO Inputs:** Provides a high-quality image from connected equipment.
- ❑ **Favorite Channels:** Allows you to navigate a list of up to 16 favorite channels without leaving the current channel.
- ❑ **Steady Sound[®]:** Equalizes volume levels so there is consistent output between programs and commercials.

Enjoying Your TV

To enjoy your TV for years to come and maintain its original picture quality, you should perform periodic maintenance.

Notes on the TV

To enjoy clear picture

- ❑ Prevent sunlight or other light sources from shining directly onto the screen.
- ❑ The screen surface is easily scratched. Do not rub, touch, or tap it with sharp or abrasive objects (see “On Contamination on the Screen Surface” on page 6).

When not using the TV for a long period of time

- ❑ Unplug the AC power cord from the outlet if you anticipate not using the TV for more than a week.

When turning off the power

- ❑ The cooling fan will continue to operate for about two minutes. Allow several minutes before unplugging from the outlet or switching the breaker off.

On moisture condensation

- ❑ If your TV is moved directly from a cold to a warm location or is placed in a humid room, or if the room temperature changes suddenly, the picture may blur or show poor color. This is caused by moisture condensation on the lenses inside. Wait a few hours to let the moisture evaporate before turning on the TV. When the condensation has evaporated, the picture will return to normal.

Screen

To minimize reflection, the screen surface has a special coating. Inappropriate cleaning methods could damage the screen surface. Special care is required.

Cleaning the Screen Surface

Dust and dirt on the screen can affect the picture quality. To dust off the screen use a soft cloth. Be sure to follow the cleaning instruction on page 6 for stubborn stains and dirt.

Temporary Image Retention

When high contrast non-moving images such as station logos and channel numbers are displayed for a long period of time, there may be some image retention on the screen. This is only a temporary condition. Turning off the power for a while or letting the TV run on another channel will eliminate the image retention.

Indicators

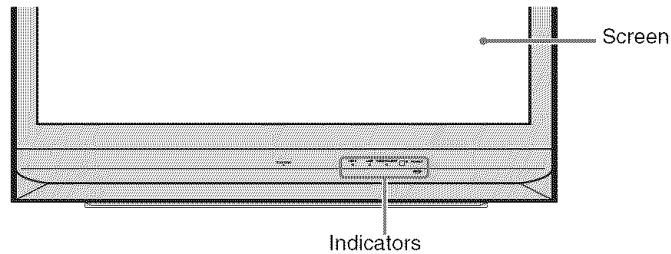

The indicators show the current status of your TV. If there is a change in the condition or a problem with the TV, the indicators will flash or light up in the manner described below to let you know that it requires your attention.

Indicator	Flashing because...
POWER flashing	green : The lamp for the light source is preparing to turn on. When it is ready, the green indicator stays on. red : The lamp door or the lamp is not securely attached. The red indicator will continue to flash in intervals of three blinks at a time until the lamp door or the lamp is placed correctly. When the lamp door or the lamp is securely attached, the TV will turn on with green indicator.
LAMP indicator flashes	The projection lamp has burned out. Replace it with new one (see page 76).
TIMER indicator is lit	When one of the timers is set, the orange indicator will remain lit (will not flash) even when the TV is turned off.

Projection Lamp

How to replace the lamp, see page 76.

Your TV uses a projection lamp as its light source. As with any lamp, it has a lifespan and needs to be replaced when the Lamp indicator flashes or the screen becomes darker. Your TV also has a function to display a message, "Projection lamp is nearing end of life. Please replace the lamp." to let you know that the lamp has reached its expected lifespan. Note the following:

- After turning on your TV, it may take a while (1 minute or less) before the picture appears.
- When the projection lamp wears out, the screen goes dark. Replace the lamp with a new Sony XL-2400 replacement lamp (not supplied).
- After lamp is replaced, please set the "Lamp Replacement" option in the Setup Settings (see page 76 and 73).

⚠ The light emitted from the lamp is quite bright when your TV is in use. To avoid eye discomfort or injury, do not look into the light housing when the power is on.

Installing the TV

Carrying Your TV

Carrying the TV requires at least two people. Do not hold by the pedestal or the front panel of the TV. Doing so may cause these parts to break off.

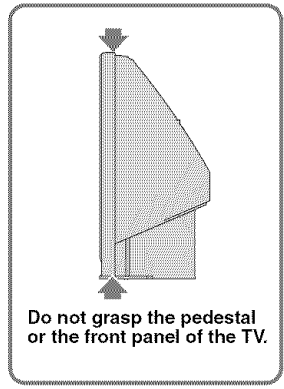

When moving the TV, place one hand in the hole on the lower portion of the TV while grasping the top with the other hand, as shown in the illustration below.

KDF-42/46E2000

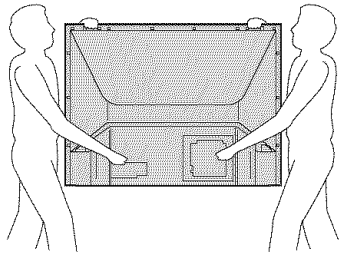

KDF-50/55E2000

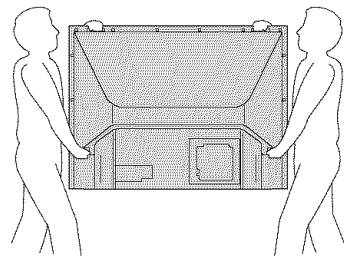

If you have connected cables and cords, be sure to unplug them before moving the TV.

Take Precaution during Installation

To ensure the safety of children and the TV, keep children away from the TV during installation. Climbing on or pushing the TV or its stand may cause it to fall and damage the TV.

Preventing the TV from Toppling Over

As a protective measure, secure the TV as follows.

Using the TV stand with support belts

- ❑ Sony strongly recommends using the TV stand SU-RG11S (for KDF-42E2000)/SU-RG12S (for KDF-46E2000)/SU-RG12L (for KDF-50/55E2000) with a support belt designed for your TV.

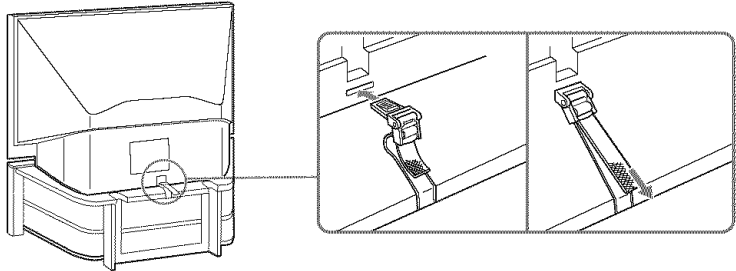

⚠ **When using the SU-RG11S (for KDF-42E2000)/SU-RG12S (for KDF-46E2000)/SU-RG12L (for KDF-50/55E2000) stand for your TV, you must use the support belt.**

When Installing Your TV against a Wall

Keep your TV at least 4 inches (10 cm) away from the wall to provide proper ventilation. Blocking the ventilation opening of the cooling fan may damage the TV.

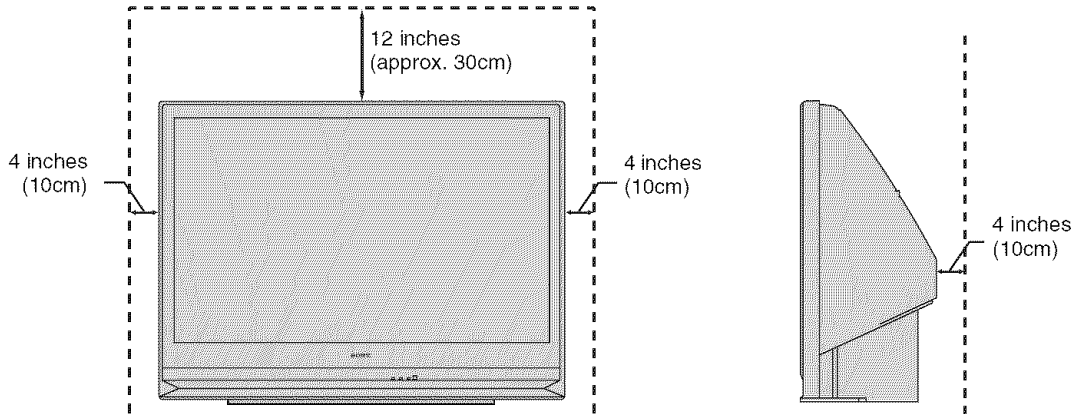

Never install the TV as follows

Air circulation is blocked

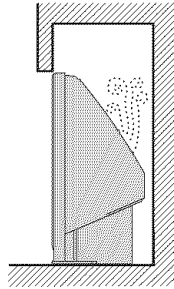

Air blown into cooling fan.

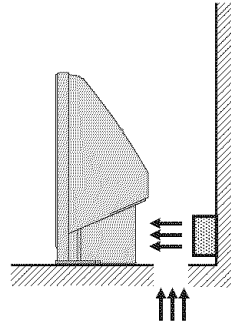

Do not install the TV near any ventilation, as it may affect the normal TV operating temperature.

Recommended Viewing Area

Your viewing position may affect the picture quality.

For the best picture quality, install your TV within the areas shown below.

Model	Viewing distance
KDF-42E2000	min. 5.9 ft. (approx. 1.8 m)
KDF-46E2000	min. 6.2 ft. (approx. 1.9 m)
KDF-50E2000	min. 6.6 ft. (approx. 2.0 m)
KDF-55E2000	min. 6.8 ft. (approx. 2.1 m)

Horizontal Viewing Area

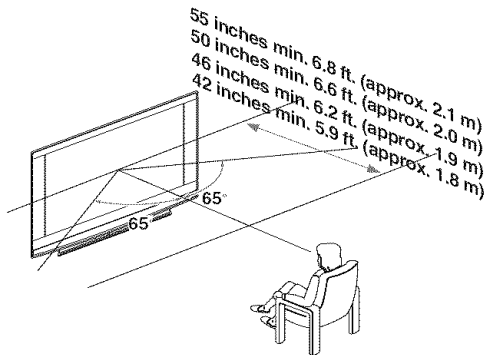



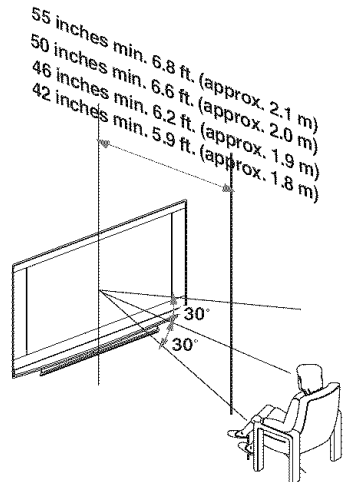





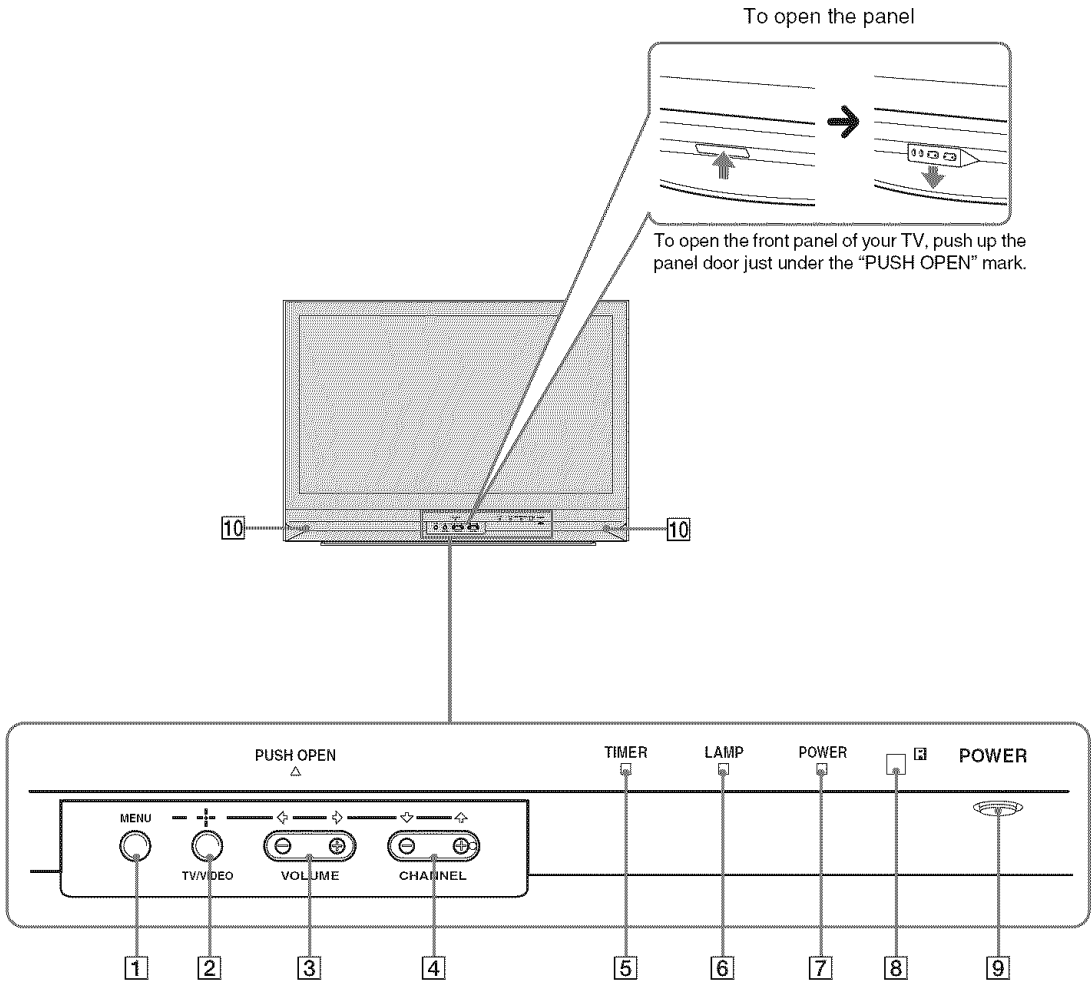

Vertical Viewing Area



TV Controls and Connectors

Front Panel



Item	Description
1 MENU	Press to display MENU to activate the  ,  ,  ,  , and  buttons. Press again to exit MENU to activate the TV/VIDEO, - VOLUME + and - CHANNEL+ buttons.
2  TV/VIDEO	Press to confirm the selection or setting. Press repeatedly to cycle through the video equipment connected to the TV's video inputs.
3  - VOLUME +	Press to adjust the volume.
4  - CHANNEL +	Press to scan through channels. To scan quickly through channels, press and hold either - or +.
5 TIMER LED	When lit in orange, indicates one of the timers is set. When it is set, this LED will remain lit even if the TV is turned off. For details, see page 72.
6 LAMP LED	Flashes in red when the lamp for the light source has burned out. For details, see "Replacing the Lamp" on page 76.
7 POWER	Lights up in green when the TV is turned on. If the LED blinks in red continuously, this may indicate the display unit needs servicing (see contacting Sony information on page 2). When the red LED blinks only three times, the lamp door of the lamp unit or the lamp itself is not securely attached (see page 78).
8  Infrared Receiver	Receives IR signals from the remote control. Do not put anything near the sensor, as its function may be affected.
9 POWER	Press to turn on and off the TV.
10 Speaker	Outputs the audio signal.

 **The CHANNEL + button has a tactile dot. Use the tactile dot as a reference when operating the TV.**

Side and Rear Panel

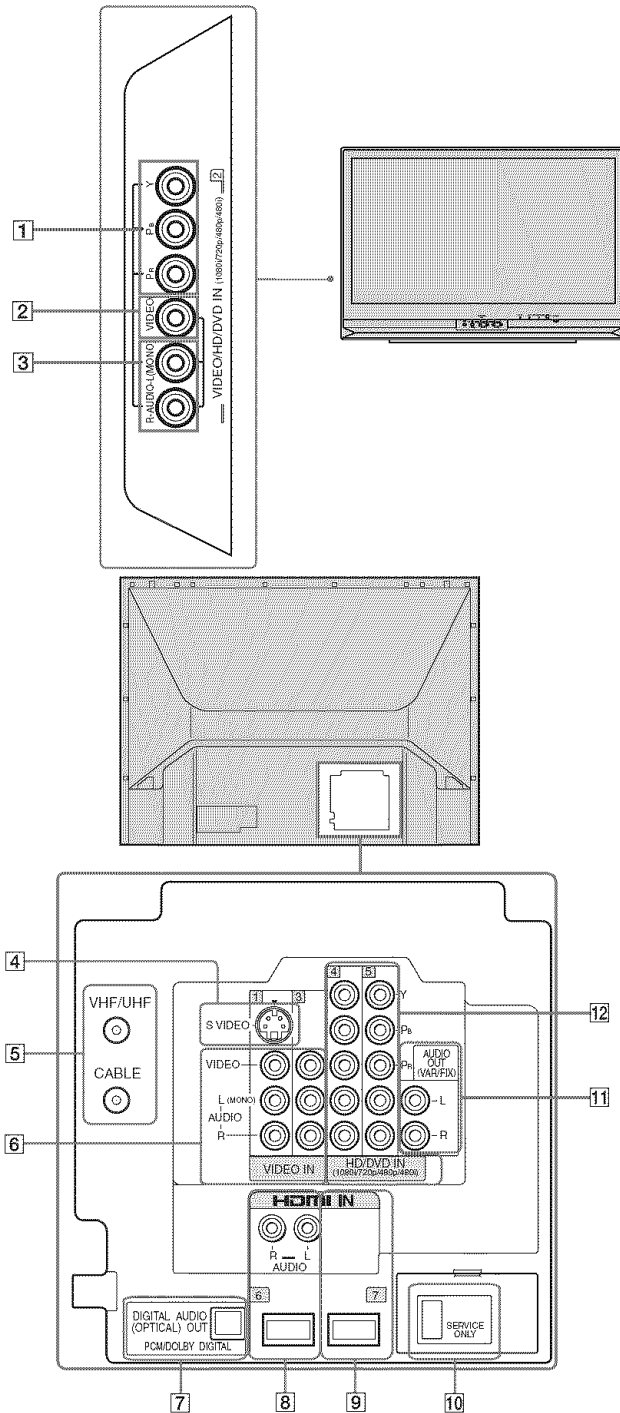

Jack	Description
1 HD/DVD IN 2 (1080i/720p/ 480p/480i)	Connects to your equipment's component video (YPbPr) output jacks. Component video provides better picture quality than the S VIDEO (4) of rear panel) or the composite video (6) of rear panel) connections (see page 19). When Auto is selected for the Video 2 (Component) option in the Setup settings, the component video function will be the default stream when present (see page 73).
2 VIDEO IN 2	Connects to the composite video output jack on your camcorder or other video equipment. When connecting composite video to VIDEO IN 2, be sure to select Video 2 (Component) to Off in the Setup settings to activate both audio and video function for composite connection (see page 73).
3 AUDIO IN 2 L (MONO)/R	Connects to the audio (L/R) output jacks of your equipment such as camcorder or other video equipment which you want an easy access.
4 VIDEO IN 1 S VIDEO	Connects to the S VIDEO output jack of your VCR or other video equipment that has S VIDEO. S VIDEO provides better picture quality than the composite video (6).
5 VHF/UHF CABLE	RF input that connects to your cable and VHF/UHF antenna signal.
6 VIDEO IN 1/3 VIDEO/ L (MONO)- AUDIO-R	Connects to the composite video and audio output jacks on your VCR or other video equipment. A third composite video and audio (VIDEO 2) is located on the left side panel of the TV.
7 DIGITAL AUDIO (OPTICAL) OUT PCM/DOLBY* DIGITAL	Connects to the optical audio input of a digital audio component that is PCM/Dolby Digital compatible.
8 HDMI IN 6 HDMI/ R-AUDIO-L	HDMI (High-Definition Multimedia Interface) provides an uncompressed, all-digital audio/video interface between this TV and any HDMI-equipped audio/video equipment, such as a set-top box, Blu-ray Disc player, DVD player, A/V receiver as well as PC. HDMI supports enhanced, or high-definition video, plus two-channel digital audio. You can also connect a DVI-equipped device to your TV by using an HDMI-to-DVI cable.
9 HDMI IN 7	When HDMI to DVI cable is used to connect your equipment for video, be sure to use audio cable for the sound. See page 35 for connecting to your personal computer.
10 Service Port	For service use only.
11 AUDIO OUT (VAR/FIX) L/R	Connects to the left and right audio input jacks of your audio or video equipment. You can use these outputs to listen to your TV's audio through your stereo system.
12 HD/DVD IN 4/5 (1080i/720p/ 480p/480i)/ L-AUDIO-R	Connects to your equipment's component video (YPbPr) and audio (L/R) jacks. Component video provides better picture quality than the S VIDEO (4) or the composite video (6) connections.

* Manufactured under license from Dolby Laboratories. "Dolby" and the double-D symbol are trademarks of Dolby Laboratories.

Connecting the TV

Overview

For optimum picture performance, your new LCD Projection TV is capable of receiving high definition programming through its integrated tuner. It is also capable of receiving HDTV content from a cable or satellite box via the video inputs (HDMI and YPBPR component video; see page 24).

To display clear, crisp pictures, your TV must be connected properly. To properly connect your TV, follow the basic connections provided in this section. Advanced connection examples are provided in the separate Quick Setup Guide accompanied with your TV. The Quick Setup Guide provides a variety of optional equipment connection diagrams.

It is strongly recommended that you connect the antenna/cable input using the 75-ohm coaxial cable to receive optimum picture quality. A 300-ohm twin lead cable can be easily affected by radio frequency, resulting in signal deterioration.





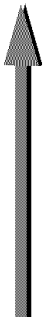

When the antenna/cable connection is done, you must perform an Initial Setup so your TV will create a list of channels you can view (see page 28). After you can receive and view programming you should select the proper Wide Mode setting to display the picture in your preferred aspect ratio. See "Changing the Wide Screen Mode" on pages 49-51.

Making Video and Audio Connections

Below are different types of video connectors available these days. Your TV comes with all types of connectors with the exception of the DVI connector but your cable box or satellite receiver may be equipped with this type. When connecting your TV, use the inputs that are available on your devices that provide the best video performance, as described below.

Best Video Performance



	Connector type	Separate audio connection required
	HDMI (High-Definition Multimedia Interface)	No
	DVI (Digital Visual Interface) *	
	Component video (480i/480p/720p/1080i)	Yes 
	S VIDEO	
	Composite video	
	RF/Coaxial	No

* An adapter is necessary when you are connecting a DVI-equipped device to this TV (see page 21).

About Using HDMI to DVI Adapter

If you are connecting equipment with DVI connector with this TV, you will need to use an adapter. You can use an HDMI-to-DVI cable or an HDMI adapter (not supplied). Both are available from your local electronics store. When you use the adapter, you will also need to use separate audio cables for sound as DVI connector is for video signals only.



HDMI-to-DVI cable

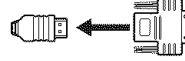

HDMI adapter



Audio cable

About Using S VIDEO



If the optional equipment you are connecting has an S VIDEO jack (shown at left), you can use an S VIDEO cable for improved picture quality (compared to an A/V cable). Because S VIDEO carries only the video signal, you also need to connect audio cables for sound, as shown below.

Example of an S VIDEO Connection

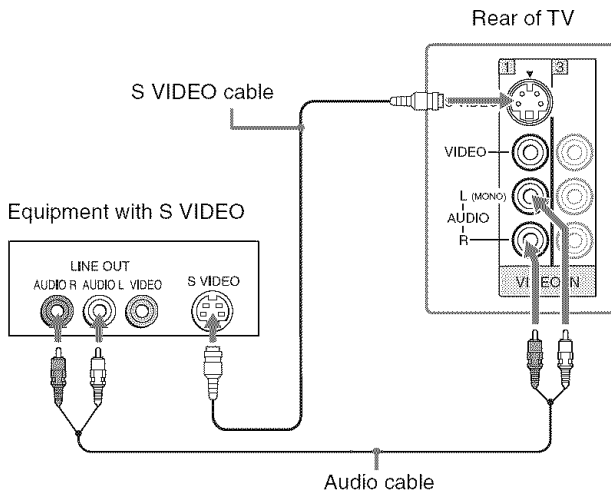

Cables are often color-coded to connectors. Connect red to red, white to white, etc.

Basic Connections

The way in which you connect your TV will vary, depending on how your home receives a signal (antenna and satellite; cable and cable box) and whether or not you plan to connect a VCR.

<i>If You Are Connecting</i>	<i>See Page</i>
<i>Cable System and/or VHF/UHF Antenna System</i>	23
<i>HD Cable Box/ HD Satellite Box</i>	24
<i>Equipment with DVI Connection</i>	25
<i>Satellite Receiver and Cable/Antenna</i>	26
<i>Equipment with Digital Audio (Optical)</i>	27

If you are connecting a VCR

- See the connections described on pages 30 and 31.

Cable System and/or VHF/UHF Antenna System

Connecting a cable system and/or an external VHF/UHF antenna to the VHF/UHF input and or CABLE will allow you to enjoy high definition and standard definition digital programming (if available in your area) along with the standard definition analog programming

This TV is capable of receiving unscrambled digital programming for both cable (QAM and 8VSB) and external VHF/UHF antenna (ATSC).

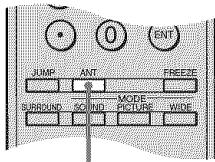

ANT button

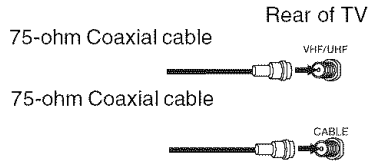

To switch between the VHF/UHF (antenna) input and the CABLE input, press the ANT button on the remote control.

Do not use an indoor antenna, which is especially susceptible to radio noise.

HD Cable Box/ HD Satellite Box

💡 The HDMI jack provides both video and audio signals, so it is not necessary to connect an audio cable.

You can also enjoy high definition programming by subscribing to high definition cable service or high definition satellite service. For the best possible picture, connect these components to your TV via the HDMI or component video (with audio) input on the back of your TV.

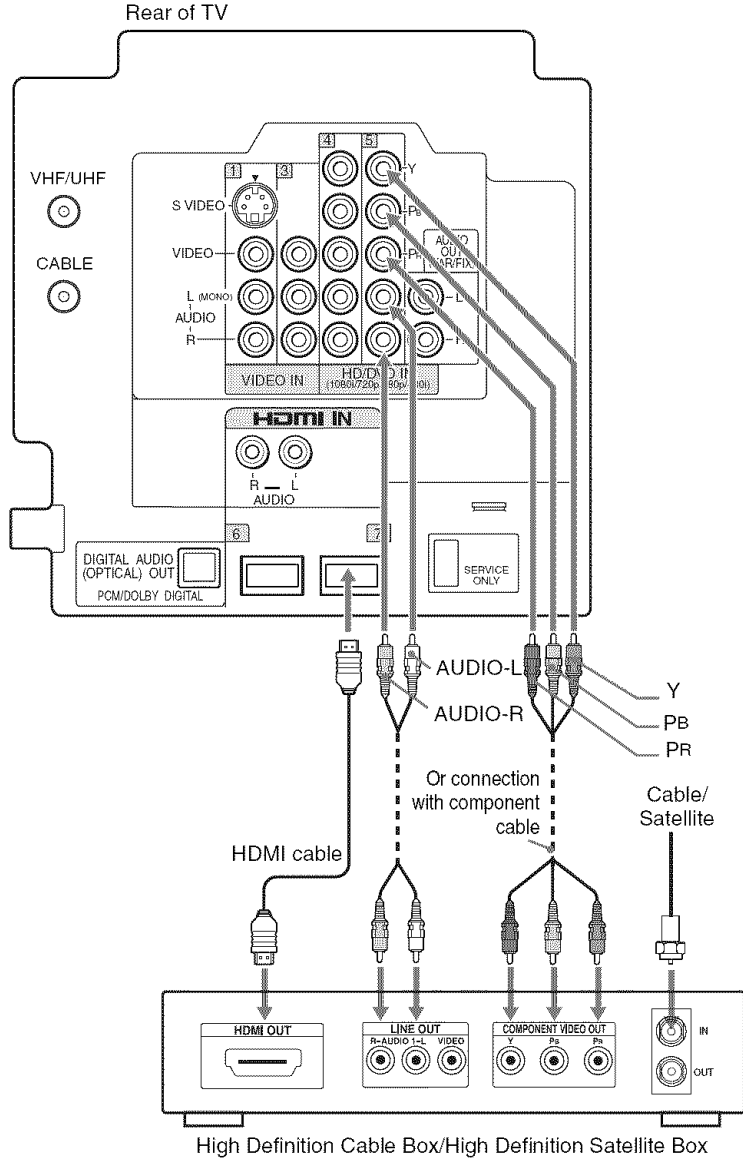

🔗 **Component video (YPBPR) or HDMI connection is necessary to view 480i, 480p, 720p and 1080i formats. Note that this TV displays all format types of picture in TV's panel resolution of 1,280 × 720.**

Equipment with DVI Connection

Cables are often color-coded to connectors. Connect red to red, white to white, etc.

💡 When connecting to a DVI output, audio cable must be used simultaneously for the audio signal. DVI carries video signal only.

Disconnect all power sources before making any connections.

If you are connecting with DVI-HDTV output, you can connect to the TV's HDMI IN (Video 6) jack by using an HDMI-to-DVI cable or an adapter (both not supplied).

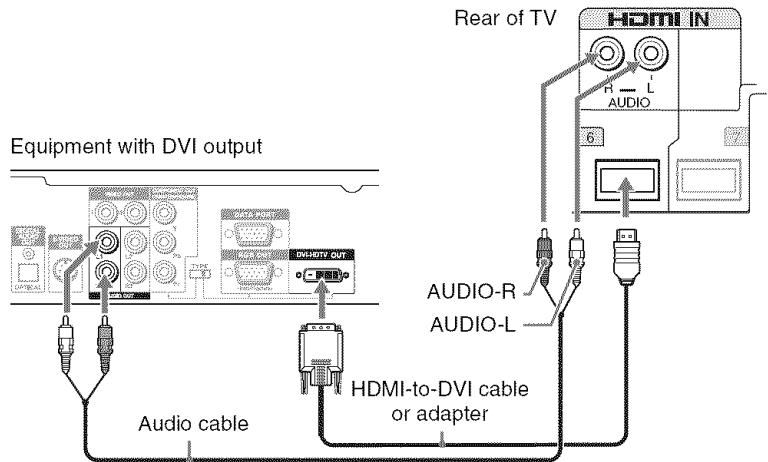

⚠️ When using a HDMI-to-DVI cable or an adapter, be sure to connect the DVI output connector first; then connect to the HDMI input on your TV.

Satellite Receiver and Cable/Antenna

- SAT signals are selected by the SAT Box connected to the VIDEO INPUT. TV signals are selected from the signal connected to the CABLE input.

Disconnect all power sources before making any connections.

- 1** Connect the satellite antenna cable to the satellite receiver's SATELLITE IN jack.
- 2** Use A/V and S VIDEO cables to connect the satellite receiver's AUDIO and S VIDEO OUT jacks to the TV's AUDIO and S VIDEO IN jacks.
- 3** Use a coaxial cable to connect your cable to the TV's CABLE jack, or your antenna to the TV's VHF/UHF jacks.

⚠ If your satellite receiver is not equipped with S VIDEO, use a VIDEO cable (yellow) instead of the S VIDEO cable.

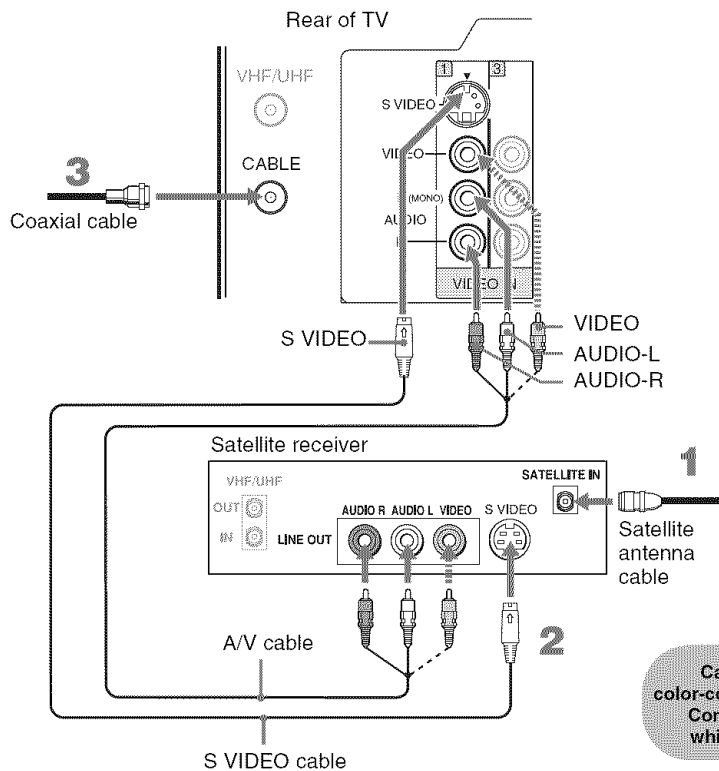

**Equipment with
Digital Audio
(Optical)**

Disconnect all power sources before making any connections.

You can use the TV's DIGITAL AUDIO (OPTICAL) OUT jack to connect a digital audio device that is PCM/Dolby Digital compatible, such as an audio amplifier.

Using an optical audio cable, connect the device's OPTICAL IN jack to the TV's DIGITAL AUDIO (OPTICAL) OUT jack.

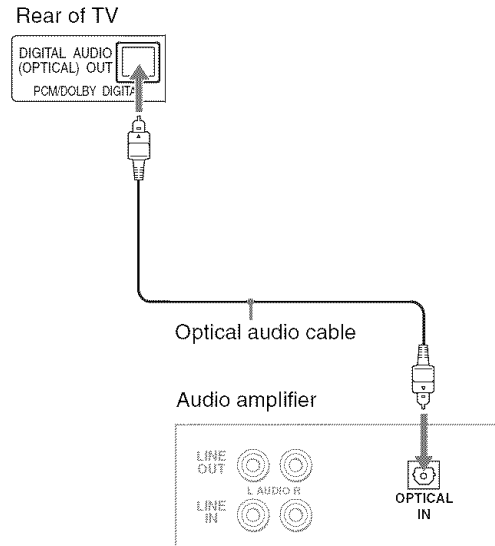







Setting Up the Channel List

After you finish connecting the TV, you can run the Initial Setup to create a list of available analog and digital channels. The Initial Setup screen appears when you turn on the TV for the first time after hooking it up. If you choose to set up the channels at a later time, select the Auto Program option to scan available channels (see page 66).

The Auto Program setup in the initial setup does not apply for installations that use a cable box for all channel selection.

Using Initial Setup

To run Initial Setup the first time you turn on your TV

- 1 Press  to turn on the TV.
The Initial Setup screen appears.
- 2 Press  or  to highlight the on-screen display language. Then press . The message “First please connect cable and/or antenna” appears. This may require 50+ minutes for completion and “Start auto program now?” appears.
- 3 Press  or  to highlight “Yes” then press .

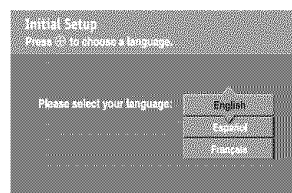

Auto Program performed through Initial Setup will automatically create a list of receivable channels from both VHF/UHF antenna and cable TV channels if both sources are connected.

Auto Program may take a while (20 to 50 minutes) to complete. A progress bar is displayed while available channels are being scanned. If you cancel the Auto Program before all receivable channels are scanned, you may want to perform the task later (see “To run Auto Program at a later time” below).

If you selected “No” during the Initial Setup, the Initial Setup message will appear each time you turn on the TV as a reminder until you complete the Auto Program.

To run Auto Program at a later time

- 1 Select Settings in MENU, and then go to Channel settings.
- 2 Select Auto Program then select Start.

Auto Program will create a list of receivable channels for the current input (VHF/UHF antenna or CABLE). You will be required to run Auto Program for each RF input to create a list of available channels from both inputs.

Connecting Optional Equipment

You can connect a variety of optional equipment to your TV. This section provides some of the individual connections you can make. For multiple connections, please refer to the Quick Setup Guide.

<i>If You Are Connecting</i>	<i>See Page</i>
VCR and Cable	30
VCR and Cable Box	31
DVD Player with Component Video Connectors	33
DVD Player with S VIDEO and Audio Connectors	34
Personal Computer	35
Camcorder or Video Game Equipment	36
Audio Receiver	37

VCR and Cable

Use this hookup if:

- You have cable TV that does not require a cable box.

Disconnect all power sources before making any connections.

- 1** Connect the CATV cable to the single (input) jack of the splitter.
- 2** Use a coaxial cable to connect one of the output jack of the splitter to the TV's CABLE jack.
- 3** Use a coaxial cable to connect the splitter's other output jack to the VCR's input jack.
- 4** Use A/V and S VIDEO cables to connect the VCR's AUDIO and S VIDEO OUT jacks to the TV's AUDIO and S VIDEO IN jacks.

If your VCR is not equipped with S VIDEO, use a VIDEO cable (yellow) instead of the S VIDEO cable.

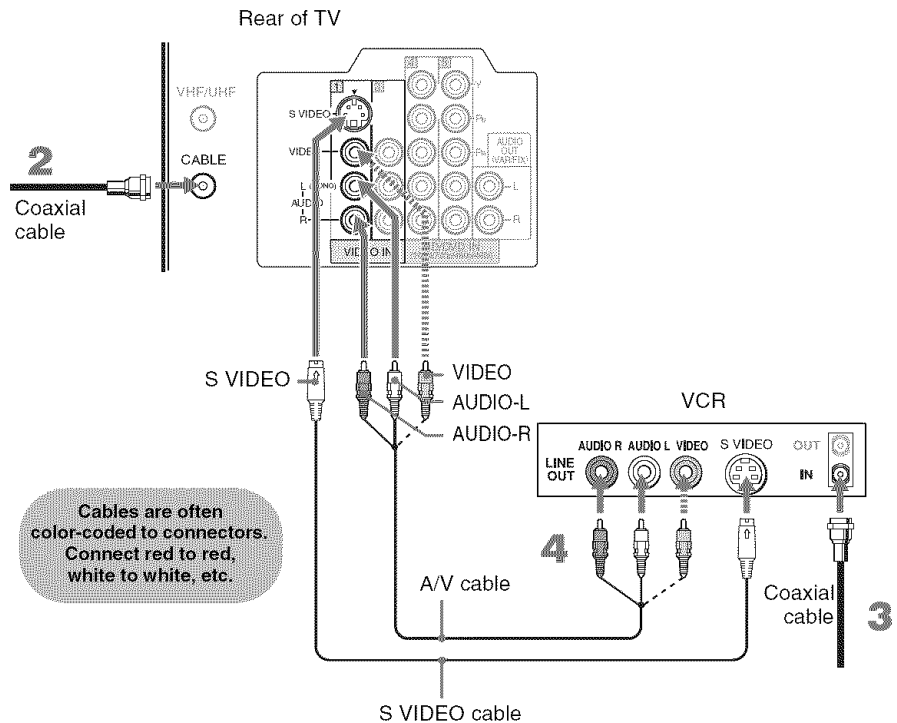

VCR and Cable Box

Use this hookup if:

- ❑ Your cable TV company scrambles some channels, but not all of them (pay channels vs. regular cable channels) and you need to use a cable box.

With this connection you can:

- ❑ Use the TV's remote control to change channels on your cable box when the signal is scrambled. To program your Sony remote control to operate your cable box, see "Programming the Remote Control" on page 41.
- ❑ Use the TV's remote control to change channels on your TV when the signal is not scrambled. Your TV's tuner provides a better picture quality than the output of your cable box.

Disconnect all power sources before making any connections.

- 1** Connect the CATV cable to the single (input) jack of the splitter.
- 2** Use a coaxial cable to connect one of the output jack of the splitter to the TV's CABLE jack.
- 3** Use a coaxial cable to connect the splitter's other output jack to the cable box's input jack.
- 4** Use a coaxial cable to connect the cable box's output jack to the VCR's RF input jack.
- 5** Use an A/V cable to connect the cable box's A/V output jacks to the TV's A/V input jacks.
- 6** Use an A/V and S VIDEO cables to connect the VCR's AUDIO and S VIDEO OUT jacks to the TV's AUDIO and S VIDEO IN jacks.

 **If your VCR is not equipped with S VIDEO, use a VIDEO cable (yellow) instead of the S VIDEO cable.**

- 7** Run Initial Setup, as described in "Setting Up the Channel List" on page 28.

 **To view scrambled channels, tune the TV to the channel the cable box is set to (usually channel 3 or 4) and then use the cable box to switch channels.**

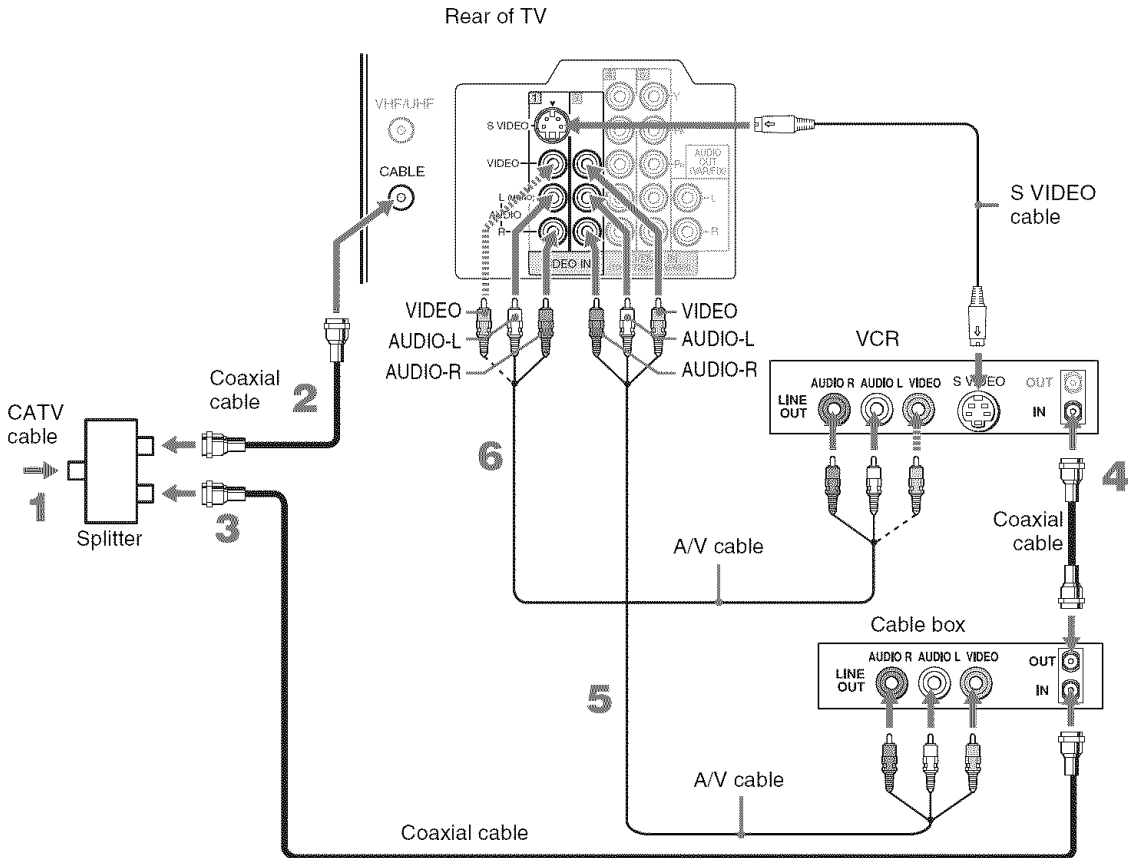

Cables are often color-coded to connectors. Connect red to red, white to white, etc.

If you are connecting a digital cable box, you will need a special bi-directional splitter designed to work with your cable box.

DVD Player with Component Video Connectors

Use this hookup if:

- Your DVD player has component (YP_BPr) jacks.

Disconnect all power sources before making any connections.

- 1** Use a component video cable to connect the DVD player's YP_BPr jacks to the TV's YP_BPr jacks. Use the HD/DVD IN 4 or 5 input.

The YP_BPr jacks on your DVD player are sometimes labeled YC_BCr, or Y, B-Y and R-Y. If so, connect the cables to like colors.

- 2** Use an audio cable to connect the DVD player's AUDIO OUT jacks to the TV's AUDIO IN jacks. Be sure to use the same row of inputs that you used for the video connection (HD/DVD IN 4 or 5).

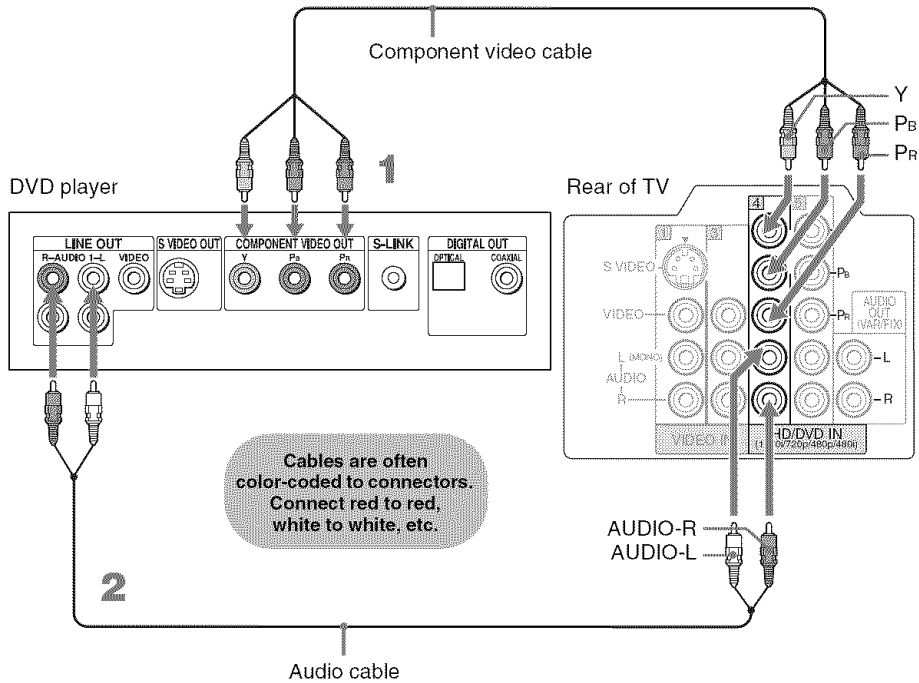

To take advantage of the Wide Mode feature, set the DVD player's aspect ratio to 16:9. For details, refer to the operating instructions supplied with your DVD player.

DVD Player with S VIDEO and Audio Connectors

Use this hookup if:

- Your DVD player does not have component (YPbPr) jacks.

Disconnect all power sources before making any connections.

- 1** Use an A/V cable to connect the DVD player's AUDIO OUT jacks to the TV's AUDIO IN jacks.
- 2** Use an S VIDEO cable to connect the DVD player's S VIDEO jack to the TV's S VIDEO jack.

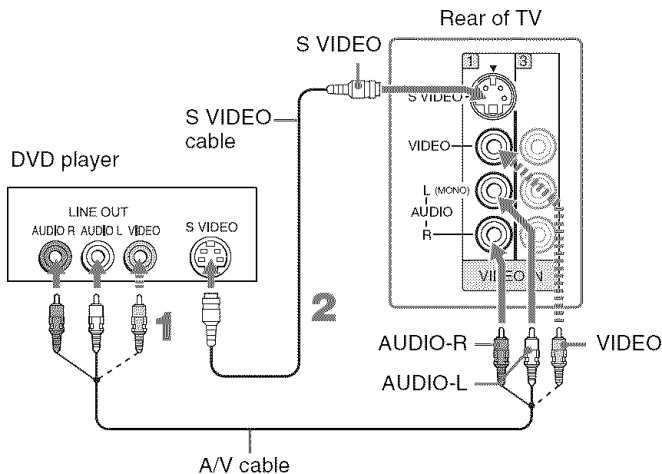

- ✎ If your DVD player is not equipped with S VIDEO, use a VIDEO cable (yellow) instead of the S VIDEO cable.
- ✎ To watch a DVD, press TV/VIDEO repeatedly to select the DVD input (VIDEO 1 in the illustration). If you have a non-Sony DVD player and want to set up the TV remote control to operate it, you must program the remote control. See "Programming the Remote Control" on page 41.
- ✎ To control DVD functions with the TV remote control, see "Operating a DVD Player or DVD Changer" on page 43.
- ✎ To easily identify equipment connected to the TV, see the instructions for setting up Label Video Inputs on page 71.

Personal Computer

If you want to use your TV as your computer monitor, you can connect your PC to the TV.

To connect a PC (personal computer)

You have a choice of connecting PC to the TV's HDMI 6 Input or HDMI 7 Input (only with HDMI connection). HDMI-to-DVI cable will carry digital video from your PC to TV. To listen to audio from your PC, you will need to connect audio cable.

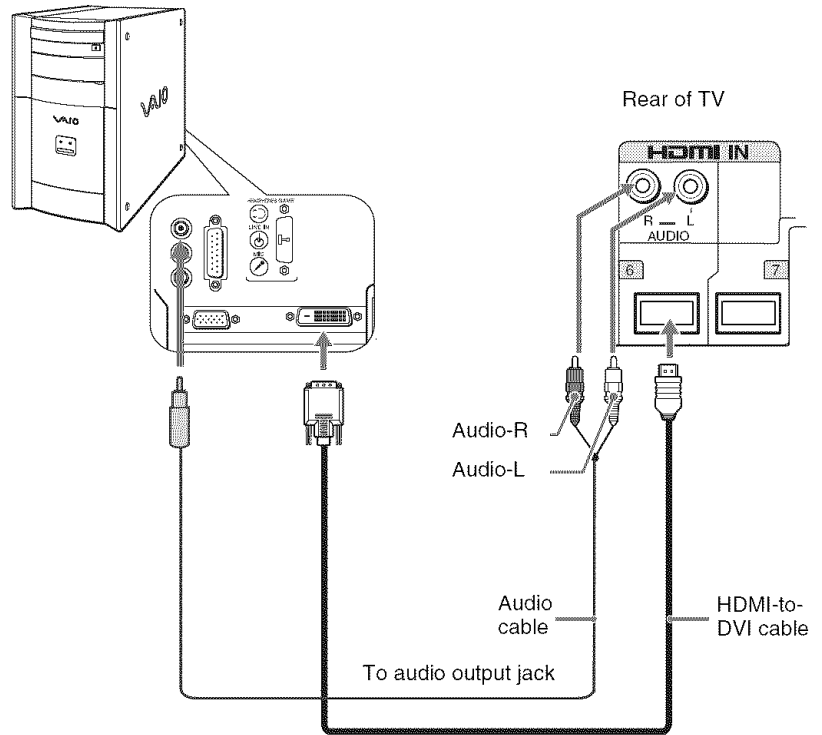

Camcorder or Video Game Equipment

You can connect a camcorder or Video Game Equipment to your TV. For easy connection, use VIDEO IN 2 on the left side of the TV. To use the S VIDEO jack instead of the VIDEO jack (yellow), use VIDEO IN 1 on the rear panel of the TV.

To connect a camcorder or Video Game Equipment to VIDEO IN 1

Use A/V and S VIDEO cables to connect the AUDIO and S VIDEO OUT jacks on the camcorder or Video Game Equipment to the AUDIO and S VIDEO IN jacks on the rear panel of the TV, as shown below.

To connect a camcorder or Video Game Equipment to VIDEO IN 2

Select Off in the Video 2 (Component) option in the Setup settings (see page 73). Use an A/V cable to connect the A/V output jacks on the camcorder or Video Game Equipment to the A/V input jacks on the left side of the TV.

- ⚠ If your camcorder is not equipped with S VIDEO, use a VIDEO cable (yellow) instead of the S VIDEO cable.
- ⚠ If you have a mono camcorder, connect its audio output jack to the TV's L MONO audio input jack.

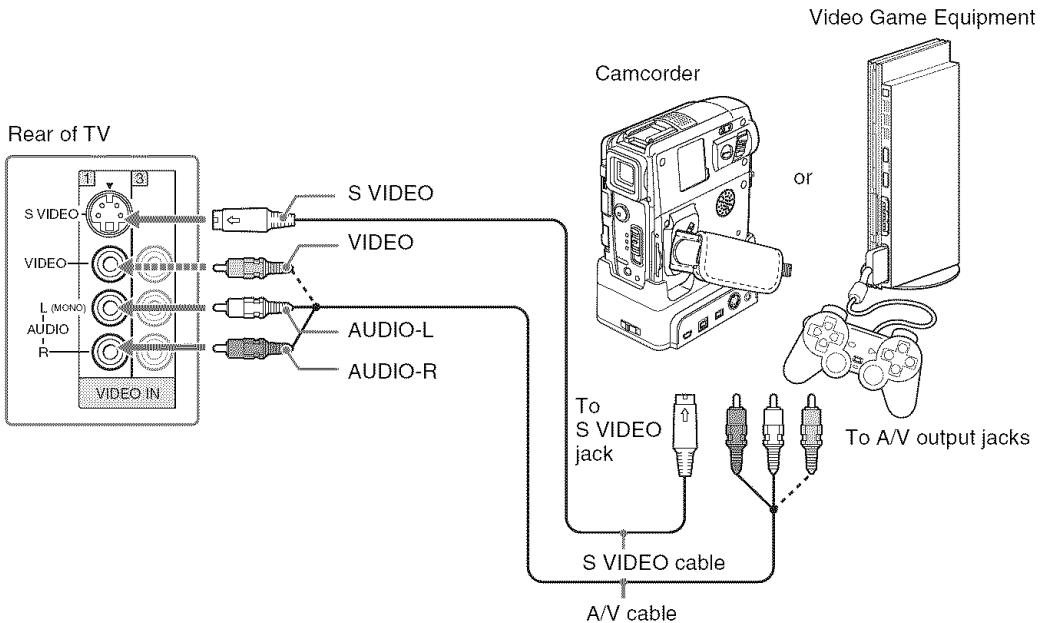

Audio Receiver

For improved sound quality, you may want to play the TV's audio through your stereo system (see page 63).

Disconnect all power sources before making any connections.

Using an audio cable, connect the TV's AUDIO OUT (VAR/FIX) jacks to the audio receiver's audio LINE IN jacks.

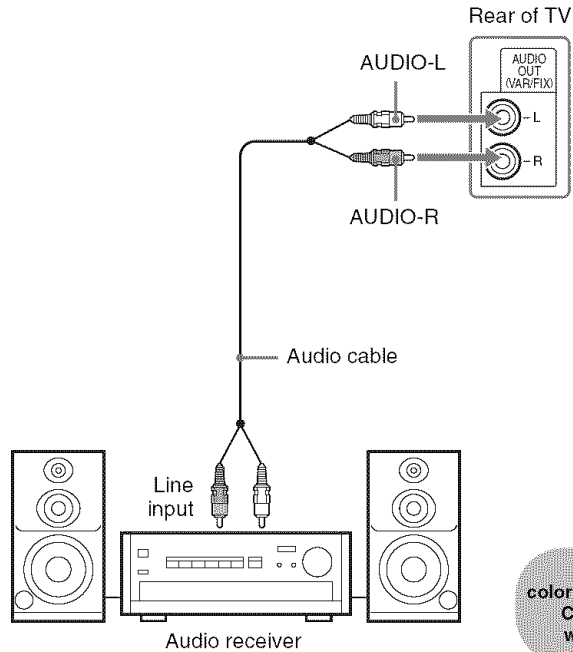

Cables are often color-coded to connectors. Connect red to red, white to white, etc.

Watching the TV

Overview

The table on the next page describes the buttons on the remote control.

Topic	Page
Inserting Batteries into the Remote Control	38
Button Descriptions	39
Programming the Remote Control	41
Manufacturer's Codes	42
Using Other Equipment with Your Remote Control	43
Special Buttons on the Remote Control	46

Inserting Batteries into the Remote Control

Insert two size AA (R6) batteries (supplied) by matching the \oplus and \ominus on the batteries to the diagram inside the battery compartment.

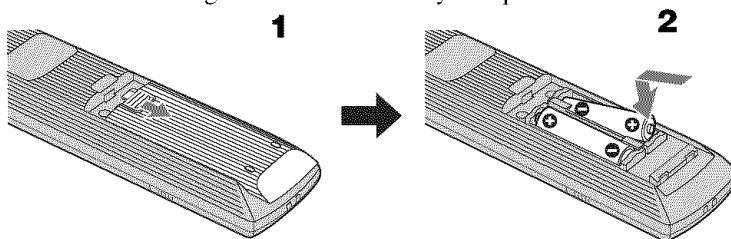

- ⚠ To avoid possible damage from battery leakage, remove the batteries if you anticipate the remote control will not be used for an extended period.
- ⚠ Handle the remote control with care. Avoid dropping it, getting it wet, or placing it in direct sunlight, near a heater, or in high humidity.
- ⚠ Your remote control can be programmed to operate most video equipment. (See “Programming the Remote Control” on page 41.)

Button Descriptions

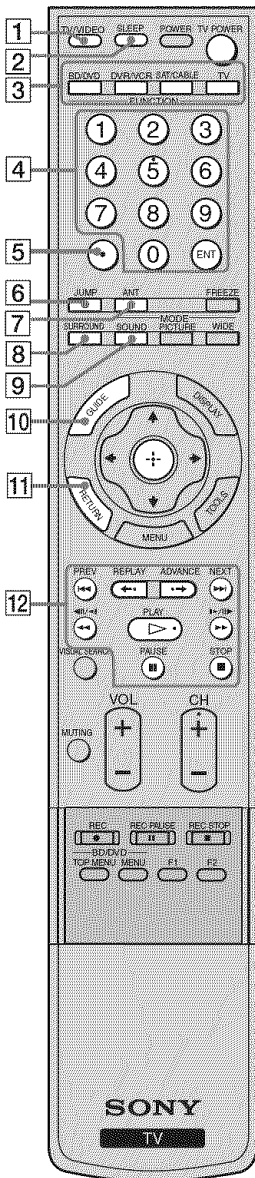

Button	Description
1 TV/VIDEO	Press to cycle through the video equipment connected to your TV's video inputs.
2 SLEEP	Press repeatedly to select the desired amount of time (Off, 15 minutes, 30 minutes, 45 minutes, 60 minutes, 90 minutes or 120 minutes) before TV turns off automatically.
3 FUNCTION Buttons	The FUNCTION button indicator lights up momentarily when pressed to show which external equipment the remote control is operating. When the remote control is set to operate the external equipment, these buttons will operate the equipment you choose. You must first press one of these FUNCTION buttons to operate the corresponding equipment. See page 41 for Programming the Remote Control.
4 0-9, ENT	Press 0-9 to select a channel: the channel changes after 2 seconds. Press ENT to change channels immediately.
5	Use with the 0-9 and ENT buttons to select digital channels (for example, 2.1).
6 JUMP	Press to jump back and forth between two channels. The TV alternates between the current channel and the last channel that was selected with buttons described above in 4 and 5 .
7 ANT	Press to change between the VHF/UHF (antenna) input and the CABLE input.
8 SURROUND	Press to select TruSurround XT audio effect or Off to turn this feature off.
9 SOUND	Press to cycle through different sound settings: Dynamic for enhanced treble and bass, Standard for spoken dialog and Custom for flat setting.
10 GUIDE	Press to display the TV's program guide.
11 RETURN	Press RETURN to either close the menu screen or move back to previous layer if you are in the multilayer menu item.
12 BD/DVD, DVD/VCR Operating Buttons	When FUNCTION is switched on BD (Blu-ray Disc)/DVD or DVR/VCR, these buttons operate the video equipment you have programmed into the remote control. For details, see "Using Other Equipment with Your Remote Control" on page 43. PREV : Press to replay the current program from the previous Chapter Mark (if any) or from the beginning of the live TV cache. REPLAY : Press to replay the current program for a set period of time. ADVANCE : Press to advance forward a set period of time when playing back a recorded program. NEXT : Press to advance forward to the next Chapter Mark (if any) or to live TV when playing back a recorded program. (fast reverse) : Press to play a program in fast rewind mode. PLAY : Press to play a program at a normal speed. (fast forward) : Press to play a program in fast forward mode. PAUSE : Press to pause playback. STOP : Press to stop the playback of a recorded program.

The 5 button, CH + button and PLAY button have a tactile dot. Use the tactile dot as a reference when operating the TV.

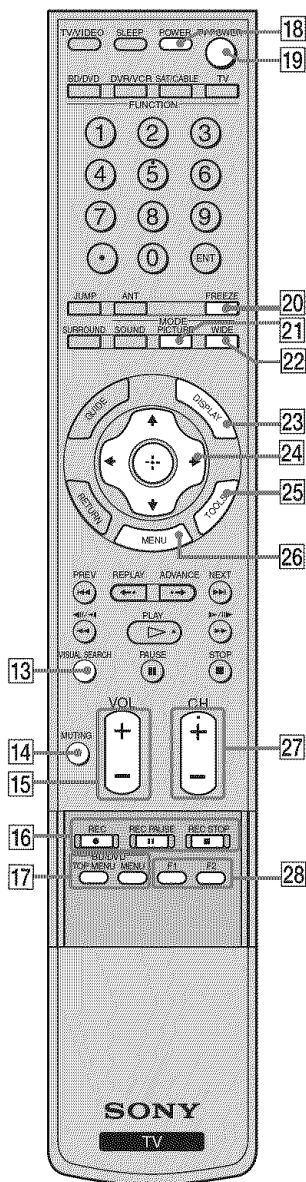

Button	Description
13 VISUAL SEARCH	To be used only with your connected external equipment with visual search function. (Non-operable button for TV)
14 MUTING	Press to mute the sound. Press again or press VOL + to unmute.
15 VOL +/-	Press to adjust the volume.
16 DVD/VCR Record Buttons	<ul style="list-style-type: none"> ● REC: Press to record. Pressing this button alone starts the recording process. ■ REC PAUSE: Press to pause the recording. ■ REC STOP: Press to stop the recording.
17 BD/DVD TOP MENU/MENU	Press to display the top menu or menu. <ul style="list-style-type: none"> For more information, refer to the operating manual of the connected equipment.
18 POWER	Press to turn on/off the external equipment selected from the FUNCTION buttons [3].
19 TV POWER	Press to turn on/off the TV.
20 FREEZE	Press to freeze the current picture. Press again to restore the picture. For details, see "Using the FREEZE Button" on page 47.
21 PICTURE	Press repeatedly to cycle through the available video picture modes: Vivid, Standard, Custom. The video picture modes can be also accessed in the Video menu. For details, see "Selecting Picture Options" on page 59.
22 WIDE	Press repeatedly to step through the Wide Screen Mode setting. The Wide Screen Mode setting can be also accessed in the Screen setting. For details, see "Using the WIDE Button" on page 49 and Wide Screen Mode for PC input on page 49.
23 DISPLAY	Press once to display channel number, label, current time and other information. Press again to turn Display off. See page 72 for details on setting the time.
24 ↑/↓/←/→ (+)	Press ↑/↓/←/→ to move the on-screen cursor. To select an item, press (+).
25 TOOLS	Press to access Tools menu with commonly used options such as: Picture Mode, Sound Mode, Wide Mode, Add to Favorites, Caption Vision (CC) and Alternate Audio.
26 MENU	Press to access the following with the MENU: <ul style="list-style-type: none"> • Watch TV (see page 55). • Select channels from the Favorite Channels you stored (see page 54). • View signals from external equipment such as DVD, VCR and others (see page 54). • Adjust or customize TV settings (see Using the Settings on page 57).
27 CH +/-	Press to scan through channels. To scan quickly through channels, press and hold down either +/- button.
28 F1/F2	Press to select the function of connected components. For details, see "Using Other Equipment with Your Remote Control" on page 43.

Programming the Remote Control

The remote control is preset to operate Sony brand video equipment.

Sony Equipment	Programmable Code Number
BD (Blu-ray Disc)/DVD	101
DVR/VCR	901 (Sony Dream System)
SAT/CABLE	801 (Sony Satellite Receiver)

Follow the steps below to program your TV's remote control to operate non-Sony video equipment.

Find the three-digit code for your equipment from the "Manufacturer's Codes" listed on page 42. If more than one code number is listed, try entering from the code listed first.

1 Press and hold the , or FUNCTION button you want to program on the remote control and press the button simultaneously. The selected FUNCTION button (BD/DVR, VCR/DVD or SAT/CABLE) will flash.

2 Enter the three-digit manufacturer's code number using the buttons while FUNCTION button is lit. If the code is not entered within 10 seconds, you must start from step 1 again.

3 Press the button. When the programming is correct, the selected FUNCTION button flashes twice. When not correct, the button flashes five times.

While , and buttons are labeled as such, you can still program any of your connected equipment using any one of the buttons regardless of the label. For example, button can be programmed to operate your VCR. If you have a DVD/VCR combo that you want to operate with your TV remote control, you can program with the or or even the , but remember which button you have programmed for your particular use.

To check if the code works

Aim your TV's remote control at the equipment, and press the green button. If the equipment turns on and off, the programming is completed. If not, try the next code listed.

If no code is input within the above specified time, or an invalid or incorrect code number is input, the remote control automatically goes back to the previous setting.

In some cases, you may not be able to program your remote control to operate other equipment. In such cases, use the equipment's own remote control.

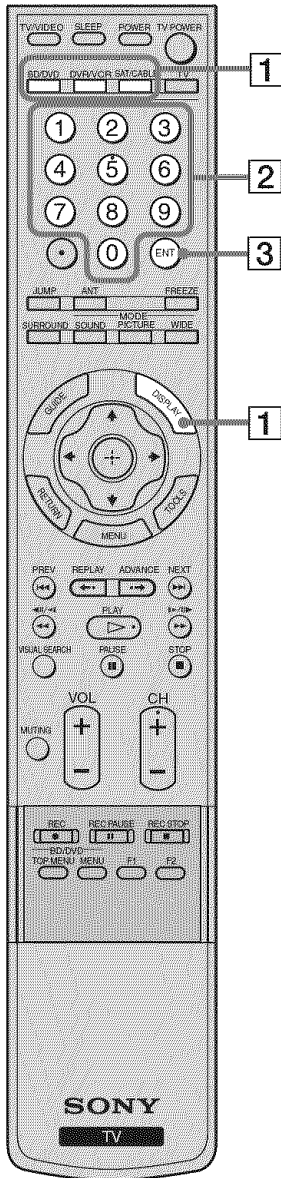

Manufacturer's Codes

DVD Players

Manufacturer	Code
Sony	751, 763
General Electric/RCA	755
Hitachi	758
JVC	756
Magnavox	757
Mitsubishi	761
Oritron	759
Panasonic	753
Philips	757
Pioneer	752, 778
RCA/PROSCAN	755
Samsung	758
Toshiba	754
Zenith	760, 762

DVD/VCR Combo Units

Manufacturer	Code
Sony	767
Broksonic	776
JVC	775
Panasonic	777
Samsung	774
Toshiba	773
Zenith	768

HDD/DVD Combo Units

Manufacturer	Code
Sony	772, 771, 770

DVD Changers

Manufacturer	Code
Sony	765
Panasonic	766

DVR

Manufacturer	Code
Sony	901

Blu-ray Disc Player (BD)

Manufacturer	Code
Sony	101, 102, 103

5.1ch DVD AV System

Manufacturer	Code
Sony (DAV)	601, 602, 603, 604

AV Receivers

Manufacturer	Code
Sony	764

VCRs

Manufacturer	Code
Sony	301, 302, 303 (VHS, 8mm, Beta)

Manufacturer	Code
Sony DV	348
Admiral (M. Ward)	327
Aiwa*	338, 344
Audio Dynamic	314, 337
Broksonic	319, 317
Canon	309, 308
Citizen	332
Craig	302, 332
Curtis Mathes	304, 338, 309
Daewoo	341, 312, 309
DBX	314, 336, 337
Dimensia	304
Emerson	319, 320, 316, 317, 318, 341
Fisher	330, 335
Funai	338
General Electric	329, 304, 309
Go Video	322, 339, 340
Goldstar	332
Hitachi	306, 304, 305, 338
Instant Replay	309, 308
JC Penney	309, 305, 304, 330, 314, 336, 337
JVC	314, 336, 337, 345, 346, 347
Kenwood	314, 336, 332, 337
LG	332
LXI (SEARS)	332, 305, 330, 335, 338
Magnavox	308, 309, 310
Marantz	314, 336, 337
Marta	332
Memorex	309, 335
Minolta	305, 304
Mitsubishi/MGA	323, 324, 325, 326
Multitech	325, 338, 321
NEC	314, 336, 337
Olympic	309, 308
Optimus	327
Orion	317
Panasonic	308, 309, 306, 307
Pentax	305, 304
Philco	308, 309
Philips	308, 309, 310
Pioneer	308
Quasar	308, 309, 306
RCA/PROSCAN	304, 305, 308, 309, 311, 312, 313, 310, 329
Realistic	309, 330, 328, 335, 324, 338
Sansui	314

Manufacturer	Code
Samsung	322, 313, 321
Sanyo	330, 335
Scott	312, 313, 321, 335, 323, 324, 325, 326
Sharp	327, 328
Signature 2000 (M. Ward)	338, 327
SV2000	338
Sylvania	308, 309, 338, 310
Symphonic	338
Tashiro	332
Tatung	314, 336, 337
Teac	314, 336, 338, 337
Technics	309, 308
Toshiba	312, 311
Wards	327, 328, 335, 331, 332
Yamaha	314, 330, 336, 337
Zenith	331

Cable Boxes

Manufacturer	Code
Sony	230
Hamlin/Regal	222, 223, 224, 225, 226
Jerrold/	201, 202, 203, 204,
General Inst./	205, 206, 207, 208,
Motorola	218, 222
Oak	227, 228, 229
Panasonic	219, 220, 221
Pioneer	211, 214, 215
Scientific Atlanta	209, 210, 211
Tocom	216, 217
Zenith	212, 213

Satellite Receivers

Manufacturer	Code
Sony	801
Dish Network	810
EchoStar	810
General Electric	802
Hitachi	805
Hughes	804
JVC	810
Mitsubishi	809
Panasonic	803
Philips	811
RCA/PROSCAN	802, 808
Toshiba	806, 807
Samsung	812

* If an Aiwa VCR does not work even though you enter the code for Aiwa, enter the code for Sony instead.

Using Other Equipment with Your Remote Control

To operate other equipment connected to your TV, first turn to page 42 and program the necessary code. For operating video equipment, press TV/VIDEO repeatedly until you see the video input on the screen for your connected equipment. Remote control tips are provided below.

 **Some functions cannot be operated depending on the equipment. In that case, operate by the remote control supplied with the equipment.**

Operating a Cable Box

To Do This ...	Press ...
Activate the remote control to operate the cable box	SAT/CABLE (FUNCTION)
Turn on/off	POWER

Operating a Satellite Receiver

To Do This ...	Press ...
Activate the remote control to operate the satellite receiver	SAT/CABLE (FUNCTION)
Turn on/off	POWER
Select a channel	0-9, ENT
Change channels	CH +/-
Back to previous channel	JUMP

Operating a VCR

To Do This ...	Press ...
Activate the remote control to operate the VCR	DVR/VCR (FUNCTION)
Turn on/off	POWER
Change channels	CH +/-
Record	●
Play	▷
Stop	■

Operating a DVD Player or DVD Changer

To Do This ...	Press ...
Activate the remote control to operate the DVD	DVD/VCR (FUNCTION)
Turn on/off	POWER
If you have a DVD changer, to skip disc	F1
Play	▷
Stop	■
Pause	(press again to resume normal playback)

To Do This ...	Press ...
Select a channel	0-9, ENT
Change channels	CH +/-
Back to previous channel	JUMP

To Do This ...	Press ...
Display channel number	DISPLAY
Display SAT Guide	GUIDE
Display SAT Menu	MENU
Move highlight (cursor)	↑ ↓ ← →
Select item	⊕

To Do This ...	Press ...
Fast forward	▶▶
Rewind the tape	◀◀
Pause	(press again to resume normal playback)
Select a channel	0-9, ENT
INPUT SELECT	TV/VIDEO

To Do This ...	Press ...
Step through different tracks of the disc	◀◀ to fast reverse or ▶▶ to fast forward the disc when pressed during playback
Step through different chapters of the disc	▶▶ to step forward or ◀◀ to step backward
Select a track directly	0-9, ENT
Display the disc menu or top menu	BD/DVD MENU or TOP MENU
Display the system MENU	MENU
Operate the DVD menu	↑ ↓ ← → ⊕

Operating a Blu-ray Disc Player (BD)

To Do This ...	Press ...
Activate the remote control to operate the Blu-ray Disc player	BD/DVD (FUNCTION)
Turn on/off	POWER
Play	▷
Stop	■
Pause	⏸ (press again to resume normal playback)

Operating a 5.1ch DVD AV System (Sony DAV)

To Do This ...	Press ...
Activate the remote control to operate the DVD	BD/DVD (FUNCTION)
Turn on/off	POWER
Select other equipment connected to the DAV	F1
Disk skip	F2
Display the disc menu or top menu	BD/DVD MENU or TOP MENU
Select a track directly	0-9, ENT

Operating a DVD/VCR Combo Unit

To Do This ...	Press ...
Activate the remote control to operate the DVD/VCR	DVR/VCR (FUNCTION)
Turn on/off	POWER
Select the DVD Select the VCR	F 1 F 2
Display the disc menu or top menu	BD/DVD MENU or TOP MENU
Play	▷
Stop	■
Pause	⏸

Operating a HDD/DVD Combo Unit

To Do This ...	Press ...
Activate the remote control to operate the DVD/HDD	DVR/VCR (FUNCTION)
Turn on/off	POWER
Select the HDD Select the DVD	F 1 F 2
Play	▷
Stop	■

To Do This ...	Press ...
Step through different tracks of the disc	◀◀ to fast reverse or ▶▶ to fast forward the disc when pressed during playback
Display the POP UP menu (BD)	BD/DVD MENU
Display the disc menu (DVD)	BD/DVD MENU
Display the top menu (BD)	BD/DVD TOP MENU
Display the top menu (DVD)	BD/DVD TOP MENU
Operate the menu	⬆ ⬇ ⬇ ⬆, ⊕

To Do This ...	Press ...
Play	▷
Stop	■
Pause	⏸
Search the picture forward or backward	▶▶ or ◀◀ during playback
Specify the previous chapter/track Specify the next chapter/track	◀◀ ▶▶
Move highlight (cursor)	⬆ ⬇ ⬇ ⬆
Select item	⊕
Master volume	VOL +/-, MUTING

To Do This ...	Press ...
Search the picture forward or backward	▶▶ or ◀◀ during playback
Move highlight (cursor) and select (DVD)	⬆ ⬇ ⬇ ⬆ ⊕
Record (VCR)	●
Change channels (VCR)	CH +/- or 0-9, ENT (using tuner)
Adjust tracking (VCR)	CH +/- (during tape playback)
Index search	◀◀ ▶▶
INPUT SELECT	TV/VIDEO

To Do This ...	Press ...
Record	●
REC PAUSE	⏸
REC STOP	■
Specify the previous chapter/track Specify the next chapter/track	◀◀ ▶▶
Replay	◀◀
Advance	▶▶

To Do This ...	Press ...
Pause	⏸
Search the picture forward or backward	▶▶ or ◀◀ during playback
Move highlight (cursor) and select	⬆ ⬇ ⬆ ⊕

Operating a DVR

To Do This ...	Press ...
Activate the remote control to operate the DVR	DVR/VCR (FUNCTION)
Turn on/off	POWER
Play	▶
Jump back while viewing live or record programs	REPLAY
Slow mode	◀◀/◀◀ (press lightly)
Jump forward while viewing recorded programs	•→

Operating an AV Receiver

To Do This ...	Press ...
Activate the remote control to operate the AV Receiver	DVR (FUNCTION)
Turn on/off	POWER

To Do This ...	Press ...
Display the disc menu or top menu	BD/DVD MENU or TOP MENU
INPUT SELECT	TV/VIDEO

To Do This ...	Press ...
Jump forward to the next available chapter	▶▶
Stop	■
Pause	⏸
Record	●
Record Stop	■
Record Pause	⏸

To Do This ...	Press ...
Master volume	VOL +/-, MUTE
Select other input connected to AV receiver	F1

Special Buttons on the Remote Control

This TV comes with convenient features that can be either accessed directly by pressing their buttons on your remote control or pressing the TOOLS button to display most commonly used functions.

Using the TOOLS Button

The TOOLS button allows you to access the following functions.

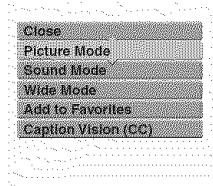

Menu Item	Reference pages
Close	
Picture Mode	see page 59
Sound Mode	see page 62
Wide Mode	see page 64
Add to Favorites	see page 54
Caption Vision (CC)	see page 71
Alternate Audio	see page 63

⚠ **Alternate Audio is only available in TV mode when the program is broadcasted with an alternate audio.**

⚠ **Add to Favorites is available for TV mode only.**

Using the TOOLS Button in PC Mode

The TOOLS button is also available while in PC input mode. The Tools menu items are different from your TV and other video inputs.

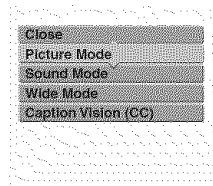

Menu Item	Reference pages
Close	
Picture Mode	see page 59
Sound Mode	see page 62
Wide Mode	see page 64
Caption Vision (CC)	see page 71

Using the **JUMP** Button

The **JUMP** button allows you to jump back and forth between the current channel and the last channel that was selected.



Using the **FREEZE** Button

The **FREEZE** button allows you to temporarily capture a program's picture. You can use this feature to write down information such as phone numbers, recipes, etc. To cancel **FREEZE** and return to normal viewing, press the **FREEZE** button again.

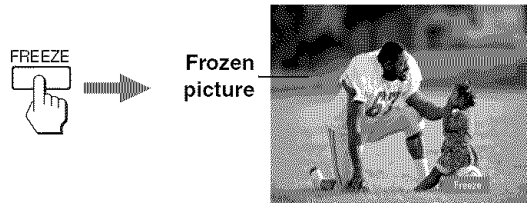

Using the **GUIDE** Button

Press **GUIDE** on the TV's remote control to display the Program Guide. The Program Guide lets you review program information if it is available from the broadcaster in the information banner.

Channel number, call letters, etc.

Information Banner

Provide channel number, program title, description, program duration, time remaining, rating information, closed-caption availability, etc.

Channel list.

Program Options (When available from the broadcaster.)

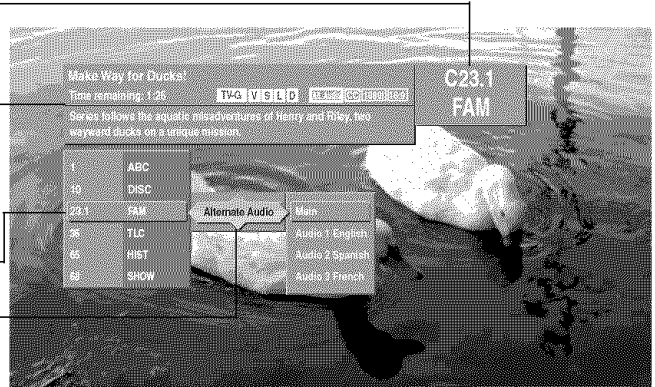

Using the Program Guide

The Program Guide allows you to select the channels from a drop down list. The Guide also provides information about the current program being shown on each channel.

Subchannels are additional channels of programming broadcast simultaneously. For example, channel 4 might include three subchannels (4.1, 4.2, 4.3) that are showing programs at the same time.

Using the Program Options

Each program has a main audio stream (the audio you hear when the channel is first tuned), and may have alternate audio streams available by the broadcaster. When available, you will see the alternate audio options as shown in the illustration above. This option allows you to switch among these alternate audio streams. The program you are watching may be broadcast in a different language.

Using the WIDE Button

Wide screen mode lets you watch 4:3 normal broadcasts in several wide screen modes (16:9 aspect ratio).

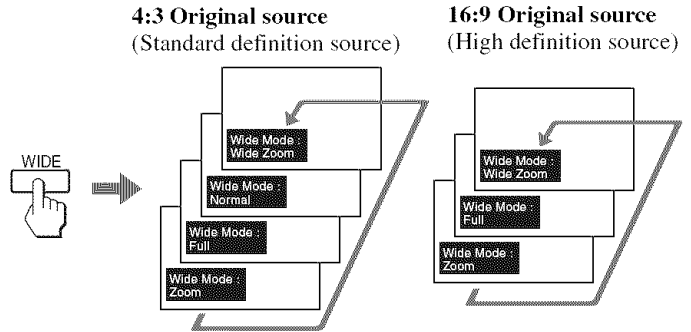

💡 When the TV receives a 720p or 1080i signal that is 4:3 aspect ratio picture with a black bar at each side, Full returns the picture to its original size.

💡 You can also access the Wide Mode settings in the Screen settings. For details, see page 64.

⚠️ When the TV receives a 720p or 1080i signal, Normal cannot be selected.

Changing the wide screen mode

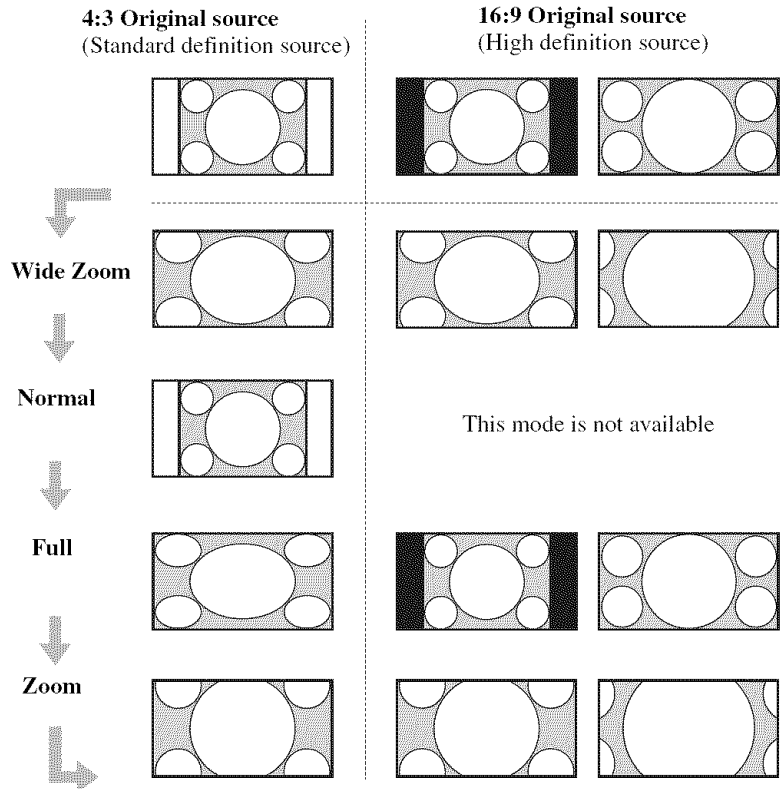

Using the WIDE Button in PC Mode

💡 You can also access the PC Wide Mode settings in the Screen settings. For details, see page 64.

💡 Depending on the signal from your PC, your TV will display black frame around the picture in various width.

While in the PC Mode, press the WIDE button to toggle through different wide screen modes to view the signal from your computer.

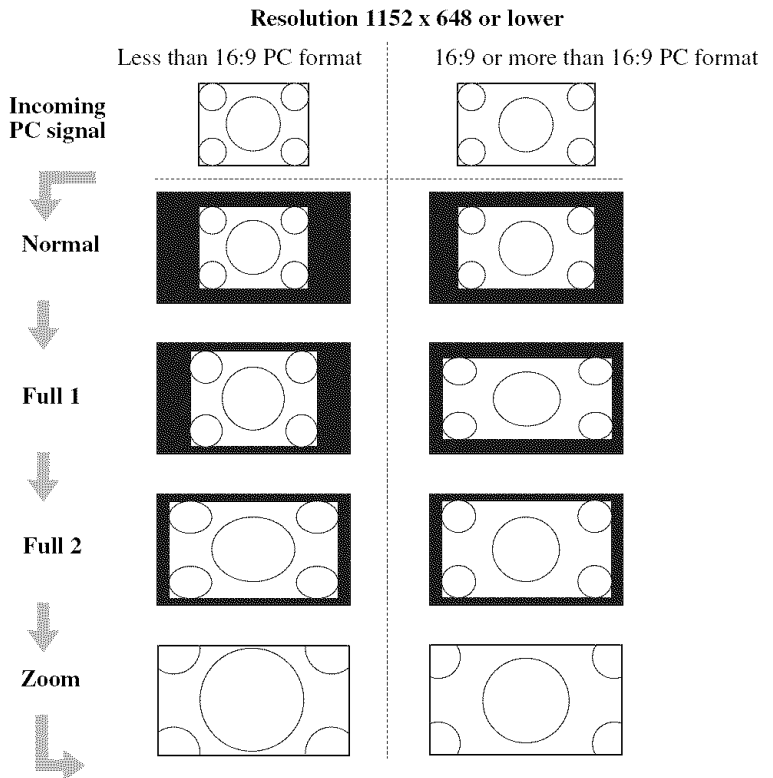
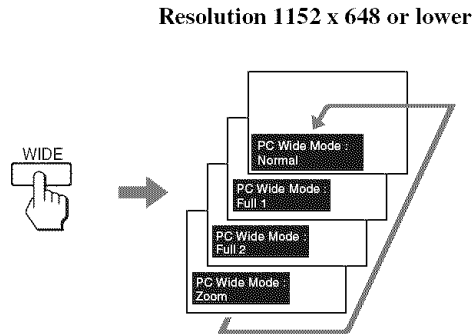

Using the WIDE Button in PC Mode continued

Resolution higher than 1152 x 648

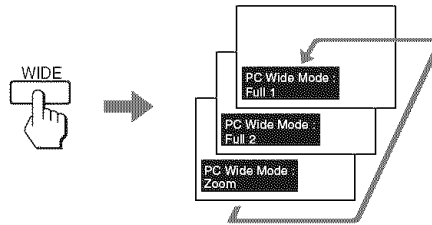

Resolution higher than 1152 x 648

Less than 16:9 PC format 16:9 or more than 16:9 PC format

Incoming PC signal

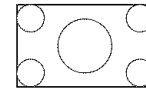
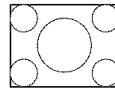

Normal

This mode is not available

This mode is not available

Full 1

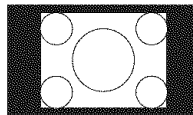

Full 2

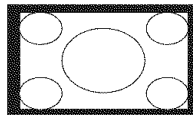

Zoom

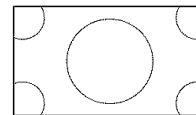
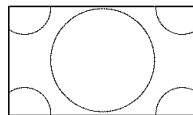

Using the Menus

Overview of MENU

MENU provides one button access for controlling your TV. It enables you to perform a variety of tasks intuitively with a control panel on the screen rather than a variety of remote control button presses.

When you press the  button, you can select from basic TV functions: External Inputs, Favorites, Cable, Antenna or adjust TV settings.

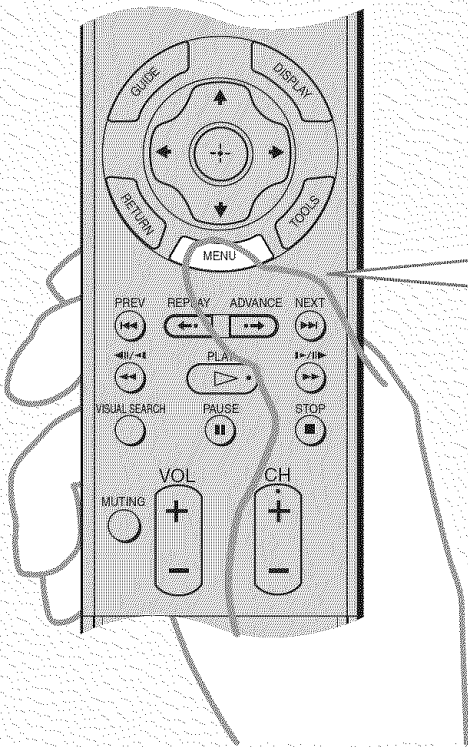

- 1 Press MENU on the remote.
MENU control panel appears.

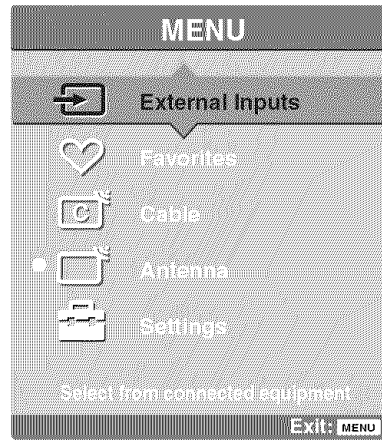





- 2 Press  to highlight the item.

- 3 Press  to select.

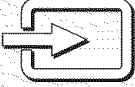
- 4 Press  to exit.

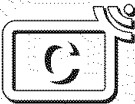
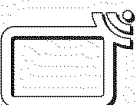
The MENU screen gives you access to the following items:

Icon	Description
 <p data-bbox="168 512 329 538">External Inputs</p>	<p data-bbox="403 373 1223 468">The External Inputs feature lets you select equipment that is connected to your TV, such as a DVD player. You can assign a label to your equipment or skip unused inputs conveniently. For details, see page 54.</p>
 <p data-bbox="194 685 302 711">Favorites</p>	<p data-bbox="403 538 1223 598">The Favorites feature lets you select programs from a list of up to 16 favorite channels that you specify. For details, see page 54.</p>
 <p data-bbox="215 859 282 885">Cable</p>	<p data-bbox="403 711 1196 772">The Cable feature displays the most recently viewed channel on the cable input.</p>
 <p data-bbox="201 1032 295 1058">Antenna</p>	<p data-bbox="403 885 1162 946">The Antenna feature displays the most recently viewed channel on the antenna input.</p>
 <p data-bbox="201 1206 288 1232">Settings</p>	<p data-bbox="403 1067 1229 1128">The Settings feature lets you adjust the Picture, Sound, Screen, Channel, Parental Lock or Setup settings. For details, see page 56.</p>

 **A dot appears next to the currently active TV mode (external input, cable TV or antenna TV).**

Navigating and Selecting Items

Use your remote control to navigate through MENU and the settings.



Using External Inputs in MENU

The External Inputs feature lets you view from a selected external input connected to your TV. You can assign a label or skip over unused inputs by selecting **Edit Video Labels**. Input label assignment can also be done by going to Setup settings and select **Label Video Inputs** (see page 71).

- 1 Highlight **External Inputs** from the MENU control panel and press .

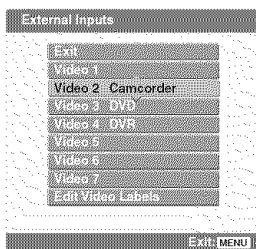
The External Inputs list appears.





- 2 Make your selection by pressing  to highlight the desired external input then press .

Using Favorites in MENU

The Favorites feature lets you select programs from a list of up to 16 favorite channels that you specify. You can create a list using the **Add to Favorites** option.

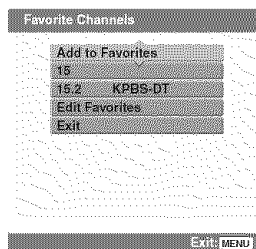
- 1 Highlight **Favorites** from the MENU control panel and press .
- The Favorite Channels list appears.



- 2 Make your selection by pressing  to highlight the desired channel then press .

 - To add the current channel to the list of Favorite Channels, highlight **Add to Favorites** and press .
 - When the Favorite Channels list is full, select **Edit Favorites** to remove a channel from the list or go to the **Channel** settings and select **Favorite Channels** to edit the channel.

Using Cable in MENU

The Cable feature displays the most recently viewed channel on the cable input.

Highlight Cable from the MENU control panel and press (+).





 **If you have not completed the initial channel setup (see page 28) both Cable and Antenna will tune to the lowest channel number. To run Auto Program see page 66.**

Using Antenna in MENU

The Antenna feature displays the most recently viewed channel on the antenna input.

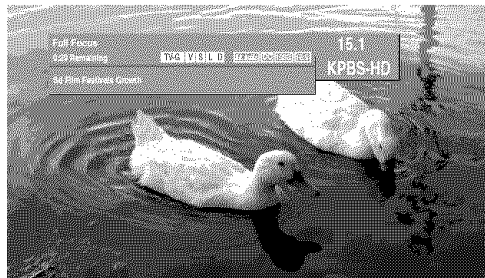
Highlight Antenna from the MENU control panel and press (+).



 **If you have not completed the initial channel setup (see page 28) both Cable and Antenna will tune to the lowest channel number. To run Auto Program see page 66.**







Using Settings in MENU

The **Settings** feature lets you enter to the settings screen where most of advanced settings and adjustments are performed. See “Overview ” on page 57.

Navigating Through Settings

The **Settings** screen provides access to the features:

- 1 Press  .
- 2 Select  .
- 3 Highlight the item: Picture, Sound, Screen, Channel, Parental Lock, Setup.
- 4 Press  to select an option.

To exit **Settings**, press  .

 **The options you can adjust vary depending on the situation. Unavailable options are grayed out.**

Using the Settings

Overview

The Settings give you access to the following features:

The on-screen menu color shown in the manual is different from the default setting (translucent) of your TV, see "Menu Color" on page 73. (Depending on the signal tuned, you may see a different Setting options on your screen. Settings displayed here are with the 720p signal.)

Settings	Allows you to set/change
<p>Picture</p>	<ul style="list-style-type: none"> Picture Mode (page 59) Reset (page 59) Advanced Iris (page 59) Picture (page 60) Brightness (page 60) Color (page 60) Hue (page 60) Color Temp. (page 60) Sharpness (page 60) Noise Reduction (page 60) DRC Mode (page 60) DRC Palette (page 61) Advanced Settings (page 61)
<p>Sound</p>	<ul style="list-style-type: none"> Sound Mode (page 62) Reset (page 62) Treble (page 62) Bass (page 62) Balance (page 62) Steady Sound (page 62) Volume Offset (page 62) Surround (page 62) BBE (page 62) MTS (page 63) Alternate Audio (page 63) Speaker (page 63) Audio Out (page 63) A/V Sync (page 63)
<p>Screen</p>	<ul style="list-style-type: none"> Wide Mode (page 64) PC Wide Mode (page 64) Auto Wide (page 65) 4:3 Default (page 65) Display Area (page 65) Horizontal Center (page 65) Vertical Center (page 65) Vertical Size (page 65)

(Continued)

Settings

Allows you to set/change

Channel

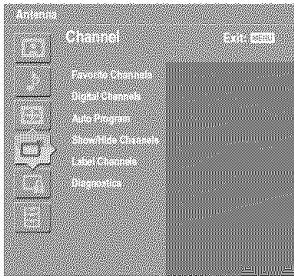

- Favorite Channels (page 66)
- Digital Channels (page 66)
- Auto Program (page 66)
- Show/Hide Channels (page 66)
- Label Channels (page 67)
- Diagnostics (page 67)

Parental Lock

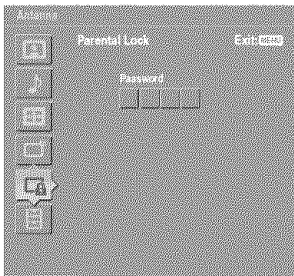

- Rating (page 68)
- Digital Rating (page 68)
- Unrated (page 69)
- Change Password (page 69)
- Select Country (page 69)

Setup

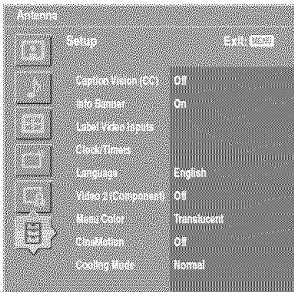

- Caption Vision (CC) (page 71)
- Info Banner (page 71)
- Label Video Inputs (page 71)
- Clock/Timers (page 72)
- Language (page 72)
- Video 2 (Component) (page 73)
- Menu Color (page 73)
- CineMotion (page 73)
- Cooling Mode (page 73)
- Lamp Replacement (page 73)
- Product Information (page 73)



Accessing the Picture Settings

1. Press MENU.....



2. Select Settings.....



3. Highlight.....



4. Press to select.....

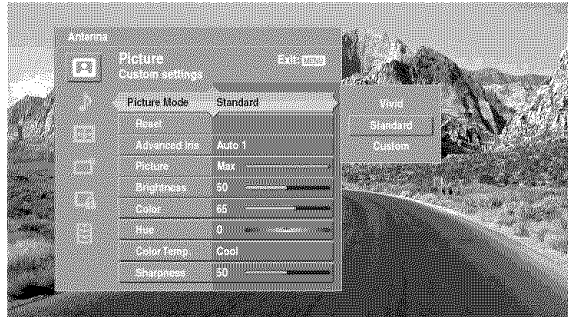

To highlight an option and to change settings, press **↑ ↓ ← →**.

Press **+** to confirm the selection.

To exit the Picture, press **MENU**.

Selecting Picture Options

To quickly and easily change from one Picture Mode to another, use PICTURE on the remote control.



The Picture settings include the following options:

Option	Description
Picture Mode	<p>Vivid Select for enhanced picture contrast and sharpness.</p> <p>Standard Select for standard picture settings. Recommended for home entertainment.</p> <p>Customized picture viewing Custom Select to display a picture with minimum enhancements.</p>
Reset	Select OK to reset all settings and adjustments to the default setting (except for Advanced Settings).
Advanced Iris	<p>By selecting the iris option, you can obtain the best brightness and contrast suited for your TV viewing.</p> <p>Auto 1/2 Automatically detects the brightness of the screen. These options are best suited for programs such as movies that often change between bright scenes and low light setting scenes.</p> <p>Auto 1: Recommended option for viewing programs that have larger variation in brightness from scene to scene.</p>

You can alter the Picture settings (Picture, Brightness, Color, etc.) for each Picture Mode and each video input.

You may set up a Picture Mode (Vivid, Standard, Custom) independently for each Video input (Video 1 to Video 7, including the Antenna input). Your Picture Mode settings are automatically saved after each selection. This allows you to customize the Picture Mode setting for each type of signal source.

(Continued)

Option	Description
	Auto 2: Recommended option for viewing programs that have less variation in brightness from scene to scene.
High	With this option, the screen has maximum level of brightness. It is suitable for TV viewing in a brightly lit room.
Medium	With this option, the brightness is about the standard level.
Low	With this option, the screen is dimmed but contrast is at a maximum. It is suitable for TV viewing in a room with low lighting.
 When Picture Mode is set to Vivid, Advanced Iris option is automatically set to Auto 1.	
Picture	Adjust to increase picture contrast and deepen the color or decrease picture contrast and soften the color.
Brightness	Adjust to brighten or darken the picture.
Color	Adjust to increase or decrease color intensity.
Hue	Adjust to increase or decrease the green tones.
Color Temp.	Choose from four color temperatures:
<i>White intensity adjustment</i>	Cool Select to give the white colors a blue tint.
	Neutral Select to give the white colors a neutral tint.
	Warm 1, 2 Select to give the white colors a red tint. Available only when Picture Mode is set to Custom.
Sharpness	Adjust to sharpen or soften the picture.
Noise Reduction	Select Auto to reduce the noise level of connected equipment. This also reduces the noise level to the signal from the VHF/UHF jack.
 When Digital Channel, Component Input, HDMI Input or Freeze mode is in use, Auto is not available.	
DRC Mode	High Density Creates a high-resolution picture with 4 x density, for high quality sources (i.e., DVD player, satellite receiver).
	Progressive Recommended for still pictures.
 DRC Mode is most effective when watching 480i source. DRC Mode is not available when using the Freeze feature; also not available when watching 480p, 720p or 1080i sources.	

Option	Description
DRC Palette	<p data-bbox="575 180 1243 234">Custom Allows you to customize the level of detail (Reality) and smoothness (Clarity).</p> <ol data-bbox="716 239 1243 326" style="list-style-type: none"> <li data-bbox="716 239 1243 326">1 Press the arrow buttons to highlight Custom then press +. The DRC palette appears. <div data-bbox="763 338 1009 539" style="border: 1px solid black; padding: 5px; margin: 10px 0;"> <p data-bbox="776 348 901 371">DRC Palette</p> <p data-bbox="776 374 928 397">Press + to exit</p> <div data-bbox="803 404 978 534" style="border: 1px solid black; padding: 5px; margin: 5px auto; width: 80px;"> <p data-bbox="807 427 848 470">Reality (25)</p> <p data-bbox="888 493 955 536">Clarity (1)</p> </div> </div> <ol data-bbox="716 552 1243 737" style="list-style-type: none"> <li data-bbox="716 552 1243 696">2 Press the arrow buttons to adjust the position of the marker (●). As you move the ● higher along the Reality axis, the picture becomes more detailed. As you move the ● to the right along the Clarity axis, the picture becomes smoother. <li data-bbox="716 701 1243 737">3 To save the setting, press +. <p data-bbox="581 743 1243 881">DRC Palette is most effective when watching 480i source. DRC Palette is not available when Noise Reduction is set to Auto or using the Freeze feature; also not available when watching 480p, 720p or 1080i sources.</p>
Advanced Settings Available in "Custom Picture Mode"	<p data-bbox="575 892 1243 1025">Program Select Program to choose among the options: Reset, Black Corrector (High/Medium/Low/Off), Gamma (Max/High/Medium/Low/Off), Clear White (High/Low/Off), Color Corrector (High/Low/Off).</p>



Accessing the Sound Settings

1. Press MENU.....



2. Select Settings.....



3. Highlight.....



4. Press to select.....

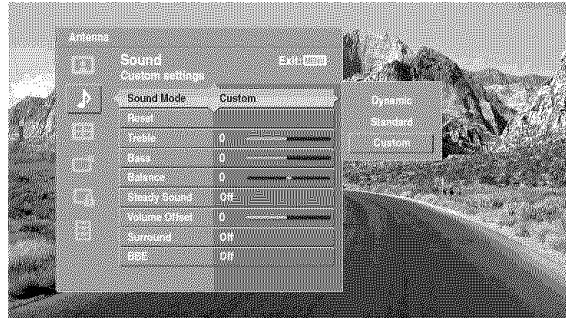

To highlight an option and to change settings, press $\uparrow \downarrow \leftarrow \rightarrow$.

Press \oplus to confirm the selection.

To exit the Sound, press

Selecting Sound Options



Sound Mode settings are independent of settings in the Treble/Bass options.

TruSurround XT attempts to create the same surround effect produced by a multichannel system using the left and right speakers.

The Sound settings include the following options:

Option	Description
Sound Mode	Dynamic Select to enhance treble and bass.
	Standard Suitable for spoken dialog.
	Custom Flat setting.
Reset	Reset the following options to the default setting: Treble, Bass, Balance, Steady Sound, Volume Offset and BBE.
Treble	Adjust to increase or decrease higher-pitched sounds.
Bass	Adjust to increase or decrease lower-pitched sounds.
Balance	Adjust to emphasize left or right speaker balance.
Steady Sound	On Select to stabilize the volume across all programs and commercials.
	Off Select to turn off Steady Sound.
Volume Offset	Adjust to increase or decrease the sound level of the current input (TV or video input) relative to other inputs.
Surround	TruSurround XT Select for surround sound (for stereo programs only).
	Off Normal stereo or mono reception.
BBE	Select to give sound more impact by compensating for phase effects in speakers. Select from High, Low, and Off.

The BBE option is not available (it is grayed out) if the Sound Mode option is set to Dynamic or Standard. To use BBE, set Sound Mode to Custom.

Option	Description	
MTS <i>Enjoy stereo, bilingual and mono programs</i>	Stereo	Select for stereo reception when viewing a program broadcast in stereo.
	Auto SAP	Select to automatically switch to second audio programs when a signal is received. (If no SAP signal is present, the TV remains in Stereo mode.)
	Mono	Select for mono reception. (Use to reduce noise during weak stereo broadcasts.)
 MTS is available only for analog programs.		
Alternate Audio <i>Digital Channel only</i>	Switch among the available alternate audio streams. The program you are tuned may be broadcast in a different language in the alternate audio stream.	
	 The Alternate Audio option is not available if the program is not broadcasted with alternate audio streams.	
Speaker	On	Select to turn on the TV speakers.
	Off	Select to turn off the TV speakers and listen to the TV's sound only through your external audio system speakers.
Audio Out <i>Easy control of volume adjustments</i>	This option can be set only when the Speaker option is set to Off .	
	Variable	The TV's speakers are turned off and the audio output from your audio system can still be controlled by the TV's remote control.
	Fixed	The TV's speakers are turned off, and the audio output of the TV is fixed. Use your audio receiver's volume control to adjust the volume (and other settings) through your audio system.
 The MUTING button on your remote control is available when Audio Out is set to Variable, and does not function when set to Fixed.		
A/V Sync	Off/1/2/3	Use this option to make adjustments to audio and video synchronization when you have external equipment connected to DIGITAL AUDIO (OPTICAL) OUT of the TV. Select Off (factory default setting) to make no adjustments. Select 1, 2 or 3 to adjust so that the video and audio from your connected external equipment are in sync.



Accessing the Screen Settings

1. Press MENU.....



2. Select Settings.....



3. Highlight.....



4. Press to select.....

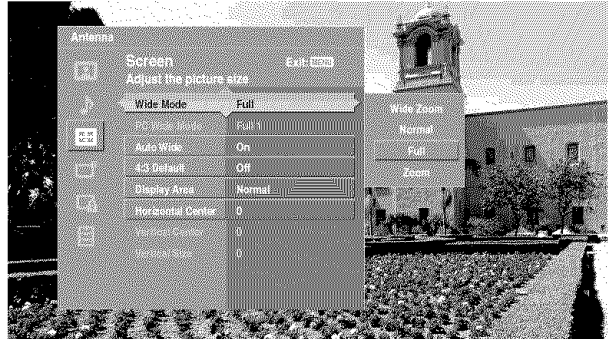

To highlight an option and to change settings, press \uparrow \downarrow \leftarrow \rightarrow .

Press \oplus to confirm the selection.

To exit the Screen, press

Selecting Screen Options

Wide Mode is unavailable while in Freeze (page 47).

The Screen settings include the following options:

Option	Description
Wide Mode	Wide Zoom
Select a screen mode to use for 4:3 sources.	Select to enlarge the 4:3 picture, to fill the 16:9 screen, keeping the original image as much as possible.
	Normal
	Select to return the 4:3 picture to its original size and aspect ratio.
	Normal is not available when you are watching 720p or 1080i sources.
	Full
	Select to enlarge the 4:3 picture horizontally only, to fill the display area.
	Zoom
	Select to proportionally enlarge 1080i and 720p sources. For 480p and 480i sources, Zoom will vertically stretch the image to fill the screen.
	To change from one Wide Mode setting to another, use the WIDE button on the remote control (see page 49).
	This “Wide Mode” option is not available (grayed out) while your TV is in PC input mode. For adjusting screen size while in PC input mode, see “PC Wide Mode”.
PC Wide Mode	Normal
	Select to display the picture in its original size.
	Normal is not available if the PC input resolution is greater than 1152 x 648.
	Full 1
	Select to enlarge the picture to fill the display area, keeping its original aspect ratio.
	A black frame will appear on the surrounding of the picture.

Option	Description
	<p>Full 2 Select to enlarge the picture to fill the display area.</p> <p> A black frame will appear on the surrounding of the picture.</p>
	<p>Zoom Select to enlarge the picture horizontally and vertically to an equal aspect ratio that fills the wide screen.</p>
Auto Wide	<p>On Select to automatically switch the wide mode based on the input signal.</p> <p>Off Select to keep the Wide Mode in its original size and aspect ratio.</p> <p> This option is not available for HDMI PC input.</p>
4:3 Default <i>Select the default screen mode to use for 4:3 sources.</i>	<p>Wide Zoom Select to enlarge the 4:3 picture, to fill the 16:9 screen, keeping the original image as much as possible.</p> <p>Normal Select to return the 4:3 picture to its original size and aspect ratio.</p> <p>Full Select to enlarge the 4:3 picture horizontally only, to fill the display area.</p> <p>Zoom Select to enlarge the picture horizontally and vertically to an equal aspect ratio that fills the wide screen.</p> <p>Off Select to continue using the current screen mode setting when the channel or input is changed.</p> <p> This option is not available for HDMI PC input.</p> <p> This option is not available if Auto Wide is set to Off.</p>
Display Area	<p>Select Normal to return to the default display area. Select -1 or -2 to enlarge the picture vertically and horizontally.</p> <p> Display Area option is not available when PC Wide Mode is set to Normal.</p>
Horizontal Center	<p>Allows you to move the position of the picture left and right in the window.</p> <p>Press ◀ or ▶ and to choose a correction between +5 and -5.</p>
Vertical Center	<p>Allows you to move the position of the picture up and down in the window. (Available only in Wide Zoom, Zoom and PC Wide modes.)</p> <p>Press ▲ or ▼ and press (+) to choose a correction between +5 and -5.</p>
Vertical Size	<p>Allows you to adjust the vertical size of the picture. (Available only in Wide Zoom, Zoom and PC Zoom modes.)</p> <p>Press ▲ or ▼ and press (+) to choose a correction between +5 and -5.</p>

If 4:3 Default is set to anything but Off, the Wide Mode setting changes only for the current channel. When you change channels (or inputs), Wide Mode is automatically replaced with the 4:3 Default setting. To retain the current Wide Mode setting as channels and inputs are changed, set 4:3 Default to Off.



Accessing the Channel Settings

1. Press MENU.....



2. Select Settings.....



3. Highlight.....



4. Press to select.....

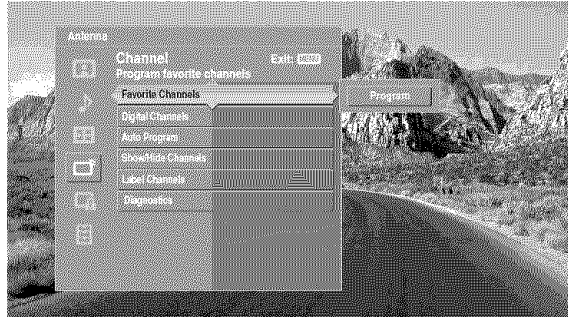

To highlight an option and to change settings, press **▲ ▼ ◀ ▶**.

Press **⊕** to confirm the selection.









To exit the Channel, press **MENU**.

Selecting Channel Options

The Channel settings include the following options:

Option	Description
Favorite Channels	Lets you set up a list of your favorite channels. For details, see "Using Favorites in MENU" on page 54.
Digital Channels Add	Select to add digital channels.
Auto Program	Automatically sets up the channel list on the TV for all receivable channels for the current input (VHF/UHF or CABLE). Select to start the Auto Program. ⚠ Auto Program may take up to 20 to 50 minutes to complete. A progress bar will display the approximate progress of the Auto Program and Digital Channels/Add sequences.
Show/Hide Channels	Allows you to show or hide channels that appear in the Program Guide and when you use the CH+/- buttons to channel surf. Channels that are set to Hidden do not appear in the Program Guide or when you use the CH+/- buttons. 1 Press ▲ or ▼ to highlight the channel that you want to show or hide. To move between the Major and Digital subchannel lists, press ◀ or ▶ . 2 To change a channel's setting to Shown or Hidden, press ⊕ . 3 To show or hide more channels, repeat steps 1 and 2.

💡 Channels that you set to Hidden can only be accessed with the 0-9 buttons.

Option	Description
<p> If you select to hide or show a major digital channel, all the sub-channels are automatically hidden or shown. To show or hide an individual sub-channel within a digital channel, you must individually select that sub-channel to show or hide.</p> <p> If you hide all sub-channels of a major digital channel, that digital channel is automatically set to Hidden.</p>	
<p>Label Channels</p>	<p>Allows you to assign labels (such as station call letters) to channel numbers.</p> <ol style="list-style-type: none"> 1 Press  or  to scroll through the channel numbers. Then press  to select the channel number that you want to assign a label. 2 Press  or  to scroll through the label characters (A-Z, 0-9, etc.). Then press  to select the highlighted character. Repeat to add characters to the label. 3 Press  to return to the Channel setting, or press MENU to exit the settings.
<p>Diagnostics</p>	<p>Display diagnostics information about the Current Channel and TV. This can be useful in providing information to an authorized technician or repair person.</p>



Accessing the Parental Lock Settings

1. Press MENU.....



2. Select Settings.....



3. Highlight.....



4. Press to select.....

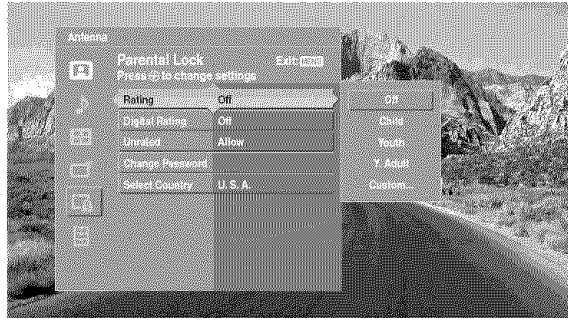

To highlight an option and to change settings, press **↑ ↓ ← →**.

Press **+** to confirm the selection.

To exit the Parental Lock, press **MENU**.

The Parental Lock setting allows you to set up the TV to block programs according to their content and rating levels.

A password needs to be setup before Parental Lock settings can be accessed for the first time. This password is required for any future access to the Parental Lock settings. If you have lost your password, see "Lost password" on page 83.

Selecting Parental Lock Options



💡 If you are not familiar with the Parental Guideline rating system, you should select Child, Youth, or Young Adult to help simplify the rating selection. To set more restrictive ratings, select Custom.

The Parental Lock settings include the following options:

Option	Description
Rating <i>Turn ratings on/off and select a rating system</i>	<p>Off Turn Parental Lock off. No programs are blocked from viewing. (See below for turning off the Digital Rating.)</p> <p>Child Maximum ratings permitted are: U.S.: TV-Y, TV-G, G Canada: C, G, TV-Y</p> <p>Youth Maximum ratings permitted are: U.S.: TV-PG, PG Canada: C8+, PG, 8 ans+, TV-PG</p> <p>Young Adult Maximum ratings permitted are: U.S.: TV-14, PG-13 Canada: 14+, 13 ans+, TV-14</p> <p>Custom... Select to set ratings manually. U.S.: See page 69 for details. Canada: See page 70 for details.</p>
Digital Rating <i>(Available only in U.S.A. where advanced ratings exist)</i>	<p>Off Turn Digital Rating off. No programs containing digital ratings are blocked from viewing.</p>

💡 The Digital Rating option is only available if digital ratings exist in the broadcasts received by your TV, and if the Country setting is U.S.A..

💡 If you select Block, be aware that the following programs may be blocked: news, sports, weather, emergency broadcasts, political programs, public service announcements, and religious programs.

Option	Description
Custom	Select to customize the Parental Lock with downloadable digital ratings.
Clear All	Select to clear the downloaded ratings.
 This icon  will appear on the information banner indicating the availability of the new downloadable rating information for Custom Digital Rating settings.	
Unrated <i>(available only in U.S.A.)</i>	Allow Allows programs and movies that are broadcast without a rating. Block Blocks all programs and movies that are broadcast without a rating.
Change Password	Select to change your password.
Select Country	U.S.A. Select to use U.S.A. ratings (see below). Canada Select to use Canadian ratings (see page 70).

To deactivate the parental control feature

- Set Rating and Digital Rating (if available) to Off when in the Parental Lock setting.

To change the password

- 1** In the Parental Lock setting, use the arrow buttons to highlight Change Password, and press  to select it.
- 2** Enter a new four-digit password using the 0-9 buttons.
- 3** Confirm the new password by entering it again.
- 4** Press MENU to exit the setting screen.

Viewing Blocked Programs

You can view a blocked program by entering the password.

- 1** Press ENT when tuned to a blocked program.
- 2** Enter your password using the 0-9 buttons.
Parental Lock will be canceled temporarily until you turn your TV off.

Selecting Custom Rating Options

💡 To ensure maximum blocking capability, the age-based ratings should be used.

US custom rating options

If you selected U.S.A. as the country of residence (see above), the Custom Rating setting includes the following options. (If you selected Canada, see page 70.)

Option	Description
Movie Rating	G All children and general audiences.
	PG Parental guidance suggested.
	PG-13 Parental guidance for children under 13.
	R Restricted viewing, parental guidance is suggested for children under 17.
	NC-17 and X No one 17 and under.

Option	Description
TV Rating	Age-Based Options
<i>Block programs by their rating, content or both</i>	TV-Y All children.
	TV-Y7 Directed to children age 7 and older.
	TV-G General audience.
	TV-PG Parental guidance suggested.
	TV-14 Parents strongly cautioned.
	TV-MA Mature audience only.
	Content-Based Options
	FV Fantasy violence.
	D Suggestive dialog.
	L Strong language.
	S Sexual situations.
	V Violence.

 **The content ratings will increase depending on the level of the age-based rating. For example, a program with a TV-PG V (Violence) rating may contain moderate violence, while a TV-14 V (Violence) rating may contain more intense violence.**

Canadian custom rating options

If you selected Canada as the country of residence on page 69, the Custom Rating setting includes the following options. (If you selected U.S.A., see page 69.)

Option	Description
English Rating	C All children.
	C8+ Children 8 years and older.
	G General programming.
	PG Parental guidance.
	14+ Viewers 14 and older.
	18+ Adult programming.
French Rating	G General programming.
	8 ans+ Not recommended for ages under 8.
	13 ans+ Not recommended for ages under 13.
	16 ans+ Not recommended for ages under 16.
	18 ans+ Programming restricted to adults.
U.S.A. Rating	See “TV Rating” above for details.



Accessing the Setup Settings

1. Press MENU.....



2. Select Settings.....



3. Highlight.....



4. Press to select.....

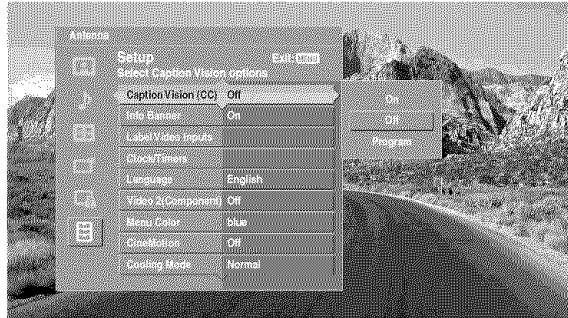

To highlight an option and to change settings, press **↑ ↓ ← →**.

Press **⊕** to confirm the selection.

To exit the Setup, press **⏪**.





















Selecting Setup Options

The Setup settings include the following options:

Option	Description
Caption Vision (CC)	On Caption Vision is turned on.
	Off Caption Vision is turned off.
	Program Allows you to set basic and advanced Caption Vision options. See "Programming Caption Vision (CC)" on page 74.
Info Banner	Set to On or Off. Select On to display the program name, time remaining and other information (if the broadcaster offers this service). Also displays when the channel is changed or the DISPLAY button is pressed.
Label Video Inputs	Allows you to label the audio/video equipment you have connected to the TV so you can identify them when using TV/VIDEO. When in this setting: <ol style="list-style-type: none"> Press ↑ or ↓ to highlight an input to label, then press ⊕ to select it. Use the arrow buttons to scroll through the labels. Press ⊕ to select the equipment you connected to each of the input jacks on the back of your TV. Select Skip if you do not have any equipment connected to a particular input.
Video 1-7	DVD, Cable Box, Satellite, BD, VCR, Receiver, DVR, Game, Camcorder, PC, Edit, Skip.

PC label is available for Video 6 and Video 7 only.

(Continued)

Option	Description
	 If you select Skip, your TV skips the selected connection when you press TV/VIDEO.
Clock/Timers	Select to set the clock and to program your TV to turn on and off at two scheduled viewing times. Once the options are set, TIMER LED lights up in orange.
Sleep	Allows you to select the amount of time (Off, 15 minutes, 30 minutes, 45 minutes, 60 minutes, 90 minutes or 120 minutes) that you want the TV to remain on before shutting off automatically.
Timer 1	You can use the Timers to program the TV to turn on and off and tune to a
Timer 2	specific channel at two scheduled viewing times.
	Timer 1 and Timer 2 cannot be set until you set the Current Time.
	<ol style="list-style-type: none"> Press  or  to highlight Timer 1 or Timer 2. To set the timer, press .
	 To go directly to programming Timer 1 or 2, press  instead of pressing .
	<ol style="list-style-type: none"> Press  or  to highlight one of the following options, then press .
Program	Select to set the Timer by day, time, duration, and channel.
Off	Select to turn off the Timer. (Your previous settings are saved.)
	<ol style="list-style-type: none"> If you selected Program in step 2, press  and  to set the day(s), hour, minute, AM/PM, duration, and channel number. Press  or press  to confirm each setting and move to the next setting. Press  to go back to the previous setting.
	<ol style="list-style-type: none"> Press MENU to exit the setting screen. An LED on the front panel will light, indicating the Timer has been set.
Current Time	You can set the current time.
	<ol style="list-style-type: none"> Press  to select Current Time.
	<ol style="list-style-type: none"> Press  and  to set the current time (day, hour, minute, and AM/PM). Press  (or press ) to confirm each setting and move to the next setting. Press  to go back the previous setting.
	<ol style="list-style-type: none"> Press MENU to exit the setting screen.
Language	Select to display all on-screen settings in your language of choice: English, Español, Français.

💡 If you choose to use the composite connection for Video 2 (Component), be sure to select Off to activate for composite use.

Option	Description
Video 2 (Component)	Auto Select to switch automatically between the component video jacks (YPbPr, AUDIO L (MONO)/AUDIO R) and the composite video jacks (VIDEO, AUDIO L (MONO)/AUDIO R) on the left side of the TV (VIDEO/HD/DVD 2 IN) depending on the cable connection.
	Off Select to activate the composite video jacks (VIDEO/AUDIO L(MONO)/AUDIO R) on the left side of the TV.
Menu Color	Enables you to select a specific color for the on-screen settings.
CineMotion	Select Auto to optimize the screen display automatically detecting film content and applying a reverse 3-2 pulldown process. Moving pictures will appear clearer and more natural looking. Select Off to disable the detection.
Cooling Mode	Select High to use the TV at an altitude of 5,000 feet (1,500m) or higher. Select Normal to use the TV at normal altitude.
Lamp Replacement	When the lamp nears the end of its life, a message will appear every time the TV is turned on. After the lamp is replaced, select this option then follow the steps on screen.
Product Information	Select to display information about your TV model.

Programming Caption Vision (CC)

If you selected the Program option under Caption Vision (CC) (see page 71), you can change the following settings:

Option	Description
Basic	Allows you to select analog* closed caption options.
	CC1, CC2, CC3, CC4 Displays a printed version of the dialog or sound effects of a program. (Should be set to CC1 for most programs.)
	Text1, Text2, Text3, Text4 Displays network/station information presented using either half or the whole screen (if available).
Digital CC	Allows you to set digital** closed captioning to Basic or Advanced.
Advanced	Allows you to select advanced digital closed caption options. Select from the available options.
Advanced Settings	Allows you to make additional settings for digital closed caption options. Select from As Broadcast, Small Text, Large Text and Custom.
	Custom Allows you to customize the following settings:
	Character Size Small, Standard, Large
	Character Style Style 1-7
	Character Color Color 1-8
	Character Opacity Solid, Translucent
	Edge Color Color 1-8
	Edge Type None, Raised, Depressed, Outline, Left Shadow, Right Shadow
	Background Color None, Color 1-8
	Background Opacity Solid, Translucent
	Window Color None, Color 1-8
	Window Opacity Solid, Translucent

* "analog" according to the Code of Federal Regulations, 47 CFR 15.119.

** "digital" according to the Code of Federal Regulations, 47 CFR 15.122.

Other Information

Overview

This chapter includes the following topics:

Topic	Page
Contacting Sony	75
Replacing the Lamp	76
Troubleshooting	80
PC Input Signal Compatibility Chart	85
Specifications	86
Optional accessories	87
Index	88

Contacting Sony

If, after reading these operating instructions, you have additional questions related to the use of your Sony television, please contact our Customer Information Services Center.

Visit	http://www.sony.com/TVsupport
US	1-800-222-SONY (7669)
Canada	1-877-899-SONY (7669)

Before calling Sony customer support, please write down the model and serial numbers of your TV.

Replacing the Lamp

The Projection lamp, like all lamps, will eventually lose brightness and functionality, which affects the overall performance of your Television. How long the Lamp maintains its brightness will vary depending upon your usage and environmental conditions. To maintain the quality of your viewing experience, Sony recommends that you replace the Lamp (1) after approximately 8,000 hours of use (the TV will display a message reminding you to replace the lamp); (2) when the screen becomes dark or the color looks unusual; or (3) when the LAMP indicator on the front of the TV flashes.



WARNING

Electric appliances can cause fire or high temperature, resulting in injury or death. Be sure to follow the instructions below.

- Use a Sony XL-2400 replacement lamp (not supplied) for replacement. Use of any other lamp may damage the TV.
- Do not remove the lamp for any purpose other than replacement. Doing so may cause injury or fire.
- Do not put flammable materials and metal objects inside the lamp receptacle of the TV after removing the lamp. Doing so may cause fire or electrical shock. Do not touch the lamp receptacle once the lamp has been removed.
- When the lamp eventually burns out, you may hear a noticeable pop sound. This is normal and it is inherent to this type of lamp.
- In rare instances, the bulb may pop inside the lamp unit, but the lamp unit is designed to contain all of the broken glass pieces inside the lamp unit.
- This television's lamp contains mercury and should be disposed of properly. Consult your local authorities regarding safe disposal. "The material contained in this lamp are similar to those of a fluorescent lamp, so you should dispose of it in the same way.

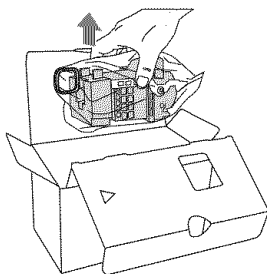
How to Replace the Lamp



- 1** Turn off the power on the main unit. Wait several minutes, then unplug the power cord.
(The cooling fan will continue to operate for about two minutes after turning the power off.)
- 2** Wait at least 30 minutes after unplugging the power cord to allow the lamp to cool down before replacing it. To avoid being burned, do not touch the lamp receptacle once the lamp has been removed.
- 3** Take the new lamp out of the box.
Do not touch the glass portion of the new lamp.
 -  **Do not shake the lamp. Vibration can damage the lamp or shorten its life.**
 -  **Avoid touching the front glass of a new lamp or the glass of the lamp receptacle. This may reduce picture quality or lamp life.**

- 4** Remove the outside lamp cover.

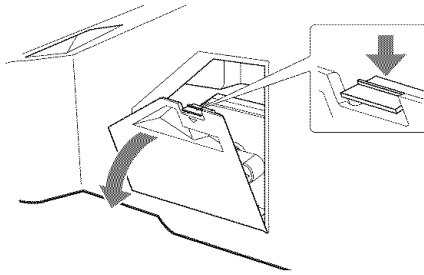

- 5** Remove the lamp door.
Turn the knob counterclockwise to OPEN and pull out the cover.

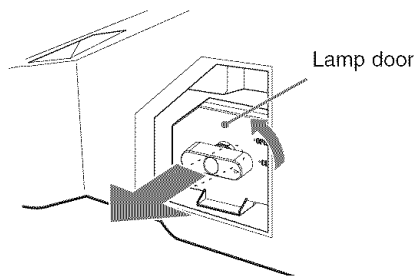

- 6** Pull out the lamp.
Hook a finger through the loop of the lamp handle and pull the handle upwards. Then pull the lamp straight out.

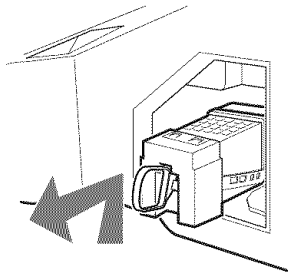

- ⚠ The lamp is very hot immediately after use. Never touch the glass portion of the lamp or the surrounding parts.
- ⚠ After the used lamp has cooled, place it into the empty box of the replacement lamp. Never put the used lamp into a plastic bag.

(Continued)

- 7** Put the new lamp into its place.
Mount the new lamp securely. Failure to do so may cause a fire or the screen to go dark.

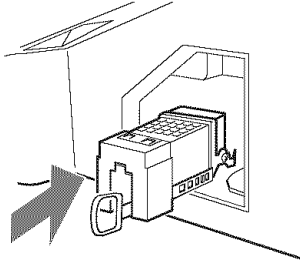

⚠ If the lamp is not securely reattached, the self-diagnostic function may be triggered and the POWER indicator flashes three times (see page 12).

- 8** Reattach the lamp door.
Turn the knob back to CLOSE and secure the cover.

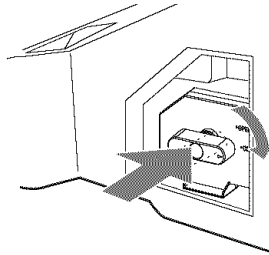

- 9** Put the outside lamp cover back in its place.

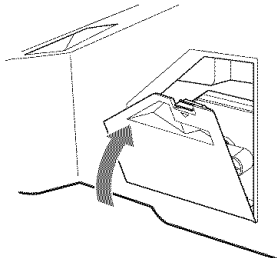

- 10** Select the Lamp Replacement option (MENU > Settings > Setup menu) and follow the on-screen procedure.

⚠ Consult your Sony dealer for a Sony XL-2400 replacement lamp.

⚠ Take great care when replacing the lamp or plugging in/unplugging the connecting cords. Rough handling may cause the TV to fall, damaging the TV, the TV stand and the floor.

The used lamp

For customers in the United States:

This product contains mercury. Disposal of this product may be regulated if sold in the United States. For disposal or recycling information, please contact your local authorities or the Electronics Industry Alliance (<http://www.eiae.org>).

- Do not leave the used lamp near flammable materials or within the reach of children.
- Do not pour water onto the used lamp or put any object inside the lamp. Doing so may cause the lamp to burst.

For replacement lamp information visit:

U. S.: <http://www.sonystyle.com/tv/>

Canada: <http://www.sonystyle.ca/tv/>

Troubleshooting

If you have additional questions, service needs, or technical assistance related to the use of your Sony TV, please visit our website or call one of the following numbers:

<http://www.sony.com/TVsupport>

1-800-222-SONY(7669) for US

1-877-899-SONY(7669) for Canada

Remote Control

Problem	Possible Remedies
Remote control does not operate	<ul style="list-style-type: none"><input type="checkbox"/> The batteries could be weak. Replace the batteries.<input type="checkbox"/> Check the orientation of the batteries.<input type="checkbox"/> Press TV (FUNCTION) once, and the TV indicator lights up. You may have inadvertently pressed SAT/CABLE (FUNCTION), which changes the remote control to SAT or CABLE mode.<input type="checkbox"/> Make sure this unit's power cord is connected securely to the wall outlet.<input type="checkbox"/> Florescent lamps can interfere with your remote control operation; try turning off the florescent lamps.<input type="checkbox"/> Keep the remote control sensor area clear from obstacles.<input type="checkbox"/> If the "High Temperature Warning" message appears, turn off the TV and wait until the TV's projection lamp cools down (approximately 5 minutes). If the remote control still does not work, make sure to dust the ventilation slots on the rear of the TV and the cooling fan to provide adequate ventilation around the TV.
Cannot change channels with the remote control	<ul style="list-style-type: none"><input type="checkbox"/> If you are using the TV to change channels, first press TV (FUNCTION) once, and the TV indicator lights up.<input type="checkbox"/> If you are using another device to change channels, be sure you have not inadvertently switched your TV from the channel 3 or 4 setting.<input type="checkbox"/> If you are using another device to change channels, be sure to press FUNCTION for that device. For example, if you are using your cable box to change channels, be sure to press SAT/CABLE (FUNCTION) once, and the SAT/CABLE indicator lights up.
Remote control does not operate non-Sony video equipment	<ul style="list-style-type: none"><input type="checkbox"/> If you replaced the batteries to the remote recently, the code numbers for the video equipment may need to be reset.<input type="checkbox"/> There may be more than one code for the equipment that you are attempting to operate.<input type="checkbox"/> There is a possibility that some non-Sony equipment cannot be operated by your Sony TV remote. You may need to use the equipment's original remote control.

Picture

Problem	Possible Remedies
No picture (screen not lit), no sound	<ul style="list-style-type: none"> <input type="checkbox"/> If your TV does not turn on and a red light keeps flashing, your TV may need service. Call your local Sony Service Center. <input type="checkbox"/> Make sure the power cord is plugged in. <input type="checkbox"/> Press POWER on the front of the TV. <input type="checkbox"/> Press TV/VIDEO to cycle through the connected video sources. <input type="checkbox"/> Try another channel; it could be station trouble.
Dark, poor or no picture (screen lit), good sound	<ul style="list-style-type: none"> <input type="checkbox"/> Adjust the Picture Mode option in the Picture setting (see page 59). <input type="checkbox"/> Adjust the Brightness option in the Picture setting (see page 60). <input type="checkbox"/> Check the antenna/cable connections.
No color/dark picture/color is not correct	<ul style="list-style-type: none"> <input type="checkbox"/> Adjust the Color option in the Picture setting (see page 60).
Only snow and noise appear on the screen	<ul style="list-style-type: none"> <input type="checkbox"/> Check the antenna/cable connections. <input type="checkbox"/> Try another channel; it could be station trouble. <input type="checkbox"/> Press ANT to change the input mode (see page 39).
Dotted lines or stripes	<ul style="list-style-type: none"> <input type="checkbox"/> Adjust the antenna. <input type="checkbox"/> Move the TV away from noise sources such as cars, neon signs, or hair dryers.
Double images	<ul style="list-style-type: none"> <input type="checkbox"/> Using a highly directional outdoor antenna or a cable may solve the problem.
“Black box” on screen	<ul style="list-style-type: none"> <input type="checkbox"/> You have selected a text option in the Setup setting and no text is available. (See page 71 to reset Setup selections.) To turn off this feature, set the Caption Vision (CC) option to Off. If you were trying to select closed captioning, select CC1 instead of Text 1-4.
Black bands appear at the top and bottom of the screen	<ul style="list-style-type: none"> <input type="checkbox"/> Some wide-screen programs are filmed in aspect ratios that are greater than 16:9 (this is especially common with theatrical releases). Your TV will show these programs with black bands at the top and bottom of the screen. For more details, check the documentation that came with your DVD (or contact your program provider).
Certain programs on DVD or other digital sources display a loss of detail, especially during fast-motion or dark scenes	<ul style="list-style-type: none"> <input type="checkbox"/> The compression used by certain digital broadcasts and DVDs may cause your TV’s screen to display less detail than usual, or cause artifacts (small blocks or dots, pixelations) to appear on your screen. This is due to your TV’s large screen and ability to show very fine detail, and is normal for certain digitally recorded programs. Adjust the reality/clarity in the DRC Palette setting (see page 61) to optimize the picture while viewing these sources.

(Continued)

Sound

Problem	Possible Remedies
Good picture, no sound	<ul style="list-style-type: none"><input type="checkbox"/> Press MUTING so that Muting disappears from the screen (see page 40).<input type="checkbox"/> Make sure the Speaker option is set to On in the Sound setting (see page 63).<input type="checkbox"/> Make sure the MTS option is set to Stereo or Mono (see page 63).<input type="checkbox"/> When the HDMI IN input is in use, surround sound, such as AC-3 and DTS, cannot be input. Change the sound setting for the external input device to Linear PCM.
Audio noise	<ul style="list-style-type: none"><input type="checkbox"/> Make sure that the antenna is connected with 75-ohm coaxial cable.<input type="checkbox"/> Keep the antenna cable away from other connecting cords.<input type="checkbox"/> To avoid TV interference, make sure to use an undamaged antenna cable.
Cannot gain enough volume when using a cable box	<ul style="list-style-type: none"><input type="checkbox"/> Increase the volume of the cable box using the cable box's remote control. Then press TV(FUNCTION) once (the TV indicator lights up) and adjust the TV's volume.
Sound seems weak or insufficient	<ul style="list-style-type: none"><input type="checkbox"/> The TV's audio might be set to Auto SAP or Mono, when it might be better set to Stereo. In the Sound setting (see page 63), set the MTS setting to Stereo. If already set to Stereo, switch to Mono (which may reduce background noise during weak stereo broadcasts).
Cannot raise the volume on external speakers	<ul style="list-style-type: none"><input type="checkbox"/> If the Speaker option is set to Off and the Audio Out option is set to Fixed (in order to output the sound to your audio system), use your audio receiver to adjust the sound (see page 63). Or, to use the TV remote control, set the Audio Out option to Variable.<input type="checkbox"/> To turn on the TV speakers, set the Speaker option to On (see page 63).
No audio for HDMI	<ul style="list-style-type: none"><input type="checkbox"/> Confirm DVD player, set-top-box audio settings. Select 2 channel LPCM audio.

Channels

Problem	Possible Remedies
Cannot receive upper channels (UHF) when using an antenna	<ul style="list-style-type: none"><input type="checkbox"/> Press ANT to select the VHF/UHF input (see page 39).<input type="checkbox"/> Use Auto Program in the Channel setting to add receivable channels that are not presently in the TV's memory (see page 66).
Cannot receive any channels when using cable TV	<ul style="list-style-type: none"><input type="checkbox"/> Use Auto Program in the Channel setting to add receivable channels that are not presently in the TV's memory (see page 66).<input type="checkbox"/> Press ANT to select the CABLE input (see page 39).
Cannot receive or select channels	<ul style="list-style-type: none"><input type="checkbox"/> Use Auto Program in the Channel setting to add receivable channels that are not presently in TV memory (see page 66).
Some digital cable channels are not being displayed	<ul style="list-style-type: none"><input type="checkbox"/> Certain cable companies have limitations on the broadcast of digital cable channels. Check with your cable company for more information.<input type="checkbox"/> The digital cable channel may be set to Hidden in the Channel setting (see page 66).

General

Problem	Possible Remedies
How to reset TV to factory settings	<input type="checkbox"/> Turn on the TV. While holding down the ↑ button on the remote control, press the POWER button on the TV. Release the POWER button then release the ↑ button. The TV will turn itself off, then back on again with Initial Setup. WARNING: This operation will clear all of your customized settings including Parental Lock setting.
How to restore Picture settings to factory settings	<input type="checkbox"/> Select Reset setting option while in the Picture setting (see page 59).
How to restore Sound settings to factory settings	<input type="checkbox"/> Select Reset setting option while in the Sound setting (see page 62).
Cannot cycle through the other video equipment connected to the TV	<input type="checkbox"/> Be sure the Label Video Inputs option is not set to Skip (see page 71).
Cannot operate the setting	<input type="checkbox"/> If a setting option appears in gray, this indicates that the setting option is not available.
Lost password	<input type="checkbox"/> On the password screen (see page 68), enter the following master password: 4357. The master password clears your previous password; it cannot be used to temporarily unblock channels.
TIMER LED on front panel is lit	<input type="checkbox"/> When lit, indicates that the timer is set (see page 72). When the timer is set, this LED will remain lit even when the TV is turned off.
LAMP LED blinks in red	<input type="checkbox"/> Replace the lamp (see page 76).
Digital cable box does not work	<input type="checkbox"/> If you are connecting a VCR and digital cable box using a splitter, as described on page 31, you must use a special bi-directional splitter that is designed to work with your digital cable box. Contact your cable provider for details.
Cannot record digital channels to VCR	<input type="checkbox"/> Only analog channels can be recorded to your VCR.
TV cabinet creaks	<input type="checkbox"/> When the TV is in use, there is a natural rise in temperature, causing the cabinet to expand or contract and may be accompanied by a slight creaking noise. This is not a malfunction.
A slight creaking noise occurs from the bottom part of the TV	<input type="checkbox"/> Advanced Iris applies a mechanical iris system. When Advanced Iris is set, a natural creaking noise occurs due to the basic structure of the optical unit. The creaking sound is an inherent nature of this system and is not a defect.
The cooling fan is loud	<input type="checkbox"/> If the TV is used at high altitudes and set to High , the cooling fan runs faster and its sound becomes louder. If the TV is not used at high altitudes, set Cooling Mode to Normal (see page 73).
"High Temperature Warning!" message appears	<input type="checkbox"/> Make sure to remove dust from the ventilation slots on the rear and both sides of the TV. In addition, make sure that there are no obstacles in front of the ventilation slots. If the message still appears after the dust or obstacles are removed, the TV may need servicing. Call your local Sony Service Center.
The TV does not turn on	<input type="checkbox"/> The TV cools down its projection lamp when the power is turned off. It takes up to two minutes for the picture to come back after the TV is turned on again. Wait for a while until the picture comes back.

(Continued)

Problem	Possible Remedies
Image left on the screen (image retention)	<ul style="list-style-type: none"> <input type="checkbox"/> Turn off the TV for a while or let the TV run on another channel. Unlike plasma TV and CRT TV, image retention on this TV is not permanent. It is only a temporary condition, (see page 11).
White spot on the screen when powered off	<p>If screen is exposed to direct sunlight or strong ambient light, part of the screen may appear white even when TV is power off. This is due to the strong light reflecting off the TV screen and reflections coming behind the screen. This is a structural property of the projection TV and is not a defect.</p> <ul style="list-style-type: none"> <input type="checkbox"/> Position your TV away from such light sources.
“Lamp Replacement message” appears.	<p>It is time for you to replace the projection lamp used in you TV.</p> <ul style="list-style-type: none"> <input type="checkbox"/> Turn to page 76 on “How to Replace the Lamp” and follow the direction on replacing the lamp. <input type="checkbox"/> Use only the lamp designated for your TV model. <input type="checkbox"/> After the lamp is replaced, select the “Lamp Replacement” option then select “Start” in the Setup menu.
The replacement lamp does not light up	<ul style="list-style-type: none"> <input type="checkbox"/> The lamp door or lamp might not be securely attached. Repeat the steps on page 76 to ensure that they are both installed securely.

PC Input Signal Compatibility Chart

Resolution				Horizontal frequency (kHz) (Refresh rate)	Vertical frequency (Hz)	VESA standard
Signals	Horizontal (Dot)	x	Vertical (Line)			
VGA	640	x	480	31.5	60	—*
	640	x	480	37.5	75	✓
	640	x	480	43.3	85	✓
	720	x	400	31.5	70	—*
SVGA	800	x	600	35.2	56	✓
	800	x	600	37.9	60	✓
	800	x	600	46.9	75	✓
	800	x	600	48.1	72	✓
XGA**	1024	x	768	48.4	60	✓
	1024	x	768	56.5	70	✓
	1024	x	768	60	75	✓
WXGA**	1280	x	768	47.4	60	✓
	1280	x	768	47.8	60	✓
	1152	x	648	40.3	60	CVT***

*: Corresponding to the VGA signal

** : These signals do not support Normal display mode.

***: Coordinated Video Timing.

- ⚠ This TV does not support Sync on Green or Composite Sync.
- ⚠ If a signal other than in the above chart is input, it may not be displayed properly or may not be displayed as you set.
- ⚠ For the best picture quality, it is recommended to use signals with a 60Hz vertical frequency from a personal computer. In plug and play, signals with 60Hz vertical frequency will be selected automatically.
- ⚠ Noise may be detected under certain conditions. If unsupported signals are used, you will see the message, "Unsupported Signal".

Specifications

Projection System	3 LCD Panels, 1 lens projection system	
LCD Panel	0.73 inch TFT LCD panel (1,280 × 720 pixels)	
Projection Lens	High Performance, large diameter hybrid lens F2.4	
Antenna	75-ohm external terminal for VHF/UHF	
Lamp	100W, XL-2400 Ultra High Pressure Lamp	
Television System	NTSC	American TV Standard
	ATSC (8VSB terrestrial)	ATSC compliant 8VSB
	QAM on cable	ANSI/SCTE 07 2000
Visible Screen Size (Picture measured diagonally)	KDF-42E2000:	42 inches
	KDF-46E2000:	46 inches
	KDF-50E2000:	50 inches
	KDF-55E2000:	55 inches
Channel Coverage	Terrestrial (analog)	2-69
	Cable TV (analog)	1-125
	Terrestrial (digital)	2-69
	Cable TV (digital)	1-135
Number of Inputs/Outputs	HDMI IN	2 Video 1 Audio
		1080i, 720p, 480p, 480i, PC Two channel linear PCM 32, 44.1 and 48 kHz, 16, 20 and 24 bit
Video (IN)	3 total (1 on side panel)	1 Vp-p, 75 ohms unbalanced, sync negative
S Video (IN)	1	Y: 1 Vp-p, 75 ohms unbalanced, sync negative C: 0.286 Vp-p (Burst signal), 75 ohms
Audio (IN)	5 total (1 on side panel)	500 mVrms (100% modulation) Impedance: 47 kilohms
Component Video Input	3 (YPbPr) (1 on side panel)	Y: 1 Vp-p, 75 ohms unbalanced, sync negative Pb: 0.7 Vp-p, 75 ohms Pr: 0.7 Vp-p, 75 ohms
AUDIO (VAR/FIX) OUT	1	500 mVrms at the maximum volume setting (Variable) 500 mVrms (Fixed) Impedance (output): 2 kilohms
RF Inputs	2	
Digital Audio Optical Output (PCM/Dolby Digital)	1	Optical Rectangular (1)
Speaker output	12 W + 12 W	
Power requirement	120 V, 60 Hz	
Power consumption	In use: 200 W	
	In standby: 0.8 W	

Dimensions (W/H/D)	KDF-42E2000: 999 × 722 × 357 mm (39 3/8 × 28 1/2 × 14 1/8 inches) KDF-46E2000: 1096 × 766 × 382 mm (43 1/4 × 30 1/4 × 15 1/8 inches) KDF-50E2000: 1184 × 827 × 408 mm (46 5/8 × 32 5/8 × 16 1/8 inches) KDF-55E2000: 1301 × 907 × 442 mm (51 1/4 × 35 3/4 × 17 1/2 inches)
Mass	KDF-42E2000: 25.3 kg (55.8 lb.) KDF-46E2000: 27 kg (59.5 lb.) KDF-50E2000: 29.3 kg (64.7 lb.) KDF-55E2000: 34 kg (75 lb.)
Supplied Accessories	
Remote Control	RM-YD010
AA (R6) Batteries	2 supplied for remote control
Operating Instructions	1
Quick Setup Guide	1
Warranty Card	1
Product Registration Card	1

Design and specifications are subject to change without notice.

Non-metric weights and measures are approximate.

Optional accessories:

- HDMI cable
- HDMI-to-DVI cable
- Component video cable
- S VIDEO cable
- A/V cable
- Audio cable
- Optical cable
- TV Stand : (SU-RG11S for KDF-42E2000, SU-RG12S for KDF-46E2000, SU-RG12L for KDF-50/55E2000)
- Lamp : XL-2400 Ultra High Pressure Lamp

 **The availability of optional accessories depends on stock.**

Index

- 0-9 buttons 39
- 4:3 Default 65
- 5.1 Channel DVD using with remote control 44

A

- A/V Sync 63
- Adding channels to the channel list 66
- Adjusting audio, Steady Sound 62
- Advanced Iris 59
- Advanced Settings 61
- Alternate Audio 63
- ANT button 39
- AUDIO (L/R) jacks, described 19
- Audio Out 63
- AUDIO OUT jack, described 19
- Audio receiver, connecting 37
- Auto Program 66
- Auto Wide 65

B

- Balance, adjusting 62
- Bass, adjusting 62
- Batteries, inserting in remote 38
- BBE 62
- Blu-ray Disc player
 - using with remote control 44
- Brightness, adjusting 60

C

- Cable
 - connecting with VCR 30
 - using with remote control 43
- Cable Box
 - connecting with VCR 31
- Camcorder connection 36
- Caption Vision
 - programming 74
- Caption Vision (CC) 71

- Change Password 69
- CHANNEL +/- button 17
- Channel settings 58, 66
- Channel Show/Hide 66
- Channels
 - Auto Program 66
 - creating labels 67
- CineMotion 9, 73
- Clear White 61
- Clock/Timers 72
- Closed caption modes 71
- Color Temp., adjusting 60
- Color, adjusting 60
- Connecting
 - Audio receiver 37
 - Camcorder 36
 - DVD player 33–34
 - Personal Computer 35
 - VCR 30–32
- Cooling Mode 73

D

- Diagnostics 67
- Digital Channels 66
- Digital Rating 68
- Digital subchannels 48
- Display Area 65
- DISPLAY button 40
- Display, turning off 40
- DRC Mode 60
- DRC Palette 61
- DVD player
 - using with remote control 43
 - with A/V connectors, connecting 34
 - with component video connectors, connecting 33

E

- English Rating 70
- ENT button 39
- External Inputs, MENU 53, 54

F

- Favorite Channels
 - setting up 66
- Favorites, MENU 53, 54
- FREEZE button 40, 47
- French Rating 70
- FUNCTION button 39

G

- Gamma 61
- GUIDE button 48
- Guide menu 48

H

- HD/DVD IN jack (1080i/720p/480p/480i), described 19
- HDMI 19
- HDMI IN jack, described 19
- High-Definition Multimedia Interface (HDMI) 9
- Horizontal Center 65
- Hue, adjusting 60

I

- Infrared Receiver (IR) 17
- Inputs, labeling 71

J, K

- JUMP 47
- JUMP button 39

L

- Label
 - Channels 67
- Label Video Inputs 71
- LAMP LED 17
- Lamp Replacement 73
- Lamp, replacing 76–79
- Language 72

- M**
 MENU 52
 MENU button 17, 43
 Menu Color 73
 Movie Rating 69
 MTS 63
 MUTING button 40
- N**
 Noise Reduction 60
- O**
 Off, turning off the TV 17
 On, turning on the TV 17
- P, Q**
 Parental Control, described 9
 Parental Lock settings 58, 68
 Password, changing 69
 PC Wide Mode 64
 Personal Computer
 connecting 35
 Picture 60
 PICTURE button 40
 Picture Mode
 Custom 59
 Standard 59
 Vivid 59
 Picture settings 57, 59
 POWER button 17
 POWER/STANDBY LED 17
 Problems, Troubleshooting 80–83
 Product Information 73
 Program Guide 48
 Program Options menu 48
- R**
 Ratings
 setting 69
 viewing blocked programs 69
 Remote control
 inserting batteries 38
 programming 41–42
 Removing channels from the
 channel list 66
 Reset 59, 62
- S**
 S VIDEO jack, described 19
 Satellite receiver, using with
 remote control 43
 Screen settings 57, 64
 Select Country 69
 Settings
 Channel 58, 66
 Parental Lock 58, 68
 Picture 57, 59
 Screen 57, 64
 Setup 58, 71
 Sound 57, 62
 Settings, MENU 53, 56
 Setup settings 58, 71
 Sharpness, adjusting 60
 Show/Hide Channels 66
 Sound Mode 62
 Sound settings 57, 62
 Speaker 17, 63
 Specifications 86–87
 Steady Sound
 adjusting 62
 described 10
 Support Belt 14
 Surround 62
- T, U**
 Timer
 set current 72
 TIMER indicator 12
 TIMER LED 17
 Timer setting 72
 TOOLS button 40
 Treble, adjusting 62
 Troubleshooting 80–83
 Turning on/off the TV 17
 TV FUNCTION button 39
 TV POWER button 40
 TV Rating 70
 TV/VIDEO button 17, 39
 U.S.A. Rating 70
 Unrated 69
- V**
 VCR
 using with remote control 43
 with cable box, connecting 31
 with cable, connecting 30
 Vertical Center 65
 Vertical Size 65
 VHF/UHF jack, described 19
 Video 2 (Component) 73
 VIDEO IN jacks, described 19
 Video inputs, labeling 71
 VIDEO/AUDIO (L/R) jacks,
 described 19
 VISUAL SEARCH 40
 VOL +/- button 40
 VOLUME +/- button 17
 Volume Offset 62
- W, X, Y**
 WEGA Engine 9
 Wide Mode 64
 Wide Screen Mode, described 9

For Your Convenience

Please contact Sony directly if you:

- Have questions on the use of your television after reading your manual
- Experience difficulty operating your television

Contact Sony Customer Support at:

<http://www.sony.com/tvsupport>

or to speak with a support representative:

United States

1-800-222-SONY (7669)

8:00 AM - 10:00 PM (EST) Mon - Fri

10:30 AM - 7:15 PM (EST) Sat - Sun

Canada

1-877-899-SONY (7669)

8:00 AM - 6:00 PM (Eastern)

8:00 AM - 5:00 PM (Western)

Sony will work to resolve your questions more quickly than your retailer or place of purchase.

Please Do Not Return the Product to the Store



2681559131

<http://www.sony.net/>

Printed in U.S.A.