

# SHARP®

## COLOR TELEVISION

### MODELS

# 32UF5/6

## ■ OPERATION MANUAL ■

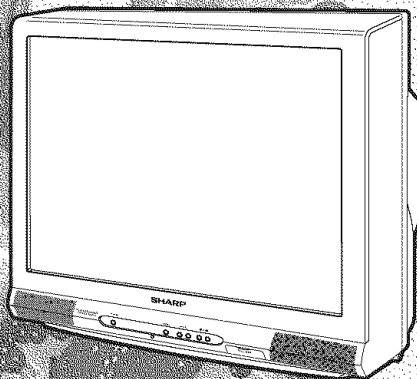

As an ENERGY STAR® Partner, SHARP has determined that this product meets the ENERGY STAR® guidelines for energy efficiency. ENERGY STAR® is a U.S. registered trademark.

## CONTENTS

|   | PAGE    |   | PAGE    |
|---|---------|---|---------|
| • <b>IMPORTANT INFORMATION/IMPORTANT SAFEGUARDS</b> .....     | 2 ~ 4   | • Parent Control .....                        | 15 ~ 25 |
| • Supplied Accessories .....                                  | 5       | • V-CHIP .....                                | 15 ~ 22 |
| • Before Operating Your Television .....                      | 5       | • VIEW TIMER .....                            | 23 ~ 25 |
| • Antenna Connections .....                                   | 5 ~ 6   | • Energy Save .....                           | 26      |
| • Quick Reference Control Operation .....                     | 7       | • Set Up .....                                | 27 ~ 33 |
| • EZ SETUP during First Use .....                             | 8       | • EZ Setup .....                              | 27      |
| • Demo Mode .....   | 9       | • Channel Setting .....                       | 28 ~ 30 |
| • Accessing the MAIN MENU screen without Remote Control ..... | 9       | • Blue Screen .....                           | 30 ~ 31 |
| • Language .....  | 10      | • Personal Preference .....                   | 32      |
| • Sleep Timer .....   | 10      | • Universal Plus Function .....               | 33      |
| • Video Adjust .....  | 11      | • Auto Input .....                            | 34      |
| • Audio Select .....  | 12 ~ 13 | • CH/INPUT ID .....                           | 35 ~ 36 |
| • MTS (Multichannel TV Sound) .....                           | 12      | • Using the Video and Audio Input Jacks ..... | 37 ~ 38 |
| • INTERNAL SPEAKER SWITCH .....                               | 12      | • Using the Audio Output Jacks .....          | 37 ~ 39 |
| • FAO (Fixed Audio Output) .....                              | 12      | • Operation of Remote Control .....           | 40 ~ 44 |
| • AUDIO ADJUST .....  | 13      | • Before Calling for Service .....            | 45      |
| • Closed Caption .....  | 14      | • Calling for Service .....                   | 45      |
|   |         | • Specifications .....                        | 46      |
|   |         | • Limited Warranty .....                      | 59      |

This operating manual includes basic operating instructions in Spanish and French.  
SPANISH is on page 47 ~ 51.  
FRENCH is on page 52 ~ 56.

## A759 N1

Welcome to the SHARP Family. We are pleased that you are now the owner of a SHARP Color Television – built for outstanding quality, reliability and performance. Every SHARP Color Television set is tuned and adjusted for proper color and sound, and has passed through the most stringent quality control tests at the factory. We have prepared this OPERATION MANUAL so that you may adjust the picture and color to your personal viewing preference. We sincerely hope that you receive the greatest satisfaction and enjoyment from your new SHARP Color Television set for years to come. Please read these instructions carefully, and keep them handy for your future reference.

**IMPORTANT**

To aid reporting in case of loss or theft, please record the TV's model and serial numbers in the space provided. The numbers are located at the rear of the TV.

|                    |
|--------------------|
| <b>Model No.:</b>  |
| <b>Serial No.:</b> |

# IMPORTANT INFORMATION

There are two important reasons for prompt warranty registration of your new SHARP television set. Use the REGISTRATION CARD packed in with the set.

**FIRST – WARRANTY**

This is to assure that you will immediately receive the full consumer benefit of the parts, service and labor warranty applicable to your purchase.

**SECOND – CONSUMER PRODUCT SAFETY ACT**

To assure that you will promptly receive any safety notification on inspection, modification or recall that SHARP may be required to give under the 1972 Consumer Product Safety Act. PLEASE READ CAREFULLY THE IMPORTANT "LIMITED WARRANTY" CLAUSE ON THE LAST PAGE.

**WHAT IS ENERGY STAR®**

TVs and VCRs use energy both when they are on and when they are off. Americans spend more than \$1 billion a year on energy consumed by TVs and VCRs when they are not in use. The new ENERGY STAR® models will reduce that energy "leakage" by up to 75 percent. Ultimately, this will mean more than \$500 million a year in energy savings for consumers.

The energy savings will help reduce the burning of fossil fuels and the related carbon dioxide pollution that contributes to global warming. If every American family replaced their TVs and VCRs with ENERGY STAR® models, it would reduce carbon dioxide emissions by five million tons every year — equivalent to eliminating the pollution from more than one million cars.

By using ENERGY STAR® products, you will save money on your electric bills and use less energy. That makes good economic sense and it's good for our environment.

**WARNING:** TO REDUCE THE RISK OF FIRE OR ELECTRIC SHOCK, DO NOT EXPOSE THIS APPLIANCE TO WET LOCATIONS.

|  |
|--|
|  <div style="display: inline-block; border: 1px solid black; padding: 5px; text-align: center;"> <p><b>CAUTION</b><br/>RISK OF ELECTRIC SHOCK<br/>DO NOT OPEN</p> </div>  |
| <p><b>CAUTION:</b> TO REDUCE THE RISK OF ELECTRIC SHOCK, DO NOT REMOVE COVER (OR BACK). NO USER-SERVICEABLE PARTS INSIDE. REFER SERVICING TO QUALIFIED SERVICE PERSONNEL.</p>  |

 The lightning flash with arrowhead within a triangle is intended to tell the user that parts inside the product are a risk of electric shock to persons.

 The exclamation point within a triangle is intended to tell the user that important operating and servicing instructions are in the papers with the appliance.

"Note to CATV system installer: This reminder is provided to call the CATV system installer's attention to Article 820-40 of the National Electrical Code that provides guidelines for proper grounding and, in particular, specifies that the cable ground shall be connected to the grounding system of the building, as close to the point of cable entry as practical."

# IMPORTANT INFORMATION (Continued)

**WARNING** – FCC Regulations state that any unauthorized changes or modifications to this equipment not expressly approved by the manufacturer could void the user's authority to operate this equipment.

## PRODUCT DISPOSAL

This product utilizes a Cathode Ray Tube (CRT) containing lead and tin lead solder. Disposal of these materials may be regulated due to environment considerations. For disposal or recycling information, please contact your local authorities or the Electronics Industries Alliance: [www.eiae.org](http://www.eiae.org)

**CAUTION:** Do not place the AC power cord under the TV set or other heavy items.

# IMPORTANT SAFEGUARDS

**CAUTION:** Please read all of these instructions before you operate your television and save these instructions for later use.

Electrical energy can perform many useful functions. This unit has been engineered and manufactured to assure your personal safety. BUT IMPROPER USE CAN RESULT IN POTENTIAL ELECTRICAL SHOCK OR FIRE HAZARDS. In order not to defeat the safeguards incorporated in this equipment, observe the following basic rules for its installation, use and servicing.

1. Unplug this television equipment from the wall outlet before cleaning.
2. Do not use liquid cleaners or aerosol cleaners. Use a damp cloth for cleaning.
3. Do not use attachments not recommended by the television equipment manufacturer as they may cause hazards.
4. Do not use this television equipment near water — for example, near a bath tub, washbowl, kitchen sink or laundry tub, in a wet basement, or near a swimming pool, etc.
5. Do not place this equipment on an unstable cart, stand, or table. The television equipment may fall, causing serious injury to a child or an adult, and serious damage to the equipment. Use only with a cart or stand recommended by the manufacturer or sold with the television equipment.
6. Television equipment and cart combination should be moved with care. Quick stops, excessive force, and uneven surfaces may cause the equipment and cart combination to overturn.
7. Wall or shelf mounting should follow the manufacturer's instructions, and should use a mounting kit approved by the manufacturer.
8. Slots and openings in the cabinet and the back or bottom are provided for ventilation. To insure reliable operation of the television equipment and to protect it from overheating, these openings must not be blocked or covered. This television equipment should not be placed in a built-in insulation such as a bookcase unless proper ventilation is provided.
9. The openings should never be covered with a cloth or other material, and the bottom openings should not be blocked by placing the television equipment on a bed, sofa, rug, or other similar surface. This television equipment should never be placed near or over a radiator or heat register.
10. This television equipment should be operated only from the type of power source indicated on the marking label. If you are not sure of the type of power supplied to your home, consult your television dealer or local power company.



For television equipment designed to operate from battery power, refer to the operating instructions.

11. As a safety feature, television equipment is equipped with a 2-wire polarized plug (one plug blade bigger than the other). The 2-wire polarized plug will fit only one way into the power outlet.  
If the plug does not fit, ask your electrician to replace your obsolete outlet. Do not modify the plug and defeat this safety feature.
12. Do not allow anything to rest on the power cord. Do not locate this television equipment where the cord will be abused by persons walking on it.

# IMPORTANT SAFEGUARDS (Continued)

13. Follow all warnings and instructions marked on the television equipment.
14. If an outside antenna is connected to the television equipment, be sure the antenna system is grounded so as to provide some protection against voltage surges and built-up static charges. Section 810 of the National Electrical Code provides information with respect to proper grounding of the mast and supporting structure, grounding of the lead-in wire to an antenna discharge unit, size of grounding conductors, location of antenna-discharge unit, connection to grounding electrodes, and requirements for the grounding electrode.

## EXAMPLE OF ANTENNA GROUNDING ACCORDING TO NATIONAL ELECTRICAL CODE.

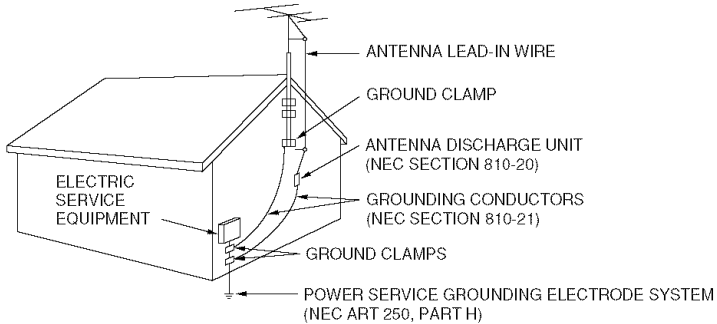

### NEC - NATIONAL ELECTRICAL CODE

15. For added protection for this television equipment during a lightning storm, or when it is left unattended and unused for long periods of time, unplug it from the wall outlet and disconnect the antenna. This will prevent damage to the equipment due to lightning and power-line surges.
16. An outside antenna system should not be located in the vicinity of overhead power lines or other electric light or power circuits, or where it can fall into such power lines or circuits. When installing an outside antenna system, extreme care should be taken to keep from touching such power lines or circuits as contact with them might be fatal.
17. Do not overload wall outlets and extension cords as this can result in fire or electric shock.
18. Never push objects of any kind into this television equipment through cabinet slots as they may touch dangerous voltage points or short out parts that could result in a fire or electric shock. Never spill liquid of any kind on the television equipment.
19. Do not attempt to service this television equipment yourself as opening or removing covers may expose you to dangerous voltage or other hazards. Refer all servicing to qualified service personnel.
20. Unplug this television equipment from the wall outlet and refer servicing to qualified service personnel under the following conditions:
  - A. When the power cord or plug is damaged or frayed.
  - B. If liquid has been spilled into the television equipment.
  - C. If the television equipment has been exposed to rain or water.
  - D. If the television equipment does not operate normally by following the operating instructions. Adjust only those controls that are covered by the operating instructions as improper adjustment of other controls may result in damage and will often require extensive work by a qualified technician to restore the television equipment to normal operation.
  - E. If the television equipment has been dropped or the cabinet has been damaged.
  - F. When the television equipment exhibits a distinct change in performance — this indicates a need for service.
21. Upon completion of any service or repairs to this television equipment, ask the service technician to perform routine safety checks to determine that the television is in safe operating condition.
22. When replacement parts are required, be sure the service technician has used replacement parts specified by the manufacturer that have the same characteristics as the original part. Unauthorized substitutions may result in fire, electric shock, or other hazards.

## Supplied Accessories

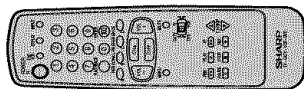

Infrared Remote Control/Part Number  
RRMCGA035WJSA (32UF5)  
RRMCGA035WJSB (32UF6)



Size AA  
Dry Batteries

## Before Operating Your Television

### Location

- For normal operation, your TV should be located in an area of the room where cool adequate ventilation is provided. Do not place the back of the television set in a place where free airflow will be restricted.
- Any magnetic force may disturb the color picture. Make sure that magnets, electric clocks, toys using magnets or any other magnetic substance, such as iron are kept well away from the TV set.

### Power

Your TV operates on 120 Volts, 60 Hz (normal household current) and has a polarized plug. If you are unable to insert the plug fully into the outlet, try reversing the plug. Should it fail to fit, contact an electrician. Do not defeat the safety feature of the polarized plug.

### Note:

- If the set will not be used for a long period, such as during a vacation, unplug the set from the wall outlet to economize power. (If the TV set is plugged in, a slight current still flows, even with the POWER BUTTON in the OFF position.)
- Lines and other noise may appear in TV broadcast images when an FM tuner or radio is located near the TV and both radio and TV broadcasts are being received. Should such noise appear, turn off the radio.
- If you are listening to an AM broadcast, turn the TV off. AM broadcast signals may not be received due to interference from the TV.

### ■ Before using the television, prepare the Remote Control

To use the remote control, insert batteries first.

#### Insert the batteries



- With your thumbnail, pull up the slit as indicated by the arrow to remove the back cover. Insert two batteries (size "AA"). Be sure to match the battery  $\oplus/\ominus$  terminals with the  $\oplus/\ominus$  marks inside the compartment.

## Antenna Connections

### Antennas

- The antenna requirements for good color television reception are more important than those for black & white television reception. For this reason, a good quality outdoor antenna is strongly recommended.

The following is a brief explanation of the type of connections that are provided with the various antenna systems:

1. A 75 ohm system is generally a round cable with F-type connector that can easily be attached to a terminal without tools (not supplied).
2. A 300 ohm system is a flat "twin-lead" cable that can be attached to a 75 ohm terminal through a 300-75 ohm ADAPTOR (not supplied).

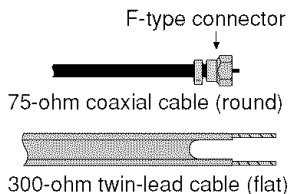

# Antenna Connections (Continued)

## OUTDOOR ANTENNA CONNECTION

- Use one of the following two diagrams if you connect an outdoor antenna.
  - A: Using a VHF/UHF combination outdoor antenna.
  - B: Using separate VHF and/or UHF outdoor antenna.
- Connect an outdoor antenna cable lead-in to the COAXIAL CABLE CONNECTOR on the rear of the TV set.

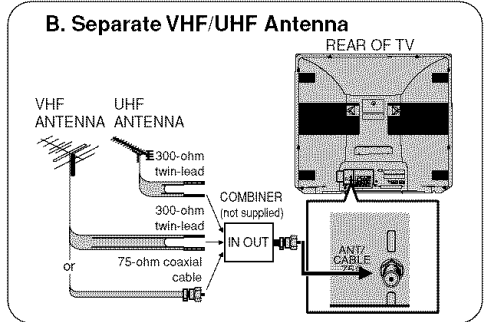
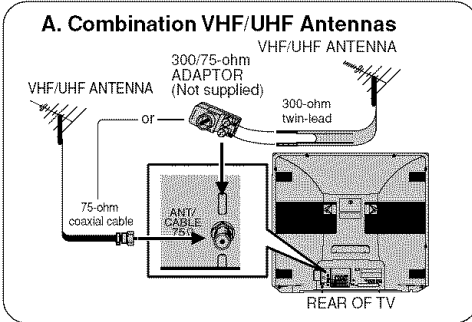

- The design may be slightly different depending on the model.

## NOTICE

### F-type connector should be finger tightened only

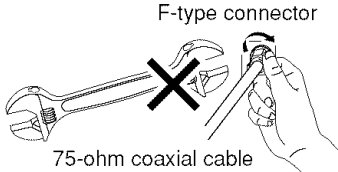

When connecting the RF cable to the TV set, do not tighten F-type connector with tools. If tools are used, it may cause damage to your TV set. (The breaking of internal circuit, etc.)

## CABLE TV (CATV) CONNECTION

- A 75 ohm coaxial cable connector is built into the set for easy hookup. When connecting the 75 ohm coaxial cable to the set, screw the 75 ohm cable to the COAXIAL CABLE CONNECTOR.
  - Some cable TV companies offer "premium pay channels". Since the signals of these premium pay channels are scrambled, a cable TV converter/descrambler is generally provided to the subscriber by the cable TV company. This converter/descrambler is necessary for normal viewing of the scrambled channels. (Set your TV on channel 3 or 4. Typically one of these channels is used. If this is unknown, consult your cable TV company.) For more specific instructions on installing cable TV, consult your cable TV company. One possible method of utilizing the converter/descrambler provided by your cable TV company is explained below.
- Please note: RF switch equipped with position A/B (not provided) is required.

"A" position on the RF switch (not supplied) : You can view all unscrambled channels using the TV's channel keys.

"B" position on the RF switch (not supplied) : You can view the scrambled channels via the converter/descrambler using the converter's channel keys.

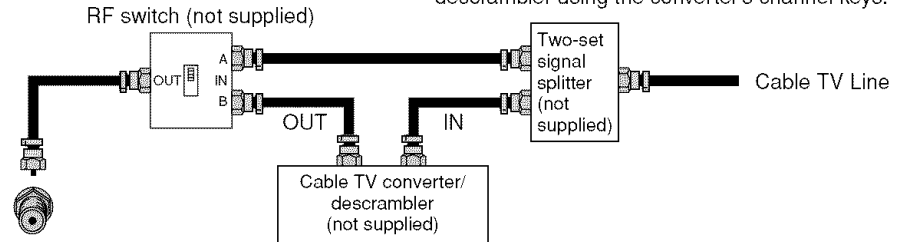

### Note:

- Consult your SHARP Dealer or Service Center for the type of splitter, RF switch or combiner that might be required.

# Quick Reference Control Operation

## Location of Controls

### Front Panel

#### POWER

Press → On.  
Press again → Off.

SENSOR AREA FOR  
REMOTE CONTROL

#### MENU

Press → Accesses MAIN MENU.  
Press again → Exits MAIN MENU.

#### VOLUME UP/DOWN

(+) Increases sound.  
(-) Decreases sound.

VIDEO/AUDIO IN 2  
TERMINALS  
(INSIDE DOOR)

#### CHANNEL UP/DOWN

(▲) Selects next higher channel.

(▼) Selects next lower channel.

- Press both at the same time to access the MAIN MENU screen.

## Basic Remote Control Functions

#### POWER

Press → On.  
Press again → Off.

#### REMOTE KEYPAD

Accesses any channel from keypad.

#### FLASHBACK

Returns to previous channel.

#### PERSONAL PREFERENCE

With the Personal Preference buttons, you can program your favorite programs by using the 4 categories A, B, C and D. The channels can be accessed quickly by using these buttons. (See page 32.)

#### VOLUME UP/DOWN

(+) Increases sound.  
(-) Decreases sound.

- In menu mode, changes or selects the TV adjustments.

#### MENU

Press → Accesses MAIN MENU.  
Press again → Exits MAIN MENU.

#### CATV/DVD-TV/VCR MODE SELECT SWITCH

In TV/VCR position, sends power and channel select commands (Channel up/down and Random Access buttons) to the TV and VCR control.

In CATV/DVD position, sends power and channel select commands to a cable TV converter and DVD control.

#### DVD/VCR CONTROL

See page 40.

Infrared Transmitter Window

#### DISPLAY

Press → Displays receiving channel for four seconds.

Press again → Removes display.

- Temporarily displays receiving channel when in Closed Caption mode.

#### INPUT

Press → Switch to external video INPUT 1 mode.

Press 2 times → Switch to external video INPUT 2 mode.

Press 3 times → Switch to external video INPUT 3 mode or COMPONENT mode.

Press 4 times → Switch back to the original TV mode.  
See page 38.

#### ENTER

Used in some instances where a Cable Converter Box requires an "enter" command after selecting channels, when using the REMOTE KEYPAD button. (See page 39)

#### CHANNEL UP/DOWN

(▲) Selects next higher channel.

(▼) Selects next lower channel.

- See pages 28 ~ 30 for channel presetting.
- Moves the "●" mark of the MENU screens.

#### MUTE

Press → Mutes sound.

Press again → Restores sound.

- CLOSED CAPTION appears when sound is muted.

### Note:

- The above shaded buttons on the Remote Control glow in the dark. To use the glow-in-the-dark display on the remote control, place it under a fluorescent light or other lighting.
- The phosphorescent material contains no radioactive or toxic material, so it is safe to use.
- The degree of illumination will vary depending on the strength of lighting used.
- The degree of illumination will decrease with time and depending on the temperature.
- The time needed to charge the phosphorescent display will vary depending on the surrounding lighting.
- Sunlight and fluorescent lighting are the most effective when charging the display.

# EZ SETUP during First Use

- When you turn on the TV for the first time, it will automatically memorize the broadcast channels.

Please perform the following instructions before pressing the **POWER** button.

- (1) Insert the batteries into the remote control. (See page 5)
- (2) Connect the antenna cable to the TV set. (See page 5 ~ 6)
- (3) Plug in the AC POWER cord to the wall outlet.

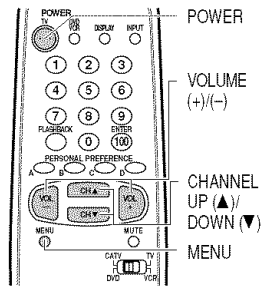

- 1 Press the **POWER** button on the TV set or on the Remote Control to turn on the TV. The SELECT LANGUAGE mode will be displayed.

(On the Set) (Remote Control)

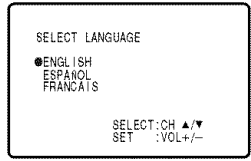

(SELECT LANGUAGE screen)

- 2 Press **CH ▲/▼** to select "ENGLISH", "SPANISH (ESPAÑOL)" or "FRENCH (FRANÇAIS)".



- 3 Press **VOL +/-** to access EZ SETUP screen.

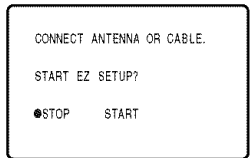

(EZ SETUP screen)

- 4 Press **VOL +**.  
The tuner will automatically search for the broadcast and cable TV channels. (The CH No. will automatically increase when it appears.)

If you want to stop the EZ SETUP process once it has started, press **VOL -** and it will be canceled.

If you want to SETUP again, please refer to page 34 on SETUP.

### To cancel EZ SETUP

Press **VOL -**.

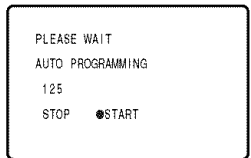

- 5 Once EZ SETUP is completed, the lowest channel number memorized will be displayed.



2

### Note:

- If EZ SETUP does not memorize all the channels in your region, please refer to page 28 for more information on manually memorizing the channels using CHANNEL SETTING.
- It may be difficult to PRESET when the broadcast signals are weak, the channel cycle frequency is incorrect or frequency jamming is occurring around the area. Please refer to pages 28 ~ 30 for more information on manually memorizing the channels using CHANNEL SETTING.



## Demo Mode

- To quickly learn more about the TV set, press and hold for more than three seconds **MENU** or both **CH ▲/▼** on the TV set. The TV set will go into DEMO mode and briefly explain the various features.
- To cancel DEMO mode, again press **MENU** or both **CH ▲/▼** on the TV set.

### Example:

DEMO mode display



(On the Set)

**MENU**



**MENU**  
button

## Accessing the MAIN MENU screen without Remote Control

- If you misplaced your Remote Control you can still access most settings via the MAIN MENU screen when you press **MENU** on the TV set.
- Some features of your TV set will not be accessible without the Remote Control. If you lost your Remote Control, contact a Sharp Service Center for a replacement.

(On the Set)

**MENU**



**MENU** button

# Language

- The language for the ON SCREEN DISPLAY can be set to ENGLISH, SPANISH or FRENCH.

1 Press **MENU** to access the MAIN MENU screen.

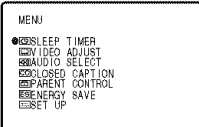

(MAIN MENU screen)

2 Press **CH ▲/▼** to move the “●” mark to “SET UP”.

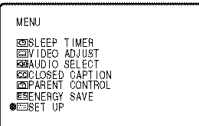

3 Press **VOL +/-** to access the SET UP screen, then press **CH ▲/▼** to move the “●” mark to “LANGUAGE”.

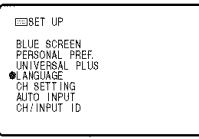
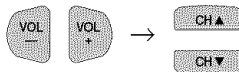

(SET UP screen)

4 Press **VOL +/-** to access the LANGUAGE select screen.

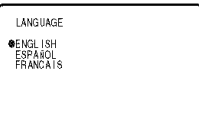

(LANGUAGE select screen)

5 Press **CH ▲/▼** to select “ENGLISH”, “ESPAÑOL (SPANISH)” or “FRANCAIS (FRENCH)”.

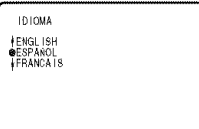

6 Press **MENU** to exit.



# Sleep Timer

- You can preset your television to turn off automatically in increments of 30, 60, 90, or 120 minutes.

1 Press **MENU** to access the MAIN MENU screen.

2 Press **VOL +/-** to access the SLEEP TIMER screen.

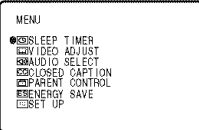
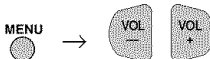

3 Press **VOL +/-** to set a sleep time of 30, 60, 90 or 120 minutes.

4 Press **MENU** to exit.

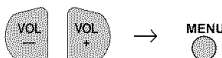

(SLEEP TIMER screen)

## Note:

- To turn off the SLEEP TIMER, repeat the above SLEEP TIMER steps and select “--- M REMAIN” during step 3.
- While SLEEP TIMER is active, the time remaining will be briefly displayed on-screen at regular intervals or when the Remote’s **DISPLAY** key is pressed twice. 5 minutes before the SLEEP TIMER turns off the TV, the screen prompts the time remaining for 4 seconds. The SLEEP TIMER shows a similar display for each remaining minute and a 10-second display right before shutting off the TV.
- If you turn the POWER OFF, the SLEEP TIMER will automatically reset.

# Video Adjust

## • Description of Adjustment Items

| Selected item | VOL + button  | VOL - button                |
|---------------|---|-----------------------------|
| PICTURE       | To increase contrast                                | To decrease contrast        |
| TINT          | To make skin tones greenish                         | To make skin tones purplish |
| COLOR         | To increase color intensity                         | To decrease color intensity |
| BRIGHT        | To increase brightness                              | To decrease brightness      |
| SHARP         | To increase sharpness                               | To decrease sharpness       |
| COLOR TEMP.   | To choose a LOW, ML, MH or HIGH color tone.         |                             |
| RESET         | To return all adjustments to factory preset levels. |                             |

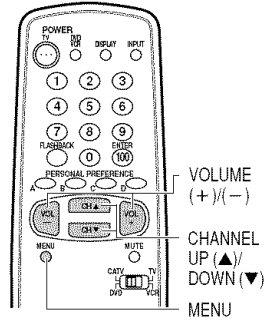

- 1 Press **MENU** to access the MAIN MENU screen.
- 2 Press **CH ▲/▼** to move the "●" mark to "VIDEO ADJUST".

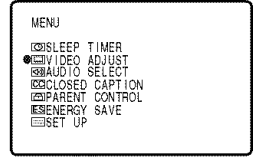
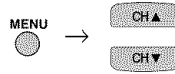

(MAIN MENU screen)

- 3 Press **VOL +/-** to access the PICTURE adjust screen.

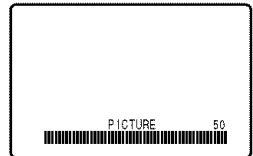

(PICTURE adjust screen)

- 4 Press **CH ▲/▼** to select the desired adjustment item. (Refer to the diagram below.)

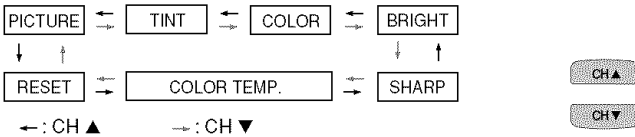

- 5 Press **VOL +/-** to adjust the setting.

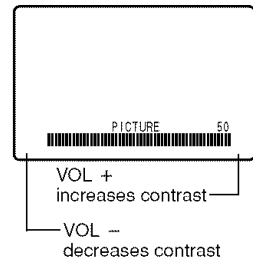
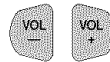

- 6 Repeat steps 4 to 5 to adjust other settings.

- 7 Press **MENU** to exit.



### Note

- VIDEO ADJUST setting, once set, is shared among AIR/CABLE, INPUT 1, INPUT 2, and INPUT 3 modes.
- VIDEO ADJUST setting for INPUT 3 when used as COMPONENT can be set independently. **11**

# Audio Select

## ■ MTS (Multichannel TV Sound)

This function allows reception of stereo or bilingual TV sound.

- You can enjoy Hi-Fi stereo sound or SAP broadcasts where available.

Stereo broadcasts

Live television broadcasts of sports, shows, concerts, etc. can be received in dynamic stereo sound.

SAP broadcasts

Television broadcast can be received with either MAIN or SAP sound.

MAIN sound: The normal program soundtrack. (Monaural or stereo where available.)

SAP sound: Second language, supplementary commentaries, etc. (SAP sound is monaural.)

- If stereo sound is difficult to hear;

You can obtain clearer sound by manually switching to fixed monaural mode.

## ■ SPEAKER (Internal Speaker Switch)

This function turns the TV's internal speakers "ON" or "OFF" when listening to sound from external speakers by using the AUDIO OUTPUT Terminals. (See page 39).

## ■ FAO (Fixed Audio Output)

This function turns the TV's internal speakers "OFF" and allows fixed audio output from the AUDIO OUTPUT Terminals. (See page 39). With FAO, the TV's volume control is disabled.

- 1 Press **MENU** to access the MAIN MENU screen.

- 2 Press **CH ▲/▼** to move the "●" mark to "AUDIO SELECT".

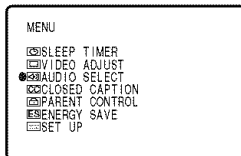
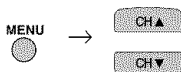

(MAIN MENU screen)

- 3 Press **VOL +/-** to access the AUDIO SELECT screen.

- 4 Press **CH ▲/▼** to move the "●" mark to "MTS", "SPEAKER", "FAO" or "AUDIO ADJUST".

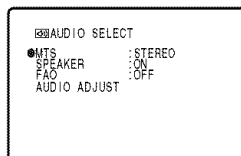
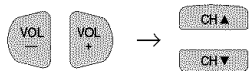

(AUDIO SELECT screen)

- 5 Press **VOL +/-** to select "STEREO", "SAP" or "MONO" when the "●" mark is at "MTS" position.

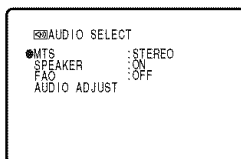
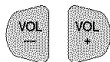
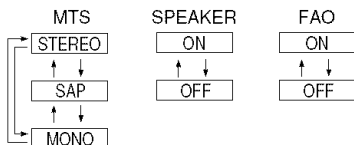

(AUDIO SELECT screen)

# Audio Select (Continued)

## AUDIO ADJUST

When the "●" mark is at "AUDIO ADJUST", press **VOL +/-** to access the AUDIO ADJUST screen. To access the desired item, press **CH ▲/▼**. To adjust the audio setting, press **VOL +/-**.

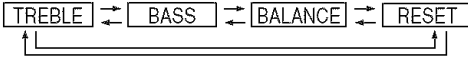

| Selected item | VOL + button  | VOL - button                            |
|---------------|---|---|
| TREBLE        | To increase treble response.                        | To decrease treble response.            |
| BASS          | To increase bass response.                          | To decrease bass response.              |
| BALANCE       | To emphasize the right speaker's volume.            | To emphasize the left speaker's volume. |
| RESET         | To return all adjustments to factory preset levels. |   |

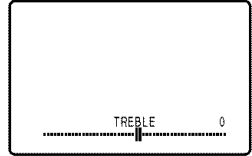

## 6 Press **MENU** to exit.



An example screen displaying ON AIR when receiving stereo broadcasts

Current channel number \_\_\_\_\_

"← ON AIR" will appear next to STEREO or SAP when receiving STEREO or SAP broadcasts.

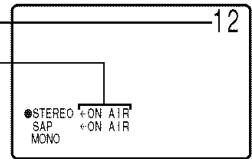

(CHANNEL call on screen)

### Note:

- Once MONO mode is selected, the TV sound remains monaural even if the TV set receives a stereo broadcast. You must switch the mode back to STEREO if you want to hear stereo sound again.
- Selecting MTS while receiving video signals from INPUT terminals does not change the type of sound; in this case, sound is determined by the video source.
- If "FAO" mode is on, "SPEAKER" mode will automatically turn off. Changing "SPEAKER" setting will not affect "FAO" mode.

# Closed Caption

## • How to set CLOSED CAPTION

- Your TV is equipped with an internal Closed Caption decoder. "Closed Caption" is a system which allows conversations, narration, and sound effects in TV programs and home videos to appear as captions on the TV screen (see the illustration).



- Not all the programs and videos will offer closed captioning. Please look for the "CC" symbol to ensure that captions will be shown.

- Closed Caption broadcast can be viewed in two modes: CAPTION and TEXT. For each mode, two channels are available, CH1 and CH2:

The CAPTION mode shows subtitles of dialogs and commentaries of TV dramas and news programs while allowing clear view of the picture.

The TEXT mode displays over the picture other various information (such as TV program schedule, weather forecast, etc.) that is independent of the TV programs.

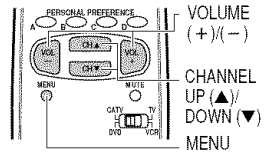

1 Press **MENU** to access the MAIN MENU screen.

2 Press **CH ▲/▼** to move the "●" mark to "CLOSED CAPTION".

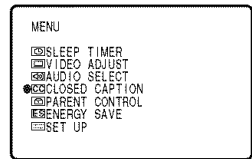
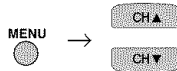

(MAIN MENU screen)

3 Press **VOL +/-** to access the CLOSED CAPTION setting screen.

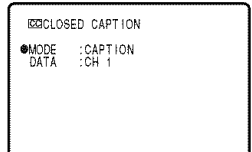
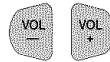

(CLOSED CAPTION setting screen)

4 Press **CH ▲/▼** to move the "●" mark to either "MODE" or "DATA".

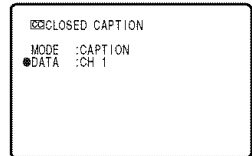

5 Press **VOL +/-** to change the CLOSED CAPTION setting.

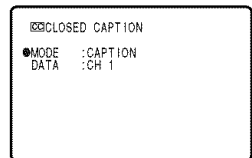
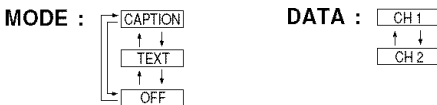

6 Press **MENU** to exit.



### Note:

- If a broadcast contains CLOSED CAPTION and the **MUTE** button is pressed, the set enters CAPTION mode automatically. Pressing **MUTE** again will return the set to its previous condition.
- Closed Caption may malfunction (white blocks, strange characters, etc.) if signal conditions are poor or if there are problems at the broadcast source. This does not necessarily indicate a problem with your TV.
- If any button is pressed to call up the ON SCREEN DISPLAY while viewing a CLOSED CAPTION broadcast, the closed captions will disappear momentarily.
- If no TEXT broadcast is being received while viewing in the TEXT mode, the screen may become dark and blank for some programs. Should this occur, switch the Closed Caption mode to "OFF".

# Parent Control (V-CHIP Operation)

## ■ V-CHIP

- This function allows you to restrict TV programs and also allows you to control TV usage based on FCC data. This function is to prevent your children from watching violence or sexual scenes that may be harmful.
- Restriction of TV programs includes two characters that contain information about the program's MPAA rating and the TV Parental Guidelines. MPAA is restricted by age. TV Parental Guidelines are restricted by age and contents.
- Since a TV program may use either the MPAA rating or the TV Guidelines you should adjust both for complete control.

### [1] MPAA RATING

| RATING    |       |  |
|-----------|-------|--|
| age based | G     | GENERAL AUDIENCES. All ages admitted.  |
|           | PG    | PARENTAL GUIDANCE SUGGESTED. Some material may not be suitable for children.                     |
|           | PG-13 | PARENTS STRONGLY CAUTIONED. Some material may be inappropriate for children under 13.            |
|           | R     | RESTRICTED. Under 17 requires accompanying parent or adult guardian.                             |
|           | NC-17 | NO ONE 17 AND UNDER ADMITTED.  |
|           | X     | X Rating is an older rating that is unified with NC-17 but may be encoded on older movie's data. |

## • MPAA RATING

### Example 1:

"PG-13" in the age-based rating is blocked, this will automatically block the higher ratings "R", "NC-17", "X" also.

#### 1. User setting

|       |       |
|-------|-------|
| G     | ----  |
| PG    | ----  |
| PG-13 | BLOCK |
| R     | BLOCK |
| NC-17 | BLOCK |
| X     | BLOCK |

#### 2. Block table

|       |              |
|-------|--------------|
| G     | not to block |
| PG    | not to block |
| PG-13 | Select block |
| R     | auto-block   |
| NC-17 | auto-block   |
| X     | auto-block   |

### Example 2:

"R" in the age-based rating is blocked, this will automatically block the higher rating "NC-17", "X" also.

#### 1. User setting

|       |       |
|-------|-------|
| G     | ----  |
| PG    | ----  |
| PG-13 | ----  |
| R     | BLOCK |
| NC-17 | BLOCK |
| X     | BLOCK |

#### 2. Block table

|       |              |
|-------|--------------|
| G     | not to block |
| PG    | not to block |
| PG-13 | not to block |
| R     | Select block |
| NC-17 | auto-block   |
| X     | auto-block   |

### Note:

- MPAA RATING is only age-based.

### [2] TV PARENTAL GUIDELINES

| RATING    |                                     | content based                       |                                     |                                     |                                     |                                     |                                     |
|-----------|-------------------------------------|-------------------------------------|-------------------------------------|-------------------------------------|-------------------------------------|-------------------------------------|-------------------------------------|
|           |                                     | AGE                                 | D<br>(Sexually Suggestive Dialog)   | L<br>(Adult Language)               | S<br>(Sexual Situation)             | V<br>(Violence)                     | FV<br>(Fantasy Violence)            |
| age based | TV-Y (All children)                 | <input checked="" type="checkbox"/> | -                                   | -                                   | -                                   | -                                   | -                                   |
|           | TV-Y7 (Direct to Older Children)    | <input checked="" type="checkbox"/> | -                                   | -                                   | -                                   | -                                   | <input checked="" type="checkbox"/> |
|           | TV-G (General Audience)             | <input checked="" type="checkbox"/> | -                                   | -                                   | -                                   | -                                   | -                                   |
|           | TV-PG (Parental Guidance Suggested) | <input checked="" type="checkbox"/> | <input checked="" type="checkbox"/> | <input checked="" type="checkbox"/> | <input checked="" type="checkbox"/> | <input checked="" type="checkbox"/> | -                                   |
|           | TV-14 (Parents Strongly Cautioned)  | <input checked="" type="checkbox"/> | <input checked="" type="checkbox"/> | <input checked="" type="checkbox"/> | <input checked="" type="checkbox"/> | <input checked="" type="checkbox"/> | -                                   |
|           | TV-MA (Mature Audience Only)        | <input checked="" type="checkbox"/> | -                                   | <input checked="" type="checkbox"/> | <input checked="" type="checkbox"/> | <input checked="" type="checkbox"/> | -                                   |

: Content Rating can be set.

- : Content Rating cannot be set (not normally broadcast by TV station).

# Parent Control (V-CHIP Operation) (Continued)

## TV PARENTAL GUIDELINES (Example)

### Example 1.1 : Age Based setting

Clear s (block) from each "AGE" box for all ratings. This will automatically unblock everything.

|       | AGE                      | D | L | S | V | FV | <input type="checkbox"/> VIEW | <input checked="" type="checkbox"/> BLOCK |
|-------|--------------------------|---|---|---|---|----|-------------------------------|---|
| TV-Y  | <input type="checkbox"/> | - | - | - | - | -  | <input type="checkbox"/>      | <input checked="" type="checkbox"/>       |
| TV-Y7 | <input type="checkbox"/> | - | - | - | - | -  | <input type="checkbox"/>      | <input checked="" type="checkbox"/>       |
| TV-G  | <input type="checkbox"/> | - | - | - | - | -  | <input type="checkbox"/>      | <input checked="" type="checkbox"/>       |
| TV-PG | <input type="checkbox"/> | - | - | - | - | -  | <input type="checkbox"/>      | <input checked="" type="checkbox"/>       |
| TV-14 | <input type="checkbox"/> | - | - | - | - | -  | <input type="checkbox"/>      | <input checked="" type="checkbox"/>       |
| TV-MA | <input type="checkbox"/> | - | - | - | - | -  | <input type="checkbox"/>      | <input checked="" type="checkbox"/>       |

MENU: RETURN

### Example 1.2 : Age Based setting

For "TV-G" put a  in the "AGE" box. This will automatically block the higher age ratings "TV-PG", "TV-14" and "TV-MA" as well as "TV-G". Please note the content ratings "D", "L", "S", "V" are automatically blocked as well.

|       | AGE                                 | D                                   | L                                   | S                                   | V                                   | FV                                  | <input type="checkbox"/> VIEW | <input checked="" type="checkbox"/> BLOCK |
|-------|-------------------------------------|-------------------------------------|-------------------------------------|-------------------------------------|-------------------------------------|-------------------------------------|-------------------------------|---|
| TV-Y  | <input type="checkbox"/>            | -                                   | -                                   | -                                   | -                                   | -                                   | <input type="checkbox"/>      | <input checked="" type="checkbox"/>       |
| TV-Y7 | <input type="checkbox"/>            | -                                   | -                                   | -                                   | -                                   | -                                   | <input type="checkbox"/>      | <input checked="" type="checkbox"/>       |
| TV-G  | <input checked="" type="checkbox"/> | -                                   | -                                   | -                                   | -                                   | -                                   | <input type="checkbox"/>      | <input checked="" type="checkbox"/>       |
| TV-PG | <input checked="" type="checkbox"/> | <input checked="" type="checkbox"/> | <input checked="" type="checkbox"/> | <input checked="" type="checkbox"/> | <input checked="" type="checkbox"/> | <input checked="" type="checkbox"/> | <input type="checkbox"/>      | <input checked="" type="checkbox"/>       |
| TV-14 | <input checked="" type="checkbox"/> | <input checked="" type="checkbox"/> | <input checked="" type="checkbox"/> | <input checked="" type="checkbox"/> | <input checked="" type="checkbox"/> | <input checked="" type="checkbox"/> | <input type="checkbox"/>      | <input checked="" type="checkbox"/>       |
| TV-MA | <input checked="" type="checkbox"/> | <input checked="" type="checkbox"/> | <input checked="" type="checkbox"/> | <input checked="" type="checkbox"/> | <input checked="" type="checkbox"/> | <input checked="" type="checkbox"/> | <input type="checkbox"/>      | <input checked="" type="checkbox"/>       |

MENU: RETURN

### Example 2.1 : Content Based setting

If you choose to unblock every content-based items ("D", "L", "S", "V"), clear the  (block) from each "AGE" box of "TV-PG", "TV-14" and "TV-MA".

|       | AGE                                 | D | L | S | V | FV | <input type="checkbox"/> VIEW | <input checked="" type="checkbox"/> BLOCK |
|-------|-------------------------------------|---|---|---|---|----|-------------------------------|---|
| TV-Y  | <input type="checkbox"/>            | - | - | - | - | -  | <input type="checkbox"/>      | <input checked="" type="checkbox"/>       |
| TV-Y7 | <input type="checkbox"/>            | - | - | - | - | -  | <input type="checkbox"/>      | <input checked="" type="checkbox"/>       |
| TV-G  | <input type="checkbox"/>            | - | - | - | - | -  | <input type="checkbox"/>      | <input checked="" type="checkbox"/>       |
| TV-PG | <input checked="" type="checkbox"/> | - | - | - | - | -  | <input type="checkbox"/>      | <input checked="" type="checkbox"/>       |
| TV-14 | <input checked="" type="checkbox"/> | - | - | - | - | -  | <input type="checkbox"/>      | <input checked="" type="checkbox"/>       |
| TV-MA | <input checked="" type="checkbox"/> | - | - | - | - | -  | <input type="checkbox"/>      | <input checked="" type="checkbox"/>       |

MENU: RETURN

### Example 2.2 : Content Based setting

Put a  in the box corresponding to "TV-PG" (row) and "V (Violence)" (column). This will automatically block the "V" boxes for "TV-14" and "TV-MA". Setting only "TV-PG-V", "TV-14-V" or "TV-MA-V" will not block all programs rated "TV-PG", "TV-14" or "TV-MA".

|       | AGE                                 | D | L | S | V                                   | FV | <input type="checkbox"/> VIEW | <input checked="" type="checkbox"/> BLOCK |
|-------|-------------------------------------|---|---|---|-------------------------------------|----|-------------------------------|---|
| TV-Y  | <input type="checkbox"/>            | - | - | - | -                                   | -  | <input type="checkbox"/>      | <input checked="" type="checkbox"/>       |
| TV-Y7 | <input type="checkbox"/>            | - | - | - | -                                   | -  | <input type="checkbox"/>      | <input checked="" type="checkbox"/>       |
| TV-G  | <input type="checkbox"/>            | - | - | - | -                                   | -  | <input type="checkbox"/>      | <input checked="" type="checkbox"/>       |
| TV-PG | <input checked="" type="checkbox"/> | - | - | - | <input checked="" type="checkbox"/> | -  | <input type="checkbox"/>      | <input checked="" type="checkbox"/>       |
| TV-14 | <input type="checkbox"/>            | - | - | - | <input checked="" type="checkbox"/> | -  | <input type="checkbox"/>      | <input checked="" type="checkbox"/>       |
| TV-MA | <input type="checkbox"/>            | - | - | - | <input checked="" type="checkbox"/> | -  | <input type="checkbox"/>      | <input checked="" type="checkbox"/>       |

MENU: RETURN

### Example 3 : Resetting an Age Based setting

For "TV-14", put a  (block) in the "AGE" box. This will again automatically block the content ratings "D", "L", "S", "V" for "TV-MA" as well as "TV-14" ("D" is not available for "TV-MA"). Please note that the lower age rating "TV-PG" does not change from its previous settings after this.

|       | AGE                                 | D | L | S | V | FV | <input type="checkbox"/> VIEW | <input checked="" type="checkbox"/> BLOCK |
|-------|-------------------------------------|---|---|---|---|----|-------------------------------|---|
| TV-Y  | <input type="checkbox"/>            | - | - | - | - | -  | <input type="checkbox"/>      | <input checked="" type="checkbox"/>       |
| TV-Y7 | <input type="checkbox"/>            | - | - | - | - | -  | <input type="checkbox"/>      | <input checked="" type="checkbox"/>       |
| TV-G  | <input type="checkbox"/>            | - | - | - | - | -  | <input type="checkbox"/>      | <input checked="" type="checkbox"/>       |
| TV-PG | <input type="checkbox"/>            | - | - | - | - | -  | <input type="checkbox"/>      | <input checked="" type="checkbox"/>       |
| TV-14 | <input checked="" type="checkbox"/> | - | - | - | - | -  | <input type="checkbox"/>      | <input checked="" type="checkbox"/>       |
| TV-MA | <input checked="" type="checkbox"/> | - | - | - | - | -  | <input type="checkbox"/>      | <input checked="" type="checkbox"/>       |

MENU: RETURN

## Note:

- Content ratings can be modified but only in the combinations indicated by  in the table on page 15.
- Changing a lower age rating's content setting to "BLOCK" automatically changes the same higher age rating's content setting to "BLOCK" regardless of their previous settings.
- Changing a lower rating's "AGE" setting to "BLOCK" automatically changes all higher ratings to "BLOCK" regardless of their previous settings.
- For "TV-Y7", "TV-PG", "TV-14" and "TV-MA", if you clear the  in the "AGE" box (unblock) you can still change settings based on content.
- Clearing a higher rating's age or content setting will not clear lower settings. Make sure that all undesired boxes are blocked.

## [3] ADDITIONAL MODE

Besides "MPAA RATINGS" and "TV PARENTAL GUIDELINES", new ratings system's data can be downloaded when they become available. (See page 19.)



# Parent Control (V-CHIP Operation) (Continued)

## • How to set V-CHIP

### [1] MPAA RATING

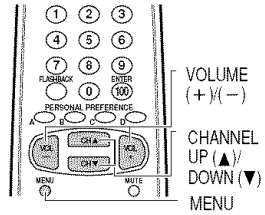

1 Press **MENU** to access the MAIN MENU screen.

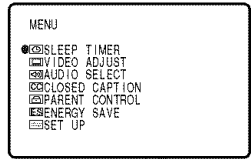

(MAIN MENU screen)

2 Press **CH ▲/▼** to move the "●" mark to "PARENT CONTROL".

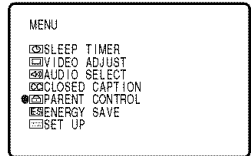

3 Press **VOL +/-** to access the PARENT CONTROL screen.

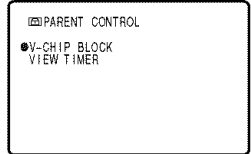
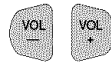

(PARENT CONTROL screen)

4 Press **VOL +/-** to access the V-CHIP select screen.

**Note:**

- If SECRET No. is already set, enter the SECRET No. (See • **To change the V-CHIP BLOCK after registering a secret No.** on page 22.)

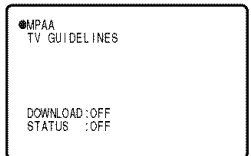
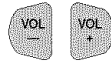

(V-CHIP select screen)

5 Press **VOL +/-** to select "MPAA". Press **CH ▲/▼** to move the "●" mark to "PG", then press **VOL +/-** to select BLOCK. If you set "PG" to BLOCK, "PG-13", "R", "NC-17" and "X" are automatically blocked.

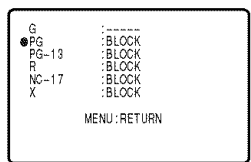

6 Press **MENU** to return to the V-CHIP select screen.



# Parent Control (V-CHIP Operation) (Continued)

7 Press **MENU**, then "INPUT SECRET No." will be displayed.

**Note:**

- If SECRET No. is already set, skip to step 9.



8 Enter a 4-digit SECRET No. using the **REMOTE KEYPAD**.

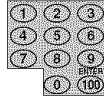

9 When done, press **MENU** to exit.



**Note:**

- If you set "G" to BLOCK, all ratings are automatically blocked.
- If you set "X" to BLOCK, "G", "PG", "PG-13", "R" and "NC-17" are not blocked.

## [2] TV GUIDELINES

1 Repeat steps 1 to 4 of [1] **MPAA RATING**.

2 Press **CH ▲/▼** to move the "●" mark to "TV GUIDELINES".

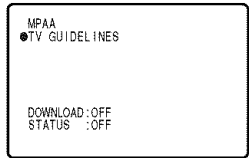

(V-CHIP select screen)

3 Press **VOL +/-** to access the TV GUIDELINES screen.

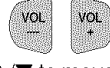

4 To change AGE and CONTENT SETTING, press **CH ▲/▼** to move the "●" mark to the desired rating and then press **VOL +/-** to select.

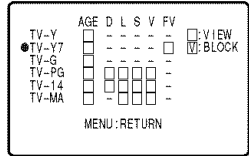
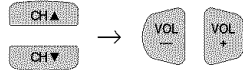

(TV GUIDELINES screen)

5 Press **CH ▲/▼** to move the "●" mark to the desired content item and then press **VOL +/-** to select either "BLOCK" or "-----" (unblock).

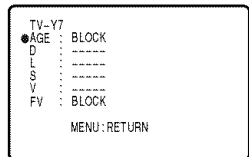
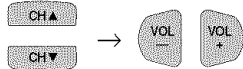

(CONTENT RATING screen)

6 Press **MENU** to return to the TV GUIDELINES screen.

7 Repeat steps 4 to 6 until all ratings and their contents are set.

8 When done, press **MENU** to return to V-CHIP select screen.

9 Press **MENU** to exit.

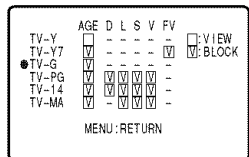

**Note:**

- If SECRET No. is not set, enter a SECRET No. as show in steps 7 and 8 of [1] **MPAA RATING**.

# Parent Control (V-CHIP Operation) (Continued)

## [3] Downloading additional rating mode

There will be an additional new rating system. In that case, please set up as follows. Subsequently the new rating system will set up automatically.

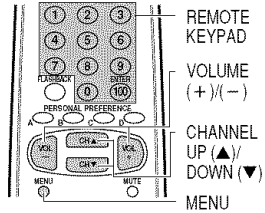

1 Repeat steps 1 to 4 of [1] MPAA RATING.

2 Press **CH ▲/▼** to move the "●" mark to "DOWNLOAD".

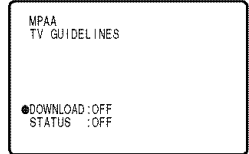

3 Press **VOL +/-** to select "DOWNLOAD : ON".

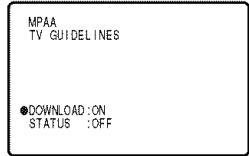
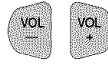

4 Press **MENU**, then "INPUT SECRET No." will be displayed.

### Note:

- If SECRET No. is already set, skip to step 6.



5 Enter a 4-digit secret No. using the **REMOTE KEYPAD**.

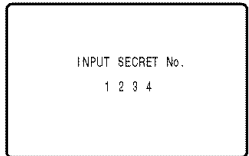

6 Press **MENU** to exit.



## • Downloading V-CHIP data

1 If you watch a program containing "new rating system data", the DOWNLOAD screen will be displayed.



(DOWNLOAD screen)

2 The DOWNLOAD screen will disappear, once downloading is finished.

### Note:

- DOWNLOAD will not start, if you are not watching a program containing "new rating system data".

# Parent Control (V-CHIP Operation) (Continued)

- **How to set additional rating mode (Example)**  
Once downloading is complete, you can set the blocking pattern as follows.

- 1 Repeat steps 1 to 4 of [1] MPAa RATING.
- 2 Press **CH ▲/▼** to move the "●" mark to "Cdn. English Ratings", then press **VOL +/-**.

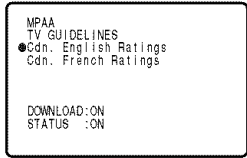
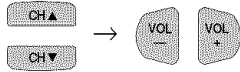

(After downloading the rating data)

- 3 You can select "BLOCK" or "-----" (unlock) for each rating item by pressing **CH ▲/▼** and **VOL +/-**.

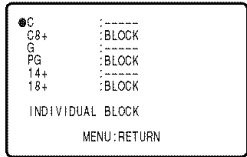
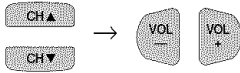

(ENGLISH INDIVIDUAL BLOCK screen)

- 4 You can select "BLOCK" or "-----" (unlock) for each rating item by pressing **CH ▲/▼** and **VOL +/-** if you select "Cdn. French Ratings" in step 2.

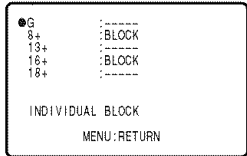
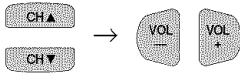

(FRENCH INDIVIDUAL BLOCK screen)

**Note:** ➔

- You are able to download up to 4 different rating systems.

# Parent Control (V-CHIP Operation) (Continued)

## • Activating the V-CHIP BLOCK

1 Repeat steps 1 to 4 of [1] **MPAA RATING**.

2 Press **CH ▲/▼** to move the "●" mark to "STATUS". Press **VOL + / -** to activate the V-CHIP BLOCK. (If STATUS is OFF, V-CHIP BLOCK will not operate.)

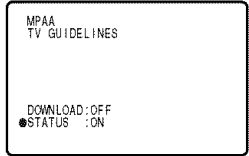
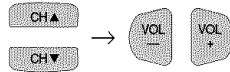

(V-CHIP select screen)

3 Press **MENU**, then "INPUT SECRET No." will be displayed.

### Note:

- If SECRET No. is already set, skip to step 5.



4 Enter a 4-digit secret No. using the **REMOTE KEYPAD**.

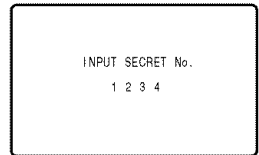
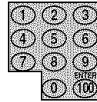

5 Press **MENU** and the secret No. will be registered.



## • To temporarily cancel the V-CHIP BLOCK

1 "V-CHIP HAS BEEN ACTIVATED" appears if you view a program with the same program rating data you configured.

### Note:

- "V-CHIP HAS BEEN ACTIVATED" will not be displayed if STATUS is not configured to "ON".

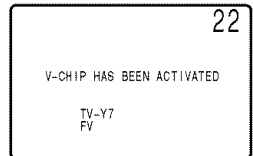

2 Press **MENU**, then "INPUT SECRET No." will be displayed.



3 Enter the 4-digit secret No. using the **REMOTE KEYPAD**, then V-CHIP BLOCK will be canceled temporarily. If the wrong secret No. is chosen, "SECRET No. IS INCORRECT" will be displayed. Input the secret No. again in this case.

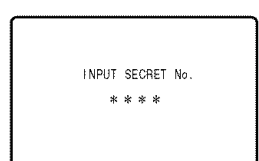
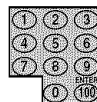

### Note:

- If you turn the power ON from OFF, the V-CHIP BLOCK will be activated again.

## Parent Control (V-CHIP Operation) (Continued)

- To change the V-CHIP BLOCK setting after registering a secret No.

- 1 Repeat steps 1 to 4 of [1] **MPAA RATING**, then "INPUT SECRET No." will be displayed.

INPUT SECRET No.  
- - - -

- 2 Enter the 4-digit secret No. using the **REMOTE KEYPAD** and the V-CHIP select screen will be displayed. Set V-CHIP BLOCK again.

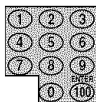

INPUT SECRET No.  
\* \* \* \*

- If you forget or need to change your secret No., clear the original secret No. and set up a new one.

- 1 Repeat steps 1 to 4 of [1] **MPAA RATING**, or 1 to 2 of **To temporarily cancel the V-CHIP BLOCK**, then "INPUT SECRET No." will be displayed.

- 2 Press and hold both **VOL +** and **CH ▲** on the TV set simultaneously until the message "INPUT SECRET No." disappears.

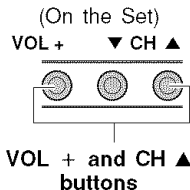

- 3 Press the **MENU** button twice to exit.



# Parent Control (VIEW TIMER)

## VIEW TIMER

This function allows you to restrict TV viewing time and also allows you to control TV usage. This function is to prevent your children from watching too much TV.

**VIEWING TIME** (an accumulative timer: counts only the time duration while the TV power is on.)

- VIEWING TIME can be set from 30M (30 minutes) to 10H00M (10 hours) in 30 minutes intervals.

**OFF TIME** (Restricts TV viewing after the VIEWING TIME reaches zero.)

- OFF TIME can be set from 30M (30 minutes) to 10H00M (10 hours) in 30 minutes intervals.

**STATUS** (Select ON to activate VIEW TIMER)

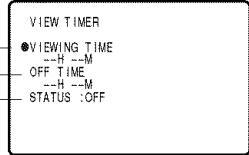

### How to set VIEW TIMER

- Press **MENU** to access the MAIN MENU screen.
- Press **CH ▲/▼** to move the "●" mark to "PARENT CONTROL".

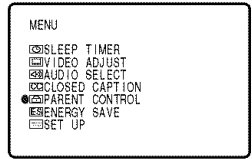
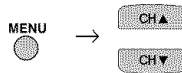

(MAIN MENU screen)

- Press **VOL +/-** to access the PARENT CONTROL screen.
- Press **CH ▲/▼** to move the "●" mark to "VIEW TIMER".

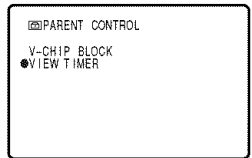
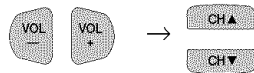

(PARENT CONTROL screen)

- Press **VOL +/-** to access "VIEW TIMER".

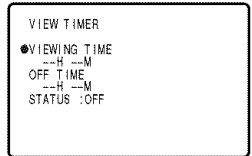
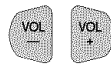

- Press **CH ▲/▼** to select "VIEWING TIME" and "OFF TIME". For each selection, press the **VOL +/-** to set the time duration.

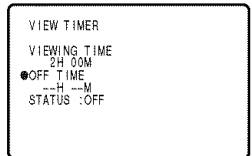
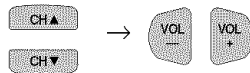

- Press **CH ▲/▼** to select "STATUS". Press the **VOL +/-** to turn ON the "VIEW TIMER". (If STATUS is OFF, VIEW TIMER will not operate.)

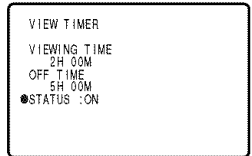
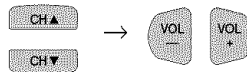

- Press **MENU**. "INPUT SECRET No." will be displayed.

### Note

- If SECRET No. is already set, skip to step 10.



# Parent Control (VIEW TIMER) (Continued)

9 Enter a 4-digit SECRET No. using the **REMOTE KEYPAD**.

10 Press **MENU** to exit.

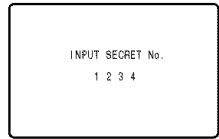

## Example:

- To restrict anybody from watching TV for more than 5 hours, after watching the TV for 2 hours, your settings would look like the one on the right.
- You can choose to watch the 2 hours of TV as you wish. For example, you could watch 1 hour of TV, turn the TV off for 30 minutes, then turn the TV on and watch the remaining 1 hour of the VIEWING TIME.

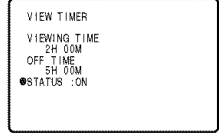

## • To change the VIEW TIMER setting after registering a secret No.

1 Repeat steps 1 to 4 of **How to set VIEW TIMER**. Press **VOL +/-**, and "INPUT SECRET No." will be displayed.

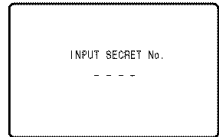
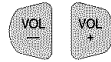

2 Enter the 4-digit SECRET No. using the **REMOTE KEYPAD**, and the VIEW TIMER access screen will be displayed. Repeat steps 5, 6.

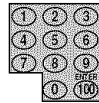

## Note:

- When you choose the correct secret No., the VIEW TIMER access screen is displayed. If the wrong secret No. is chosen, "SECRET No. IS INCORRECT" is displayed. Input the secret No. again in this case.

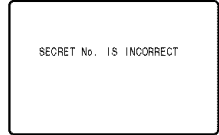

## • To cancel the VIEW TIMER (While the TV set is OFF but the VIEW TIMER is set.)

1 Turn on the TV; a blue screen message "TIME OVER" will appear. If you do nothing, the TV will turn off in approximately 30 seconds.



2 Enter the 4-digit secret No. using the **REMOTE KEYPAD**. When you choose the correct secret No., the VIEW TIMER is canceled. If the wrong secret No. is chosen, "SECRET No. IS INCORRECT" is displayed. Input the secret No. again in this case.

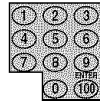



## Parent Control (VIEW TIMER) (Continued)

- To cancel the VIEW TIMER setting or change the secret No. (If you forget the SECRET No.)

1 Repeat steps 1 to 4 of **How to set VIEWTIMER**. Press **VOL +/–**, and “INPUT SECRET No.” will be displayed.



2 Press and hold both **VOL +** and **CH ▲** on the TV set simultaneously until the VIEW TIMER access screen is displayed. Now you can cancel the VIEW TIMER settings or change the SECRET No. while “INPUT SECRET No.” is displayed.

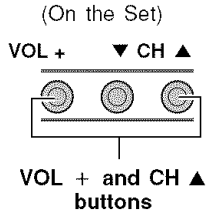

### • Notice of Remaining VIEWING TIME

- For every 30 minute interval, the remaining time will be displayed for 4 seconds. For the last 5 minutes, the remaining time will be displayed every minute.
- “0 REMAIN” will be displayed for 10 seconds just before the VIEWING TIME expires.

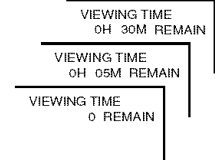

# Energy Save

- This feature lets you lower the power consumption of your TV set which in turn saves you money and minimizes the impact on the environment. When this feature is turned on, it reduces the brightness of the TV to a level that consumes approximately 20 percent less energy than when the feature is turned off. The reduction in brightness will be less noticeable under low room lighting conditions.

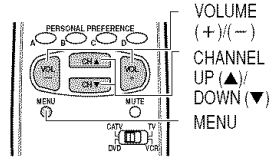

- Press **MENU** to access the MAIN MENU screen.
- Press **CH ▲/▼** to move the "●" mark to "ENERGY SAVE".

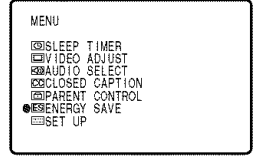
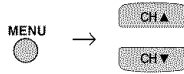

(MAIN MENU screen)

- Press **VOL +/-** to access the ENERGY SAVE select screen.

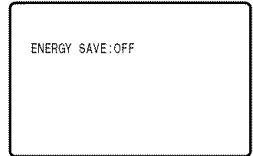
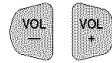

(ENERGY SAVE select screen)

- Press **VOL +/-** to select "ON".

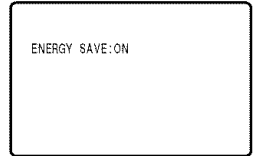
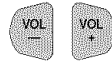

- Press **MENU** to exit.



# Set Up

## EZ Setup

By operating the channel preset functions, you can preset your TV to the desired channels for viewing.

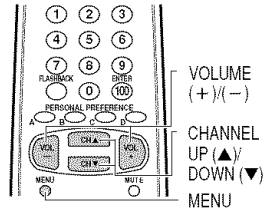

- 1 Press **MENU** to access the MAIN MENU screen.
- 2 Press **CH ▲/▼** to move the "●" mark to "SET UP".

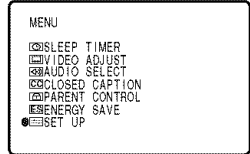
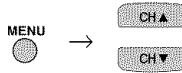

(MAIN MENU screen)

- 3 Press **VOL +/-** to access the SET UP screen, then press **CH ▲/▼** to move the "●" mark to "CH SETTING".

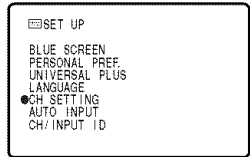
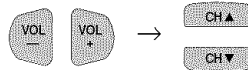

(SET UP screen)

- 4 Press **VOL +/-** to access the CH SETTING screen.

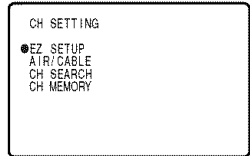
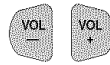

(CH SETTING screen)

- 5 Press **VOL +/-** to access the EZ SETUP screen.

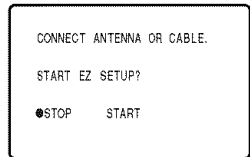
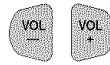

(EZ SETUP screen)

- 6 Press **VOL +**.  
The tuner will automatically search for the broadcasting and cable TV channels. (The CH No. will automatically increase when it appears.)  
If you want to stop the EZ SETUP process once it has started, press **VOL -**. Search will be canceled.

(START)



(STOP)



**To cancel EZ SETUP**  
Press **VOL -**.

- 7 Once EZ SETUP is complete, the lowest channel number memorized will be displayed.

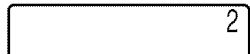

# Set Up (Continued)

## Channel Setting

If EZ SETUP does not memorize all the channels in your region, follow the instructions below to manually memorize the channel.

1 Press **MENU** to access the MAIN MENU screen.

2 Press **CH ▲/▼** to move the "●" mark to "SET UP".

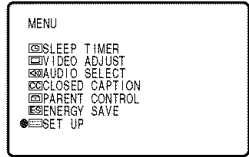
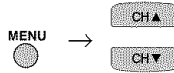

(MAIN MENU screen)

3 Press **VOL +/-** to access the SET UP screen.

4 Press **CH ▲/▼** to move the "●" mark to "CH SETTING".

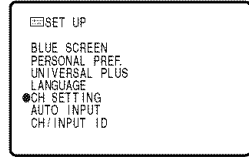
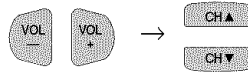

(SET UP screen)

5 Press **VOL +/-** to access the CH SETTING screen.

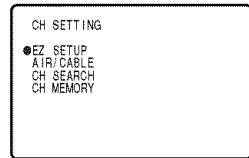
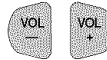

(CH SETTING screen)

6 Press **CH ▲/▼** to move the "●" mark to "AIR/CABLE", then press **VOL +/-** to access the AIR/CABLE screen.

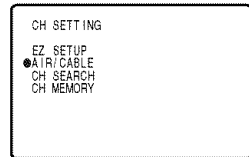
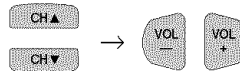

7 Press **CH ▲/▼** to move the "●" mark to the desired mode.

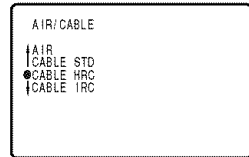
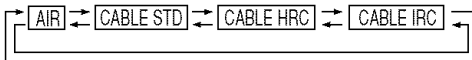

(AIR/CABLE screen)

8 Press **MENU** to exit.



### Note:

- Receivable channels of your TV set are:

AIR channels:

VHF: 2 through 13.

UHF: 14 through 69.

CABLE channels:

1 (HRC and IRC mode only)

2 through 125 (STD, HRC and IRC)

# Set Up (Continued)

- **Saving broadcast TV channels into memory**

**1** Press **MENU** to access the MAIN MENU screen, then press **CH ▲/▼** to move the “●” mark to “SET UP”.

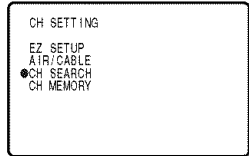
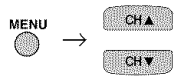

(CH SETTING screen)

**2** Press **VOL +/-** to access the SET UP screen, then press **CH ▲/▼** to move the “●” mark to “CH SETTING”.

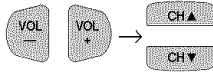

**3** Press **VOL +/-** to access the CH SETTING screen.

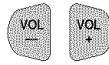

**4** Press **CH ▲/▼** to move the “●” mark to “CH SEARCH”, then press **VOL +/-** to access the CH SEARCH screen.

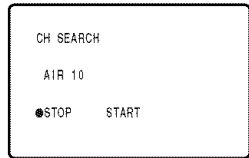
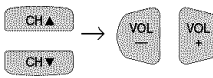

(CH SEARCH screen)

**To start:**

Press **VOL +**. The tuner will search through all available channels in your area and add them into the TV memory.

(START)



**To stop:**

Press **VOL -**. CH SEARCH will stop at the current channel and will not add any higher channels.

(STOP)



**5** Press **MENU** to exit.



**Note:**

- If you press **VOL +** again while in the CH SEARCH mode, auto-program will start again, and the previously memorized channels will be lost.

- **Adding weak or additional channels or erasing unwanted channels from TV memory**

**1** Press **MENU** to access the MAIN MENU screen, then press **CH ▲/▼** to move the “●” mark to “SET UP”.



**2** Press **VOL +/-** to access the SET UP screen, then press **CH ▲/▼** to move the “●” mark to “CH SETTING”.

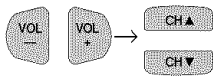

**3** Press **VOL +/-** to access the CH SETTING screen, then press **CH ▲/▼** to move the “●” mark to “CH MEMORY”.

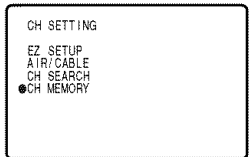
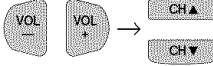

(CH SETTING screen)

**4** Press **VOL +/-** to access CH MEMORY.

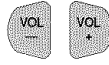

**5** Use **CH ▲/▼** or **REMOTE KEYPAD** to select each desired channel to add or erase.

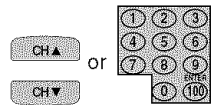

# Set Up (Continued)

- 6 Press **VOL +** to add a channel to the TV memory or press **VOL -** to erase a channel from the TV memory.

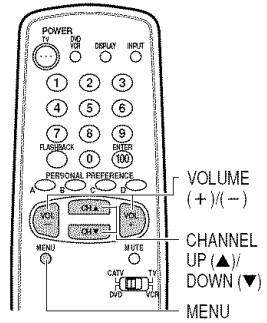
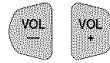
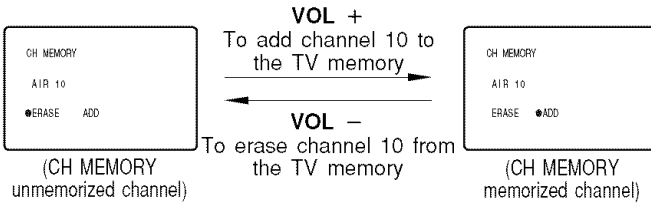

- 7 Press **MENU** to exit.



## BLUE SCREEN

Automatically turns the screen blue if a broadcast signal is not received. After 15 minutes of non-reception, the TV will turn off automatically.

- 1 Press **MENU** to access the MAIN MENU screen.
- 2 Press **CH ▲/▼** to move the "●" mark to "SET UP".

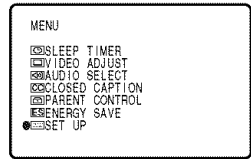
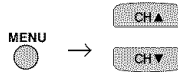

(MAIN MENU screen)

- 3 Press **VOL +/-** to access the SET UP screen.

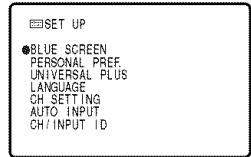
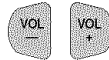

(SET UP screen)

- 4 Press **VOL +/-** to access the BLUE SCREEN select screen.

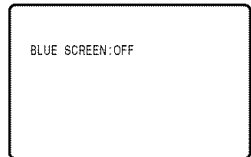

(BLUE SCREEN select screen)

- 5 Press **VOL +/-** to select "ON".

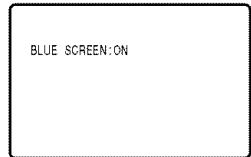

## Set Up (Continued)

- 6 Press **MENU** to exit.



When the BLUE SCREEN is set to "ON"

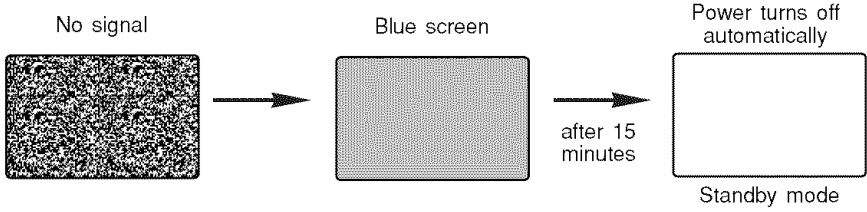

**Note:**

- Poor reception due to weak signals, or too much noise might activate the BLUE SCREEN function despite the presence of a broadcast signal. To continue watching TV under these conditions, switch the BLUE SCREEN "OFF".
- While INPUT1, 2 or 3 (COMPONENT) is selected, the BLUE SCREEN will not be shown even if BLUE SCREEN is turned on.

# Set Up (Continued)

## Personal Preference

By setting **PERSONAL PREFERENCE** channels in advance, you can select your favorite channels easily.

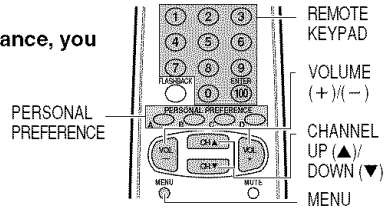

- 1 Press **MENU** to access the MAIN MENU screen.
- 2 Press **CH ▲/▼** to move the "●" mark to "SET UP".

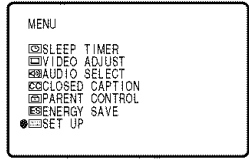
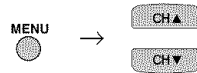

(MAIN MENU screen)

- 3 Press **VOL +/-** to access the SET UP screen, then press **CH ▲/▼** to move the "●" mark to "PERSONAL PREF."

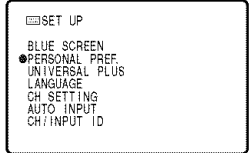
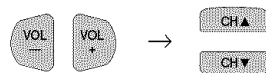

(SETUP screen)

- 4 Press **VOL +/-** to select the PERSONAL PREFERENCE select screen in which you can program 4 favorite channels, in 4 different categories. (total of 16 channels)

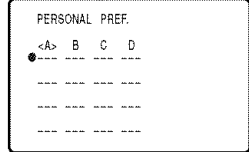
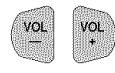

(PERSONAL PREFERENCE select screen)

- 5 Press **VOL +/-** and **CH ▲/▼** to move the "●" mark to the desired position.

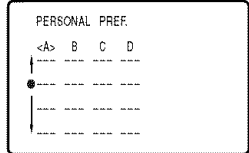

- 6 Press **REMOTE KEYPAD** on the Remote to input the CHANNEL Number into memory. Press **INPUT** on the Remote to register the INPUT mode into memory.

**Example:** 125 — Press "100" followed by "2" and then "5".  
 25 — Press "2" and then "5".  
 4 — Press "0" and then "4".  
 To reset a registered CHANNEL Number, input "0" twice.

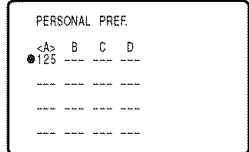
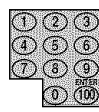

- 7 Repeat steps 5 and 6 to register the next CHANNEL Number or INPUT mode.
- 8 Press **MENU** to exit.



### To select the PERSONAL PREFERENCE channel.

If the channels are memorized as shown on the right, press the Remote's "A" button to select the channels below.

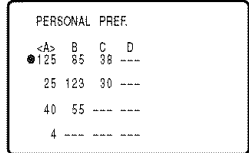
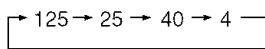



# Set Up (Continued)

## ■ Universal Plus Function

VCR or DVD input mode will be selected automatically by pressing the VCR/DVD PLAY button on the Remote Control.

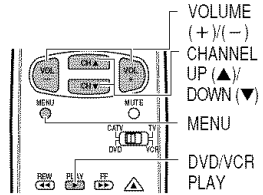

- 1 Press **MENU** to access the MAIN MENU screen.
- 2 Press **CH ▲/▼** to move the "●" mark to "SET UP".

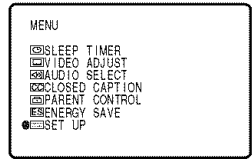
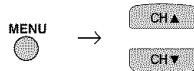

(MAIN MENU screen)

- 3 Press **VOL +/-** to access the SET UP screen.

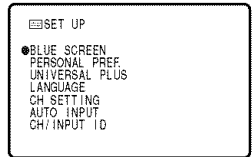

(SET UP screen)

- 4 Press **CH ▲/▼** to move the "●" mark to "UNIVERSAL PLUS".

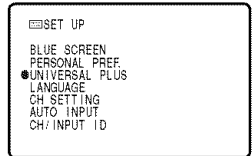

- 5 Press **VOL +/-** to access the UNIVERSAL PLUS select screen to select VCR or DVD mode.

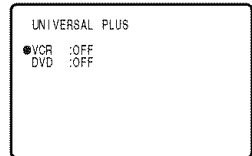

(UNIVERSAL PLUS select screen)

- 6 Press **CH ▲/▼** to select the VCR or DVD, and press **VOL +/-** to select "CH3", "CH4", "INPUT 1", "INPUT 2", "INPUT 3 (COMPONENT)" or "OFF".

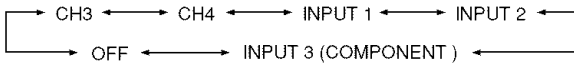

Switch to the input mode your VCR or DVD is connected to. If connected through RF (antenna terminal), select either CH3 or CH4 to match the setting of the VCR or DVD.

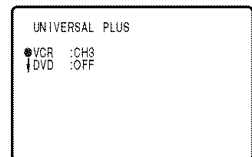
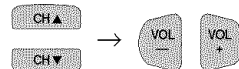

- 7 Press **MENU** to exit.



# Auto Input

- The unit is preset to switch to the INPUT 2 screen automatically when VIDEO equipment is connected to the INPUT 2 terminal. Do the following to switch this feature off:

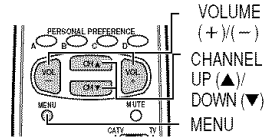

- Press **MENU** to access the MAIN MENU screen.
- Press **CH ▲/▼** to move the "●" mark to "SET UP".

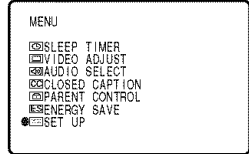
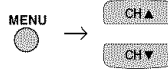

(MAIN MENU screen)

- Press **VOL +/-** to access the SET UP screen, then press **CH ▲/▼** to move the "●" mark to "AUTO INPUT".

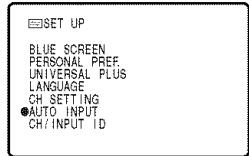
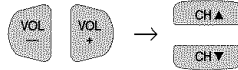

(SET UP screen)

- Press **VOL +/-** to access the AUTO INPUT select screen. Press **VOL +/-** to select "AUTO".

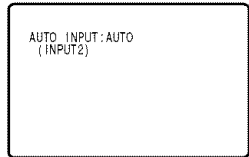
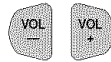

(AUTO INPUT select screen)

- You may turn off "AUTO INPUT" when it is not in use. Press **VOL +/-** to select "OFF".

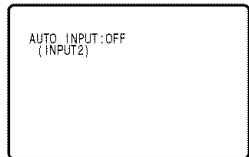
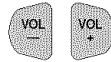

- Press **MENU** to exit.



# CH/Input ID

- You can assign an ID label to each channel or input mode. These ID labels can be 4 characters long maximum and will be displayed along with the channel number/input mode when the labeled channel is selected.  
(Example: labeling air channel 10 "TV12".)

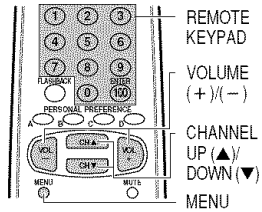

- Press **MENU** to access the MAIN MENU screen.

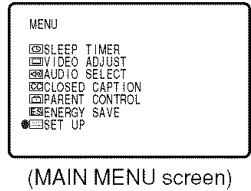

- Press **CH ▲/▼** to move the "●" mark to "SET UP".

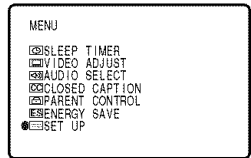

- Press **VOL +/-** to access the SET UP screen then press **CH ▲/▼** to move the "●" mark to "CH/INPUT ID".

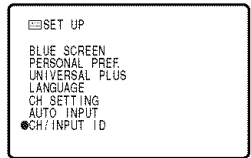
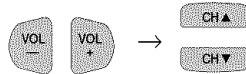

- Press **VOL +/-** to access the CH/INPUT ID screen.

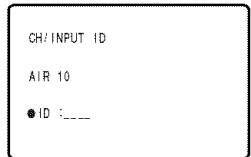
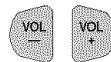

# CH/Input ID (Continued)

- 5 Use **CH ▲/▼** or **REMOTE KEYPAD** to select each desired channel to label.  
Press **INPUT** on the Remote to label the INPUT mode.

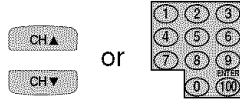

## ID: Labeling the channel name

Press **VOL +/-** to select "ID" then press **VOL +** to select the first character. Press **CH ▲/▼** to enter a desired letter. Press **VOL +/-** to enter the next desired letter. Press **MENU** to return to the CH/INPUT ID screen.

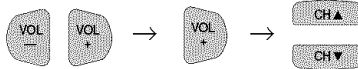

### Selectable characters:

Space: \_  
Alphabets: A-Z  
Numbers: 0-9  
Symbols: — . & ( ) / +

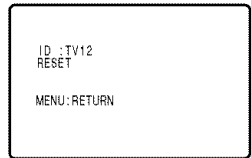
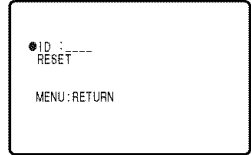
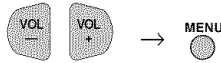

### RESET: Resetting the ID to "----"

Press **CH ▲/▼** to move the "●" mark to "RESET", then press **VOL +/-**. The previously set ID will return to "----".

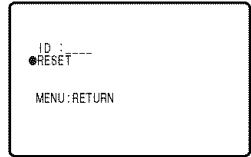
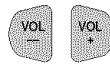
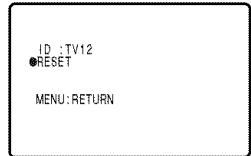

- 6 Press **MENU** to exit.



### Note:

- The maximum number of ID labels available to register channel names is 20 for AIR channels and 40 for CABLE channels.
- If you wish to register a new ID when all the available ID labels are assigned, delete a registered ID to make room.

# Using the Video and Audio Input Terminals

- Connecting video equipment for playback of video material.
- To view video material from external video equipment, make sure to connect the equipment properly to the input terminals on the TV set.

## Connecting video device equipped with video output terminals

### CONNECTIONS

#### VIDEO EQUIPMENT

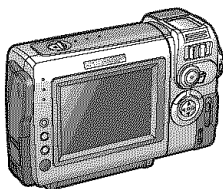

CAMCORDER

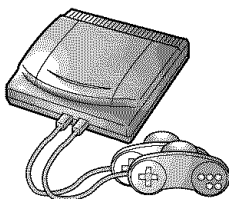

TV GAME

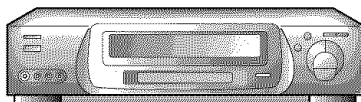

VCR

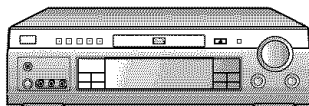

DVD

Yellow : To video input terminal  
White : To audio input (L) terminal  
Red : To audio input (R) terminal

#### (Front connection terminals of TV)

Pull open for inside door

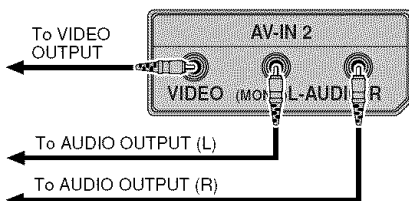

#### (Rear connection terminals of TV)

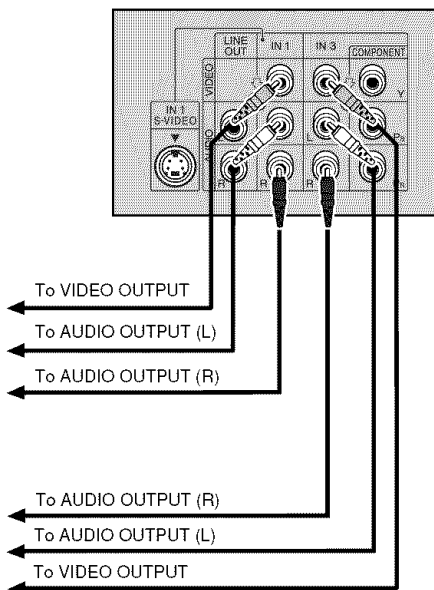

# Using the Video and Audio Input Terminals (Continued)

## Notes:

- COMPONENT terminals are DVD compatible, allows you to enjoy the highest quality playback image than the image from IN 1 S-VIDEO terminal.
- The IN 1 S-VIDEO terminal is used to obtain a higher quality image by importing image signals.
- The S-VIDEO terminal is for the video image only. To receive an audio signal, connect the audio cable to the IN 1 AUDIO terminals (left and right).

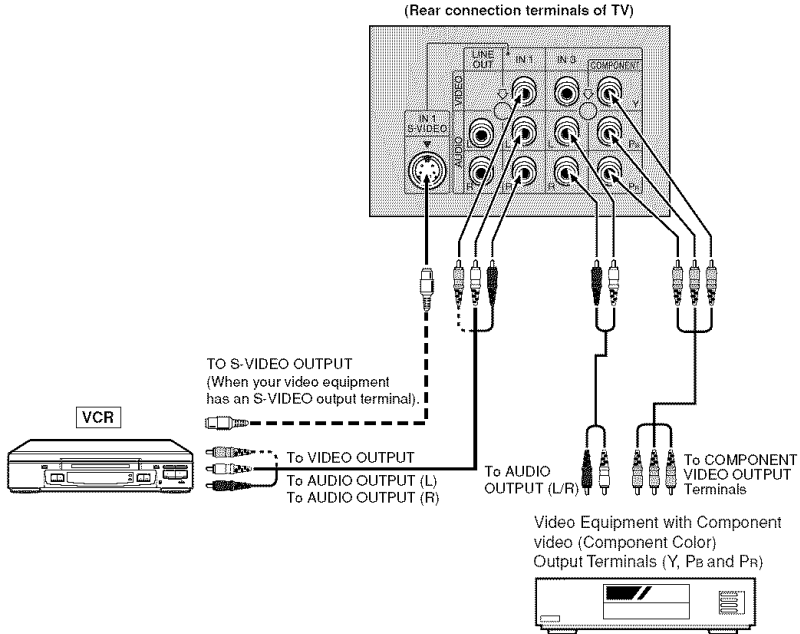

## • To watch video material play back

- Press the Remote's **INPUT** button to select the VIDEO INPUT mode for the video equipment you wish to play.
- The external VIDEO INPUT mode will change as follows each time the **INPUT** button is pressed.

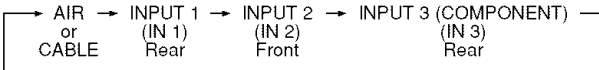

- When the AV cables are connected to the VIDEO INPUT 3 and COMPONENT Y, Pb and Pr terminals simultaneously, the COMPONENT terminal has priority over the VIDEO terminal.
- INPUT mode can be selected by pressing either the **CH ▲** on the TV remote control when the TV is set to the highest channel stored in memory, or by pressing the **CH ▼** when it is set to the lowest channel.

## Note:

- When connecting video or audio equipment to the television, be sure that the power is turned off in order to prevent damage to either the television or the equipment being connected.
- The S-Video terminal has priority over the VIDEO terminal (IN 1). When you wish to use video equipment connected to the VIDEO terminal (IN 1), unplug equipment connected to the S-VIDEO terminal.
- It is the intent of SHARP that this product be used in full compliance with the copyright law of the United States and that prior permission be obtained from copyright owners whenever necessary.
- For detailed information on the connection and use of auxiliary equipment, refer to the instruction manuals of the equipment being used.
- The connection cables/cords can be obtained from your local video store.

## Using the Audio Output Terminals

- These terminals are used for connecting an external audio amplifier. The STEREO/MONO/SAP, VOLUME, MUTE and FAO functions can all be controlled via the television's remote control or directly on the TV itself. These terminals relay the audio signal of all programs being displayed on the TV screen.

(AUDIO OUTPUT terminals are located on the rear of the cabinet.)

### CONNECTIONS

(Rear connection terminals of TV)

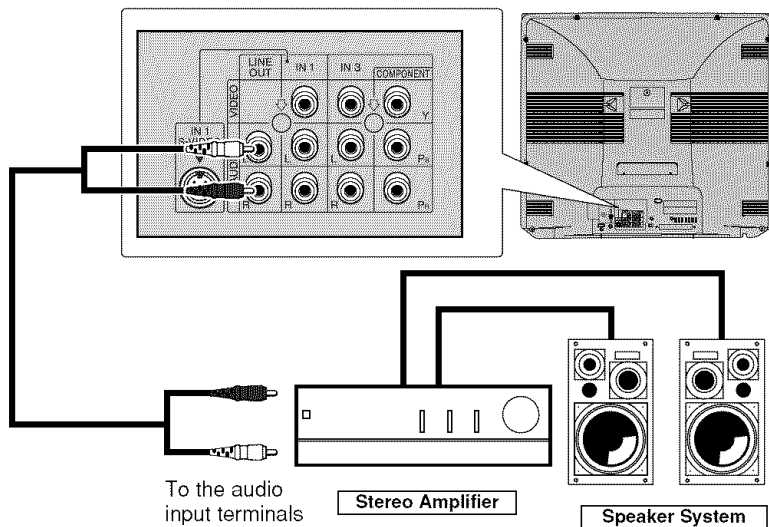

- (1) Before connecting the cables, turn on the TV and adjust the TV volume to a moderate listening level.
- (2) Turn off the TV and connect the audio cables to the AUDIO LINE OUTPUT terminals on the TV.
- (3) Turn the TV set and stereo amplifier on.
- (4) If you desire, you can turn off the sound of the TV's internal speakers by accessing the TV's AUDIO SELECT screen. See pages 12, 13.
- (5) Adjust the volume control on the stereo amplifier to a moderate listening level.
- (6) Control of the audio can be adjusted using the audio controls (STEREO/MONO/SAP, VOLUME, MUTE and FAO), from either the remote control, or directly from the TV set.

#### Note:

- For detailed information on the connection and use of auxiliary equipment, refer to the operation manuals of the equipment being used.
- When connecting monaural equipment to the AUDIO INPUT or OUTPUT of this set, use an audio connection cord and plug adaptor as shown below.
- When FAO is set to "OFF", we recommend you to keep the TV's audio output level high for optimal sound quality. (see page 12.)

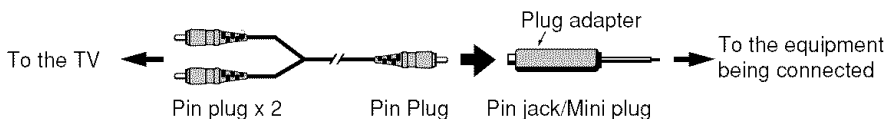

# Operation of Universal Remote Control

## • Universal Remote Control

With the purchase of your television set you also have received the latest innovation in remote control technology. With its easy-to-use push button keyboard, your Remote can control your television set and most infrared remote controlled VCRs, cable TV converters and DVDs as well.

### Note:

- Depending on the model year produced, brand and type of VCR, cable TV converter and DVD, some models may not be compatible with the remote control.
- Some brands may not enable channel selection until the **ENTER** is pressed. In such case, try the following.

### Example:

When you select channel 24,

- (1) Press **REMOTE KEYPAD** "2".
- (2) Press **REMOTE KEYPAD** "4".
- (3) Press **ENTER**.

For detailed information on the use of the Cable TV converter Box refer to their operating manuals.

## • Using your Remote with your TV

After installing the batteries, set the **CATV/ DVD-TV/VCR** on the Remote to the TV position. (If you can change the channel of the TV by pressing **CH ▲/▼** on the Remote Control, it is in the TV position.)

## • "Identifying" VCRs, cable TV converters and DVDs

Your Remote Control has been set at the factory to operate your TV and many remote controlled VCRs, cable TV converters and DVDs. However, in some cases an easy one-time set-up step may be necessary before the Remote will operate accessory VCRs, cable TV converters and DVDs.

- In this set-up step, the Remote locates and memorizes the remote control transmitter code for the VCR, cable TV converters and DVDs.
- Once "identified", the Remote sends proper signals to operate your accessory.
- This identifying step will not have to be repeated until power to the Remote is interrupted due to a battery failure.

## • Using your remote control with a VCR

Once you make certain the Remote Control has "identified" your remote controlled VCR or DVD, the Remote is ready to operate your unit. The various VCR or DVD function buttons on the Remote will not operate your VCR or DVD if those features are not already found on your unit.

- All VCR buttons will operate whether the Remote is in TV or VCR modes.
- For detailed information on the use of the VCR or DVD, refer to the operation manual of the VCR or DVD.

### DVD/VCR POWER

Press to turn the VCR or DVD on and off.

### PLAY ►

Press to playback a tape or disc.

### REWIND ◀◀

Press to rewind a tape or reverse a disc. For some VCRs or DVDs you may need to press **STOP** first, then **REWIND**.

### PAUSE ||

Press to temporarily stop the tape or disc during playback or recording (VCR only). Press again to release **PAUSE**.

### STOP ■

Press to stop the tape or disc.

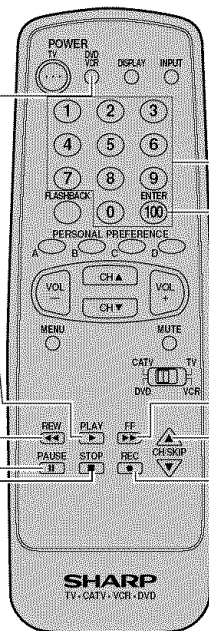

### REMOTE KEYPAD

Use to enter two-digit code numbers when identifying your VCR, DVD and CATV converter.

### ENTER

### FF ►►

Press to rapidly advance the tape or disc. For some VCRs or DVDs, you may need to press **STOP** first, then **FF**.

### VCR CHANNEL

**UP (▲)/ DOWN (▼)**  
Press to scan up or down through channels on the VCR.

### DVD SKIP

Press to jump forward to the beginning of the next chapter/track, or backward to the beginning of the current chapter/track, and automatically start to play that chapter/track.

### RECORD ●

Press to begin recording. (VCR only)



# Operation of Universal Remote Control (Continued)

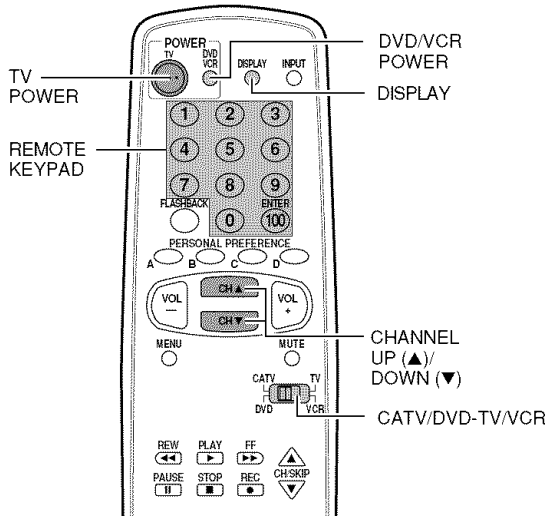

## • How to identify a VCR

The remote control may already be set to operate your VCR. Try this initial check before going on to the following "identifying" section.

- (1) Slide **CATV/DVD-TV/VCR** switch to VCR.
- (2) Point the Remote towards VCR and press **POWER (DVD/VCR)**.
- (3) Does the Remote turn the VCR ON and OFF?
  - If yes, the Remote is ready to operate the VCR and no further steps are needed.
  - If no, continue to the "identifying" section.

## Direct Entry Method

Refer to the following steps and list to quickly find the remote control code for your accessory VCR.

- First look up your VCR's remote control code number before going through the Direct Entry Method.
  - If this procedure does not identify your accessory VCR, use the Search Method of identification (described in the next section).
- (1) Slide **CATV/DVD-TV/VCR** switch to VCR.
  - (2) Press and hold down **DISPLAY** and **CH ▼** on your remote control. Then release both buttons.
  - (3) Within 10 seconds after releasing **DISPLAY** and **CH ▼**, enter your VCR's two-digit remote control code number using the **REMOTE KEYPAD** (refer to the list on page 42).
  - The remote control is now ready to send commands to your VCR.

Some brands have more than one remote code listed, due to changes in the remote codes from early to later model years, or due to format differences (VHS/BETA). In such cases, you may have to try more than one code to find the code your VCR accepts.

## Note:

Depending on the model, year produced, brand, and type of VCR, some models may not be compatible with the remote control.

## Search Method

- (1) Slide **CATV/DVD-TV/VCR** switch to VCR.
- (2) Press **POWER** of the VCR to ON.
- (3) Stand at least 6 feet away from the front of the VCR. Point the Remote towards the VCR. Hold down **DISPLAY** and **CH ▲** at the same time. KEEP HOLDING THE BUTTONS DOWN.
- (4) Watch the channel number indicator on the VCR, channel numbers will scan up when the VCR has been identified. Release **DISPLAY** and **CH ▲** as soon as the channel numbers start to scan up. The VCR's remote control code number has been identified, and the Remote is ready to operate the VCR.

# Operation of Universal Remote Control (Continued)

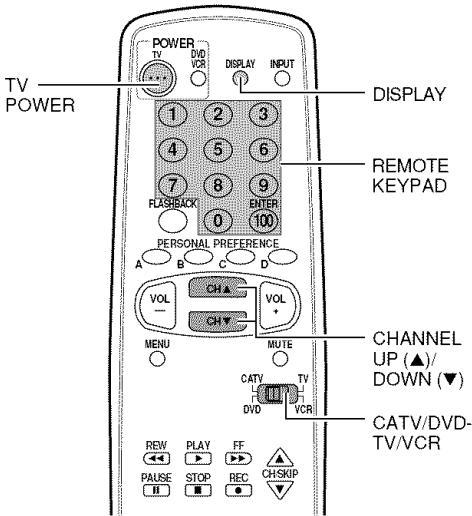

## Tips on identifying your VCR

If your VCR model does not have the "channel up" function on its remote control, it cannot be identified using the Search Method for identifying. For such models, please try the Direct Entry Method of identifying.

**Be Patient:** A minute or two can seem a lot longer when you're waiting for something to happen, but the code should be identified within 2 minutes. Remember, it is only a one-time set-up.

Be careful not to let the VCR scan more than 5 channels when the indicator starts to move up. If you continue holding down the **DISPLAY** and **CH ▲** after 5 channel scans, the proper remote code can be passed up, and the 2 minutes identifying cycle will have to be repeated.

If a channel change does not occur on the VCR within 2 minutes, read the identifying instructions again and repeat the steps. Should a channel change still not occur, the Remote will not operate with the desired VCR.

| VCR BRAND       | REMOTE CONTROL CODE NUMBER |
|-----------------|----------------------------|
| Akai            | 25, 26, 37                 |
| Audio Dynamics  | 15, 22, 30                 |
| Broksonic       | 32                         |
| Canon           | 04                         |
| Capehart        | 34                         |
| Craig           | 10, 31                     |
| Curtis Mathis   | 04                         |
| Daewoo          | 34                         |
| DBX             | 15, 22, 30                 |
| Dynatech        | 29                         |
| Emerson         | 21, 32, 35                 |
| Fisher          | 09, 10, 11                 |
| Funai           | 28, 29                     |
| GE              | 04                         |
| Goldstar        | 24                         |
| Hitachi         | 06                         |
| Instant Replay  | 04                         |
| JC Penney       | 04, 06, 24, 30             |
| JVC             | 15, 41, 42                 |
| Kenwood         | 14, 15                     |
| Lloyds          | 29                         |
| Magnavox        | 04, 05, 08                 |
| Magnin          | 31                         |
| Marantz         | 30                         |
| Memorex         | 04, 10, 24, 29             |
| Minolta         | 06                         |
| Mitsubishi      | 17, 18, 39, 40             |
| Montgomery Ward | 02, 43                     |
| Multitech       | 29                         |
| NEC             | 15, 22, 30                 |
| Panasonic       | 04, 44                     |
| Pentax          | 05, 06                     |
| Philco          | 04, 05                     |
| Philips         | 04, 05, 08                 |
| Quasar          | 04                         |
| RCA             | 06, 07, 33                 |
| Realistic       | 01, 02, 10, 24             |
| Samsung         | 23, 31                     |
| Sanyo           | 14, 10                     |
| Scott           | 20                         |
| Sears           | 06, 11, 24                 |
| Sharp           | 01, 02, 03                 |
| Shintom         | 36                         |
| Sony            | 12, 13, 38                 |
| Sound Design    | 29                         |
| Sylvania        | 04, 05, 08                 |
| Symphonic       | 29                         |
| Tatung          | 15                         |
| Teac            | 15, 29                     |
| Teknika         | 27, 29                     |
| Thomas          | 29                         |
| TMK             | 21                         |
| Toshiba         | 19, 20                     |
| Video Concepts  | 30                         |
| Yamaha          | 15, 29, 30                 |
| Zenith          | 16                         |

# Operation of Universal Remote Control (Continued)

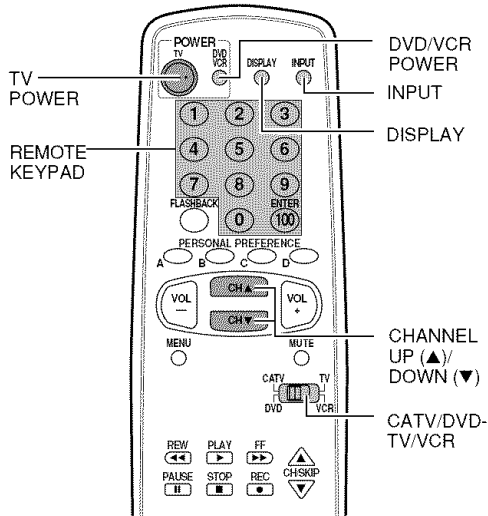

## • How to identify a DVD

The remote control may already be set to operate your DVD. Try this initial check before going on to the following "identifying" section.

- (1) Slide **CATV/DVD-TV/VCR** switch to DVD.
- (2) Point Remote towards DVD and press **DVD/VCR POWER**.
- (3) Does the Remote turn the DVD ON and OFF?
  - If yes, the Remote is ready to operate the DVD and no further steps are needed.
  - If no, continue to the "identifying" section.

## Direct Entry Method.

Refer to the following steps and list to quickly find the remote control code for your accessory DVD.

- First look up your DVD's remote control code number before going through the Direct Entry Method.
  - (1) Slide **CATV/DVD-TV/VCR** switch to DVD.
  - (2) Press and hold down **INPUT** and **CH ▼** on your remote control. Then release both buttons.
  - (3) Within 10 seconds after releasing **INPUT** and **CH ▼**, enter your DVD's two-digit remote control code number using **REMOTE KEYPAD** (refer to the list).
- The remote control is now ready to send commands to your DVD.

| DVD BRAND  | REMOTE CONTROL CODE NUMBER |
|------------|----------------------------|
| Denon      | 02                         |
| JVC        | 09                         |
| Magnavox   | 04                         |
| Marantz    | 04                         |
| Mitsubishi | 06                         |
| Panasonic  | 02                         |
| Philips    | 04                         |
| Pioneer    | 08                         |
| Proscan    | 03                         |
| RCA        | 03                         |
| Samsung    | 07                         |
| Sharp      | 01, 10                     |
| Sony       | 05                         |
| Toshiba    | 04                         |
| Yamaha     | 02                         |
| Zenith     | 04                         |

## Note:

Depending on the model, year produced, brand, and type of DVD, some models may not be compatible with the remote control.

# Operation of Universal Remote Control (Continued)

## • How to identify a cable converter

### Direct Entry Method

Refer to the following steps and list to quickly find the remote control code for your cable TV converter.

- First look up your converter's remote code number before going through the Direct Entry Method below.
  - If this procedure does not identify your converter, use the Search Method for identification.
- (1) Slide **CATV /DVD-TV/VCR** switch to CATV.
  - (2) Press and hold down **DISPLAY** and **CH ▼** on your remote control. Then release both buttons.
  - (3) Within 10 seconds after releasing **DISPLAY** and **CH ▼**, enter your converter's two-digit code number using **REMOTE KEYPAD** (refer to the list).
- The remote control is now ready to send commands to your converter.
  - Some brands have more than one remote code listed due to changes in the remote codes from early to later model years. In such cases, you may have to try more than one code to find the code your converter accepts.

### Note: ➤

Depending on the model, year produced, brand, and type of CATV converter, some models may not be compatible with the remote control.

### Search Method

- (1) Slide **CATV /DVD-TV/VCR** switch to CATV.
- (2) Press the power button on the cable converter to ON.
- (3) Stand at least 6 feet away from the converter. Point the Remote towards the converter. Hold down the **DISPLAY** and **CH ▲** at the same time. KEEP HOLDING THE BUTTONS DOWN.
- (4) Watch the Channel Number indicator on the converter. Channel numbers will scan up when the converter has been identified. Release the **DISPLAY** and **CH ▲** as soon as the channel numbers start to scan up. The converter's remote control code number has been identified, and the remote is ready to operate the converter.

| CATV CONVERTER BRAND | REMOTE CONTROL CODE NUMBER             |
|----------------------|--|
| Anvision             | 07, 08                                 |
| Cable Star           | 07, 08                                 |
| Eagle                | 08                                     |
| General Instrument   | 04, 05, 15, 23, 24, 25, 30, 36         |
| Jerrold              | 04, 05, 15, 23, 24, 25 30, 36          |
| Magnavox             | 07, 08, 19, 25, 28, 29, 32, 33, 40, 41 |
| Oak Sigma            | 18                                     |
| Panasonic            | 27, 39                                 |
| Philips              | 07, 08, 19, 26, 28, 29, 32, 33, 40, 41 |
| Pioneer              | 18, 20                                 |
| Randtek              | 07, 08                                 |
| RCA                  | 27, 43                                 |
| Scientific Atlanta   | 03, 22, 42                             |
| Sony                 | 44                                     |
| Viewstar             | 07, 08, 19, 26, 28, 29 32, 33, 40, 41  |
| Zenith               | 14                                     |

### Tips on identifying your cable converter

**Be Patient:** A minute or two can seem a lot longer when you're waiting for something to happen, but the code should be identified within 2 minutes. Remember, it is only a one-time set-up.

Be careful not to let the CATV converter scan more than 5 channels when the indicator starts to move up. If you continue holding down the **DISPLAY** and **CH ▲** after 5 channel scans, the proper remote code can be passed up, and the 2 minute identifying cycle will have to be repeated.

If a channel change does not occur on the cable converter within 2 minutes, read the identifying instructions again and repeat the steps. Should a channel change still not occur, the remote will not operate with the desired converter.

### Note: ➤

Some satellite receivers can be operated by the REMOTE CONTROL. If you have a Satellite Receiver, you can use the above method to search for available channels.

# Before Calling for Service

Check these items and see if you can correct the trouble with a slight adjustment of the controls.

| <b>QUICK SERVICE CHECK LIST</b>  | <b>PROBLEM</b>                     |  |                             |                |                   |                          |          |                                 |              |                             |                   |                 |                        |                        |                     |                        |   |   |
|--|------------------------------------|--|-----------------------------|----------------|-------------------|--------------------------|----------|---------------------------------|--------------|-----------------------------|-------------------|-----------------|------------------------|------------------------|---------------------|------------------------|---|---|
| <b>POSSIBLE REMEDY</b>   | No Playback of VCR and Disc Player | No Picture or Sound from External Video/Audio Products | Remote Control Doesn't Work | Bars on Screen | Picture Distorted | Picture Rolls Vertically | No Color | Poor Reception on Some Channels | Weak Picture | Lines or Streaks in Picture | Ghosts in Picture | Picture Blurred | Sound OK, Picture Poor | Picture OK, Sound Poor | No Picture or Sound | Dark and Blank Picture | External Electrical Noise Interfering with TV's Operation | Color on Part of the Screen Appears Distorted |
| Try a new channel, if OK, then there is possible station trouble.                                    |                                    |  |                             | X              | X                 | X                        | X        | X                               | X            | X                           | X                 | X               | X                      | X                      |                     |                        |   |   |
| Is TV plugged in? Power at outlet?   |                                    | X  | X                           |                |                   |                          |          |                                 |              |                             |                   |                 |                        |                        |                     |                        |   |   |
| Is TV's POWER button on?   |                                    | X  |                             |                |                   |                          |          |                                 |              |                             |                   |                 |                        |                        |                     |                        |   |   |
| Is antenna connected to terminal on the back of the set?   |                                    |  |                             |                |                   |                          | X        | X                               | X            |                             | X                 |                 | X                      |                        | X                   |                        |   |   |
| If outside antenna is being used, check for broken wire.   |                                    |  |                             | X              | X                 | X                        | X        | X                               | X            | X                           | X                 | X               | X                      |                        | X                   |                        |   |   |
| Check for local interference or external electrical noise.   |                                    |  |                             | X              | X                 | X                        |          | X                               | X            | X                           | X                 | X               | X                      |                        |                     |                        | X   |   |
| Turn off with POWER button and then turn it on after about a minute.                                 |                                    | X  |                             |                |                   |                          |          |                                 |              |                             |                   |                 |                        |                        | X                   |                        |   |   |
| Adjust COLOR control.  |                                    |  |                             |                |                   |                          | X        |                                 |              |                             |                   |                 |                        |                        |                     |                        |   |   |
| Adjust PICTURE control.  |                                    |  |                             |                |                   |                          |          |                                 | X            |                             |                   |                 | X                      |                        |                     |                        |   |   |
| Check external Video/Audio products: look for loose/broken connection leads. (Refer to page 37 ~ 39) | X                                  | X  |                             |                |                   |                          |          |                                 |              |                             |                   |                 | X                      | X                      | X                   |                        |   |   |
| Check batteries of Remote Control.   |                                    |  | X                           |                |                   |                          |          |                                 |              |                             |                   |                 |                        |                        |                     |                        |   |   |
| Press TV/VCR button on the remote to select TV mode.   |                                    |  | X                           |                |                   |                          |          |                                 |              |                             |                   |                 |                        |                        |                     |                        |   |   |
| Are audio cables connected firmly? Check the volume level.   |                                    |  |                             |                |                   |                          |          |                                 |              |                             |                   |                 |                        | X                      | X                   |                        |   |   |
| Is SPEAKER ON? See page 12.  |                                    |  |                             |                |                   |                          |          |                                 |              |                             |                   |                 |                        |                        | X                   |                        |   |   |
| Change Closed Caption mode to "OFF" / Energy Save mode to "OFF".                                     |                                    |  |                             |                |                   |                          |          |                                 |              |                             |                   |                 |                        |                        |                     | X                      |   |   |
| Unplug the TV and plug it in again after two minutes or longer.                                      |                                    |  | X                           |                |                   | X                        | X        | X                               | X            |                             |                   |                 | X                      | X                      | X                   | X                      | X   | X   |

**Note:**

- When viewing in TEXT mode, if no TEXT broadcast is being received, the screen may become dark and blank. Should this occur, set the Closed Caption mode to "OFF".



(Dark and Blank Picture)

## Calling for Service

For location of the nearest Sharp Authorized Servicer, or to obtain product literature accessories, supplies, or customer assistance, please call 1-800-BE-SHARP.

## Specifications

|                         |   |          |
|-------------------------|---|----------|
| MODEL                   | 32UF5/6   |          |
| Receiving System        | NTSC  |          |
| Stereo Broadcast        | MTS/SAP   |          |
| Reception Channels      |   |          |
| AIR                     | VHF   | 2-13 ch  |
|                         | UHF   | 14-69 ch |
| CATV                    | 1-125 ch  |          |
| Channel Tuning          | 181-channel Reception PLL tuning system   |          |
| Antenna Input Impedance | VHF/UHF 75 ohm Unbalanced   |          |
| Screen Size             | 32" Diagonally Measured   |          |
| Terminals               | Audio/Video input x 3 (Front x 1, Rear x 2)<br>S-Video input x 1 (Rear)<br>COMPONENT-IN x 1 (Rear)<br>Audio output x 1 (Rear) |          |
| Sound Output            | 5 W (RMS) x 2   |          |
| Power Source            | AC 120 V, 60 Hz   |          |
| Power Consumption       | 160 W   |          |
| Dimensions              | 29 <sup>57/64</sup> " (W) x 26 <sup>3/4</sup> " (H) x 23 <sup>1/2</sup> " (D)<br>[759 mm (W) x 679 mm (H) x 596.5 mm (D)]     |          |
| Weight (approx.)        | 143 lbs. (65 kg)  |          |

- Design and specifications are subject to change without notice.

Lea estas instrucciones cuidadosamente y consérvelas a la mano para consultarlas en el futuro.

**IMPORTANTE**

Sírvase anotar el modelo del televisor y los números de serie en el espacio provisto, para ayudar a reportar en caso de pérdida o robo. Los números están ubicados en la parte posterior del televisor.

|  |
|--|
| <p><b>N° de modelo :</b></p> <p><b>N° de serie :</b></p> |
|--|

# INFORMACIÓN IMPORTANTE

Existen dos razones importantes para registrar dentro del plazo límite la garantía de su nuevo televisor SHARP, mediante la TARJETA DE REGISTRO incluida con el aparato.

**PRIMERA – GARANTÍA**

Garantiza al cliente la recepción inmediata de todas las prestaciones de consumidor en cuanto a piezas, servicio técnico y mano de obra aplicable a su adquisición.

**SEGUNDA – ACTA DE SEGURIDAD DE PRODUCTOS DE CONSUMIDOR**

Con el fin de garantizar al cliente la recepción puntual de cualquier notificación de seguridad sobre inspección, modificación o cancelación que se le pueda solicitar a SHARP bajo el Acta de seguridad de productos de consumidor de 1972. LEA CUIDADOSAMENTE LA CLÁUSULA "GARANTÍA LIMITADA" DE LA ÚLTIMA PÁGINA.

**¿QUÉ ES ENERGY STAR® ?**

Los televisores y las videograbadoras utilizan energía cuando están encendidos ó apagados. Los norteamericanos gastan más de 1 billón de dólares al año en la energía que consumen televisores y videograbadoras cuando no se encuentran en uso. Los nuevos modelos ENERGY STAR® reducen esa "fuga" de energía hasta en un 75 por ciento. Esto implica más de 500 millones de dólares al año en ahorro de energía para los consumidores.

El ahorro de energía ayuda a reducir el consumo de combustibles fósiles y por tanto la contaminación por dióxido de carbono que contribuye al calentamiento global. Si cada familia norteamericana sustituyera sus televisores y videograbadoras por modelos ENERGY STAR®, se reducirían las emisiones de dióxido de carbono en cinco millones de toneladas cada año (equivalente a eliminar la contaminación procedente de más de un millón de automóviles).

El uso de productos ENERGY STAR® permite reducir el monto de las facturas de energía eléctrica y consumir menos energía. De este modo ahorrará dinero y ayudará a proteger el medio ambiente.

**ADVERTENCIA : PARA REDUCIR EL RIESGO DE INCENDIO O DESCARGA ELÉCTRICA, NO EXPONGA ESTE APARATO A LA HUMEDAD.**

|   |   |   |
|---|---|---|
|   | <p><b>PRECAUCION</b></p> <p><b>RIESGO DE ELECTRO-CHOQUE NO ABRA</b></p> |  |
| <p><b>PRECAUCIÓN : PARA REDUCIR EL RIESGO DE DESCARGAS ELÉCTRICAS, NO RETIRE LA CUBIERTA (NI EL PANEL POSTERIOR).</b></p> <p><b>NO CONTIENE PIEZAS REPARABLES POR EL USUARIO. SOLICITE ASISTENCIA TÉCNICA A PERSONAL DE SERVICIO TÉCNICO ESPECIALIZADO.</b></p> |   |   |

 El relámpago con cabeza de flecha dentro de un triángulo trata de indicar al usuario que las partes dentro del producto representan riesgo de electrochoque para las personas.

 El signo de exclamación dentro de un triángulo trata de indicar al usuario que las instrucciones importantes de operación y servicio se encuentran en los documentos con el aparato.

"Nota para el instalador del sistema de TV por cable: Esta nota tiene el propósito de llamar la atención del instalador del sistema de cable acerca del Artículo 820-40 del Código Eléctrico Nacional, que contiene las directrices para la puesta a tierra y, en particular, especifica que el cable de puesta a tierra debe estar conectado al sistema de puesta a tierra del edificio lo más cerca a la entrada del cable."

# INFORMACIÓN IMPORTANTE (Continuación)

**ADVERTENCIA** - Las Normas de la FCC establecen que cualquier cambio o modificación no autorizada que se realice en este equipo y que no esté expresamente aprobado por el fabricante podría anular la autoridad del usuario para utilizar este equipo.

## DESECHO DEL PRODUCTO

Este producto utiliza un Tubo de rayos catódicos (TRC) que contiene soldadura de estaño y plomo. El desecho de estos materiales deberá ser considerando regulaciones ambientales. Para obtener información sobre el desecho o el reciclado, póngase en contacto con las autoridades locales o con Electronics Industries Alliance: [www.eiae.org](http://www.eiae.org)

**PRECAUCIÓN:** No coloque el cable de alimentación de CA debajo del televisor u otro elemento pesado.

# MEDIDAS DE SEGURIDAD IMPORTANTES

**PRECAUCIÓN :** Lea por favor todas estas instrucciones antes de poner en funcionamiento su televisor, y guárdelas para poder utilizarlas en el futuro.

La energía eléctrica permite realizar muchas funciones útiles. Este aparato ha sido diseñado y fabricado para garantizar su seguridad física. Sin embargo, UNA UTILIZACIÓN INAPROPIADA PODRÍA SER LA CAUSA DE DESCARGAS ELÉCTRICAS O INCENDIOS. Para mantener el buen funcionamiento de este equipo y evitar problemas, siga las normas básicas indicadas a continuación cuando lo instale, utilice o repare.

1. Desenchufe el televisor del tomacorriente antes de limpiarlo.
2. No utilice líquidos ni aerosoles de limpieza. Para limpiar el televisor utilice un paño húmedo.
3. No utilice accesorios que no los recomiende el fabricante del televisor porque podrían causar peligros.
4. No utilice el televisor cerca del agua – por ejemplo, cerca de una bañera, lavado, fregadero o lavadora, en un sótano húmedo, cerca de una piscina, etc.
5. No utilice este televisor sobre un carrito, un soporte o una mesa inestables. El televisor podría caerse causando serias heridas a niños o adultos, y, por supuesto, el aparato se estropearía. Ponga el televisor solamente sobre un carrito o soporte recomendado por el fabricante, o vendido junto con el televisor.
6. La combinación de carrito y televisor debe moverse con mucho cuidado. Las paradas rápidas, la fuerza excesiva y las superficies irregulares pueden ser la causa de que la combinación de televisor y carrito se volteen.
7. Cuando instale el televisor en una pared o en una estantería siga las instrucciones del fabricante, y utilice el kit de montaje aprobado por el fabricante.
8. Las ranuras y aberturas de la caja y del panel posterior o inferior sirven para la ventilación del aparato, para que éste funcione bien y para evitar que se caliente. Estas aberturas no deben taparse nunca. Este televisor no debe colocarse en un lugar cerrado (como un estante para libros) si éste no dispone de la ventilación apropiada.
9. Las aberturas no deben taparse nunca con un paño u otro material; y las aberturas del panel inferior no deben taparse tampoco colocando el televisor sobre una cama, sofá, alfombra u otra superficie similar. Este televisor no debe ponerse nunca cerca o encima de un radiador u otro aparato que produzca calor.
10. Este televisor sólo debe funcionar con la fuente de corriente indicada en la etiqueta del fabricante. Si no está seguro acerca del tipo de corriente de su hogar, póngase en contacto con el concesionario de quien adquirió el televisor o con la compañía eléctrica local.  
En el caso de equipos de televisión diseñados para funcionar con baterías, consulte las instrucciones de uso.
11. Como medida de seguridad, el equipo de televisión está equipado con un enchufe polarizado de dos hilos. El enchufe polarizado de dos hilos solamente calza de una sola manera en el tomacorriente. Si el enchufe no entra en el tomacorriente, pídale a un electricista que le coloque un tomacorriente nuevo. No modifique el enchufe porque anulará esta característica de seguridad.
12. No permita que se apoye nada sobre el cable de alimentación. No ponga este televisor donde el cable pueda ser deformado por personas que caminen sobre él.





# MEDIDAS DE SEGURIDAD IMPORTANTES (Continuación)

13. Cumpla con todos los avisos y las instrucciones marcados en el televisor.
14. Si hay una antena exterior conectada al televisor, asegúrese de que el sistema de antena está conectado a tierra, para obtener así cierta protección contra la sobretensión y contra las cargas de electricidad estática acumulada.

## EJEMPLO DE CONEXIÓN A TIERRA DE UNA ANTENA SEGÚN EL CÓDIGO ELÉCTRICO NACIONAL.

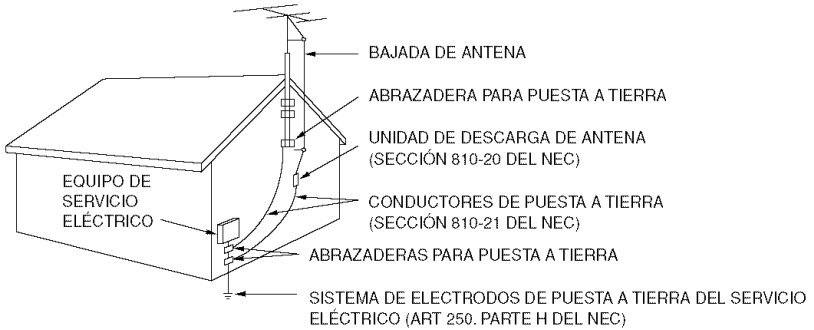

### NEC- NATIONAL ELECTRICAL CODE (CÓDIGO ELÉCTRICO NACIONAL)

15. Para proteger aún más este televisor durante tormentas eléctricas o cuando se deje sin atender y sin utilizar durante largos periodos de tiempo, desenchufe el cable de alimentación del tomacorriente y desconecte la antena. Esto evitará que el aparato pueda estropearse debido a los relámpagos y la sobretensión en la línea de alimentación.
16. Un sistema de antena exterior no debe ubicarse cerca de líneas de alimentación elevadas, ni cerca de luces eléctricas o circuitos de alimentación. Tampoco debe ubicarse donde pueda caer sobre tales líneas o circuitos de alimentación. Cuando instale un sistema de antena exterior, tenga muchísimo cuidado para no tocar las líneas o circuitos de alimentación porque el contacto podría causar un accidente mortal.
17. No sobrecargue los tomacorrientes ni los cables de extensión porque esto podría causar un incendio o descarga eléctrica.
18. No meta nunca ningún objeto en el interior del televisor porque podría tocar piezas con alta tensión o causar un cortocircuito con otras piezas causando un incendio o descarga eléctrica. No derrame nunca ningún tipo de líquido sobre el televisor.
19. No trate de reparar el televisor usted mismo porque al abrir o quitar las tapas podría exponerse a una descarga de tensión u otros peligros. Las reparaciones debe realizarlas el personal de servicio CALIFICADO.
20. Desenchufe este televisor del tomacorriente y solicite el servicio de un técnico calificado cuando se produzcan las condiciones siguientes:
  - A. Cuando el cable de la alimentación o el enchufe estén estropeados.
  - B. Cuando haya derramado un líquido sobre el televisor.
  - C. Si el televisor ha quedado expuesto a la lluvia o al agua.
  - D. Si el televisor no funciona normalmente siguiendo las instrucciones de utilización. Ajuste solamente los controles indicados en las instrucciones de utilización. Un ajuste inadecuado de otros controles podría estropear el aparato y, entonces, sería necesario acudir a un técnico CALIFICADO para que éste lo repare y lo devuelva a su condición normal.
  - E. Si el televisor se ha caído o la caja se ha estropeado.
  - F. Cuando las prestaciones del televisor cambien considerablemente será necesario llamar al servicio de reparaciones.
21. Al finalizar cualquier servicio o reparación de este televisor, pida al técnico de servicio que realice comprobaciones de seguridad rutinarias para determinar si el televisor puede funcionar sin causar ningún problema.
22. Cuando sea necesario cambiar piezas, cerciórese de que el técnico de servicio utiliza las piezas de CAMBIO especificadas por el fabricante, aquellas que tengan las mismas características que las piezas originales. Las piezas de recambio no autorizadas pueden causar incendios, descargas eléctricas u otros peligros.

# Referencia rápida de los controles de operación

## Ubicación de los controles

(ESPAÑOL)

### Panel Delantero

#### ALIMENTACION (POWER)

Pulsando → Enciende (On).  
Pulsando nuevamente → Apaga (Off).

#### ZONA DEL SENSOR DEL MANDO A DISTANCIA

#### MENU (MENU)

Pulsando → Accede al MENU PRINCIPAL.  
Pulsando nuevamente → Sale del MENU PRINCIPAL.

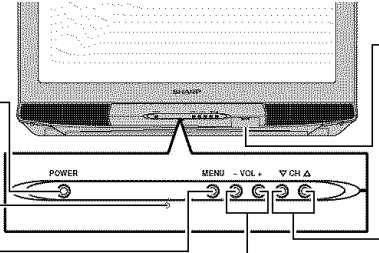

**AUMENTO/DISMINUCION DEL VOLUMEN (VOL)**  
(+) Aumenta el sonido.  
(-) Disminuye el sonido.

**TERMINALES DE ENTRADA VIDEO/AUDIO [IN 2]**  
(POR DENTRO DE LA PUERTA)

#### CANAL SUPERIOR/INFERIOR (CH) - MENU

(▲) Selecciona el siguiente canal superior.  
(▼) Selecciona el siguiente canal inferior.  
• Pulse ambos al mismo tiempo para acceder a la pantalla de MENU PRINCIPAL.

## Funciones Basicas Del Control Remoto

#### ALIMENTACION (POWER)

Pulsando → Enciende (On).  
Pulsando nuevamente → Apaga (Off).

#### TECLADO A DISTANCIA (REMOTE KEYPAD)

Para tener acceso a cualquier canal empleando las teclas.

#### RETORNO AL CANAL ANTERIOR (FLASHBACK)

Para volver al canal anterior.

#### PREFERENCIAS PERSONALES

Con los botones Personal Preference puede programar sus programas favoritos utilizando las cuatro categorías A, B, C y D. Puede acceder a los canales rápidamente utilizando estos botones. (Consulte la página 32)

#### AUMENTO/DISMINUCION DEL VOLUMEN (VOLUME UP/DOWN)

(+) Aumenta el sonido.  
(-) Disminuye el sonido.  
• En modo de MENU cambia o selecciona el ajuste del televisor.

#### PREPARACION (MENU)

Pulsando → Accede al MENU PRINCIPAL.  
Pulsando nuevamente → Sale del MENU PRINCIPAL.

#### CONMUTADOR SELECTOR DE TELEVISOR/TV POR CABLE (TV-CATV)

En la posición TV, el mando envía los comandos de alimentación y selección de canales (botones de canal superior/inferior y de acceso aleatorio) a un televisor. En la posición CATV, envía los comandos de alimentación y selección de canales a un convertidor de TV por cable.

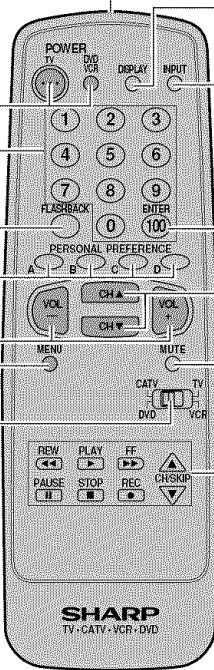

Ventanilla del transmisor de infrarrojos

#### VISUALIZACION (DISPLAY)

Pulsando → Aparece el canal de recepción por cuatro segundos.  
Pulsando nuevamente → Elimina la visualización.

• En el modo de "Closed Caption" se muestra el canal de recepción por un corto tiempo.

#### ENTRADA (INPUT)

Pulsando → Cambia al modo de entrada 1 del video externo.  
Pulsando 2 veces → Cambia al modo de entrada 2 del video externo.  
Pulsando 3 veces → Cambia al modo de entrada 3 del video externo o al modo COMPONENT.  
Pulsando 4 veces → Vuelve al modo TV original. Consulte la página 38.

#### INTRODUCIR (ENTER)

Se utiliza en algunos casos en los cuales una Caja de Inversor de Cable requiere una orden "enter" después de seleccionar los canales, al usar el teclado a distancia. (Consulte la página 39)

#### CANAL SUPERIOR/INFERIOR (CHANNEL UP/DOWN)

(▲) Selecciona el siguiente canal superior.  
(▼) Selecciona el siguiente canal inferior.  
• Consulte las páginas 28 ~ 30 para obtener información sobre el preajuste de canales.  
• En el modo de MENU, mueve la marca "●".

#### SILENCIAMIENTO (MUTE)

Pulsando → Silencia el sonido.  
Pulsando nuevamente → Restaura el sonido.  
• CLOSED CAPTION aparece automáticamente cuando el sonido es silenciado. Siempre y cuando la transmisión tenga esta señal.

#### CONTROLES DEL DVD/VIDEO

Consulte la página 40.

### Nota:

- Los botones que arriba pueden verse sombreados en el Control Remoto lucen en la oscuridad. Para usar el visor del control remoto que luce en la oscuridad, colocarlo bajo una luz fluorescente u otra fuente luminosa.
- El material fosforescente no contiene elementos radiactivos ni tóxicos, de modo que su uso no representa ningún peligro.
- El grado de iluminación variará de acuerdo con la potencia de la luz utilizada.
- El grado de iluminación irá decayendo con el tiempo y dependiendo de la temperatura.
- El tiempo necesario para cargar el visor fosforescente variará de acuerdo con la iluminación circundante.
- La luz del sol y la luz fluorescente son las más eficaces para la carga del visor.

# Antes de llamar al servicio de reparaciones

Verifique estos puntos para ver si usted mismo puede solucionar el problema.

| <p style="text-align: center;"><b>LISTA DE COMPROBACIONES DE SERVICIO RAPIDO</b></p>                | <p style="text-align: center;"><b>PROBLEMA</b></p> | El video o el reproductor de discos de video no reproducen imágenes | El equipo de video/audio externo no produce imágenes ni sonido | El mando a distancia no funciona | Barras en la pantalla | Imagen distorsionada | La imagen se desplaza verticalmente | No hay color | Mala recepción de algunos canales | Imagen débil | Franjas en la imagen | Imagen fantasma | Imagen borrosa | Sonido adecuado, imagen mala | Imagen adecuada, sonido malo | No hay imagen ni sonido | Imagen oscura y en blanco | Interferencia de ruido eléctrico externo con el funcionamiento del televisor | El color se ve distorsionado en parte de la pantalla |
|---|--|---|--|----------------------------------|-----------------------|----------------------|-------------------------------------|--------------|-----------------------------------|--------------|----------------------|-----------------|----------------|------------------------------|------------------------------|-------------------------|---------------------------|--|--|
| POSIBLE SOLUCIÓN  |  |   |  |                                  |                       |                      |                                     |              |                                   |              |                      |                 |                |                              |                              |                         |                           |  |  |
| Pruebe con otro canal y si todo está bien, el problema puede ser de la emisora.                     |  |   |  |                                  |                       | X                    | X                                   | X            | X                                 | X            | X                    | X               | X              | X                            | X                            | X                       |                           |  |  |
| Está conectado el televisor? Llega electricidad al tomacorrientes?                                  |  | X   | X  |                                  |                       |                      |                                     |              |                                   |              |                      |                 |                |                              |                              |                         | X                         |  |  |
| Está conectado el interruptor del televisor?  |  | X   |  |                                  |                       |                      |                                     |              |                                   |              |                      |                 |                |                              |                              |                         | X                         |  |  |
| Está conectado la antena al terminal del panel posterior del televisor?                             |  |   |  |                                  |                       |                      |                                     | X            | X                                 | X            |                      | X               |                | X                            |                              | X                       |                           |  |  |
| Si utiliza una antena exterior, cerciórese de que el cable no esté dañado.                          |  |   |  |                                  | X                     | X                    | X                                   | X            | X                                 | X            | X                    | X               | X              | X                            |                              | X                       |                           |  |  |
| Compruebe si hay interferencia local.   |  |   |  | X                                | X                     | X                    |                                     | X            | X                                 | X            | X                    | X               | X              | X                            | X                            |                         |                           |  | X  |
| Desconecte el interruptor POWER y vuelva a conectarlo después de transcurrir un minuto.             |  | X   |  |                                  |                       |                      |                                     |              |                                   |              |                      |                 |                |                              |                              |                         | X                         |  |  |
| Ajuste el control de COLOR.   |  |   |  |                                  |                       |                      |                                     | X            |                                   |              |                      |                 |                |                              |                              |                         |                           |  |  |
| Ajuste el control de MATIZ.   |  |   |  |                                  |                       |                      |                                     |              |                                   | X            |                      |                 |                | X                            |                              |                         |                           |  |  |
| Verifique los productos externos de Video/Audio, revise si hay fugas de conexiones sueltas o rotas. | X  | X   |  |                                  |                       |                      |                                     |              |                                   |              |                      |                 |                | X                            | X                            | X                       |                           |  |  |
| Compruebe el estado de las pilas del mando a distancia.   |  |   | X  |                                  |                       |                      |                                     |              |                                   |              |                      |                 |                |                              |                              |                         |                           |  |  |
| Pulse el botón TV/VCR del control remoto para seleccionar el modo TV.                               |  |   | X  |                                  |                       |                      |                                     |              |                                   |              |                      |                 |                |                              |                              |                         |                           |  |  |
| Están bien conectados los cables de sonido? Compruebe el nivel del volumen.                         |  |   |  |                                  |                       |                      |                                     |              |                                   |              |                      |                 |                |                              | X                            | X                       |                           |  |  |
| Está conectado el altavoz?  |  |   |  |                                  |                       |                      |                                     |              |                                   |              |                      |                 |                |                              |                              | X                       |                           |  |  |
| Desactive (OFF) el modo CLOSED CAPTION / Desactive (OFF) el modo Ahorro de Energía (Energy Save).   |  |   |  |                                  |                       |                      |                                     |              |                                   |              |                      |                 |                |                              |                              |                         |                           | X  |  |
| Desenchufe el televisor y vuelva a enchufarlo después de dos minutos o más.                         |  |   | X  |                                  |                       | X                    | X                                   | X            | X                                 |              |                      |                 |                | X                            | X                            | X                       | X                         | X  | X  |

**Nota:**

- Cuando se ve en modo TEXTO sin recibir emisiones de TEXTO, la pantalla puede ponerse en blanco y negro. Si ocurriera ésto, ponga el modo CLOSED CAPTION en OFF.



(Imagen oscura y en blanco)

## Solicitud de servicio técnico

Para la localización del Servicio Técnico Autorizado de Sharp más próximo o para conseguir material de información, repuestos o asistencia técnica, llame a 1-800-BE-SHARP.

Lisez attentivement ces instructions et gardez-les à proximité pour toute référence ultérieure.

**IMPORTANT**

Afin de vous aider en cas de perte ou de vol, inscrivez les numéros de série et de modèle du téléviseur dans les espaces fournis à cet effet. Ces numéros sont situés à l'arrière du téléviseur.

|  |
|--|
| <p><b>N° du modèle :</b></p> <p><b>N° de série :</b></p> |
|--|

# INFORMATIONS IMPORTANTES

Deux raisons importantes d'enregistrer rapidement la garantie de votre nouveau téléviseur SHARP à l'aide de la carte d'enregistrement (REGISTRATION CARD) incluse dans le colis :

**LA PREMIERE – LA GARANTIE**

Grâce à elle, vous obtiendrez immédiatement les avantages client concernant la garantie des pièces, du service et des travaux applicable à votre achat.

**LA DEUXIEME – LA LOI SUR LA SECURITE DU PRODUIT DE CONSOMMATION (CONSUMER PRODUCT SAFETY ACT)**

Grâce à elle, vous recevrez rapidement un avis de sécurité lors du contrôle, de la modification ou du rappel de votre produit que SHARP peut être amené à fournir conformément à la loi de 1972 sur la sécurité du produit de consommation. LISEZ ATTENTIVEMENT LE PARAGRAPHE «GARANTIE LIMITEE» DE LA DERNIERE PAGE.

**ENERGY STAR® : QU'EST-CE QUEC'EST**

Les téléviseurs et les magnétoscopes utilisent de l'énergie lorsqu'ils sont allumés et éteints. Les Américains dépensent plus d'1 milliard de dollars par an en énergie consommée par les téléviseurs et les magnétoscopes une fois éteints. Les nouveaux modèles ENERGY STAR® réduisent jusqu'à 75 % ce gaspillage d'énergie. Ce qui représente finalement plus de 500 millions de dollars par an d'économie d'énergie pour les consommateurs.

Ces économies aident à réduire la combustion des énergies fossiles et la pollution au gaz carbonique associée, qui contribue au réchauffement de la planète. Si toutes les familles américaines remplaçaient leurs téléviseurs et leurs magnétoscopes par des modèles ENERGY STAR®, les émissions de gaz carbonique seraient réduites de cinq millions de tonnes par an — ce qui reviendrait à éliminer la pollution émise par plus d'un million de voitures.

En utilisant les produits ENERGY STAR®, vous économiserez également de l'argent sur vos factures d'électricité et vous utiliserez moins d'énergie. Un peu de bon sens économique au profit de notre environnement !

**AVERTISSEMENT: POUR REDUIRE LE RISQUE D'INCENDIE OU D'ELECTROCUTION, N'EXPOSEZ PAS CET EQUIPEMENT A DES ENDROITS TRES HUMIDES.**

|   |  |   |
|---|--|---|
|   | <p><b>ATTENTION</b></p> <p><b>RISQUE D'ELECTROCUTION</b></p> <p><b>NE PAS OUVRIR</b></p> |  |
| <p><b>ATTENTION : POUR REDUIRE LE RISQUE D'ELECTROCUTION, NE RETIREZ PAS LE CAPOT (OU LE PANNEAU ARRIERE). L'APPAREIL NE CONTIENT AUCUNE PIECE A ENTREtenir PAR L'UTILISATEUR. CONSULTEZ UN PERSONNEL QUALIFIE POUR LA MAINTENANCE.</b></p> |  |   |



Le symbole de la foudre sous forme de flèche dans un triangle est supposé indiquer à l'utilisateur que les pièces internes au produit constituent un risque d'électrocution.

Le symbole du point d'exclamation dans un triangle est supposé indiquer à l'utilisateur que des instructions de fonctionnement et de maintenance importantes se trouvent dans la documentation fournie avec l'équipement.

"Note à l'intention de l'installateur du système CATV : Ce rappel est fourni afin d'attirer l'attention de l'installateur de système CATV sur l'article 820-40 du National Electrical Code qui indique les règles de mise à la terre appropriée et, en particulier, spécifie que la ligne de terre doit être connectée au réseau commun de mise à la terre du bâtiment, au point le plus proche possible de la source."

# INFORMATIONS IMPORTANTES (Suite)

**AVERTISSEMENT** - Les réglementations FCC établissent que des changements ou des modifications non autorisés sur cet équipement et non approuvés expressément par le fabricant peuvent annuler tout pouvoir de l'utilisateur sur le fonctionnement de cet équipement.

## MISE AU REBUT DU PRODUIT

Ce produit utilise un tube à rayons cathodiques (TRC) contenant du plomb à braser et du brasage tendre. La mise au rebut de ces matières peut être réglementée pour des raisons environnementales. Pour toute information sur la mise au rebut ou le recyclage, contactez les autorités locales ou les précautions importantes préconisées par la société Electronics Industries Alliance sur : [www.eiae.org](http://www.eiae.org).

**ATTENTION:** Ne placez pas le cordon d'alimentation sous le téléviseur ou sous tout autre objet lourd.

# PRÉCAUTIONS IMPORTANTES

**ATTENTION :** Veuillez lire toutes ces instructions avant d'utiliser votre télévision et conservez-les pour un usage ultérieur.

L'énergie électrique peut exécuter de nombreuses fonctions utiles. Cet appareil a été conçu et fabriqué de façon à garantir votre entière sécurité. CEPENDANT, TOUTE UTILISATION INADEQUATE PEUT ENTRAÎNER DES RISQUES D'ELECTROCUTION OU D'INCENDIE. Afin de ne pas détruire les protections intégrées à cet appareil, respectez les règles de base suivantes pour son installation, son utilisation et sa maintenance.

1. Débranchez la télévision avant de la nettoyer.
2. N'utilisez pas de nettoyeurs liquides ou d'aérosols et utilisez un chiffon humide.
3. N'utilisez pas d'accessoires déconseillés par le fabricant de matériel vidéo, car ils impliquent des risques.
4. N'utilisez pas cette télévision à proximité d'eau — par exemple, près d'une baignoire, d'un lavabo, d'un évier ou d'un bac à laver, dans une cave humide ou près d'une piscine, etc.
5. Ne placez pas cet équipement sur un chariot, un support ou une table instable. La télévision peut tomber et provoquer de graves lésions à toute personne et causer de sérieux dommages à l'équipement. Utilisez uniquement un support ou un chariot recommandé par le fabricant ou vendu avec la télévision.
6. L'ensemble télévision-chariot doit être déplacé délicatement. Les arrêts brusques, une force excessive et des surfaces inégales peuvent renverser l'ensemble.
7. L'installation au mur ou sur une tablette doit être réalisée conformément aux instructions du fabricant et à l'aide d'un kit de montage approuvé par ce dernier.
8. Les fentes et les ouvertures du châssis à l'arrière ou dans la partie inférieure sont prévus pour la ventilation. Pour garantir un fonctionnement fiable de la télévision et pour la protéger de toute surchauffe, ces ouvertures ne doivent être ni obturées, ni recouvertes. La télévision ne doit pas être placée dans un endroit encastré tel qu'une bibliothèque, sauf si une ventilation adéquate est prévue.
9. Les ouvertures ne doivent jamais être recouvertes par un chiffon ou autre et celles de la partie inférieure ne doivent jamais être obturées si vous placez la télévision sur un lit, un sofa, un tapis ou toute surface similaire. Cette télévision ne doit être placée ni à proximité d'un radiateur ou d'un registre de chaleur, ni dessus.
10. Cette télévision doit être alimentée uniquement par le type d'alimentation électrique indiqué sur l'étiquette. Si vous n'êtes pas sûr du type d'alimentation de votre domicile, consultez votre revendeur de télévision ou la compagnie d'électricité locale (EDF en France).
11. Du point de vue de la sécurité, la télévision est équipée d'une fiche polarisée à 2 fils (une lame plus importante que l'autre). La fiche polarisée à 2 fils ne pénètre dans la prise électrique que dans un seul sens.



Pour la télévision conçue pour fonctionner sur batterie, reportez-vous au mode d'emploi.

12. Ne posez rien sur le cordon d'alimentation. Ne placez pas la télévision dans un emplacement où le cordon d'alimentation est susceptible d'être endommagé par le passage répété de personnes.

# PRÉCAUTIONS IMPORTANTES (suite)

13. Respectez tous les avertissements et instructions mentionnés sur la télévision.
14. Si une antenne extérieure est raccordée à la télévision, veillez à ce que le système d'antenne soit relié à la terre de façon à fournir une protection vis-à-vis des poussées de tension et des charges électrostatiques accumulées. La section 810 du National Electrical Code fournit des informations relatives à une mise à la terre correcte de la potence et de la structure portante, à une mise à la terre du fil d'entrée à une unité de décharge d'antenne, aux dimensions des conducteurs de terre, à l'emplacement de l'unité de décharge d'antenne, au raccordement des prises de terre ainsi qu'à leurs exigences.

## EXEMPLE DE MISE A LA TERRE D'ANTENNE CONFORME AU NATIONAL ELECTRICAL CODE.

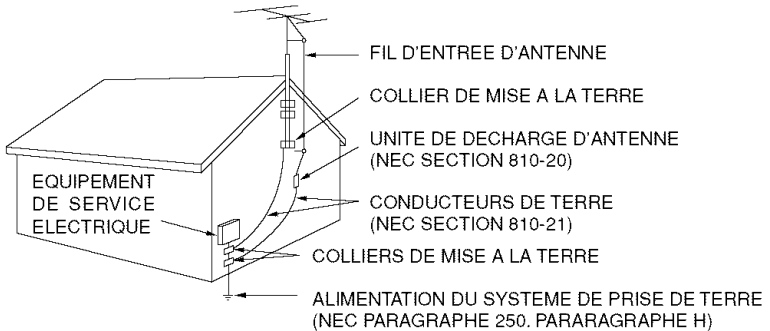

NEC- NATIONAL ELECTRICAL CODE

15. Pour tout ajout de protection à votre télévision en cas de foudre ou lorsque elle reste en veille et inutilisée pendant de longues périodes, débranchez-la et déconnectez l'antenne. Vous éviterez ainsi des dommages à votre équipement suite à la foudre et des poussées de tension.
16. Un système d'antenne extérieure ne doit pas être situé à proximité de lignes aériennes ou d'autres groupes électrogènes ou circuits électriques ou dans des emplacements où l'antenne pourrait tomber sur ce type de lignes ou circuits. Lors de l'installation d'un système d'antenne extérieure, faites extrêmement attention à ne pas entrer en contact avec ces lignes ou circuits, car cela pourrait vous être fatal.
17. Ne surchargez pas les prises et les prolongateurs de ligne afin d'éviter tout risque d'incendie ou d'électrocution.
18. N'introduisez jamais d'objets à travers les fentes du châssis, car ils pourraient entrer en contact avec des points de tension dangereux ou des pièces court-circuitées et provoquer ainsi un incendie ou une électrocution. Ne répandez jamais de liquides sur la télévision.
19. N'essayez pas de réparer vous-même votre télévision. L'ouverture ou le retrait des capots peut vous exposer à une tension dangereuse ou à d'autres risques. Confiez toutes les opérations de maintenance à un personnel qualifié.
20. Lorsque vous êtes confronté aux situations suivantes, débranchez la télévision et confiez toutes les opérations de maintenance à un personnel qualifié :
  - A. lorsque le cordon d'alimentation ou la fiche est endommagé ou effiloché ;
  - B. si du liquide a été répandu sur/dans la télévision ;
  - C. si la télévision a été exposée à la pluie ou à l'eau ;
  - D. si la télévision ne fonctionne pas normalement même en respectant le mode d'emploi. Réglez uniquement les commandes abordées par le mode d'emploi. Des réglages inappropriés d'autres commandes peuvent occasionner des dommages et nécessiteront ensuite, dans la plupart des cas, une intervention plus importante d'un technicien qualifié pour que la télévision fonctionne normalement ;
  - E. si la télévision a été renversée ou que le châssis est endommagé ;
  - F. lorsque la télévision présente une altération visible des performances — cela indique un besoin de maintenance.
21. Pour toute maintenance ou réparation de la télévision, demandez au technicien de réaliser des contrôles de sécurité classiques afin de déterminer si la télévision est en bon état de marche.
22. Lorsqu'un remplacement de pièces se révèle nécessaire, veillez à ce que le technicien utilise des pièces de rechange spécifiées par le fabricant et qu'elles aient les mêmes caractéristiques que la pièce d'origine. Des remplacements non autorisés peuvent occasionner un incendie, une électrocution ou d'autres risques.

# Référence rapide sur les commandes

## Emplacement des touches

(FRANÇAIS)

### Panneau Avant

#### ALIMENTATION (POWER)

Appuyer → Pour mettre sous tension.  
Appuyer de nouveau → Pour mettre hors tension.

#### ZONE DE DETECTION DU CAPTEUR

#### RÉGLAGE (MENU)

Appuyer → Pour mettre sous tension.  
Appuyer de nouveau → Pour mettre hors tension.

#### AUGMENTATION/RÉDUCTION DU VOLUME SONORE (VOL.)

(+) Pour augmenter le volume du son.  
(-) Pour diminuer le volume du son.

#### PRISES D'ENTRÉE VIDÉO/AUDIO [IN 2] (DERRIERE LE VOLET)

#### TOUCHES DES CANAUX CROISSANT/DÉCROISSANT (CH) - MENU

(▲) Sélectionne le canal supérieur suivant.  
(▼) Sélectionne le canal inférieur précédent.

• Appuyez simultanément sur ces deux touches pour accéder à l'écran MENU PRINCIPAL.

## Fonctions de base de la télécommande

#### ALIMENTATION (POWER)

Appuyer pour mettre sous tension.  
Appuyer de nouveau pour mettre hors tension.

#### PAVE NUMERIQUE DE COMMANDE A DISTANCE (REMOTE KEYPAD)

Sélectionne directement le canal voulu sur le pavé numérique.

#### RETOUR (FLASHBACK)

Rappelle le canal regardé précédemment.

#### PREFERENCES PERSONNELLES

Grâce aux touches de préférence personnelle, vous pouvez programmer vos programmes préférés à l'aide des 4 catégories:

A, B, C et D. Ces touches vous permettent d'accéder rapidement à ces canaux. (Voir page 32)

#### AUGMENTATION/RÉDUCTION DU VOLUME SONORE (VOLUME UP/DOWN)

(+) Pour augmenter le volume du son.  
(-) Pour diminuer le volume du son.  
• Pour changer ou sélectionner les réglages du téléviseur en mode menu.

#### RÉGLAGE (MENU)

Appuyer → Accès au MENU PRINCIPAL.  
Appuyer de nouveau → Sortie du MENU PRINCIPAL.

#### SÉLECTEUR DE MODE DE CÂBLOVISION/DVD-TÉLÉVISION/MAGNETOSCOPE (CATV/DVD-TV/VCR)

En position télévision/magnétoscope (TV/VCR), permet de mettre le téléviseur et le magnétoscope sous/hors tension et de sélectionner ses canaux (touche de canaux en ordre croissant/décroissant et d'accès direct).  
En position câblovision/DVD (CATV/DVD), permet de mettre un convertisseur de téléviseur par câble et un lecteur de DVD sous/hors tension et de sélectionner ses canaux.

#### Fenêtre d'émission du signal infrarouge

#### AFFICHAGE (DISPLAY)

Appuyer pour afficher le canal reçu pendant quatre secondes.  
Appuyer de nouveau pour faire disparaître le canal.

• Pour afficher temporairement le canal reçu en mode Sous-titres.

#### ENTRÉE (INPUT)

Appuyer → Pour sélectionner le mode ENTREE 1 vidéo externe.  
Appuyer 2 fois → Pour sélectionner le mode ENTREE 2 vidéo externe.  
Appuyer 3 fois → Pour sélectionner le mode ENTREE 2 vidéo externe ou le mode COMPOSANT.  
Appuyer 4 fois → Pour revenir au mode TV initial. Voir page 38.

#### ENTRER (ENTER)

Parfois utilisée lorsqu'un convertisseur nécessite l'introduction d'une commande "enter" après la sélection de canaux à l'aide du pavé numérique de commande à distance. (Voir page 39)

#### TOUCHES DES CANAUX CROISSANT/DÉCROISSANT (CHANNEL UP/DOWN)

(▲) Sélectionne le canal supérieur suivant.  
(▼) Sélectionne le canal inférieur précédent.  
• Voir pages 28 ~ 30 pour prérégler les canaux.  
• Déplace le curseur "●" sur l'écran du MENU.

#### SOURDINE (MUTE)

Appuyer → Mise en sourdine du son.  
Appuyer de nouveau → Rétablissement du son.  
• CLOSED CAPTION apparaît lorsque le son est mis en sourdine.

#### COMMANDE DU LECTEUR DE DVD/MAGNETOSCOPE

Voir page 40.

### Remarque:

- Les boutons ombrés de la télécommande illustrés ci-dessus brillent dans l'obscurité lorsque la télécommande a été placée sous une ampoule fluorescente ou toute autre source lumineuse.
- Le matériau phosphorescent n'est absolument pas toxique ou radioactif. Il peut donc être utilisé en toute sécurité.
- Le degré d'illumination variera en fonction de l'intensité de la source d'éclairage.
- Le degré d'illumination diminuera avec le temps, en fonction de la température.
- Le temps requis pour charger les touches phosphorescentes dépendra de l'éclairage environnant.
- Les rayons directs du soleil et les luminaires fluorescents constituent les meilleures sources de chargement des touches phosphorescentes.

# Avant d'appeler un réparateur

Vérifier les points suivants afin de déterminer s'il est possible de remédier au problème par un simple réglage des commandes.

| LISTE DES VÉRIFICATIONS POUR UN DÉPANNAGE RAPIDE   | PROBLÈME   |   |                                   |                    |                       |                              |                |                                     |                 |                                |                 |                 |                            |                             |                  |                      |   |  |
|--|--|---|-----------------------------------|--------------------|-----------------------|------------------------------|----------------|-------------------------------------|-----------------|--------------------------------|-----------------|-----------------|----------------------------|-----------------------------|------------------|----------------------|---|--|
|  | Pas de reproduction d'un magnétoscope ou lecteur de disque | Pas d'image ou de son d'un appareil vidéo/audio externe | La télécommande ne fonctionne pas | Barres sur l'écran | Distorsion de l'image | L'image défile verticalement | Pas de couleur | Faible réception de certains canaux | Image affaiblie | Lignes ou rayures dans l'image | Images fantômes | Image brouillée | Son normal, image médiocre | Image normale, son médiocre | Ni son, ni image | Image sombre et vide | Bruit électrique extérieur interférant avec le fonctionnement du téléviseur | Couleur sur une partie de l'écran semble altérée |
| SOLUTION POSSIBLE  |  |   |                                   |                    |                       |                              |                |                                     |                 |                                |                 |                 |                            |                             |                  |                      |   |  |
| Essayer un nouveau canal. S'il fonctionne, il s'agit probablement d'une panne de la chaîne.                      |  |   |                                   |                    | X                     | X                            | X              | X                                   | X               | X                              | X               | X               | X                          | X                           | X                |                      |   |  |
| Le téléviseur est-il branché?<br>La prise secteur fonctionne-t-elle?   | X  | X   |                                   |                    |                       |                              |                |                                     |                 |                                |                 |                 |                            |                             | X                |                      |   |  |
| L'interrupteur POWER du téléviseur est-il sous tension?  | X  |   |                                   |                    |                       |                              |                |                                     |                 |                                |                 |                 |                            |                             | X                |                      |   |  |
| L'antenne est-elle raccordée aux bornes à l'arrière de l'appareil?   |  |   |                                   |                    |                       |                              | X              | X                                   | X               |                                | X               |                 | X                          |                             | X                |                      |   |  |
| Si l'antenne extérieure est utilisée, s'assurer qu'il n'y a pas de fils sectionnés.                              |  |   |                                   | X                  | X                     | X                            | X              | X                                   | X               | X                              | X               | X               |                            | X                           |                  |                      |   |  |
| Vérifier s'il n'y a pas d'interférence locale ou de bruit électrique extérieur.                                  |  |   | X                                 | X                  | X                     |                              | X              | X                                   | X               | X                              |                 | X               | X                          |                             |                  |                      | X   |  |
| Mettre l'interrupteur POWER hors tension puis de nouveau sous tension au bout d'une minute.                      |  | X   |                                   |                    |                       |                              |                |                                     |                 |                                |                 |                 |                            | X                           |                  |                      |   |  |
| Régler la commande de COULEUR.   |  |   |                                   |                    |                       |                              | X              |                                     |                 |                                |                 |                 |                            |                             |                  |                      |   |  |
| Régler la commande de CONTRASTE.   |  |   |                                   |                    |                       |                              |                |                                     | X               |                                |                 |                 | X                          |                             |                  |                      |   |  |
| Vérifier l'appareil vidéo/audio externe : s'assurer que les câbles de connexion ne sont pas desserrés ou cassés. | X  | X   |                                   |                    |                       |                              |                |                                     |                 |                                |                 |                 | X                          | X                           | X                |                      |   |  |
| Vérifier les piles de la télécommande.   |  |   | X                                 |                    |                       |                              |                |                                     |                 |                                |                 |                 |                            |                             |                  |                      |   |  |
| Appuyez sur la touche TV/VCR de la télécommande pour sélectionner le mode TV.                                    |  |   | X                                 |                    |                       |                              |                |                                     |                 |                                |                 |                 |                            |                             |                  |                      |   |  |
| Les câbles audio sont-ils fermement connectés?<br>Vérifier le niveau du volume.                                  |  |   |                                   |                    |                       |                              |                |                                     |                 |                                |                 |                 |                            | X                           | X                |                      |   |  |
| Les haut-parleurs fonctionnent-ils?  |  |   |                                   |                    |                       |                              |                |                                     |                 |                                |                 |                 |                            |                             | X                |                      |   |  |
| Mettre le mode sous-titrage hors service "ARRÊT"<br>Mode d'économie d'énergie sur "ARRÊT".                       |  |   |                                   |                    |                       |                              |                |                                     |                 |                                |                 |                 |                            |                             |                  | X                    |   |  |
| Débrancher le téléviseur et le rebrancher après deux minutes.  |  |   | X                                 |                    |                       | X                            | X              | X                                   | X               |                                |                 |                 | X                          | X                           | X                | X                    | X   |  |

## Remarque:

- En mode TEXTE, s'il n'y a pas d'émission TEXTE à recevoir, l'écran du téléviseur pourrait être sombre et vide. Dans ce cas, placer le mode Sous-titrage hors service.



(Image sombre et vide)

## Appel au service après-vente

Pour connaître l'emplacement du centre de service après-vente agréé Sharp le plus proche ou pour obtenir de la documentation sur les produits, des accessoires, des consommables ou une aide au consommateur, appelez le 1-800-BE-SHARP.



# Limited Warranty

## CONSUMER LIMITED WARRANTY

SHARP ELECTRONICS CORPORATION warrants to the first consumer purchaser that this Sharp brand product (the "Product"), when shipped in its original container, will be free from defective workmanship and materials, and agrees that it will, at its option, either repair the defect or replace the defective Product or part thereof with a new or remanufactured equivalent at no charge to the purchaser for parts or labor for the period(s) set forth below.

This warranty does not apply to any appearance items of the Product nor to the additional excluded item(s) set forth below nor to any Product the exterior of which has been damaged or defaced, which has been subjected to improper voltage or other misuse, abnormal service or handling, or which has been altered or modified in design or construction.

In order to enforce the rights under this limited warranty, the purchaser should follow the steps set forth below and provide proof of purchase to the servicer.

The limited warranty described herein is in addition to whatever implied warranties may be granted to purchasers by law. ALL IMPLIED WARRANTIES INCLUDING THE WARRANTIES OF MERCHANTABILITY AND FITNESS FOR USE ARE LIMITED TO THE PERIOD(S) FROM THE DATE OF PURCHASE SET FORTH BELOW. Some states do not allow limitations on how long an implied warranty lasts, so the above limitation may not apply to you.

Neither the sales personnel of the seller nor any other person is authorized to make any warranties other than those described herein, or to extend the duration of any warranties beyond the time period described herein on behalf of Sharp.

The warranties described herein shall be the sole and exclusive warranties granted by Sharp and shall be the sole and exclusive remedy available to the purchaser. Correction of defects, in the manner and for the period of time described herein, shall constitute complete fulfillment of all liabilities and responsibilities of Sharp to the purchaser with respect to the Product, and shall constitute full satisfaction of all claims, whether based on contract, negligence, strict liability or otherwise. In no event shall Sharp be liable or in any way responsible, for any damages or defects in the Product which were caused by repairs or attempted repairs performed by anyone other than an authorized servicer. Nor shall Sharp be liable or in any way responsible for any incidental or consequential economic or property damage. Some states do not allow the exclusion of incidental or consequential damages, so that above exclusion may not apply to you.

THIS WARRANTY GIVES YOU SPECIFIC LEGAL RIGHTS. YOU MAY ALSO HAVE OTHER RIGHTS WHICH VARY FROM STATE TO STATE.

---

### Model Specific Section

#### Your Product Model Number & Description:

32UF5/6, 32 inch Color Television, (Be sure to have this information available when you need service for your Product.)

#### Warranty Period for this Product:

One (1) year parts and labor. The warranty period continues for an additional one (1) year, for a total of two (2) years, with respect to the picture tube(s) in the Product for parts only. Labor and service are not provided free of charge for this additional period.

#### Additional Item(s) Excluded from Warranty Coverage (if any):

Non-rechargeable batteries.

#### Where to Obtain Service:

From a Sharp Authorized Servicer located in the United States. To find the location of the nearest Sharp Authorized Servicer, call Sharp toll free at 1-800-BE-SHARP.

#### What to Do to Obtain Service:

Contact your Sharp Authorized Servicer to obtain in-home service for this Product. The Servicer will come to your home and if it is necessary to remove the Product, the Servicer will reinstall it. Be sure to have **Proof of Purchase** available.