

User Manual

27PT9015D

32PT7005D

32PT9005D



Thank you for choosing Philips.

Need help fast?

*Read your Quick Use Guide and/or
Owner's Manual first for quick tips
that make using your Philips product
more enjoyable.*

*If you have read your instructions
and still need assistance,
you may access our online help at
www.usasupport.philips.com
or call*

1-888-PHILIPS (744-5477)
while with your product
(and Model / Serial number)

For Customer Use

Enter below the Serial No. which is located
on the rear of the cabinet. Retain this
information for future reference.

Model No. _____

Serial No. _____

PHILIPS

Return your Product Registration Card today to get the very most from your purchase.

Registering your model with PHILIPS makes you eligible for all of the valuable benefits listed below, so don't miss out. Complete and return your Product Registration Card at once to ensure:

*Proof of Purchase

Returning the enclosed card guarantees that your date of purchase will be on file, so no additional paperwork will be required from you to obtain warranty service.

*Product Safety Notification

By registering your product, you'll receive notification - directly from the manufacturer - in the rare case of a product recall or safety defect.

*Additional Benefits of Product Ownership

Registering your product guarantees that you'll receive all of the privileges to which you're entitled, including special money-saving offers.



PHILIPS

Congratulations on your purchase, and welcome to the "family!"

Dear PHILIPS product owner:

Thank you for your confidence in PHILIPS. You've selected one of the best-built, best-backed products available today. We'll do everything in our power to keep you happy with your purchase for many years to come.

As a member of the PHILIPS "family," you're entitled to protection by one of the most comprehensive warranties and outstanding service networks in the industry. What's more, your purchase guarantees you'll receive all the information and special offers for which you qualify, plus easy access to accessories from our convenient home shopping network.

Most importantly, you can count on our uncompromising commitment to your total satisfaction.

All of this is our way of saying welcome - and thanks for investing in a PHILIPS product.

P.S. To get the most from your PHILIPS purchase, be sure to complete and return your Product Registration Card at once.

Know these **safety** symbols



This "bolt of lightning" indicates uninsulated material within your unit may cause an electrical shock. For the safety of everyone in your household, please do not remove product covering.

The "exclamation point" calls attention to features for which you should read the enclosed literature closely to prevent operating and maintenance problems.

WARNING: To reduce the risk of fire or electric shock, this apparatus should not be exposed to rain or moisture and objects filled with liquids, such as vases, should not be placed on this apparatus.

CAUTION: To prevent electric shock, match wide blade of plug to wide slot, fully insert.

ATTENTION: Pour éviter les choc électriques, introduire la lame la plus large de la fiche dans la bome correspondante de la prise et pousser jusqu'au fond.

PHILIPS

Visit our World Wide Web Site at <http://www.usasupport.philips.com>

IMPORTANT SAFETY INSTRUCTIONS

Read before operating equipment

1. Read these instructions.
2. Keep these instructions.
3. Heed all warnings.
4. Follow all instructions.
5. Do not use this TV near water.
6. Clean only with a dry cloth.
7. Do not block any of the ventilation openings. Install in accordance with the manufacturers instructions.
8. Do not install near any heat sources such as radiators, heat registers, stoves, or other apparatus (including amplifiers) that produce heat.
9. Do not defeat the safety purpose of the polarized or grounding-type plug. A polarized plug has two blades with one wider than the other. A grounding type plug has two blades and third grounding prong. The wide blade or third prong are provided for your safety. When the provided plug does not fit into your outlet, consult an electrician for replacement of the obsolete outlet.
10. Protect the power cord from being walked on or pinched particularly at plugs, convenience receptacles, and the point where they exit from the apparatus.
11. Only use attachments/accessories specified by the manufacturer.
12.  Use only with a cart, stand, tripod, bracket, or table specified by the manufacturer, or sold with the TV. When a cart is used, use caution when moving the cart/TV combination to avoid injury from tip-over.
13. Unplug this TV during lightning storms or when unused for long periods of time.
14. Refer all servicing to qualified service personnel. Servicing is required when the TV has been damaged in any way, such as power-supply cord or plug is damaged, liquid has been spilled or objects have fallen into apparatus, the TV has been exposed to rain or moisture, does not operate normally, or has been dropped.
15. This product may contain lead and mercury. Disposal of these materials may be regulated due to environmental considerations. For disposal or recycling information, please contact your local authorities or the Electronic Industries Alliance: www.eiae.org
16. Damage Requiring Service - The TV should be serviced by qualified service personnel when:
 - A. The power supply cord or the plug has been damaged; or
 - B. Objects have fallen, or liquid has been spilled into the TV; or
 - C. The TV has been exposed to rain; or
 - D. The TV does not appear to operate normally or exhibits a marked change in performance; or
 - E. The TV has been dropped, or the enclosure damaged.
17. **Tilt/Stability** - All televisions must comply with recommended international global safety standards for tilt and stability properties of its cabinet design.
 - Do not compromise these design standards by applying excessive pull force to the front, or top, of the cabinet which could ultimately overturn the product.
 - Also, do not endanger yourself, or children, by placing electronic equipment/toys on the top of the cabinet. Such items could unsuspectingly fall from the top of the set and cause product damage and/or personal injury.
18. **Wall or Ceiling Mounting** - The TV should be mounted to a wall or ceiling only as recommended by the manufacturer.
19. **Power Lines** - An outdoor antenna should be located away from power lines.
20. **Outdoor Antenna Grounding** - If an outside antenna is connected to the receiver, be sure the antenna system is grounded so as to provide some protection against voltage surges and built up static charges.

Section 810 of the National Electric Code, ANSI/NFPA No. 70-1984, provides information with respect to proper grounding of the mast and supporting structure, grounding of the lead-in wire to an antenna discharge unit, size of grounding connectors, location of antenna-discharge unit, connection to grounding electrodes, and requirements for the grounding electrode. See Figure below.
21. **Object and Liquid Entry** - Care should be taken so that objects do not fall and liquids are not spilled into the enclosure through openings.
 - a) Warning: To reduce the risk of fire or electric shock, this apparatus should not be exposed to rain or moisture and objects filled with liquids, such as vases, should not be placed on this apparatus.
22. **Battery Usage CAUTION** - To prevent battery leakage that may result in bodily injury, property damage, or damage to the unit:
 - Install all batteries correctly, with + and - aligned as marked on the unit.
 - Do not mix batteries (old and new or carbon and alkaline, etc.).
 - Remove batteries when the unit is not used for a long time.

Note to the CATV system installer: This reminder is provided to call the CATV system installer's attention to Article 820-40 of the NEC that provides guidelines for proper grounding and, in particular, specifies that the cable ground shall be connected to the grounding system of the building, as close to the point of cable entry as practical.

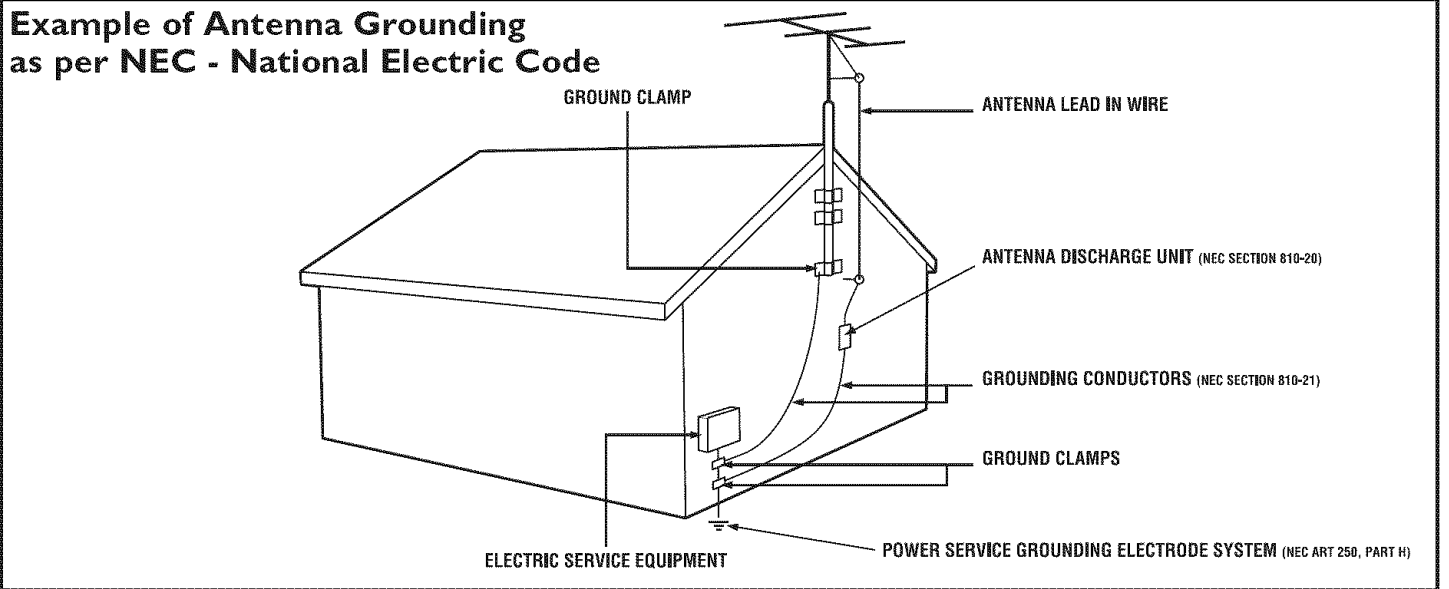







INTRODUCTION

Welcome/Registration of Your TV	2
Safety/Precautions	2/3
A Guide to Digital TV	5
Quick Tips Before You Start	5



GETTING STARTED

Description of Remote Control buttons	6
Basic TV and Remote Control Operation	7
First Time You Turn On The TV	8

INSTALLATION MENU

Auto Install	9
How To Use The Language Controls	10
How To Use The Tuner Mode Control	11
Channel Edit (Add or skip channels)	12
 Auto Chron (Synchronisation of time)	13
 Timer - Time Zone	14
 Timer - Daylight Saving	14
 How To Add Or Skip Weak Digital Signals	15
 Emergency Alert Setting	16
 Factory Channel Reset	16
 Digital Audio (Selecting audio languages)	17
Picture Menu Controls	18
Sound Menu Controls	19

FEATURES MENU

Understanding Autolock Controls	20
AutoLock	21
AutoLock - Blocking Channels	22
Block / Clear All Channels At The Same Time	23
Blocking Options	23
Movie Ratings	24
TV Ratings	25
How To Use the Timer Menu Controls	26
 Close Captioning Display in Digital Mode	27
 Caption Option in Digital Mode	27
Close Captioning in Analog Mode	28
SleepTimer	29
Rotation	29
How To Use The Format Control	30

OTHER FEATURES

Active Control	17
Auto Picture	18
Auto Sound	19
 Information Banner and Electronic Program Guide	31

IMPORTANT INFORMATION

Glossary	32
Troubleshooting	33-34
Cleaning and Care	35
Specifications	36
Limited Warranty	37
Index	38

Active Control continuously measures and corrects all incoming signals to help provide the best picture quality. This feature monitors and corrects both the sharpness control and noise reduction control (Pg. 17).

Audio Volume Leveler (AVL) Control keeps the TV sound at an even level. Differences in volume levels during commercial breaks are reduced, making for a more consistent, comfortable sound for your listening pleasure (Pg. 19).

AutoChron sets the clock of the TV automatically or manually. For automatic selection, there will be queries for Time Zone, Day Light saving and channel to seek clock. For manual selection, you need to key in the time. (Pg. 13).

AutoLock lets you block channels or programs from viewing with content not suitable for children or with restricted TV ratings (Pg. 21).

AutoPicture lets you change the picture settings (color, tint, contrast, etc.) for various types of programming, such as sports, movies, multimedia (games), or weak signals with the push of one button (Pg. 18).

AutoSound lets you select from four pre-set controls and a personal control that you set according to your own preferences through the onscreen Sound menu. The four pre-set controls (Speech, Movie, Music, and Multimedia) lets you custom set the TV sound to enhance the particular programming you are watching (Pg. 19).

Channel Edit lets you add or skip channels from the list stored in the TV memory. Channel Edit makes it easy to limit or expand the number of channels that are available to you when you press the Channel (+) or (-) buttons on your remote control (Pg. 12).

Closed Captioning allows the viewer to read TV program dialogue or voice conversations as onscreen text. (Pg. 27-28).

Digital Audio allows you to switch to another audio language when it is available. This is only for programs that are shown in more than one audio language (Page 17).

Sleep Timer automatically turns OFF the TV after a set amount of time that you have chosen (Page 29).



As an Energy Star® Partner, Philips Consumer Electronics has determined this product meets the Energy Star® guidelines for energy efficiency. Energy Star® is a U.S. registered mark. Using products with the Energy Star® label can save energy. Saving energy reduces air pollution and lowers utility bills.

Active Control, AutoPicture, AutoSound, AutoChron, and Incredible Surround are trademarks of Philips Consumer Electronics Company. Copyright 2001 Philips Consumer Electronics.



*Manufactured under license from Dolby Laboratories. "Dolby" and the double-D symbol are trademarks of Dolby Laboratories.

A GUIDE TO DIGITAL TV

What is Digital Television (DTV)?

Digital Television (DTV) is a relatively new type of broadcasting that promises to transform television viewing into a whole new experience. Digital technology is used to capture images and sound to deliver a better picture quality.

There are many levels of digital television quality. The most common are:

Standard Definition TV (SDTV)

SDTV is the basic level of quality display and resolution for both analog and digital. Transmission of SDTV can be in the traditional (4:3) or widescreen (16:9) format.

Enhanced Definition TV (EDTV)

EDTV is better in picture quality than analog television. The formats for EDTV are 480p widescreen (16:9) or traditional (4:3). EDTV is in the middle range quality between SDTV and HDTV.

High Definition TV (HDTV)

HDTV has the highest quality for digital broadcast formats. Its resolution is widescreen format (16:9). Combined with digitally enhanced sound technology, HDTV sets new standards for sound and picture quality in television.

Difference between Digital and Analog ?

Digital Television is a more flexible and efficient technology than the analog broadcast system. Analog broadcasts can only provide one program at a time. Digital television can broadcast a high definition program or more than one standard definition program at the same time. With Digital television you can receive information of programs through the Information Banner and Electronic Program Guide. This information is provided by the broadcaster.

QUICK TIPS BEFORE YOU START

- 1 When the TV is powered-on for the first time you will be prompted to auto install the TV in order to receive the channels that are broadcasted locally.
- 2 Auto Installation may take **20 to 40 minutes** depending on the number of channels that are transmitted by the cable provider or broadcaster.
- 3 When the TV is not receiving any signal from the antenna / cable, **NO SIGNAL** will appear on the TV screen. This can be caused by the antenna / cable not being plugged in correctly or when the wrong tuner mode is selected.

When no transmission is received from the broadcaster, **NO PROGRAM** will appear on the TV screen.
- 4 You will not be able to receive pay channels when using direct antenna / cable connection to the television.
- 5 When the Set-top box is connected to the television using coaxial cable, it is necessary to auto-program the television for the single channel (3 or 4) that the Set-top box outputs and change the channels at the Set-top Box to view the program.
- 6 When the Set-top box is connected to the television using **AV** connection, select the television input source for the Set-top box to view the program and change the channels at the Set-top Box to view the program.
- 7 **Pressing the A/D button on the remote control toggles the TV between Digital and Analog Mode.**

Accessories List :

- 1 Remote Control
- 2 AA batteries
- 1 User Manual
- 1 Warranty Card

DESCRIPTION OF REMOTE CONTROL BUTTONS

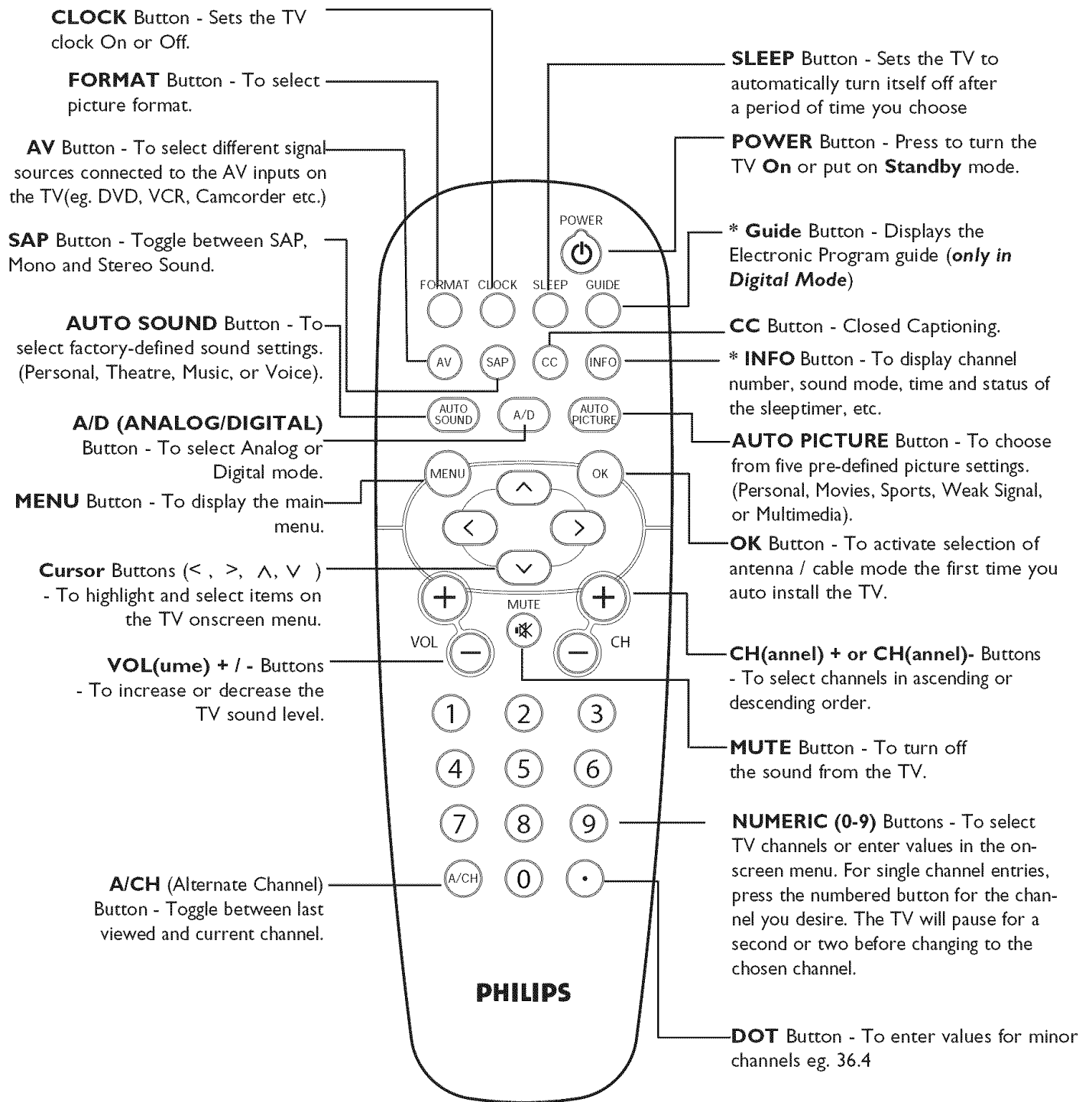

HELPFUL HINTS

* The quality and accuracy of the information on the program guide and information banner are transmitted from broadcasters. You may see a difference in broadcast time if the broadcaster is from a different time zone area (refer to page 31).

The INFO button can also be used to exit the menu display from the TV screen.

BASIC TV AND REMOTE CONTROL OPERATION

1 Press **POWER** button on the TV to turn it on. Pressing any button on the front panel of the TV will also turn the TV On.

2 Press the **VOLUME +** to increase the sound level and **VOLUME -** to lower the sound level.

Pressing both buttons together will display the onscreen menu. While in menu mode, use these buttons to make adjustments or selections.

3 Press **CHANNEL +** or **-** to select TV channels.

4 Point the remote control towards the remote sensor window on the front of the TV when using the remote control.

5 Press **MENU** button on the remote to display the onscreen menu.

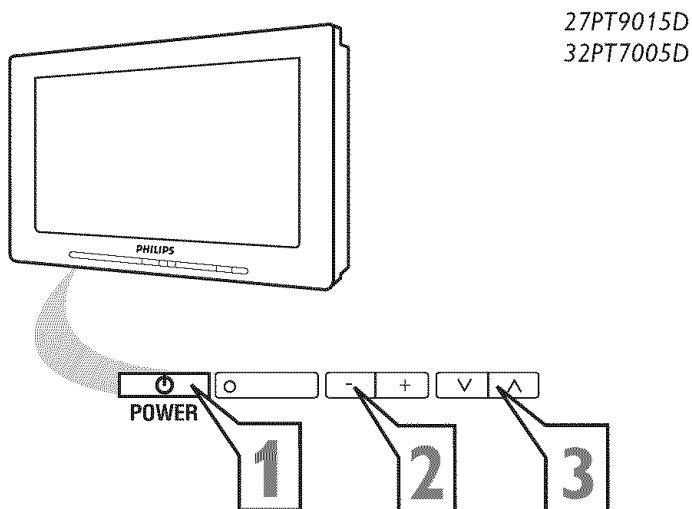
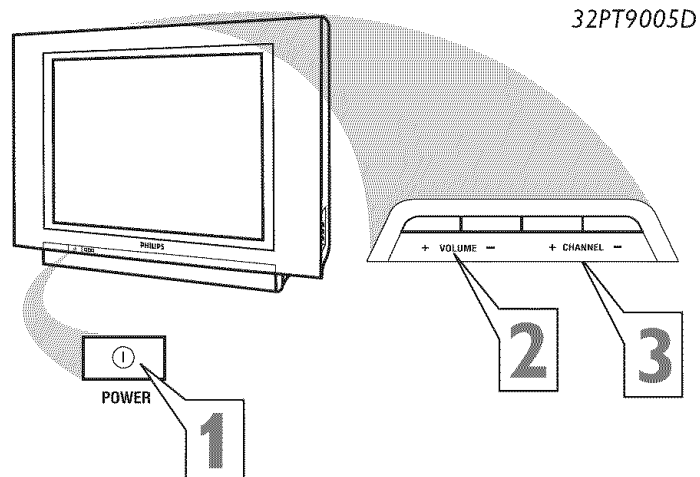

REMOTE CONTROL

How to load the supplied batteries into the remote control.

1 Remove the battery compartment lid on the back of the remote control.

2 Insert two AA-sized batteries into the battery compartment, making sure the positive + and negative - polarity line up correctly as indicated inside the case.

3 Close the battery lid.

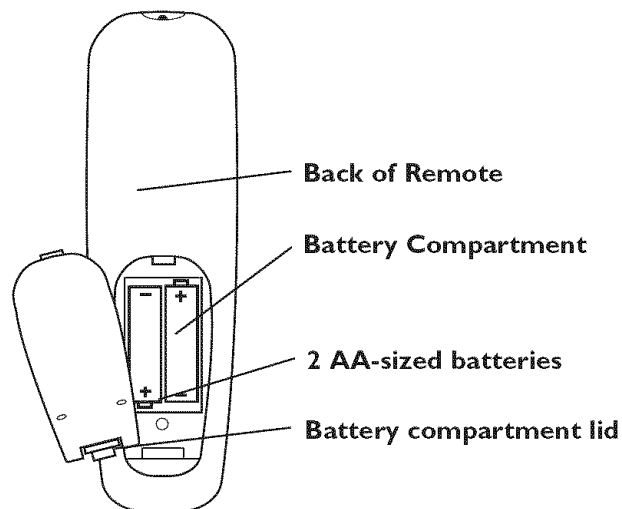

FIRST TIME YOU TURN ON THE TV

The first time you turn on the new TV set, you will see a screen that helps you to auto install the programs. Follow the instructions on this screen to start auto installation. Digital and Analog auto installation will be performed at the same time. Auto installation may take **20 to 40 minutes** depending on the number of channels available. You will see the progress of the auto installation represented by the 2 bars below the words Analog Channels and Digital Channels respectively. An active hour-glass will be displayed on the TV screen to indicate that auto installation is still in progress, please wait.

Note : This screen will only appear the first time you turn on the TV. If you wish to auto install programs later, please follow the procedure in the next page (page 9).

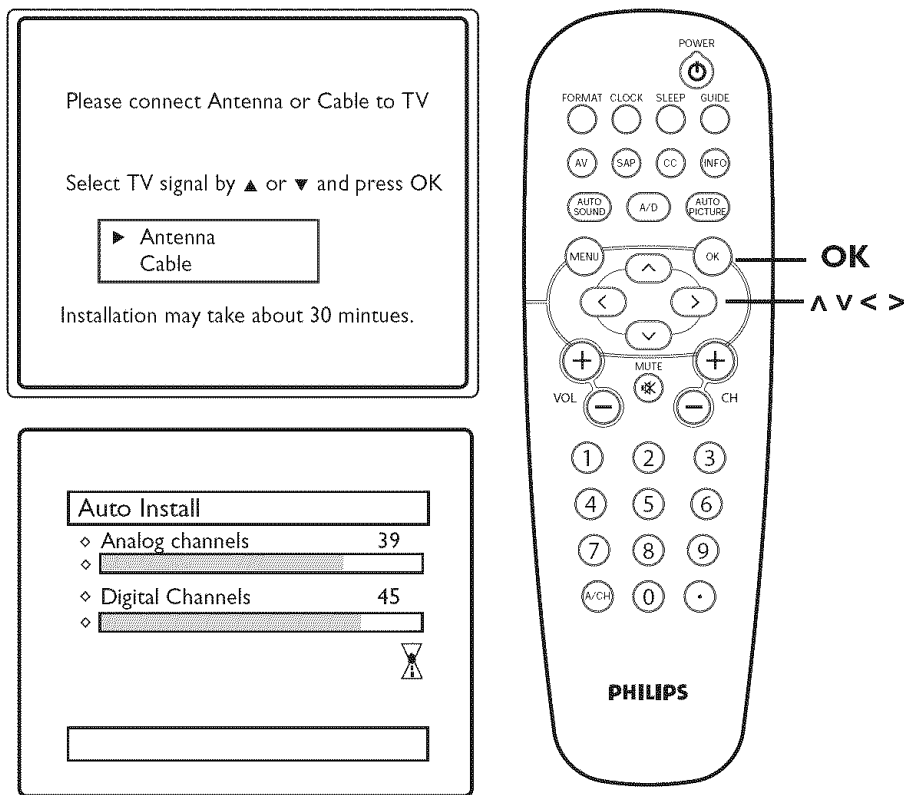

HELPFUL HINTS

ANTENNA : If you have and off-air or roof-top antenna, select **Antenna**.

CABLE : If you have subscribed to cable signal from any cable company, or you are receiving free-to-air cable channels through your wall connection select **Cable**.

When you install in either Digital or Analog mode, both Digital and Analog channels will be installed.

AUTO INSTALL

You can auto install programs on your TV. This makes it easy for you to select only the TV stations in your area when the CHANNEL (+), (-) buttons are pressed.

Follow these steps for Digital Mode and Analog Mode

- 1 Complete the antenna or cable signal connection before activating **AUTO INSTALL**. See *How to make the best connection guide* for details.
- 2 Press **MENU** button on the remote control to display the onscreen menu.
- 3 Press **CURSOR** \wedge or \vee to scroll through the onscreen menu until you see **Install** highlighted.
- 4 Press **CURSOR** $\>$ to display the **Install** menu features.
- 5 Press **CURSOR** \wedge or \vee to scroll through the Install features until you see **Auto Install** highlighted.
- 6 Press **CURSOR** $\>$ to start **Auto Installation**.
- 7 Auto Install will begin. This may take **20 to 40 minutes** depending on the number of channels available.
- 8 When finished, press **MENU** button on the remote control twice to exit the menu display from the TV screen.

Digital Mode

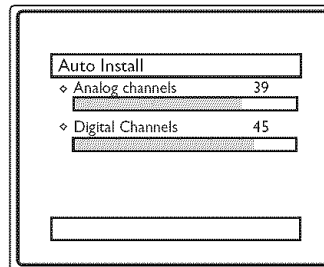
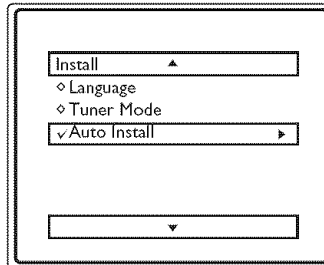
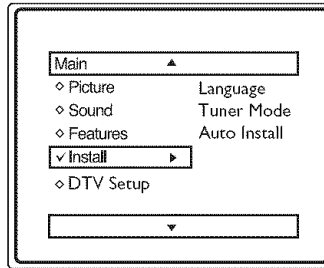

Analog Mode

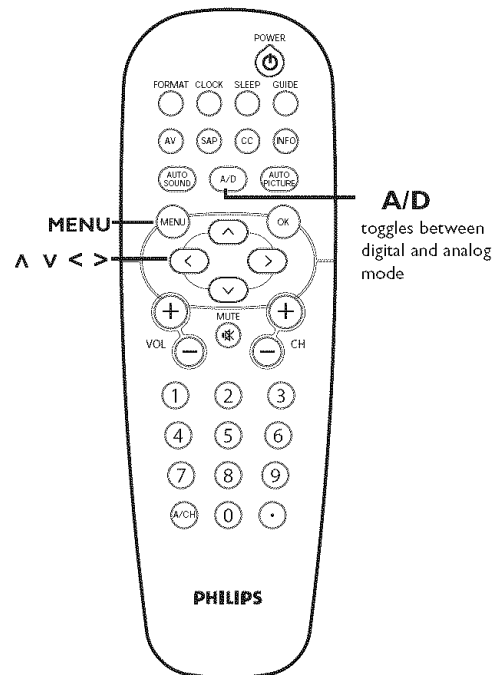
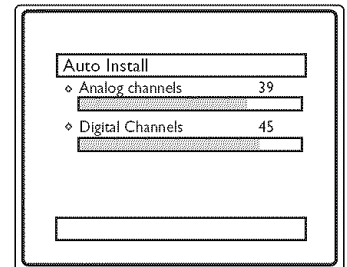
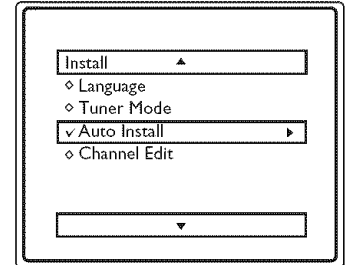
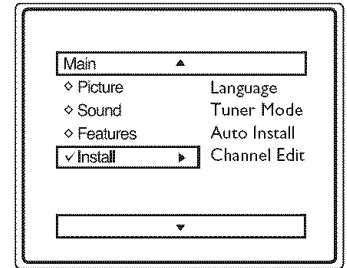

HELPFUL HINTS

When **CABLE** is selected, channels 1 to 135 are available in Digital Mode and Channels 1 to 125 are available in Analog Mode.

When **ANTENNA** is selected, channels 2 to 69 are available for both Digital and Analog Modes.

When you are in **Digital Mode**, channel numbers will be displayed as 23-1, or 100-2 etc.

When you install in either Digital or Analog mode, both Digital and Analog channels will be installed.

HOW TO USE THE LANGUAGE CONTROL

For French and Spanish speaking TV owners an onscreen Language option is present. With the Language control you can set the TV's on-screen menu to be shown in English, French, or Spanish.

Follow these steps for Digital Mode and Analog Mode

- 1 Press **MENU** button on the remote control to display the onscreen menu.
- 2 Press **CURSOR** \wedge or \vee to scroll through the onscreen menu until you see **Install** highlighted.
- 3 Press **CURSOR** $>$ to display the **Install** menu features.
- 4 Press **CURSOR** \wedge or \vee to scroll through the **Install** features until you see **Language** highlighted.
- 5 Press **CURSOR** $>$ to select **English, Français** (French) or **Español** (Spanish).
- 6 When finished, press **MENU** button on the remote twice to exit the menu from the TV screen.
- 7 Press **A/D** button on the remote to switch between Digital and Analog Channels.

Digital Mode

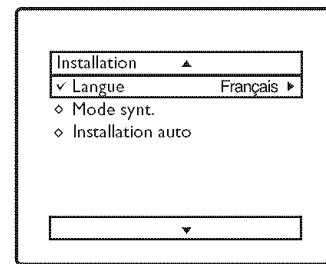
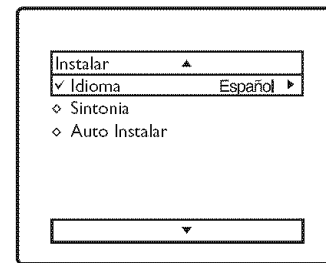
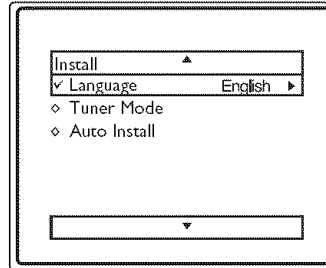
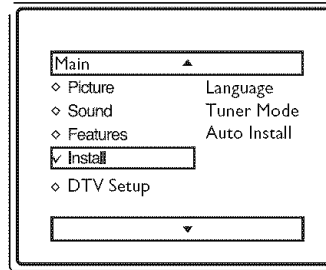

Analog Mode

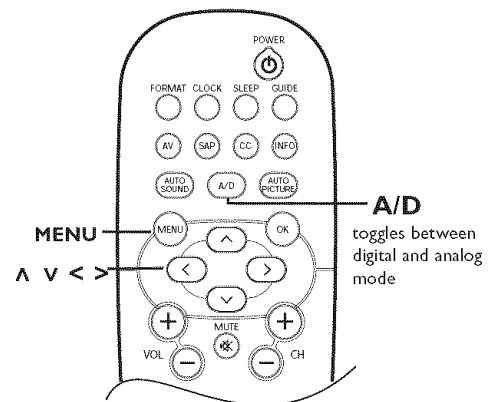
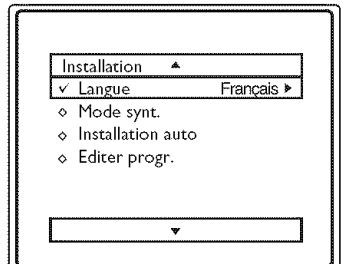
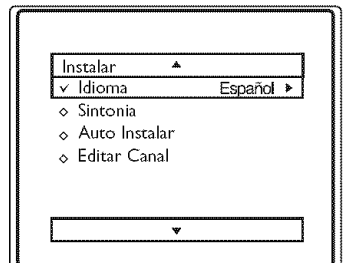
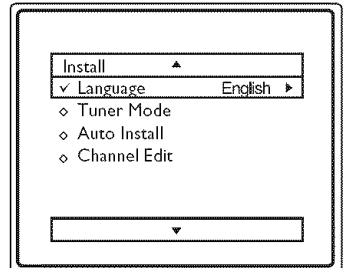
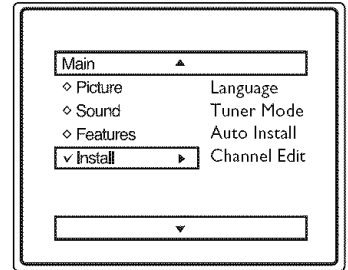

HELPFUL HINT

The Language control only makes the TV on-screen Menu items appear in English, Spanish, or French text.

It does not change the other on-screen text languages such as Closed Caption (**CC**) TV programmes.

Press **AID** button on the remote control to toggle between **Digital and Analog Mode**.

HOW TO USE THE TUNER MODE CONTROL

The TUNER MODE control lets you change the TV input signal to ANTENNA or CABLE mode. It is important that you know which type of signal to look for (Cable or Antenna).

Follow these steps for Digital Mode and Analog Mode

- 1 Press **MENU** button on the remote control to display the onscreen menu.
- 2 Press **CURSOR** \wedge or \vee to scroll through the onscreen menu until you see **Install** highlighted.
- 3 Press **CURSOR** $\>$ to display the Install menu features.
- 4 Press **CURSOR** \wedge or \vee to scroll through the Install features until you see **Tuner Mode** highlighted.
- 5 Press **CURSOR** $\>$ to select Antenna or Cable.
- 6 When finished, press **MENU** button on the remote control twice to exit the menu from the TV screen.

Digital Mode

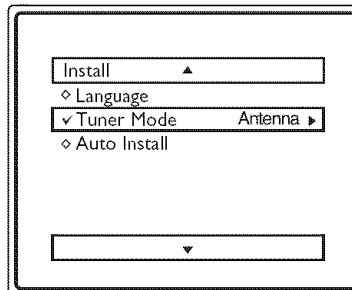
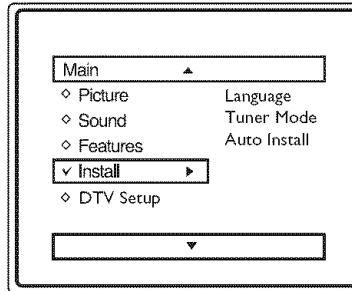

Analog Mode

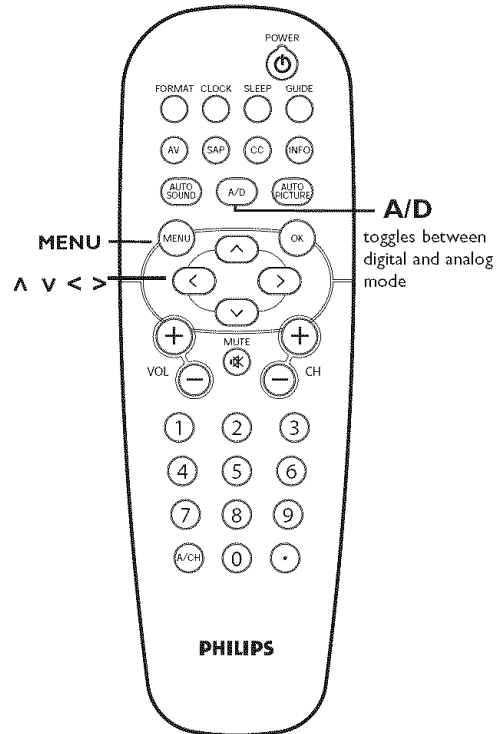
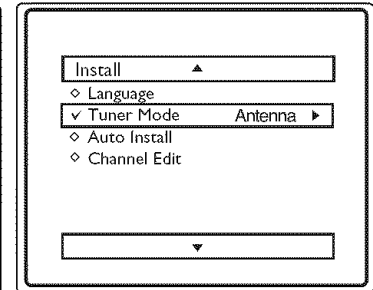
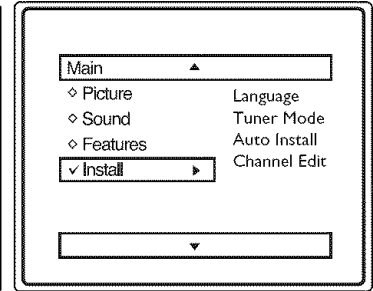

HELPFUL HINTS

When CABLE is selected, channels 1-135 are available in Digital Mode and Channels 1-125 are available in Analog Mode.

When ANTENNA is selected, channels 2-69 are available for both Digital and Analog Modes.

When you install in either Digital or Analog mode, both Digital and Analog channels will be installed.

Press **A/D** button on the remote control to toggle between **Digital and Analog Mode**.

CHANNEL EDIT (ADD OR SKIP CHANNELS)

Channel Edit allows you to add or skip channels from your favorite list.

Follow these steps for Digital Mode

- 1 Press **MENU** on the remote control to display the onscreen menu.
- 2 Press **CURSOR** \wedge or \vee to scroll through the onscreen menu until you see **DTV Setup** highlighted.
- 3 Press **CURSOR** $\>$ to highlight the **Ch. Install** menu features.
- 4 Press **CURSOR** \wedge or \vee to scroll through the **Ch. Install** features until you see **Channel Edit** highlighted.
- 5 Press **CURSOR** $\>$ to display the Channel Edit options.
- 6 Press **CURSOR** \wedge or \vee to scroll the menu to highlight the channel you wish to add or skip.
- 7 Press **CURSOR** $\>$ or $\<$ to toggle between **Added** or **Skipped**. If **Skipped** is selected, the channels will be skipped when scrolling channels with the **CH+** or **CH-**. If **Added** is selected, the channels will not be skipped when scrolling channels with the **CH+** or **CH-**.
- 8 When finished, press **MENU** on the remote control four times to exit the menu from the TV screen.

Note : When you are in Digital Mode you can only add or skip programs in Digital Channels.

Digital Mode

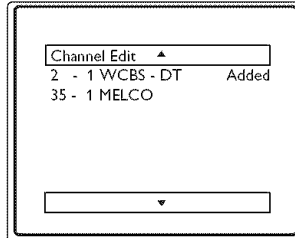
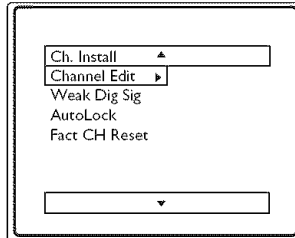
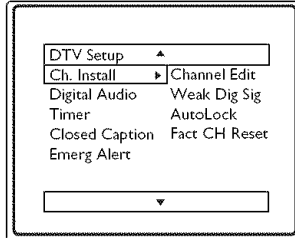
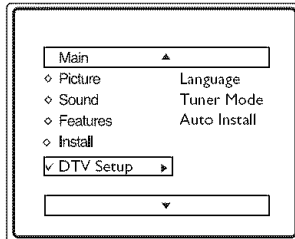

Analog Mode

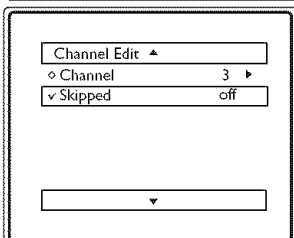
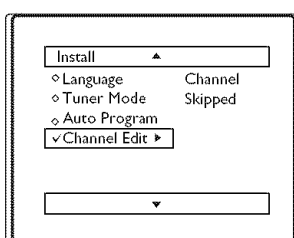
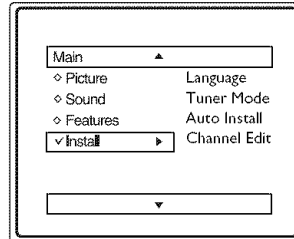

Follow these steps for Analog Mode

- 1 Press **MENU** on the remote control to display the onscreen menu.
- 2 Press **CURSOR** \wedge or \vee to scroll through the onscreen menu until you see **Install** highlighted.
- 3 Press **CURSOR** $\>$ to display the Channel Edit menu features.
- 4 Press **CURSOR** $\<$ or $\>$ until the Channel you wish to Edit is displayed.
- 5 Press **CURSOR** \vee to highlight Skipped option.
- 6 Use **CURSOR** $\>$ or $\<$ to toggle between **on** or **off**.
- 7 If **On** is selected, the channels will be skipped when scrolling channels with the **CH+** or **CH-**. If **Off** is selected, the channels will not be skipped when scrolling channels with the **CH+** or **CH-**.
- 8 When finished, press **MENU** button on the remote control three times to exit the menu from the TV screen.

Note : When you are in Analog Mode you can only add or skip programs in Analog Channels.

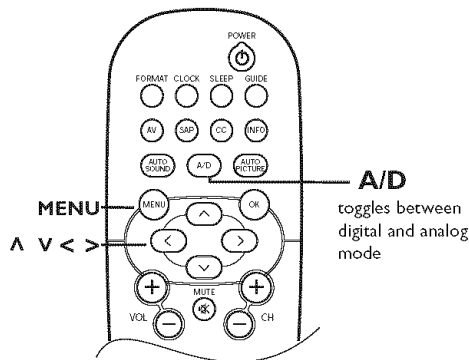

HELPFUL HINT

It is important to auto install the TV (Refer page 9) before you try to Edit the Channels. If auto installation is not done, Channel Edit will show an error message : **Favorite Channel list is empty. You must Auto Install.**

Press **A/D** button on the remote control to toggle between **Digital and Analog Mode**.

AUTO CHRON (SYNCHRONISATION OF TIME)

Auto Chron allows you to set the clock of the TV automatically for automatic selection, there will be queries for Channel, Time Zone and Day Light saving. After successful setup, Auto Chron will automatically maintain the correct time. **This feature is ONLY available in Digital Mode.**

- 1 Press **MENU** button on the remote control to display the onscreen menu.
- 2 Press **CURSOR** \wedge or \vee to scroll through the onscreen menu until you see **DTV Setup** highlighted.
- 3 Press **CURSOR** $\>$ followed by **CURSOR** \wedge or \vee to scroll through the **DTV Setup** features until you see **Timer** highlighted.
- 4 Press **CURSOR** $\>$ followed by **CURSOR** \wedge or \vee until **Auto Chron** is highlighted.
- 5 Press **CURSOR** $\>$ followed by the **NUMERIC** buttons on the remote control to enter the channel number which has the time you want your TV to be synchronized to.
- 6 When finished, press **MENU** button on the remote control three times to exit the menu from the TV screen.

Digital Mode

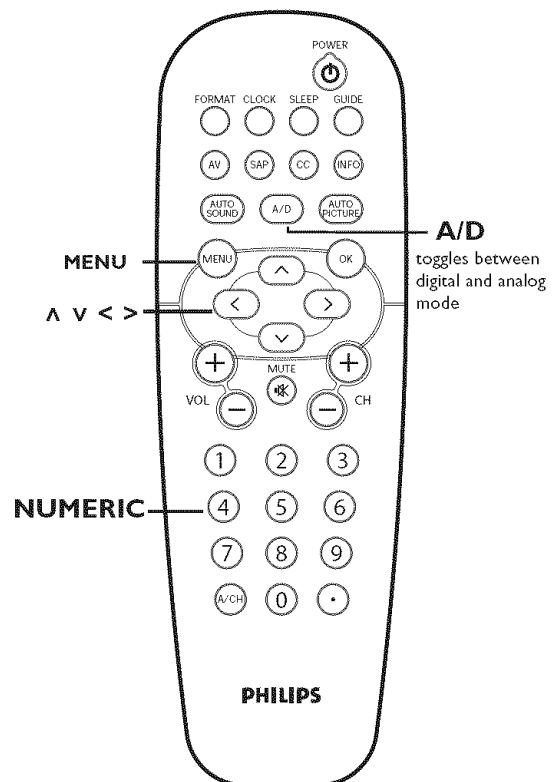
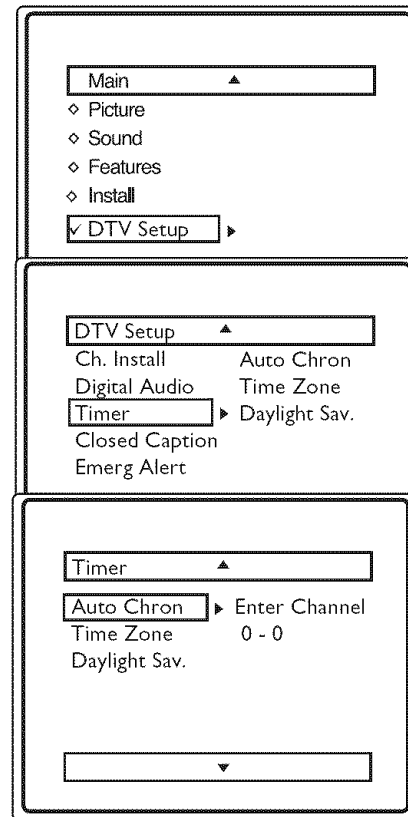

HELPFUL HINT

Press **A/D** button on the remote control to toggle between **Digital and Analog Mode**.

TIMER - TIME ZONE

Timer feature allows you to select the time zone you are in. **This Feature is ONLY available in Digital Mode.**

- 1 Press **MENU** button on the remote control to display the onscreen menu.
- 2 Press **CURSOR** \wedge or \vee to scroll through the onscreen menu until you see **DTV Setup** highlighted.
- 3 Press **CURSOR** $\>$ followed by **CURSOR** \wedge or \vee to scroll through the **DTV Setup** features until you see **Timer** highlighted.
- 4 Press **CURSOR** $\>$ followed by **CURSOR** \wedge or \vee until **Time Zone** is highlighted.
- 5 Press **CURSOR** $\>$ repeatedly to select the Time Zone you are in. Choices include **Central, Mountain, Pacific, Alaska, Hawaii, Atlantic** and **Eastern**.
- 6 When finished, press **MENU** button on the remote control four times to exit the menu from the TV screen.

Digital Mode

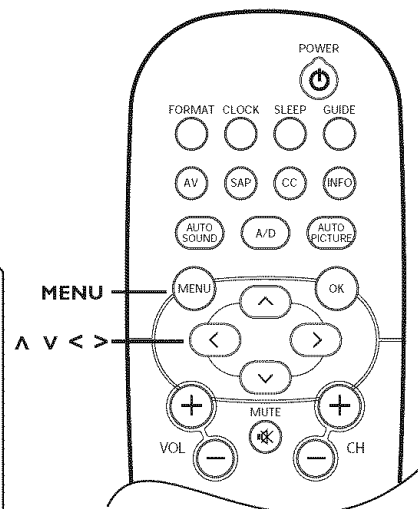
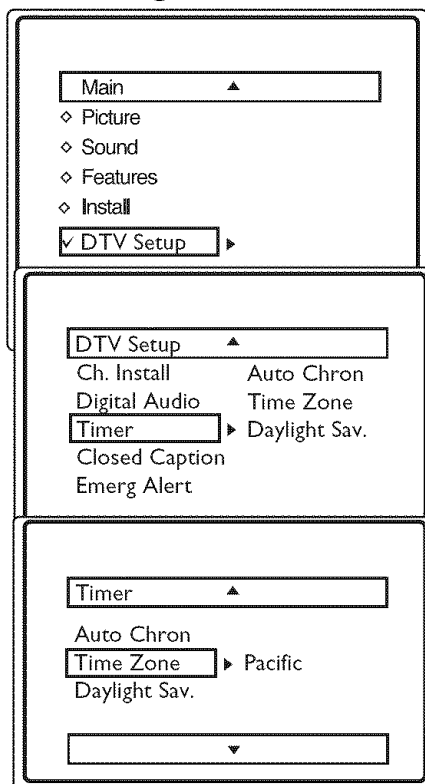

TIMER - DAYLIGHT SAVING

Daylight Saving feature in Digital Mode allows you to adjust the timer on the TV an hour ahead of the official standard time. **Daylight Saving is ONLY available in Digital Mode.**

- 1 Press **MENU** button on the remote control to display the onscreen menu.
- 2 Press **CURSOR** \wedge or \vee to scroll through the onscreen menu until you see **DTV Setup** highlighted.
- 3 Press **CURSOR** $\>$ followed by **CURSOR** \wedge or \vee to scroll through the **DTV Setup** features until you see **Timer** highlighted.
- 4 Press **CURSOR** $\>$ followed by **CURSOR** \wedge or \vee until **Daylight Sav** is highlighted.
- 5 Press **CURSOR** $\>$ to select **On** or **Off**. If **Daylight Saving** is set to **On**, the Timer on the TV will display One hour ahead of the actual time. If Daylight Saving is set to **Off**, the Timer on the TV will display the actual Time set.
- 6 When finished, press **MENU** button on the remote four times to exit the menu from the TV screen.

Digital Mode

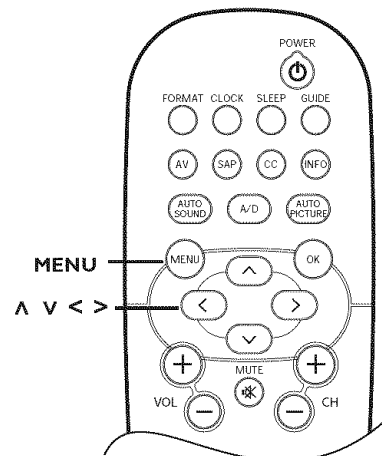
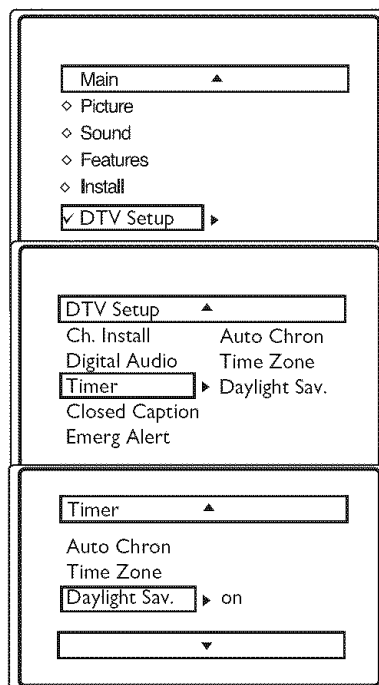

Please be reminded to set Daylight Saving to Off after the Daylight Saving Season.

HOW TO ADD OR SKIP WEAK DIGITAL SIGNAL

Digital broadcasting is still new. It is not uncommon for a broadcaster to only send out a digital signal for part of a day. The reception could also come and go. If you program your channels when the signal is not being sent or is weak it will not be saved in your channel setup. Using the **Weak Digital Signal** feature here, you can add those channels with weak or no signals to your channel list. **Adding or skipping Weak Digital Signal can ONLY be done in Digital Mode.**

- 1 Press **MENU** button on the remote control to display the onscreen menu.
- 2 Press **CURSOR** \wedge or \vee to scroll through the onscreen menu until you see **DTV Setup** highlighted.
- 3 Press **CURSOR** $\>$ to display the **DTV Setup** menu features.
- 4 Press **CURSOR** \wedge or \vee to scroll through the **DTV SETUP** features until you see **Ch. Install** highlighted. Press **CURSOR** $\>$ to display **Ch. Install** features.
- 5 Press **CURSOR** \wedge or \vee to scroll through the DTV Setup features until you see **Weak Dig Sig** highlighted.
- 6 Press **CURSOR** $\>$ to display the **Weak Dig Sig** options.
- 7 Use **CURSOR** \wedge or \vee to highlight the channel you wish to add or skip.
- 8 Use **CURSOR** $\>$ to toggle between **Added** or **Skipped**. If **Skipped** is selected the channels will be skipped when scrolling channels with **CH+** or **CH-**. If **Added** is selected the channels will not be skipped when scrolling channels with **CH+** or **CH-**.
- 9 When finished, press **MENU** button on the remote five times to exit the menu from the TV screen.

Digital Mode

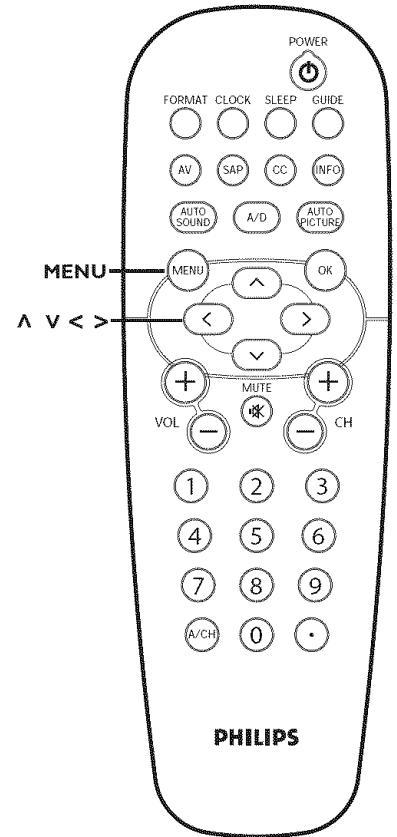
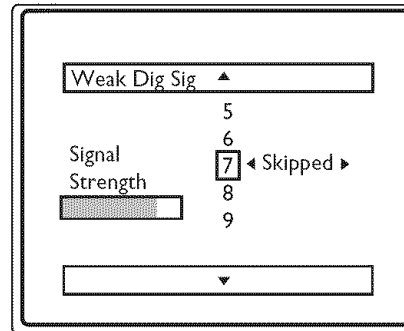
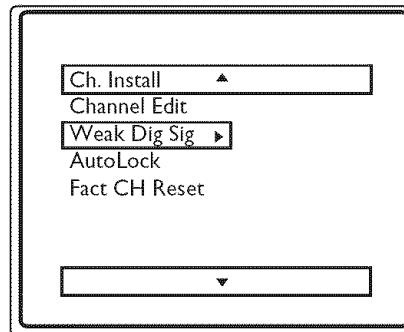
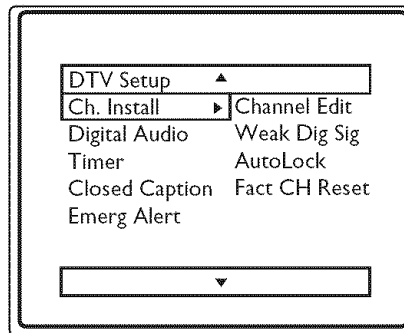
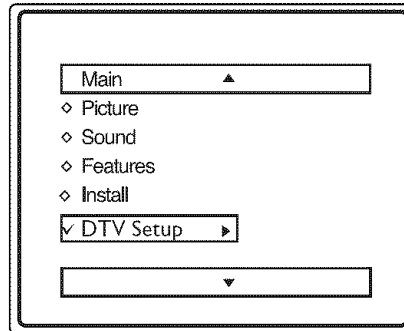

HELPFUL HINTS

When no transmission is received from the broadcaster, the message, '**NO PROGRAM**' will appear on the TV screen.

Press **AID** button on the remote control to toggle between **Digital and Analog Mode**.

EMERGENCY ALERT SETTING

Emergency Alert lets you display or discard emergency alerts for Low or Medium priority. **This feature is ONLY available in Digital mode.**

- 1 Press **MENU** button on the remote control to display the onscreen menu.
- 2 Press **CURSOR** \wedge or \vee to scroll through the onscreen menu until you see **DTV Setup** menu highlighted.
- 3 Press **CURSOR** $\>$ to display the **DTV Setup** menu features.
- 4 Press **CURSOR** \wedge or \vee to scroll through the **DTV Setup** features until you see **Emerg Alert** highlighted.
- 5 Press **CURSOR** $\>$ to enter the the **Emerg Alert** sub menu.
- 6 Press **CURSOR** \wedge or \vee to highlight either **Medium** or **Low**.
- 7 Press **CURSOR** $\>$ to switch between **On** or **Off**. If **On** is selected, the TV will display the alert of that priority.
- 8 When finished, press **MENU** button on the remote control four times to exit the menu from the TV screen.

** Emergency Alert will not be visible if no broadcast is received or when the TV is in Standby mode.*

Digital Mode

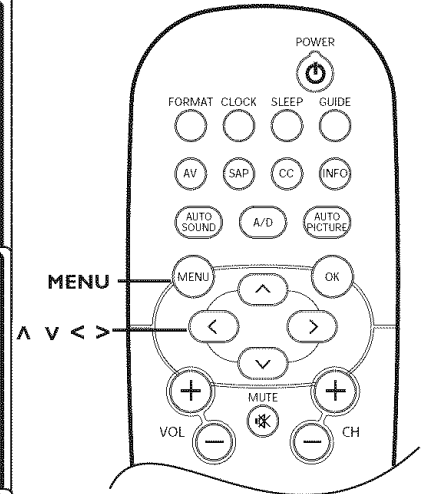
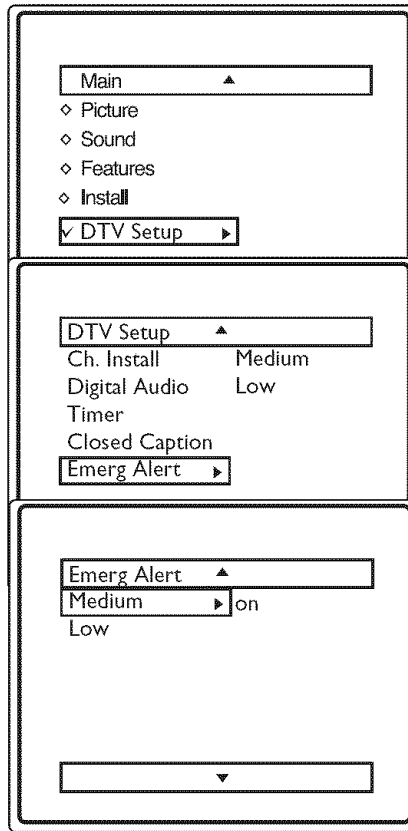

FACTORY CHANNEL RESET

Factory Channel Reset feature lets you erase the contents of the master, user and favorite channel lists. This restores the TV to the initial state before the first Auto Program operation. **This feature is ONLY available in Digital Mode.** For instructions on how to Auto Install the TV again, refer to page 9.

- 1 Press **MENU** on the remote control to display the onscreen menu.
- 2 Press **CURSOR** \wedge or \vee to scroll through the onscreen menu until you see **DTV Setup** highlighted.
- 3 Press **CURSOR** $\>$ to display the **Ch. Install** menu features.
- 4 Press **CURSOR** \wedge or \vee to scroll through the **Ch. Install** features until you see **Fact CH Reset** highlighted.
- 5 Press **CURSOR** $\>$ to clear all DTV settings **OR** Press the **Menu** button on the remote control to maintain the DTV settings.

Digital Mode

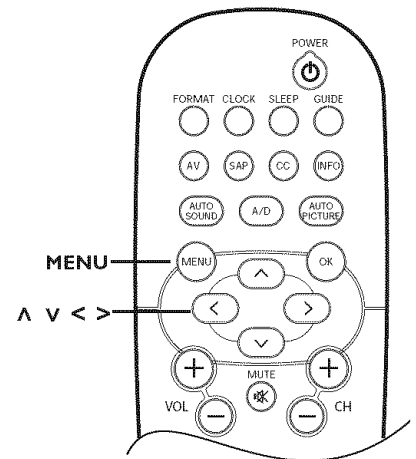
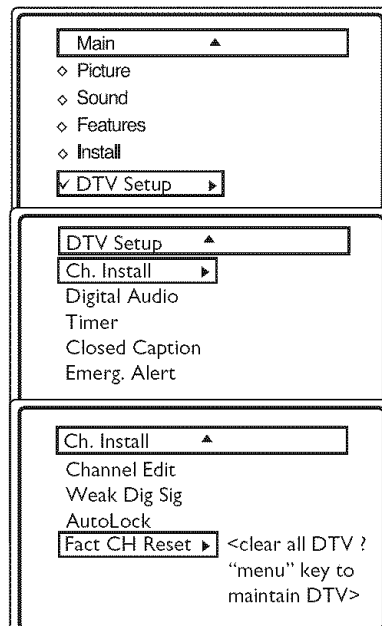

HELPFUL HINTS

Press **AID** button on the remote control to toggle between **Digital and Analog Mode**.

<clear all DTV ?
"menu" key to
maintain DTV>

DIGITAL AUDIO (SELECTING AUDIO LANGUAGES)

Digital Audio allows you to switch to another audio language when it is available. This feature is **ONLY** available in Digital Mode.

- 1 Press **MENU** button on the remote control to display the onscreen menu.
- 2 Press **CURSOR** \wedge or \vee to scroll through the onscreen menu until you see **DTV Setup** highlighted.
- 3 Press **CURSOR** $\>$ to display the **DTV Setup** menu features.
- 4 Press **CURSOR** \wedge or \vee to scroll through the **DTV SETUP** features until you see **Digital Audio** highlighted.
- 5 Press **CURSOR** $\>$ to select the language you want to hear.

Digital Mode

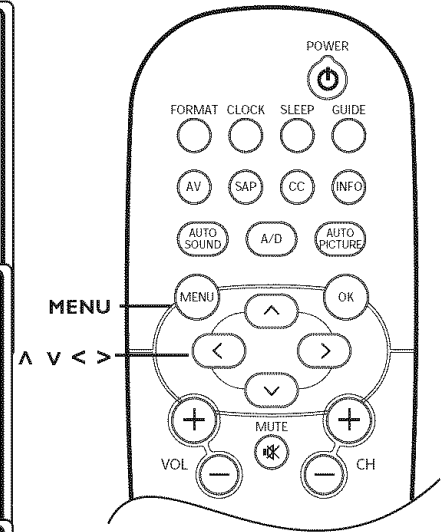
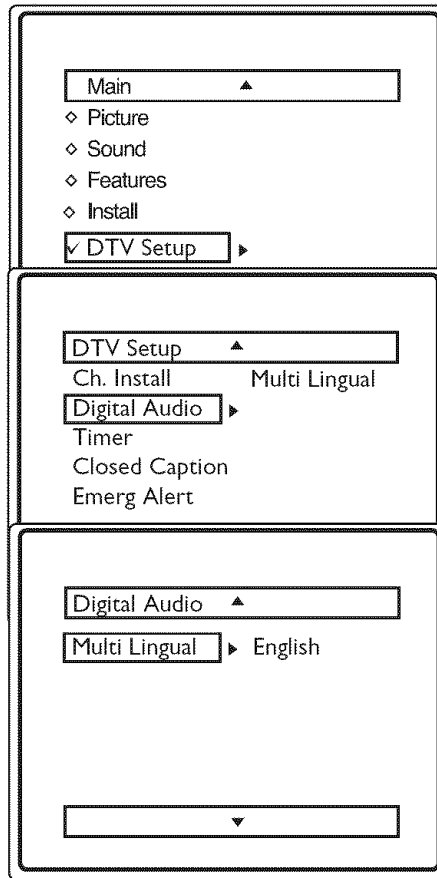

HELPFUL HINTS

This is only for programs that are shown in more than one audio language.

ACTIVE CONTROL OPTIONS

Active control options adjusts the picture quality according to the signal strength coming in. This feature is **ONLY** available in Analog Mode.

- 1 Press **MENU** button on the remote control to display the onscreen menu.
- 2 Press **CURSOR** \wedge or \vee to scroll through the onscreen menu until you see **Features** highlighted.
- 3 Press **CURSOR** $\>$ or $\<$ to display the **Features** menu.
- 4 Press **CURSOR** \wedge or \vee repeatedly until you see **Active Control** highlighted.
- 5 Press **CURSOR** $\>$ or $\<$ to toggle the **Active Control** to **On** and **Off**. When **On** is selected, the TV will automatically adjust the picture quality according to the signal strength received.
- 6 When finished, press **MENU** button on the remote control twice to exit the menu from the TV screen.

Analog Mode

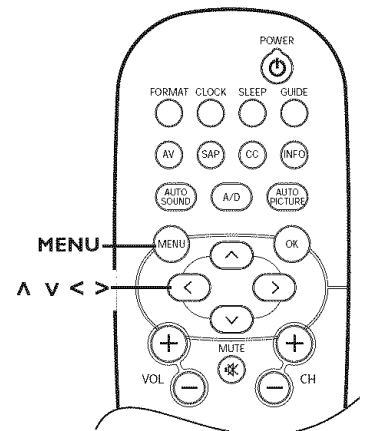
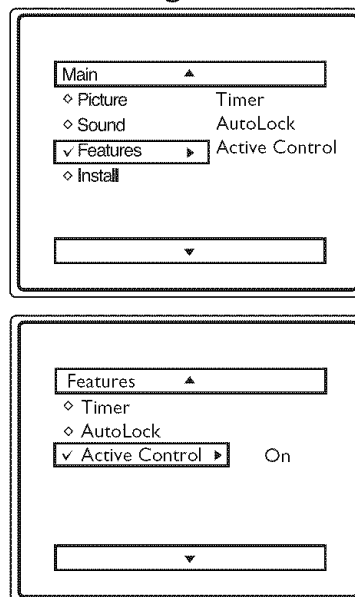

HELPFUL HINTS

Press **A/D** button on the remote control to toggle between **Digital** and **Analog Mode**.

PICTURE MENU CONTROLS

To adjust your TV picture controls, select a channel and use the Picture Menu Controls listed below. Your selection is stored as **Personal**.

- 1 Press **MENU** button on the remote control to display the onscreen menu.
- 2 Press **CURSOR** \wedge or \vee to until the **Picture** menu feature is highlighted.
- 3 Press **CURSOR** $>$ or $<$ to adjust

Brightness Control - until the darkest parts of the picture are as bright as you want.

Color Control - to add or remove color.

Picture Control - until the lightest parts of the picture show good detail.

Sharpness Control - to improve sharpness in the picture.

Tint Control - adjust natural skin tones in the picture quality.

Note : Tint is not available in Digital Mode

Color Temp Control - to select Normal, Cool, or Warm picture preferences. For Normal, whites will maintain their whiteness; Cool will make the whites bluish; and Warm will make the whites reddish.

DNR - When set to On Dynamic Noise Reduction helps to eliminate "noise" from the picture.

Contrast + Control - when set to **On**, the Contrast + control helps to "sharpen" the picture quality. The black portions of the picture become richer in darkness and the whites become brighter.

Digital and Analog Mode

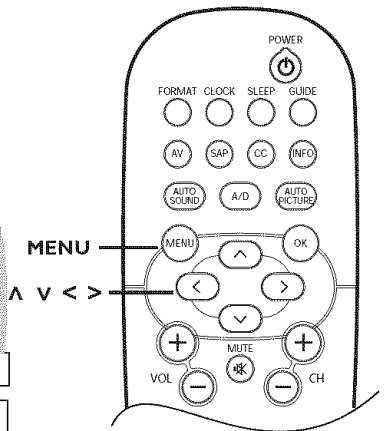
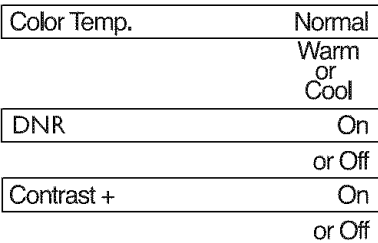
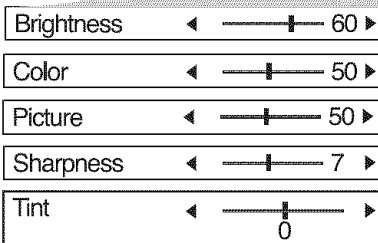
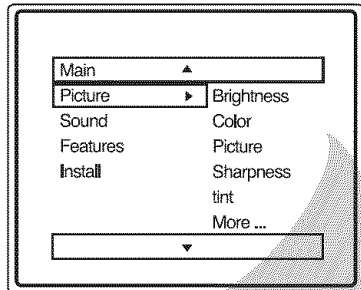

HELPFUL HINTS

Press **A/D** button on the remote control to toggle between **Digital and Analog Mode**.

AUTO PICTURE

Whether you're watching a movie or a sporting event, your TV has automatic video control settings to enhance your current program source or content.

- 1 Press **AUTO PICTURE** button on the remote control. The current Auto Picture setting will display on the screen.
- 2 Press **AUTO PICTURE** repeatedly to select either **Personal**, **Movies**, **Sports**, **Weak Signal** or **Multimedia** picture settings.

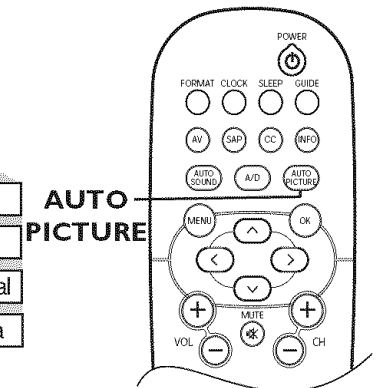
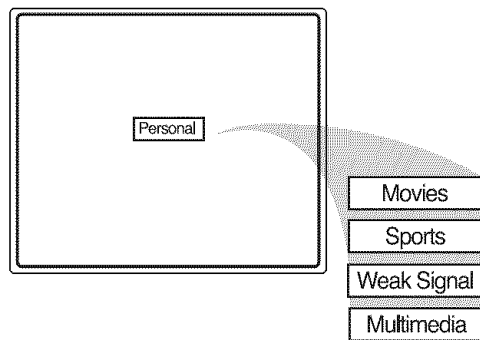

NOTE: The way you choose to set the Picture Menu Controls will become your Personal setting.

SOUND MENU CONTROLS

To adjust your TV sound, use the Sound Menu Controls listed below. Your selection is stored as **Personal**.

- 1 Press **MENU** button on the remote control to display the onscreen menu.
- 2 Press **CURSOR** ∇ to until the **Sound** menu feature is highlighted.
- 3 Press **CURSOR** $>$ or $<$ to adjust

Treble: Enhance the high frequency sounds.

Bass: Enhance the low frequency sounds.

Balance: Level of sound coming from the left and right speakers.

AVL: (Auto Volume Leveler) When turned **On**, AVL will level out the sound being heard when sudden change in volume occurs during commercial breaks or channel changes.

Incr. Surround: Select **Incr. Surround** or **Stereo** settings if you're in **Stereo mode**. Select **Mono** or **Spatial** if you're in Mono mode.

SAP: Secondary Audio Programming is sent as a third audio channel, a SAP signal can be heard apart from the current TV program sound.

Note: If SAP is not present on a selected show, No SAP will be displayed on the TV screen.

Sound: toggles between **Stereo** or **Mono** settings.

Note: If Stereo is not present on a selected show and the TV is in Stereo mode, the sound coming from the TV will remain in the Mono mode.

Digital Mode

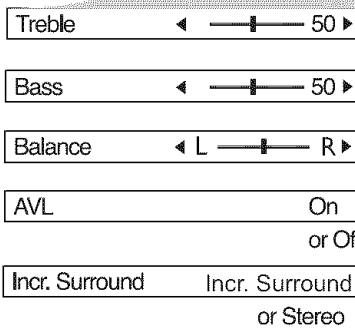
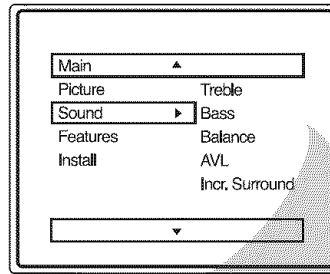

Analog Mode

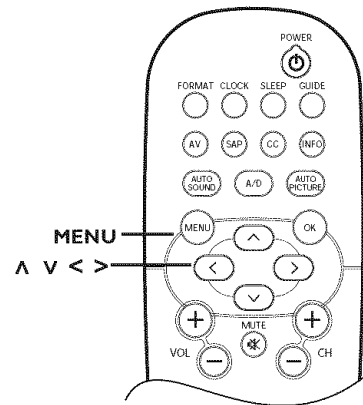
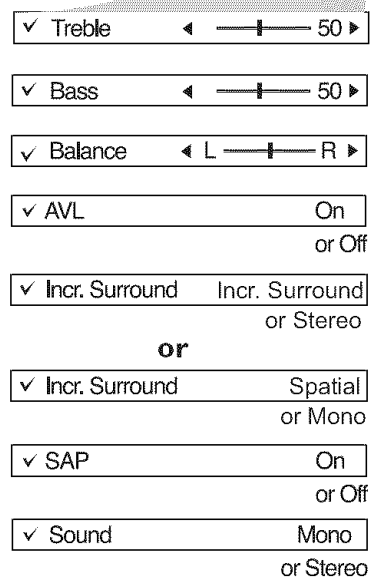
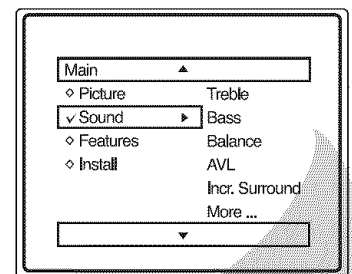

HELPFUL HINTS

Press **AID** button on the remote control to toggle between **Digital and Analog Mode**.

AUTO SOUND

The Auto Sound feature allows the listener to select between four different pre-set sound options.

- 1 Press **AUTO SOUND** button on the remote control. The current **Auto Sound** setting will be displayed in the middle of the TV screen.
- 2 Press **AUTO SOUND** repeatedly to toggle between the four settings. (**Personal**, **Theatre**, **Music**, or **Voice**).

NOTE: The way you choose to set the Sound Menu Controls will become your **Personal** setting.

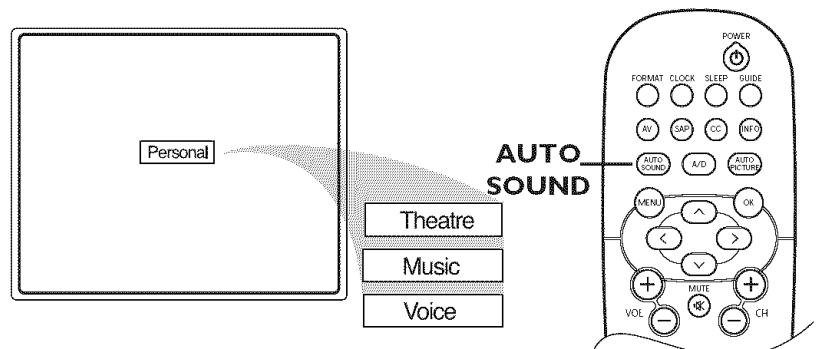

UNDERSTANDING AUTOLOCK CONTROLS

AutoLock is a feature that lets the TV receive and process data sent by broadcasters or other program providers with program content advisory. When programmed by the viewer, a TV with AutoLock can respond to the content advisory and block program content that may be found objectionable (such as offensive language, violence, sexual situations, etc.). This feature is useful for adults to prevent certain types of programs from being viewed by children.

AutoLock offers various **BLOCKING** controls to choose from:

Access Code - An Access Code must be set to prevent children from unblocking questionable or censored programming set by their parents.

Channel Block - After an access code has been programmed, you cannot block individual channels including the A/V inputs.

Clear All - Lets you clear all channels being blocked from your viewing set with the Channel Block Control.

Block All - Lets you block ALL channels except A/V inputs.

No Rating / Unrated - ALL programing with no content advisory data can be blocked if **NO RATING / Unrated** is set to ON.

Movie Ratings - Certain blocking options exist which will block programming based on ratings patterned by the Motion Pictures Association of America (MPAA).

TV Ratings - Like the Movie Ratings, programs can be blocked from viewing using standard TV ratings set by TV broadcasters.

MOVIE RATINGS

G: General Audience - All ages admitted. Suitable for all ages.

PG: Parental Guidance Suggested - Contains material unsuitable for younger children.

PG-13: Parents Strongly Cautioned - Contains material unsuitable for children under the age of 13.

R: Restricted - Suitable for adults above 17 years of age only.

NC-17: No one under the age of 17 will be admitted.

X: Adults Only - Contains one or more of the following: very graphic violence, very graphic and explicit or indecent sexual acts, very coarse and intensely suggestive language.

TV RATINGS

TV-Y : Designed for a very young audience, including children ages 2-6

TV-Y7: Appropriate for children age 7 and above who have acquired the development skills needed to distinguish between make-believe and reality.

acquired the development skills needed to distinguish between make-believe and reality.

TV-G : Suitable for most audiences. Contains little or no violence, no strong language, and little or no sexual dialogue or situations.

TV-PG: Contains material unsuitable for younger children. Could contain Moderate violence (V), some sexual situations (S), infrequent coarse language (L), or some suggestive dialogue (D).

TV-14: Contains some material unsuitable for children under 14 years of age. Contains one or more of the following: intense violence (V), intense sexual situations (S), strong coarse language (L), or intensely suggestive dialogue (D).

TV-MA - Viewed by adults and therefore may be unsuitable for children under 17. Contains one or more of the following: graphic violence (V), explicit sexual situations (S), or crude indecent language (L).

AUTOLOCK

AutoLock allows the viewer to block out any channels. A channel blocked by the AutoLock control cannot be viewed until a correct access code is used to unlock the channel for viewing.

Follow these steps for Digital Mode

- 1 Press **MENU** button on the remote control to display the onscreen menu.
- 2 Press **CURSOR** \wedge or \vee to scroll through the onscreen menu until you see **DTV Setup** highlighted. Press **CURSOR** \gt to display **DTV Setup** features.
- 3 Press **CURSOR** \wedge or \vee to scroll through the **DTV Setup** features until **Ch. Install** is highlighted.
- 4 Press **CURSOR** \gt followed by **CURSOR** \wedge or \vee until you see **AutoLock** highlighted.
- 5 Press **CURSOR** \gt to enter the AutoLock mode.
"Password _ _ _ _" will appear.
- 6 Press **CURSOR** \gt followed by the **NUMERIC** buttons on the remote control to enter the access code. **0711** is the default. The first time you enter the code, **Incorrect** will appear on the screen. Enter the same code again. **Correct** will be displayed. Now can proceed to block channels.

Follow these steps for Analog mode

- 1 Press **MENU** button on the remote control to display the onscreen menu.
- 2 Press **CURSOR** \wedge or \vee to scroll through the onscreen menu until you see **Features** highlighted.
- 3 Press **CURSOR** \gt to display the **Features** menu.
- 4 Press **CURSOR** \wedge or \vee repeatedly until you see **AutoLock** highlighted.
- 5 Press **CURSOR** \gt to enter the AutoLock mode.
"**Access Code** _ _ _ _" will appear.
- 6 Using the **NUMERIC** buttons on the remote control enter the access code. **0711** is the default. The first time you enter the code, **Incorrect** will appear on the screen. Enter the same code again. You will be prompted to enter a new code.
- 7 Use the **NUMERIC** buttons on the remote control enter the access code of your choice. Enter the same code a second time to confirm it. Once the new code is confirmed, the **AutoLock** menu will appear. You can now access the functions available in the menu.

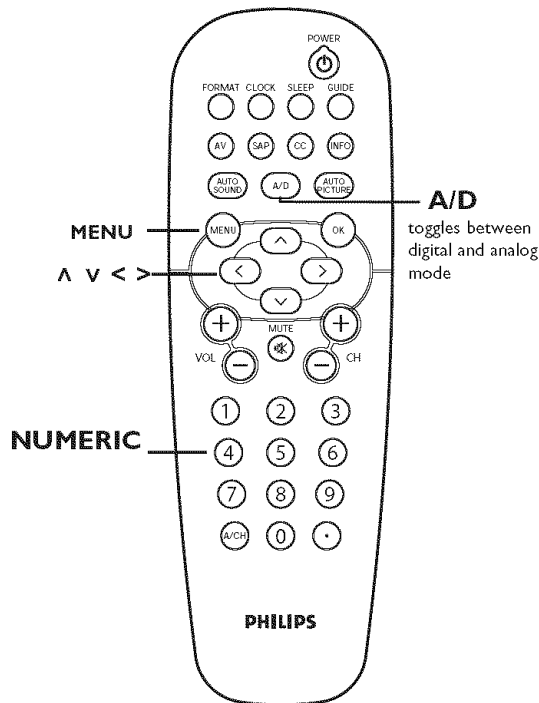
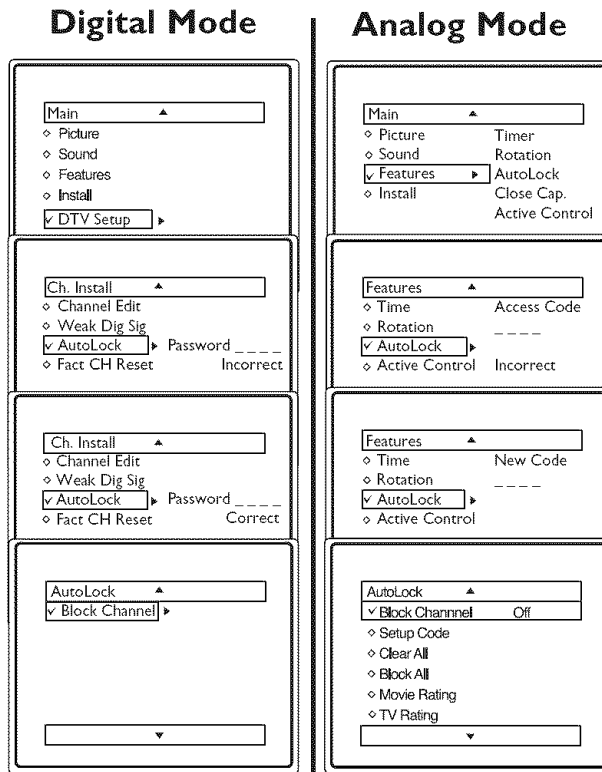

HELPFUL HINTS

When you are in **Digital Mode** you can only **AutoLock** Digital Channels.

When you are in **Analog Mode** you can only **AutoLock** Analog Channels.

Note : Remember this new code which you have set. You can use this code to access AutoLock features in both **Digital** and **Analog** mode. If you forget the new code you have set, key **0711** to access AutoLock features.

AUTOLOCK - BLOCKING CHANNELS

After you have set your personal access code (see previous page), you are now ready to select the channels you want to block.

Follow these steps for Digital Mode

Follow these steps for Analog Mode

1 After Setting your personal access code (see previous page), press **CURSOR** \wedge or \vee until you see **Block Channel** highlighted.

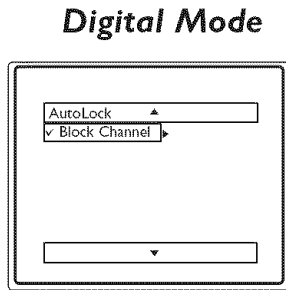

2 Press **CURSOR** $>$ to enter the **Block Channel** menu. Press **CURSOR** $>$ or $<$ to **Block** or **unBlock** the channel.

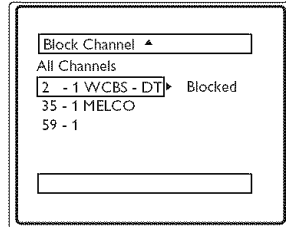

3 Press **CURSOR** \wedge or \vee to highlight the channel you wish to Block or Unblock.

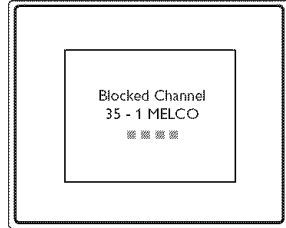

4 Press **CURSOR** $>$ or $<$ to select **Block** or **Unblock**.

5 When finished, press **MENU** button on the remote control three times to exit the menu from the TV screen.

When **Block** is selected, a message will appear to show you the channel that has been Blocked.

Note : When you are in **Digital Mode** you can only **block** Digital Channels.

Analog Mode

1 After Setting your personal access code (see previous page), press **CURSOR** \wedge or \vee until you see **Block Channel** highlighted.

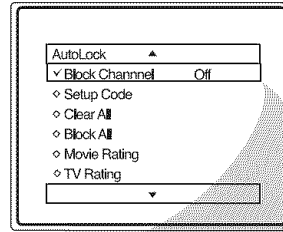

2 Press **CURSOR** \wedge or \vee to select channels you wish to block. Press **CURSOR** $>$ or $<$ to select between **Block** and **Unblock**.

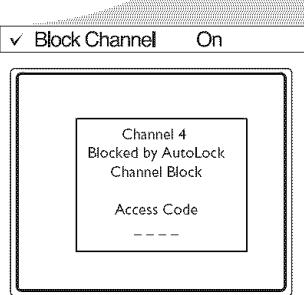

3 Press **CURSOR** $>$ or $<$ to select **Block** or **Unblock**.

4 When finished, press **MENU** on the remote control three times to exit the menu from the TV screen.

When **Block** is selected, a message will appear to show you the channel that has been Blocked.

Note : When you are in **Analog Mode** you can only **block** Analog Channels.

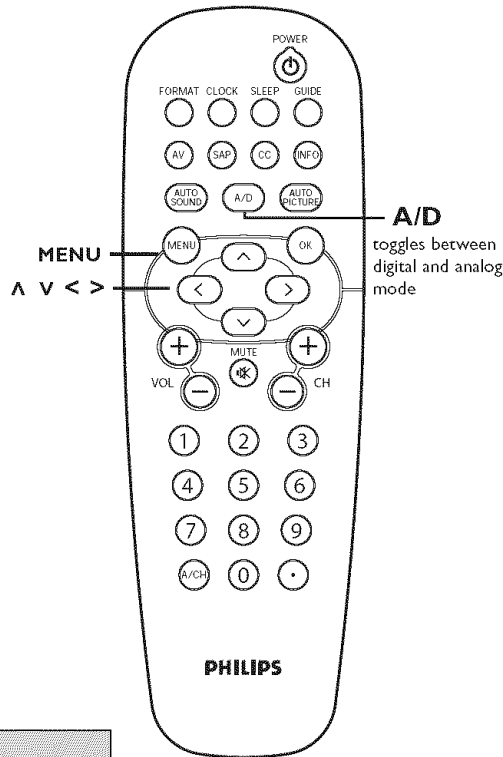

HELPFUL HINTS

If you forget your code, the **0711** is the default and can be used to enter and create a new access code.

BLOCK / CLEAR ALL CHANNELS AT THE SAME TIME

After blocking specific channels there may come a time when you want to block or clear all the channels at the same time. This can be done only after you have entered your access code and the AutoLock features are displayed on the screen (refer to page 21).

Follow these steps for Digital Mode

Digital Mode

Analog Mode

Follow these steps for Analog mode

- 1 Press **CURSOR** ∇ to select Block channel. Press the **CURSOR** $>$ button to enter the Block Channel menu.

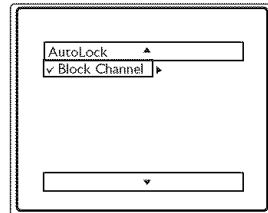

- 2 Press **CURSOR** \wedge or ∇ until **All Channels** is highlighted. Press **CURSOR** $>$ or $<$ to toggle between **Block** and **Unblock**. If **Unblock** is selected, all channels will be viewable. If **Block** is selected, ALL available channels will be blocked from viewing.

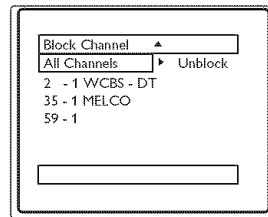

- 3 When finished, press **MENU** four times to exit the menu.

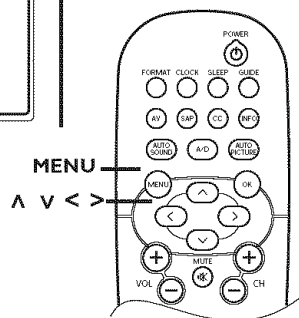

- 1 Press **CURSOR** $>$ to select either **Clear All** or **Block All**.

- 2 If **Clear All** is set to on, all channels will be viewable. If **Block All** is set to on all available channels will be blocked from viewing.

- 3 When finished, press **MENU** on the remote control four times to exit the menu from the TV screen.

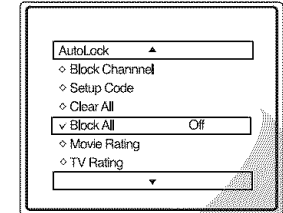

BLOCK OPTIONS

Block Options allows you to block programs by ratings instead of channels. This can be done only after you have entered your access code and AutoLock feature is displayed on the screen.

Note : To access this menu for both Digital and Analog Mode, follow the steps for Analog mode (Page 21).

Follow these steps for both Digital and Analog Mode

Digital Mode

Analog Mode

- 1 Press **CURSOR** \wedge or ∇ until you see **Block Options** highlighted.
- 2 Press **CURSOR** \wedge or ∇ to display the Block Options (Unrated, No Rating or Blocking) menu.
- 3 Press **CURSOR** \wedge or ∇ until you see the desired Option is highlighted. When highlighted, each feature can be turned **On** or **Off** using **CURSOR** $>$ or $<$ on the remote control.
- 4 When finished, press **MENU** four times to exit the menu.

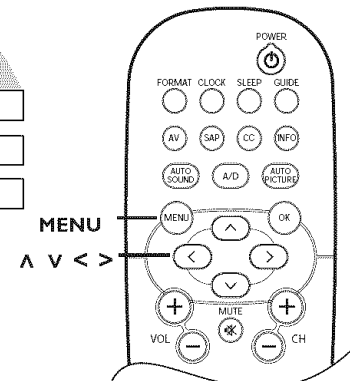
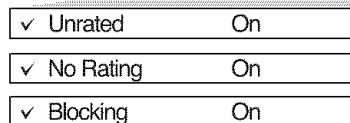
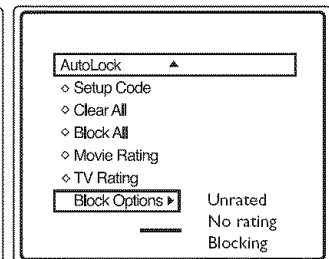
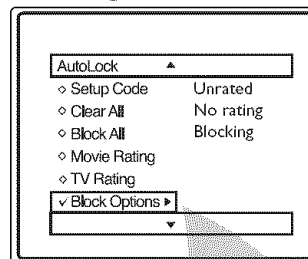

HELPFUL HINTS

Press **AID** button on the remote control to toggle between **Digital and Analog Mode**.

MOVIE RATINGS

The AutoLock feature can block programs based on the Movie Industry ratings. Once you have entered your access code and the AutoLock features are displayed on the screen.

Note : To access this menu for both Digital and Analog Mode, follow the steps for Analog mode (Page 21).

Follow these steps for Digital Mode

- 1 Press **CURSOR** \wedge or \vee until you see **Block by Rating** highlighted.
- 2 Press the **CURSOR** $>$ to display the Movie Rating options (G, PG, PG-13, R, NC17, or X).
- 3 Press **CURSOR** \wedge or \vee to highlight any of the Movie Rating options. When highlighted, all these options can be turned **On** (which will allow blocking) or **Off** (which will allow viewing).
- 4 Press **CURSOR** $>$ on the remote control to turn the rating option **On** or **Off**.

Digital Mode

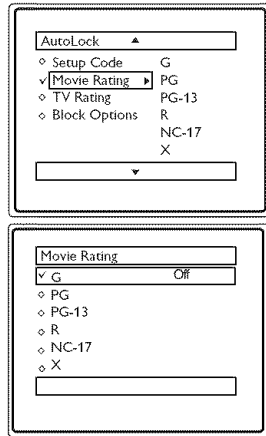

Analog Mode

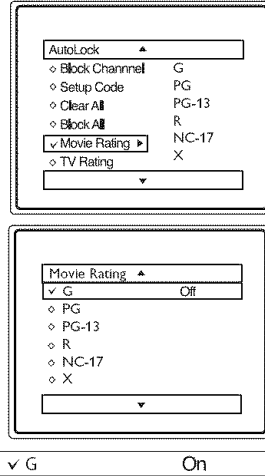

Follow these steps for Analogue mode

- 1 Press **CURSOR** \wedge or \vee until you see **Movie Rating** highlighted.
- 2 Press **CURSOR** $>$ to display the Movie Rating options (G, PG, PG-13, R, NC17, or X).
- 3 Press **CURSOR** \wedge or \vee to highlight any of the **Movie Rating** options. When highlighted, all these options can be turned **On** (which will allow blocking) or **Off** (which will allow viewing).
- 4 Use **CURSOR** $>$ on the remote control to turn the rating option **On** or **Off**.

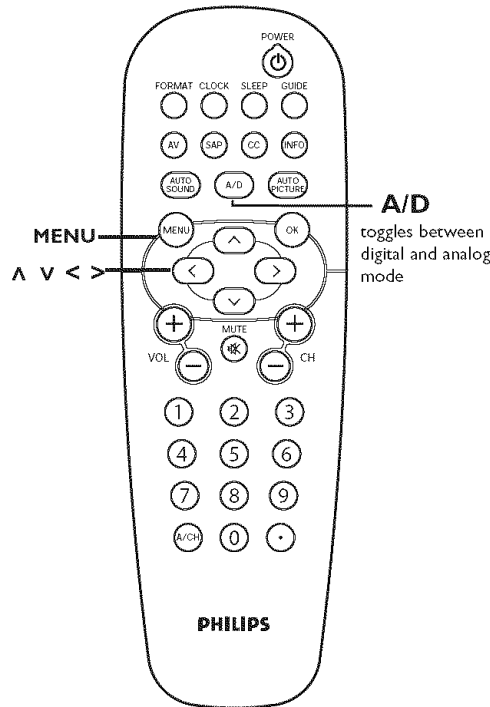

HELPFUL HINTS

Press **A/D** button on the remote control to toggle between **Digital and Analog Mode**.

TV RATINGS

The AutoLock feature can block programs based on the TV Industry ratings. When you have entered your access code and the AutoLock features are displayed on the screen (refer to page 22).

Note : To access this menu for both Digital and Analog Mode, follow the steps for Analog mode (Page 21).

Follow these steps for Digital Mode

- 1 Press **CURSOR** \wedge or \vee until you see **TV Rating** highlighted.
- 2 Press the **CURSOR** \rightarrow to display the TV Rating options (TV-Y, TV-Y7, TV-G, TV-PG, TV-14 or TV-MA).
- 3 Press **CURSOR** \wedge or \vee to highlight any of the TV Rating options. When highlighted, all these options can be turned On (which will allow blocking) or Off (which will allow viewing).
- 4 Press **CURSOR** \rightarrow or \leftarrow to turn the rating option **On** or **Off**.
- 5 If the TV-Y7, TV-PG, TV-14 or TV-MA sub-menu is accessed, press **CURSOR** \wedge or \vee to select one of the options (Block All, V, S, L, D or FV).
- 6 Press **CURSOR** \rightarrow to turn option **On** or **Off**.

Digital Mode

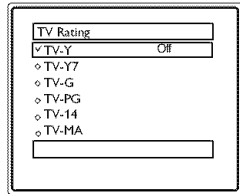
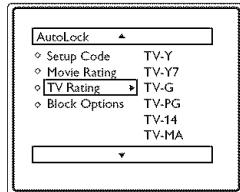

<input checked="" type="checkbox"/> TV-Y	On
<input checked="" type="checkbox"/> TV-Y7	Block All, FV
<input checked="" type="checkbox"/> TV-G	Off
<input checked="" type="checkbox"/> TV-PG	Block All, V, S, L, D
<input checked="" type="checkbox"/> TV-14	Block All, V, S, L, D
<input checked="" type="checkbox"/> TV-MA	Block All, V, S, L

Analog Mode

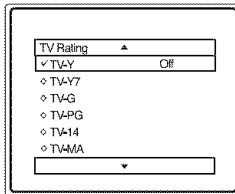
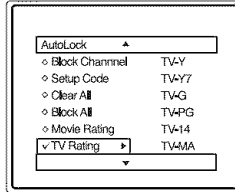

<input checked="" type="checkbox"/> TV-Y	On
<input checked="" type="checkbox"/> TV-Y7	Block All, FV
<input checked="" type="checkbox"/> TV-G	Off
<input checked="" type="checkbox"/> TV-PG	Block All, V, S, L, D
<input checked="" type="checkbox"/> TV-14	Block All, V, S, L, D
<input checked="" type="checkbox"/> TV-MA	Block All, V, S, L

Follow these steps for Analog Mode

- 1 Press **CURSOR** \wedge or \vee until you see TV Rating highlighted.
- 2 Press the **CURSOR** \rightarrow to display the TV Rating options (TV-Y, TV-Y7, TV-G, TV-PG, TV-14 or TV-MA).
- 3 Press **CURSOR** \wedge or \vee until any of the TV Rating options is highlighted. All these highlighted options can be turned On (which will allow blocking) or Off (which will allow viewing).
- 4 Press **CURSOR** \rightarrow to turn the TV-Y or TV-G rating **On** or **Off**. **OR** press the **CURSOR** \rightarrow to enter the sub-menus.
- 5 If the TV-Y7, TV-PG, TV-14 or TV-MA sub-menu is accessed, press **CURSOR** \wedge or \vee to select one of the options (Block All, V, S, L, D or FV).
- 6 Press **CURSOR** \rightarrow to turn option **On** or **Off**.

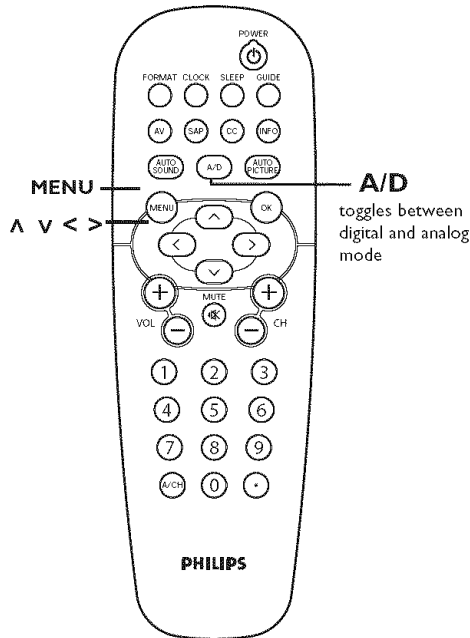

HELPFUL HINTS

Press **A/D** button on the remote control to toggle between **Digital and Analog Mode**.

HOW TO USE THE TIMER MENU CONTROLS

Your television comes with an onscreen clock. The TV can also be set to turn on or off at a specific time and tune to a specific channel when it powers itself on.

- 1 Press the **MENU** button on the remote control to display the onscreen menu.
- 2 Press the **CURSOR** \wedge or \vee button until **Features** is highlighted.
- 3 Press the **CURSOR** $\>$ button to display the Features menu.
- 4 Press the **CURSOR** $\>$ button to display the Timer menu.
- 5 Press the **CURSOR** $\>$ button to access the Timer menu.
- 6 Press the **CURSOR** \wedge or \vee , until one of the Timer controls (Time, Start Time, Stop Time, Channel, Activate, or Displayhighlight) is highlighted.
- 7 Press the **CURSOR** $\>$ to display the menu for the selected item. Make adjustments to the selected items by following the steps below.

Time: Enter the current time using the **NUMERIC** buttons. Use the **CURSOR** $\>$ or $\<$ to toggle the **AM** and **PM** setting.

Start Time: Use the **NUMERIC** buttons to enter the time you want the TV to turn itself On. Use the **CURSOR** $\>$ or $\<$ to toggle the **AM** and **PM** setting.

Stop Time: Use the **NUMERIC** buttons to enter the time you want the TV to turn itself Off. Use the **CURSOR** $\>$ or $\<$ to toggle the **AM** and **PM** setting.

Channel: In **Digital Mode**, use **CH +** or **CH-** to select **DTV** which is the last viewed digital channel. In **Analog Mode**, use the **NUMERIC** buttons or the **CH +** or **CH-** buttons to enter the startup channel.

Activate: Set the timer to turn itself **Off**, **Once** or **Daily**. Press the **CURSOR** $\>$ or $\<$ to select **Once**, **Daily**, or **Off**.

Display: Press the **CURSOR** $\>$ or $\<$ to toggle between **On** or **Off**. If **On** is selected, the time will be displayed all the time when the TV is on. When **Off** is selected, the time will only appear when the **INFO** button is pressed.

NOTE : Display is not available in Digital Mode.

- 8 Press the **MENU** button on the remote control three times to remove the onscreen menu from the TV screen.

Digital Mode

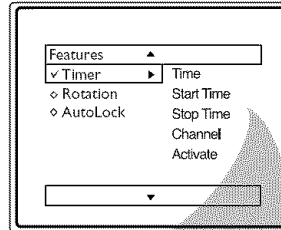
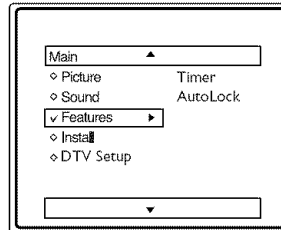

Time	09:00 AM or PM
Start Time	10:00 AM or PM
Stop Time	11:30 AM or PM
Channel	DTV
Activate	Off or Daily or Once

Analog Mode

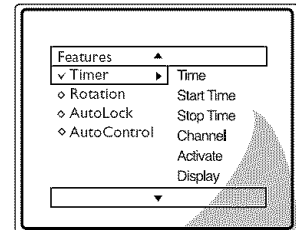
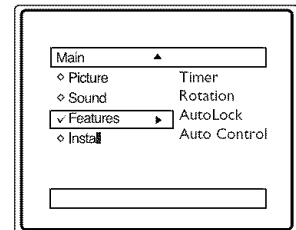

\vee Time	09:00 AM or PM
\vee Start Time	10:00 AM or PM
\vee Stop Time	11:30 AM or PM
\vee Channel	2
\vee Activate	Off or Daily or Once or On
\vee Display	Off or On

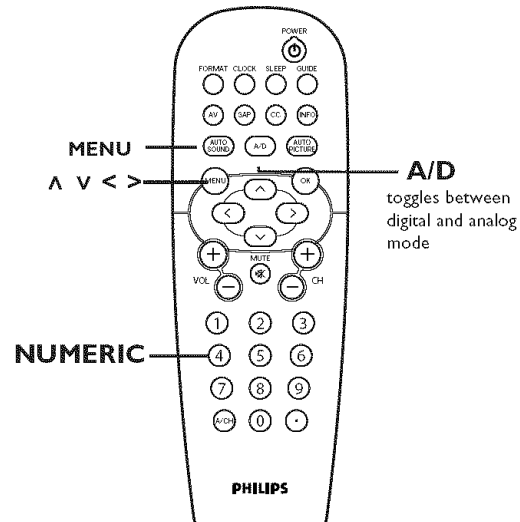

HELPFUL HINTS

In Digital Mode : Before you turn off the TV you have to switch to the **desired digital channel** because the TV will wake up in the last viewed digital channel.

In Analog Mode : You can specify which channel to wake up to.

Press **A/D** button on the remote control to toggle between **Digital and Analog Mode**.

CLOSE CAPTIONING DISPLAY IN DIGITAL MODE

When in digital mode, you can assign display options to your closed captioning options. This feature is **ONLY** available in Digital Mode.

- 1 Press **MENU** button on the remote control to display the onscreen menu.
- 2 Press **CURSOR** \wedge or \vee until you see **DTV Setup** highlighted.
- 3 Press **CURSOR** \rightarrow to display the **DTV Setup** options.
- 4 Press **CURSOR** \wedge or \vee until you see **Close Caption** highlighted. Press **CURSOR** \rightarrow to enter **Display** menu options.
- 5 Press **CURSOR** \rightarrow to toggle to the options that you want – **Off**, **Always on** or **On when muted**.
- 6 When finished, press **MENU** button on the remote control to exit the menu from the TV screen.

Digital Mode

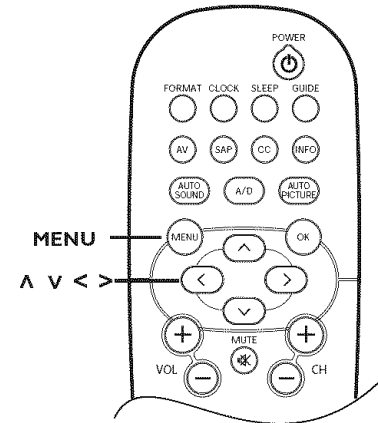
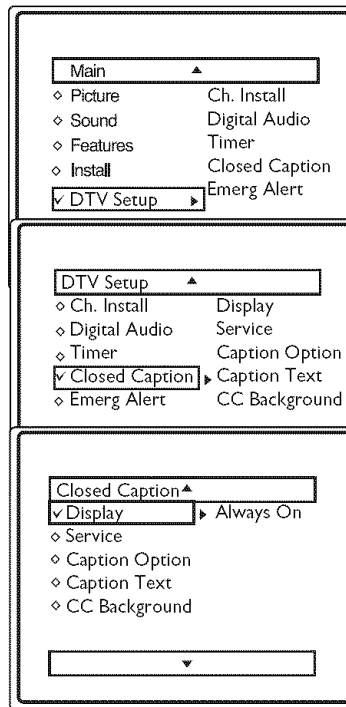

HELPFUL HINTS

An alternative way of activating closed caption is by pressing the **CC** button on the remote control. Close Captions may take 10 - 20 seconds to appear on the TV screen.

CAPTION OPTION IN DIGITAL MODE

Caption Option lets you select the default option or options that you have assigned to your Close captioning service. This feature is **ONLY** available in Digital Mode.

- 1 Press **MENU** button on the remote control to display the onscreen menu.
- 2 Press **CURSOR** \wedge or \vee until you see **DTV Setup** highlighted.
- 3 Press **CURSOR** \rightarrow to display the **DTV Setup** options.
- 4 Press **CURSOR** \wedge or \vee until you see **Close Caption** highlighted. Press **CURSOR** \rightarrow to enter **Caption Option** menu options.
- 5 Press **CURSOR** \rightarrow to toggle to the options that you want – **Use Default** or **Use Options**.
- 6 When **Use Options** is chosen, you will be prompted to select text size, color, opacity, edge color, type and CC background color.
- 7 When finished, press **MENU** button on the remote control to exit the menu from the TV screen.

Digital Mode

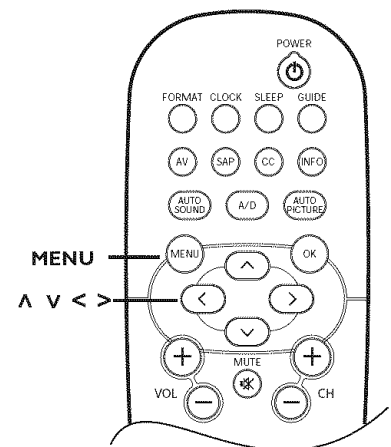
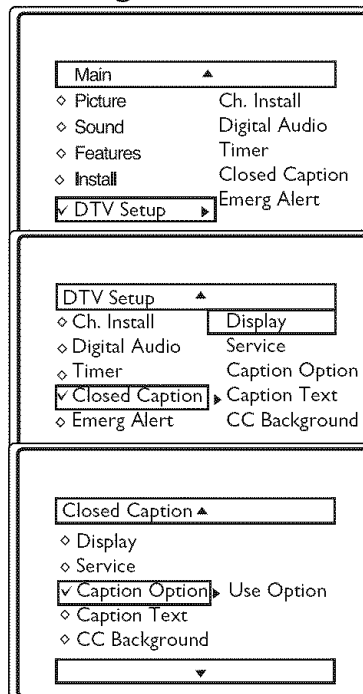

HELPFUL HINTS

Press **A/D** button on the remote control to toggle between **Digital** and **Analog Mode**.

CLOSE CAPTIONING IN ANALOG MODE

Close captioning in analog mode allows you to select the close caption setting while watching analog transmission.

- 1 Press the **MENU** button on the remote control to display the onscreen menu.
- 2 Press the **CURSOR** \wedge or \vee button until **Features** is highlighted.
- 3 Press the **CURSOR** \leftarrow or \rightarrow button to display the Features menu.
- 4 Press the **CURSOR** \rightarrow button to display the **Close Caption** menu.
- 5 Press the **CURSOR** \rightarrow repeatedly to select one of the close caption settings namely **CC Off**, **CC1**, **CC2** and **CC Mute**.
 - CC Off** : Turns Close Captioning Off.
 - CC1 and CC2** : Depending on the broadcaster, this displays the close caption languages available in the program at the time of broadcast.
 - CC Mute** : Displays close caption when the TV is muted.
- 6 Press the **MENU** button on the remote control three times to remove the onscreen menu from the TV screen.

Analog Mode

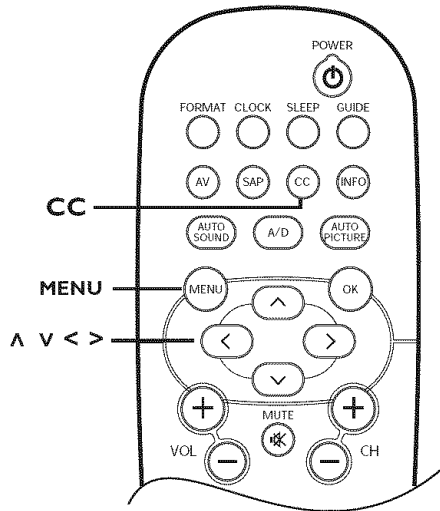
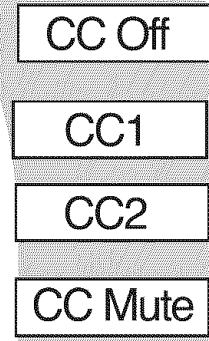
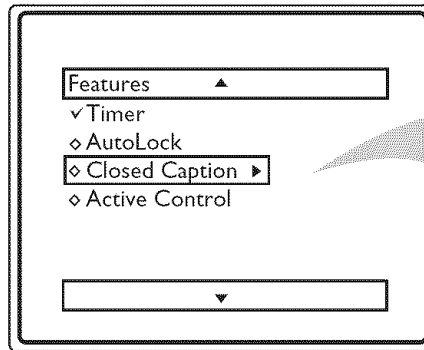
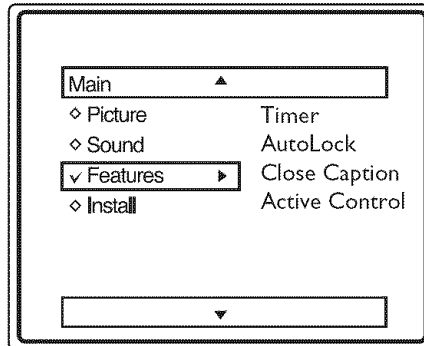

HELPFUL HINTS

An alternative way of activating closed caption is by pressing the **CC** button on the remote control.

Close Captions may take a while to appear on the TV screen.

SLEEPTIMER

The SleepTimer feature allows you to set a timer to automatically turn the TV off after a period of time you choose - 15, 30, 45, 60, 90, 120, 180 or 240 minutes.

- 1 Press **SLEEP** button on the remote control to display the sleeptimer menu.
- 2 Press **SLEEP** button on the remote control to select the amount of time (15, 30, 45, 60, 90, 120, 180 or 240 minutes) before the TV automatically switches Off.

NOTE: An onscreen countdown will appear during the last minute before the TV switches Off. If any button is pressed during the last minute of the countdown, the Sleep Timer setting will be cancelled.

Digital and Analog Mode

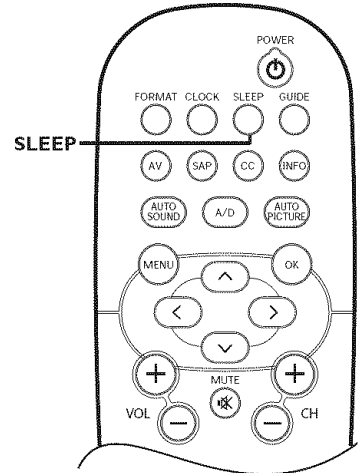
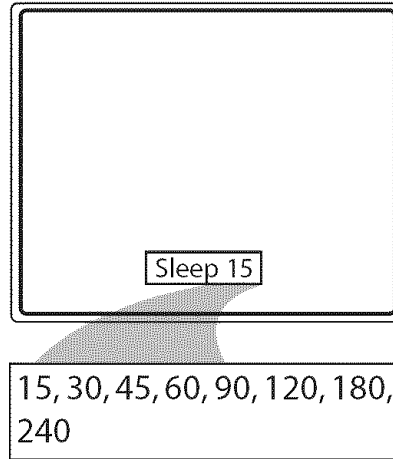

ROTATION

Sometimes the video transmitted to the TV screen might appear slightly tilted. The Rotation control lets you correct the problem by adjusting the screen in a clockwise or counterclockwise direction.

- 1 Press **MENU** button on the remote control to display the onscreen menu.
- 2 Press **CURSOR** \wedge or \vee until you see **Features** highlighted.
- 3 Press **CURSOR** $\>$ to display feature menu.
- 4 Press **CURSOR** \wedge or \vee until you see **Rotation** control highlighted.
- 5 Press **CURSOR** $\>$ or $\<$ to rotate the picture on the screen clockwise or counter clockwise.
- 6 Press **MENU** twice to exit the menu from the TV screen.

32PT9005D Only

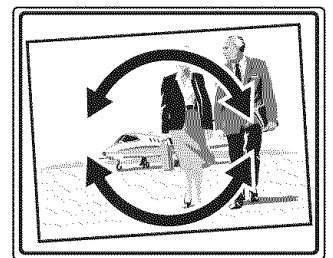
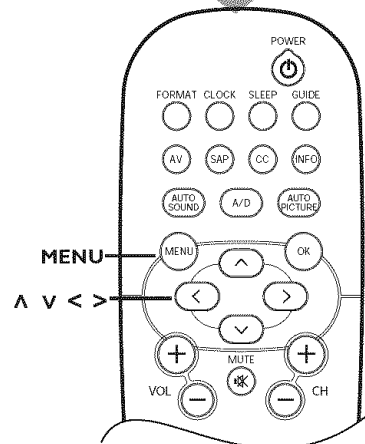
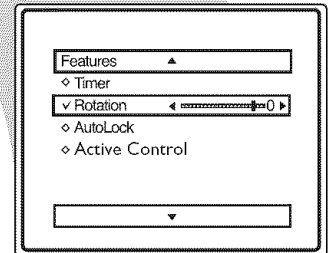
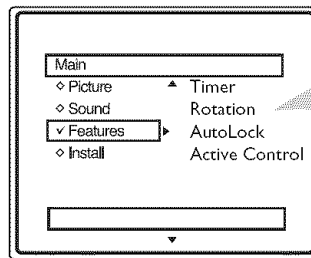

HELPFUL HINTS

Press **A/D** button on the remote control to toggle between **Digital and Analog Mode**.

HOW TO USE THE FORMAT CONTROL

The format Control feature allows you to select the picture-format mode.

Selecting a Picture Format Using the Remote Control

- 1 Press **FORMAT** button on the remote control once to see the current picture-format mode.
- 2 Press **FORMAT** button repeatedly on the remote control to select one of the screen format options namely 4:3, 4:3 Expand, 4:3 Stretch and 16:9 Compress.

Picture-Format Modes

- 4:3** Shows picture in its original (4:3 aspect ratio) format. You will see 2 side borders on the TV screen.
- 4:3 Expand** Expands the picture vertically.
- 4:3 Stretch** Expands the picture horizontally eliminating the side borders on both sides of the TV screen.
- 16:9 Compress** Expands the picture horizontally delivering a home-cinema experience. You will see 2 black borders at the top and bottom of the screen.

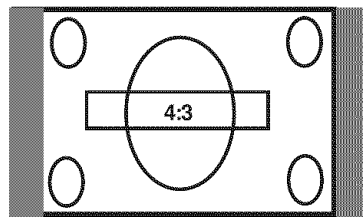

4:3

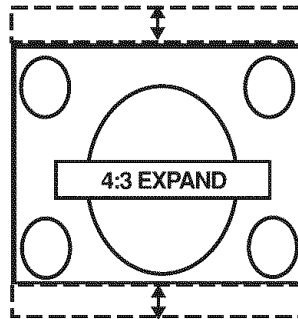

4:3 EXPAND

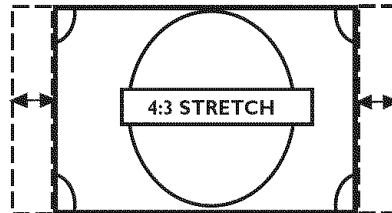

4:3 STRETCH

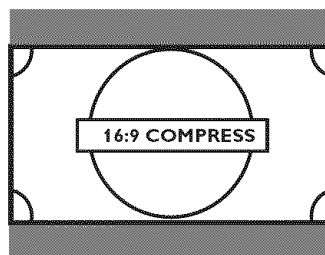

16:9 COMPRESS

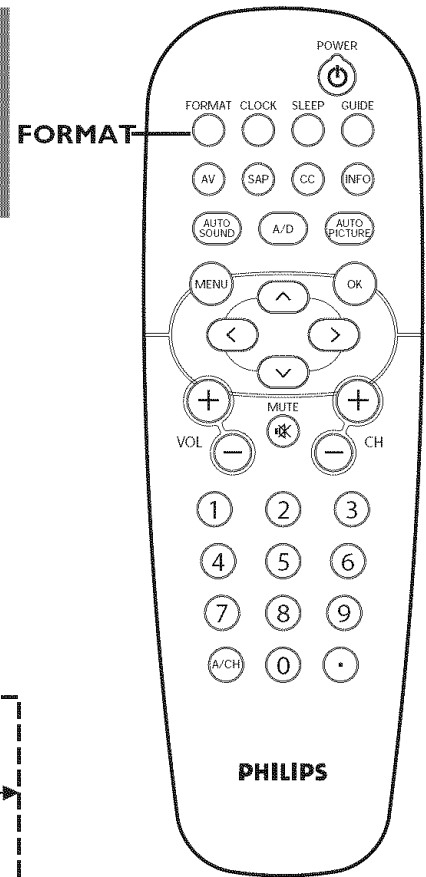

HELPFUL HINTS

Picture-format mode can only be activated when you are watching High-definition (HD) programs.

Press **A/D** button on the remote control to toggle between **Digital and Analog Mode**.

INFORMATION BANNER AND ELECTRONIC PROGRAM GUIDE

The Information Banner displays information of the program that is being transmitted. This feature is **ONLY** available in Digital.

Information Banner

- 1 Press **INFO** button on the remote control once to see the **Information Banner**.

Note : The Information Banner displays the channel number, time and features that are available in the program that is being shown. Feature logos that are lighted up show that the feature is available.

Digital Mode

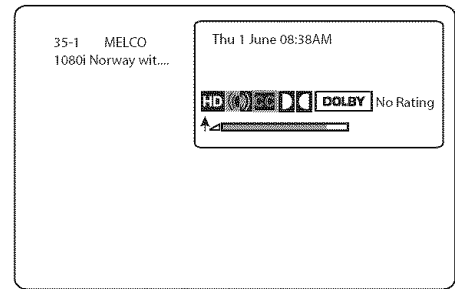

INFORMATION BANNER

Electronic Program Guide

- 2 Press **GUIDE** button on the remote control once to see the **Electronic Program Guide**.

Note : The Electronic Program Guide displays the program schedule that will be broadcast on the channel.

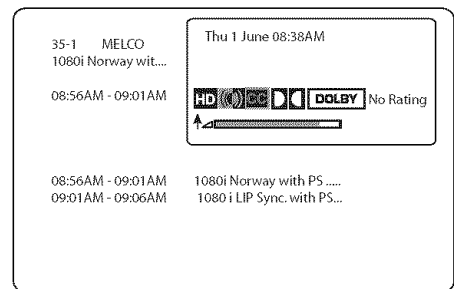

ELECTRONIC PROGRAM GUIDE

When any of these logos on the Information Banner and Electronic Program Guide are lighted up, it means the features are available.

HD High Definition Program.

 Surround Sound.

CC Close Captioning Text.

DOLBY Dolby Digital Sound.

 Signal strength the TV is receiving.

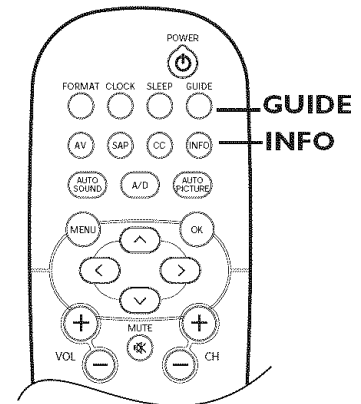

HELPFUL HINTS

The quality and accuracy of the information on the Information Banner and Electronic Program Guide are transmitted from broadcasters. You may see a difference in broadcast time if the broadcaster is from a different time zone area.

If "**No Information**" appears on the screen when the **INFO** or **GUIDE** button on the remote control is pressed, it means the broadcaster is not providing any information.

*The **INFO** button can also be used to exit the menu display from the TV screen.*

GLOSSARY

Aspect Ratio	The ratio between the width and height of the TV picture on the screen. In a normal TV set the aspect ratio is 4 to 3 (4:3). The new aspect ratio in HDTV is 16:9 which resembles the aspect ratio in a movie theatre (Widescreen). New TV systems support both 4:3 and 16:9 aspect ratio and can automatically switch between them.
Audio Video (A/V)	A term often used when discussing a channel on a TV receiver or on video equipment, which has been especially designed to accept VCR audio-video signals. This channel automatically activates special circuitry within the TV set to prevent picture distortion and skewing. It is also used for audio-video processors, which handle both types of signals.
ATSC	ATSC: Advanced Television Systems Committee. Formed to establish technical standards for advanced television systems, including digital high definition television (HDTV).
CVBS	Composite Video Baseband Signal. In broadcast television this refers to the video signal, including the colour information and syncs
DTV	Digital television. Generic term that refers to all digital television formats, including high-definition television (HDTV) and standard-definition television (SDTV).
DOLBY Digital	Dolby Digital - Six-channel digital audio standard that is part of the U.S. digital television standard; also called AC-3 or Digital 5.1. The channels consist of front left, front right, front center, surround or rear left, surround or rear right, and a separate subwoofer
Digital Tuner	A digital tuner serves as the decoder required to receive and display digital broadcasts. It can be included inside TV sets or via a set-top box.
HDTV	The generally agreed upon definition of HDTV is approximately twice the vertical and horizontal picture resolution of today's NTSC TV, which essentially makes the picture twice as sharp. HDTV also has a screen ratio of 16:9 as compared with most of today's TV screens, which have a screen ratio of 4:3. HDTV offers reduced motion artifacts (i.e. ghosting, dot crawl), and offers 5.1 independent channels of CD-quality stereo surround sound, (also referred to as AC-3).
NTSC	National television system committee. The organization that developed the analog television standard currently in use in the U.S., Canada, and Japan. Now generally used to refer to that standard. The NTSC standard combines blue, red, and green signals modulated as an AM signal with an FM signal for audio.
Progressive Scan	In Progressive Scanning all the horizontal scan lines are scanned on to the screen at one time. The Digital TV and HDTV Standards accept both Interlaced Scan and Progressive Scan broadcast and display methods.
Resolution	Resolution: A measurement of the finest (smallest) detail that is visible in a video image. TV Resolutions may be expressed as number of pixels in an image; or more commonly, "As Total Number of (horizontally scanned) Lines used to create the image. Standard Digital TV Resolutions: SDTV: 480i - The picture is 704x480 pixels, 480p - The picture is 704x480 pixels. HDTV: 720p - The picture is 1280x720 pixels, 1080i - The picture is 1920x1080 pixels, 1080p - The picture is 1920x1080 pixels.

TROUBLESHOOTING TIPS

Check this List of **Symptoms** and **Suggested Steps To Take** before requesting Service. You may be able to solve the problem yourself. If you face problems connecting the TV to external devices, please refer to the User Guide of the external device or call their service centers for help. Charges for TV installation and adjustments of customer controls are not covered under your warranty.

SYMPTOMS		SUGGESTED STEPS TO TAKE
Hookup	Can't get external audio equipment to work with TV.	<ol style="list-style-type: none"> 1. SPDIF output audio only in digital mode and the audio equipment used must have the decoder. 2. Ensure that Monitor Out Audio LR output audio is connected to Audio In of device (refer to Connection Guide Panel 3).
Installation	Can't get the AV channels on the TV screen.	Press the AV button on the remote control repeatedly to select the desired AV channels. Note: SVHS can only be selected if a S-VHS device is connected and powered on.
Installation	TV displays wrong channel or no channels above 13	Go to TUNER MODE in the television menu and select the correct signal source, then perform the automatic installation again. (Refer to page 11).
Installation	Channel numbers do not follow the channel number of the programs.	Go to TUNER MODE in the television menu and select the correct signal source, then perform the automatic installation again. (Refer to page 11).
Installation	Channel numbers look different. Eg. 23-1, 45-3 etc.	You are in Digital Mode. Press A/D button on the remote control to toggle between Digital and Analog mode.
Installation	Auto installation is taking too long.	Auto installation may take 20 to 40 minutes depending on the number of channels that are available.
Installation	Cannot add or skip channels from favorite list. Error message " Favorite Channel list is empty. You must Auto Install. "	<ol style="list-style-type: none"> 1. You may not have completed auto installation. Do an auto installation again (refer to page 9). 2. You may have chosen the wrong TUNER MODE. Go to TUNER MODE in the TV menu and select the correct signal source, then perform the auto installation again (refer to page 11).
AutoLock	Unable to change Autolock password.	You can change the Autolock password via the feature menu (refer to page 21)
Close Caption	Close Captioning text does not appear.	Close Captioning text takes a while to appear. If Close Captioning text still does not appear, press the CC button on the remote control again to switch to another Close Captioning channel (refer to page 27 and 28).
Digital Audio	Unable to switch to another audio language	You can only select different audio languages when the program is broadcasted in different audio language (refer to page 17).
Format Control	Unable to change picture-format.	Picture-format mode can only be activated when you are watching high-definition (HD) program. Press the INFO button on the remote control. If the Information Banner does not show HD lighted, you are not watching a HD program and therefore format control cannot be activated (refer to page 30)
Information Banner	" No Information " appears on the TV screen.	Information is broadcaster dependent. If the broadcaster does not provide any information. " No Information " will be displayed when the INFO or GUIDE button on the remote control is pressed (refer to page 31)

TROUBLESHOOTING TIPS

SYMPTOMS		SUGGESTED STEPS TO TAKE
Settings	<p>Error messages appear on the screen of TV:</p> <p>No Signal</p> <p>No Program</p> <p>Audio Only</p>	<p>Check that the antenna / cable is connected properly and that you have selected the correct tuner mode (refer to page 11).</p> <p>There could be temporarily no transmission on the selected channel. You may like to add these channels to the Weak Dig Sig. list. (refer to page 15). When transmission is resumed or when available, your TV will receive it.</p> <p>The current channel has only audio transmission.</p>
Sound	Sound is not in Stereo.	<p>This could be due to any of the following reasons:</p> <ol style="list-style-type: none"> 1. Not all transmitted broadcasts by the cable or broadcast stations are in STEREO. Try checking with several major network stations to be sure that the station you selected is in STEREO. 2. When SAP is turned ON, the sound mode is automatically set to MONO. 3. Sound mode is set to MONO. Set the sound mode to STEREO. (Refer to page 19). 4. When using an AV input, the television will not display STEREO even though it is producing stereo sound.
Sound	Disturbing sound (such as buzzing, clicking, cracking, humming, whistling etc.)	<p>It is normal to hear a disturbing sound (such as buzzing, clicking, cracking, humming, whistling, etc) from a distance less than 2 meters (6 feet) with the television sound muted.</p> <p>If problem occurs on one channel, you may have a signal problem. Please contact the cable provider or local broadcaster regarding the specific channel.</p>
General	No power to the TV	<p>Check the TV power cord. Unplug the power cord from the TV, wait 10 seconds, then reinsert the plug into your wall outlet. Power On the TV again.</p> <p>Plug the power cord directly to the wall socket and not via an extension cord.</p> <p>If you need to use an extension cord, check that the fuse on the AC power strip is not blown.</p>
General	TV is not responding to Remote Control	<p>Ensure the batteries are inserted into the remote control according to the illustration in the battery compartment. Refer to page 7.</p> <p>Reset the TV by disconnecting the power plug from the wall outlet for 10 seconds and then reconnecting it again.</p>
General	No Picture on the TV screen	<p>Check antenna connections. Are they properly secured to the TV ANT 75 ohm plug?</p> <p>Check the TUNER MODE control for the correct tuner setting.</p> <p>Try running the Auto Install feature to find all available channels (refer to page 9).</p> <p>Press the AV button on the remote control to make sure the correct signal source is selected (FRONT, AV1, AV2, Current Channel, etc.).</p> <p>Note: SVHS can only be selected if a S-VHS device is connected and powered on.</p>
General	TV Displays white lines in letterbox when viewing a DVD disc	<p>Some DVD Discs are encoded with as much as 30% more video information to give the best possible picture quality. With the DVD Player in the 16:9 picture format, the playback of this type of disc with extra video information can produce a number of small white lines in the upper portion of the black letterbox area. With some of these discs, this problem is inherent and does not require a service call.</p>

CLEANING AND CARE

WARNING Concerning Stationary Images on the TV Screen:

Do not leave stationary or letterbox images on screen for extended periods of time. This can cause uneven picture-tube aging.

Normal use of the TV should involve the showing of pictures that contain constantly moving and changing images that fill the screen. Be careful not to leave nonmoving images on screen for extended periods of time, or to display the same images on screen too frequently, because subtle ghost images can be left on the picture tubes. Sources of stationary images may be DVD disks, laser disks, video games, CD-i disks, videotapes, digital television boxes, broadcast channels, cable channels, satellite channels, and others. Here are some examples of stationary images (this is not an all-inclusive list; you may encounter others in your viewing):

- DVD menus—listings of DVD disk content
- Letterbox black bars—shown at the top and bottom of the TV screen when a wide screen (16:9) movie is viewed on a TV with standard (4:3) aspect ratio.
- Video-game images and scoreboards
- Television station logos—present a problem if they are bright and stationary; moving or low-contrast graphics are less likely to cause uneven aging of the picture tube
- Stock-market tickers—presented at the bottom of the TV screen
- Shopping channel logos and pricing displays—bright and shown constantly or repeatedly in the same location on the TV screen.

Placement of the TV

- To avoid cabinet warping, cabinet color changes, and increased chance of set failure, do not place the TV where temperatures can become excessively hot; for example, in direct sunlight or near a heating appliance.
- Be sure to allow a free flow of air to and from the perforated back cover of the set.

Cleaning

- To avoid possible shock hazard, be sure the TV is unplugged from the electrical outlet before cleaning.
- Regularly dust the TV with a dry, nonscratching duster to keep the TV clean.
- When cleaning the TV, take care not to scratch or damage the screen surface. Avoid wearing jewelry or using anything abrasive. Do not use household cleaners. Wipe the front screen with a clean cloth dampened with water. Use even, easy, vertical strokes when cleaning.
- Gently wipe the cabinet surfaces with a clean cloth or sponge dampened in a solution of cool, clear water and a mild soap or detergent. Use a clean, dry cloth to dry the wiped surfaces.
- Occasionally vacuum the ventilation holes or slots in the back cover of the set.
- Never use thinners, insecticide sprays, or other chemicals on or near the cabinet, as they might cause permanent damage of the cabinet finish.

SPECIFICATIONS

	27PT9015D	32PT9005D	32PT7005D	
PICTURE / DISPLAY				
Aspect ratio :	4:3	4:3	4:3	
Picture Display Picture Enhancement	27" Real Flat Picture, Scavem, Auto Picture (5 modes) Color, Contrast, Sharpness Control	32" Real Flat Picture, 2D Comb filter, Scavem, Auto Picture (5 modes) Color, Contrast, Sharpness Control	32" Black Matrix Picture tube, Auto Picture (5 modes) Color, Contrast, Sharpness Control	
SOUND				
Sound Power (Output RMS) Sound Enhancement	2 x 5w Incredible Surround			
CONVENIENCE	Auto Program Easy toggle Digital / Analog modes Closed Captioning Full text Sleeptimer Clock			
ON SCREEN DISPLAY LANGUAGES	English, French, Spanish			
CONNECTIVITY				
Rear	Component Video Input (Y Pb Pr) S-Video (SVHS) Composite Video input (CVBS) Antenna / Cable RF In SPDIF Out (Digital Only) Audio Out (Cinch)			
Side	Composite Video Input (CVBS) Headphone Jack			
ELECTRICAL INFORMATION	USA	MEXICO	USA	USA
Voltage (V)	120V~	127V~	120V~	120V~
Frequency (Hz)	60Hz	60Hz	60Hz	60Hz
Approx. consumption (W)	120W	134W	127W	125W
Max. consumption (W)	132W	147W	139W	137W
WEIGHT & DIMENSIONS :				
Weight (incl. Packaging) :	49 kg / 108 lbs		76 kg / 167 lbs	60 kg / 132 lbs
Weight (excl. Packaging) :	44 kg / 97 lbs		71 kg / 156 lbs	55 kg / 121 lbs
Visible diagonal / screen size :	27 inch / 68.6 cm		32 inch / 81.3 cm	32 inch / 81.3 cm

Specifications and information are subject to change without notice.

PHILIPS LIMITED WARRANTY

90 Days Labor & One (1) Year Parts & Two (2) Years Display

PHILIPS CONSUMER ELECTRONICS warrants this product against defect in material or workmanship, subject to any conditions set forth as follows:

PROOF OF PURCHASE: You must have proof of the date of purchase to receive warranted repair on the product. A sales receipt or other document showing the product and the date that you purchased the product as well as the authorized retailer included, is considered such proof.

COVERAGE:

(If the product is determined to be defective)

LABOR: For a period of ninety (90) days from the date of purchase, Philips will repair or replace the product, at its option, at no charge, or pay the labor charges to any Philips authorized repair facility. After the period of ninety (90) days, Philips will no longer be responsible for charges incurred.

PARTS: For a period of one (1) year from the date of purchase, Philips will supply at no charge, new or rebuilt replacement parts in exchange for defective parts. Philips authorized service centers will provide removal and installation of the part under the specified labor warranty.

DISPLAY: For a period of two (2) years from the date of purchase, Philips will supply, at no charge, a new or rebuilt active display device in exchange for the defective display. Philips authorized service centers will provide removal and installation of the parts under the specified labor warranty.

EXCLUDED FROM WARRANTY COVERAGE

Your warranty does not cover:

- Labor charges for installation or setup of the product, adjustment of customer controls on the product, and installation or repair of antenna systems outside of the product.
- Product repair and/or part replacement because of improper installation, connections to improper voltage supply, abuse, neglect, misuse, accident, unauthorized repair or other cause not within the control of Philips.
- A product that requires modification or adaptation to enable it to operate in any country other than the country for which it was designed, manufactured, approved and/or authorized, or repair of products damaged by these modifications.
- Damage occurring to product during shipping when improperly packaged or cost associated with packaging.
- Product lost in shipment and no signature verification of receipt can be provided.
- A product used for commercial or institutional purposes (including but not limited to rental purposes).
- Products sold AS IS or RENEWED.

TO OBTAIN WARRANTY SERVICE IN THE U.S.A., PUERTO RICO, OR U.S. VIRGIN ISLANDS...

Contact Philips Customer Care Center at:
1-888-PHILIPS (1-888-744-5477)

TO OBTAIN WARRANTY SERVICE IN CANADA...

1-800-661-6162 (French Speaking)
1-888-PHILIPS (1-888-744-5477) - (English or Spanish Speaking)

REPAIR OR REPLACEMENT AS PROVIDED UNDER THIS WARRANTY IS THE EXCLUSIVE REMEDY FOR THE CONSUMER. PHILIPS SHALL NOT BE LIABLE FOR ANY INCIDENTAL OR CONSEQUENTIAL DAMAGES FOR BREACH OF ANY EXPRESS OR IMPLIED WARRANTY ON THIS PRODUCT. EXCEPT TO THE EXTENT PROHIBITED BY APPLICABLE LAW, ANY IMPLIED WARRANTY OF MERCHANTABILITY OR FITNESS FOR A PARTICULAR PURPOSE ON THIS PRODUCT IS LIMITED IN DURATION TO THE DURATION OF THIS WARRANTY.

Some states do not allow the exclusions or limitation of incidental or consequential damages, or allow limitations on how long an implied warranty lasts, so the above limitations or exclusions may not apply to you. In addition, if you enter into a service contract agreement with the PHILIPS partnership within ninety (90) days of the date of sale, the limitation on how long an implied warranty lasts does not apply.

This warranty gives you specific legal rights. You may have other rights which vary from state/province to state/province.

INDEX

Accessories List	5	Index	38
Active Control	17	Information Banner	31
AutoLock Controls		Language Control	10
Access Code	21	Picture Control	18
Block/Clear All Channels	23	Quick Tips	5
Movie Ratings	24	Registration of TV Information	2
TV Ratings	25	Rotation	29
Blocking Options	23	Safety / Precautions	2-3
Automatic Program	9	Second Audio Programming (SAP)	19
Auto Picture	18	Sharpness Control	18
Auto Sound	19	Sleeptimer	29
AVL (Automatic Volume Leveler) Control	19	Specifications	36
Balance Control	19	Stereo/Mono Control	19
Bass Control	19	Timer Controls	
Brightness Control	18	Activate Control	26
Cleaning and Care	35	Clock, Time Control	26
Channel Edit (Add or Skip channels)	12	Display Control	26
Closed Captioning in Digital Mode	27	Channel Control	26
Closed Captioning in Analog Mode	28	Start Time Control	26
Color Control	18	Stop Time Control	26
Color Temperature (Color Temp) Control	18	Tint Control	18
Electronic Program Guide (EPG)	31	Treble Control	19
Feature Highlights	4	Troubleshooting	33-34
Format Controls	30	Tuner Mode Controls	11
Glossary	32	Warranty (Limited)	37
Guide To Digital TV	5	Weak Digital Signal (Add or Skip)	15

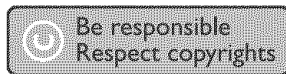
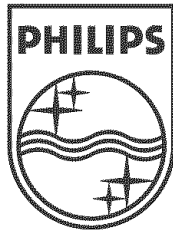

Specifications are subject to change without notice.
Trademarks are the property of Koninklijke Philips Electronics N.V. or their respective owners.
2005 © Koninklijke Philips Electronics N.V. All rights reserved.

www.philips.com

3139 125 35342