

Home Theater System with 5 Disc DVD Changer and HDMI

HT-Q80

HT-TQ85

SAMSUNG ELECTRONICS AMERICA, INC.

SERVICE DIVISION

400 Valley Road, Suite 201
Mount Arlington, NJ 07856
1-800-SAMSUNG (1-800-726-7864)
www.samsung.com



Instruction Manual

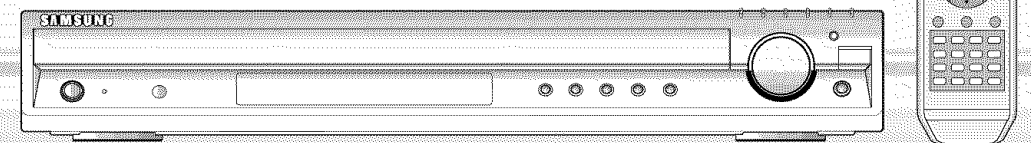

AH68-01834A

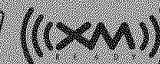

Safety Warnings

**CLASS 1 LASER PRODUCT
 KLASSE 1 LASER PRODUKT
 LUOKAN 1 LASER LAITE
 KLAS 1 LASER APPARAT
 PRODUCTO LASER CLASE 1**

Note to CATV system installer :
 This reminder is provided to call the CATV system installer's attention to Section 820~40 of the NEC which provides guidelines for proper grounding and, in particular, specifies that the cable ground shall be connected to the grounding system of the building, as close to the point of cable entry as practical



CAUTION:
 TO REDUCE THE RISK OF ELECTRIC SHOCK, DO NOT REMOVE REAR COVER. NO USER SERVICEABLE PARTS INSIDE. REFER SERVICING TO QUALIFIED SERVICE PERSONNEL.

CLASS 1 LASER PRODUCT

This Compact Disc player is classified as a CLASS 1 LASER product.

Use of controls, adjustments or performance of procedures other than those specified herein may result in hazardous radiation exposure.

CAUTION-INVISIBLE LASER RADIATION WHEN OPEN AND INTERLOCKS DEFEATED, AVOID EXPOSURE TO BEAM.

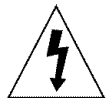

This symbol indicates that dangerous voltage which can cause electric shock is present inside this unit.



This symbol alerts you to important operating and maintenance instructions accompanying the unit.

WARNING: To reduce the risk of fire or electric shock, do not expose this appliance to rain or moisture.

CAUTION: TO PREVENT ELECTRIC SHOCK, MATCH WIDE BLADE OF PLUG TO WIDE SLOT, FULLY INSERT.

Precautions

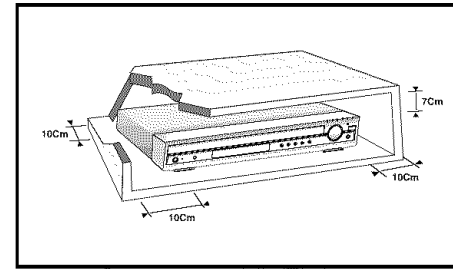

Ensure that the AC power supply in your house complies with the identification sticker located on the back of your player. Install your player horizontally, on a suitable base (furniture), with enough space around it for ventilation (3~4inches). Make sure the ventilation slots are not covered. Do not stack anything on top of the player. Do not place the player on modules or other equipment which may become hot. Before moving the player, ensure the disc tray is empty. This player is designed for continuous use. Switching off the Home Theater to the stand-by mode does not disconnect the electrical supply. In order to disconnect the player completely from the power supply, remove the main plug from the wall outlet, especially when left unused for a long period of time.

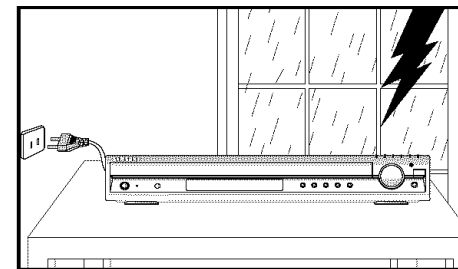
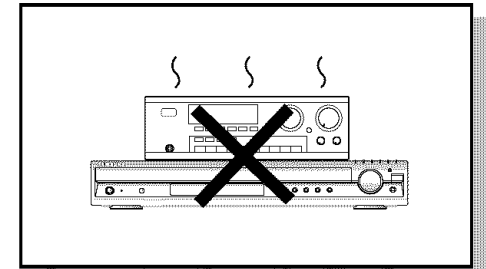

During thunderstorms, disconnect AC main plug from the wall outlet. Voltage peaks due to lightning could damage the unit.

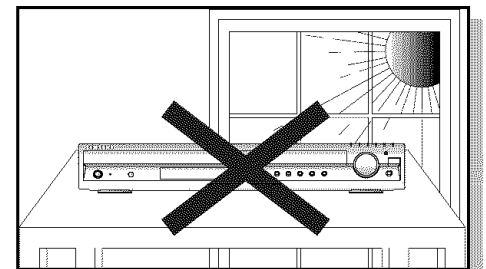

Do not expose the unit to direct sunlight or other heat sources. This could lead to overheating and malfunction of the unit.

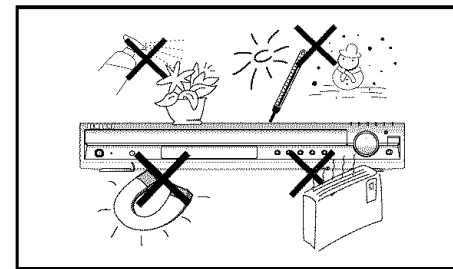

Protect the player from moisture (i.e. vases), and excess heat (e.g. fireplace) or equipment creating strong magnetic or electric fields (i.e. speakers...). Disconnect the power cable from the AC supply if the player malfunctions. Your player is not intended for industrial use. Use of this product is for personal use only. Condensation may occur if your player or disc has been stored in cold temperatures. If transporting the player during the winter, wait approximately 2 hours until the unit has reached room temperature before using.

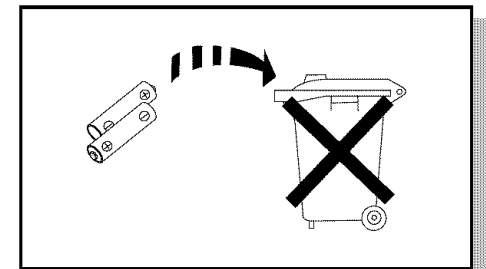

The batteries used with this product contain chemicals that are harmful to the environment. Do not dispose of batteries in the general household trash.

Safety Instructions

READ INSTRUCTIONS

All the safety and operating instructions should be read before the appliance is operated.

RETAIN INSTRUCTIONS

The safety and operating instructions should be retained for future reference.

HEED WARNINGS

All warnings on the appliance and in the operating instructions should be adhered to.

FOLLOW INSTRUCTIONS

All operating and use instructions should be followed.

WATER AND MOISTURE

Do not use this video product near water—for example, near a bathtub, wash bowl, kitchen sink, or laundry tub, in a wet basement, or near a swimming pool, and the like.

OVERLOADING

Do not overload wall outlets and extension cords as this can result in the risk of fire or electric shock.

VENTILATION

Slots and openings in the cabinet are provided for ventilation and to ensure reliable operation of the video product and to protect it from overheating these openings must not be blocked or covered. The openings should never be blocked by placing the video product on a bed, sofa, rug, or other similar surface. This video product should never be placed near or over a radiator or heat register.

This video product should not be placed in a built-in installation such as a bookcase or rack unless proper ventilation is provided or the manufacturer's instructions have been followed.

POWER CORD PROTECTION

Power-supply cords should be routed so that they are not likely to be walked on or pinched by items placed upon or against them paying particular attention to cords at plugs, convenience receptacles, and the point where they exit from the appliance.

CLEANING

Unplug this video product from the wall outlet before cleaning. Do not use liquid cleaners or aerosol cleaners. Use a damp cloth for cleaning.

LIGHTNING

For added protection of this video product receiver during a lightning storm, or when it is left unattended and unused for long periods of time, unplug it from the wall outlet and disconnect the antenna or cable system. This will prevent damage to the video product due to lightning and power-line surges.

OBJECT AND LIQUID ENTRY

Never push objects of any kind into this product through openings as they may touch dangerous voltage points or short-out parts that could result in a fire or electric shock. Never spill liquid of any kind on the video product.

ACCESSORIES

Do not place this video product on an unstable cart, stand, tripod, bracket, or table. The video product may fall, causing serious injury to a child or adult, and serious damage to the appliance. Use only with a cart, stand, tripod, bracket, or table recommended by the manufacturer, or sold with the video product. Any mounting of the appliance should follow the manufacturer's instructions and should use a mounting accessory recommended by the manufacturer.

CART

An appliance and cart combination should be moved with care. Quick stops, excessive force, and uneven surfaces may cause the appliance and cart combination to overturn.

POWER SOURCES

This video product should be operated only from the type of power source indicated on the marking label. If you are not sure of the type of supply to your home, consult your appliance dealer or local power company. For video products intended to be operated from battery power, or other sources, refer to the operating instructions.

POWER LINES

An outside antenna system should not be located in the vicinity of overhead power lines or other electric light or power circuits, or where it can fall into such power lines or circuits. When installing an outside antenna system, extreme care should be taken to keep from touching such power lines or circuits as contact with them might be fatal.

POLARIZATION

This video product is equipped with a polarized alternating current line plug (a plug having one blade wider than the other.) This plug will fit into the power outlet only one way. This is a safety feature. If you are unable to insert the plug fully into the outlet, try reversing the plug. If the plug should still fail to fit, contact your electrician to replace your obsolete outlet. Do not defeat the safety purpose of the polarized plug.

OUTDOOR ANTENNA GROUNDING

- If an outside antenna is connected to the antenna terminal, be sure the antenna system is grounded so as to provide some protection against voltage surges and built-up static charges.
- In the U.S.A section 810 of the National Electrical Code, ANSI/NFPA No. 70-1984, provides information with respect to proper grounding of the mast and supporting structure, grounding of the lead-in wire to an antenna discharge unit, size of grounding conductors, location of antenna discharge unit, connection to grounding electrodes, and requirements for the grounding electrode. See the figure below.

ATTACHMENTS

Do not use attachments not recommended by the video product manufacturer as they may cause hazards.

SERVICING

- Do not attempt to service this product yourself as opening or removing covers may expose you to dangerous voltage or other hazards.
- Refer all servicing to qualified service personnel.

REPLACEMENT PARTS

When replacement parts are required, be sure the service technician has used replacement parts specified by the manufacturer or having the same characteristics as the original part. Unauthorized substitutions may result in fire, electric shock or other hazards.

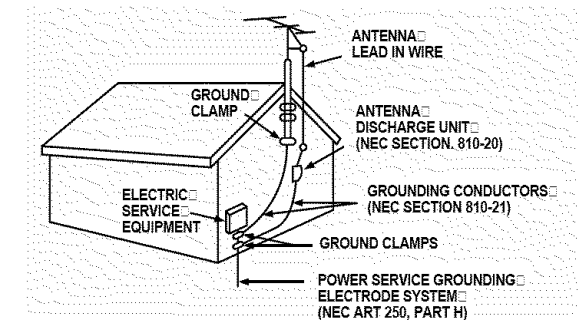

SAFETY CHECK

Upon completion of any service or repairs to this video product, ask the service technician to perform safety checks to determine that the video product is in proper operating condition.

DAMAGE REQUIRING SERVICE

- Unplug this video product from the wall outlet and refer servicing to qualified service personnel under the following conditions.
- a. When the power-supply cord or plug is damaged.
 - b. If liquid has been spilled, or objects have fallen into the video product.
 - c. If the video product has been exposed to rain or water.
 - d. If the video product does not operate normally by following the operating instructions. Adjust only those controls that are covered by the operating instructions as an improper adjustment of other controls may result in damage and will often require extensive work by a qualified technician to restore the video product to its normal operation.
 - e. If the video product has been dropped or the cabinet has been damaged.
 - f. When the video product exhibits a distinct change in performance - this indicates a need for service.

HEAT

This video unit should be situated away from heat sources such as radiators, stoves, or other products (including modules) that produce heat.

Features

● Multi-Disc Playback & FM Tuner

The HT-Q80/HT-TQ85 combines the convenience of multi-disc playback capability, including DVD-AUDIO, DVD-VIDEO, CD, MP3-CD, WMA-CD, DivX, CD-R/RW, and DVD-R/RW, with a sophisticated FM tuner, all in a single player.

● USB Host Play

You can enjoy media files such as pictures, movies and tunes saved in an MP3 player, digital camera or USB memory by connecting the storage device to the USB port of the home theater.

● Dolby Pro Logic II

Dolby Pro Logic II is a new form of multi-channel audio signal decoding technology that improves upon existing Dolby Pro Logic.

● DTS (Digital Theater Systems)

DTS is an audio compression format developed by Digital Theater Systems Inc. It delivers full-frequency 5.1 channel sound.

● TV Screen Saver Function

The HT-Q80/HT-TQ85 automatically brightens and darkens your TV screen after 3 minutes in the stop mode.

The HT-Q80/HT-TQ85 automatically switches itself into the power saving mode after 20 minutes in the screen saver mode.

● Power Saving Function

The HT-Q80/HT-TQ85 automatically shuts itself off after 20 minutes in stop mode.

● Customized TV Screen Display

The HT-Q80/HT-TQ85 allows you to select your favorite image during JPEG and DVD playback and set it as your background wallpaper.

● HDMI

HDMI transmits DVD video and audio signals simultaneously, and provides a clearer picture.

● AV SYNC Function

Video may lag behind the audio if the unit is connected to a digital TV.

To compensate for this, you can adjust the audio delay time to sync up with the video.

● Optional XM radio

Samsung's XM Ready Home Theater Systems give you the opportunity to enjoy America's leading satellite radio service in CD-quality sound.

● Optional Wireless receiver amplifier

Samsung's optional rear-channel wireless module does away with cables running between your DVD receiver and rear-channel speakers. Instead, the rear speakers connect to a compact wireless module that communicates with your DVD receiver.

Contents

● PREPARATION

Safety Warnings	1
Precautions	2
Safety Instructions	3
Features	5
Notes on Discs	7
Description	9

● CONNECTIONS

Connecting the Speakers	13
Connecting the optional Wireless Receiving Amplifier	15
Connecting the Video Out to TV	18
Connecting the HDMI IN/OUT	19
HDMI Function	20
Connecting External Components	22
Connecting the FM Antenna	23
Connecting an optional XM Satellite Radio Antenna	24

● OPERATION

Before Using Your Home Theater	25
Disc Playback	27
Selecting a Disc in the Disc changer	28
MP3/WMA-CD Playback	29
Displaying Disc Information	30
JPEG File Playback	31
DivX Playback	33
Checking the Remaining Time	35
Fast/Slow Playback	36
Skipping Scenes/Songs	36
Repeat Playback	37
A-B Repeat Playback	38
Step Function	39
Angle Function	39
Zoom (Screen Enlarge) Function	40
EZ VIEW Function	40
Bonus Group / Navigating Pages	41
Selecting Audio/Subtitle Language	42
Playing Media Files using the USB HOST feature	43
Moving Directly to a Scene/Song	45
Using Disc Menu	46
Using the Title Menu	46

● SETUP

Setting the Language	47
Setting TV Screen type	49
Setting Parental Controls (Rating Level)	51
Setting the Password	52
Setting the Wallpaper	53
DVD Playback Mode	55
Setting the Speaker Mode	56
Setting the Delay Time	57
Setting the Test Tone	59
Setting the DRC (Dynamic Range Compression)	60
Setting the Audio	61
AV SYNC Setup	63
Sound Field (DSP)/EQ Function	64
Dolby Pro Logic II Mode	65
Dolby Pro Logic II Effect	66

● RADIO OPERATION

Listening to Radio	67
Presetting Stations	68
Before Using XM Satellite Radio	69
Listening to XM Satellite Radio	70
XM Display Mode	71
XM Search Mode	73
Presetting XM Satellite Radio	74

● MISCELLANEOUS

Convenient Functions	75
Operating a TV with the Remote Control	77
Before Calling for Service	79
Cautions on Handling and Storing Discs	81
Language Code List	82
USB Host Feature Supported Products	83
Specifications	84

● Speaker Installation

How to install the speaker and the stand	85
--	----

Notes on Discs



DVD (Digital Versatile Disc) offers fantastic audio and video, thanks to Dolby Digital surround sound and MPEG-2 video compression technology. Now you can enjoy these realistic effects in the home, as if you were in a movie theater or concert hall.

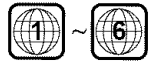

DVD players and the discs are coded by region. These regional codes must match in order for the disc to play. If the codes do not match, the disc will not play. The Region Number for this player is given on the rear panel of the player. (Your DVD player will only play DVDs that are labeled with identical region codes.)

Playable Discs

Disc Type	Mark (Logo)	Recorded Signals	Disc Size	Max. Playing Time
DVD		Audio + Video	5"	Approx. 240 min. (single-sided) Approx. 480 min. (double-sided)
			3 1/2"	Approx. 80 min. (single-sided) Approx. 160 min. (double-sided)
AUDIO-CD		Audio	5"	74 min.
			3 1/2"	20 min.
DivX		MPEG4 MP3	5"	74 min.
			3 1/2"	20 min.

Do not use the following types of disc!

- LD, CD-G, CD-I, CD-ROM and DVD-ROM discs cannot be played on this player. If such discs are played, a "WRONG DISC FORMAT" message appears on the TV screen.
- DVD discs purchased abroad may not play on this player. If such discs are played, a "WRONG REGION CODE" message appears on the TV screen.

Copy Protection

- Many DVD discs are encoded with copy protection. Because of this, you should only connect your DVD player directly to your TV, not to a VCR. Connecting to a VCR results in a distorted picture from copy-protected DVD discs.
- This product incorporates copyright protection technology that is protected by methods claims of certain U.S. patents and other intellectual property rights owned by Macrovision Corporation and other rights owners. Use of this copyright protection technology must be authorized by Macrovision Corporation, and is intended for home and other limited viewing uses only unless otherwise authorized by Macrovision Corporation. Reverse engineering or disassembly is prohibited.

Disc Recording Format

This product does not support Secure (DRM) Media files.

CD-R Discs

- Some CD-R discs may not be playable depending on the disc recording device (CD-Recorder or PC) and the condition of the disc.
- Use a 650MB/74 minute CD-R disc. Do not use CD-R discs over 700MB/80 minute as they may not be played back.
- Some CD-RW (Rewritable) media, may not be playable.
- Only CD-Rs that are properly "closed" can be fully played. If the session is closed but the disc is left open, you may not be able to fully play the disc.

CD-R MP3 Discs

- Only CD-R discs with MP3 files in ISO 9660 or Joliet format can be played.
- MP3 file names should be 8 characters or less in length and contain no blank spaces or special characters (. / = +).
- Use discs recorded with a compression/decompression data rate greater than 128Kbps.
- Only files with the ".mp3" and ".MP3" extensions can be played.
- Only a consecutively written Multisession disc can be played. If there is a blank segment in the Multisession disc, the disc can be played only up to the blank segment.
- If the disc is not closed, it will take longer to begin playback and not all of the recorded files may be played.
- For files encoded in Variable Bit Rate (VBR) format, i.e. files encoded in both low bit rate and high bit rate (e.g., 32Kbps ~ 320Kbps), the sound may skip during playback.
- A maximum of 500 tracks can be played per CD.
- A maximum of 300 folders can be played per CD.

CD-R JPEG Discs

- Only files with the ".jpeg" and ".JPEG" extensions can be played.
- If the disc is not closed, it will take longer to start playing and not all of the recorded files may be played.
- Only CD-R discs with JPEG files in ISO 9660 or Joliet format can be played.
- JPEG file names should be 8 characters or less in length and contain no blank spaces or special characters (. / = +).
- Only a consecutively written multisession disc can be played. If there is a blank segment in the multisession disc, the disc can be played only up to the blank segment.
- A maximum of 9,999 images can be stored on a single CD.
- When playing a Kodak/Fuji Picture CD, only the JPEG files in the picture folder can be played.
- Picture discs other than Kodak/Fuji Picture CDs may take longer to start playing or may not play at all.

CD-R/RW DivX Discs

- Since this product only provides encoding formats authorized by DivX Networks, Inc., a DivX file created by the user might not be played.
- Software update for unsupported formats is not supported. (Example: QPEL, GMC, resolution higher than 720 x 480 pixels, etc.)
- Sections with high frame rate might not be played while playing a DivX file.
- For more information about the formats authorized by DivX Networks, Inc., visit "www.divxnetworks.net".

Description

—Front Panel—

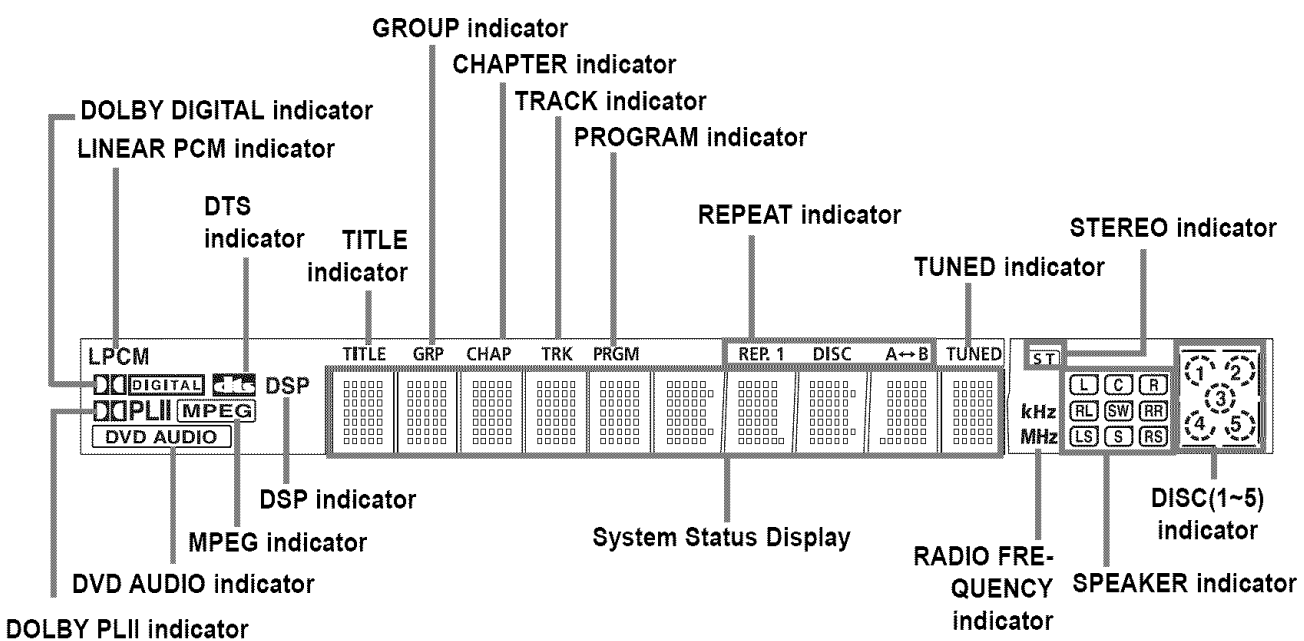
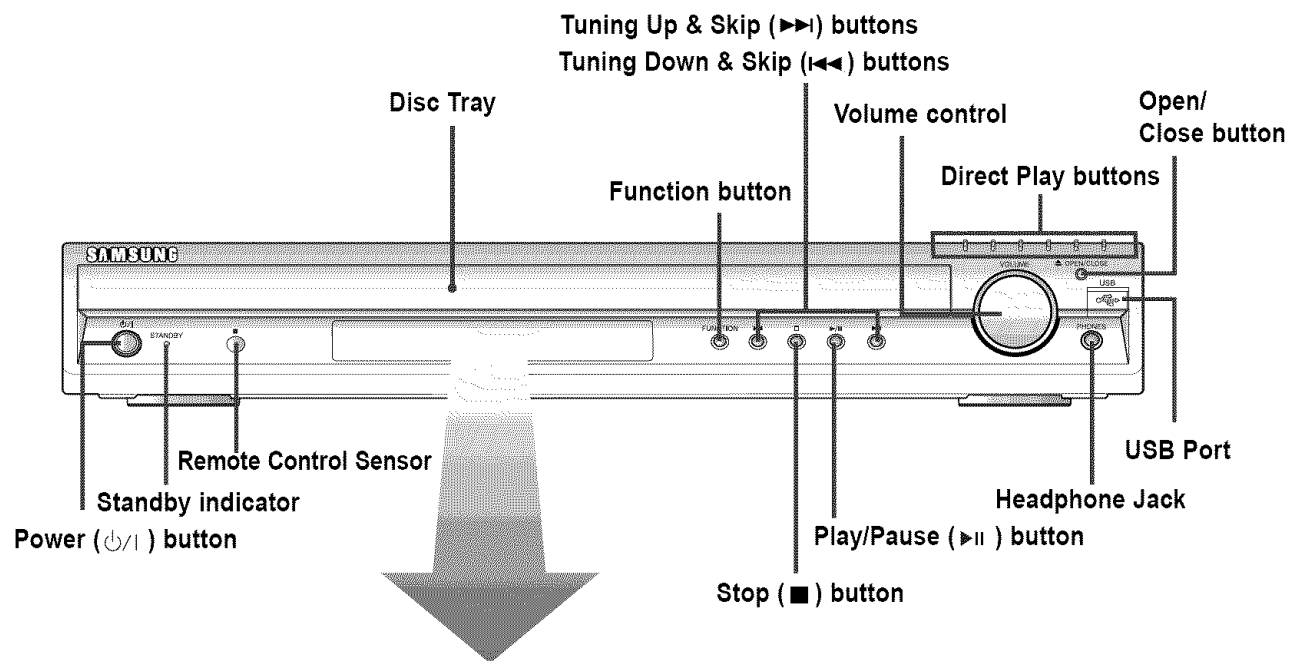

—Rear Panel—

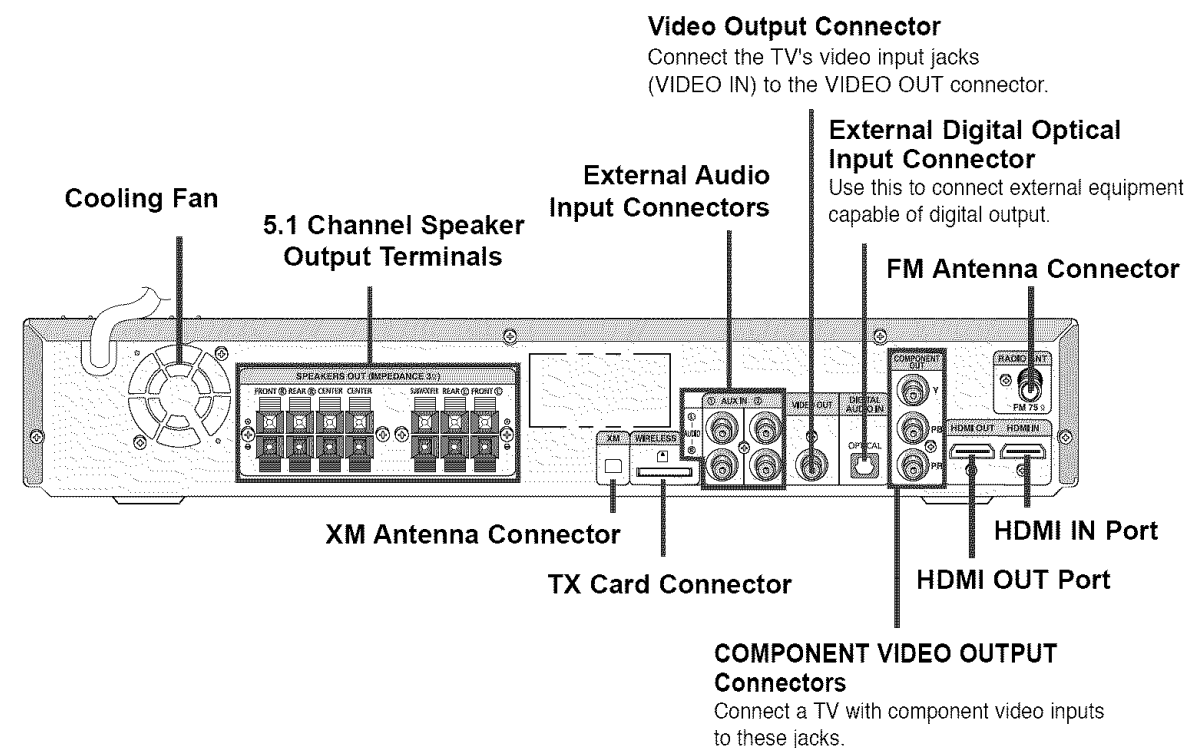

Accessories

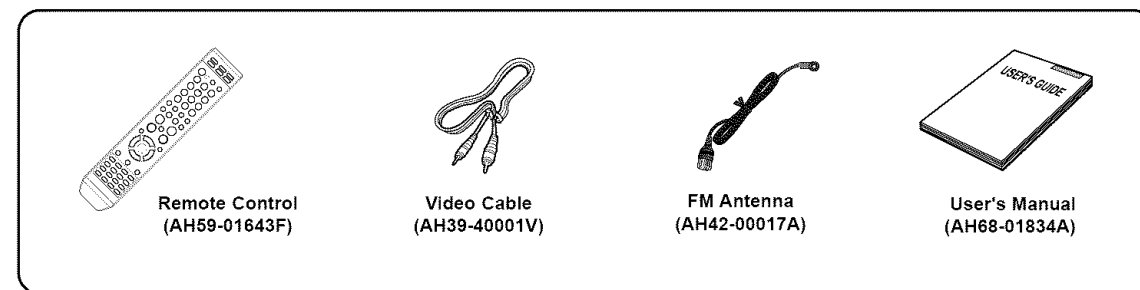

—Remote Control—

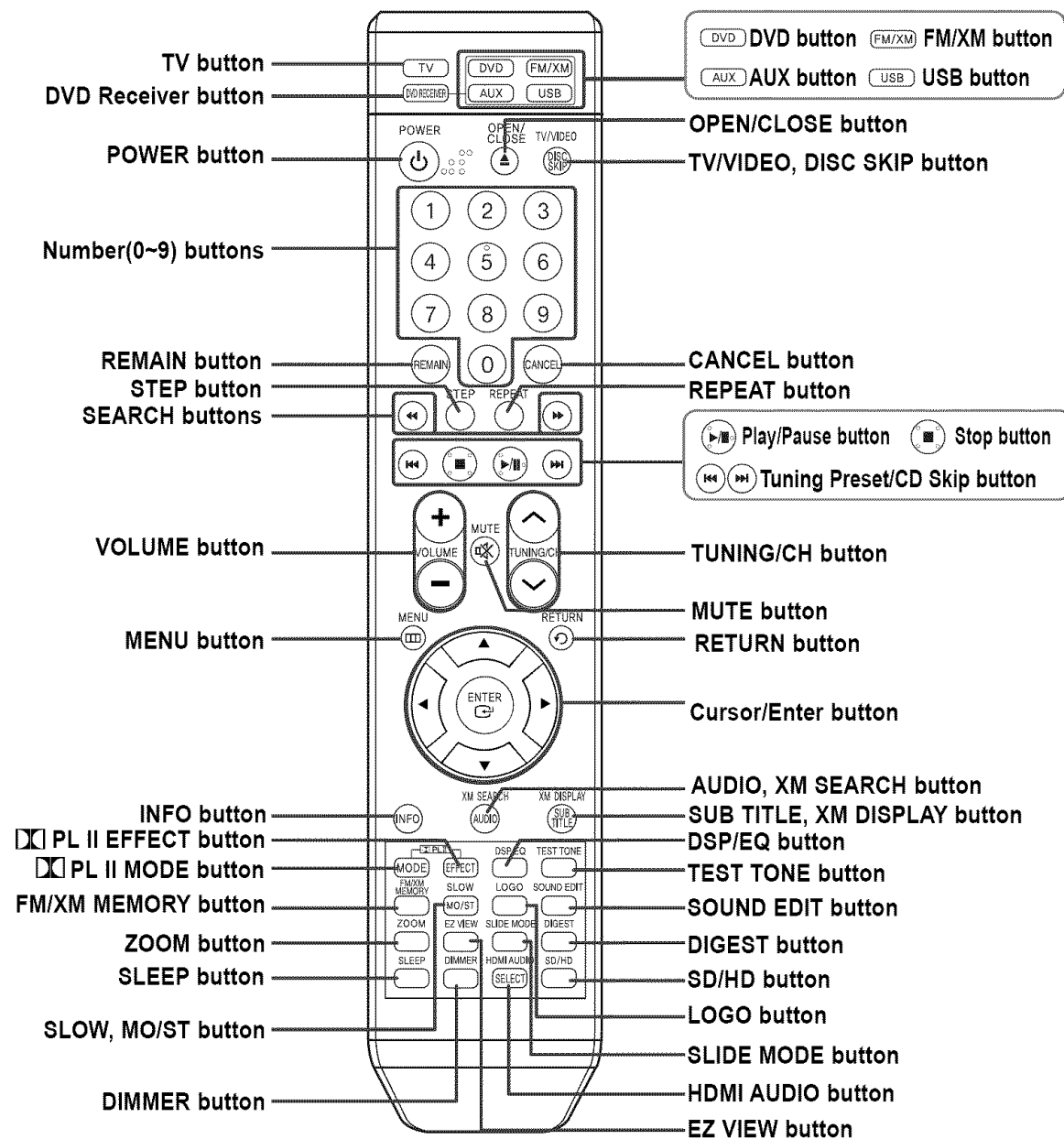

Insert Remote Batteries

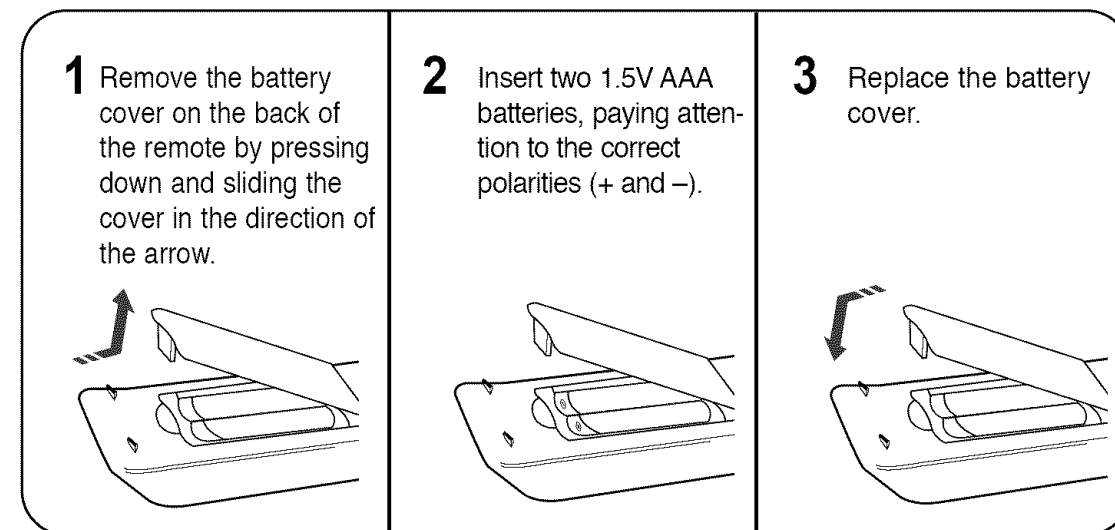

- Caution** Follow these precautions to avoid leaking or cracking cells:
- Place batteries in the remote control so they match the polarity:(+) to (+)and (-)to (-).
 - Use the correct type of batteries.Batteries that look similar may differ in voltage.
 - Always replace both batteries at the same time.
 - Do not expose batteries to heat or flame.

Range of Operation of the Remote Control

The remote control can be used up to approximately 23 feet/7 meters in a straight line. It can also be operated at a horizontal angle of up to 30° from the remote control sensor.

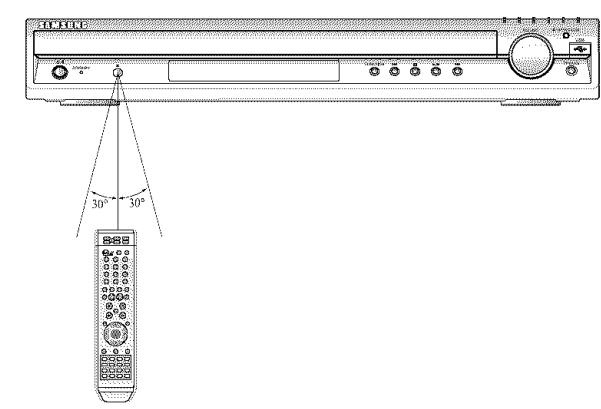

Connecting the Speakers

Before moving or installing the product, be sure to turn off the power and disconnect the power cord.

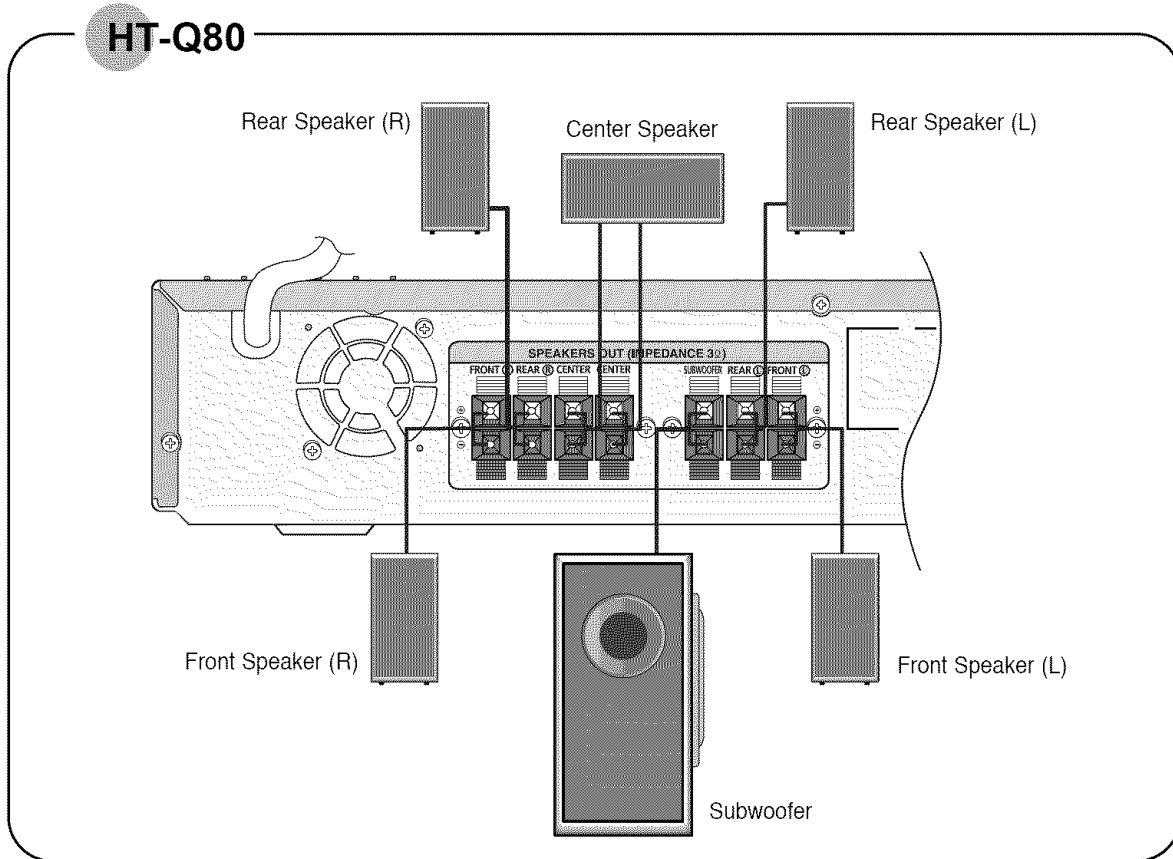

Position of the Home Theater

- Place it on a stand, cabinet shelf, or under the TV stand.

Front Speakers **L R**

- Place these speakers in front of your listening position, facing inwards (about 45°) toward you.
- Place the speakers so that their tweeters will be at the same height as your ear.
- Align the front face of the front speakers with the front face of the center speaker or place them slightly in front of the center speakers.

Center Speaker **C**

- It is best to install it at the same height as the front speakers.
- You can also install it directly over or under the TV.

Selecting the Listening Position

The listening position should be located about 2.5 to 3 times the distance of the TV's screen size away from the TV. Example: For 32" TVs 2~2.4m (6~8 feet)
For 55" TVs 3.5~4m (11~13 feet)

Rear Speakers **SL SR**

- Place these speakers behind your listening position.
- If there isn't enough room, place these speakers so they face each other.
- Place them about 60 to 90cm (2 to 3feet) above your ear, facing slightly downward.

★ Unlike the front and center speakers, the rear speakers are used to handle mainly sound effects and sound will not come from them all the time.

Subwoofer **SW**

- The position of the subwoofer is not so critical. Place it anywhere you like.

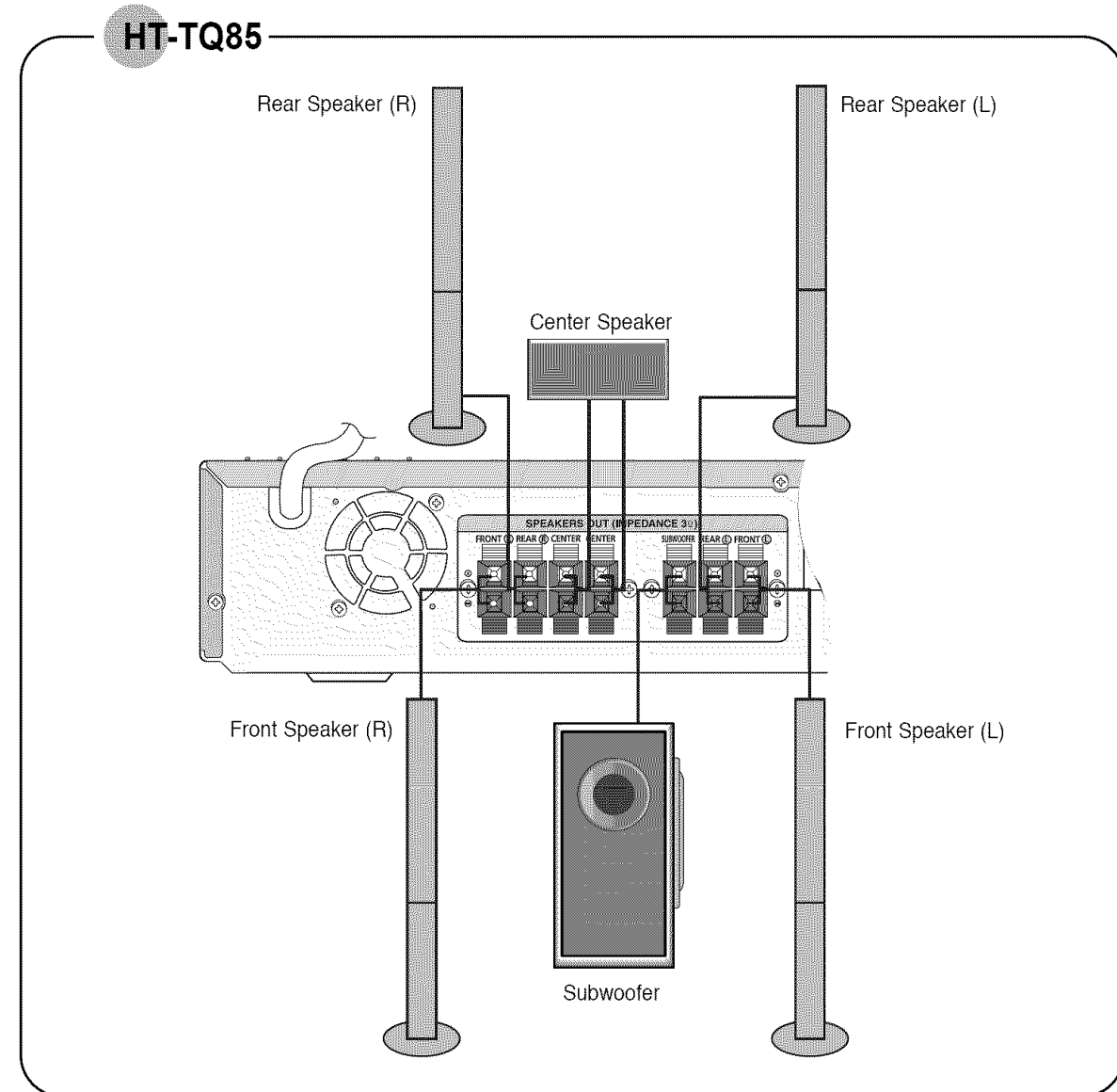

1 Press and hold the terminal tab.

2 Insert the speaker cord.

3 Release your finger.

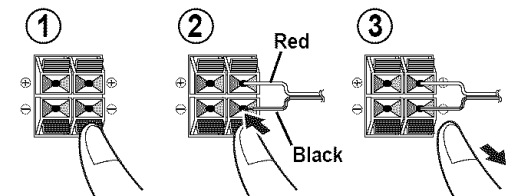

Caution

- Do not let children play with or near the speakers. They could get hurt if a speaker falls.
- When connecting the speaker wires to the speakers, make sure that the polarity (+/-) is correct.

Note

- If you place a speaker near your TV set, screen color may be distorted because of the magnetic field generated by the speaker. If this occurs, place the speaker away from your TV set.

Connecting the optional Wireless Receiving Amplifier

To connect the rear speakers wirelessly, you have to additionally purchase the wireless receiving module and TX card from your Samsung retailer.

HT-Q80

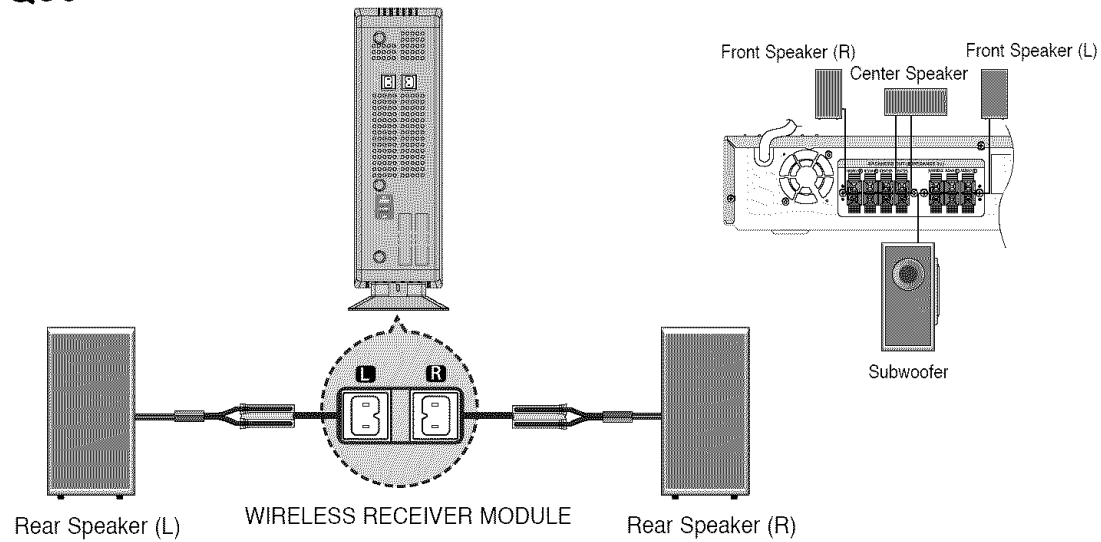

HT-TQ85

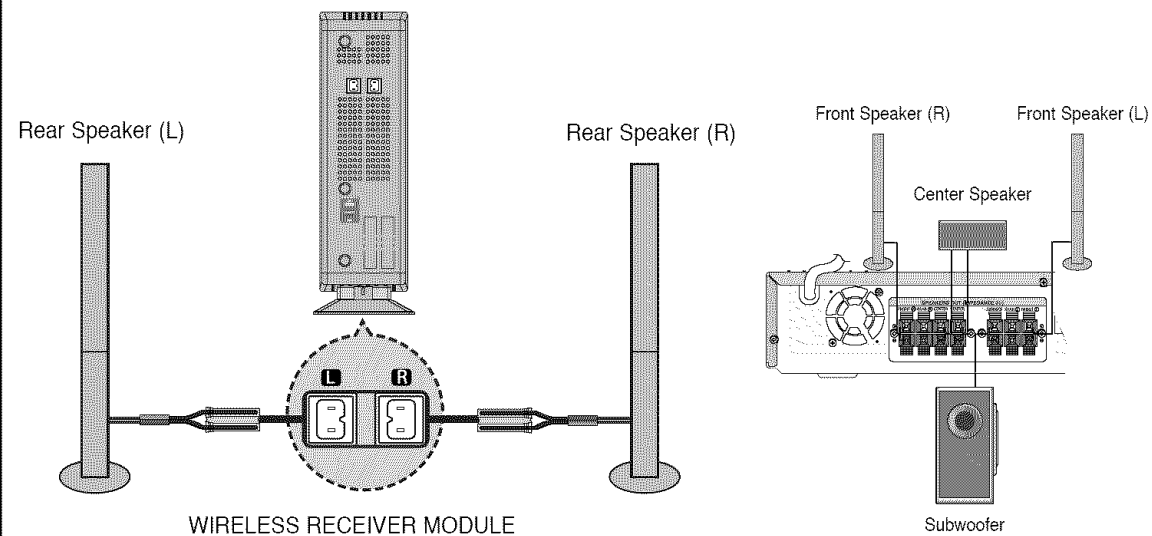

When you have purchased the wireless receiving module (SWA-3000) additionally

- 1 Connect the front, center and subwoofer speakers, referring to page 14.
- 2 Insert the TX card into the TX card connection port on the back of the main unit.
 - Hold the TX card so that the slanted side faces leftward and insert the card into the port.
 - The TX card enables communication between the main unit and the wireless receiver.
- 3 Connect the left and right rear speakers to the wireless receiving module.
- 4 Plug the power cord of the wireless receiving module in the wall outlet and switch the power switch 'ON'.

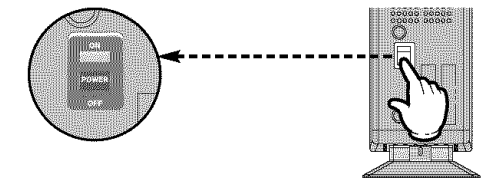
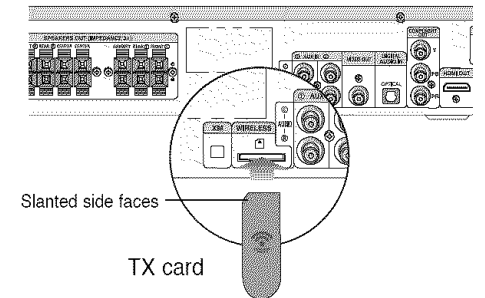

Caution

- Do not insert a card other than the TX card dedicated for the product. The product might be damaged or it may not be removed easily.
- Do not insert the TX card upside down or in reverse direction.
- Insert the TX card when the main unit is turned off. Inserting the card when it is turned on may cause a problem.
- If the TX Card is inserted in the main unit, the rear speakers don't output sounds.

Connecting the optional Wireless Receiving Amplifier

Resetting Wireless Communication

Reset the system if a communication failure occurs, or if the Link indicator (blue LED) on the wireless receiver does not light up and the "REAR CHK" message blinks on the main unit's display.
Reset the system while the main unit and the wireless receiver module (SWA-3000) are in Power Standby mode.

- 1 With the main unit turned off, press and hold the remote control's **REMAIN** button for 5 seconds.

- Press the button until the POWER(☺) indicator lights up blue. (The indicator will turn off in 1 second.)

- 2 With the wireless receiver module turned on, use a ball point pen or a pair of tweezers to press the **RESET** button on the back of the unit.

- The Standby/On LED on the front panel of the wireless receiver module blinks 2 times.

- 3 Turn on the main unit.

- The Link LED of the wireless receiver module is lit and the setup is finished.
- If Power Standby mode continues, repeat Steps 1 to 3 above.

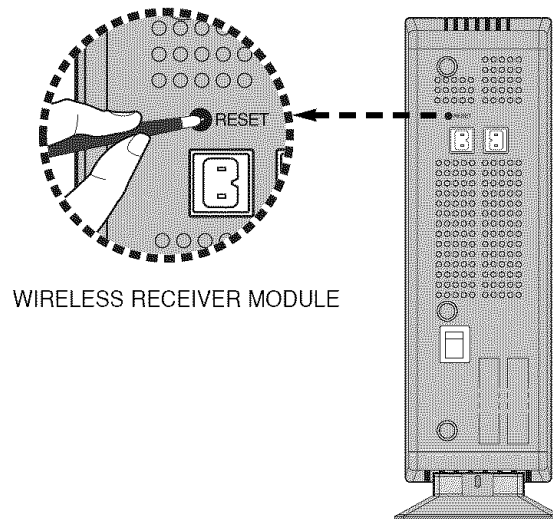

Caution

- When the wireless receiving module setting is complete, no audio signal is output from the Rear Speaker OUT ports on the back of the main unit.
- The wireless receiving antenna is built into the wireless receiver module. Keep the unit away from water and moisture.
- For optimal listening performance, make sure that the area around the wireless receiver module location is clear of any obstructions.
- Sound will be heard from the wireless rear speakers in DVD 5.1-CH or Dolby Pro Logic II mode only.
- In 2-CH mode, no sound will be heard from the wireless rear speakers.

Note

- Place the wireless receiver module at the rear of the listening position. If the wireless receiver module is too close to the main unit, some sound interruption may be heard due to interference.
- If you use a device such as a microwave oven, wireless LAN Card, Bluetooth equipment, or any other device that uses the same frequency (2.4GHz) near the system, some sound interruption may be heard due to interference.
- The transmission distance of radio wave is about 33 feet, but may vary depending on your operating environment.
If a steel-concrete wall or metallic wall is between the main unit and the wireless receiver module, the system may not operate at all, because the radio wave cannot penetrate metal.

Connecting the Video Out to TV

Choose one of the two methods for connecting to a TV.

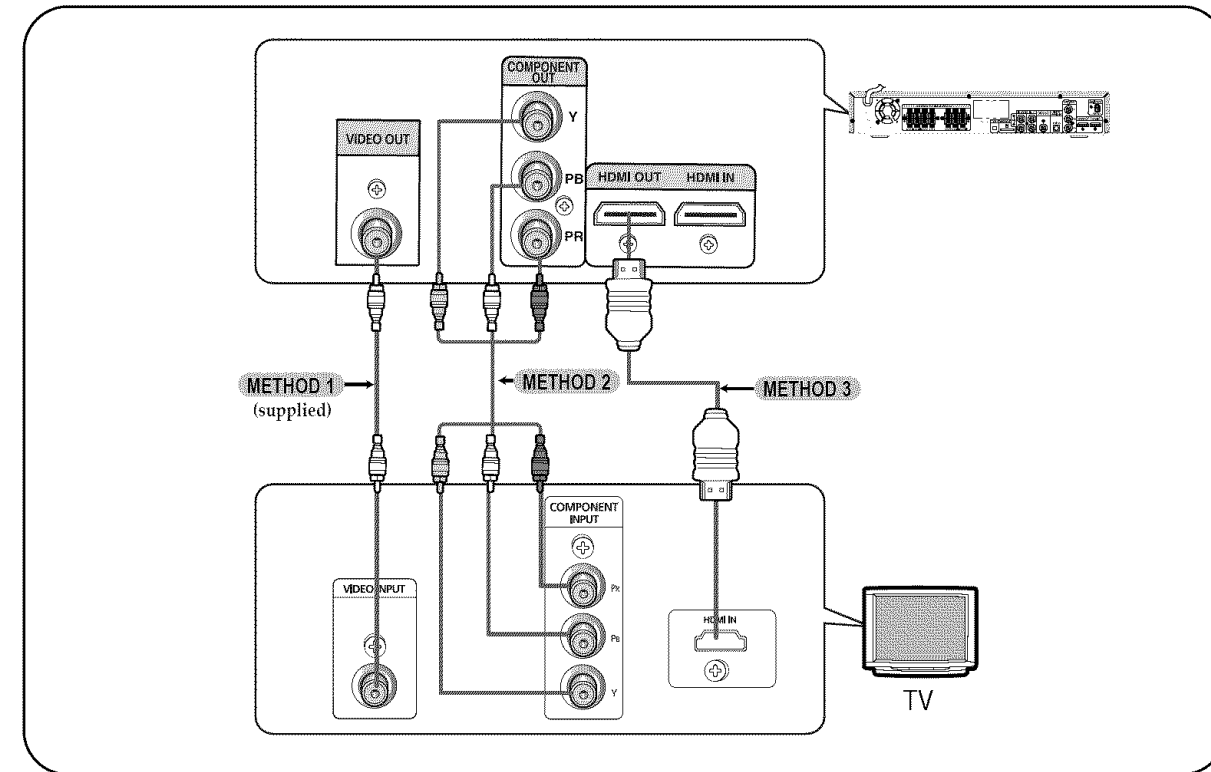

METHOD 1 Composite Video (Good Quality)

- Connect the supplied video cable from the VIDEO OUT jack on the back panel of the system to the VIDEO IN jack on your TV.

METHOD 2 Component (Better Quality)

- If your television is equipped with Component Video inputs, connect a component video cable (not supplied) from the Pr, Pb and Y jacks on the back panel of the system to the corresponding jacks on your TV.

METHOD 3 HDMI (Best Quality)

- Connect the HDMI out to the HDMI input on your TV.

Note

- This product operates in Progressive scan mode(480p Only) for Component Output.
- If the TV only supports a resolution of 576i(480i), the screen may be divided into 2 screens, or display nothing.
- After making the video connection, set the Video input source on your TV to match the corresponding Video output (HDMI, Component or Composite) on your Home theater. See your TV owner's manual for more information on how to select the TV's Video Input source.

Connecting the HDMI IN/OUT

HDMI (High-Definition Multimedia Interface) is a next generation TV-type digital interface specification that enables transmitting digital video and audio over a single cable. In addition, it enables you to enjoy multi-channel digital audio.

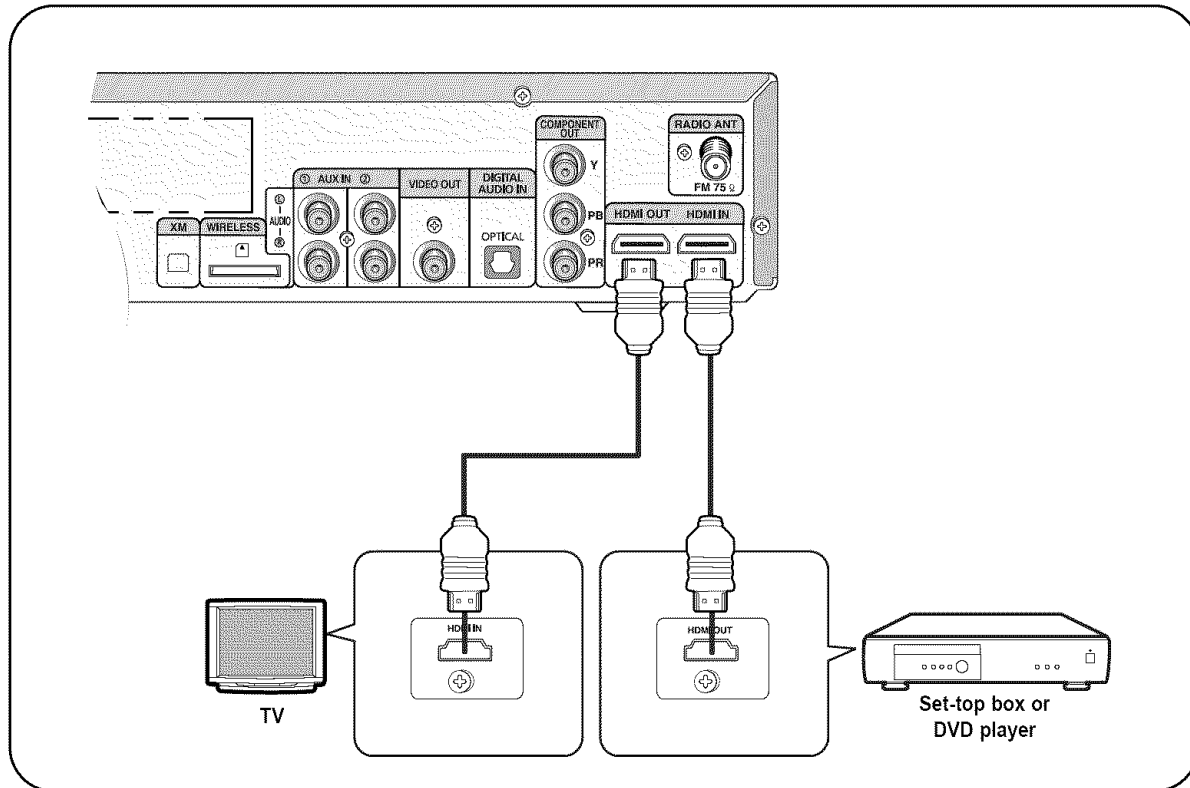

- 1 Connect the HDMI IN Port of this unit and the HDMI OUT Port of a set-top box or the DVD player.
- 2 Connect the HDMI OUT Port of this unit and the HDMI IN Port of your TV.
- 3 Press **AUX** on the remote control to select 'HDMI IN'.
 - Each time the button is pressed, the selection changes as follows:
DIGITAL IN → AUX 1 → AUX 2 → HDMI IN.
 - You can also use the **FUNCTION** button on the main unit.
The mode switches as follows: DVD/CD → DIGITAL IN → AUX 1 → AUX 2 → HDMI IN → USB → FM → XM.

Note

- When this unit is turned off, no HDMI video or audio signal is output from this unit.
- In the HDMI IN Function, the video resolution switch button (SD/HD) does not work.
- When the output from an external device, which is connected to this device, is DVI, no audio will be output. In this case, you can listen to the digital audio by connecting the Optical OUT of the source device and the Optical IN of this device, even if the source device and this device is connected through DVI interface.

HDMI Function

What is HDMI (High Definition Multimedia Interface)?

This device transmits DVD video signal digitally without the process of converting to analog. You can get sharper digital pictures by connecting the video to your TV using an HDMI connection cable.

HDMI Audio ON/OFF function

- The audio signals transmitted over the HDMI Cable can be toggled ON/OFF.

Press the **HDMI AUDIO** button on the remote control.

- This toggles between "AUDIO ON" and "AUDIO OFF" on the display.
- **AUDIO ON** : Both video and audio signals are transmitted over the HDMI connection cable, and audio is output through your TV speakers only.
- **AUDIO OFF** : Video is transmitted over the HDMI connection cable only, and audio is output through the home theater speakers only.

Note

- The default setting value of this product is HDMI AUDIO OFF.
- HDMI AUDIO is automatically down-mixed to 2ch for TV speakers.
- If you turn the unit off and on, or switch functions when the HDMI AUDIO is set to ON, the HDMI AUDIO is automatically set to OFF.

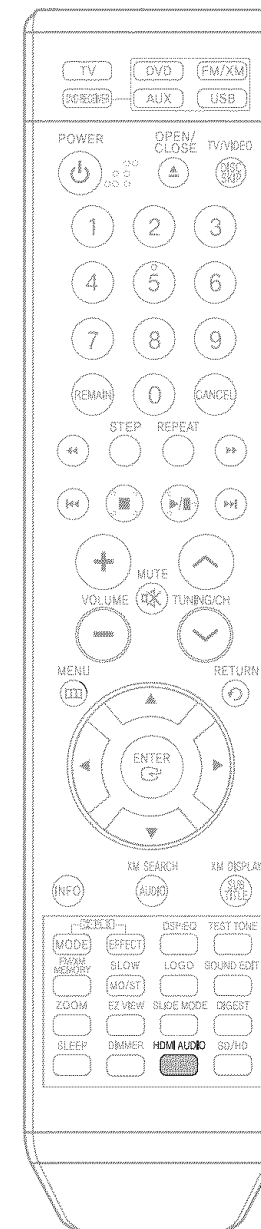

HDMI Function

Resolution Selection

- This function allows the user to select screen resolution for HDMI output.

In Stop mode, press and hold the **SD/HD** (Standard Definition/High Definition) button on the remote control.

- Resolutions available for the HDMI output are 480P, 720P and 1080i.
- SD(Standard Definition) resolution is 480p and HD(High Definition) resolution is 720p/1080i.

Example: If the TV supports resolution up to 480p:

Press the **SD/HD** button.

- A 480p video signal is output through the HDMI output.
- If the TV does not support the configured resolution, you will not be able to see the picture properly.

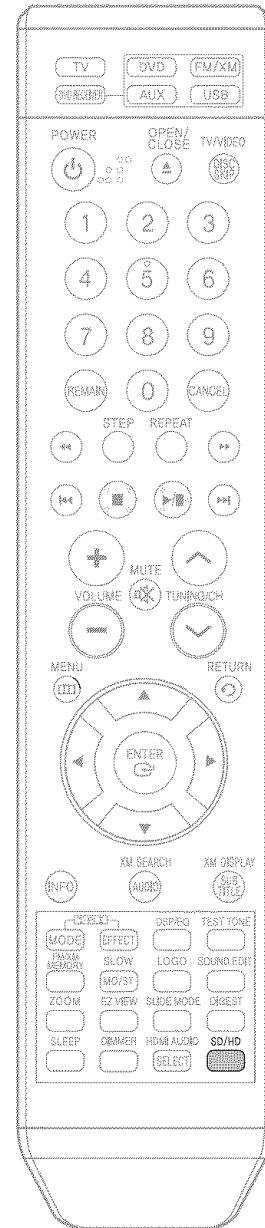

Note

- You do not have to make separate adjustments, since the Home Theater and TV will be automatically adjust themselves to the optimal resolution and aspect ratio if connected to HDMI. (If the TV is an HDTV and has an HDMI Input jack, output is automatically converted to 1080i resolution (if supported by the TV).)
- For component video output, only 480P is supported.
- When both HDMI and COMPONENT jacks are connected, COMPONENT video is not displayed.
- See your TV owner's manual for more information on how to select the TV's Video Input source.

Connecting External Components

Connecting an External Digital / Analog Component

Example: Digital signal components such as a Set-Top Box or CD Recorder.

Analog signal components such as a VCR.

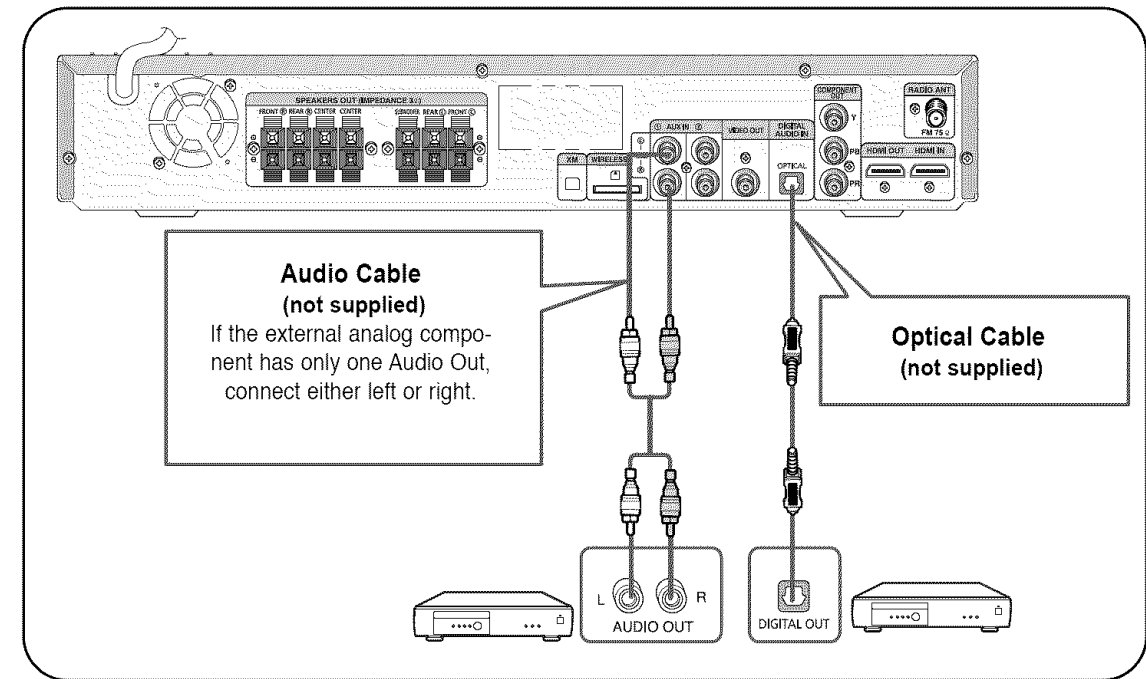

- 1 Connect the Digital Input (OPTICAL) to the Digital Output on the external digital component.
- 2 Connect AUX (Audio) In on the Home Theater to Audio Out on the external analog component.
 - Be sure to match connector colors.
- 3 Press **AUX** on the remote control to select 'HDMI IN /DIGITAL IN / AUX1/AUX2' input.
 - Each time the button is pressed, the selection changes as follows: AUX1 → AUX2→ HDMI IN→DIGITAL IN
 - You can also use the **FUNCTION** button on the main unit.

The mode switches as follows: DVD/CD → DIGITAL IN → AUX1→ AUX2→HDMI IN → USB → FM → XM

Note

- You can connect the Video Output jack on your VCR to the TV, and connect the Audio Output jacks on the VCR to this product.

Connecting the FM Antenna

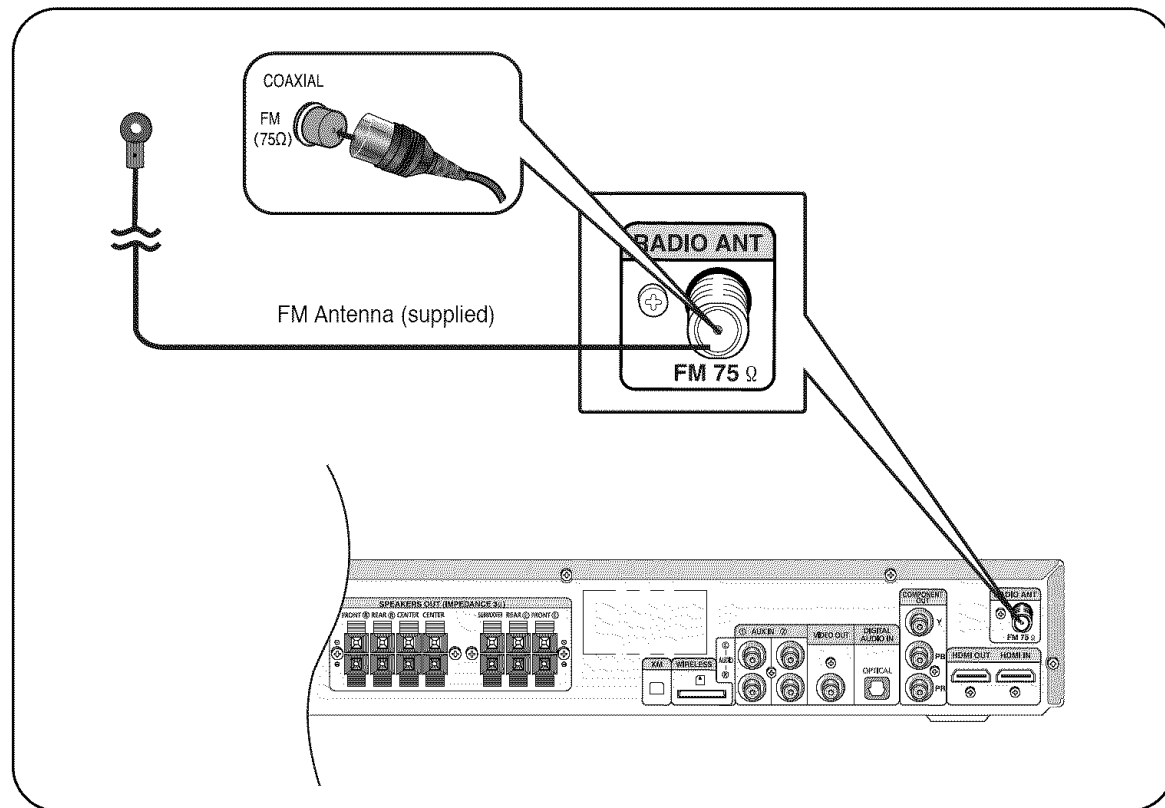

- 1 Connect the FM antenna supplied to the FM 75Ω COAXIAL terminal.
- 2 Slowly move the antenna wire around until you find a location where reception is good, then fasten it to a wall or other rigid surface.

Cooling Fan The cooling fan supplies cool air to the unit to prevent overheating.

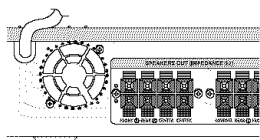

Please observe the following cautions for your safety.

- Make sure the unit is well-ventilated. If the unit has poor ventilation, the temperature inside the unit could rise and may damage it.
- Do not obstruct the cooling fan or ventilation holes. (If the cooling fan or ventilation holes are covered with a newspaper or cloth, heat may build up inside the unit and fire may result.)

Notes • This unit does not receive AM broadcasts.

Connecting an optional XM Satellite Radio Antenna

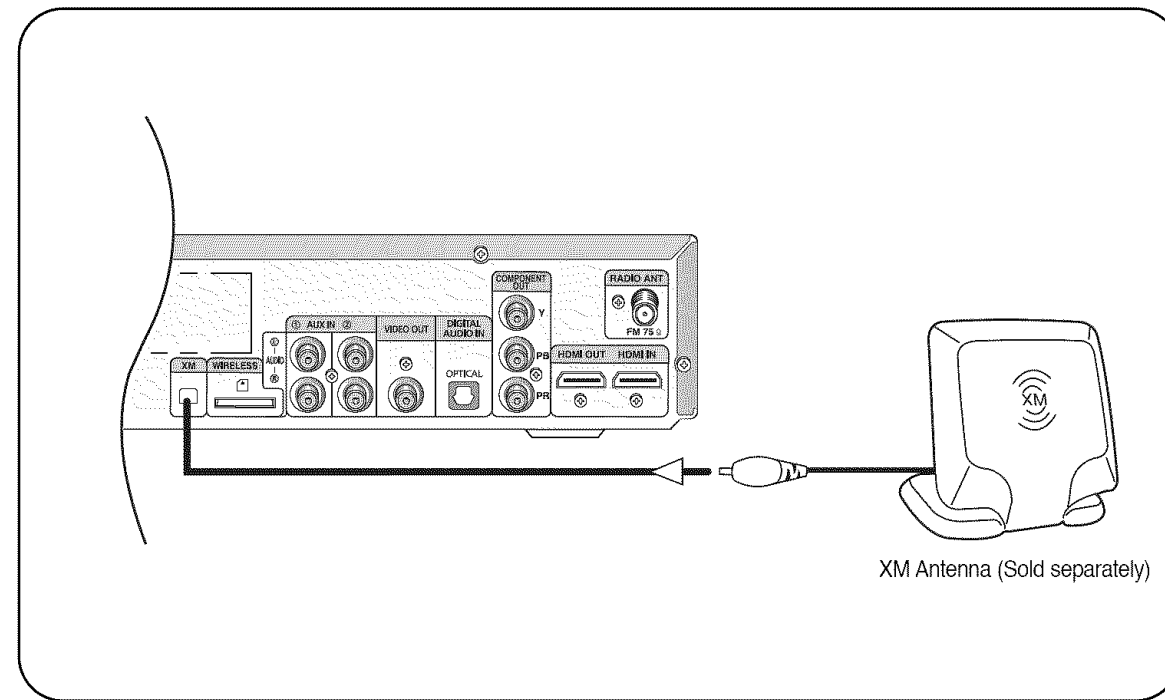

Connect the XM Antenna(Sold separately) to the XM Antenna Connector on the rear of this unit.

- Notes**
- To ensure optimal reception of XM's satellite signal, the XM Antenna should be placed at or near a southerly facing window with nothing obstructing its path to the sky. You can mount it indoors or outdoors.
 - When making connections, also refer to the operation instructions of the XM Antenna.
 - Depending on your location, the radio signal may be weak or cannot be tuned .

Before Using Your Home Theater

Your Home Theater is capable of playing DVD, CD, MP3/WMA and JPEG discs. Depending on the disc you are using, these instructions may vary slightly. Read the instructions carefully before using.

To Operate your Samsung TV and the Home Theater with the HT-Q80/HT-TQ85's Remote Control

1 Plug the main unit's power cord into the AC power supply.

2 Press **TV** button to set the remote to TV mode.

3 Press the **POWER** button to turn on your Samsung TV with this remote.

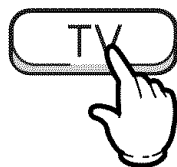

4 Press **TV/VIDEO** button to select VIDEO mode on your TV.

5 Press **DVD RECEIVER** button to switch to DVD RECEIVER mode.

6 Press **FUNCTION** button on the main unit or DVD button on the remote to enable DVD/CD playback.

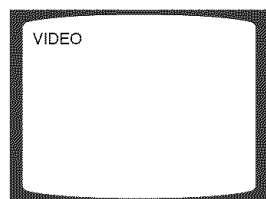

Note

- Buttons Enabled for TV Operation: POWER, CHANNEL, VOLUME, TV/VIDEO, and Numeric (0-9) buttons.
- By default, the remote control is set to work with Samsung TVs. See page 77 for more information about remote control operation with other manufacturer's TVs.

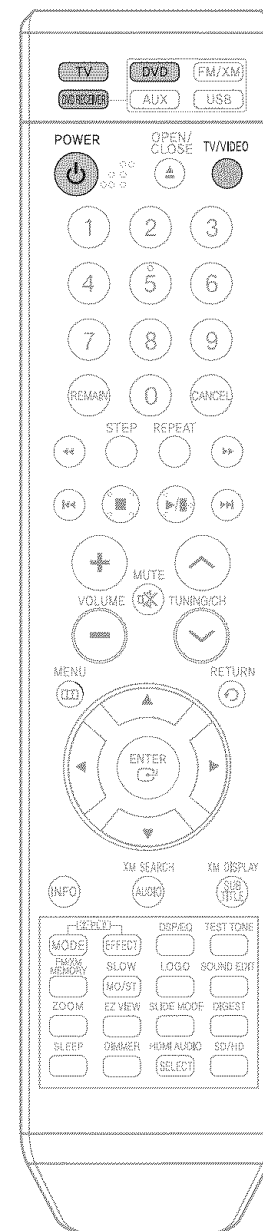

Disc terminology

Groups and tracks (DVD-AUDIO)

- DVD-audio is divided into several large sections called "groups" and smaller sections called "tracks". Numbers are allotted to these sections. These numbers are called "group numbers" and "track numbers".

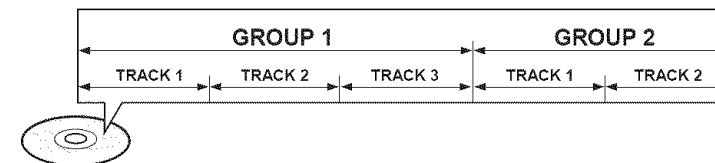

Titles and chapters (DVD-VIDEO)

- DVD-video is divided into several large sections called "titles" and smaller sections called "chapters". Numbers are allotted to these sections. These numbers are called "title numbers" and "chapter numbers".

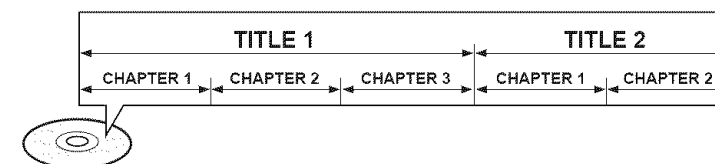

Tracks (Video and music CDs)

- Video and music CDs are divided into sections called "tracks". Numbers are allotted to these sections. These numbers are called "track numbers".

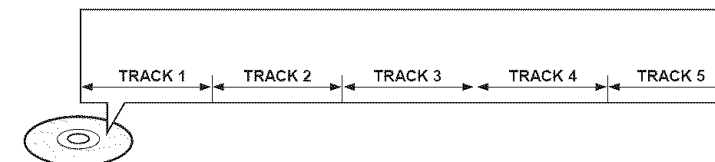

Files (DivX)

- DivX is divided into sections called "files". Numbers are allotted to these sections. These numbers are called "file numbers".

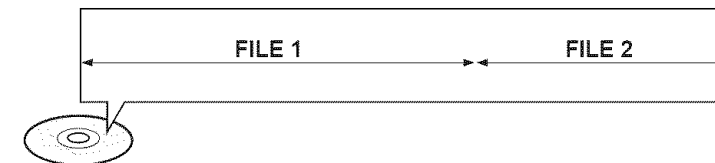

Note

- In this manual, the instructions marked with "DVD (DVD)" are applicable to DVD-VIDEO, DVD-AUDIO, and DVD-R/RW discs. Where a particular DVD type is mentioned, it is indicated separately.
- Depending on the content of the disc, the initial screen may appear different.

Disc Playback

1 Press **OPEN/CLOSE** button to open the disc tray.

2 Load a disc.
• Place a disc gently into the tray with the disc's label facing up.

3 Press **DISC SKIP** button.
• Rotate the carousel tray so you can load the third, fourth, and fifth discs.

4 Close the compartment by pressing the **OPEN/CLOSE** button again.

DVD **CD**

• Playback starts automatically.

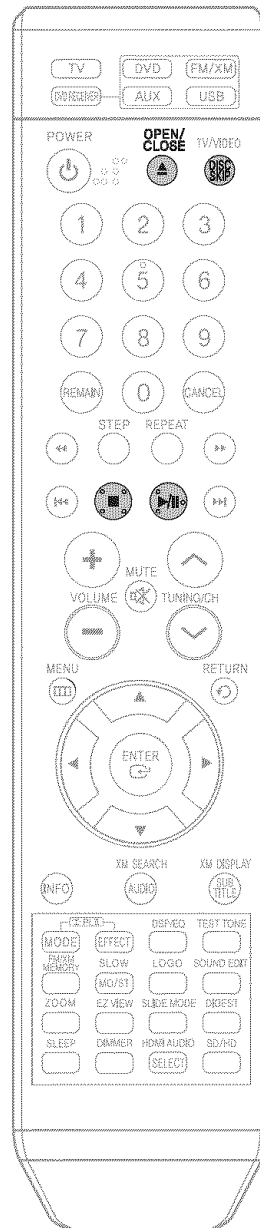

Note • Depending on the content of the disc, the initial screen may appear different.

Selecting a Disc in the Disc changer

The DVD/CD function is automatically selected when Disc Skip is pushed.

To select a specific disc, press the corresponding **DIRECT PLAY (1, 2, 3, 4, 5)** buttons on the front panel or **DISC SKIP** on the remote control, until the required disc indicator flashes.

• If the disc selected is not loaded, the next disc is played automatically.

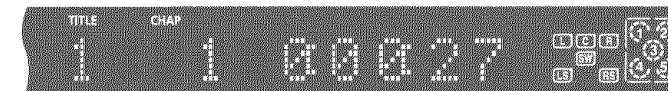

To stop playback, press **STOP** during playback.

- If pressed once, "PRESS PLAY" is displayed and the stop position will be stored in memory. If **PLAY/PAUSE (▶/||)** button or **ENTER** button is pressed, playback resumes from the stop position. (This function works only with DVDs.)
- If pressed twice, "STOP" is displayed, and if **PLAY/PAUSE (▶/||)** button is pressed, playback starts from the beginning.

To temporarily pause playback, press **PLAY/PAUSE** during playback.

- To resume playback, press **PLAY/PAUSE (▶/||)** button again.

MP3/WMA-CD Playback

Data CDs (CD-ROM, CD-R, CD-RW) encoded in MP3/WMA format can be played.

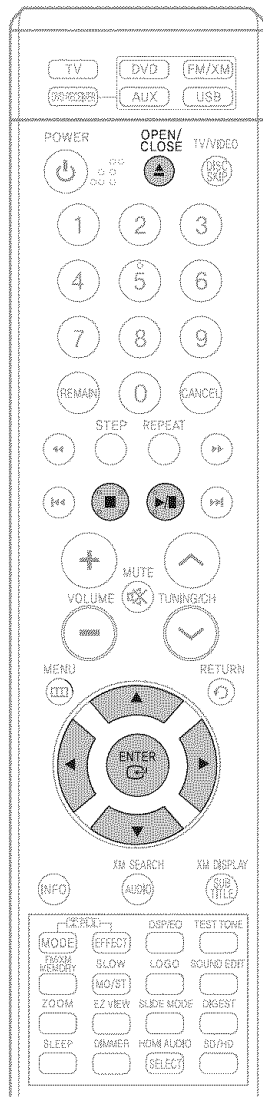

1 Press the **OPEN/CLOSE** button to open the disc tray, and then load the MP3/WMA disc.

- The MP3/WMA menu screen will appear and playback will start.
- The appearance of the menu depends on the MP3/WMA disc.
- WMA-DRM files cannot be played.

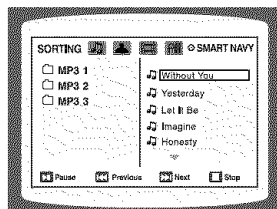

2 In Stop mode, use ◀ ▶ ▲ ▼ to select the album, and then press the **ENTER** button.

- Use ▲ ▼ to select the track.

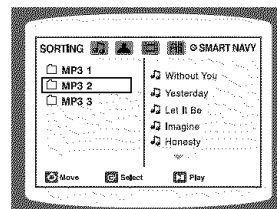

3 To change the album, use ◀ ▶ ▲ ▼ to select another album in Stop mode, and then press the **ENTER** button.

- To select another album and track, repeat Steps 2 and 3 above.

Note • Depending on the recording mode, some MP3/WMA-CDs may not play.
• Table of contents of a MP3-CD varies depending on the MP3/WMA track format recorded on the disc.

4 Press the **STOP** button to stop playback.

To play a file icon in the screen,

Press the ◀ ▶ ▲ ▼ button when it is in stop status and select a desired icon from the top part of the menu.

- To play music files only, select the icon.
- To view image files only, select the icon.
- To view movie files only, select the icon.
- To select all files select the icon.

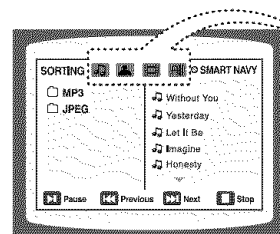

- Music File Icon
- Image File Icon
- Movie File Icon
- All File Icon

Displaying Disc Information

You can view disc playback information on the TV screen.

Press **INFO** button.

- Each time the button is pressed, the display changes as follows:

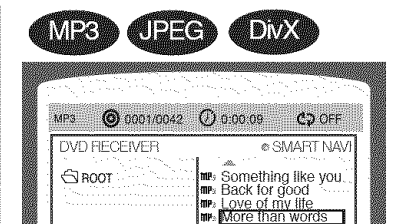
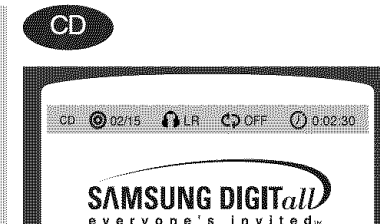
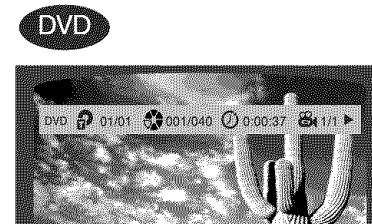

The information Display disappears from the screen

The information Display disappears from the screen

appears on the TV screen!

If this symbol appears on the TV screen while buttons are being operated, that operation is not possible with the disc currently being played.

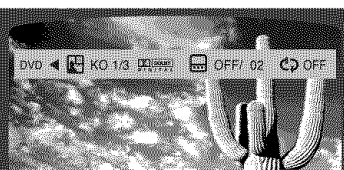

The information Display disappears from the screen

Note

- Depending on the disc, the disc information display may appear different.
- Depending on the disc, you can also select DTS, DOLBY DIGITAL, or PRO LOGIC.

- **What is a Group?**
A section of tracks contained in a DVD-AUDIO disc.
- **What is a Title?**
A movie contained in a DVD-VIDEO disc.
- **What is a Chapter?**
Each title on a DVD disc is divided into several smaller sections called "chapters".
- **What is a Track (File)?**
A section of video or a music file recorded on a DVD-AUDIO, CD, or MP3-CD

Screen Display

- | | | | |
|-------------------|----------------------|-------------------------|-------------------------|
| DVD display | TITLE display | ELAPSED TIME display | LR STEREO (L/R) display |
| CD display | GROUP display | REPEAT PLAYBACK display | DOLBY DIGITAL display |
| DVD-AUDIO display | CHAPTER display | AUDIO LANGUAGE display | ANGLE display |
| | TRACK (FILE) display | SUBTITLE display | |

JPEG File Playback JPEG

Images captured with a digital camera or camcorder, or JPEG files on a PC can be stored on a CD and then played back with this Home Theater.

Slide Mode

1 Place the JPEG disc on the disc tray.

2 Press the **OPEN/CLOSE** button.

3 Press **SLIDE MODE** button.

- Playback starts automatically.
- Each time the button is pressed, the image makes the transition as follows:

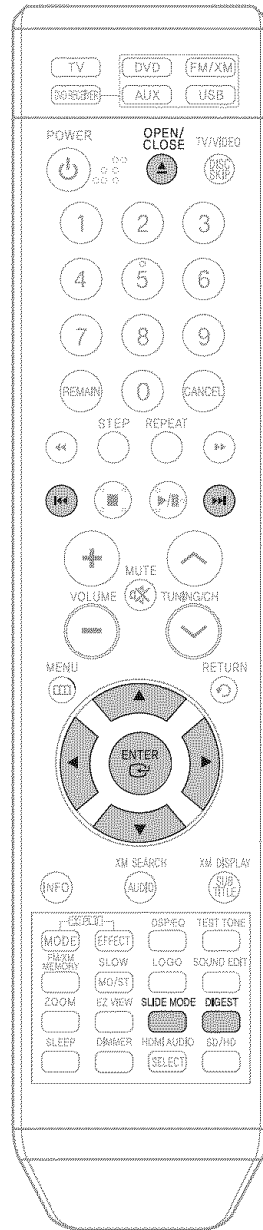
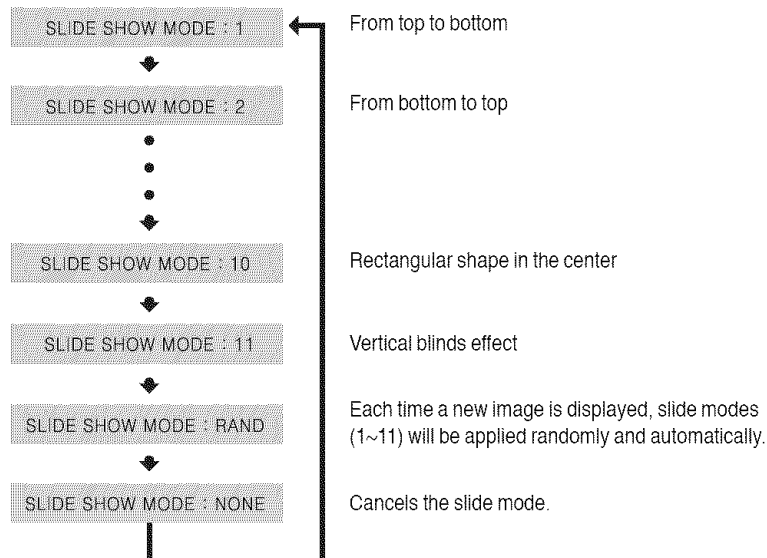

Press **I◀◀▶▶I** to skip to the next slide.

- Each time the button is pressed, the slide moves backward or forward.

Digest Function

You can view 9 JPEG images on the TV screen.

1 Press **DIGEST** button during playback.

- JPEG files will be shown in 9 windows.

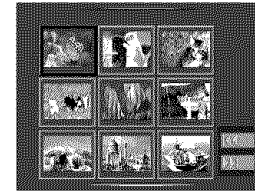

2 Press Cursor **▲, ▼, ◀, ▶** buttons to select the desired image and then press **ENTER** button.

- The selected image is played for 5 seconds before moving to the next image.

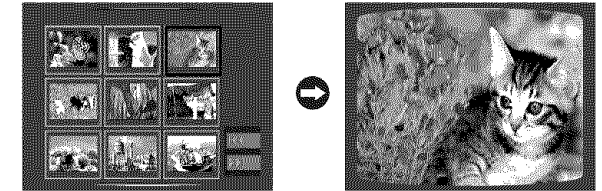

To view the previous or next image with 9 windows, press **◀◀▶▶**.

Rotate/Flip Function

Press Cursor **▲, ▼, ◀, ▶** buttons during playback.

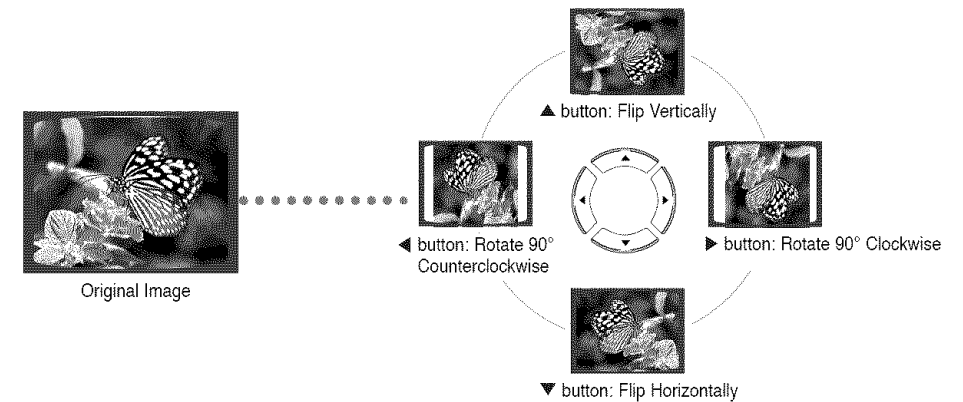

- Note**
- The maximum resolutions supported by this product are 5120 x 3480 (or 19.0 MPixel) for standard JPEG files and 2048 x 1536 (or 3.0 MPixel) for progressive image files.

DivX Playback

The functions on this page apply to DIVX disc playback.

Skip Forward/Back

During playback, press the **⏮ ⏭** button.

- Goes to the next file whenever you press **⏭** button, if there are over 2 files in the disk.
- Goes to the previous file whenever you press **⏮** button, if there are over 2 files in the disk.

Fast playback

To play back the disc at a faster speed, press **⏮** or **⏭** during playback.

- Each time you press either button, the playback speed will change as follows:
2x → 4x → 8x → 32x → Normal.

5 Minute Skip function

During playback, press the **⏮** , **⏭** button.

- Playback skips 5 minutes forward whenever you press **⏭** button.
- Playback skips 5 minutes back whenever you press **⏮** button.

Zoom Function

1 Press **ZOOM** button.

- Each time you press the button, your selection will toggle between "ZOOM X2" and "ZOOM OFF".

2 Press Cursor **▲, ▼, ◀, ▶** buttons to move to the area you want to enlarge.

- Note**
- DIVX file can be zoomed only in ZOOM X2 mode.
 - DivX files have .Avi file extensions, however, not all .Avi files are DivX and may not be playable in this unit.

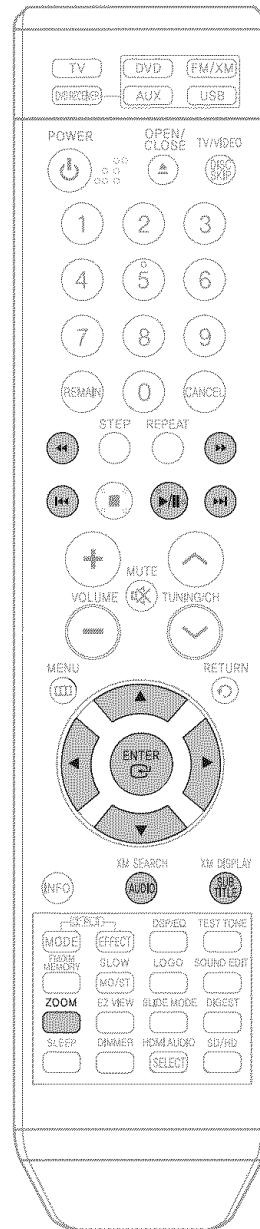

Subtitle Display

Press the **SUBTITLE** button.

- Each time you press the button, your selection will toggle between "SUBTITLE (1/1, 1/2 ...)" and "SUBTITLE OFF".
- If the disc has only one subtitle file, it will be played automatically.
- See number 2 (Caption Function) below for more details concerning Subtitle usage with DIVX discs.

Audio Display

Press the **AUDIO** button.

- If there are multiple audio tracks on a disc, you can toggle between them.
- Each time you press the button, your selection will toggle between "AUDIO(1/1, 1/2 ...)" and "👉".

Note • "👉" is displayed when there is one supported language in the disc.

DivX(Digital internet video eXpress)

DivX is a video file format developed by Microsoft and is based on MPEG4 compression technology to provide audio and video data over the Internet in real-time. MPEG4 is used for video encoding and MP3 for audio encoding so that the users can watch a movie at near DVD-quality video and audio.

1. Supported Formats

- This product only supports the following media formats. If both video and audio formats are not supported, the user may experience problems such as broken images or no sound.

• Supported Video Formats

Format	AVI	WMV
Supported Versions	DivX3.11 ~ 5.1	V1/V2/V3/V7

• Supported Audio Formats

Format	MP3	WMA	AC3	DTS
Bit Rate	80~384kbps	56~128kbps	128~384kbps	1.5Mbps
Sampling Frequency	44.1khz		44.1/48khz	44.1khz

- DivX files, including audio and video files, created in the DTS format can only support up to 6Mbps.
- Aspect Ratio: Although default DivX resolution is 640*480 pixels (4:3), this product supports up to 720*480 pixels (16:9). TV screen resolutions higher than 800 will not be supported.
- When you play a disc whose sampling frequency is higher than 48khz or 320kbps, you may experience shaking on the screen during playback.

2. Caption Function

- You must have some experience with video extraction and editing in order to use this feature properly.
- To use the caption function, save the caption file (*.smi) in the same file name as that of the DivX media file (*.avi) within the same folder.

Example. Root Samsung_007CD1.avi
Samsung_007CD1.smi

- Up to 60 alphanumeric characters or 30 East Asian characters (2 byte characters such as Korean and Chinese) for the file name.

Checking the Remaining Time

Press the **REMAIN** button.

- For checking the total and remaining time of a title or chapter being played.

Each time the **REMAIN** button is pressed

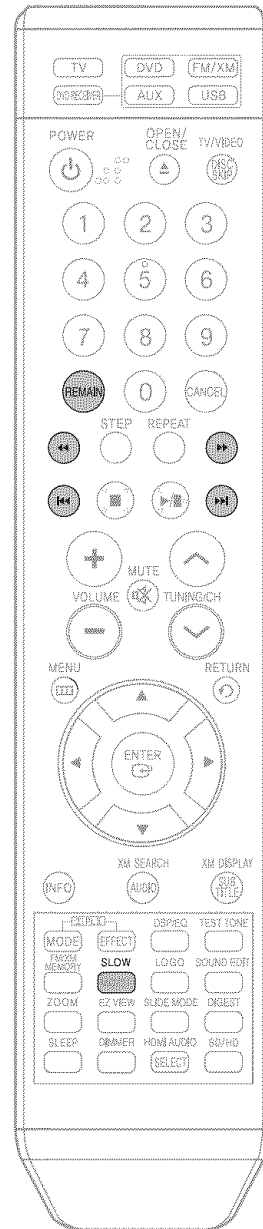
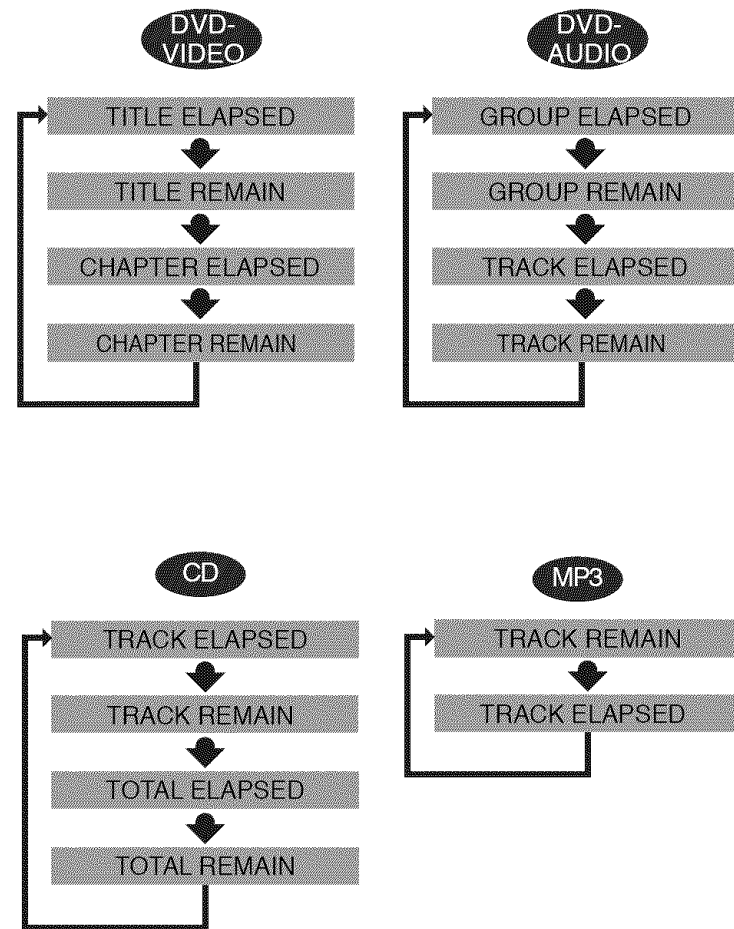

Fast/Slow Playback

Fast Playback

DVD CD MP3

Press **◀▶**.

- Each time the button is pressed during playback, the playback speed changes as follows.

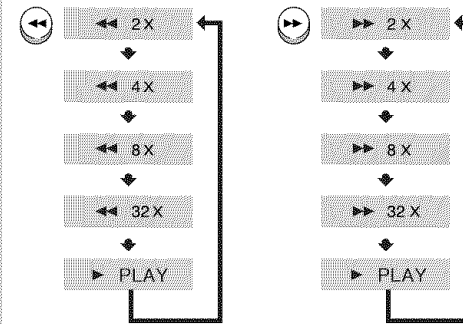

Note

- During fast playback of a CD or MP3-CD, sound is heard only at 2x speed, and not at 4x, 8x, and 32x speeds.

Slow Playback

Press **SLOW** button.

- Each time the button is pressed during playback, the playback speed changes as follows.

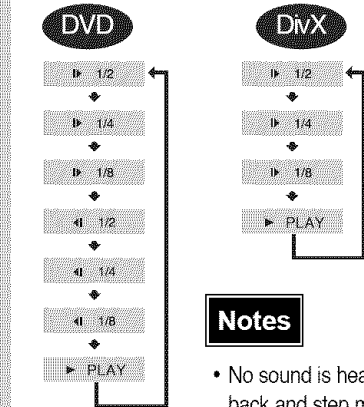

Notes

- No sound is heard during slow playback and step motion playback.
- Reverse slow playback does not work with DivX.

Skipping Scenes/Songs

Press **◀▶**.

- Each time the button is pressed briefly during playback, the previous or next chapter, track, or directory (file) will be played.
- You cannot skip chapters consecutively.

DVD

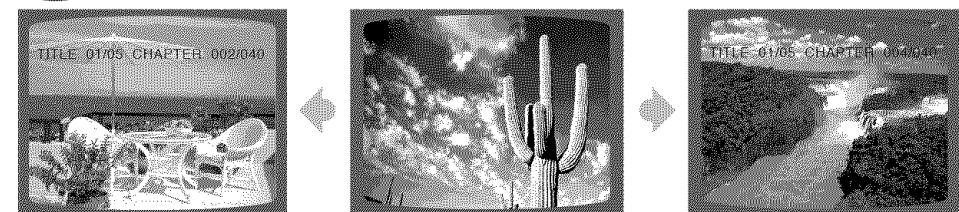

MP3

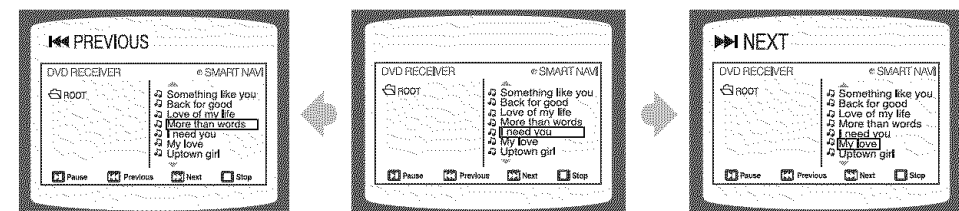

Repeat Playback

Repeat playback allows you to repeatedly play a chapter, title, track (song), or directory (MP3 file).

DVD CD MP3 JPEG

Press **REPEAT** button.

- Each time the button is pressed during playback, the repeat playback mode changes as follows:

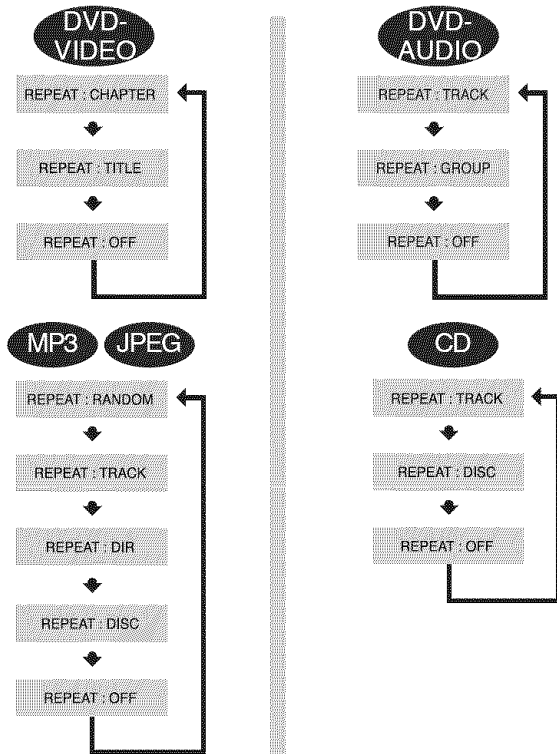

Repeat Playback Options

- CHAPTER**
Repeatedly plays the selected chapter.
- TITLE**
Repeatedly plays the selected title.
- GROUP**
Repeatedly plays the selected group.
- RANDOM**
Plays tracks in random order.
(A track that has already been played may be played again.)
- TRACK**
Repeatedly plays the selected track.
- DIR**
Repeatedly plays all tracks in the selected folder.
- DISC**
Repeatedly plays the entire disc.
- OFF**
Cancels Repeat Playback.

To Select a Repeat Playback Mode in the Disc Information Screen

- Press **INFO** button twice.
- Press Cursor **▶** button to move to REPEAT PLAYBACK (↻) display.
- Press Cursor **▼** button to select the desired Repeat Playback mode.
- Press **ENTER** button.

* For MP3 and JPEG discs, you cannot select Repeat Play from the information display screen.

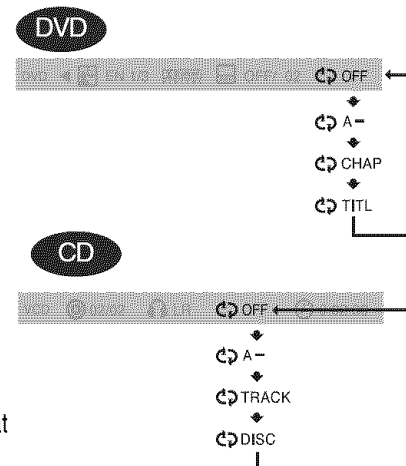

A-B Repeat Playback

You can repeatedly play back a designated section of a DVD.

DVD

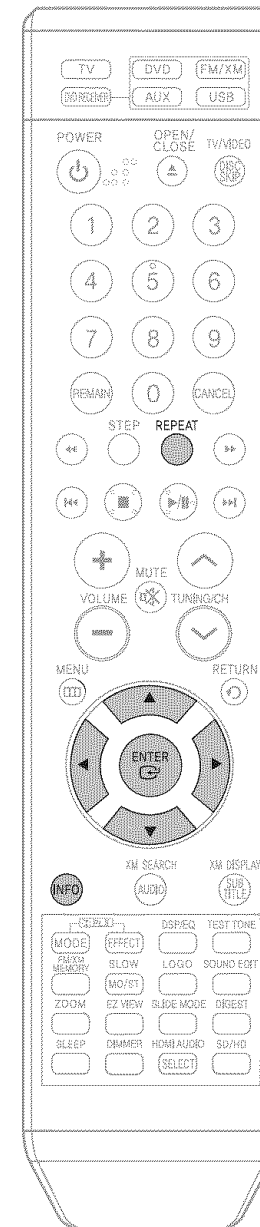

- Press **INFO** button twice.



- Press Cursor **▶** button to move to REPEAT PLAYBACK (↻) display.



- Press Cursor **▲**, **▼** buttons to select 'A-' and then press **ENTER** button at the beginning of the desired segment.

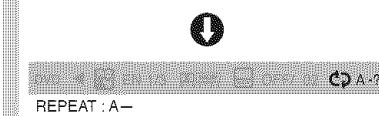

- Press **ENTER** button at the end of the desired segment.

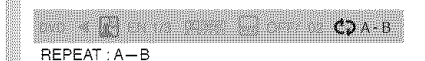

- When **ENTER** button is pressed, the selected position will be stored in memory.

- The specified segment will be played repeatedly.

To return to normal playback, press Cursor **▲**, **▼** buttons to select **↻ OFF**.

Note

- The A-B Repeat function does not operate with MP3, CD or JPEG discs.

Step Function DVD

Press **STEP** button.

- The picture moves forward one frame each time the button is pressed during playback.

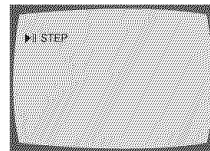

Angle Function DVD

This function allows you to view the same scene in different angles.

1 Press **INFO** button.

2 Press Cursor **▶** button to move to **ANGLE** () display.

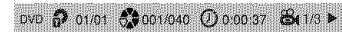

3 Press Cursor **▲**, **▼** or numeric buttons to select the desired angle.

- Each time the button is pressed, the angle changes as follows:

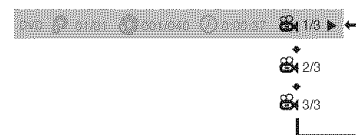

- Note**
- The Angle function works only with discs on which multiple angles have been recorded.

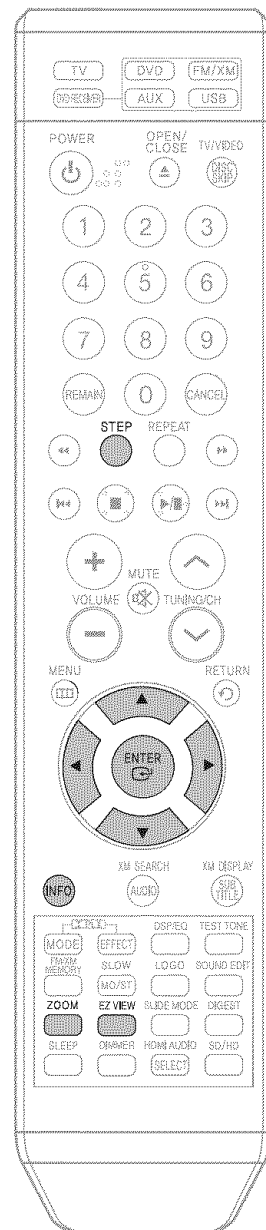

Zoom (Screen Enlarge) Function DVD

This function allows you to enlarge a particular area of the displayed image.

1 Press **ZOOM** button.

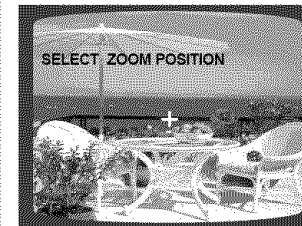

2 Press Cursor **▲**, **▼**, **◀**, **▶** buttons to move to the area you want to enlarge.

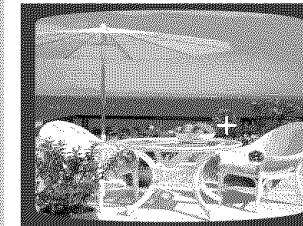

3 Press **ENTER** button.

- Each time the button is pressed, the zoom level changes as follows:

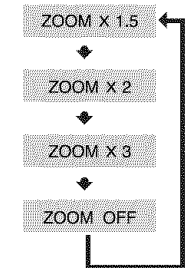

- Note**
- When a DivX disc is being played, only the 2:1 zoom-in is available.

EZ VIEW Function DVD

Press **EZ VIEW** button.

- Each time the button is pressed, the zoom function will switch between On and Off.
- When a movie is played in Widescreen format, black bars at the top and bottom of the TV screen can be removed by pressing the **EZ VIEW** button.

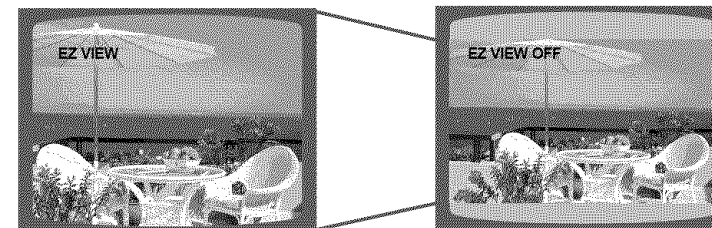

- Note**
- This function will not work if the DVD is recorded with multi-camera angle format.
 - Black bars may not disappear because some DVD discs have a built-in horizontal to vertical ratio.
 - This feature is not supported for DivX discs.

Bonus Group / Navigating Pages

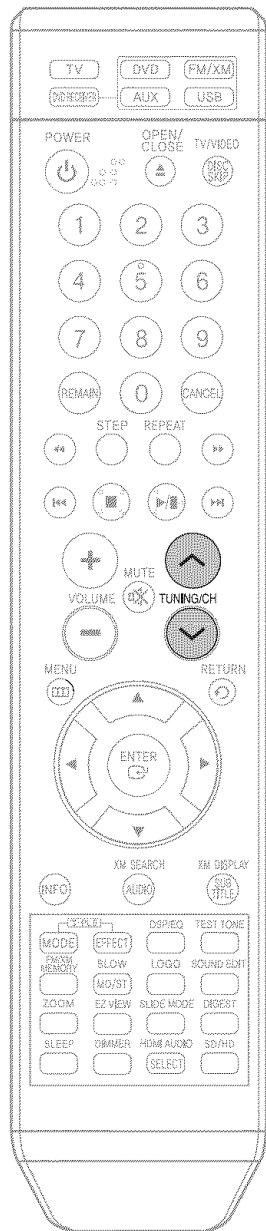

Bonus Group DVD-AUDIO

Some DVD-Audio discs have an extra 'bonus' group that requires a 4-digit key number to access. See the disc packaging for details and the key number.

When you play a DVD-Audio disc that has a bonus group, the key number input screen appears automatically.

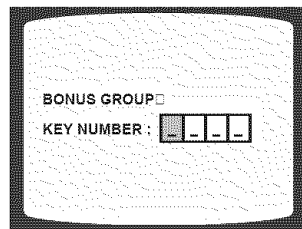

Note

- If you eject the disc, switch the power off, or unplug the player, you will need to re-enter the key number.

Navigating Pages DVD-AUDIO

During playback, press the **TUNING/CH** button on the remote control.

- You can select the desired image from a DVD-Audio disc containing still images.
- With some discs, you may not be able to select images.

Selecting Audio/Subtitle Language

Audio Language Selection Function DVD

1 Press **INFO** button twice.

2 Press Cursor **▲**, **▼** buttons or numeric buttons to select the desired audio language.

- Depending on the number of languages on a DVD disc, a different audio language (ENGLISH, SPANISH, FRENCH, etc.) is selected each time the button is pressed.

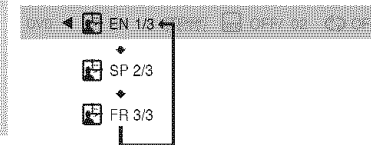

Subtitle Language Selection Function DVD

1 Press **INFO** button twice.

2 Press Cursor **▶** button to move to **SUBTITLE ()** display.



3 Press Cursor **▼** button or numeric buttons to select the desired subtitle.

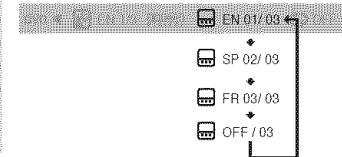

Note

- To operate this function, you can also press the Select AUDIO or Select SUBTITLE buttons on the remote control.
- Depending on the disc, the Subtitle and Audio Language functions may not be available.

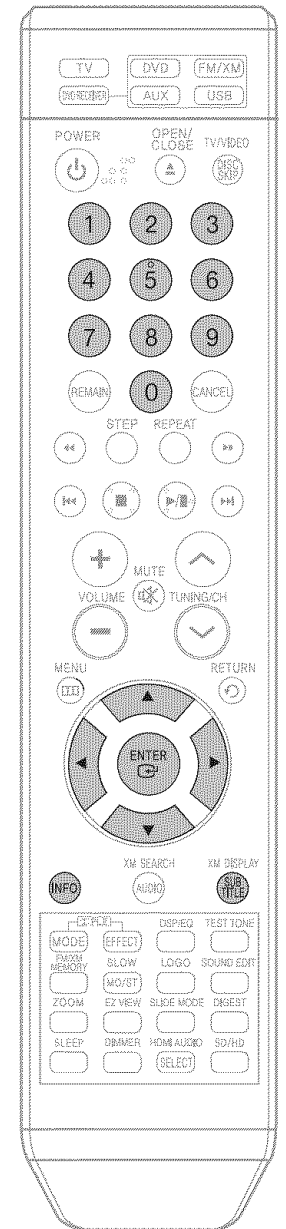

Playing Media Files using the USB HOST feature

You can enjoy media files such as pictures, movies and music saved in an MP3 player, USB memory or digital camera in high quality video with 5.1 channel home theater sound by connecting the storage device to the USB port of the home theater.

1 Connect the USB device to the USB port on the rear of the unit.

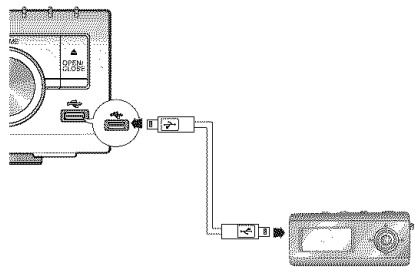

2 Press the **FUNCTION** button on the main unit or the **USB** button on the remote control to select the USB mode.

- "USB" appears on the display screen and then disappears.
- USB MENU screen appears on the TV screen and the saved file is played.

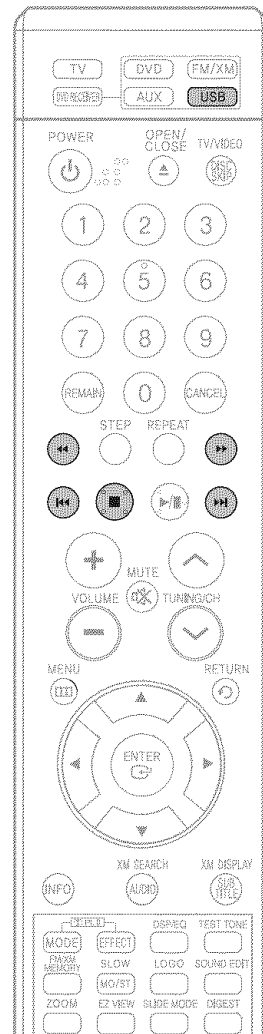
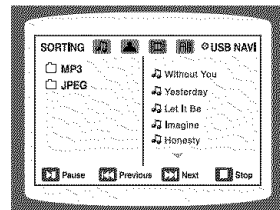

To stop playback, press the **STOP** (■) button.

Safe USB Removal

To prevent damage to the memory stored in the USB device, perform safe removal before disconnecting the USB cable.

- (1) Press the Stop button twice in a row.
The display will show **REMOVE → USB**.
- (2) Remove the USB cable.

Skip Forward/Back

During playback, press the **⏮⏭** button.

- When there is more than one file, when you press the **⏭** button, the next file is selected.
- When there is more than one file, when you press the **⏮** button, the previous file is selected.

Fast playback

To play back the disc at a faster speed, press **⏮** or **⏭** during playback.

- Each time you press either button, the playback speed will change as follows:
2x → 4x → 8x → 32x → Normal.

Compatible Devices

1. USB devices that support USB Mass Storage v1.0.
(USB devices that operate as a removable disk in Windows (2000 or later) without additional driver installation.)
2. MP3 Player: HDD and flash type MP3 players.
3. Digital camera: Cameras that support USB Mass Storage v1.0.
 - Cameras that operate as a removable disk in Windows (2000 or later) without additional driver installation.
4. USB HDD and USB Flash Drive: Devices that support USB2.0 or USB1.1.
 - You may experience a difference in playback quality when you connect a USB1.1 device.
 - For a USB HDD, make sure to connect an auxiliary power cord to the USB HDD for proper operation.
5. USB card Reader: One slot USB card reader and Multi slot USB card reader
 - Depending on the manufacturer, the USB card reader may not be supported.
 - If you install multiple memory devices into a multi card reader, you may experience problems.
6. If you use a USB extension cable, the USB device might not be recognized.

Supported Formats

	File name	File extension	Bit rate	Version	Pixel	Sampling Frequency
Still Picture	JPG	JPG, JPEG	—	—	640*480	—
Music	MP3	.MP3	80~384kbps	—	—	44.1kHz
	WMA	.WMA	56~128kbps	V8	—	44.1kHz
Movie	WMV	.WMV	4Mbps	V1,V2,V3,V7	720*480	44.1kHz~48kHz
	DivX	.AVI,.ASF	4Mbps	DivX3.11~DivX5.1,Xvid	720*480	44.1kHz~48kHz

- CBI (Control/Bulk/Interrupt) is not supported.
- Digital Cameras that use PTP protocol or require additional program installation when connected to a PC are not supported.
- A device using NTFS file system is not supported.
(Only FAT 16/32 (File Allocation Table 16/32) file system is supported.)
- Some MP3 players, when connected to this product, may not operate depending on the sector size of their file system.
- The USB HOST function is not supported if a product that transfers media files by its manufacturer-specific program is connected.
- Does not operate with Janus enabled MTP(Media Transfer Protocol) devices.
- **The USB host function of this product does not support all USB devices. For information on the supported devices, see pages 83.**

Moving Directly to a Scene/Song

DVD CD

1 Press **INFO** button.



Moving to a Title/Track

2 Press Cursor **▲**, **▼** buttons or numeric buttons to select the desired title/track and then press **ENTER** button.



Moving to a Chapter

3 Press Cursor **◀**, **▶** buttons to move to Chapter () display.



Moving to a Chapter

4 Press Cursor **▲**, **▼** buttons or numeric buttons to select the desired chapter and then press **ENTER** button.



Moving to a Specific Time

5 Press Cursor **◀**, **▶** buttons to move to time display.



Moving to a Specific Time

6 Press the numeric buttons to select the desired time and then press **ENTER** button.



MP3 JPEG

Press the **numeric** buttons.

- The selected file will be played.
- When playing an MP3 or JPEG disc, you cannot use **▲**, **▼** to move to a folder. To move a folder, press **■** (Stop) and then press **▲**, **▼**.

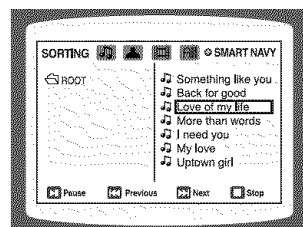

Note

- You can press **◀◀▶▶** on the remote control to move directly to the desired title, chapter, or track.
- Depending on the disc, you may not be able to move to the selected title or time.

Using Disc Menu DVD

You can use the menus for the audio language, subtitle language, profile, etc. DVD menu contents differ from disc to disc.

1 In Stop mode, press **MENU** button.



2 Press Cursor **▲**, **▼** buttons to move to 'DISC MENU' and then press **ENTER** button.



- When you select Disc Menu and it is not supported by the disc, the "This menu is not supported" message appears on the screen.

Note

- Disc menu display may be different depending on the disc.

3 Press Cursor **▲**, **▼**, **◀**, **▶** buttons to select the desired item.

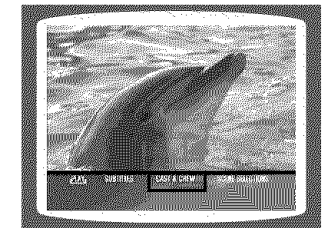

- Press **ENTER** button.

Using the Title Menu DVD

For DVDs containing multiple titles, you can view the title of each movie. Depending on the disc, the availability of this feature may vary.

1 In Stop mode, press **MENU** button.



2 Press Cursor **▲**, **▼** button to move to 'Title Menu'.

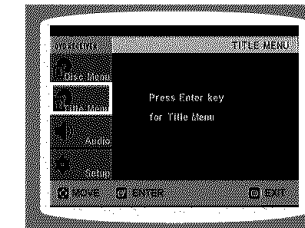

3 Press **ENTER** button.

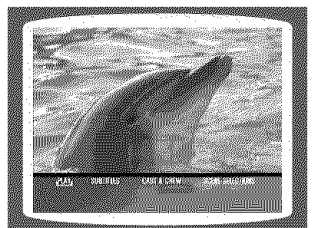

- The title menu appears.

Press **MENU** button to exit the setup screen.

Note

- Title menu display may be different depending on the disc.

Setting the Language

OSD (On-Screen Display) language is set to English by default.

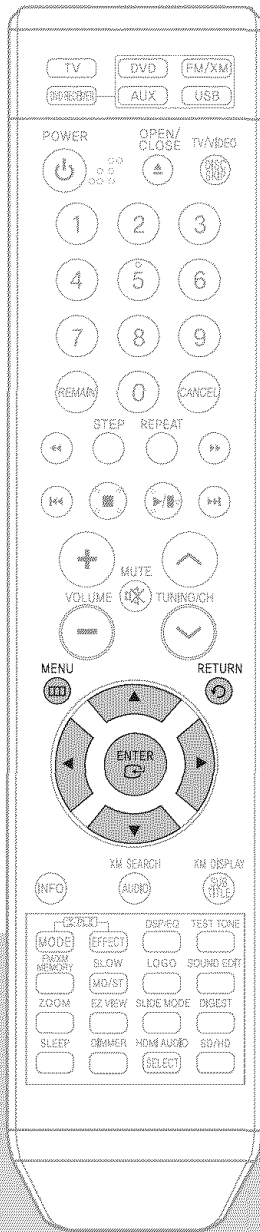

1 In Stop mode, press **MENU** button.



2 Press Cursor **▼** button to move to 'Setup' and then press **ENTER** button.

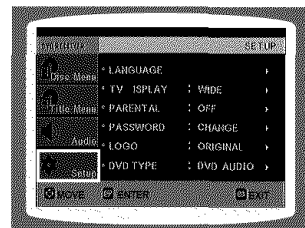

3 Select 'Language' and then press **ENTER** button

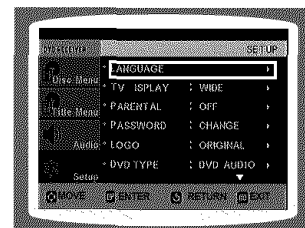

4 Press Cursor **▲, ▼** button to select 'OSD Language' and then press **ENTER** button.

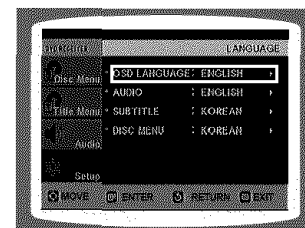

5 Press Cursor **▲, ▼** button to select the desired language and then press **ENTER** button.



- Once the setup is complete, the OSD will be English if English has been selected as language.

- Press **RETURN** button to return to the previous level.
- Press **MENU** button to exit the setup screen.

Note

• To select another language, select OTHER and enter the language code of your country. (See page 82 for language codes)
AUDIO, SUB TITLE and DISC MENU language can be selected.

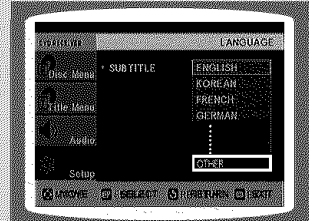

Selecting the OSD Language



Selecting the Audio Language (recorded on the disc)



Selecting the Subtitle Language (recorded on the disc)



Selecting the Disc Menu Language (recorded on the disc)

* If the language you selected is not recorded on the disc, menu language will not change even if you set it to your desired language.

SETUP

Setting TV Screen type

Depending on your TV type (Wide Screen or conventional 4:3), you can select the TV's aspect ratio.

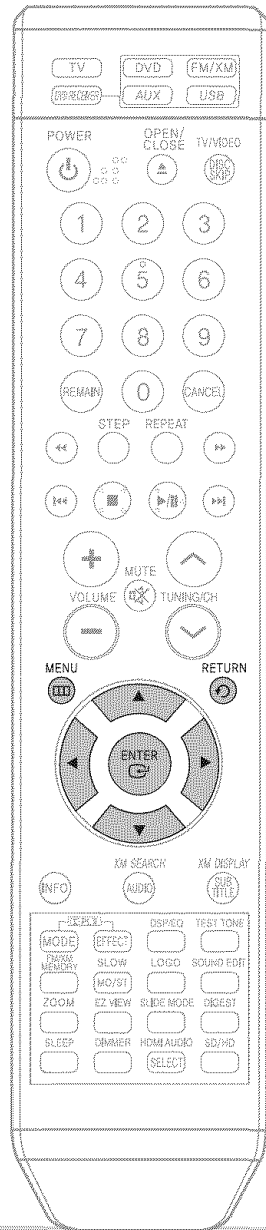

1 In Stop mode, press **MENU** button.

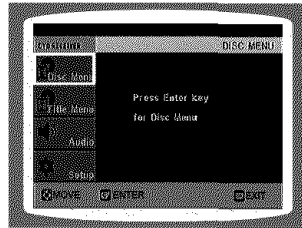

2 Press Cursor \blacktriangledown button to move to 'Setup' and then press **ENTER** button.

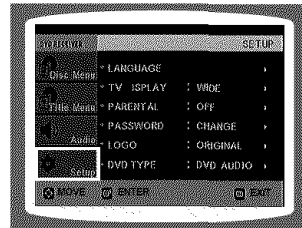

3 Press Cursor \blacktriangledown button to move to 'TV DISPLAY' and then press **ENTER** button.

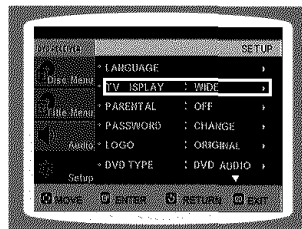

4 Press Cursor \blacktriangle , \blacktriangledown button to select the desired item and then press **ENTER** button.

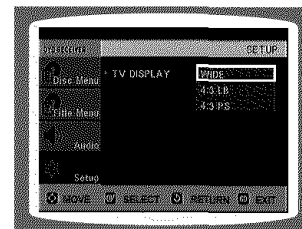

• Once the setup is complete, you will be taken to the previous screen.

Adj using the TV Aspect Ratio (Screen Size)

The horizontal to vertical screen size ratio of conventional TVs is 4:3, while that of widescreen and high definition TVs is 16:9. This ratio is called the aspect ratio. When playing DVDs recorded in different screen sizes, you should adjust the aspect ratio to fit your TV or monitor.

• For a standard TV, select either "4:3LB" or "4:3PS" option according to personal preference. Select "16:9" if you have a widescreen TV.

WIDE

: Select this to view a 16:9 picture in the full-screen mode on your widescreen TV.
• You can enjoy the widescreen aspect.



4:3LB (4:3 Letterbox)

: Select this to play a 16:9 picture in the letter box mode on a conventional TV.
• Black bars will appear at the top and bottom of the screen.



4:3PS (4:3 Pan&Scan)

: Select this to play a 16:9 picture in the pan & scan mode on a conventional TV.
• You can see the central portion of the screen only (with the sides of the 16:9 picture cut off).



Note

- If a DVD is in the 4:3 ratio, you cannot view it in widescreen.
- Since DVD discs are recorded in various image formats, they will look different depending on the software, the type of TV, and the TV aspect ratio setting.

Press **RETURN** button to return to the previous level.

Press **MENU** button to exit the setup screen.

Setting Parental Controls (Rating Level)

Use this to restrict playback of adult or violent DVDs you do not want children to view.

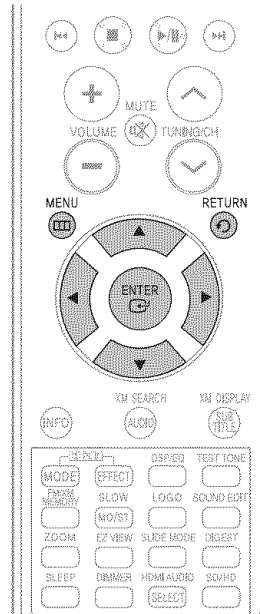

1 In Stop mode, press **MENU** button.

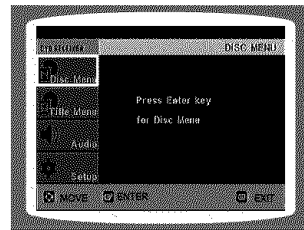

2 Press Cursor **▼** button to move to 'Setup' and then press **ENTER** button.

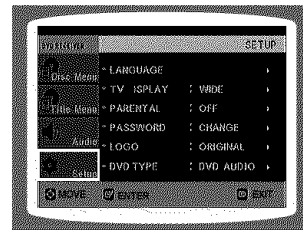

3 Press Cursor **▼** button to move to 'PARENTAL' and then press **ENTER** button.

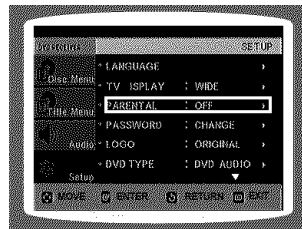

4 Press Cursor **▲, ▼** button to select the desired rating level and then press **ENTER** button.

- If you have selected Level 6, you cannot view DVDs with Level 7 or higher.
- The higher the level, the closer the content is to violent or adult material.

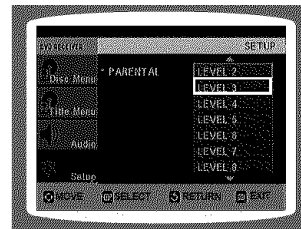

5 Enter the password and then press **ENTER** button.

- The password is set to "7890" by default.
- Once the setup is complete, you will be taken to the previous screen.

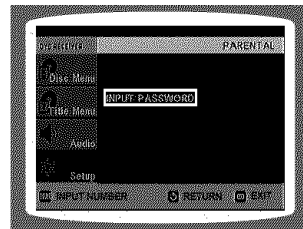

Note • This function works only if a DVD disc contains the rating level information.

Press **RETURN** button to return to the previous level.

Press **MENU** button to exit the setup screen.

Setting the Password

You can set the password for the Parental (rating level) setting.

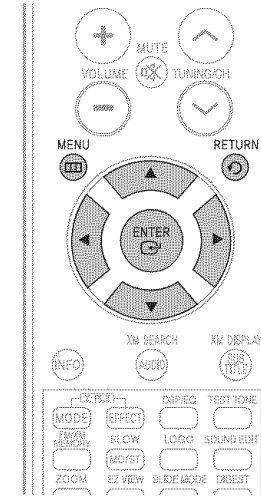

1 Press **MENU** button.



2 Press Cursor **▼** button to move to 'Setup' and then press **ENTER** button.

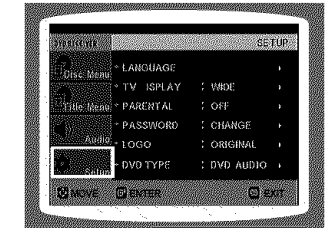

3 Press Cursor **▼** button to move to 'PASSWORD' and then press **ENTER** button.

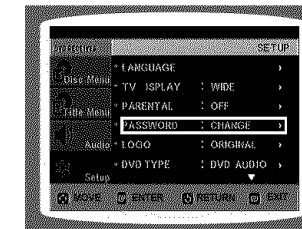

4 Press **ENTER** button.

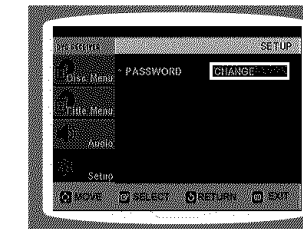

5 Enter the password and then press **ENTER** button.

- Enter the old password, a new password, and confirm new password.
- The setting is complete.

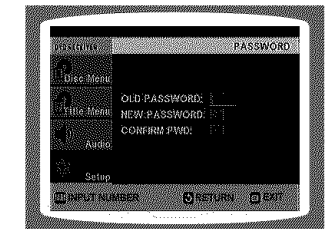

Note • The password is set to "7890" by default.

If you have forgotten the rating level password, do the following:

- While the player is in the no disc mode, hold the main unit's button for longer than 5 seconds. "INITIALIZE" appears on the display and all settings will return to the default values.
- Press the POWER button.

Using the **RESET** function will erase all stored settings. Do not use this unless necessary.

Setting the Wallpaper

JPEG DVD

While watching a DVD or JPEG CD, you can set the image you like as background wallpaper.

Setting the Wallpaper

1 During playback, press **PLAY/PAUSE** button when an image you like appears.

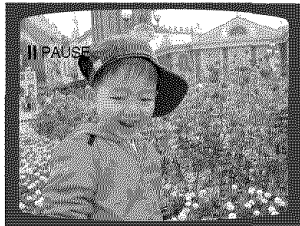

2 Press **LOGO** button.

- "COPY LOGO DATA" will be displayed on the TV screen.

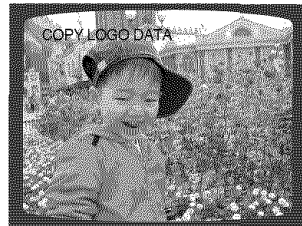

3 The power will turn off and then back on.

- The selected wallpaper will be displayed.
- You can select up to 3 wallpaper settings.

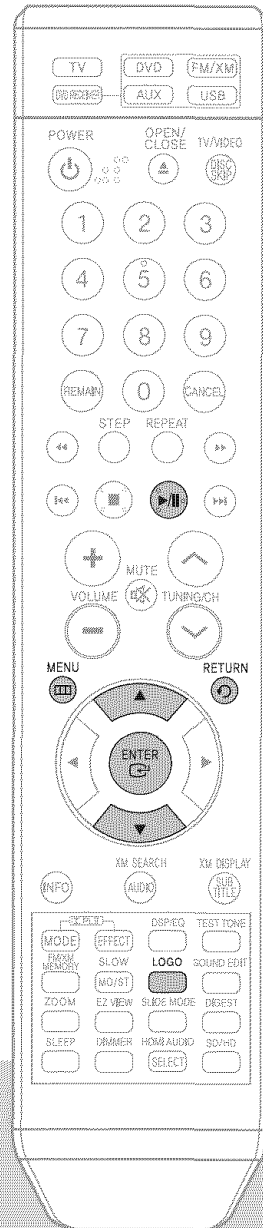

To select one of the 3 wallpaper settings you've made

1 In Stop mode, press **MENU** button.



2 Press Cursor \blacktriangledown button to move to 'Setup' and then press **ENTER** button.

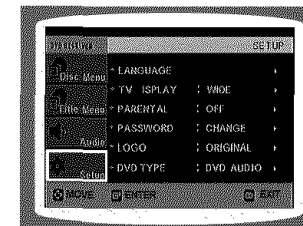

3 Press Cursor \blacktriangledown button to move to 'LOGO' and then press **ENTER** button.

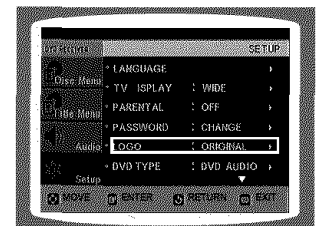

4 Press \blacktriangledown to select the desired 'USER', and then press **ENTER**.

- This selects one of the 3 wallpaper screens



5 Press **MENU** button to exit the setup screen.

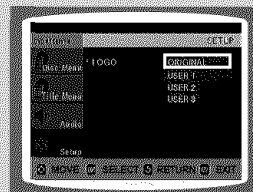

Select this to set the Samsung Logo image as your wallpaper.



Select this to set the desired image as your wallpaper.

Press **RETURN** button to return to the previous level.

Press **MENU** button to exit the setup screen.

DVD Playback Mode

Some DVD-Audio discs contain DVD-Video as well as DVD-Audio. To play back the DVD-Video portion of the DVD-Audio disc, set the unit to DVD-Video mode.

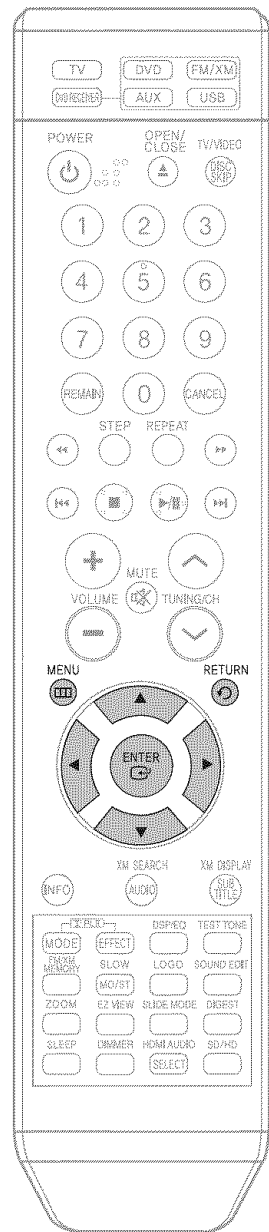

1 Press the **MENU** button while the disc tray is open.



2 Press Cursor \blacktriangledown button to move to 'Setup' and then press **ENTER** button.

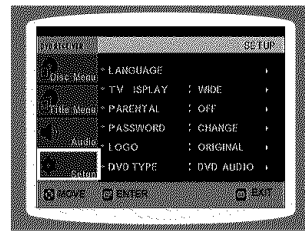

3 Press Cursor \blacktriangledown button to move to 'DVD TYPE' and then press **ENTER** button.

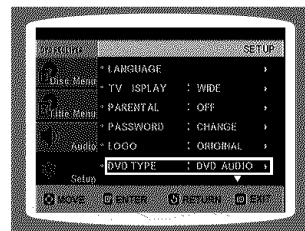

4 Press Cursor \blacktriangle , \blacktriangledown button to move to 'DVD VIDEO' and then press **ENTER** button.



• Set steps 1 ~ 4 again if you want to switch to DVD AUDIO Play mode.

When Selecting DVD Play Mode:

- **DVD VIDEO** : set to play the DVD video contents contained on a DVD audio disc.
- **DVD AUDIO** : set to play the default DVD audio.

Note

- DVD Play mode is set to DVD Audio as factory default setting.
- Powering off the main unit will automatically switch to the DVD Audio mode.

DivX (R) registration

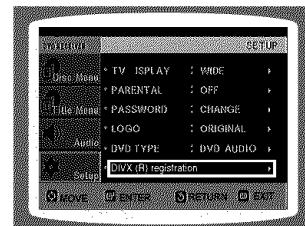

- Please use the Registration code to register this player with the DivX (R) video on demand format. To learn more, go to www.divx.com/vod.

Setting the Speaker Mode

Signal outputs and frequency responses from the speakers will automatically be adjusted according to your speaker configuration and whether certain speakers are used or not.

1 In Stop mode, press **MENU** button.



2 Press Cursor \blacktriangledown button to move to 'Audio' and then press **ENTER** button.

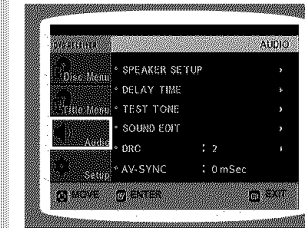

3 In the Speaker Setup, press the **ENTER** button again.

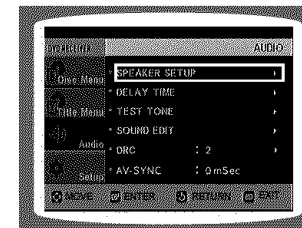

4 Press Cursor \blacktriangle , \blacktriangledown , \blacktriangleleft , \blacktriangleright buttons to move to the desired speaker and then press **ENTER** button.

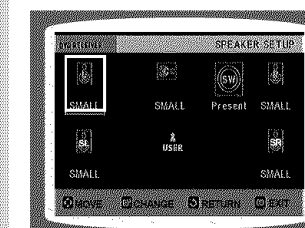

- For C, SL, and SR, each time the button is pressed, the mode switches alternately as follows: SMALL \rightarrow NONE.
- For L and R, the mode is set to SMALL.

SMALL : Select this when using the speakers.

NONE : Select this when no speakers are connected.

Note

- Depending on PRO LOGIC and STEREO settings, the speaker mode may vary (see page 65).

Setting the Delay Time

If the speakers cannot be placed at equal distances from the listening position, you can adjust the delay time of the audio signals from the center and rear speakers.

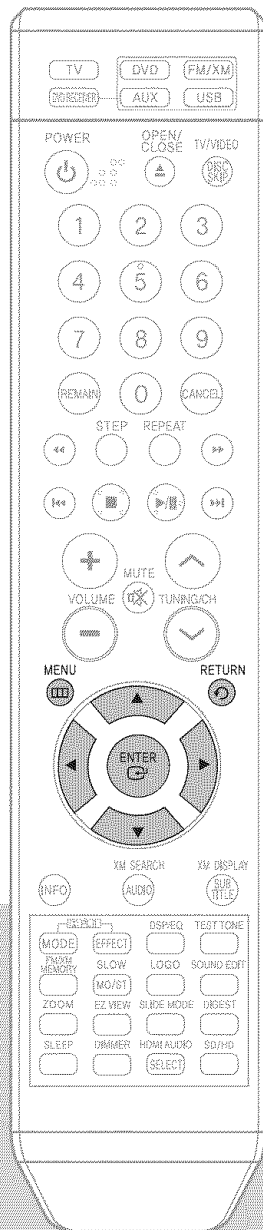

1 In Stop mode, press **MENU** button.



2 Press Cursor \blacktriangledown button to move to 'Audio' and then press **ENTER** button.

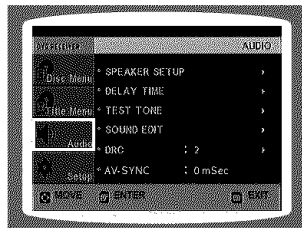

3 Press Cursor \blacktriangledown button to move to 'DELAY TIME' and then press **ENTER** button.

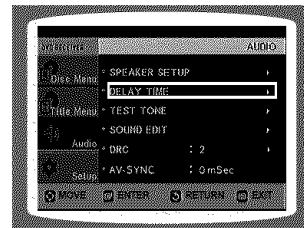

4 Press Cursor \blacktriangle , \blacktriangledown , \blacktriangleleft , \blacktriangleright buttons to move to the desired speaker and then press **ENTER** button.

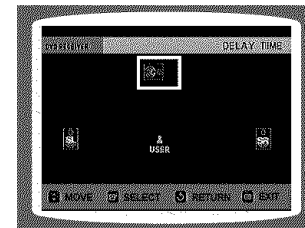

5 Press Cursor \blacktriangleleft , \blacktriangleright to set the Delay time.

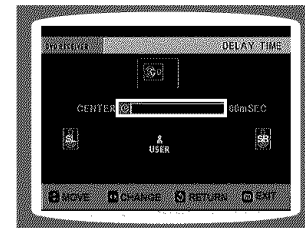

- You can set the delay time for C between 00 and 05mSEC and for SL and SR between 00 and 15mSEC.

Setting up the Speaker Delay Time

When 5.1CH Surround Sound is played, you can enjoy the best sound if the distance between you and each speaker is the same. Since the sounds arrive at the listening position at different times depending on the placement of speakers, you can adjust this difference by adding a delay effect to the sound of the Center and Surround Speakers.

Note

- With \square PL (Dolby Pro Logic II), the delay time may be different for each mode.
- With AC-3 and DTS, the delay time can be set between 00 and 15mSEC.
- The Center channel is only adjustable on 5.1 channel discs.

Setting CENTER SPEAKER

If the distance of Dc is equal to or longer than the distance of Df in the figure, set the mode as 0ms. Otherwise, change the setting according to the table.

Distance between Df and Dc	Delay Time
0 inch	0 ms
13.6 inches	1 ms
27.2 inches	2 ms
40.8 inches	3 ms
4.5 feet	4 ms
5.6 feet	5 ms

Setting REAR (SURROUND) SPEAKERS

If the distance of Df is equal to the distance of Ds in the figure, set the mode as 0ms. Otherwise, change the setting according to the table.

Distance between Df and Ds	Delay Time
0 inch	0 ms
40.8 inches	3 ms
6.7 feet	6 ms
10.0 feet	9 ms
13.4 feet	12 ms
16.7 feet	15 ms

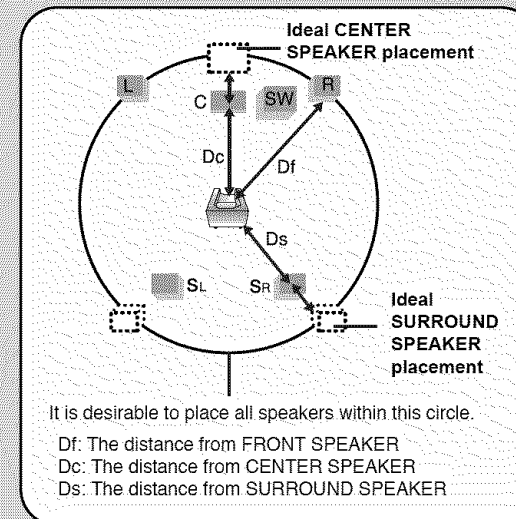

Setting the Test Tone

Use the Test Tone feature to check the speaker connections.

1 In Stop or no disc mode, press **MENU** button.



2 Press Cursor \blacktriangledown button to move to 'Audio' and then press **ENTER** button.

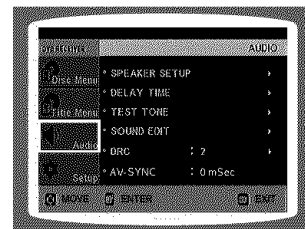

3 Press Cursor \blacktriangledown button to move to 'TEST TONE' and then press **ENTER** button.

- The test tone will be sent to L \rightarrow C \rightarrow R \rightarrow SR \rightarrow SL \rightarrow SW in order. If the ENTER button is pressed again at this time, the test tone will stop.

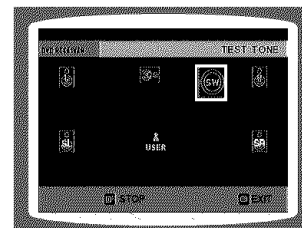
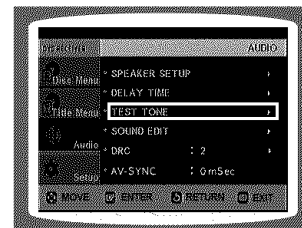

Press **RETURN** button to return to the previous level.

Press **MENU** button to exit the setup screen.

Alternate method: press the **TEST TONE** button on the remote.

Press **TEST TONE** button.

- Test tone will be produced as follows:
When playing a DVD or CD, this will work only in Stop mode.
- Use this function to check that each speaker is correctly connected and that there is no problem.
- When there is no input signal from the HDMI IN function, the Test Tone will not work.

To end the test tone, press **TEST TONE** button again.

L: Front Speaker (L) C: Center Speaker SW: Subwoofer
R: Front Speaker (R) SL: Rear Speaker (L) SR: Rear Speaker (R)

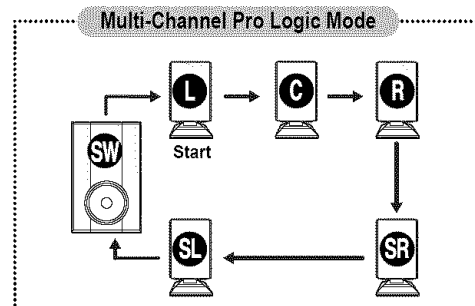

Setting the DRC (Dynamic Range Compression)

ENG

This feature balances the range between the loudest and quietest sounds. You can use this function to enjoy Dolby Digital sound when watching movies at low volume at night.

1 In Stop or no disc mode, press **MENU** button.



2 Press Cursor \blacktriangledown button to move to 'Audio' and then press **ENTER** button.

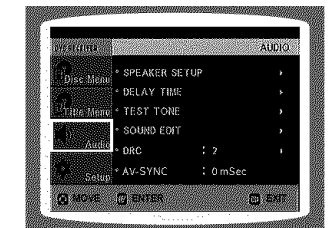

3 Press Cursor \blacktriangledown button to move to 'DRC' and then press **ENTER** button.

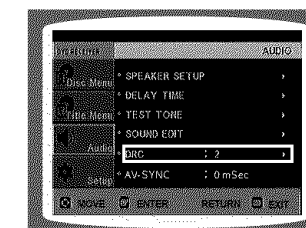

4 Press Cursor \blacktriangle , \blacktriangledown to adjust the 'DRC'.

- When the Cursor \blacktriangle button is pressed, the effect is greater, and when the Cursor \blacktriangledown button is pressed, the effect is smaller.

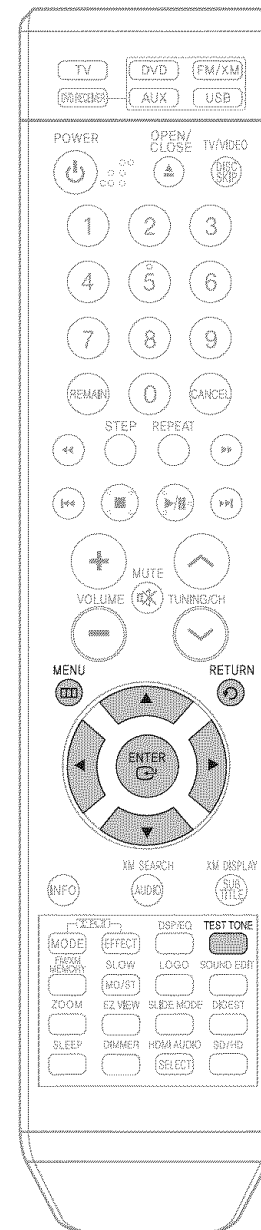
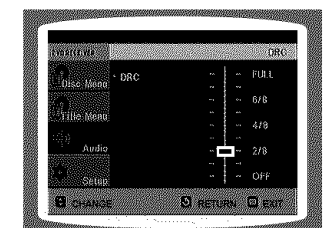

Press **RETURN** button to return to the previous level.

Press **MENU** button to exit the setup screen.

SETUP

Setting the Audio

You can adjust the balance and level for each speaker.



Method 1 When adjusting the audio quality using the setup screen

1 In Stop mode, press **MENU** button.

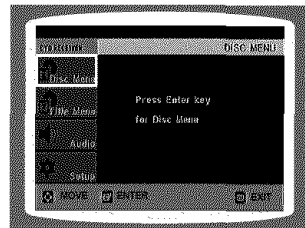

2 Press Cursor \blacktriangledown button to move to 'Audio' and then press **ENTER** button.

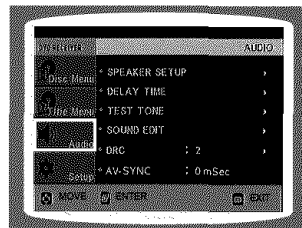

3 Press Cursor \blacktriangledown button to move to 'SOUND EDIT' and then press **ENTER** button.

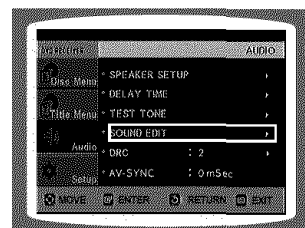

4 Press Cursor \blacktriangle , \blacktriangledown buttons to select and adjust the desired item. Press the \blacktriangleleft , \blacktriangleright buttons to adjust the settings.

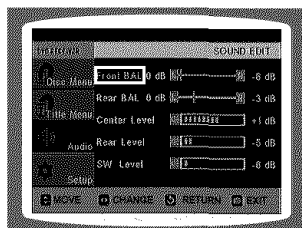

Method 2 When manually adjusting with the SOUND EDIT button

Adj using Front Speaker Balance

1 Press **SOUND EDIT** button and then press Cursor \blacktriangleleft , \blacktriangleright .

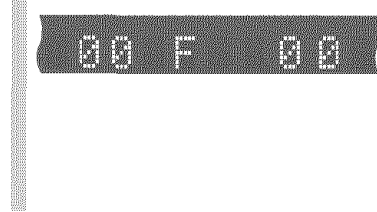

Adj using Rear Speaker Balance

2 Press **SOUND EDIT** button and then press Cursor \blacktriangleleft , \blacktriangleright .

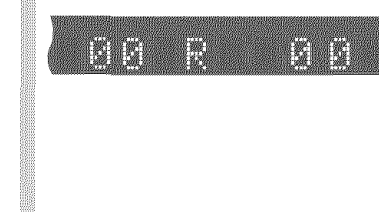

Adj using Center Speaker Level

3 Press **SOUND EDIT** button and then press Cursor \blacktriangleleft , \blacktriangleright .

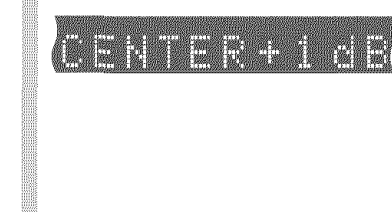

Adj using Rear Speaker Level

4 Press **SOUND EDIT** button and then press Cursor \blacktriangleleft , \blacktriangleright .

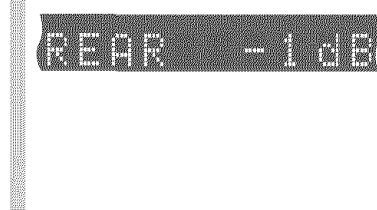

Adj using Subwoofer Speaker Level

5 Press **SOUND EDIT** button and then press Cursor \blacktriangleleft , \blacktriangleright .

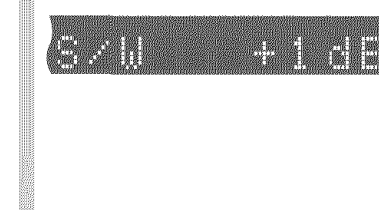

Press **RETURN** button to return to the previous level.

Press **MENU** button to exit the setup screen.

Note

- Adj using Front/Rear Speaker Balance**
 - You can select between 00 and -06 and OFF.
 - The volume decreases as you move closer to -6.
- Adj using Center/Rear/Subwoofer Speaker Level**
 - The volume level can be adjusted in steps from +6dB to -6dB.
 - The sound gets louder as you move closer to +6dB and quieter as you get closer to -6dB.

AV SYNC Setup

Video may look slower than the audio if it is connected to a digital TV. If this occurs, adjust the audio delay time to match the video.

1 Press the **MENU** button.

- Setup menu appears.



2 Press Cursor **▲**, **▼** buttons to move to 'Audio' and then press **ENTER** button.

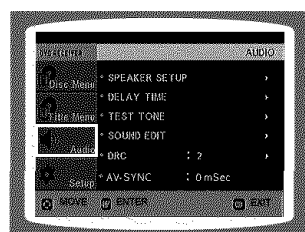

3 Press Cursor **▲**, **▼** buttons to move to 'AV-SYNC' and then press **ENTER** button.

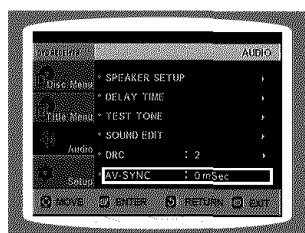

4 Press Cursor **▲**, **▼** buttons to select the AV-SYNC Delay Time and then press the **ENTER** button.

- You can set the audio delay time between 0 ms and 300 ms. Set it to the optimal status.

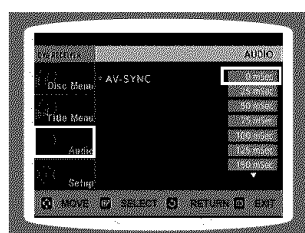

Press **RETURN** button to return to the previous level.

Press **MENU** button to exit the setup screen.

Sound Field (DSP)/EQ Function

DSP(Digital Signal Processor) DSP modes have been designed to simulate different acoustic environments. EQ: You can select ROCK, POP, or CLASSIC to optimize the sound for the genre of music you are playing

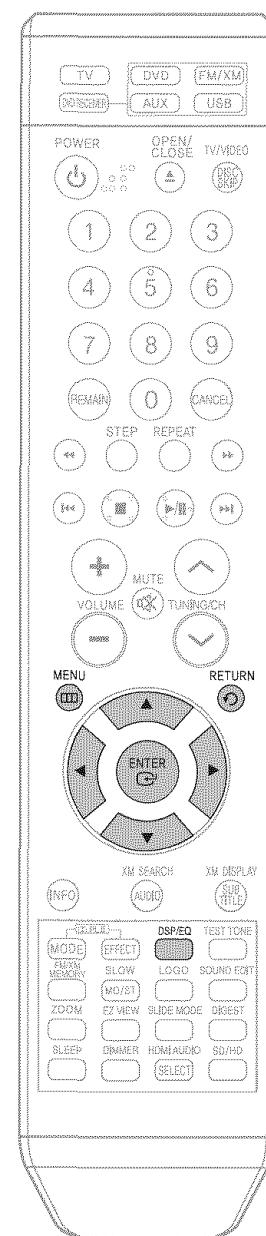

Press **DSP/EQ** button.

- "DSP" appears on the display panel.
- Each time the button is pressed, the selection changes as follows:

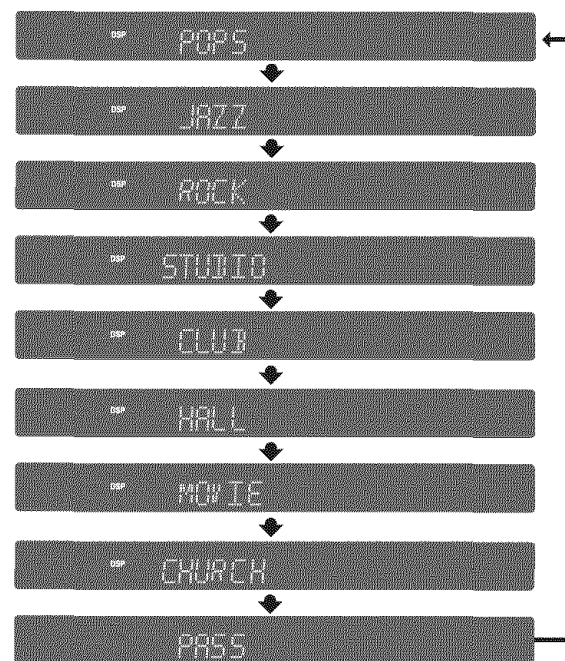

- Note**
- DSP/EQ function is only available in STEREO mode. Press the **PL II** mode button to show STEREO on the display.
 - This feature works with CDs, MP3-CDs, 2 channel DVD-Audio, DivX and Dolby Digital discs.
 - When playing a DVD disc encoded with two or more channels, multi-channel mode will be selected automatically and DSP/EQ function does not work.

- POP, JAZZ, ROCK:** Depending on the genre of music, you can select POP, JAZZ, and ROCK.
- STUDIO:** Provides a sense of presence as if in a studio.
- CLUB:** Simulates the sound of a dance club with a throbbing bass beat.
- HALL:** Provides a clear vocal as if listening in a concert hall.
- MOVIE:** Provides the feeling of a movie theater.
- CHURCH:** Gives the feel of being in a grand church.
- PASS:** Select this for normal listening.

Dolby Pro Logic II Mode

You can select the desired Dolby Pro Logic II audio mode.

Press **PL II MODE** button.

- Each time the button is pressed, the mode changes as follows.

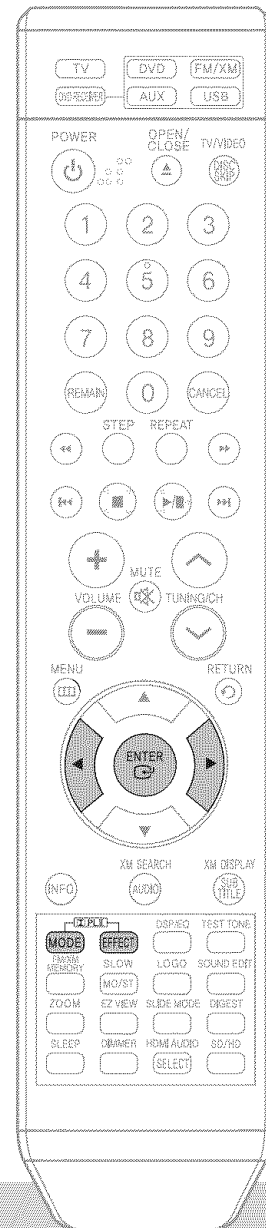
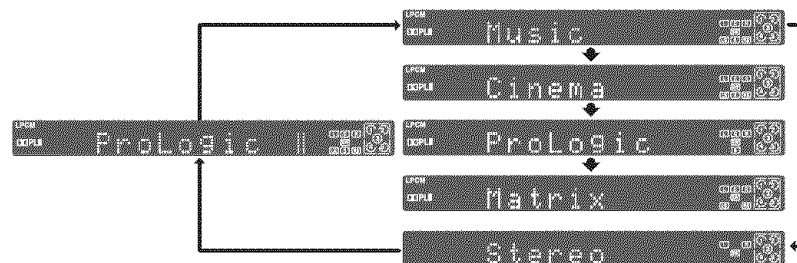

Note

- When selecting Pro Logic II mode, connect your external device to the AUDIO INPUT jacks (L and R) on the player. If you connect to only one of the inputs (L or R), you cannot listen to surround sound.

PRO LOGIC II

- **MUSIC:** When listening to music, you can experience sound effects as if you are listening to the actual performance.
- **CINEMA:** Adds realism to the movie soundtrack.
- **PRO LOGIC:** You will experience a realistic multi-channel effect, as if using five speakers, while using just the front left and right speakers.
- **MATRIX:** You will hear 5.1 channel surround sound.
- STEREO:** Select this to listen to sound from the front left and right speakers and the subwoofer only.

Dolby Pro Logic II Effect

This function works only in Dolby Pro Logic MUSIC mode.

1 Press **PL II MODE** button to select 'MUSIC' mode.



2 Press **PL II EFFECT** button to select Panorama, then press Cursor **◀, ▶** buttons to select the desired effect setting.

- You can select either 0 or 1.
- This mode extends the front stereo image to include the surround speakers for an exciting "wraparound" effect with side wall imaging.



3 Press **PL II EFFECT** button to select C-Width, then press Cursor **◀, ▶** buttons to select the desired effect setting.

- You can select between 0 and 7.
- This sets the width of the center image. The higher the setting, the less sound comes from the center speaker.



4 Press **PL II EFFECT** button to select Dimension, then press the Cursor **◀, ▶** buttons to select the desired setting.

- You can select between 0 and 6.
- Incrementally adjusts the sound field (DSP) from the front or rear.



Note

- When playing a DVD disc encoded with two or more channels, multi-channel mode will be selected automatically and **PL II** (Dolby Pro Logic II) button does not work.

Listening to Radio

Remote Control Unit

1 Press the **FM/XM** button and select the FM band.

2 Tune in to the desired station.

Automatic Tuning 1 When **◀▶▶▶** is pressed, a preset broadcast station is selected.

Automatic Tuning 2 Press and hold **TUNING/CH** to automatically search for active broadcasting stations.

Manual Tuning Briefly press **TUNING/CH** to increase or decrease the frequency incrementally.

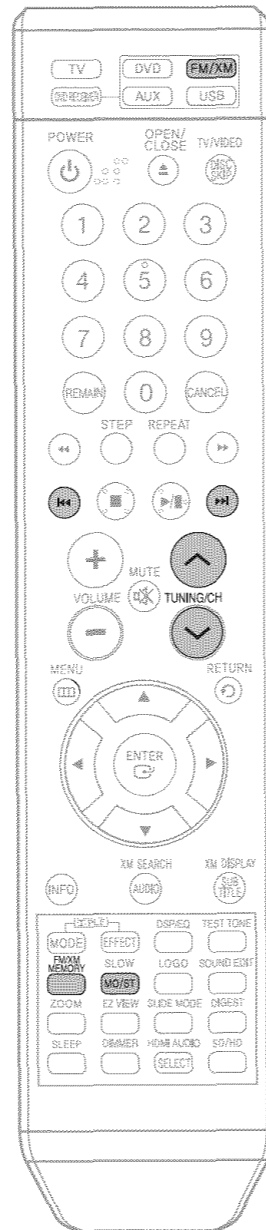

Main Unit

1 Press the **FUNCTION** button to select the FM band.

2 Select a broadcast station.

Automatic Tuning 1 Press the **STOP** (■) button to select PRESET and then press **◀▶▶▶** button to select the preset station.

Automatic Tuning 2 Press the **STOP** (■) button to select "MANUAL" and then press and hold **◀▶▶▶** button to automatically search the band.

Manual Tuning Press **STOP** (■) to select MANUAL and then briefly press **◀▶▶▶** to tune in to a lower or higher frequency.

Presetting Stations

Example: Presetting FM 89.1 in the memory

1 Press the **FM/XM** button and select the FM band.

FM 91.90

2 Press **TUNING/CH** to select "89.10".

- Refer to Step 2 on page 67 to automatically or manually tune in to a station.

FM 89.10

3 Press the **FM/XM MEMORY** button.

- "PRGM" flashes in the display.

PRGM FM 89.10

4 Press **◀▶▶▶** to select preset number.

- You can select between 1 and 15 presets.

PRGM FM 89.10

5 Press the **FM/XM MEMORY** button again.

- Press the **FM/XM MEMORY** button before 'PRGM' disappears from the display.
- 'PRGM' disappears from the display and the station is stored in memory.

FM 89.10

6 To preset another station, repeat steps 2 to 5.

Note • This unit does not receive AM broadcasts.

Press **MO/ST** button to listen in Mono/Stereo.
(This applies only when listening to an FM station.)

- Each time the button is pressed, the sound switches between "STEREO" and "MONO".
- In a poor reception area, select MONO for a clear, interference-free broadcast.

To tune in to a preset station, press **◀▶▶▶** on the remote control to select a channel.

Before Using XM Satellite Radio

What is XM satellite Radio?

XM Satellite Radio is the satellite radio service with millions of listeners across the U.S., broadcasting live daily. XM's channel lineup includes more than 160 digital channels of choice from coast to coast: 68 commercial-free music channels, featuring hip hop to opera, classical to country, bluegrass to blues; 33 channels of premier sports, talk, comedy, children's and entertainment programming; and more than 20 channels of the traffic and weather information for major metropolitan areas nationwide.

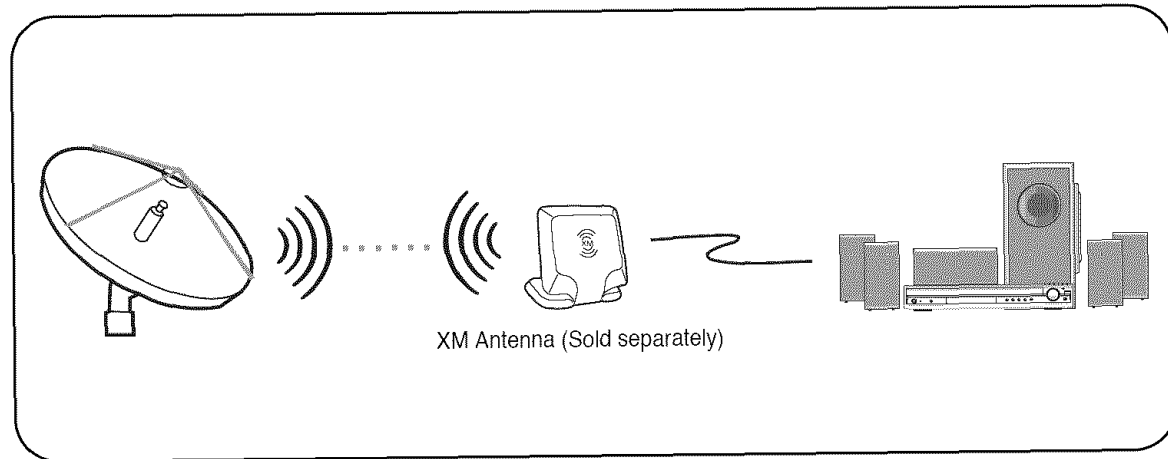

XM Antenna (Sold separately)

Notes

- The XM Satellite Radio service is only available in the 48 contiguous United States (not available in Alaska and Hawaii).
- XM Antenna and monthly subscription are sold separately. For details, see the XM Satellite Radio website at "<http://www.xmradio.com>"
- To ensure optimal reception of XM's satellite signal, the XM Antenna should be placed at or near a southerly facing window with nothing obstructing its path to the sky. You can mount it indoors or outdoors.

Listening to XM Satellite Radio

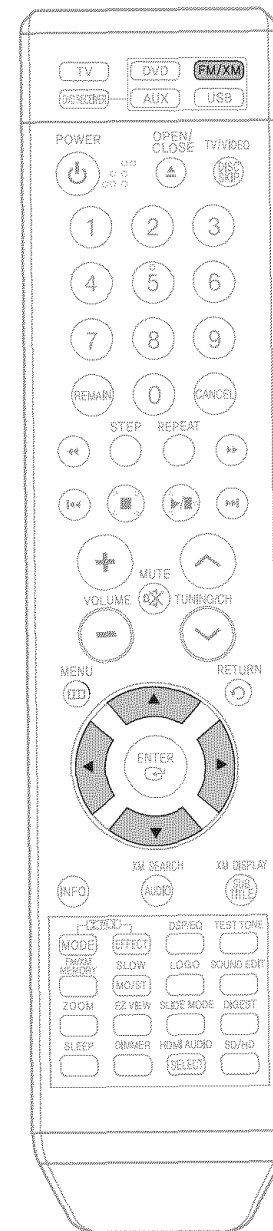

1 Press the **FM/XM** button (or **FUNCTION** button on the main unit) and select the **XM** band.

- Each time the FM/XM button is pressed, the band switches between "FM → XM".

10201 Na

2 Press **◀, ▶** button to select the channel, press **▲, ▼** button to select the category.

- You can select the channel directly by pressing the number buttons (1 to 255).

Note

- If "CHECK ANTENNA" appears in the display, the XM Antenna may not be connected to the XM Antenna Connector on the rear of this unit properly.
- When the selected channel is not available, "CH---" is displayed.

XM Display Mode

The XM features described here only operate when the optional XM antenna is connected to the main unit.

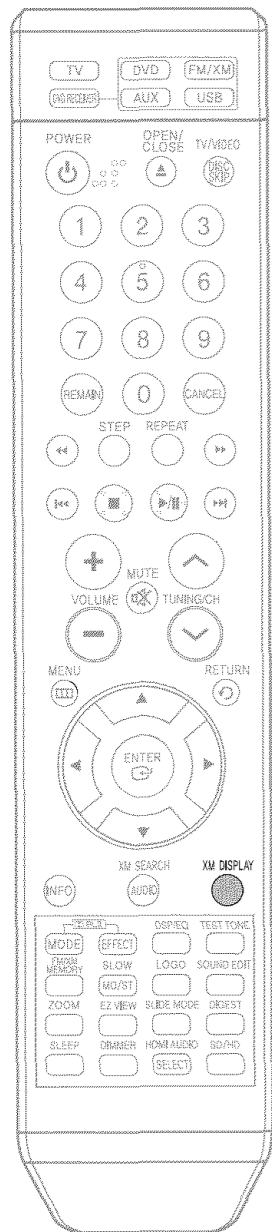

Press the **XM DISPLAY** button.

- Each time the XM DISPLAY button is pressed, the mode changes as follows:

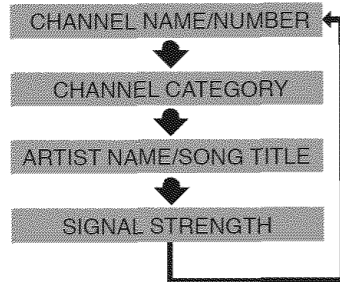

- When the Channel Name/Number is displayed :

[020] Na

- When the Channel Category is displayed :

<CAT>

- When the Artist Name/Song Title is displayed :

Chuck Berr

- When the Signal Strength is displayed :

GOOD

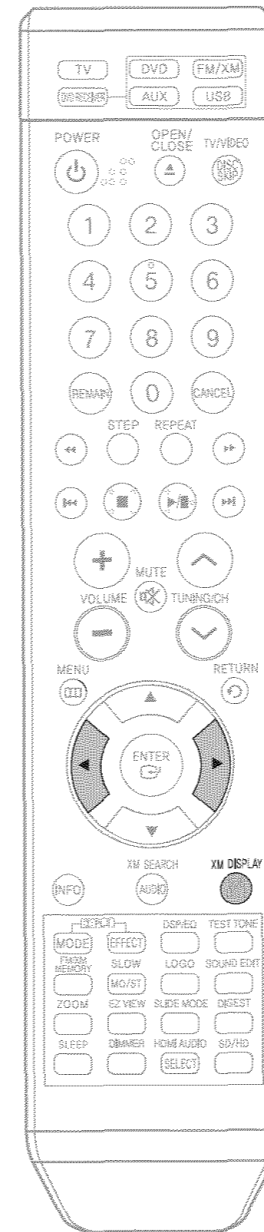

Checking the XM signal strength

Press the **XM DISPLAY** button until “Signal” is displayed.

- The display changes as shown below according to the receiving condition.

Display	Condition
GOOD	Signal strength is good
MARGINAL	Signal strength is marginal
WEAK	Signal strength is poor
NO	Loss of signal

Checking the Radio ID

Press the ◀, ▶ button (or ◀◀▶▶ button on the main unit) to select channel “o”.

- The Radio ID is displayed. The ID below is just an example.

JH7X504Y

Notes

- The front panel display can indicate up to 10 alphanumeric characters at once. If the information contains more than 10 characters, the information scrolls from right to left.
- If the information contains a character that cannot be recognized by the unit, the character will be displayed with an underbar “ * ”.

Note

- To sign up for an account with the XM Satellite Radio service, an XM Satellite Radio ID number is required. Follow the procedure above to check your ID number, and then access the website at “<http://activate.xmradio.com>” or call “1-800-XM-RADIO(1-800-967-2346)” with a major credit card to sign up.

XM Search Mode

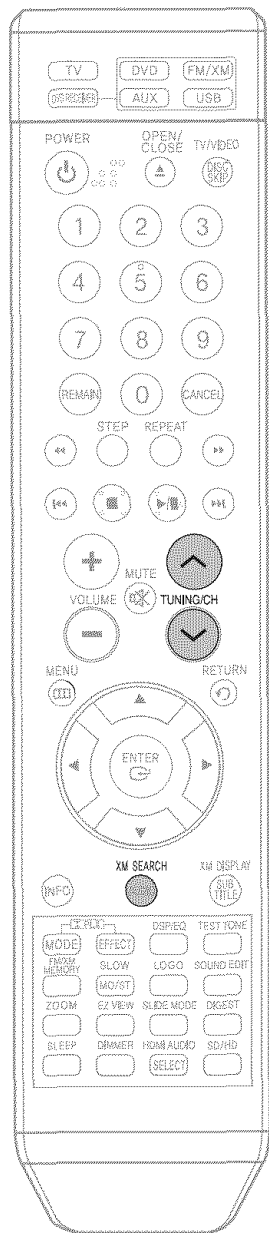

Press the **XM SEARCH** button.

- Each time the XM SEARCH button is pressed, the mode changes as follows:

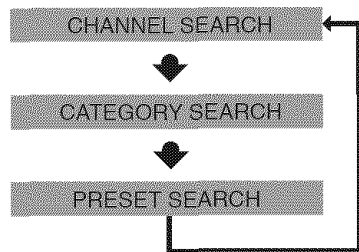

- Channel Search Mode : Press **TUNING/CH** (or **◀▶▶▶** button on the main unit) to move to the desired channel.

CH Search

- Category Search Mode : Press **TUNING/CH** (or **◀▶▶▶** button on the main unit) to select the channel within the selected category.

CAT Search

- Preset Search Mode : Press **TUNING/CH** (or **◀▶▶▶** button on the main unit) to select the channel within the memorized channels.

PRS Search

Presetting XM Satellite Radio

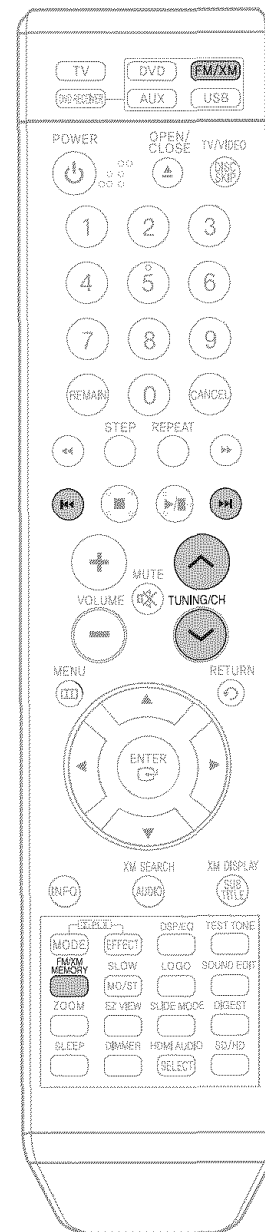

1 Press the **FM/XM** button (or **FUNCTION** button on the main unit) and select the XM band.

- Each time the FM/XM button is pressed, the band switches between "FM → XM"

2 search the XM Satellite Radio channel you want to set as a preset channel.

- When the channel number '20' is selected.

[020]

3 Press the **FM/XM MEMORY** button.

- "PRGM" flashes in the display.

PRGM [01] [020]

4 Press **◀▶▶▶** to select preset number.

- You can select between 1 and 15.

PRGM [02] [020]

5 Press the **FM/XM MEMORY** button again.

- Press the **FM/XM MEMORY** button before 'PRGM' disappears from the display.
- 'PRGM' disappears from the display and the station is stored in memory.

[020]

6 To preset another station, repeat steps 2 to 5.

- You can select between 1 and 15

Note • Up to 15 stations can be saved in memory. If you save more than 15 stations, the oldest station previously saved is removed and a new station is stored in its place.

Convenient Functions

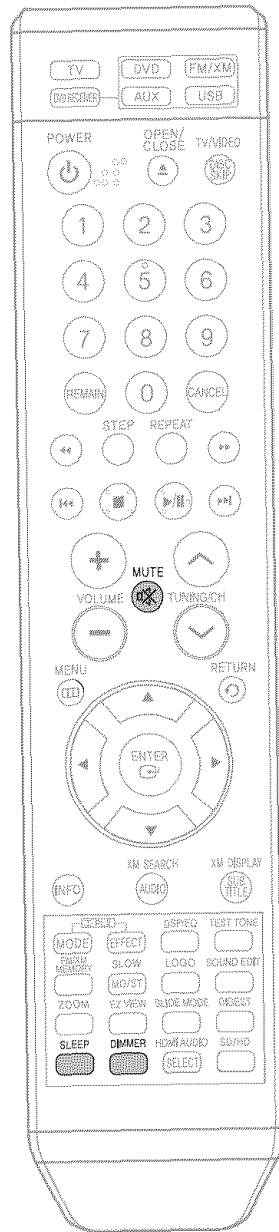

Sleep Timer Function

You can set the time that the Home Theater will shut itself off.

Press **SLEEP** button.

- "SLEEP" will be displayed. Each time the button is pressed, the preset time changes as follows: 10 → 20 → 30 → 60 → 90 → 120 → 150 → OFF.

SLEEP 10

To confirm the sleep timer setting, press **SLEEP** button.

- The remaining time before the Home Theater will shut itself off is displayed.
- Pressing the button again changes the sleep time from what you have set earlier.

To cancel the sleep timer, press **SLEEP** button until OFF appears on the display.

Adjusting Display Brightness

You can adjust the brightness of the display on the main unit so it won't interfere with your movie viewing.

Press **DIMMER** button.

- Each time the button is pressed, the brightness changes as follows: DARK → BRIGHT.

Mute Function

This is useful when answering a doorbell or telephone call.

Press **MUTE** button.

- 'MUTE ON' appears in the display.
- To restore the sound, press the button again to select 'MUTE OFF'.

MUTE ON

Using Headphones

Use headphones (not supplied) for private listening pleasure.

Connect the headphones to the PHONES jack for private listening.

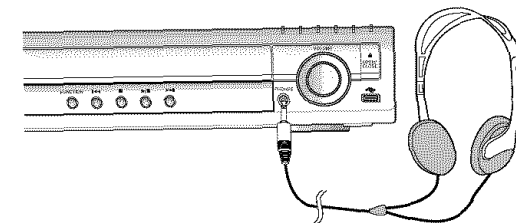

Caution

- To prevent hearing damage, do not increase the volume excessively when using headphones.

Operating a TV with the Remote Control

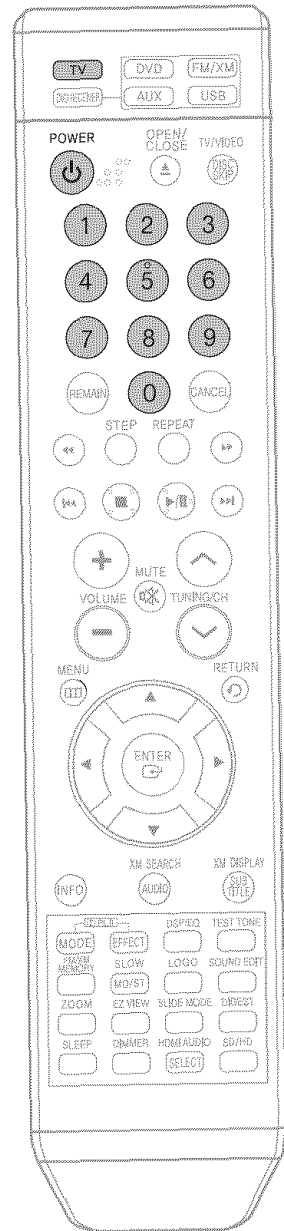

When operating a TV with the remote control

1 Press **TV** button to select TV mode.

2 Press **POWER** button to turn on the TV.

3 Point the remote control toward the TV.

4 While holding down **POWER**, enter the code corresponding to your brand of TV.

- If the code matches the TV's code, the TV will be turned off.
- If there is more than one code listed for your TV in the table, enter one at a time to determine which code works.

Example: For a Samsung TV

While holding down **POWER**, use the number buttons to enter 00, 01, 02, 03, 04, and 05.

5 Point the remote control toward the TV and press **POWER**. If the TV turns off or on, the setting is complete.

- You can use the TV **POWER**, **VOLUME**, **CHANNEL**, and **Numeric** buttons (0~9).

Note

- The remote control may not work on some brands of TVs. Also, some operations may not be possible depending on your brand of TV.
- If you do not set the remote control with the code for your brand of TV, the remote control will work on a Samsung TV by default.



TV Brand Code List

No.	Brand	Code	No.	Brand	Code
1	Admiral (M.Wards)	056, 057, 058	44	MTC	018
2	A Mark	001, 015	45	NEC	018, 019, 020, 040, 059, 060
3	Anam	001, 002, 003, 004, 005, 006, 007, 008, 009, 010, 011, 012, 013, 014	46	Nikei	003
4	AOC	001, 018, 040, 148	47	Onking	003
5	Bell & Howell (M.Wards)	057, 058, 081	48	Onwa	003
6	Brocsonic	059, 060	49	Panasonic	006, 007, 008, 009, 054, 066, 067, 073, 074
7	Candle	018	50	Penney	018
8	Cetronic	003	51	Philco	003, 015, 017, 018, 048, 054, 059, 062, 069, 090
9	Citizen	003, 018, 025	52	Philips	015, 017, 018, 040, 048, 054, 062, 072
10	Cinema	097	53	Pioneer	063, 066, 080, 091
11	Classic	003	54	Portland	015, 018, 059
12	Concerto	018	55	Proton	040
13	Contec	046	56	Quasar	006, 066, 067
14	Coronado	015	57	Radio Shack	017, 048, 056, 060, 061, 075
15	Craig	003, 005, 061, 082, 083, 084	58	RCA/Proscan	018, 059, 067, 076, 077, 078, 092, 093, 094
16	Croslex	062	59	Realistic	003, 019
17	Crown	003	60	Sampo	040
18	Curtis Mates	059, 061, 063	61	Samsung	000, 015, 016, 017, 040, 043, 046, 047, 048, 049, 059, 060, 098
19	CXC	003	62	Sanyo	019, 061, 065
20	Daewoo	002, 003, 004, 015, 016, 017, 018, 019, 020, 021, 022, 023, 024, 025, 026, 028, 029, 030, 032, 034, 035, 036, 048, 059, 090	63	Scott	003, 040, 060, 061
21	Daytron	040	64	Sears	015, 018, 019
22	Dynasty	003	65	Sharp	015, 057, 064
23	Emerson	003, 015, 040, 046, 059, 061, 064, 082, 083, 084, 085	66	Signature 2000 (M.Wards)	057, 058
24	Fisher	019, 065	67	Sony	050, 051, 052, 053, 055
25	Funai	003	68	Soundesign	003, 040
26	Futuretech	003	69	Spectricon	001
27	General Electric (GE)	006, 040, 056, 059, 066, 067, 068	70	SSS	018
28	Hall Mark	040	71	Sylvania	018, 040, 048, 054, 059, 060, 062
29	Hitachi	015, 018, 050, 059, 069	72	Symphonic	061, 095, 096
30	Inkel	045	73	Tatung	006
31	JC Penny	056, 059, 067, 086	74	Techwood	018
32	JVC	070	75	Teknika	003, 015, 018, 025
33	KTV	059, 061, 087, 088	76	TMK	018, 040
34	KEC	003, 015, 040	77	Toshiba	019, 057, 063, 071
35	KMC	015	78	Vidtech	018
36	LG (Goldstar)	001, 015, 016, 017, 037, 038, 039, 040, 041, 042, 043, 044	79	Videch	059, 060, 069
37	Luxman	018	80	Wards	015, 017, 018, 040, 048, 054, 060, 064
38	LXI (Sears)	019, 054, 056, 059, 060, 062, 063, 065, 071	81	Yamaha	018
39	Magnavox	015, 017, 018, 048, 054, 059, 060, 062, 072, 089	82	York	040
40	Marantz	040, 054	83	Yupiteru	003
41	Matsui	054	84	Zenith	058, 079
42	MGA	018, 040	85	Zonda	001
43	Mitsubishi/MGA	018, 040, 059, 060, 075	86	Dongyang	003, 054

Before Calling for Service

Refer to the chart below when this unit does not function properly. If the problem you are experiencing is not listed below or if the instruction below does not help, turn off the unit, disconnect the power cord, and contact the nearest authorized dealer or Samsung Electronics Service Center.

Symptom	Check/Remedy
Disc tray does not open.	<ul style="list-style-type: none"> Is the power cord plugged securely into the outlet? Turn off the power and then turn it back on.
Playback does not start.	<ul style="list-style-type: none"> Check the region number of the DVD. DVD discs purchased from abroad may not be playable. CD-ROMs and DVD-ROMs cannot be played on this DVD player. Make sure that the rating level is correct.
Playback does not start immediately when the Play/Pause button is pressed.	<ul style="list-style-type: none"> Are you using a deformed disc or a disc with scratches on the surface? Wipe the disc clean.
Sound is not produced.	<ul style="list-style-type: none"> No sound is heard during fast playback, slow playback, and step motion playback. Are the speakers connected properly? Is the speaker setup correctly customized? Is the disc severely damaged?
Sound can be heard only from a few speakers and not all six.	<ul style="list-style-type: none"> When listening to a CD or radio, sound is output to the front speakers (L/R) only. Select "PRO LOGIC II" by pressing DJPL II (Dolby Pro Logic II) on the remote control to use all six speakers. Make sure that the DVD disc is 5.1-CH compatible. If you set C, SL, and SR to NONE in the speaker mode in the audio setup of the setup screen, no sound is heard from the center speaker and the front left and right speakers. Set C, SL, and SR to SMALL.
Picture does not appear, sound is not produced, or the disc tray opens 2 to 5 seconds later.	<ul style="list-style-type: none"> Was the DVD player suddenly moved from a cold place to a warm one? When condensation forms inside the player, remove the disc and let the player stand for 1 or 2 hours with the power on. (You can use the player again after condensation disappears.)
Dolby Digital 5.1 CH Surround Sound is not produced.	<ul style="list-style-type: none"> Is there "Dolby Digital 5.1 CH" mark on the disc? Dolby Digital 5.1 CH Surround Sound is produced only if the disc is recorded with 5.1 channel sound. Is the audio language correctly set to DOLBY DIGITAL 5.1-CH in the information display?
The remote control does not work.	<ul style="list-style-type: none"> Is the remote control being operated within its operation range of angle and distance? Are the batteries exhausted? Have you selected the mode(TV/DVD) functions of the remote control (TV or DVD) correctly?

Symptom	Check/Remedy
<ul style="list-style-type: none"> Disc is rotating but no picture is produced. Picture quality is poor and picture is shaking. 	<ul style="list-style-type: none"> Is the TV power on? Are the video cables connected properly? Is the disc dirty or damaged? A poorly manufactured disc may not be playable.
Audio language and subtitles do not work.	<ul style="list-style-type: none"> Audio language and subtitles will not work for DVDs not containing them. And depending on the disc, they may work differently.
Menu screen does not appear even when the menu function is selected.	<ul style="list-style-type: none"> Are you using a disc that does not contain menus?
Aspect ratio cannot be changed.	<ul style="list-style-type: none"> You can play 16:9 DVDs in 16:9 WIDE mode, 4:3 LETTER BOX mode, or 4:3 PAN SCAN mode, but 4:3 DVDs can be seen in 4:3 ratio only. Refer to the DVD disc jacket and then select the appropriate function.
<ul style="list-style-type: none"> The main unit is not working. (Example: The power goes out or strange noise is heard.) The DVD player is not working normally. 	<ul style="list-style-type: none"> Turn off the power and hold the  button on the main unit for longer than 5 seconds. <p>Using the RESET function will erase all stored settings. Do not use this unless necessary.</p>
The password for rating level has been forgotten.	<ul style="list-style-type: none"> While "NO DISC" message appears on the display of main unit, hold the main unit's  button for longer than 5 seconds. "INITIALIZE" appears on the display and all settings will return to the default values. Press the POWER button. <p>Using the RESET function will erase all stored settings. Do not use this unless necessary.</p>
Can't receive radio broadcast.	<ul style="list-style-type: none"> Is the antenna connected properly? If the antenna's input signal is weak, install an external FM antenna in an area with good reception.
"CHECK ANTENNA" is displayed.	<ul style="list-style-type: none"> XM Antenna Connector and the XM Antenna is not properly connected. Check the connections.
"ON SIGNAL" is displayed.	<ul style="list-style-type: none"> Reposition your XM Antenna.
"OFF AIR" is displayed.	<ul style="list-style-type: none"> The selected channel is not currently broadcasting.
Receiving only XM channel 0 and channel 1.	<ul style="list-style-type: none"> XM Antenna is not activated. Access the website at "http://activate.xmradio.com" with a credit card to sign up.

Cautions on Handling and Storing Discs

Small scratches on the disc may reduce sound and picture quality or cause skipping. Be especially careful not to scratch discs when handling them.

Handling discs

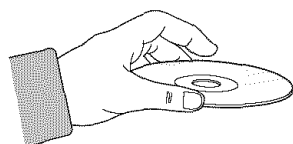

Do not touch the playback side of the disc. Hold the disc by the edges so that fingerprints will not get on the surface.
Do not stick paper or tape on the disc.

Disc Storage

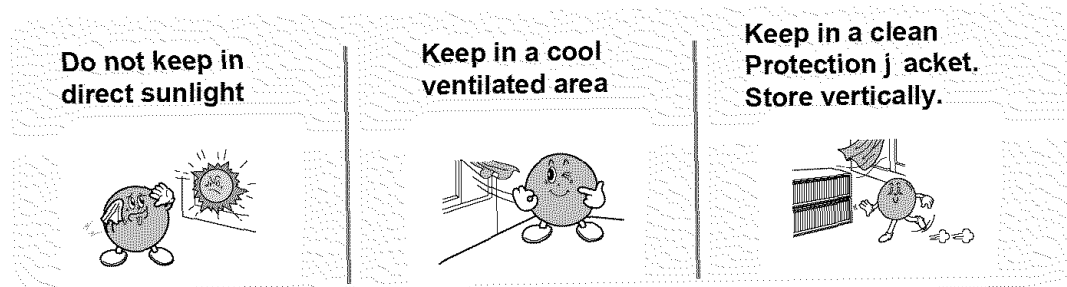

Caution

- Do not allow the discs to become contaminated with dirt.
- Do not load cracked or scratched discs.

Handling and Storing Discs



When you get fingerprints or dirt on the disc, clean it with a mild detergent diluted in water and wipe with a soft cloth.

- When cleaning, wipe gently from the inside to the outside of the disc.

Note

- Condensation may form if warm air comes into contact with cold parts inside the player. When condensation forms inside the player, the player may not operate correctly. If this occurs, remove the disc and let the player stand for 1 or 2 hours with the power on.

Language Code List

Enter the appropriate code number for the initial settings "Disc Audio", "Disc Subtitle" and/or "Disc Menu" (See page 47).

Code	Language	Code	Language	Code	Language	Code	Language
1027	Afar	1181	Frisian	1334	Latvian, Lettish	1506	Slovenian
1028	Abkhazian	1183	Irish	1345	Malagasy	1507	Samoan
1032	Afrikaans	1186	Scots Gaelic	1347	Maori	1508	Shona
1039	Amharic	1194	Galician	1349	Macedonian	1509	Somali
1044	Arabic	1196	Guarani	1350	Malayalam	1511	Albanian
1045	Assamese	1203	Gujarati	1352	Mongolian	1512	Serbian
1051	Aymara	1209	Hausa	1353	Moldavian	1513	Siswati
1052	Azerbaijani	1217	Hindi	1356	Marathi	1514	Sesotho
1053	Bashkir	1226	Croatian	1357	Malay	1515	Sundanese
1057	Byelorussian	1229	Hungarian	1358	Maltese	1516	Swedish
1059	Bulgarian	1233	Armenian	1363	Burmese	1517	Swahili
1060	Bihari	1235	Interlingua	1365	Nauru	1521	Tamil
1069	Bislama	1239	Interlingue	1369	Nepali	1525	Tegulu
1066	Bengali; Bangla	1245	Inupiak	1376	Dutch	1527	Tajik
1067	Tibetan	1248	Indonesian	1379	Norwegian	1528	Thai
1070	Breton	1253	Icelandic	1393	Occitan	1529	Tigrinya
1079	Catalan	1254	Italian	1403	(Afan) Oromo	1531	Turkmen
1093	Corsican	1257	Hebrew	1408	Oriya	1532	Tagalog
1097	Czech	1261	Japanese	1417	Punjabi	1534	Setswana
1103	Welsh	1269	Yiddish	1428	Polish	1535	Tonga
1105	Danish	1283	Javanese	1435	Pashto, Pushto	1538	Turkish
1109	German	1287	Georgian	1436	Portuguese	1539	Tsonga
1130	Bhutani	1297	Kazakh	1463	Quechua	1540	Tatar
1142	Greek	1298	Greenlandic	1481	Rhaeto-Romance	1543	Twi
1144	English	1299	Cambodian	1482	Kirundi	1557	Ukrainian
1145	Esperanto	1300	Kannada	1483	Romanian	1564	Urdu
1149	Spanish	1301	Korean	1489	Russian	1572	Uzbek
1150	Estonian	1305	Kashmiri	1491	Kinyarwanda	1581	Vietnamese
1151	Basque	1307	Kurdish	1495	Sanskrit	1587	Volapuk
1157	Persian	1311	Kirghiz	1498	Sindhi	1613	Wolof
1165	Finnish	1313	Latin	1501	Sangro	1632	Xhosa
1166	Fiji	1326	Lingala	1502	Serbo-Croatian	1665	Yoruba
1171	Faeroese	1327	Laothian	1503	Singhalese	1684	Chinese
1174	French	1332	Lithuanian	1505	Slovak	1697	Zulu

USB Host Feature Supported Products

Digital Camera

Product	Company	Type
Finepix-A340	Fuji	Digital Camera
Finepix-F810	Fuji	Digital Camera
Finepix-F610	Fuji	Digital Camera
Finepix-1450	Fuji	Digital Camera
Finepix S7000	Fuji	Digital Camera
Finepix A310	Fuji	Digital Camera
KD-310Z	Konica	Digital Camera
Finecam SL300R	Kyocera	Digital Camera
Finecam SL400R	Kyocera	Digital Camera
Finecam S5R	Kyocera	Digital Camera
Finecam Xt	Kyocera	Digital Camera
Dimage-Z1	Minolta	Digital Camera
Dimage Z1	Minolta	Digital Camera
Dimage X21	Minolta	Digital Camera
Coolpix4200	Nikon	Digital Camera
Coolpix4300	Nikon	Digital Camera
Coolpix 2200	Nikon	Digital Camera
Coolpix 3500	Nikon	Digital Camera
Coolpix 3700	Nikon	Digital Camera
Coolpix 4100	Nikon	Digital Camera
Coolpix 5200	Nikon	Digital Camera
Stylus 410 digital	Olympus	Digital Camera
300-digital	Olympus	Digital Camera
U300	Olympus	Digital Camera
X-350	Olympus	Digital Camera
C-760	Olympus	Digital Camera
C-5060	Olympus	Digital Camera
X1	Olympus	Digital Camera
U-mini	Olympus	Digital Camera
Lumix-FZ20	Panasonic	Digital Camera
DMC-FX7GD	Panasonic	Digital Camera
Lumix LC33	Panasonic	Digital Camera
LUMIX DMC-F1	Panasonic	Digital Camera
Optio-S40	Pentax	Digital Camera
Optio-S50	Pentax	Digital Camera
Optio 33LF	Pentax	Digital Camera
Optio MX	Pentax	Digital Camera
Digimax-420	Samsung	Digital Camera
Digimax-400	Samsung	Digital Camera
Sora PDR-T30	Toshiba	Digital Camera
Coolpix 5900	Nikon	Digital Camera
Coolpix S1	Nikon	Digital Camera
Coolpix 7600	Nikon	Digital Camera
DMC-FX7	Panasonic	Digital Camera
Dimage Xt	Minolta	Digital Camera
AZ-1	Olympus	Digital Camera

USB Flash Disk

Product	Company	Type
Cruzer Micro	Sandisk	USB 2.0 USB Flash Drive 128M
Cruzer Mini	Sandisk	USB 2.0 128M
Cruzer Mini	Sandisk	USB 2.0 256M
SONY Micro Vault	Sony	USB 2.0 64MB
FLEX DRIVE	Serotech	USB 2.0 32MB
AnyDrive	A.L tech	USB 2.0 128MB
XTICK	LG	USB 2.0 128M
Micro Mini	lomega	USB 2.0 128M
iFlash	Imation	USB 2.0 64M
LG	XTICK(M)	USB 2.0 64M
RiDATA	EZDrive	USB 2.0 64M

MP3 Player

Product	Company	Type
Creative MuVo NX128M	Creative	128 MB MP3 Player
Iriver H320	Iriver	20G HDD MP3 Player
YH-920	Samsung	20G HDD MP3 Player
YP-T7	Samsung	MP3 Player
YP-MT6	Samsung	MP3 Player
YP-T6	Samsung	MP3 Player
YP-53	Samsung	MP3 Player
YP-ST5	Samsung	MP3 Player
YP-T5	Samsung	MP3 Player
YP-60	Samsung	MP3 Player
YP-780	Samsung	MP3 Player
YP-35	Samsung	MP3 Player
YP-55	Samsung	MP3 Player
IAUDIO U2	Cowon	MP3 Player
IAUDIO G3	Cowon	MP3 Player
IAudio M3	Cowon	HDD MP3 Player
SI-M500L	Sharp	256MB MP3 Player
H10	Iriver	MP3 Player
YP-T5 VB	Samsung	MP3 Player
YP-53	Samsung	256MB MP3 Player

Multi Card Reader

Product	Company	Type
UNICORN	Unicorn	USB 2.0 7 IN 1 CARD READER UC-601R
USB 2.0 Card Reader	Billionton(Taiwan)	USB 2.0 Card Reader for SD/MMC/RS-MMC(3-in-1)

USB External HDD

Product	Company	Type
CUTIE	Serotech	POCKET HARD DISK DRIVE
MOMOBAY UX-2	Dvico	USB 2.0

Specifications

GENERAL	Power Consumption	110W		
	Weight	11lbs		
	Dimensions (W x H x D)	17 x 3 x 17.1 inches		
	Operating Temperature Range	41°F ~ 95°F		
	Operating Humidity Range	10% ~ 75%		
TUNER	Usable Sensitivity	10dB		
	S/N Ratio	60dB		
	Distortion	1%		
OUTPUT	Composite Video	1.0Vp-p(75Ω load)		
	Component Video	Y:1.0Vp-p(75Ω load)		
		Pr:0.70Vp-p(75Ω load)		
		Pb:0.70Vp-p(75Ω load)		
HDMI	Impedance: 85~115Ω			
AMPLIFIER	Front speaker output	140W x 2(3Ω)		
	Center speaker output	140W x 2(3Ω)		
	Rear speaker output	140W x 2(3Ω)		
	Subwoofer speaker output	160W(3Ω)		
	Frequency range	20Hz~20KHz		
	S/N Ratio	75dB		
	Channel separation	60dB		
	Input sensitivity	(AUX)400mV		
HT-Q80	Speaker system	5.1ch speaker system		
		Front/Center/Rear speaker	Subwoofer speaker	
	Impedance	3Ω x 6	3Ω	
	Frequency range	145Hz~20KHz	35Hz~155Hz	
	Output sound pressure level	84dB/W/M	82dB/W/M	
	Rated input	140W	160W	
	Maximum input	280W	320W	
	Dimensions (W x H x D)	Front/Rear	3.9 x 6.9 x 3.7 inches	7.8 x 15.7 x 13.3 inches
		Center	11.8x 3.5 x 3.6 inches	
		Center	2.9 lbs	
Weights	Front/Rear	3 lbs/2.6 lbs	13.9 lbs	
Center	2.9 lbs			
HT-TQ85	Speaker system	5.1ch speaker system		
		Front/Center/Rear speaker	Subwoofer speaker	
	Impedance	3Ω x 6	3Ω	
	Frequency range	145Hz~20KHz	35Hz~155Hz	
	Output sound pressure level	84dB/W/M	82dB/W/M	
	Rated input	140W	160W	
	Maximum input	280W	320W	
	Dimensions (W x H x D)	Front/Rear	3.5 x 41.1 x 3.5 inches	7.8 x 15.7 x 13.3 inches
		Center	11.8 x 3.5 x 3.6 inches	
		Center	2.7 lbs	
Weights	Front/Rear	15.4 lbs/14.2 lbs	13.9 lbs	
Center	2.7 lbs			

Speaker Installation

SAMSUNG Home Theater

LIMITED WARRANTY TO ORIGINAL PURCHASER

This SAMSUNG brand product, as supplied and distributed by Samsung Electronics America, Inc. (SAMSUNG) and delivered new, in the original carton to the original consumer purchaser, is warranted by SAMSUNG against manufacturing defects in materials and workmanship for a limited warranty period of:

One (1) Year Parts and Labor*
(*90 Days Parts and Labor for Commercial Use)

This limited warranty begins on the original date of purchase, and is valid only on products purchased and used in the United States. To receive warranty service, the purchaser must contact SAMSUNG for problem determination and service procedures. Warranty service can only be performed by a SAMSUNG authorized service center. The original dated bill of sale must be presented upon request as proof of purchase to SAMSUNG or SAMSUNG's authorized service center. Transportation of the product to and from the service center is the responsibility of the purchaser.

SAMSUNG will repair or replace this product, at our option and at no charge as stipulated herein, with new or reconditioned parts or products if found to be defective during the limited warranty period specified above. All replaced parts and products become the property of SAMSUNG and must be returned to SAMSUNG. Replacement parts and products assume the remaining original warranty, or ninety (90) days, whichever is longer.

SAMSUNG's obligations with respect to software products distributed by SAMSUNG under the SAMSUNG brand name are set forth in the applicable end user license agreement. Non-SAMSUNG hardware and software products, if provided, are on an "AS IS" basis. Non-SAMSUNG manufacturers, suppliers, publishers, and service providers may provide their own warranties.

This limited warranty covers manufacturing defects in materials and workmanship encountered in normal, and except to the extent otherwise expressly provided for in this statement, noncommercial use of this product, and shall not apply to the following, including, but not limited to: damage which occurs in shipment; delivery and installation; applications and uses for which this product was not intended; altered product or serial numbers; cosmetic damage or exterior finish; accidents, abuse, neglect, fire, water, lightning or other acts of nature; use of products, equipment, systems, utilities, services, parts, supplies, accessories, applications, installations, repairs, external wiring or connectors not supplied and authorized by SAMSUNG, or which damage this product or result in service problems; incorrect electrical line voltage, fluctuations and surges; customer adjustments and failure to follow operating instructions, cleaning, maintenance and environmental instructions that are covered and prescribed in the instruction book; product removal or reinstallation; reception problems and distortion related to noise, echo, interference or other signal transmission and delivery problems. SAMSUNG does not warrant uninterrupted or error-free operation of the product.

THERE ARE NO EXPRESS WARRANTIES OTHER THAN THOSE LISTED AND DESCRIBED ABOVE, AND NO WARRANTIES WHETHER EXPRESS OR IMPLIED, INCLUDING, BUT NOT LIMITED TO, ANY IMPLIED WARRANTIES OF MERCHANTABILITY OR FITNESS FOR A PARTICULAR PURPOSE, SHALL APPLY AFTER THE EXPRESS WARRANTY PERIODS STATED ABOVE, AND NO OTHER EXPRESS WARRANTY OR GUARANTY GIVEN BY ANY PERSON, FIRM OR CORPORATION WITH RESPECT TO THIS PRODUCT SHALL BE BINDING ON SAMSUNG. SAMSUNG SHALL NOT BE LIABLE FOR LOSS OF REVENUE OR PROFITS, FAILURE TO REALIZE SAVINGS OR OTHER BENEFITS, OR ANY OTHER SPECIAL, INCIDENTAL OR CONSEQUENTIAL DAMAGES CAUSED BY THE USE, MISUSE OR INABILITY TO USE THIS PRODUCT, REGARDLESS OF THE LEGAL THEORY ON WHICH THE CLAIM IS BASED, AND EVEN IF SAMSUNG HAS BEEN ADVISED OF THE POSSIBILITY OF SUCH DAMAGES. NOR SHALL RECOVERY OF ANY KIND AGAINST SAMSUNG BE GREATER IN AMOUNT THAN THE PURCHASE PRICE OF THE PRODUCT SOLD BY SAMSUNG AND CAUSING THE ALLEGED DAMAGE. WITHOUT LIMITING THE FOREGOING, PURCHASER ASSUMES ALL RISK AND LIABILITY FOR LOSS, DAMAGE OR INJURY TO PURCHASER AND PURCHASER'S PROPERTY AND TO OTHERS AND THEIR PROPERTY ARISING OUT OF THE USE, MISUSE OR INABILITY TO USE THIS PRODUCT SOLD BY SAMSUNG NOT CAUSED DIRECTLY BY THE NEGLIGENCE OF SAMSUNG. THIS LIMITED WARRANTY SHALL NOT EXTEND TO ANYONE OTHER THAN THE ORIGINAL PURCHASER OF THIS PRODUCT, IS NONTRANSFERABLE AND STATES YOUR EXCLUSIVE REMEDY.

Some states do not allow limitations on how long an implied warranty lasts, or the exclusion or limitation of incidental or consequential damages, so the above limitations or exclusions may not apply to you. This warranty gives you specific legal rights, and you may also have other rights which vary from state to state.

To obtain warranty hardware service, please contact SAMSUNG at:

SAMSUNG CUSTOMER CARE CENTER
400 Valley Road, Suite 201, Mt. Arlington, NJ 07856
1-800-SAMSUNG (1-800-726-7864) and www.samsung.com

How to install the speaker and the stand. (Tallboy type)(HT-TQ85)

Components
A: SPEAKER
B: STAND
C: STAND BASE
D: SCREW
E: SCREW

- Turn the STAND(B) upside-down and connect it to the STAND BASE(C).
- Turning the screw(D) clockwise, connect it to two holes marked with the arrow using a screwdriver as shown in the illustration.
- Turning the supplied screw (E) clockwise, connect it to a hole on the rear of the Speaker.
- Connect the assembled stand to the SPEAKER(A).
- Turning the screw (E) clockwise, connect to a hole on the rear of the speaker using a screwdriver as shown in the illustration.
- This is the successfully assembled speaker.
* Make sure that the TALLBOY type speaker should be installed on the flat and stable area. Otherwise it may fall down due to external shock.

How to install the speaker and the stand. (Half tallboy type)(HT-TQ85)

- Connect the SPEAKER(A) with the STAND BASE(C).
- Turning the screw (D) clockwise, connect it to two holes marked with the arrow using a screwdriver as shown in the illustration.
- Turning the screw (E) clockwise, connect to a hole on the rear of the speaker using a screwdriver as shown in the illustration.
- This is the successfully assembled SPEAKER(A).