

TOSHIBA



Introduction

Connecting
your TV/DVD

Setting up
your TV/DVD

Using the
TV/DVD's Features

DVD Playback

Appendix

OWNER'S MANUAL

LCD TV/DVD Combination

COLORSTREAM[®] HD

DOLBY DIGITAL

HDMI

THEATERWIDE HD

EDTV MONITOR

DVD VIDEO

COMPACT disc DIGITAL VIDEO

dts DIGITAL OUT

DMX[®]

LCDVD[™]

23HLV86

Owner's Record

The model number and serial number are on the back of your TV/DVD. Record these numbers in the spaces below. Refer to these numbers whenever you communicate with your Toshiba dealer about this TV/DVD.

Model number:

Serial number:

© 2006 TOSHIBA CORPORATION
All Rights Reserved



Always read and understand the **PRODUCT WARNINGS and USER DIRECTIONS** that are contained in this manual before attempting to use your television, to help ensure its safe use. Always store this manual near your television for convenient future reference.

Dear Customer,

Thank you for purchasing this Toshiba television.

You must carefully read and understand all of the safety instructions contained in this manual before you attempt to use this product in order to avoid potential hazards that could cause bodily injury or property damage or could damage your television.

We hope that you are completely satisfied with your Toshiba television and that it will give you long and enjoyable service. We look forward to providing you with additional Toshiba products to serve all of your entertainment needs in the future.

Safety Precautions

WARNING: TO REDUCE THE RISK OF FIRE OR ELECTRIC SHOCK, DO NOT EXPOSE THIS APPLIANCE TO RAIN OR MOISTURE.



CAUTION: TO REDUCE THE RISK OF ELECTRIC SHOCK, DO NOT REMOVE COVER (OR BACK).

NO USER-SERVICEABLE PARTS INSIDE. REFER SERVICING TO QUALIFIED SERVICE PERSONNEL.



The lightning flash with arrowhead symbol, within an equilateral triangle, is intended to alert the user to the presence of uninsulated "dangerous voltage" within the product's enclosure that may be of sufficient magnitude to constitute a risk of electric shock to persons.

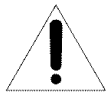

The exclamation point within an equilateral triangle, is intended to alert the user to the presence of important operating and maintenance (servicing) instructions in the literature accompanying the appliance.

CAUTION: To reduce the risk of electric shock, do not use the polarized plug with an extension cord, receptacle, or other outlet unless the blades can be inserted completely to prevent blade exposure.



ENERGY STAR® qualified TV. Products that earn the ENERGY STAR prevent green house gas emissions by meeting strict energy efficiency guidelines set by the U.S. Environmental Protection Agency and the U.S. Department of Energy. ENERGY STAR and the ENERGY STAR mark are registered U.S. marks.

WARNING: If you decide to wall mount this television, always use a UL-approved wall bracket appropriate for the size and weight of this television. The use of any wall bracket other than a UL-approved wall bracket appropriate for the size and weight of this television for wall mounting this television could result in serious bodily injury and/or property damage.

NOTE TO CATV INSTALLERS

This is a reminder to call the CATV system installer's attention to Article 820-40 of the NEC, which provides guidelines for proper grounding and, in particular, specifies that the cable ground shall be connected to grounding system of the building, as close to the point of cable entry as practical. For additional antenna grounding information, see item 27 on page 5.

Child Safety

It Makes A Difference Where Your TV Stands

Congratulations on your purchase!

As you enjoy your new TV, keep these safety tips in mind:



The Issue

- If you are like most consumers, you have a TV in your home. Many homes, in fact, have more than one TV.
- The home theater entertainment experience is a growing trend, and larger TVs are popular purchases; however, they are not always supported on the proper TV stands.
- Sometimes TVs are improperly secured or inappropriately situated on dressers, bookcases, shelves, desks, audio speakers, chests, or carts. As a result, TVs may fall over, causing unnecessary injury.



Toshiba Cares!

- The consumer electronics industry is committed to making home entertainment enjoyable and safe.
- The Consumer Electronics Association formed the Home Entertainment Support Safety Committee, comprised of TV and consumer electronics furniture manufacturers, to advocate children's safety and educate consumers and their families about television safety.

Tune Into Safety

- One size does NOT fit all! Use appropriate furniture large enough to support the weight of your TV (and other electronic components).
- Use appropriate angle braces, straps, and anchors to secure your furniture to the wall (but never screw anything directly into the TV).
- Carefully read and understand the other enclosed instructions for proper use of this product.
- Do not allow children to climb on or play with furniture and TVs.
- Avoid placing any item on top of your TV (such as a VCR, remote control, or toy) that a curious child may reach for.
- Remember that children can become excited while watching a program and can potentially push or pull a TV over.
- Share our safety message about this hidden hazard of the home with your family and friends. Thank you!



2500 Wilson Blvd.
Arlington, VA 22201 U.S.A.
Tel. 703-907-7600 Fax 703-907-7690
www.CE.org

CEA is the Sponsor, Producer and Manager of the International CES®

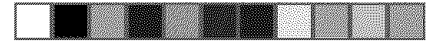
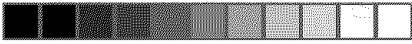

Introduction

Connecting your TV/DVD

Setting up your TV/DVD

Using the TV/DVD's Features

DVD Playback

Appendix

FCC compliance information

CAUTION: TO PREVENT ELECTRIC SHOCK DO NOT USE THIS POLARIZED PLUG WITH AN EXTENSION CORD, RECEPTACLE OR OTHER OUTLET UNLESS THE BLADES CAN BE FULLY INSERTED TO PREVENT BLADE EXPOSURE.

FCC Declaration of Conformity Compliance Statement (Part 15):

The Toshiba 23HLV86, LCD TV/DVD Combination complies with Part 15 of the FCC rules. Operation is subject to the following two conditions: (1) this device may not cause harmful interference, and (2) this device must accept any interference received, including interference that may cause undesired operation.

The party responsible for compliance to these rules is:

Toshiba America Consumer Products, L.L.C.

82 Totowa Rd. Wayne, NJ 07470.

Ph: (800) 631-3811 or visit TACP's website at www.tacp.Toshiba.com

NOTE: This equipment has been tested and found to comply with the limits for a Class B digital device, pursuant to Part 15 of the FCC rules. These limits are designed to provide reasonable protection against harmful interference in a residential installation. This equipment generates, uses, and can radiate radio frequency energy and, if not installed and used in accordance with the instructions, may cause harmful interference to radio communications. However, there is no guarantee that interference will not occur in a particular installation. If this equipment does cause harmful interference to radio or television reception, which can be determined by removing and applying power to the equipment, the user is encouraged to try to correct the interference by one or more of the following measures:

- Reorient or relocate the receiving antenna.
- Increase the separation between the equipment and the receiver.
- Connect the equipment into an outlet on a circuit different from that to which the receiver is connected.
- Consult the dealer or an experienced radio/TV technician for help.

CAUTION: Changes or modifications to this equipment not expressly approved by Toshiba could void the user's authority to operate this equipment.

CAUTION:

THIS DIGITAL VIDEO PLAYER EMPLOYS A LASER SYSTEM. TO ENSURE PROPER USE OF THIS PRODUCT, PLEASE READ THIS OWNER'S MANUAL CAREFULLY AND RETAIN FOR FUTURE REFERENCE. SHOULD THE UNIT REQUIRE MAINTENANCE, CONTACT AN AUTHORIZED SERVICE LOCATION.

USE OF CONTROLS, ADJUSTMENTS OR THE PERFORMANCE OF PROCEDURES OTHER THAN THOSE SPECIFIED HEREIN MAY RESULT IN HAZARDOUS RADIATION EXPOSURE.

TO PREVENT DIRECT EXPOSURE TO LASER BEAM, DO NOT TRY TO OPEN THE ENCLOSURE. VISIBLE LASER RADIATION MAY BE PRESENT WHEN THE ENCLOSURE IS OPENED. DO NOT STARE INTO BEAM.

Location of the required Marking

The rating sheet and the safety caution are the rear of the unit.

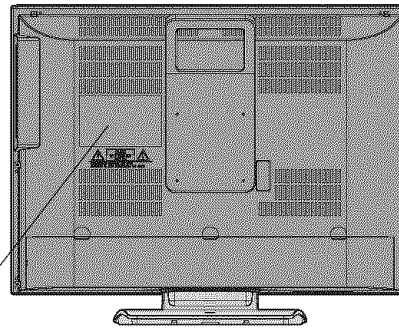

CERTIFICATION: COMPLIES WITH FDA RADIATION PERFORMANCE STANDARDS, 21 CFR SUBCHAPTER J.

ON DISPOSAL

This product contains mercury. Disposal of mercury may be regulated due to environmental considerations. For disposal or recycling information, please contact your local authorities or the Electronic Industrial Alliance: www.eiae.org.



IMPORTANT SAFEGUARDS

Important Safety Instructions

- 1) **Read these instructions.**
- 2) **Keep these instructions.**
- 3) **Heed all warnings.**
- 4) **Follow all instructions.**



- 5) **Do not use this apparatus near water.**
- 6) **Clean only with dry cloth.**
- 7) **Do not block any ventilation openings.** Install in accordance with the manufacturer's instructions.
- 8) **Do not install near any heat sources** such as radiators, heat registers, stoves, or other apparatus (including amplifiers) that produce heat.

- 9) **Do not defeat the safety purpose of the polarized or grounding type plug.** A polarized plug has two blades with one wider than the other. A grounding type plug has two blades and a third grounding prong. The wide blade or the third prong are provided for your safety. If the provided plug does not fit into your outlet, consult an electrician for replacement of the obsolete outlet.

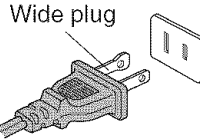

- 10) **Protect the power cord** from being walked on or pinched, particularly at plugs, convenience receptacles, and the point where they exit from the apparatus.

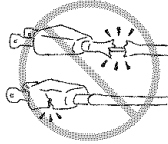

- 11) **Only use attachments/accessories specified by the manufacturer.**

- 12) **Use only with the cart, stand, tripod, bracket, or table specified by the manufacturer, or sold with the apparatus.** When a cart is used, use caution when moving the cart/apparatus combination to avoid injury from tip-over.



- 13) **Unplug this apparatus during lightning storms or when unused for long periods of time.**

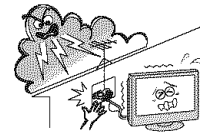

- 14) **Refer all servicing to qualified service personnel.** Servicing is required when the apparatus has been damaged in any way, such as power-supply cord or plug is damaged, liquid has been spilled or objects have fallen into the apparatus, the apparatus has been exposed to rain or moisture, does not operate normally, or has been dropped.

- 14a) **CAUTION:** If the TV is dropped and the cabinet or enclosure surface has been damaged or the TV does not operate normally, take the following precautions:
 - ALWAYS turn off the TV and unplug the power cord to avoid possible electric shock or fire.
 - To prevent personal injury, never handle the damaged television.
 - ALWAYS contact a service technician to inspect the TV any time it has been damaged or dropped.



- 15) The apparatus shall not be exposed to dripping or splashing and that no objects filled with liquids, such as vases, shall be placed on the apparatus.

Installation, Care, and Service

Installation

Follow these recommendations and precautions and heed all warnings when installing your TV:

- 16) Never modify this equipment. Changes or modifications may void: a) the warranty, and b) the user's authority to operate this equipment under the rules of the Federal Communications Commission.

- 17)  **DANGER: RISK OF SERIOUS PERSONAL INJURY, DEATH, OR EQUIPMENT DAMAGE!** Never place the TV on an unstable cart, stand, or table. The TV may fall, causing serious personal injury, death, or serious damage to the TV. 

- 18) Never place items such as vases, aquariums, or candles on top of the TV.

- 19) Always place the TV on the floor or a sturdy, level, stable surface that can support the weight of the unit. Use a sturdy tie between the TV's rear hook and the rear wall, pillar, etc., to secure the TV. If you use a TV stand, fix the TV by using the attached band.

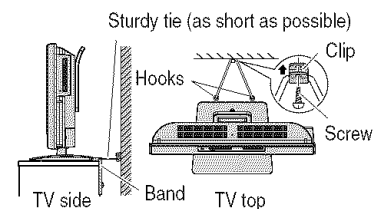

- 20) Never expose the apparatus to dripping or splashing liquid or place items such as vases, aquariums, any other item filled with liquid, or candles on top of the TV.

- 21) Never block or cover the slots or openings in the TV cabinet back, bottom, and sides.

Never place the TV:

- on a bed, sofa, rug, or similar surface;
- too close to drapes, curtains, or walls; or
- in a confined space such as a bookcase, built-in cabinet, or any other place with poor ventilation.

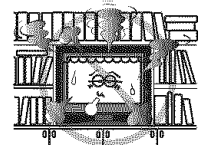

The slots and openings are provided to protect the TV from overheating and to help maintain reliable operation of the TV. Leave a space of at least 4 inches around the TV.

- 22) Always place the back of the television at least one (1) inch away from any vertical surface (such as a wall) to allow proper ventilation.

- 23) Never allow anything to rest on or roll over the power cord, and never place the TV where the power cord is subject to wear or abuse.

- 24) Never overload wall outlets and extension cords.

- 25) Always operate the TV with the power source indicated on the rating label.



- 25a) For models provided with an AC Adapter and/or Car Adapter.
 - Always use the adapter type specified by Toshiba.

CAUTION: To reduce the risk of electric shock, do not use the polarized plug with an extension cord, receptacle, or other outlet unless the blades can be inserted completely with three-wire grounding type to prevent blade exposure.

Installation (cont. from previous page)

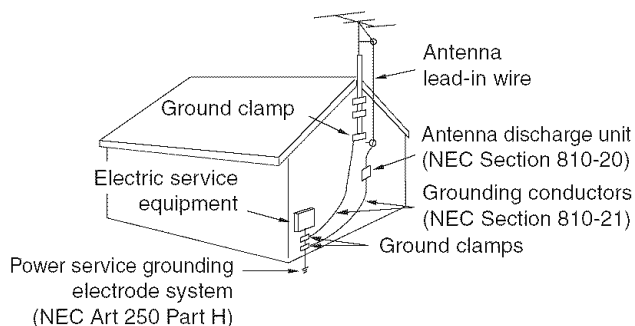

- 26) Always make sure the antenna system is properly grounded to provide adequate protection against voltage surges and built-up static charges (see Section 810 of the National Electric Code).



- 27)  **DANGER: RISK OF SERIOUS PERSONAL INJURY OR DEATH!**
- Use extreme care to make sure you are never in a position where your body (or any item you are in contact with, such as a ladder or screw-driver) can accidentally touch overhead power lines. Never locate the antenna near overhead power lines or other electrical circuits.
 - Never attempt to install any of the following during lightning activity: a) an antenna system; or b) cables, wires, or any home theater component connected to an antenna or phone system.
- 

Care

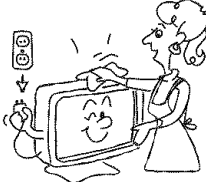
For better performance and safer operation of your TOSHIBA TV, follow these recommendations and precautions:

- 28) Always unplug the TV before cleaning. Wipe the display panel surface gently using only the supplied wiping cloth or a soft cloth (cotton, flannel, etc.) A hard cloth may damage the surface of the panel. Avoid contact with alcohol, thinner, benzene, acidic or and alkaline solvent cleaners, abrasive cleaners, or chemical cloths, as the surface may be impaired.
- 
- 29)  **WARNING: RISK OF ELECTRIC SHOCK!** Never spill liquids or push objects of any kind into the TV cabinet slots.
- 30) While it is thundering, do not touch the connecting cables or apparatus.
- 31) For added protection of your TV from lightning and power surges, always unplug the power cord and disconnect the antenna from the TV if you leave the TV unattended or unused for long periods of time.
- 32) During normal use, the TV may make occasional snapping or popping sounds. This is normal, especially when the unit is being turned on or off. If these sounds become frequent or continuous, unplug the power cord and contact a Toshiba Authorized Service Center.

Care (cont. from previous column)

- 33) Keep your fingers well clear of the disc slot as it is closing. Failure to do so may cause serious personal injury.
- 34) When you use headphones, keep the volume at a moderate level. Using headphones continuously at a high volume may cause hearing damage.
- 35) Do not look into the opening of the disc slot or ventilation opening of the product to see the source of the laser beam. Doing so may cause sight damage.
- 36) Do not use a cracked, deformed, or repaired disc. These discs are easily broken and may cause serious personal injury and product malfunction.
- 37) Do not press on or jolt the LCD panel. Doing so may cause the LCD panel glass to break and injury may occur. Should the LCD panel be broken and liquid leaks out, do not inhale or swallow it. Doing so may cause poisoning. If you have got it into your mouth, wash it out and consult your doctor. If your hands or clothes have touched it, wipe them with alcohol and a cleaning cloth and then wash them well.

Service

- 38)  **WARNING: RISK OF ELECTRIC SHOCK!** Never attempt to service the TV yourself. Opening and removing the covers may expose you to dangerous voltage or other hazards. Refer all servicing to a Toshiba Authorized Service Center.
- 39) If you have the TV serviced:
- Ask the service technician to use only replacement parts specified by the manufacturer.
 - Upon completion of service, ask the service technician to perform routine safety checks to determine that the TV is in safe operating condition.
- 40) When the TV reaches the end of its useful life, ask a qualified service technician to properly dispose of the TV.

Introduction

Connecting your TV/DVD

Setting up your TV/DVD

Using the TV/DVD's Features

DVD Playback

Appendix

Precautions

Important notes about your LCD TV

The following symptoms are technical limitations of LCD Display technology and are not an indication of malfunction. Therefore, Toshiba is not responsible for perceived defects resulting from these symptoms.

- 1) An afterimage (ghost) may appear on the screen if a fixed, nonmoving image is displayed for a long period of time. The afterimage is not permanent and will disappear in a short period of time.
- 2) The LCD panel contained in this TV is manufactured using an extremely high level of precision technology; however, there may be an occasional pixel (dot of light) that does not operate properly (does not light, remains constantly lit, etc.). This is a structural property of LCD technology, is not a sign of malfunction, and is not covered under your warranty. Such pixels are not visible when the picture is viewed from a normal viewing distance.

Note: Interactive video games that involve shooting a "gun" type of joystick at an on-screen target may not work on this TV.

Notes on handling

- Do not subject the LCD panel to physical shock, such as dropping it. It may cause unit damage and malfunction.
- When shipping the unit, the original shipping carton and packing materials come in handy. For fully protection, repack the unit as it was originally packed at the factory.
- Do not use volatile liquids, such as insecticide, near the unit. Do not leave rubber or plastic products in contact with the unit for prolonged periods of time. Doing so will leave marks on the finish.
- The top and rear panels of the unit may become warm after a long period of use. This is not a malfunction.
- When the unit is not in use, always remove the disc and turn off the power.
- If you do not use the unit for a long period, the unit may not function properly in the future. Turn on and use the unit occasionally.

Notes on locating the unit

- When you place this unit near a TV, radio, or VCR, the playback picture may become poor and the sound may be distorted. In this case, place the unit away from the TV, radio, or VCR.
- To avoid damage to this product, never place or store the TV/DVD in direct sunlight; hot, humid areas; or areas subject to excessive dust or vibration.

Notes on moisture condensation

Moisture condensation damages the unit. Please read the following carefully.

Moisture condensation occurs, for example, when you pour a cold drink into a glass on a warm day and drops of water form on the outside of the glass. In the same way, moisture may condense on this unit's internal optical pick-up lens, one of the most crucial internal parts of the unit.

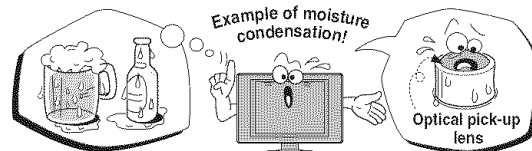

Moisture condensation may occur in the following situations:

- When you move the unit from a cold area to a warm area.
- When you use the unit in a room in which the heat was just turned on.
- When you use the unit in an area where cold air from an air conditioner directly hits the unit.
- When you use the unit in a humid area.

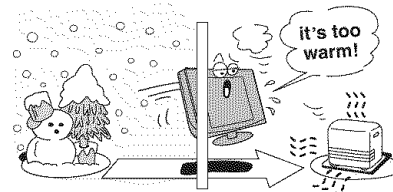

Never use the unit when moisture condensation may occur.

Using the unit when moisture condensation exists may damage discs and internal parts. Remove the disc, connect the power cord of the unit to the wall outlet, turn on the unit, and leave it for two or three hours. After two or three hours, the unit will have warmed up and evaporated any moisture. Keep the unit connected to the wall outlet and moisture condensation will seldom occur.

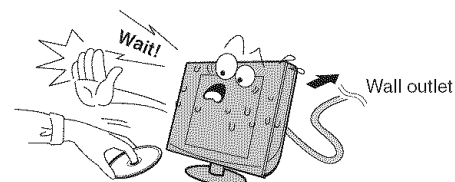

Note on cleaning

Use a soft, dry cloth for cleaning.

- Do not use any type of solvent, such as thinner and benzene, as they may damage the surface of the unit.

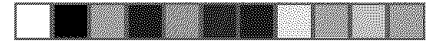
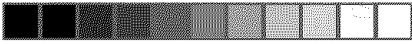

Notes on discs

On handling discs

- Do not touch the playback side of the disc. For example, handle the disc so that it is shown in figure below.

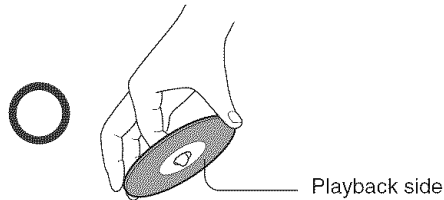

- Do not attach paper or tape to discs.



On cleaning discs

- Fingerprints and dust on the disc cause picture and sound deterioration. Wipe the disc from the center outwards with a soft cloth. Always keep the disc clean.

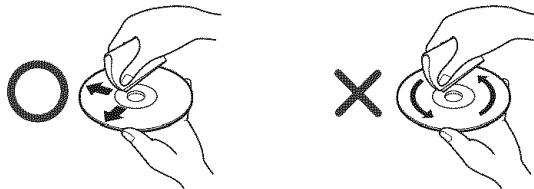

- Do not use any type of solvent such as thinner, benzene, commercially available cleaners or antistatic spray for vinyl LPs. It may damage the disc.

On storing discs

- Do not store discs in a place subject to direct sunlight or near heat sources.
- Do not store discs in places subject to moisture and dust such as a bathroom or near a humidifier.
- Store discs vertically in a case. Stacking or placing objects on discs outside of their case may cause warping.

Structure of disc contents

Normally, DVD video discs are divided into titles, and the titles are sub-divided into chapters. Video CDs and Audio CDs are divided into tracks.

DVD video disc

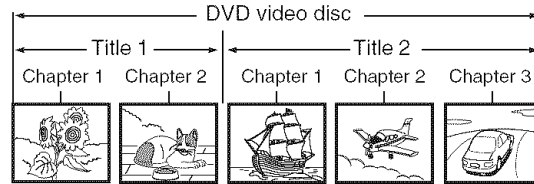

Video CD/Audio CD

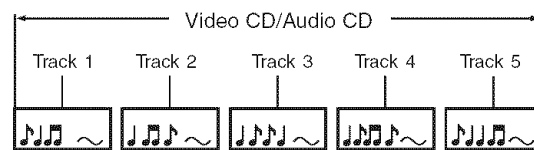

Each title, chapter or track is assigned a number, which is called "title number", "chapter number" or "track number" respectively. Some discs may not have these numbers.

Notes on copyright

The unauthorized recording, use, distribution, or revision of television programs, video tapes, DVDs, and other materials is prohibited under the Copyright Laws of the United States and other countries, and may subject you to civil and criminal liability.

This product incorporates copyright protection technology that is protected by method claims of certain U.S. patents and other intellectual property rights owned by Macrovision Corporation and other rights owners. Use of this copyright protection technology must be authorized by Macrovision Corporation, and is intended for home and other limited viewing uses only unless otherwise authorized by Macrovision Corporation. Reverse engineering or disassembly is prohibited.

Introduction

Connecting your TV/DVD

Setting up your TV/DVD

Using the TV/DVD's Features

DVD Playback

Appendix

About this owner's manual

This owner's manual explains the basic instructions of this unit. Some DVD video discs are produced in a manner that allows specific or limited operation during playback. As such, the unit may not respond to all operating commands. This is not a defect in the unit. Refer to instruction notes of discs.

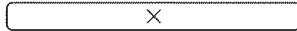

The following symbol may appear on the TV screen during operation.



It means that the operation is not permitted by the TV/DVD or the disc.

For example, sometimes it is unable to stop the playback of copyright message of the disc when the STOP (■) button is pressed. Alternatively, this symbol may also indicate that the feature is not available for the disc.

Notes on region numbers

The region number of this unit is 1. If region numbers, which stand for their playable area, are printed on your DVD video disc and you do not find  or , disc playback will not be allowed by the player. (In this case, the unit will display a message on-screen.)

Some DVDs that have no region code label may still be subject to area restrictions and therefore are not playable.

On Video CDs

The DVD player contained in this LCD TV supports Video CDs equipped with the PBC (Version 2.0) function. (PBC is the abbreviation of Playback Control.) You can enjoy two playback variations depending on types of discs.

- **Video CD not equipped with PBC function (Version 1.1)**



Sound and movie can be played on this DVD in the same way as an audio CD.

- **Video CD equipped with PBC function (Version 2.0)**

In addition to operation of a Video CD not equipped with the PBC function, you can enjoy playback of interactive software with search function by using the menu displayed on the TV screen (Menu Playback). Some of the functions described in this owner's manual may not work with some discs.

Playable discs

This unit can play the following discs.

	Disc Mark	Contents	Disc Size	Maximum playback time
DVD video discs		Audio + Video (moving pictures)	12 cm	Approx. 4 hours (single sided disc) Approx. 8 hours (double sided disc)
			8 cm	Approx. 80 minutes (single sided disc) Approx. 160 minutes (double sided disc)
Video CDs		Audio + Video (moving pictures)	12 cm	Approx. 74 minutes (single sided disc)
			8 cm	Approx. 20 minutes (single sided disc)
Audio CDs		Audio	12 cm	Approx. 74 minutes (single sided disc)
			8 cm	Approx. 20 minutes (single sided disc)

The following discs are also available.

- DVD-R/RW discs of DVD video format
- CD-R/CD-RW discs of CD-DA, Video CD, MP3, WMA, JPEG or DivX® format
- Kodak Picture CD and FUJICOLOR CD format

Some of these discs may be incompatible.

- You cannot play discs other than those listed above.
- You cannot play discs of DVD-RAM, DVD-ROM, Photo CD, etc., or non standardized discs even if they may be labeled as above.
- Some CD-R/RWs cannot be played back depending on the recording conditions.
- This unit uses the NTSC color system, and cannot play DVD video discs recorded in any other color system (PAL, SECAM, etc.).
- This unit can play an 8cm disc. Please do not use a disc adapter. It may cause trouble.
- Please do not insert any disc of an irregular shape into the unit, as it may interfere with the function of the unit. You may not be able to remove it.
- Please do not use after market accessories, such as a ring protector, as this may cause trouble with the operation of the unit.

Because of problems and errors that can occur during the creation of DVD and CD Software and/or the manufacture of DVD and CD discs, Toshiba cannot assure that the DVD player contained in this TV will successfully play every disc bearing the DVD and CD logos. If you happen to experience any difficulty playing a DVD and/or CD disc on the DVD player contained in this TV, please contact Toshiba Customer Service.

 is a trademark of DVD Format/Logo Licensing corporation.

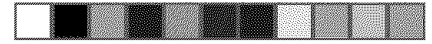
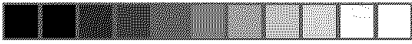

Contents

Introduction	2
FCC compliance information	3
IMPORTANT SAFEGUARDS	4
Precautions	6
Notes on discs	7
Contents	9
Exploring your new TV/DVD	10
Selecting a location for the TV/DVD	11
Connecting your TV/DVD	11
Connecting a VCR	11
Connecting a cable converter box or Antenna	12
Connecting a satellite receiver and a VCR	13
Connecting a DVD player with ColorStream® (component video) and a VCR	14
Connecting a DTV receiver/set-top box with ColorStream® (component video) and a VCR	15
Connecting a camcorder	16
Connecting an HDMI™ or a DVI device	17
Connecting an amplifier equipped with a Dolby® Digital decoder	18
Connecting an amplifier equipped with a DTS® decoder	18
Connecting an amplifier equipped with an MPEG audio decoder	19
Connecting an amplifier equipped with a digital audio input	19
Connecting a PC (personal computer)	20
Setting up your TV/DVD	21
Using the remote control	21
Installing the remote control batteries	21
Learning about the remote control	22
Starting setup	23
Changing the on-screen display language	23
Adding channels to the TV/DVD's memory	24
Programming channels automatically	24
Adding and erasing channels manually	24
Changing channels	24
Game mode	24
Using the TV/DVD's features	25
Adjusting the channel settings	25
Switching between two channels	25
Programming your favorite channels	25
Using the LOCKS menu	26
Selecting a password	26
Using the V-Chip (parental control) feature	27
Locking channels	28
Locking the video inputs	28
Setting the GameTimer™	29
Using the panel lock feature	29
Labeling channels	30
Selecting the video input source	31
Labeling the video input sources	31
Setting the clock	31
Setting the ON timer	32
Viewing the wide-screen picture formats (480i and 480p signals only)	33
Scrolling the TheaterWide® picture (TheaterWide 2 and 3 only)	35
Selecting the cinema mode	36
Using the ASPECT feature	36
Setting the sleep timer	37

Using the closed caption feature	37
Adjusting the picture	38
Selecting the picture mode	38
Adjusting the picture quality	38
Using the CableClear® feature	39
Selecting the color temperature	39
Resetting your picture adjustments	39
Adjusting the sound	40
Muting the sound	40
Selecting stereo/SAP broadcasts	40
Adjusting the sound quality	40
Resetting your audio adjustments	41
Using the StableSound® feature	41
Using the surround sound feature	41
Selecting the HDMI audio input source	42
Adjusting the back lighting feature	42
Displaying on-screen information	42
Auto power off	42
Understanding the Power Return feature	42
Picture/Audio adjustments in PC mode	43
Resetting your picture/audio adjustments in PC mode	43
DVD Playback	44
Playing a disc	44
Playing in fast reverse or fast forward directions	46
Playing frame by frame	46
Playing in slow-motion	46
Locating a chapter or track	46
Zooming	47
Locating desired scene	47
Marking desired scenes	48
Marking the scenes	48
Retuning to the scenes	48
Repeat playback	49
A-B Repeat playback	49
Program playback	50
Random playback	50
Changing angles	51
Title selection	51
DVD menu	51
Changing soundtrack language	52
Subtitles	52
Disc status	53
To turn off the PBC	53
MP3/WMA/JPEG/DivX® and Audio CD operation	54
MP3/WMA CD and Audio CD playback	55
JPEG CD playback	56
Divx® CD playback	57
Playing Divx® VOD content	57
Repeat and program playback using file browser	58
Repeat playback	58
Random playback	58
Program playback	58
DVD function setup	59
Customizing the function settings	59
Temporary cancel the rating level by DVD disc	62
Appendix	63
Language code list	63
Troubleshooting	64
Specifications	66
Limited United States Warranty	67

Introduction

Connecting
your TV/DVD

Setting up
your TV/DVD

Using the
TV/DVD's Features

DVD Playback

Appendix

Exploring your new TV/DVD

You can operate your TV/DVD by using the buttons on the top panel or the remote control. The side and back panels provide the terminals to connect other equipment to your TV/DVD.

The STARTING SETUP feature appears the first time you turn on the TV/DVD. See page 23 for details.

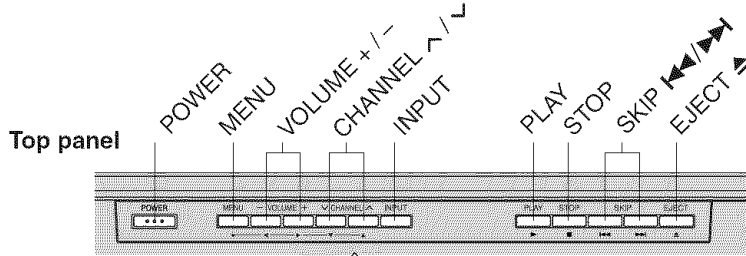

The volume and channel buttons on the top panel can be used as ▲/▼ and ◀▶ buttons while the TV menu is displayed on screen.

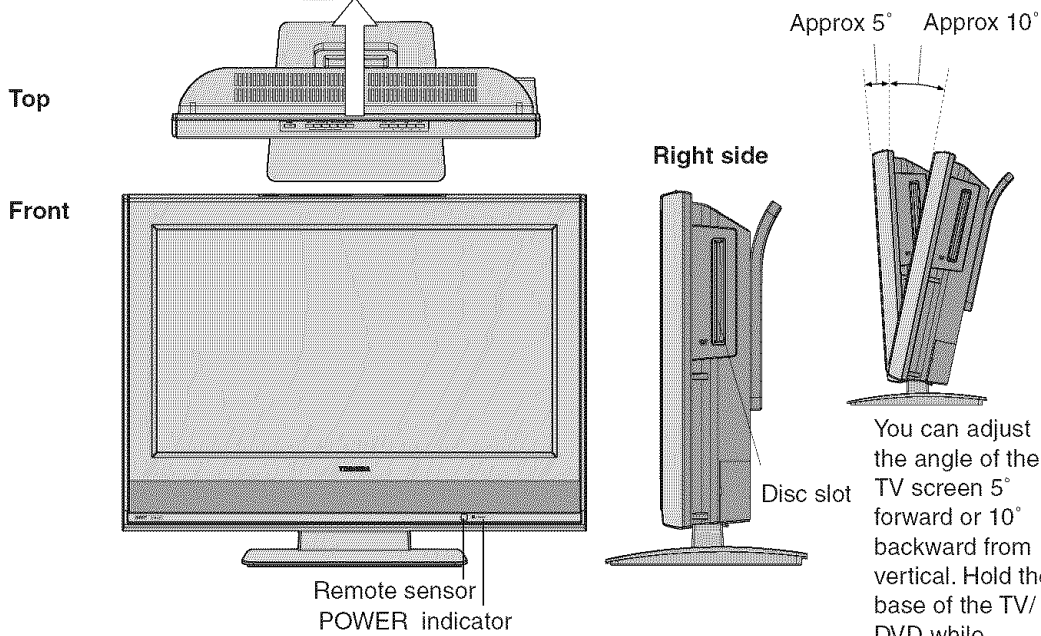

Remote control

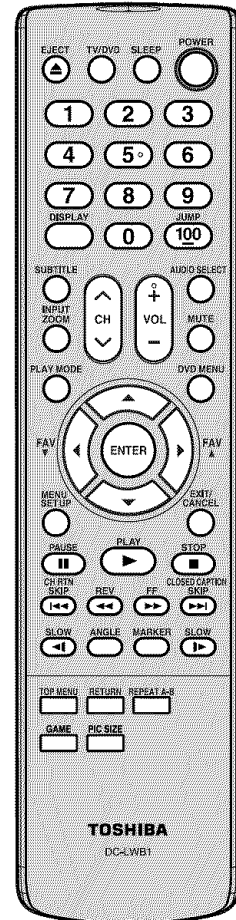

You can adjust the angle of the TV screen 5° forward or 10° backward from vertical. Hold the base of the TV/DVD while adjusting the angle.

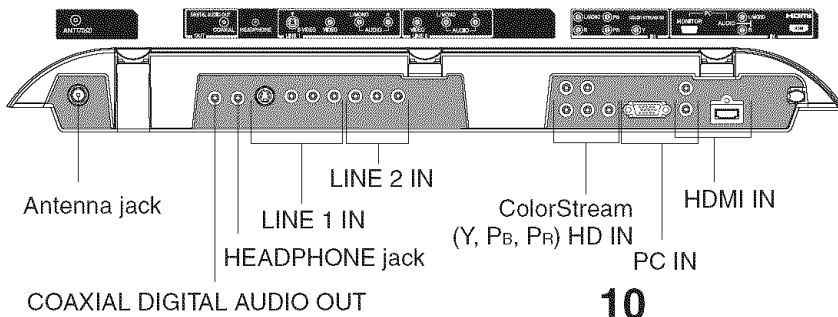
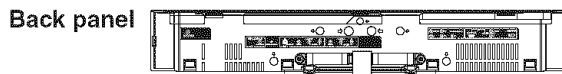
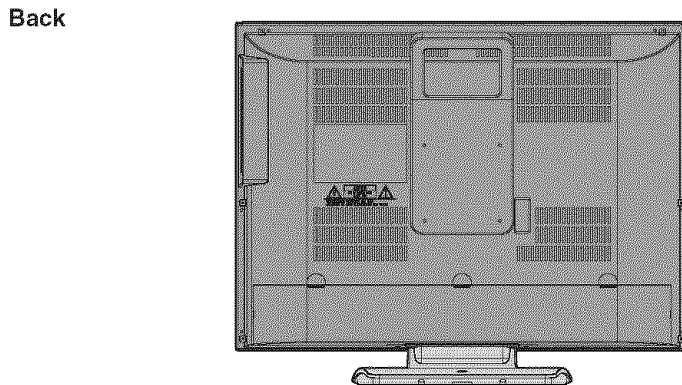

Selecting a location for the TV/DVD

- Place the TV/DVD on the floor or on a sturdy platform in a location where light does not directly hit the screen.
- Place the TV/DVD far enough from the walls to allow proper ventilation. Inadequate ventilation may cause overheating, which may damage the TV/DVD. **This type of damage is NOT COVERED BY YOUR WARRANTY.**

Connecting your TV/DVD

- A coaxial cable is the standard cable that comes in from your antenna or cable converter box. Coaxial cables use "F" connectors.
- Standard A/V (audio/video) cables are usually color coded according to use: yellow for video and red and white for audio. The red audio cable is for the stereo right channel, and the white audio cable is for the stereo left (or mono) channel. If you look at the rear panel of the TV/DVD, you will see that the terminals are color coded in the same manner as the cables.
- S-video cables provide better picture performance than standard video cables. S-video cables can only be used with S-video compatible components.
- Component video cables provide better picture performance than S-video cables. Component video cables can only be used with component video compatible components.
- HDMI (High Definition Multimedia Interface) cable is for use with video equipment that has HDMI output (see page 17).

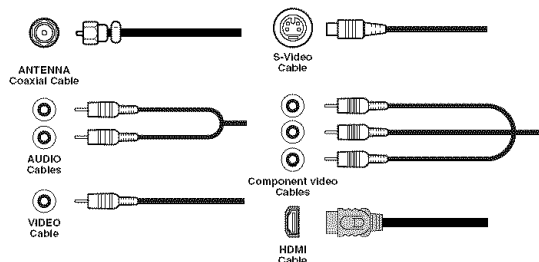

Connecting a VCR

This connection allows you to watch local channels and video programs, play or record on the VCR while watching TV, and record from one channel while watching another channel.

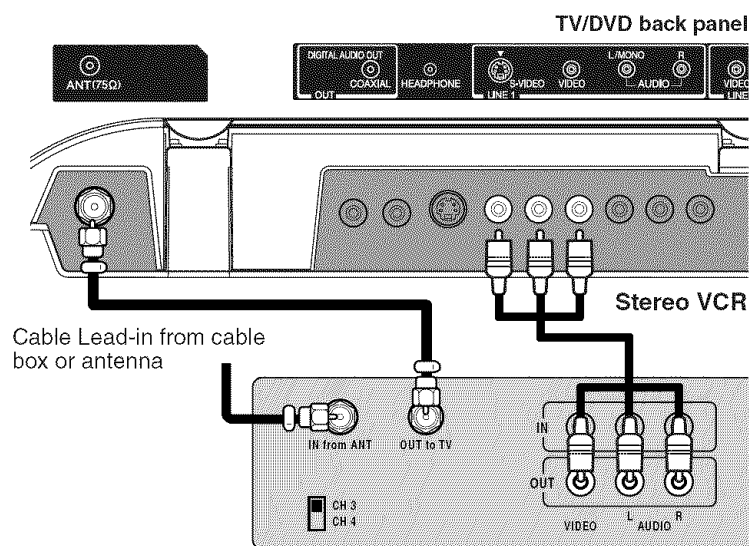

NOTE: DO NOT CONNECT A PC USING THE HDMI INPUT.
ALWAYS use the VGA port provided to connect a PC.

You will need:

- two coaxial cables
- one set of standard A/V cables

Note:

If using a mono VCR, connect L/Mono to VCR Audio OUT using only one audio cable. For better picture quality, if your VCR has S-video, you can use an S-video cable instead of the standard video cable. Do not connect a standard video cable and an S-video cable to LINE1 simultaneously.

The unauthorized recording, use, distribution or revision of television programs, videotapes, DVDs, and other materials is prohibited under the Copyright Laws of the United States and other countries, and may subject you to civil and criminal liability.

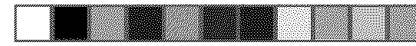
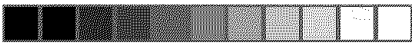

Connecting a cable converter box or Antenna

This television has an extended tuning range and can tune most cable channels without using a cable company supplied converter box. Some cable companies offer "premium pay channels" in which the signal is scrambled. Descrambling these signals for normal viewing requires the use of a descrambler device, which is generally provided by the cable company.

Option 1: For Subscribers to Basic Cable TV Service

For basic cable service not requiring a Converter/Descrambler box, connect the incoming 75 ohm Coaxial Cable directly to the Antenna Jack on the back of the television.

Option 2: For Subscribers to Scrambled Cable TV Service

If you subscribe to a cable service that requires the use of a Converter/Descrambler box, connect the incoming cable to the Converter/Descrambler box and connect the output of the box to the Antenna Jack on the back of the television. Follow the connections shown below. Set the television to the output of the Converter/Descrambler box (usually channel 3 or 4) and use the Converter/Descrambler box to select channels.

Option 3: For Subscribers to Unscrambled Basic Cable with Scrambled Premium Channels

If you subscribe to a cable service in which basic cable channels are unscrambled and premium channels require the use of a Converter/Descrambler box, you may wish to use a two-set signal splitter (sometimes called a "two-set coupler") and an A/B Switch box from the cable installer or an electronics supply store. Follow the connections shown below. With the switch in the "B" position, you can directly tune any unscrambled channels on your TV/DVD. With the switch in the "A" position, tune your TV/DVD to the output of the Converter/Descrambler box (usually channel 3 or 4) and use the box to tune scrambled channels.

Note:

When you use a converter box with your TV/DVD, there may be features that you cannot program using the remote control, such as labeling channels, blocking channels, and programming your favorite channels.

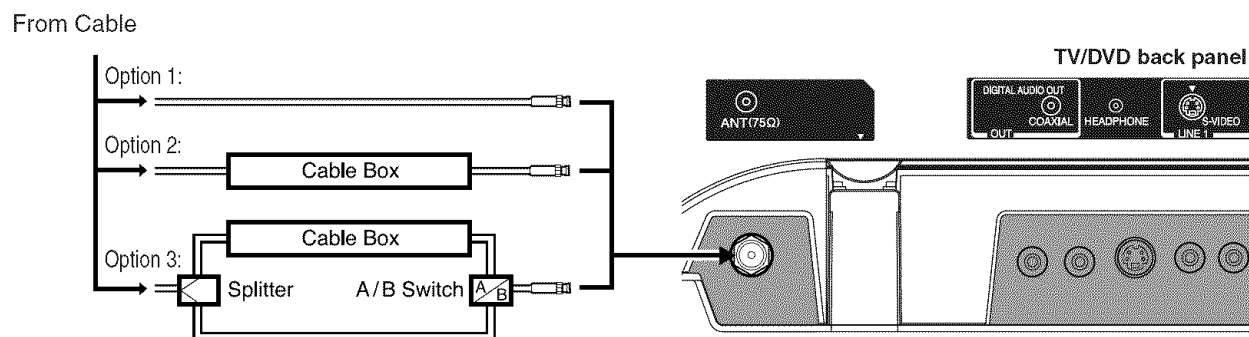

Connecting a satellite receiver and a VCR

This connection allows you to watch satellite, VCR, or TV programs. You can record from the satellite receiver and TV, as well as record one TV channel while watching another channel.

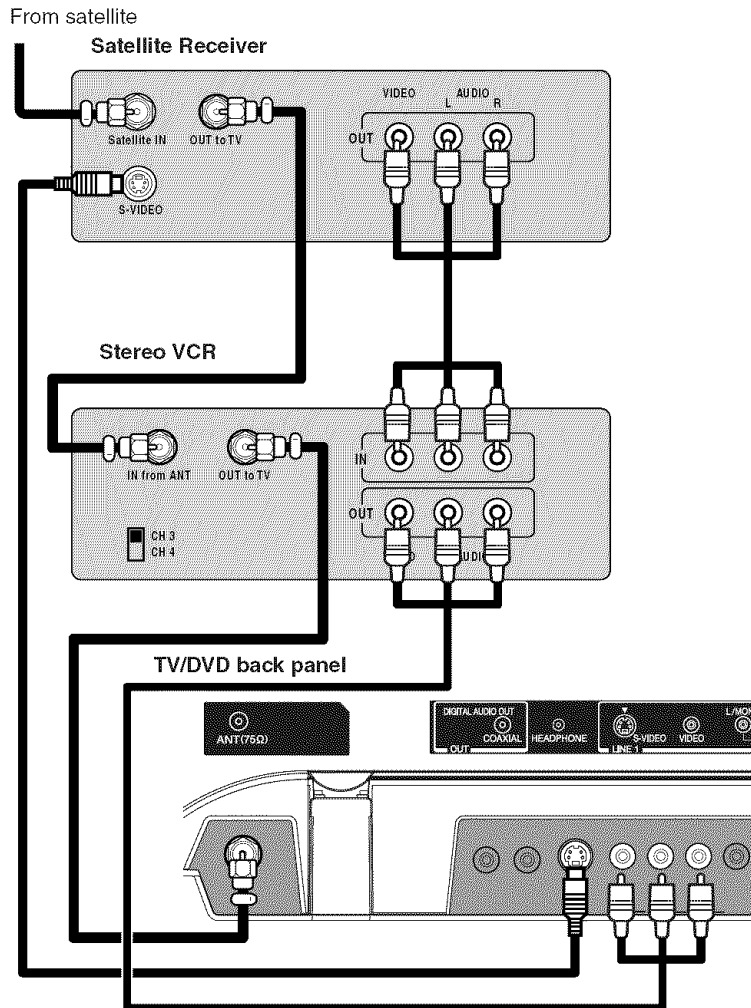

You will need:

- three coaxial cables
- two sets of standard A/V cables
- one S-video cable

Note:

You can use a standard video cable instead of the S-video cable, but the picture quality will decrease. If you use an S-video cable between the TV/DVD and DVD player/satellite receiver, make the audio connections but remove the standard video cable. Do not connect both an S-video and a standard video cable to LINE1 at the same time or the picture performance will be unacceptable.

The unauthorized recording, use, distribution or revision of television programs, videotapes, DVDs, and other materials is prohibited under the Copyright Laws of the United States and other countries, and may subject you to civil and criminal liability.

Introduction

Connecting your TV/DVD

Setting up your TV/DVD

Using the TV/DVD's Features

DVD Playback

Appendix

Connecting a DVD player with ColorStream® (component video) and a VCR

This connection allows you to watch DVD, VCR, or TV programs and record TV programs. You can record from one source while watching a program from another source. Your TV/DVD has ColorStream (component video) inputs. Connecting your TV/DVD to a component video compatible DVD player, such as a Toshiba DVD player with ColorStream®, can greatly enhance picture quality and performance.

You will need:

- two coaxial cables
- one set of standard A/V cables
- one set of component video cables
- one pair of standard audio cables

Note:

The ColorStream HD jacks can be used with Progressive (480p, 720p) and Interlaced (480i, 1080i) scan systems. A 1080i signal will provide the best picture performance.

The unauthorized recording, use, distribution or revision of television programs, videotapes, DVDs, and other materials is prohibited under the Copyright Laws of the United States and other countries, and may subject you to civil and criminal liability.

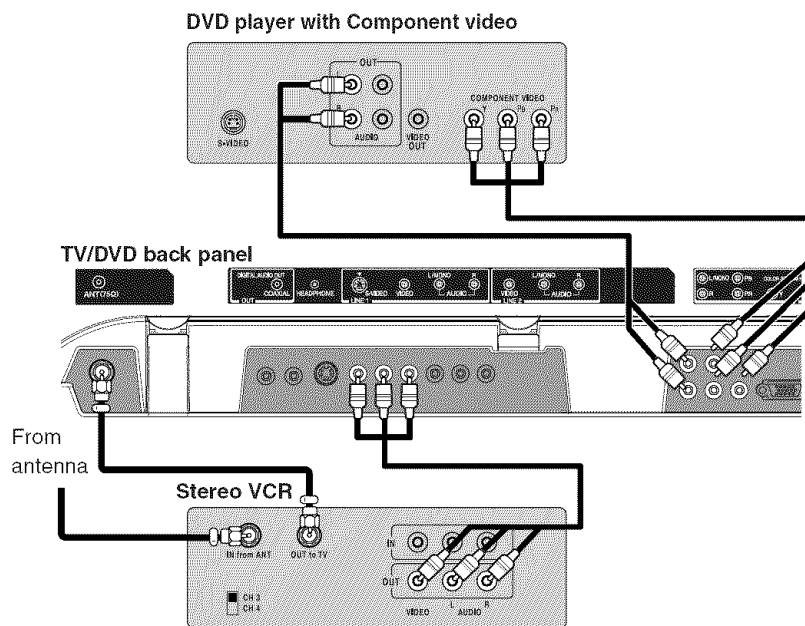

Connecting a DTV receiver/set-top box with ColorStream® (component video) and a VCR

This connection allows you to watch DTV (digital TV), VCR, and TV programs, and record DTV and TV programs.

Your TV/DVD has ColorStream® (component video) inputs. Connecting your TV/DVD to a DTV receiver with component video can greatly enhance picture quality and realism.

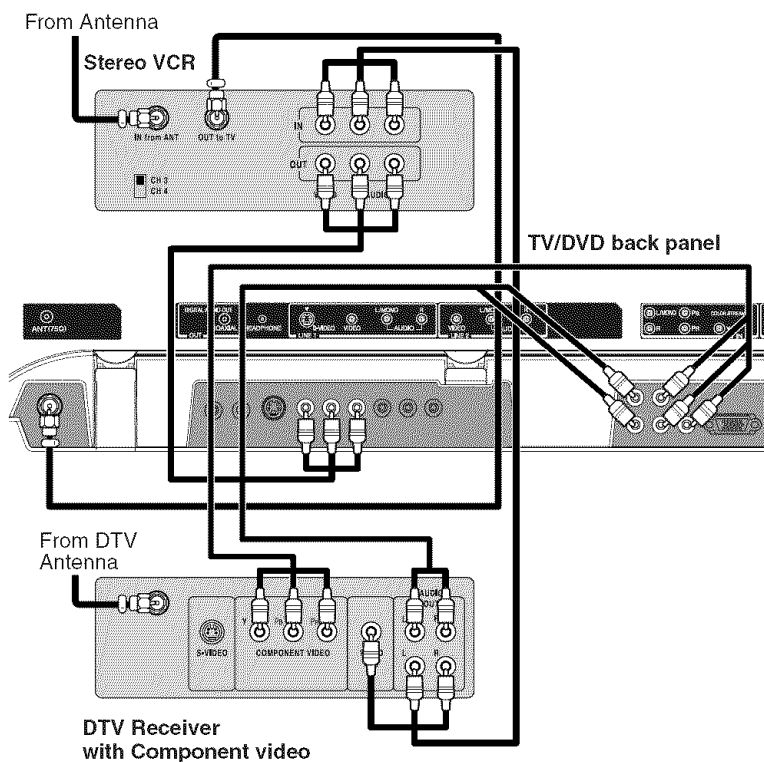

You will need:

- three coaxial cables
- two sets of standard A/V cables
- one set of standard audio cables
- one set of component video cables

Note:

The ColorStream HD jacks and HDMI jacks can be used with Progressive (480p, 720p) and Interlaced (480i, 1080i) scan systems.

If your DTV receiver does not have component video, use the S-video and standard audio connections instead. Do not connect both an S-video and a standard video cable to LINE1 at the same time or the picture performance will be unacceptable. For an HDMI connection, see page 17.

The unauthorized recording, use, distribution, or revision of television programs, videotapes, DVDs, and other materials is prohibited under the Copyright Laws of the United States and other countries, and may subject you to civil and criminal liability.

Introduction

Connecting your TV/DVD

Setting up your TV/DVD

Using the TV/DVD's Features

DVD Playback

Appendix

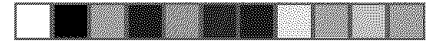
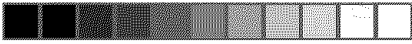

Connecting a camcorder

This connection allows you to watch videos recorded on a camcorder.

You will need:

- one set of standard AV cables

Connecting your TV/DVD

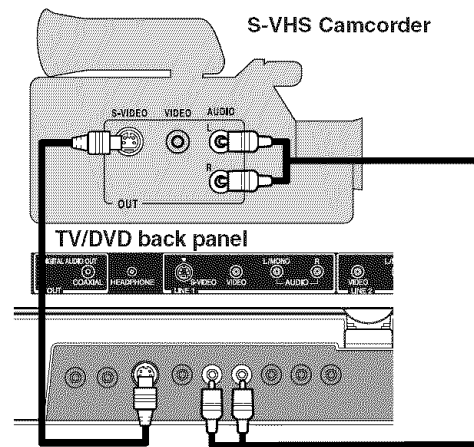
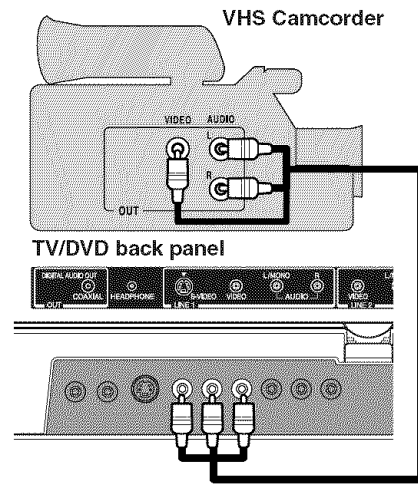

You will need:

- one S-video cable
- one pair of standard audio cables

Note:

For better picture quality, if your camcorder has S-video, you can use an S-video cable (plus the standard audio cables) instead of a standard video cable. Do not connect both a standard video cable and an S-video cable at the same time, or the picture performance will be unacceptable.

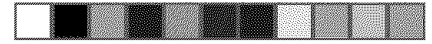
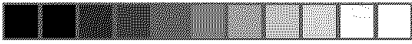

Connecting an HDMI™ or a DVI device

The HDMI input on your TV receive digital audio and uncompressed digital video from an HDMI source device, or uncompressed digital video from a DVI (Digital Video Interface) source device.

This input is designed to accept HDCP (High-Bandwidth Digital-Content Protection) program material in digital form from EIA/CEA-861/861B-compliant^[1] consumer electronic devices (such as a set-top box or DVD player with HDMI or DVI output).

The HDMI input is designed for best performance with high definition video signals. They will accept and display 480i, 480p, 720p and 1080i signals.



NOTE: DO NOT CONNECT A PC USING THE HDMI INPUT.

ALWAYS use the VGA port provided to connect a PC.

To connect an HDMI device, you will need:

- one HDMI cable (type A connector)

For proper operation, it is recommended that you use as short an HDMI cable as possible. You should not encounter difficulty if you use an HDMI cable that is shorter than 16.4 ft (5m).

HDMI cable transfers both video and audio. Separate analog audio cables are not required (see illustration below).

You must set the HDMI audio input setting to “HDMI” in the AUDIO menu (see page 42).

Some CDVs (Video CDs) may not output digital audio signals. In that case, you may hear sound by connecting analog audio cables. If you do use analog audio cables for this reason, you will need to set the HDMI audio input setting to “DVI” to hear the analog audio (see page 42).

Note: If you connect an HDMI device and analog audio cables and play media with digital audio output, to hear digital audio you must set the HDMI audio input setting to “HDMI” (page 42).

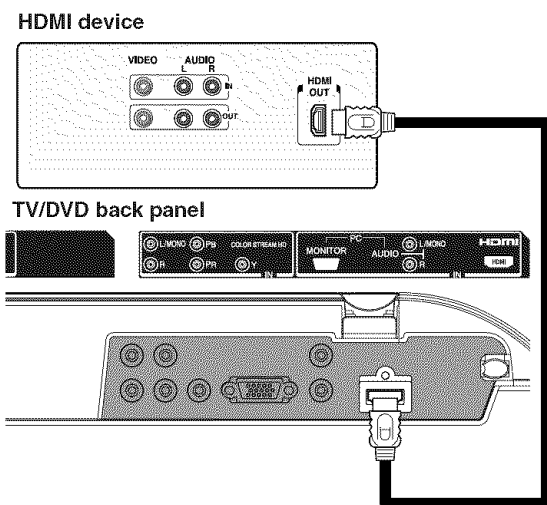

[1] EIA/CEA-861/861B compliance covers the transmission of uncompressed digital video with high-bandwidth digital content protection, which is being standardized for reception of high-definition video signals.

Because this is an evolving technology, it is possible that some devices may not operate properly with the TV.

To ensure that the HDMI or DVI device is reset properly, it is recommended that you follow these procedures:

- When turning on your electronic components, **turn on the TV/DVD first**, and then the HDMI or DVI device.
- When turning off your electronic components, **turn off the HDMI or DVI device first**, and then the TV/DVD.

To connect a DVI device, you will need:

- one HDMI-to-DVI adapter cable (HDMI type A connector)

For proper operation, the length of an HDMI-to-DVI adapter cable should not exceed 9.8 ft (3m). The recommended length is 6.6 ft (2m).

- one pair of standard analog audio cables

An HDMI-to-DVI adapter cable transfers only video. Separate analog audio cables are required (see illustration below).

You must set the HDMI audio input setting to “DVI” in the AUDIO menu (see page 42).

DVI device

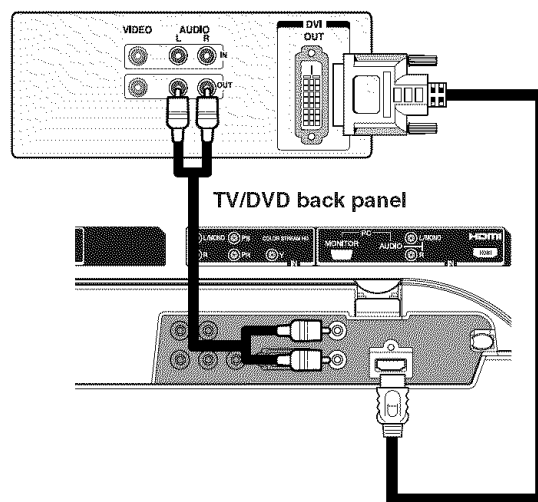

HDMI, the HDMI logo, and High-Definition Multimedia Interface are trademarks or registered trademarks of HDMI Licensing, LLC.

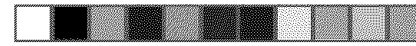
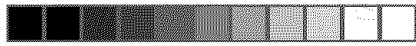

Connecting your TV/DVD

Connecting an amplifier equipped with a Dolby® Digital decoder

Dolby Digital

Dolby Digital is the surround sound technology used in theaters showing the latest movies, and is now available to reproduce this realistic effect in the home. You can enjoy motion picture and live concert DVD video discs encoded via the Dolby Digital recording system with this dynamic realistic sound by connecting the TV/DVD to a 6 channel amplifier equipped with a Dolby Digital decoder or Dolby Digital processor. If you have a Dolby Surround Pro Logic decoder, you will obtain the full benefit of Pro Logic from the same DVD movies that provide full 5.1-channel Dolby Digital soundtracks, as well as from titles with the Dolby Surround mark.

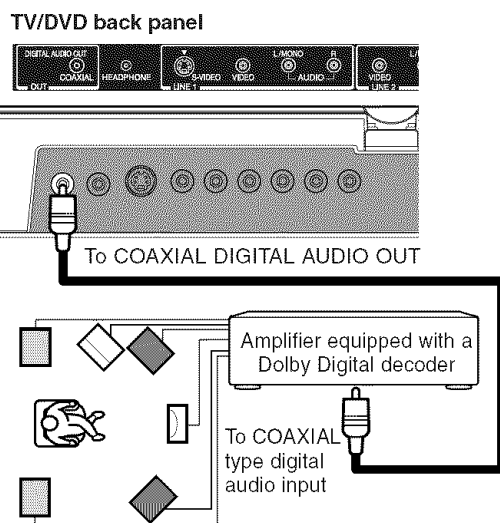

You will need:

- one coaxial cable

Note:

- *DO NOT connect the COAXIAL DIGITAL AUDIO OUT jack of the TV/DVD to the AC-3 RF input of a Dolby Digital Receiver. This input on your A/V Receiver is reserved for Laserdisc use only and is incompatible with the COAXIAL DIGITAL AUDIO OUT jack of the TV/DVD.*
- *Connect the COAXIAL DIGITAL AUDIO OUT jack of the TV/DVD to the "COAXIAL" input of a Receiver or Processor.*
- *Refer to the owner's manual of the connected equipment as well.*
- *The output sound of the TV/DVD has a wide dynamic range. Be sure to adjust the receiver's volume to a moderate listening level. Otherwise, the speakers may be damaged by a sudden high volume sound.*
- *Turn off the amplifier before you connect or disconnect the TV/DVD's power cord. If you leave the amplifier power on, the speakers may be damaged.*

Manufactured under license from Dolby Laboratories. Dolby and the double-D symbol are trademarks of Dolby Laboratories.

Connecting an amplifier equipped with a DTS® decoder

Digital Theater Systems (DTS)

DTS is a high quality surround technology used in theaters and now available for home use, on DVD video discs or audio CDs. If you have a DTS decoder or processor, you can obtain the full benefit of 5.1 channel DTS encoded sound tracks on DVD video discs or audio CDs.

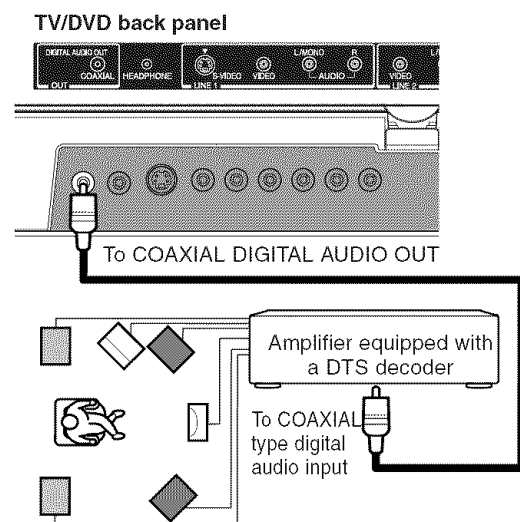

You will need:

- one coaxial cable

Note:

- *Connect the COAXIAL DIGITAL AUDIO OUT jack of the TV/DVD to the "COAXIAL" input of a Receiver or Processor.*
- *Refer to the owner's manual of the connected equipment as well.*
- *The output sound of the TV/DVD has a wide dynamic range. Be sure to adjust the receiver's volume to a moderate listening level. Otherwise, the speakers may be damaged by a sudden high volume sound.*
- *Turn off the amplifier before you connect or disconnect the TV/DVD's power cord. If you leave the amplifier power on, the speakers may be damaged.*

DTS and DTS Digital Out are trademarks of Digital Theater Systems, Inc.

Connecting an amplifier equipped with an MPEG audio decoder

MPEG2 sound

You can enjoy motion picture and live concert DVD video discs encoded via the MPEG2 recording system with dynamic realistic sound by connecting an amplifier equipped with an MPEG2 audio decoder or MPEG2 audio processor.

TV/DVD back panel

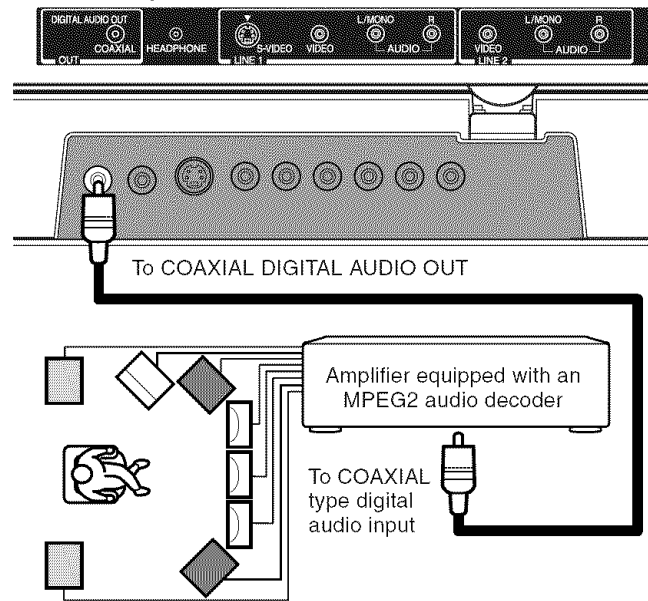

Connecting an amplifier equipped with a digital audio input

2 channel digital stereo

You can enjoy the dynamic sound of 2 channel digital stereo by connecting an amplifier equipped with a digital audio input and speaker system (right and left front speakers).

TV/DVD back panel

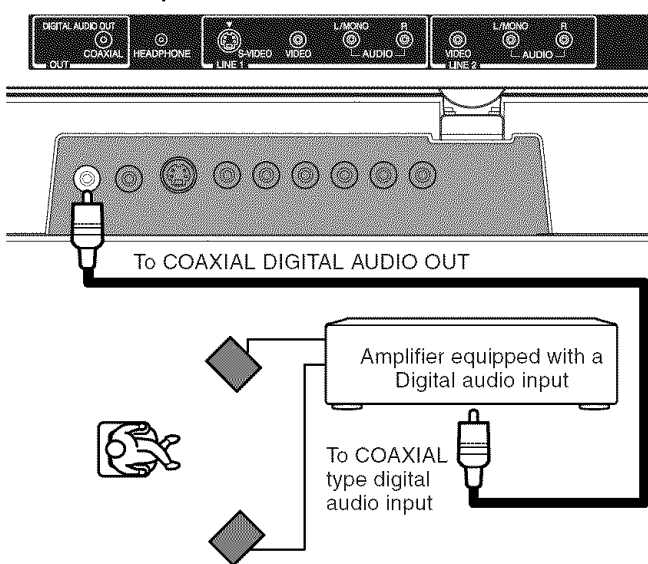

You will need:

- one coaxial cable

Note:

- Connect the COAXIAL DIGITAL AUDIO OUT jack of the TV/DVD to the "COAXIAL" input of a Receiver or Processor.
- Refer to the owner's manual of the connected equipment as well.
- The output sound of the TV/DVD has a wide dynamic range. Be sure to adjust the receiver's volume to a moderate listening level. Otherwise, the speakers may be damaged by a sudden high volume sound.
- Turn off the amplifier before you connect or disconnect the TV/DVD's power cord. If you leave the amplifier power on, the speakers may be damaged.

You will need:

- one coaxial cable

Note:

- PCM audio is limited to DVD or CD playback.
- Connect the COAXIAL DIGITAL AUDIO OUT jack of the TV/DVD to the "COAXIAL" input of a Receiver or Processor.
- Refer to the owner's manual of the connected equipment as well.
- The output sound of the TV/DVD has a wide dynamic range. Be sure to adjust the receiver's volume to a moderate listening level. Otherwise, the speakers may be damaged by a sudden high volume sound.
- Turn off the amplifier's before you connect or disconnect the TV/DVD's power cord. If you leave the amplifier power on, the speakers may be damaged.

Introduction

Connecting your TV/DVD

Setting up your TV/DVD

Using the TV/DVD's Features

DVD Playback

Appendix

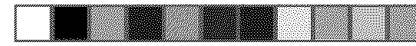
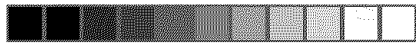

Connecting your TV/DVD

Connecting a PC (personal computer)

Before you connect this TV/DVD to your PC, change the adjustment of your PC's Resolution and Refresh rate. See "Monitor display modes" on right.

Connect one end of a (male to male) VGA cable to the video card of the computer and the other end to the VGA connector PC at the side of the TV/DVD. Fix the connectors firmly with the screws on the plug. In case of a Multimedia computer, connect the audio cables to the audio outputs of your Multimedia computer and to the AUDIO L and R connectors of the PC IN jacks of the TV/DVD.

Set the video input source to PC mode (see "Selecting the video input source" on page 31 and "Picture/Audio adjustments in the PC mode" on page 43). The TV/DVD can be used as a computer monitor.

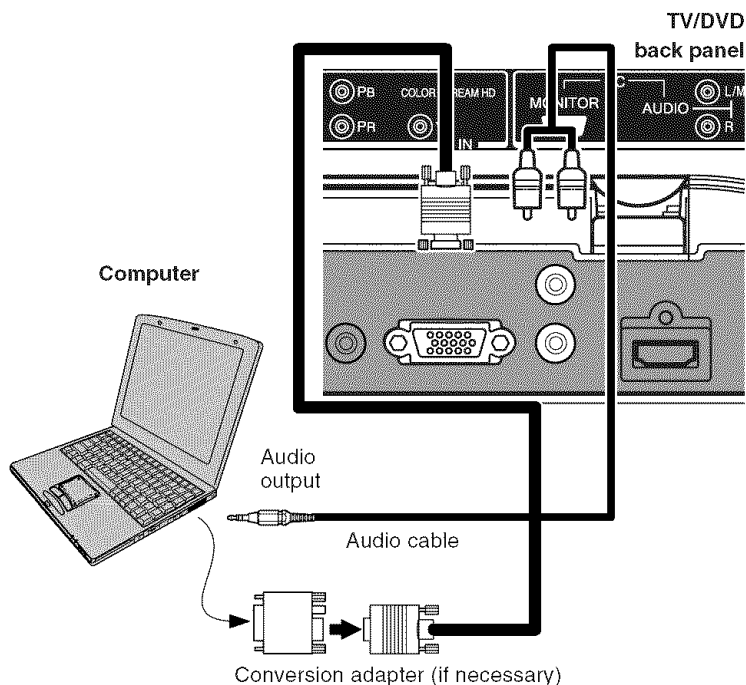

You will need:

- one VGA (15-pin) computer cable
- one PC audio cable

Monitor display modes		
Mode	Resolution	Refresh rate
VGA	640x480	60Hz
VGA	720x400	70Hz
WVGA	848x480	60Hz
SVGA	800x600	60Hz
XGA	1024x768	60Hz
WXGA	1280x720	60Hz
WXGA	1280x768	60Hz
WXGA	1360x768	60Hz

Note:

- Some PC models cannot be connected to this TV/DVD.
- An adapter is not needed for computers with a DOS/V compatible mini D-sub 15-pin terminal.
- The on-screen displays will have a different appearance in PC mode than in TV mode.
- If your PC display output corresponds to a WVGA or a WXGA resolution as indicated in the chart above (example: WXGA 1360 x 768), you must set the WVGA INPUT or WXGA INPUT to the ON position in the PC Picture menu in the TV (see page 43).



NOTE: DO NOT CONNECT A PC USING THE HDMI INPUT.

ALWAYS use the VGA port provided to connect a PC.

Setting up your TV/DVD

Using the remote control

Installing the remote control batteries

To install the batteries:

1. Open the battery cover on the back of the remote control.

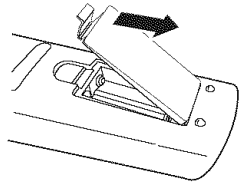

2. Install two "AAA" size batteries. Match the + and - signs on the batteries to the signs on the battery compartment.

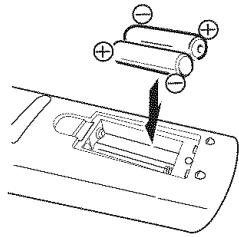

3. Close the battery cover on the remote control until the lock snaps.

Note:

The TV/DVD remote control may not operate your VCR, DVD player, or cable TV converter. Refer to the owner's manual supplied with your other devices to see which features may be available. Additionally, the remote control for this TV/DVD may not support certain features available on the original remote controls for your other devices, in which case it is suggested that you use the original remote control for the applicable device.

Caution:

- Never throw batteries into a fire.

Note:

- Be sure to use AAA size batteries.
- Dispose of batteries in a designated disposal area.
- Batteries should always be disposed of with the environment in mind. Always dispose of batteries in accordance with applicable laws and regulations.
- If the remote control does not operate correctly, or if the operating range becomes reduced, replace batteries with new ones.
- When necessary to replace batteries in the remote control, always replace both batteries with new ones. Never mix battery types or use new and used batteries in combination.
- Always remove the batteries from the remote control if they are dead or if the remote control is not to be used for an extended period of time. This will prevent battery acid from leaking into the battery compartment.

Introduction

Connecting
your TV/DVD

Setting up
your TV/DVD

Using the
TV/DVD's Features

DVD Playback

Appendix

Learning about the remote control

- EJECT** eject a disc (page 45)
- TV/DVD** switches between TV/Video input/PC and DVD
- SLEEP** programs the TV/DVD to turn off at a set time (page 37)
- POWER** turns the TV/DVD on and off
- CHANNEL NUMBERS** allow direct access to channels
- DISPLAY** displays status information on-screen (page 42)
- JUMP** locates the desired point to play back (page 47)
- SUBTITLE** sets subtitle (page 52)
- CH \wedge / \vee** cycles through programmed channels (page 24)
- VOL + / -** adjusts the volume level
- AUDIO SELECT** switches the sound of TV/DVD and changes sound track languages (page 52)
- INPUT** selects the video input source (page 31)
- ZOOM** allows you to zoom in on the frame image (page 47)
- MUTE** turns off the sound (page 40)
- PLAY MODE** sets repeat playback (page 49)
- DVD MENU** allows access to DVD menu or display a thumbnail list for JPEG (pages 51,56)
- $\blacktriangle\blacktriangledown\blacktriangleleft\blacktriangleright$** selects or adjust on-screen menus (page 23)
- FAV \blacktriangle / \blacktriangledown (Favorite Channels)** cycles through the channels you programmed as favorite channels (page 25)
- ENTER** sets programmed menu information (page 23)
- MENU/SETUP** allows access to programming menus (page 23)
- EXIT/CANCEL** exits programming menus or resets information in the menu (pages 23, 47)
- PAUSE** pauses a DVD, VCD, CD Audio (page 45)
- PLAY** plays a DVD, VCD, CD Audio (page 44)
- STOP** stops a DVD, VCD, CD Audio (page 44)
- CH RTN** returns to the last viewed channel (page 25),
- SKIP $\blacktriangleleft\blacktriangleright\blacktriangleleft\blacktriangleright$** skips chapter/track (page 46)
- REV** rewinds a DVD, VCD, CD Audio (page 46)
- FF** fast forwards a DVD, VCD, CD Audio, forwards playback (page 46)
- CLOSED CAPTION** switch between TV/Caption/Text in Closed Caption mode (page 37)
- SLOW \blacktriangleleft / \blacktriangleright** plays forward/reverse slowmotion (page 46)
- ANGLE** changes playback angle (page 51)
- MARKER** index of DVD/VCD (page 48)
- TOP MENU** allows access to DVD Top menu or display a file browser screen for JPEG (pages 51,56)
- RETURN** clears DVD setup menu (page 59)
- REPEAT A-B** repeats playback between A and B (page 49)
- GAME** game mode (page 24)
- PIC SIZE** cycles through the five picture sizes: Natural, TheaterWide 1, TheaterWide 2, TheaterWide 3 and full (page 33)

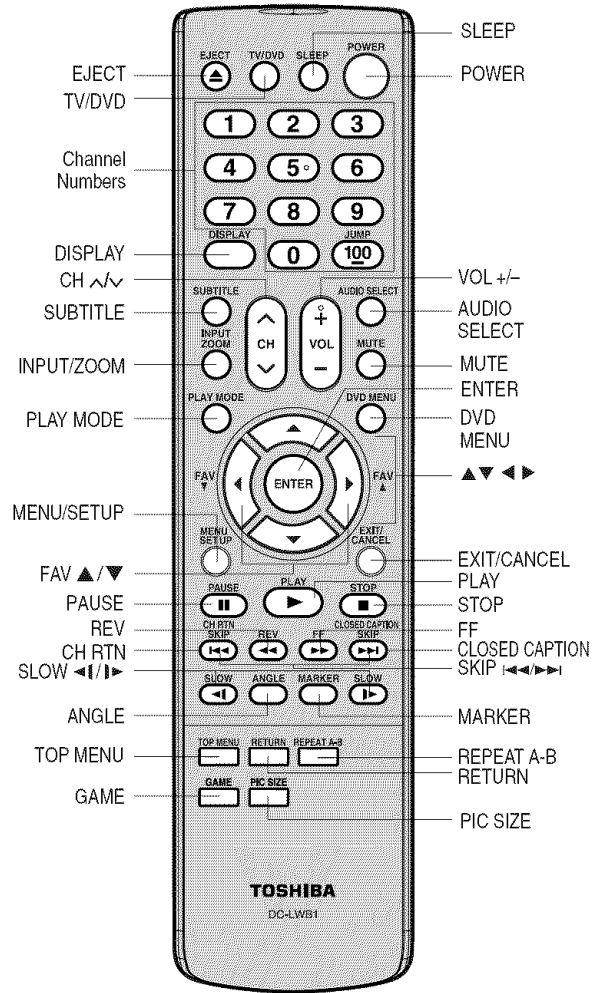

- Aim the remote control at the TV/DVD's remote sensor (see Illustration) and press the buttons to operate.
- Operate the remote control within a 30 degree on either side of the remote sensor, up to a distance of approx. 16 ft. (5m).

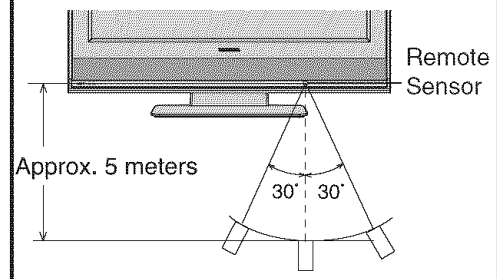

Starting setup

The STARTING SETUP feature appears the first time you turn on the TV/DVD, and helps you select the menu language, specify the TV/CABLE setting, and program channels automatically.

IMPORTANT: Make sure that the antenna or cable TV system is connected.

1. Press POWER to turn on the TV/DVD. The starting setup function begins and the language setup menu appears on the screen. Press ▲ or ▼ to select your desired language, then press ENTER.
2. Press ▲ or ▼ to select "TV" or "CABLE", then press ENTER.
3. Press ▲ or ▼ to select "START", then press ENTER. If you select "CANCEL" and press ENTER, the STARTING SETUP stops and changes to the TV screen.
4. Now the "CH PROGRAM" starts. After the starting setup is completed, the TV channel appears on the screen.
 - If you press the EXIT button in the process of "CH PROGRAM" the STARTING SETUP stops and changes to the TV screen.

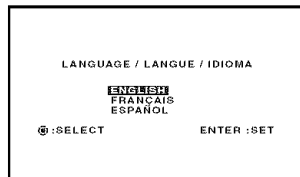

After you have installed the batteries and programmed the remote control, you need to set some preferences on the TV/DVD using the menu system. You can access the menu system with the buttons on the remote control.

- When you make a menu selection, your changes are immediate. You do not have to press MENU or EXIT to see your changes.
- After one minute, the menu screen will automatically close if you do not make a selection. Your changes will still be saved.
- When you have finished programming the menus, press EXIT.

Changing the on-screen display language

You can choose from three different languages (English, French and Spanish) for the on screen displays. Adjustment menus and messages will appear in the language of your choice.

To select a language:

1. Press MENU, then press ◀ or ▶ until the SETUP menu appears.

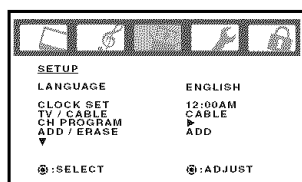

2. Press ▲ or ▼ to highlight LANGUAGE.

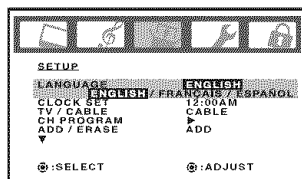

3. Press ◀ or ▶ to highlight your desired language.

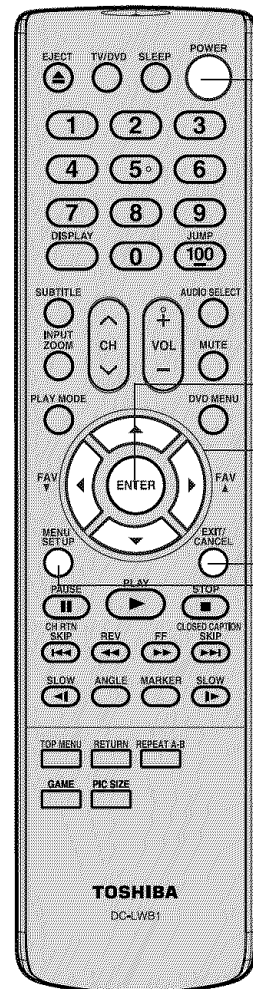

POWER

ENTER

▲▼▶

EXIT MENU

Introduction

Connecting your TV/DVD

Setting up your TV/DVD

Using the TV/DVD's Features

DVD Playback

Appendix

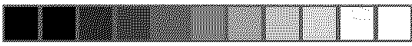

Setting up
your TV/DVD

Adding channels to the TV/DVD's memory

When you press CH \wedge / \vee , your TV/DVD will stop only on the channels you have stored in the TV/DVD's channel memory. Follow the steps below to program channels into the channel memory.

Programming channels automatically

Your TV/DVD can automatically detect all active channels and store them in its memory. After the TV/DVD has stored the channels in its memory automatically, you can add or erase channels manually.

To add channels automatically:

1. Press MENU, then press \blacktriangleleft or \blacktriangleright to display the SETUP menu.
2. Press \blacktriangle or \blacktriangledown until the TV/CABLE selection is highlighted.
3. Press \blacktriangleleft or \blacktriangleright to highlight either TV or CABLE, depending on which you use.
If you use an antenna, choose TV.
If you use cable, choose CABLE.
4. Press \blacktriangledown until the CH PROGRAM selection is highlighted.
5. Press \blacktriangleleft or \blacktriangleright to start channel programming. The TV/DVD will automatically cycle through all the TV or Cable channels (depending on which you selected), and store all active channels in the channel memory.
While the TV/DVD is cycling through the channels, the message "PROGRAMMING NOW PLEASE WAIT" appears.
6. When channel programming is complete, the message "COMPLETED" appears.
7. Press CH \wedge / \vee to view the programmed channels.

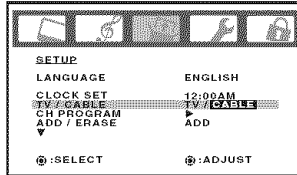

Adding and erasing channels manually

After you have programmed the channels automatically, you can add or erase specific channels manually.

To add or erase channels manually:

1. Select the channel you want to add or erase. If adding channels, you must select the channel to add using the Channel Number buttons.
2. Press MENU, then press \blacktriangleleft or \blacktriangleright to display the SETUP menu.
3. Press \blacktriangle or \blacktriangledown to highlight ADD/ERASE.
4. Press \blacktriangleleft or \blacktriangleright to select ADD or ERASE, whichever function you want to perform.
5. Repeat steps 1-4 for other channels you want to add or erase.

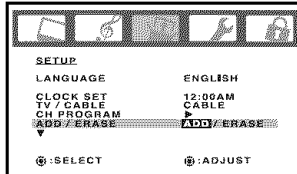

Changing channels

To change to the next programmed channel:

Press CHANNEL \wedge / \vee on the TV/DVD or CH \wedge / \vee on the remote control.

To change to a specific channel (programmed or unprogrammed):

Press the Channel Number buttons (0-9 and 100) on the remote control. For example, to select channel 125, press 100, 2, 5.

Game mode

After connecting a TV Game to the unit, press GAME. The TV screen changes to the Game mode.

- The Game mode screen is adjusted to the suitable brightness for your eyes.
- If GAME is pressed during standby mode, the unit turns on automatically and the Game mode screen appears on the screen.

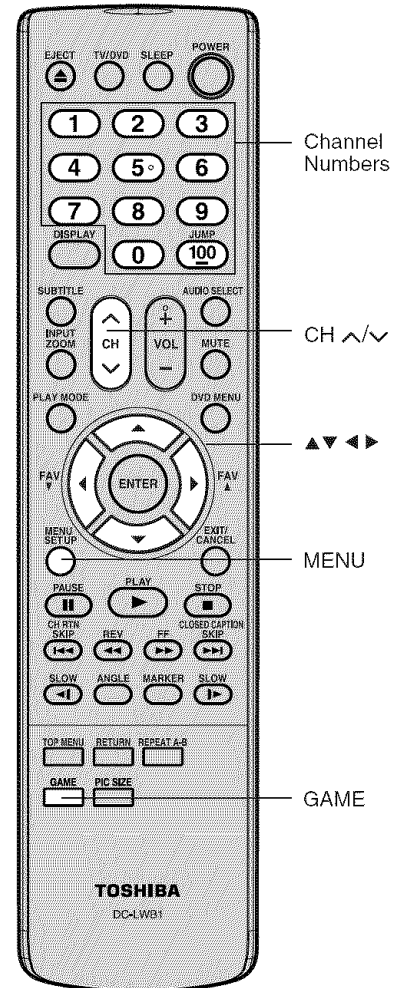

In addition to cycling through your programmed channels, the CH \wedge / \vee buttons will also cycle through the video input sources (page 31) in the order illustrated below.

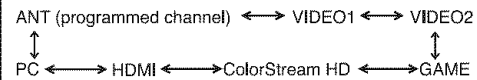

Using the TV/DVD's features

Adjusting the channel settings

Switching between two channels

You can switch between two channels without entering an actual channel number each time.

To switch between two channels:

1. Select the first channel you want to view.
2. Select a second channel using the Channel Number buttons (0-9, 100).
3. Press CH RTN. The previous channel will be displayed.

Each time you press CH RTN, the TV/DVD will switch back and forth between the two channels. The CH RTN feature is available for the video input sources also.

Programming your favorite channels

You can preset up to 12 of your favorite channels using the Favorite Channel Programming feature. Because this feature scans through only your favorite channels, it allows you to skip other channels you do not normally watch.

You can still use CH \wedge / \vee to scan through all the channels you programmed in the TV's memory.

To program your favorite channels:

1. Select a channel you want to program.
2. Press MENU, then press \leftarrow or \rightarrow to display the OPTION menu.
3. Press \blacktriangle or \blacktriangledown to highlight FAVORITE CH.

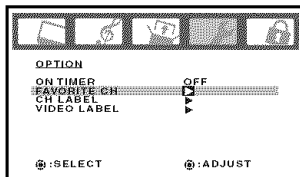

4. Press \leftarrow or \rightarrow to display the FAVORITE CH menu. SET/CLEAR will be highlighted.

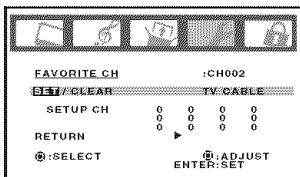

5. Press \leftarrow or \rightarrow to highlight SET and press ENTER.
6. Press EXIT to return to normal viewing.
7. Repeat steps 1-6 for up to 12 channel.

To select your favorite channels:

Press the FAV \blacktriangle / \blacktriangledown buttons on the remote control to select your favorite channels.

The FAV \blacktriangle / \blacktriangledown buttons will not work until you have programmed one of more favorite channels.

To clear your favorite channels:

1. Select a channel you want to clear from the favorite channel memory.
2. Press MENU, then press \leftarrow or \rightarrow to display the OPTION menu.
3. Press \blacktriangle or \blacktriangledown to highlight FAVORITE CH.
4. Press \leftarrow or \rightarrow to display the FAVORITE CH menu. SET/CLEAR will be highlighted.
5. Press \leftarrow or \rightarrow to highlight CLEAR.

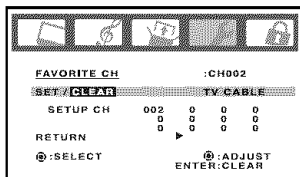

6. Press ENTER until "0" replaces the channel number you want to erase.
7. Press EXIT to return to normal viewing.
8. Repeat steps 1-7 for the other channels.

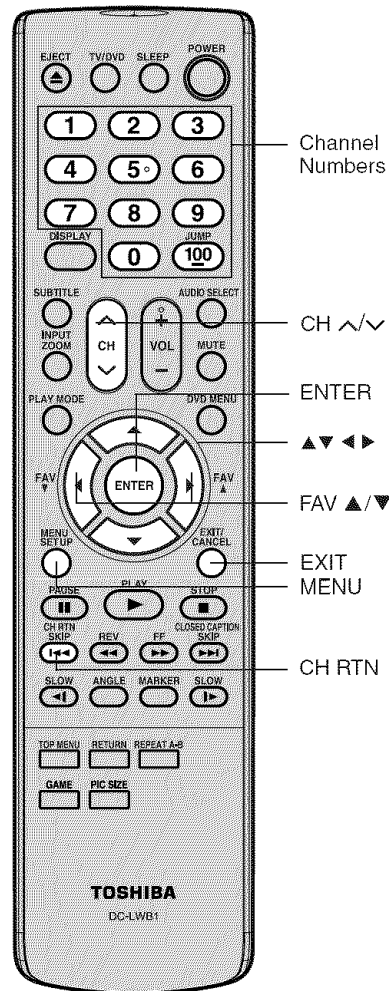

Introduction

Connecting
your TV/DVD

Setting up
your TV/DVD

Using the
TV/DVD's Features

DVD Playback

Appendix

Using the LOCKS menu

Note : The V-Chip feature is available for the U.S. V-Chip system only. The Canadian V-Chip Feature system is not supported.

You can prevent others from viewing certain programs or channels by blocking them using the V-Chip feature.

Selecting a password

Before you can use the V-Chip Feature to block programs and channels, you must select a password. The password you select prevents others from changing the rating limits you set.

To select your password and access the LOCKS menu:

1. Press MENU, then press ◀ or ▶ to highlight the LOCKS menu.
2. Press ▲ or ▼ to display the password entering mode.

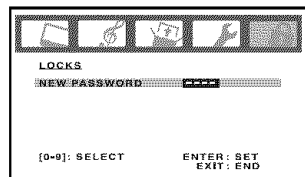

3. Use the Channel Number buttons (0-9) to enter your password. If you are accessing the LOCKS menu for the first time, select a four-digit number to be your password. Press ENTER.

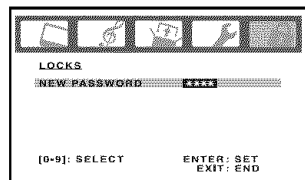

4. Enter the password again to confirm it, and then press ENTER. The LOCKS menu appears. If the wrong password is entered, "ERROR" blinks about 4 seconds.

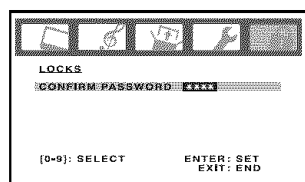

5. You may now set up the LOCKS menu. See "Using the V-Chip (parental control) feature" (page 27), "Locking channels" (page 28), "Locking the video inputs" (page 28), "Setting the GameTimer™" (page 29) or "Using the panel lock feature" (page 29).

To change your password:

1. Press MENU, then press ◀ or ▶ to display the LOCKS menu.
2. Press ▲ or ▼ to display the password entering mode.
3. Use the Channel Number buttons (0-9) to enter your password. Press ENTER. The LOCKS menu appears.
4. Press ▲ or ▼ to highlight NEW PASSWORD and press ◀ or ▶ to display the NEW PASSWORD menu.
5. Use the Channel Number buttons (0-9) to enter a new code. Press ENTER.
6. Enter the password again to confirm it, and then press ENTER.
7. Press EXIT to return to normal viewing.

Note:

The password you programmed is also used in the LOCKS menu; see pages 27-29.

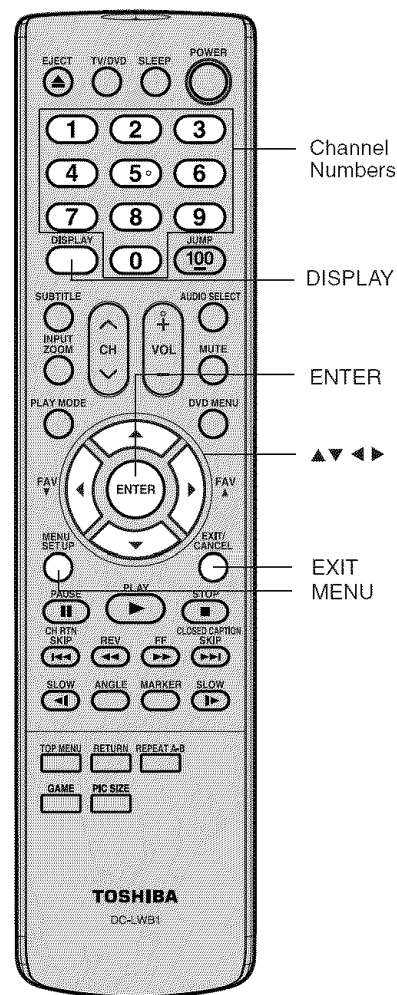

Note:

If you forget your password, press DISPLAY four times within five seconds while the TV/DVD is in password entering mode. This allows you to reset your password.

Using the V-Chip (parental control) feature

The Motion Picture Association of America (MPAA) uses a rating system to qualify motion picture content. Television broadcasters employ a rating system to qualify the content of television programs, as well. The TV and MOVIE ratings work with the V-Chip feature and allow you to block programs according to the rating limits you set.

To use the V-Chip to block programs by rating:

1. Press MENU, then press ◀ or ▶ to display the LOCKS menu.

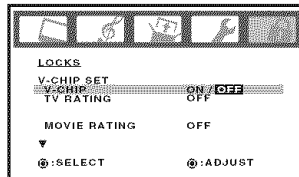

2. Press ▲ or ▼ to display the password entering mode.
3. Use the Channel Number buttons (0-9) to enter your password. Press ENTER. The LOCKS menu appears.

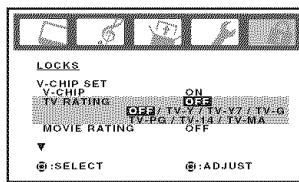

4. Press ▲ or ▼ to highlight V-CHIP.
 - Press ◀ or ▶ to highlight ON to enable V-Chip program blocking by rating.
 - Press ▶ or ▶ to highlight OFF to disable V-Chip program blocking by rating.

5. Press ▲ or ▼ to highlight TV RATING. Then, press ◀ or ▶ to display the desired rating.

- OFF** : TV RATING is not set
- TV-Y** : All children
- TV-Y7** : 7 years old and above
- TV-G** : General audience
- TV-PG** : Parental guidance
- TV-14** : 14 years old and above
- TV-MA** : 17 years old and above

- When you select TV-Y7, TV-PG, TV-14 or TV-MA, press DISPLAY to explain the rating. Press ▲ or ▼ to select the desired rating you want. Press ◀ or ▶ to select the setting "ON" or "OFF", then press ENTER.

6. Press ▲ or ▼ to highlight MOVIE RATING. Then, press ◀ or ▶ to display the desired rating.

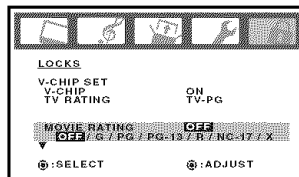

- OFF** : MOVIE RATING is not set
(no movies will be blocked)
- G** : All ages
- PG** : Parental guidance
- PG-13** : Parental guidance less than 13 years old
- R** : Under 17 years old Parental guidance suggested
- NC-17** : 17 years old and above
- X** : Adult only

7. When you are done selecting the ratings, press EXIT to return to normal viewing.

When you try to view a program with a ratings block, a message will appear listing the program's ratings. The program can still be viewed if you press MUTE and then enter your password to temporarily bypass the block.

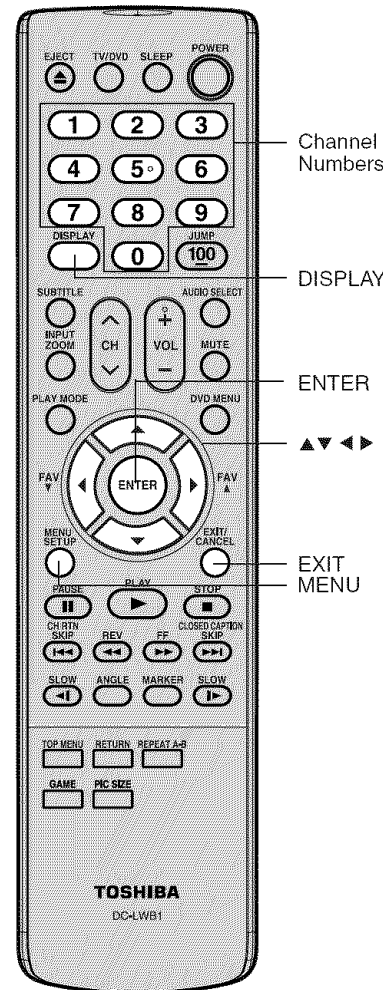

Channel Numbers

DISPLAY

ENTER

EXIT MENU

Introduction

Connecting your TV/DVD

Setting up your TV/DVD

Using the TV/DVD's Features

DVD Playback

Appendix

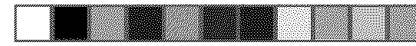
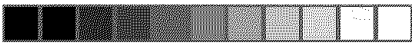

Locking channels

With the CH LOCK feature, you can lock specific channels. You will not be able to tune locked channels unless you clear the setting. You can choose to lock up to nine TV channels and nine cable channels.

To lock channels:

1. Use the Channel Number buttons (0-9 and 100) to display the television channel you wish to lock.
2. Press MENU, then press ◀ or ▶ to display the LOCKS menu.
3. Press ▲ or ▼ to display the password entering mode.
4. Use the Channel Number buttons (0-9) to enter your password, then press ENTER. The LOCKS menu appears.
5. Press ▲ or ▼ to highlight CH LOCK and press ◀ or ▶ to display the CH LOCK menu.
6. Press ◀ or ▶ to select SET to set the channel as one to be locked. Then press ENTER.
7. Repeat steps 1 through 6 to lock other channels. When you have finished locking channels, press EXIT to return to normal viewing.

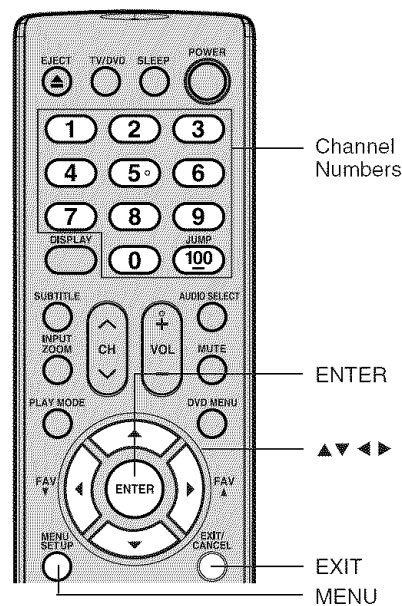
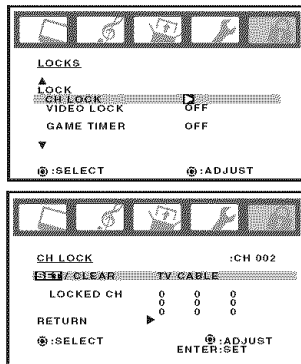

If you try to tune a locked channel, the TV/DVD will not display it, but will display the nearest unlocked channel.

To unlock channels:

1. Press MENU, then press ◀ or ▶ to display the LOCKS menu.
2. Press ▲ or ▼ to display the password entering mode.
3. Use the Channel Number buttons (0-9) to enter your password, then press ENTER. The LOCKS menu appears.
4. Press ▲ or ▼ to highlight CH LOCK and press ◀ or ▶ to display the CH LOCK menu.
5. Press ◀ or ▶ to highlight CLEAR and clear all channels from the list of locked channels. Press ENTER.
6. Press EXIT to return to normal viewing.

Note:

After programming CH LOCK, change channels before turning off the TV/DVD.

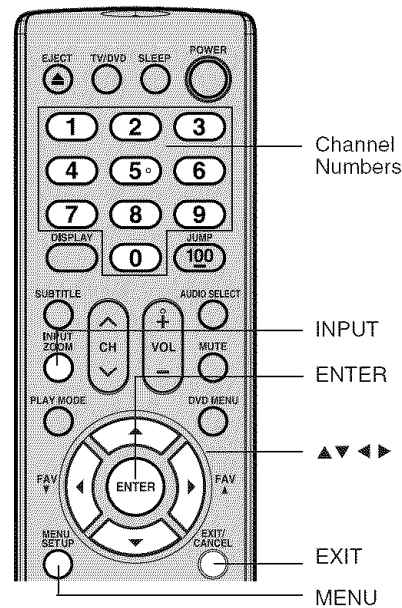

Note:

After programming VIDEO LOCK, change channels or press the INPUT key before turning off the TV/DVD.

Locking the video inputs

With the VIDEO LOCK feature, you can lock out the input sources (VIDEO1, VIDEO2, ColorStream HD, HDMI, PC, GAME) and channels 3 and 4. You will not be able to select the input sources with the INPUT button or Channel buttons unless you clear the setting.

To set up the video lock:

1. Press MENU, then press ◀ or ▶ to display the LOCKS menu.
2. Press ▲ or ▼ to display the password entering mode.
3. Use the Channel Number buttons (0-9) to enter your password, then press ENTER. The LOCKS menu appears.
4. Press ▲ or ▼ to highlight VIDEO LOCK.
5. Press ◀ or ▶ to select:
 - **OFF:** Unlocks all video input sources.
 - **VIDEO:** Locks VIDEO1, VIDEO2, ColorStream HD, HDMI, PC, GAME.
 - **VIDEO +:** Locks VIDEO1, VIDEO2, ColorStream HD, HDMI, PC, GAME, channel 3 and channel 4. This option should be used if you use the antenna terminal to play a video tape.
6. Press EXIT to return to normal viewing.

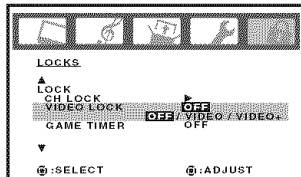

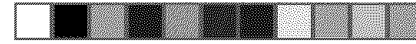
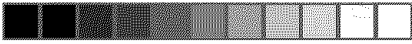

To unlock the video inputs:

1. Press MENU, then press ◀ or ▶ to display the LOCKS menu.
2. Press ▲ or ▼ to display the password entering mode.
3. Use the Channel Number buttons (0-9) to enter your password, then press ENTER. The LOCKS menu appears.
4. Press ▲ or ▼ to highlight VIDEO LOCK and press ◀ or ▶ to highlight OFF.
5. Press EXIT to return to normal viewing.

Setting the GameTimer™

With the GameTimer™ feature, you can automatically activate the VIDEO LOCK feature (VIDEO setting) to set a time limit for playing a video game (30, 60, 90 or 120 minutes).

To set up the GameTimer:

1. Press MENU, then press ◀ or ▶ to display the LOCKS menu.
2. Press ▲ or ▼ to display the password entering mode.
3. Use the Channel Number buttons (0-9) to enter your password, then press ENTER. The LOCKS menu appears.
4. Press ▲ or ▼ to highlight GAME TIMER.
5. Press ◀ or ▶ to select a time limit (30 minutes, 60 minutes, 90 minutes, 120 minutes or OFF).
6. Press EXIT to return to normal viewing. After the GameTimer is programmed, the display will appear briefly every ten minutes to remind you that the GameTimer is operating. When the programmed time is reached, the TV/DVD will change channels automatically and enter VIDEO LOCK mode.

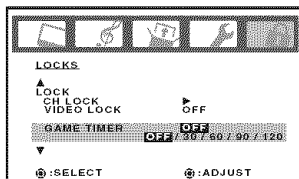

Note:

You can enjoy playing video games on this TV/DVD; however, certain video games that utilize so-called "light gun" joysticks for shooting at on-screen targets may not work with this TV/DVD.

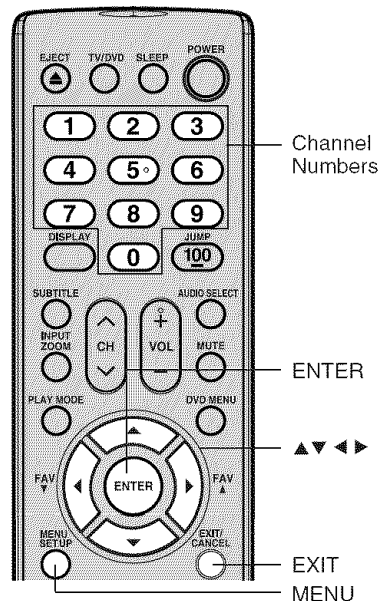

Using the panel lock feature

You can lock the top panel controls to prevent your settings from being changed accidentally (by children, for example). When the panel lock is in ON, all control buttons on the TV/DVD top panel (except POWER) do not operate.

To lock the panel controls:

1. Press MENU, then press ◀ or ▶ to display the LOCKS menu.
 2. Press ▲ or ▼ to display the password entering mode.
 3. Use the Channel Number buttons (0-9) to enter your password, then press ENTER. The LOCKS menu appears.
 4. Press ▲ or ▼ to highlight PANEL LOCK and press ◀ or ▶ to highlight ON.
- If a button on the top panel is pressed, the message "NOT AVAILABLE" appears.

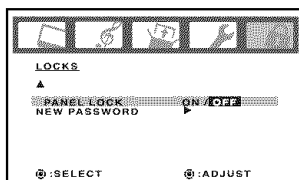

You also can unlock the panel controls using the menus:

1. Press MENU, then press ◀ or ▶ to display the LOCKS menu.
2. Press ▲ or ▼ to display the password entering mode.
3. Use the Channel Number buttons (0-9) to enter your password, then press ENTER. The LOCKS menu appears.
4. Press ▲ or ▼ to highlight PANEL LOCK, and then press ◀ or ▶ to highlight OFF.

To unlock the panel controls using the TV/DVD controls:

Press and hold the VOLUME – button on the TV/DVD top panel for about 10 seconds until the message "PANEL LOCK:OFF" appears on-screen.

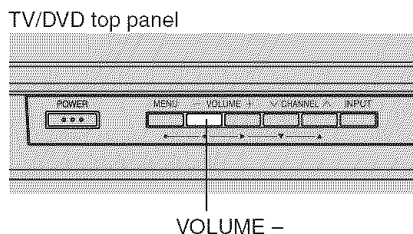

Labeling channels

Channel labels appear above the channel number display each time you turn on the TV/DVD, select a channel, or press the DISPLAY button. You can choose any four characters to identify a channel.

To create channel labels:

1. Select a channel you want to label.
2. Press MENU, then press ◀ or ▶ until the OPTION menu appears.
3. Press ▲ or ▼ to highlight CH LABEL.
4. Press ◀ or ▶ to display the CH LABEL menu. SET/CLEAR will be highlighted.
5. Press ◀ or ▶ to highlight SET.
6. Press ENTER to highlight LABEL.
7. Press ◀ or ▶ to enter a character in the first space. Press the button repeatedly until the character you want appears on the screen. Press ENTER.
8. Repeat step 7 to enter the rest of the characters.
If you would like a blank space in the label name, you must choose an empty space from the list of characters; otherwise, a dash will appear in that space.
9. Repeat steps 1-8 for other channels. You can assign a label to each channel.
10. Press EXIT to return to normal viewing.

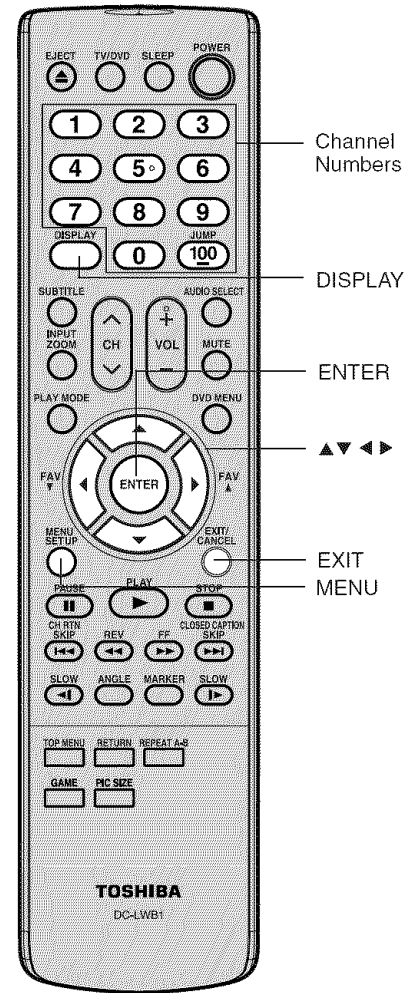
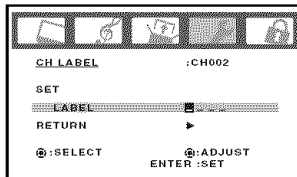
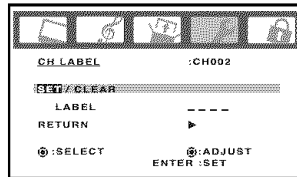
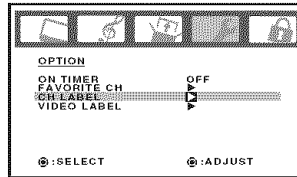

Note:

The character will change as below.

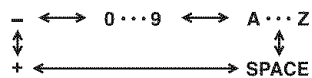

To erase channel labels:

1. Select a channel with a label.
2. Press MENU, then press ◀ or ▶ until the OPTION menu appears.
3. Press ▲ or ▼ to highlight CH LABEL.
4. Press ◀ or ▶ to display the CH LABEL menu. SET/CLEAR will be highlighted.
5. Press ◀ or ▶ to highlight CLEAR.
6. Press ENTER.
7. Repeat steps 1-6 to erase other channel labels.

Selecting the video input source

Press INPUT to view a signal from another device connected to your TV/DVD, such as a VCR or DVD player. You can select ANT, VIDEO1, VIDEO2, ColorStream HD, HDMI or PC, depending on which input jacks you used to connect your devices (see "Connecting your TV/DVD" on pages 11-17).

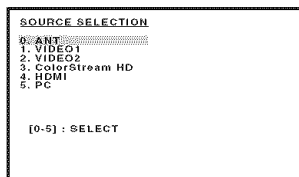

Pressing INPUT on the remote control displays the current signal source. (Press INPUT again, ▲/▼, or 0-5 to change the source.)

You also can use the CH ▲ / ▼ buttons to select the video input source. In addition to cycling through your programmed channels (page 24), the CH ▲ / ▼ buttons will also cycle through the video input sources, in the order illustrated below.

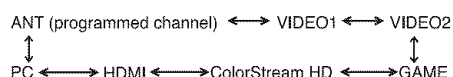

Labeling the video input sources

The video label feature allows you to label each input source for your TV/DVD from the following preset list of labels:

- : Uses the default label name
- VCR : Video cassette recorder
- DVD : DVD video
- DTV : Digital TV set-top box
- SAT : Satellite box
- CBL : Cable box
- HD : HDMI equipment

To label the video input sources:

1. Press MENU, then press ◀ or ▶ to display the OPTION menu.
2. Press ▲ or ▼ to highlight VIDEO LABEL.
3. Press ◀ or ▶ to display the VIDEO LABEL menu.
4. Press ▲ or ▼ to highlight the video source you want to label.
5. Press ◀ or ▶ to select the desired label for that input source.
6. Press EXIT to return to normal viewing.

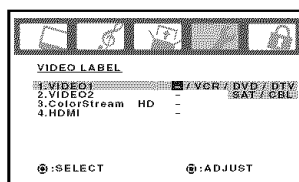
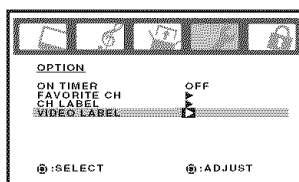

Setting the clock

You must set the clock before you can program the ON timer.

To set the clock: (Example: 8:30 AM)

1. Press MENU, then press ◀ or ▶ to display the SETUP menu.
2. Press ▲ or ▼ to highlight CLOCK SET.
3. Press ◀ or ▶ to highlight the hour position.
4. Press ▲ or ▼ to set the hour, then press ▶ to highlight the minute position.
5. Press ▲ or ▼ to set the minutes, then press EXIT to return to normal viewing.

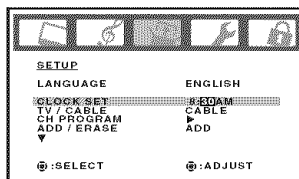
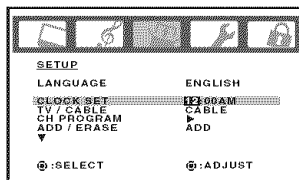

Please note the following regarding the HDMI source selection:

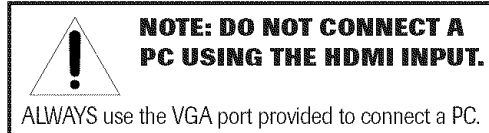

See "Connecting an HDMI™ or DVI device" on page 17 and "Connecting a PC (personal computer)" on page 20 for details.

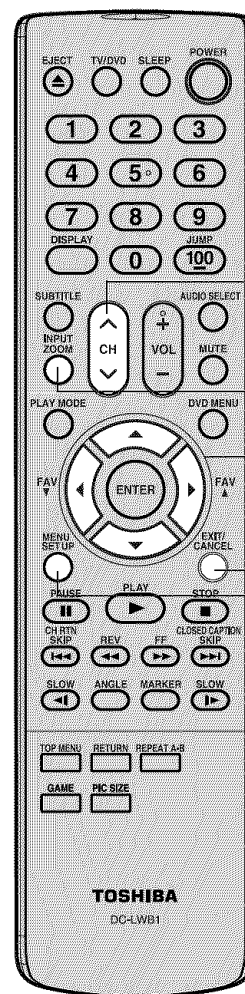

Introduction

Connecting your TV/DVD

Setting up your TV/DVD

Using the TV/DVD's Features

DVD Playback

Appendix

Setting the ON timer

This feature allows you to program the TV/DVD to turn on automatically at a set time. If you program the ON TIMER to "DAILY," the TV/DVD will turn on every day at the same time to the same channel until you clear the ON TIMER.

To set the on timer: (Example: Turning on the TV/DVD to channel 012 at 6:30 AM, DAILY)

1. Set the clock, if you have not already done so (see page 31).
2. Press MENU, then press ◀ or ▶ to display the OPTION menu.
3. Press ▲ or ▼ to highlight ON TIMER.
4. Press ◀ or ▶ to highlight SET, then press ENTER. The ON TIMER menu appears. Press ◀ or ▶ to set the time.
5. Press ▲ or ▼ to set the desired hour, then press ▶.

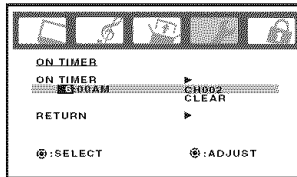

6. Set the desired minutes and channel, as in step 5.

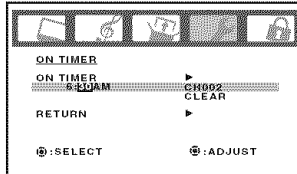

7. Press ◀ or ▶ to select ONCE or DAILY.
8. Press EXIT to return to normal viewing.

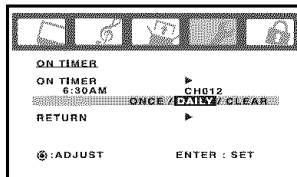

To cancel the on timer:

- Select CLEAR in step 7 above.
- Press EXIT to return to normal viewing.

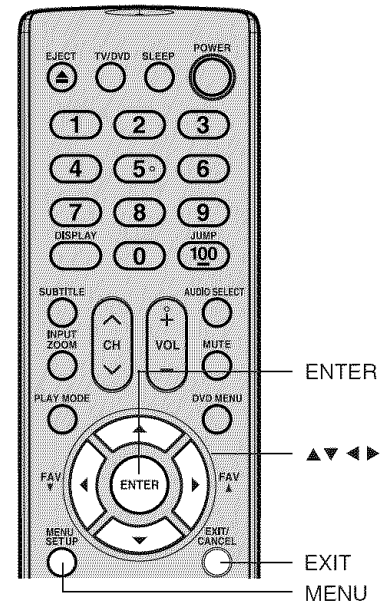

Note:

After a power failure or disconnection of the power, the timer settings will be lost.

Viewing the wide-screen picture formats (480i and 480p signals only)

You can view 480i and 480p format programs in a variety of picture sizes—Natural, TheaterWide1, TheaterWide2, TheaterWide3 and Full. The way the image displays in any of the picture sizes will vary depending on the format of the program you are viewing. Select the picture size that displays the current program the way that looks best to you.

Selecting the picture size

1. Press PIC SIZE on the remote control.
2. Press the corresponding number button (0-4) to select the desired picture size, as described below and on page 34.

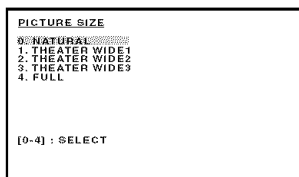

Natural picture size

- The image is displayed close to its originally formatted proportion. Some program formats will display with side bars and/or bars at the top and bottom.

Natural picture size example: The way the image displays will vary depending on the format of the program you are currently watching.

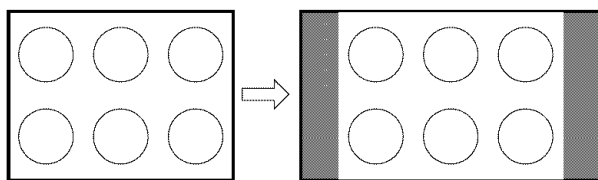

Conventional (4:3) picture on a conventional TV screen

Conventional (4:3) picture in Natural size on your wide-screen TV

TheaterWide 1 picture size (for 4:3 format programs)

- The center of the picture remains close to its original proportion, but the left and right edges are stretched wider to fill the screen.
- The top and bottom edges of the picture may be hidden; however, this mode cannot be scrolled.

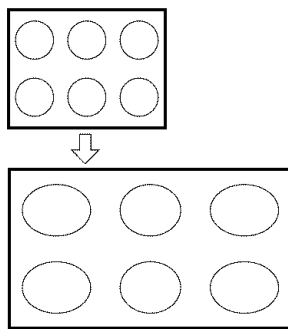

TheaterWide 1 picture size example

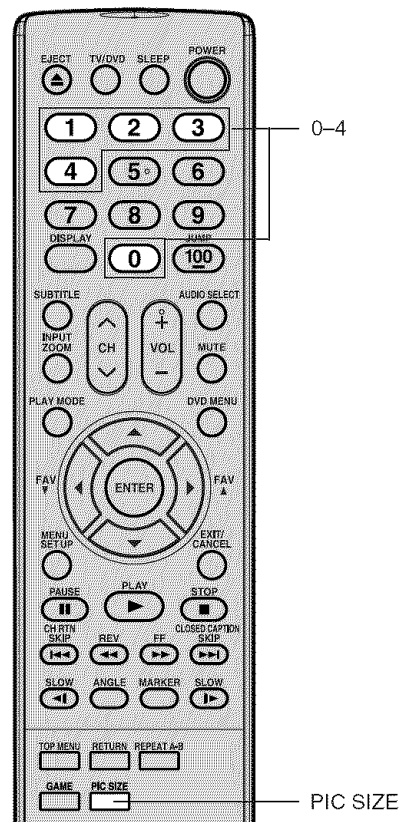

Note:

You also can change the picture size by selecting PICTURE SIZE in the SETUP menu.

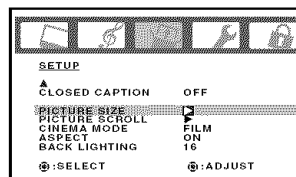

Using these functions to change the picture size (i.e., changing the height/width ratio) for any purpose other than your private viewing may be prohibited under the Copyright Laws of the United States and other countries, and may subject you to civil and criminal liability.

Introduction

Connecting your TV/DVD

Setting up your TV/DVD

Using the TV/DVD's Features

DVD Playback

Appendix

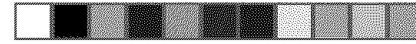
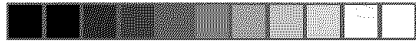

TheaterWide 2 picture size (for letter box programs)

- The picture is stretched the same amount both wider and taller (retains its original proportion.)
- The top and bottom edges of the picture may be hidden. To view the hidden areas, see “Scrolling the TheaterWide picture” on page 35.

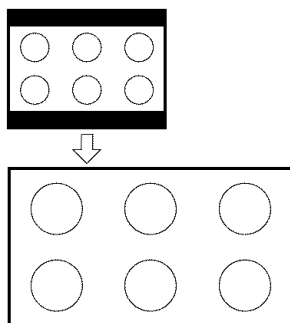

TheaterWide 2 picture size example

Note:

If you select TheaterWide 2 or 3, the top and bottom edges of the picture may be hidden. To see the hidden edges, either scroll the picture (see page 35) or try viewing the program in Full picture size.

TheaterWide 3 picture size (for letter box programs with subtitles)

- The picture is stretched wider to fill the width of the screen, but only slightly stretched taller.
- The top and bottom edges of the picture may be hidden. To view the hidden areas (such as subtitles or captions), see “Scrolling the TheaterWide picture” on page 35.

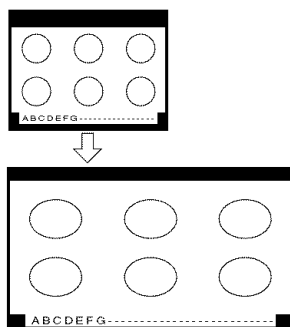

TheaterWide 3 picture size example

Full picture size (for 16:9 source programs)

- If receiving a 16:9 format program, the picture is displayed in its original proportion.
- If receiving a 4:3 format program, the picture is stretched wider to fill the width of the screen, but not stretched taller.
- None of the picture is hidden.

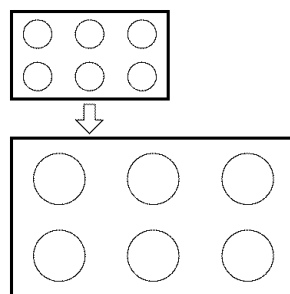

Full picture size example

Using the
TV/DVD's Features

Using these functions to change the picture size (i.e., changing the height/width ratio) for any purpose other than your private viewing may be prohibited under the Copyright Laws of the United States and other countries, and may subject you to civil and criminal liability.

Scrolling the TheaterWide® picture

(TheaterWide 2 and 3 only)

1. Press PIC SIZE to select the TheaterWide 2 or 3 mode.
2. Press MENU, and then press ◀ or ▶ until the SETUP menu appears.
3. Press ▲ or ▼ to highlight PICTURE SCROLL.

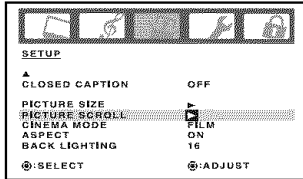

4. Press ◀ or ▶ to display the Scroll Adjustment mode.

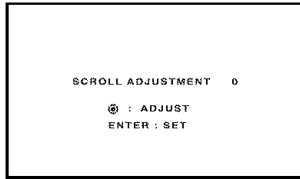

5. Press ▲ or ▼ to adjust the vertical position of the picture.
 - Normal (center) position

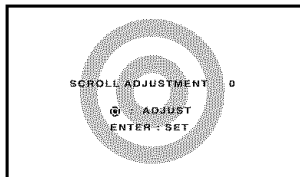

- To raise the picture, press ▲.

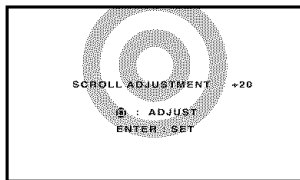

- To lower the picture, press ▼.

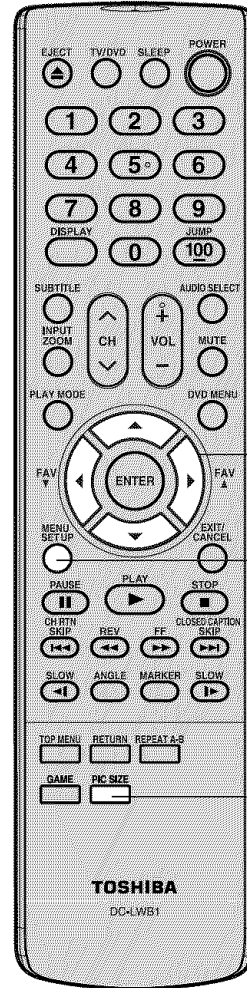
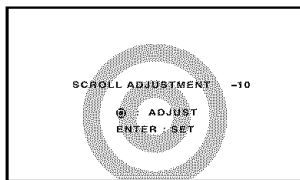

Note:

You can scroll the picture in TheaterWide 2 and TheaterWide 3 only. The scroll amounts are as follows:

- 480i/480p signal source:
 - Wide 1 : Not adjustable
 - Wide 2 : -10 to +20
 - Wide 3 : -10 to +20

Introduction

Connecting
Your TV/DVD

Setting up
Your TV/DVD

Using the
TV/DVD's Features

DVD Playback

Appendix

Selecting the cinema mode

When you view a DVD movie (3:2 pulldown processed) from a DVD player connected to the ColorStream (component video) inputs on the TV/DVD, smoother and more natural motion can be obtained by setting the CINEMA MODE to FILM.

To set the CINEMA MODE to FILM:

1. Press MENU, then press ◀ or ▶ until the SETUP menu appears.
2. Press ▲ or ▼ to highlight CINEMA MODE, then press ◀ or ▶ to select FILM.

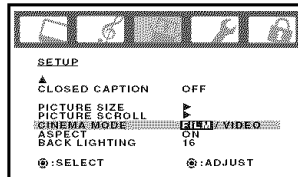

To set the CINEMA MODE to VIDEO:

Press ◀ or ▶ to select VIDEO in step 2 above.

Using the ASPECT feature

When the ASPECT feature is set to ON and the TV/DVD receives a 480i signal, the picture size is automatically selected (as described in the following table).

Aspect ratio of signal source	Automatic aspect size (automatically selected when ASPECT is ON)
4:3 Normal	Natural
16:9 Full	Full
4:3 Letter box	TheaterWide
Not defined	User-set mode

If the signal does not include aspect information, the picture size you selected on pages 33 is displayed.

To turn on the ASPECT feature:

1. Press MENU, then press ◀ or ▶ until the SETUP menu appears.
2. Press ▲ or ▼ to highlight ASPECT, then press ◀ or ▶ to select ON.

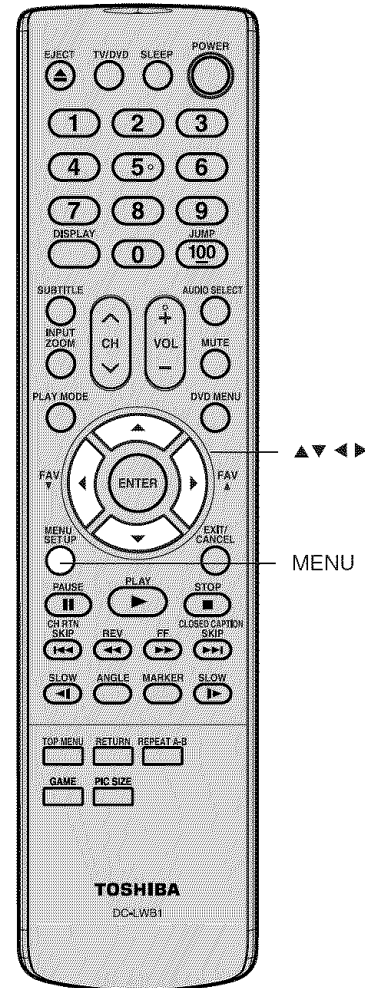
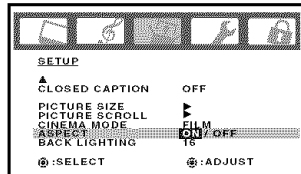

Using the TV/DVD's Features

Setting the sleep timer

You can set the TV/DVD so it turns off automatically.

To set the sleep timer:

Press SLEEP on the remote control repeatedly to set the length of time until the TV/DVD turns off. The clock will count up 10 minutes for each press of the SLEEP button (0h00m, 0h10m, ...1h50m, 2h00m). After the sleep timer is programmed, the display will appear briefly every ten minutes to remind you that the sleep timer is operating.

To confirm the sleep timer setting:

Press SLEEP one time. The remaining time will be momentarily displayed.

To cancel the sleep timer:

Press SLEEP repeatedly until the display turns to 0h00m.

Using the closed caption feature

The Closed Caption feature has two options:

- **Captions**—An on-screen display of the dialogue, narration, and sound effects of programs and videos that are closed-captioned (usually identified as “CC”).
- **Text**—An on-screen display of information not related to the program, such as weather or stock data (if available in your viewing area).

To view captions or text:

1. Tune the TV/DVD to the desired program.
2. Press MENU, then press ◀ or ▶ to display the SETUP menu.
3. Press ▲ or ▼ to highlight CLOSED CAPTION.

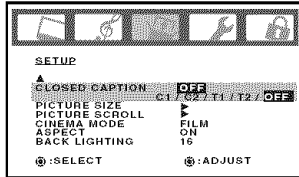

4. Press ◀ or ▶ to select the desired Closed Caption mode, as follows:
 - To view captions, select C1 or C2 (C1 displays translation of the primary language in your area).
Note: If the program or video you selected is not closed-captioned, no captions will display on-screen.
 - To view text, select T1 or T2.
Note: If text is not available in your viewing area, a black rectangle may appear on-screen. If this happens, set the Closed Caption feature to OFF.
 - To turn the Closed Caption feature off, highlight OFF in the Closed Caption menu.

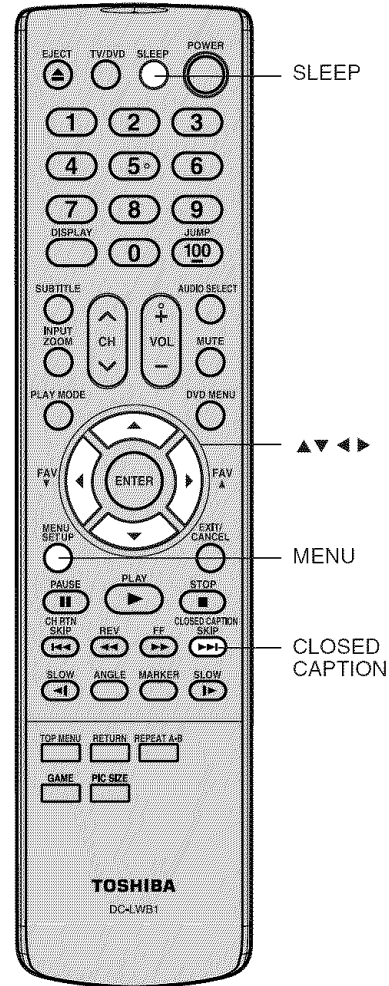

Note:

- A closed caption signal may not be decoded in the following situations:
 - when a video tape has been dubbed
 - when the signal reception is weak
 - when the signal reception is non-standard
- You also can use the CLOSED CAPTION button to view caption or text.

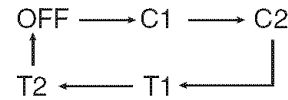

Introduction

Connecting
Your TV/DVD

Setting up
Your TV/DVD

Using the
TV/DVD's Features

DVD Playback

Appendix

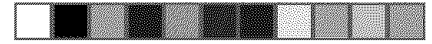
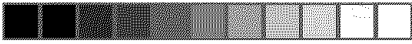

Adjusting the picture

Selecting the picture mode

You can select four picture modes—Sports, Standard, Movie, and Memory—as described in the following table:

Mode	Picture Quality
SPORTS	Bright and dynamic picture (factory-set)
STANDARD	Standard picture quality (factory-set)
MOVIE	Movie-like picture setting (factory-set)
MEMORY	Your personal preferences (set by you; see “Adjusting the picture quality” below)

To select the picture mode:

1. Press MENU, then press ◀ or ▶ to display the PICTURE menu.
2. Press ▲ or ▼ to highlight MODE.

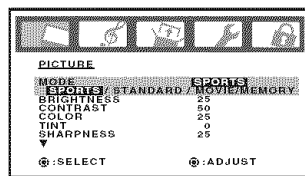

3. Press ◀ or ▶ to highlight the mode you prefer.
4. Press EXIT to return to normal viewing.

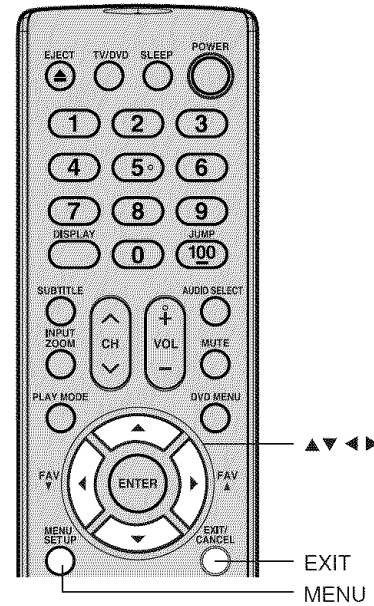

Note:

You cannot select “MODE” in the Game mode.

Adjusting the picture quality

You can adjust the picture quality to your personal preferences, including the brightness, contrast, color, tint, and sharpness. The qualities you choose will be stored automatically in your TV/DVD's memory so you can recall them at any time.

To adjust the picture quality:

1. Press MENU, then press ◀ or ▶ to display the PICTURE menu.
2. Press ▲ or ▼ until the item you want to adjust is highlighted.

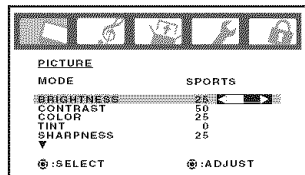

3. Press ◀ or ▶ to adjust the level.

Selection	◀ Pressing	▶
BRIGHTNESS	darker	lighter
CONTRAST	lower	higher
COLOR	paler	deeper
TINT	reddish	greenish
SHARPNESS	softer	sharper

4. Press EXIT to return to normal viewing.

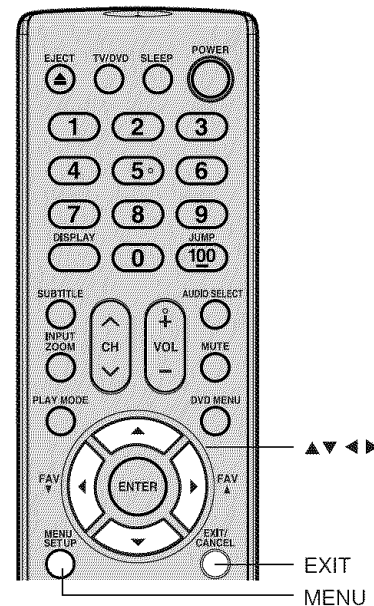

Note:

The CONTRAST default setting is set to maximum (+50) at the factory.

Using the TV/DVD's Features

Using the CableClear® feature

CableClear® reduces visible interference in your TV/DVD picture. This is useful when receiving a broadcast with a weak signal (especially a Cable channel) or playing a video cassette or disc damaged by repeated use.

To turn on the CableClear® feature:

1. Press MENU, then press ◀ or ▶ to display the PICTURE menu.
2. Press ▲ or ▼ to highlight CableClear.

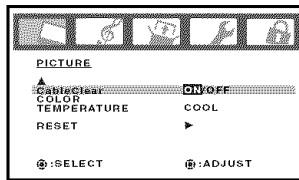

3. Press ◀ or ▶ to select ON.

To turn off the CableClear® feature:

Select OFF in step 3.

Selecting the color temperature

Change the picture quality by selecting from three preset color temperatures—cool, medium, and warm—as described in the following table:

Mode	Picture Quality
COOL	Blueish
MEDIUM	Neutral
WARM	Reddish

To select the color temperature:

1. Press MENU, then press ◀ or ▶ to display the PICTURE menu.
2. Press ▲ or ▼ to highlight COLOR TEMPERATURE.

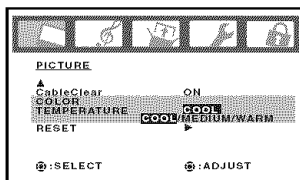

3. Press ◀ or ▶ to highlight the mode you prefer.
4. Press EXIT to return to normal viewing.

Resetting your picture adjustments

The RESET function returns your picture quality adjustments to the following factory settings:

Mode	sports	Tint	center (0)
Brightness	center (25)	Sharpness	center (25)
Contrast	max (50)	Color temperature..	cool
Color	center (25)		

To reset your picture adjustments:

1. Press MENU, then press ◀ or ▶ to display the PICTURE menu.
2. Press ▲ or ▼ to highlight RESET, and then press ◀ or ▶.

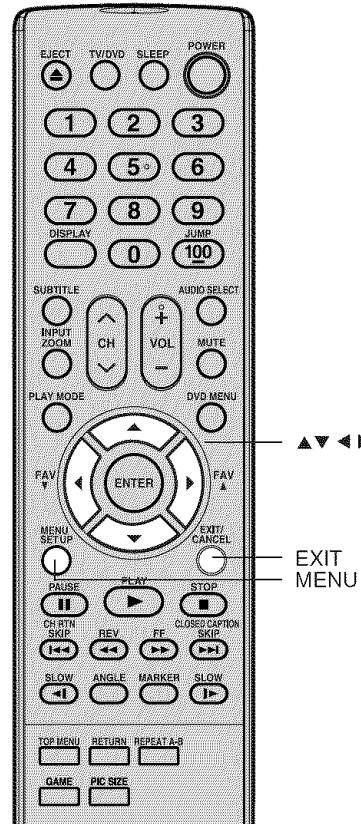
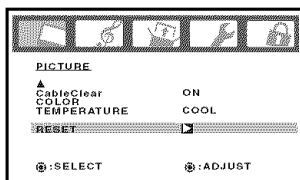

Note:

You cannot select "COLOR TEMPERATURE" in the Game mode.

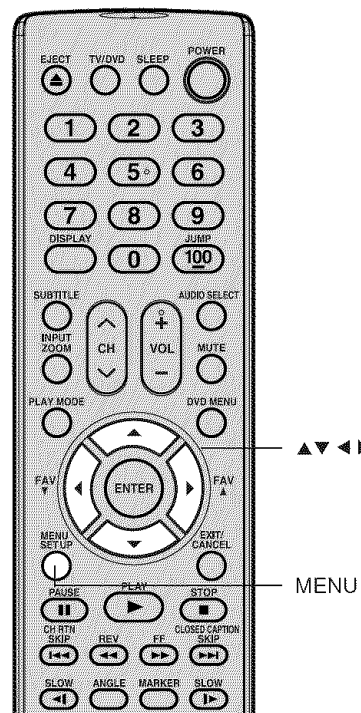

Introduction

Connecting
Your TV/DVD

Setting up
Your TV/DVD

Using the
TV/DVD's Features

DVD Playback

Appendix

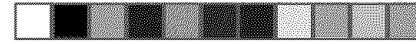
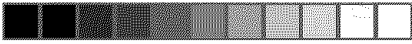

Adjusting the sound

Muting the sound

Press MUTE to temporarily turn off the sound. While the sound is off, the TV screen will display "MUTE" in the lower right-hand corner. To restore the sound, press MUTE again.

Selecting stereo/SAP broadcasts

The multi-channel TV sound (MTS) feature provides high-fidelity stereo sound. MTS also can transmit a second audio program (SAP) containing a second language or other audio information.

Note: The MTS feature is only available in ANT input source. When the TV/DVD receives a stereo or SAP broadcast, the "STEREO" or "SAP" displays on-screen every time you turn the TV/DVD on, change the channel, or press DISPLAY.

To listen to stereo sound:

1. Press MENU, then press ◀ or ▶ to display the AUDIO menu.
2. Press ▲ or ▼ to highlight MTS.
3. Press ◀ or ▶ to highlight STR (stereo).

Note:

- In general, you can leave your TV/DVD in stereo mode because the TV/DVD automatically outputs the type of sound being broadcast (stereo or mono).
- If the stereo sound is noisy, select MONO to reduce the noise.

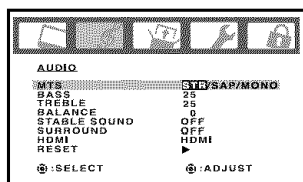

4. Press EXIT to return to normal viewing.

To listen to a second audio program (SAP):

1. Press MENU, then press ◀ or ▶ to display the AUDIO menu.
2. Press ▲ or ▼ to highlight MTS.
3. Press ◀ or ▶ to highlight SAP. The TV/DVD speakers will output the second audio program instead of normal audio.
4. Press EXIT to return to normal viewing.

Adjusting the sound quality

You can change the sound quality of your TV/DVD by adjusting the bass, treble, and balance.

To adjust the sound quality:

1. Press MENU, then press ◀ or ▶ until the AUDIO menu.
2. Press ▲ or ▼ to highlight the item you want to adjust.

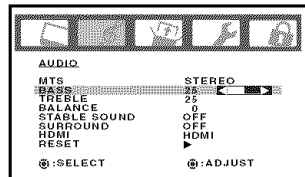

3. Press ◀ or ▶ to adjust the level.
 - ◀ makes the sound quality weaker or decreases the balance in the right channel, depending on the item selected.
 - ▶ makes the sound quality stronger or decreases the balance in the left channel, depending on the item selected.

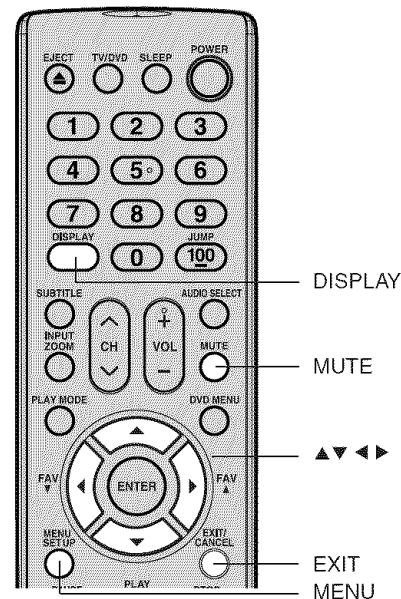

Note:

A second audio program (SAP) can be heard only on those TV stations that offer it.

For example, a station might broadcast music as a second audio program. If you have SAP on, you will see the current program on the screen but hear music instead of the program's normal audio.

However, if you have SAP on, and the station you are watching is not currently broadcasting a second audio program, the station's normal audio will be output; however, occasionally there is no sound at all in SAP mode. If this happens, set the MTS feature to STEREO mode.

Note:

Adjusting the sound quality (bass, treble and balance) does not affect the sound that is output from the headphone jack.

Resetting your audio adjustments

The RESET function returns the audio adjustments to the following factory settings:

Bass center (25)
Treble center (25)
Balance center (0)

To reset your audio adjustments:

1. Press MENU, then press ◀ or ▶ to display the AUDIO menu.
2. Press ▲ or ▼ to highlight RESET, and then press ◀ or ▶.

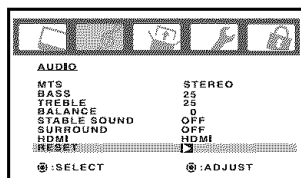

Using the StableSound® feature

The StableSound feature limits the highest volume level to prevent extreme changes in volume when the signal source is changed.

To turn on the StableSound® feature:

1. Press MENU, then press ◀ or ▶ to display the AUDIO menu.
2. Press ▲ or ▼ to highlight STABLE SOUND.
3. Press ◀ or ▶ to highlight ON.

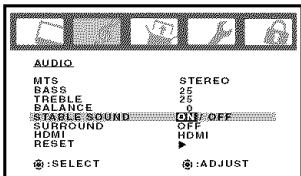

To turn off the StableSound® feature:

Highlight OFF in step 3 above.

Using the surround sound feature

The surround sound feature expands the audio listening field wider and deeper to create exceptional sound quality from the TV's speakers. The feature uses stereo signals from a TV broadcast or video input.

To turn on the surround sound feature:

1. Select the STEREO mode, if available (see "Selecting stereo/SAP broadcasts" on page 40).
2. Press MENU, then press ◀ or ▶ to display the AUDIO menu.
3. Press ▲ or ▼ to highlight SURROUND.
4. Press ◀ or ▶ to highlight ON.

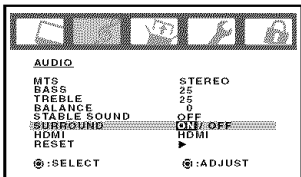

To turn off the surround sound feature:

Highlight OFF in step 4 above.

In general, you can leave your TV in surround mode because it will automatically output the type of sound being broadcast (surround stereo or monaural).

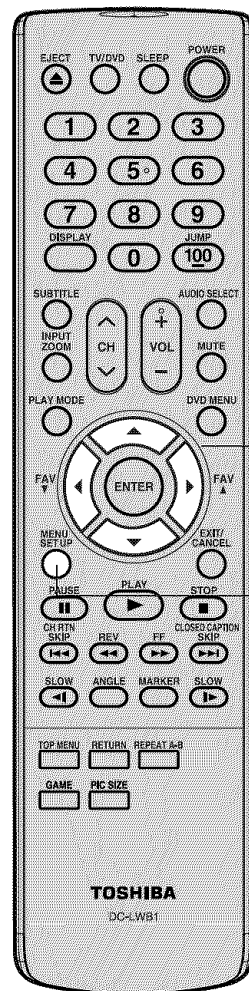

Introduction

Connecting
your TV/DVD

Setting up
your TV/DVD

Using the
TV/DVD's Features

DVD Playback

Appendix

Selecting the HDMI audio input source

See "Connecting an HDMI™ or a DVI device" on page 17 for connection information.

If you connect a DVI device, you must also connect the analog audio cables to the HDMI audio IN jacks (see page 17) to hear audio. Set the HDMI audio input setting to "DVI" with this connection.

If you connect an HDMI device and play media with digital audio output, set the HDMI audio input setting to "HDMI" with this connection to hear digital audio.

If you connect an HDMI device but play media with analog audio output (for example, certain CDVs do not output digital audio), you must also connect the analog audio cables to the HDMI audio IN jacks (see page 17) to hear audio. Set the HDMI audio input setting to "DVI" with this connection.

To select the HDMI audio input source:

1. Press MENU, then press ◀ or ▶ to display the AUDIO menu.
2. Press ▼ or ▲ to highlight HDMI.
3. Press ◀ or ▶ to select HDMI or DVI.

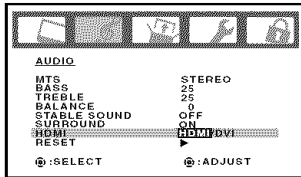

Adjusting the back lighting feature

If your TV/DVD is in a bright room, the screen image may be difficult to see. You can use the BACK LIGHTING feature to adjust the screen brightness for improved picture clarity.

To adjust the back lighting:

1. Press MENU, then press ◀ or ▶ until the SETUP menu appears.
2. Press ▲ or ▼ to highlight BACK LIGHTING.

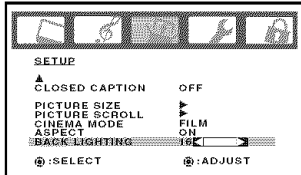

3. Press ◀ or ▶ to adjust the screen brightness.

Displaying on-screen information

Press DISPLAY to display the following on-screen information:

- Clock
- Channel number or Video input mode selected
- Channel label (if preset)
- Stereo or SAP (second audio program) audio status
- Content rating
- On timer, Sleep timer (if preset)
- Picture size

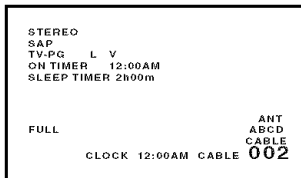

Auto power off

The TV/DVD will automatically turn off after approximately 15 minutes if it is tuned to a vacant channel or a station that completes its broadcast for the day and stops broadcasting on that channel. This feature does not work in Video input/PC/DVD mode.

Understanding the Power Return feature

If the power is cut off while you are viewing the TV/DVD and the power is resupplied, the Power Return feature will turn the TV/DVD on automatically.

If the power is going to be off for a long time or you are going to be away from home for a long time, unplug the power cord from the wall outlet to prevent the TV/DVD from turning on in your absence.

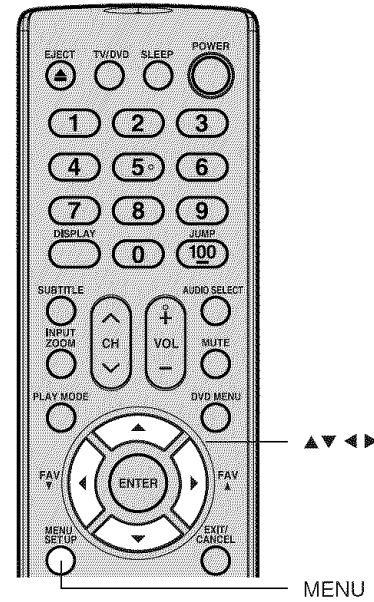

Note:

The cold cathode fluorescent lamp used for the back light on this TV/DVD has a limited life. When areas on the screen darken, flicker, or no longer light up, the lamp may be at the end of its life. Contact your nearest Toshiba Authorized Service Station.

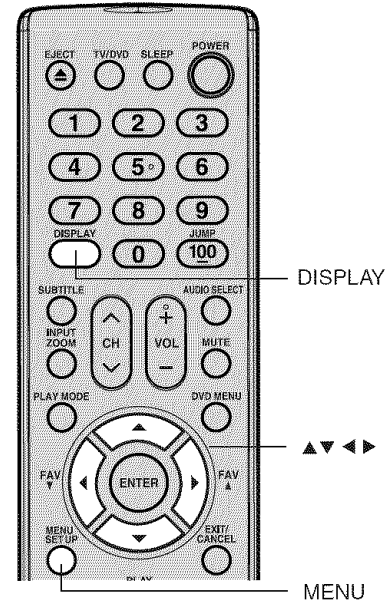

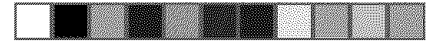
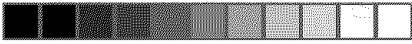

Picture/Audio adjustments in PC mode

There are a number of picture settings you can adjust to optimize the performance of the TV/DVD in PC mode.

PICTURE Menu

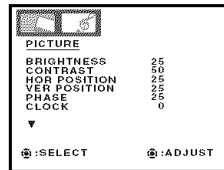

AUDIO Menu

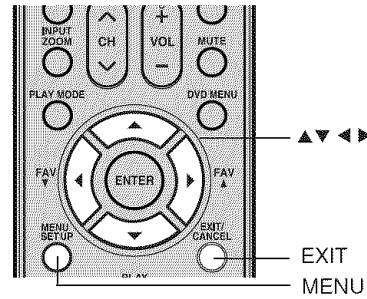
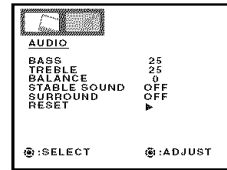

Note:

- If you wish to change the on-screen language, follow the steps 1-3 on page 23.
- If no buttons are pressed for more than approx. 60 seconds, the PC Monitor Menu screen will return to normal Monitor screen automatically.
- The PC Monitor Menu settings are not effective for normal TV mode, DVD mode or external input mode.

Example: Adjust the contrast.

1. In PC mode, press MENU, then press ◀ or ▶ to display the PICTURE menu.
2. Press ▲ or ▼ to select CONTRAST.
3. Press ◀ or ▶ to adjust the contrast level.
4. Press EXIT to return to normal viewing.

PICTURE menu settings:

- BRIGHTNESS:** To adjust the brightness of PC Monitor screen.
- CONTRAST:** To adjust the contrast of PC Monitor screen.
- HOR POSITION:** To adjust the horizontal position of the image on the PC Monitor screen. Each video standard will require a different value for this setting.
- VER POSITION:** To adjust the vertical position of the image on the PC Monitor screen. Each video standard will require a different value for this setting.
- PHASE:** This must be adjusted after the frequency has been set to optimize picture quality.
- CLOCK:** To minimize any vertical bars or stripes visible on the screen background.
- RED/GREEN/BLUE:** To adjust the color temperature of the PC Monitor screen.
- WVGA INPUT:** Set to ON, when you select the WVGA mode on the PC.
- WXGA INPUT:** Set to ON, when you select the WXGA mode on the PC.

AUDIO menu settings:

- BASS/TREBLE/BALANCE:** To adjust the sound quality of PC mode.
- STABLE SOUND:** To turn on or off the StableSound® feature in PC mode.
- SURROUND:** To turn on or off the surround effect in PC mode.

Resetting your picture/audio adjustments in PC mode

The RESET function returns your picture quality adjustments to the following factory settings:

PICTURE menu		AUDIO menu	
Brightness	center (25)	Bass	center (25)
Contrast	max (50)	Treble	center (25)
Red	center (25)	Balance	center (0)
Green	center (25)		
Blue	center (25)		

To reset your picture adjustments:

1. Press MENU in PC mode.
2. Press ◀ or ▶ to select the desired menu.
3. Press ▲ or ▼ to highlight RESET, and then press ◀ or ▶.

Introduction

Connecting your TV/DVD

Setting up your TV/DVD

Using the TV/DVD's Features

DVD Playback

Appendix

DVD Playback

Playing a disc

This section shows you the basics on how to play a disc.

Basic playback (DVD) (VCD) (CD)

Preparations: When connecting to other equipment, turn the power off.

1. Press POWER on the unit or on the remote control to turn on the unit.
The Power indicator will light.
 - Every time you press POWER, the TV/DVD starts from TV mode.
 - When using an amplifier, switch on the amplifier.
2. Press TV/DVD on the remote control to select DVD mode.
The DVD startup screen will appear on the screen. (If DVD disc has already loaded, playback will start automatically.)

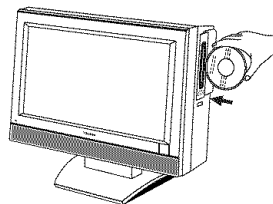
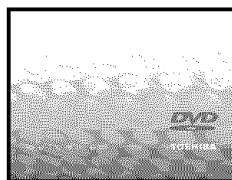

3. Load a disc in the disc slot with the label side facing forward. (If the disc has a label.) Hold the disc without touching either of its surfaces, align it with the guides, and place it in position.
4. On the TV screen, "▲" changes to "Reading" and then playback commences.

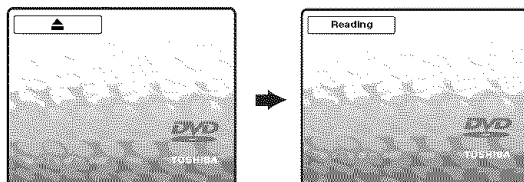

- A menu screen will appear on the TV screen if the disc has a menu feature.
Press ▲ / ▼ or ◀ / ▶ to select title, then press ENTER. Title is selected and play commences.
5. Press VOL + or – to adjust the volume.

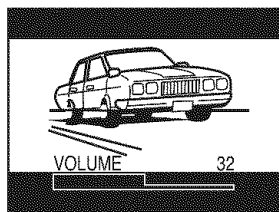

6. Press STOP to end playback.

Resume feature

- Depending on the disc you are playing, when you press STOP one time, the TV/DVD remembers the scene that was playing ("■" appears on screen). Press PLAY to resume playback from the stopped scene.
- If you press STOP again, the unit will clear the stopped scene ("■" appears on screen).

CAUTION

Keep your fingers well clear of the disc slot when disc is loading or unloading. Neglecting to do so may cause serious personal injury.

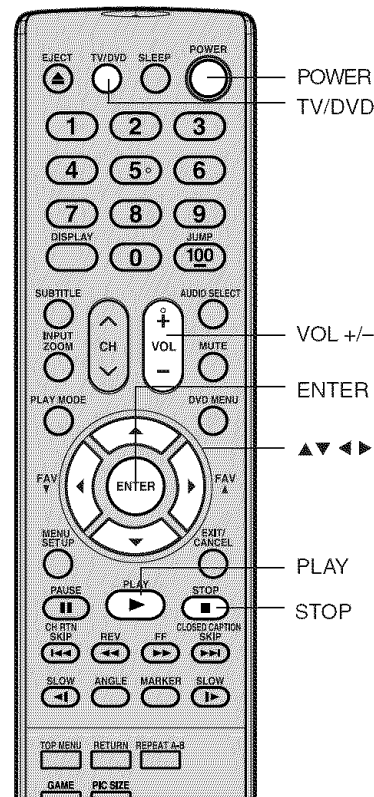

Note:

Static electricity may affect the DVD player's operation and cause it to not work properly. If this happens, turn OFF the POWER, disconnect and then reconnect the AC power cord, and turn ON the unit again.

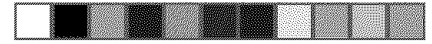
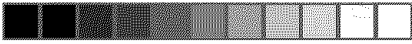

About DVD VCD CD

The DVD VCD CD icons on the heading bar show the playable discs for the function described under that heading.

DVD : You can use this function with DVD video discs.

VCD : You can use this function with Video CDs.

CD : You can use this function with Audio CDs and CD-R/RW discs.

To start playback in the stop mode

Press PLAY.

To pause playback (still mode)

Press PAUSE during playback.

To resume normal playback, press PLAY.

- The sound is muted during still mode.

To stop playback

Press STOP.

To remove the disc

Press EJECT.

Remove the disc after the disc comes out.

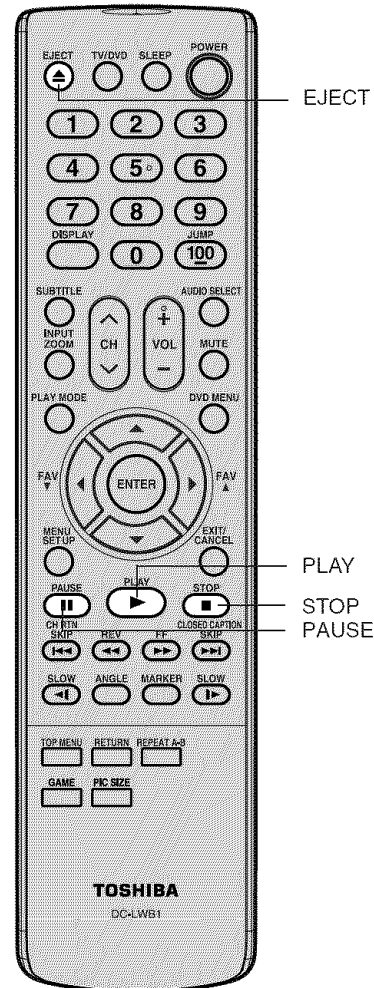
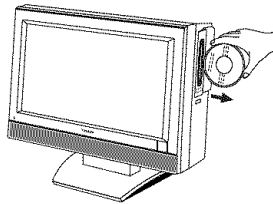

Note:

- If a non-compatible disc is loaded, "Incorrect Disc", "Region Code Error" or "Parental Error" will appear on the TV screen according to the type of loaded disc. In this case, check your disc again (see pages 8 and 61).
- Some discs may take a minute or so to start playback.
- When you set a single-faced disc label downwards (ie. the wrong way up), "Reading" will appear on the display for a few minutes and then "Incorrect Disc" will continue to be displayed.
- Some discs may not resume playing the same scene after stopping.
- Resuming cannot function when you play a PBC-featured Video CD while the PBC is on. To turn off the PBC, see page 53.
- Some playback operations of DVDs may be intentionally fixed by software producers. Since this unit plays DVDs according to the disc contents the software producers designed, some playback features may not be available. Also refer to the instructions supplied with the DVDs.
- Do not move the unit during playback. Doing so may damage the disc.
- Use EJECT on the unit to unload and eject the disc.
- Do not put any objects other than discs in the disc slot. Doing so may cause the unit to malfunction.
- There may be a slight delay between the button is pressed and the function activates.
- When an 8 cm disc is loaded in the disc slot, and the playback picture or menu screen does not appear, press PLAY.

Introduction

Connecting your TV/DVD

Setting up your TV/DVD

Using the TV/DVD's Features

DVD Playback

Appendix

Playing in fast reverse or fast forward directions

DVD VCD CD

Press REV or FF during playback.

REV: Fast reverse playback

FF: Fast forward playback

Each time you press REV or FF, the playback speed changes.

To resume normal playback

Press PLAY.

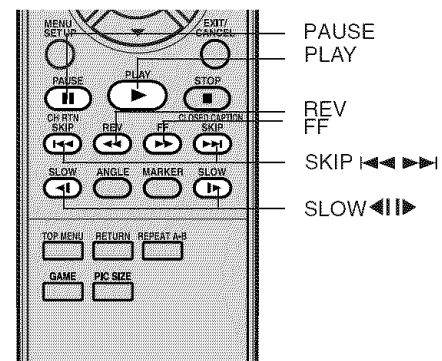

Note:

- The TV/DVD mutes sound during reverse and forward scan of DVD and Video CD discs. However, the TV/DVD plays sound during fast forward or fast reverse play of audio CDs.
- The playback speed may differ depending on the disc.

Playing frame by frame **DVD VCD**

Press PAUSE during still playback.

Each time you press PAUSE, the picture advances one frame.

To resume normal playback

Press PLAY.

Playing in slow-motion **DVD VCD**

Press SLOW ◀ (REVERSE) or ▶ (FORWARD) during playback.

Each time you press the button, the slow-motion speed changes.

To resume normal playback

Press PLAY.

Note:

The sound is muted during frame by frame playback.

Note:

- The sound is muted during slow-motion playback.
- The Video CD cannot play Reverse Slow.

Locating a chapter or track **DVD VCD CD**

Press SKIP ◀◀ or ▶▶ repeatedly to display the chapter or track number you want.

Playback starts from the selected chapter or track.

SKIP ▶▶: To locate succeeding chapters or tracks.

SKIP ◀◀: Playback starts from the beginning of the current chapter or track. When you press twice in quick successions, playback starts from the beginning of the preceding chapter or track.

Note:

A "Prohibition" symbol **X** may appear at the upper right of the screen. This symbol means either the feature you tried is not available on the disc, or the TV/DVD cannot access the feature at this time. This does not indicate a problem with the TV/DVD.

Zooming (DVD) (VCD) (CD)

This unit will allow you to zoom in on the frame image. You can then make selections by switching the position of the frame.

- Press ZOOM during playback.
The center part of the image will be zoomed in. Each press of ZOOM will change the ZOOM Q1 (x 1.3), Q2 (x 1.5) and Q3 (x 2.0).
- Press ▲/▼/◀/▶ to view a different part of the frame.
You may move the frame from the center position to UP, DOWN, LEFT or RIGHT direction.
- In the zoom mode, press ZOOM repeatedly to return to a 1:1 view (Q Off).

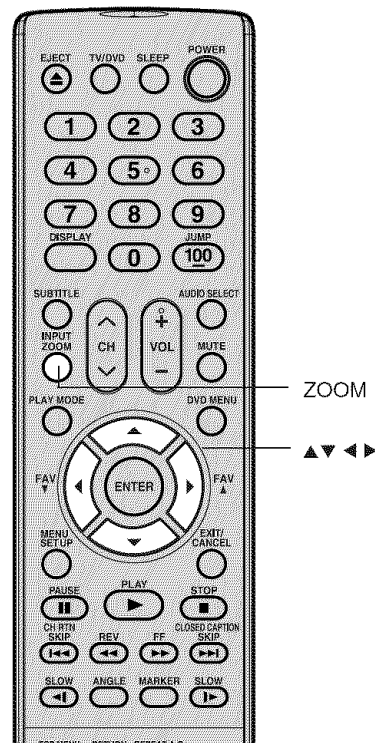
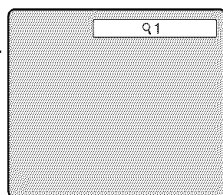

Note:

- You can select the Pause, Slow or Search playback in the zoom mode.
- Some discs may not respond to zoom feature.

Locating desired scene (DVD) (VCD) (CD)

Use the title, chapter and time recorded on the DVD disc to locate the desired point to playback. In the case of VCD/CD discs, track and time are used to locate the desired point to playback.

To check the title, chapter/track and time, press DISPLAY.

- Press JUMP during playback or resume stop mode.
- Press ▲ or ▼ to select the "Time", "Title/Track" or "Chapter".
- Press Number buttons (0-9) to input the number.
 - If you input a wrong number, press CANCEL.
 - Refer to the package supplied with the disc to check the numbers.
- Press ENTER. Playback starts.
 - When you change the title, playback starts from Chapter 1 of the selected title.
 - Some discs may not work in the above operation.

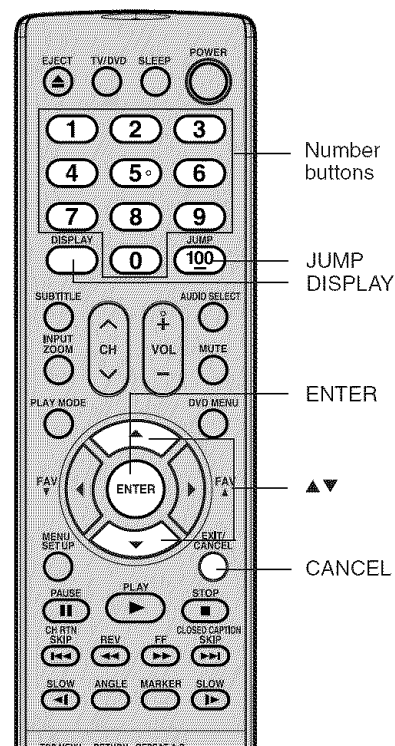
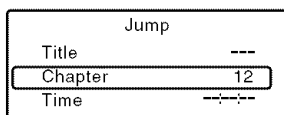
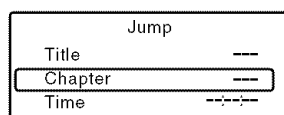
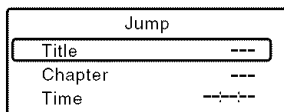

Note:

In case of the Video-CD playback with PBC, the JUMP does not work. To turn off PBC, see page 53.

Marking desired scenes **(DVD VCD)**

The unit stores the points that you want to watch again up to 3 points. You can resume playback from each scene.

Marking the scenes

1. Press MARKER during playback.



2. Select the blank Marker using ▲ or ▼. Then press ENTER at the desired scene.
 - Repeat this procedure to set the other 2 scenes.

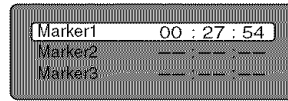

3. Press MARKER to clear this display.

Returning to the scenes

1. Press MARKER during playback or stop mode.

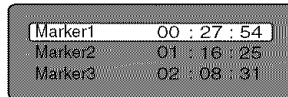

2. Press ▲ or ▼ to select the Marker 1-3.

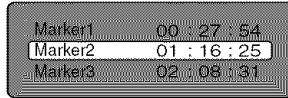

3. Press ENTER. Playback starts from the marked scene.

To cancel the Marker

Follow the above steps 1~2, then press CANCEL.

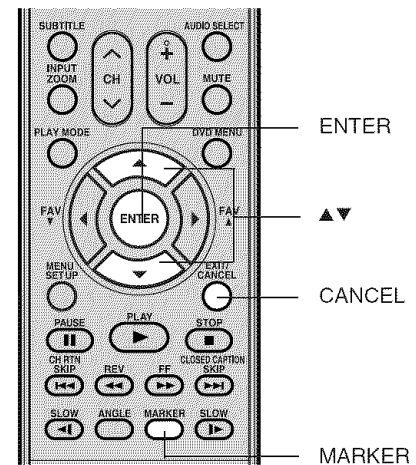

Note:

- Some discs may not work with the marking operation.
- The marking is canceled when you eject the disc or turn the power off.
- Some subtitles recorded around the marker may fail to appear.
- In case of Video CD with PBC, the MARKER is prohibited.

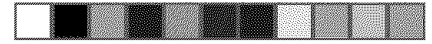
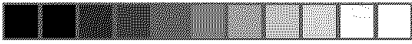

Repeat playback

1. Press PLAY MODE during playback or stop mode.
2. [DVD]

Press ENTER to select "Chapter" or "Title".

The unit automatically starts repeat playback after finishing the current title or chapter.



[Video CD]

Press ▼ to select "Repeat".

Press ENTER to select "Track" or "All".

The unit automatically starts repeat playback after finishing the current track.

- If you set the repeat mode during stop mode, press PLAY to start Repeat playback.

[Audio CD and MP3/WMA CD]

Please see "Repeat playback" (page 58).

3. Press PLAY MODE again to clear the screen.

To resume normal playback

Select Repeat : "Off" in step 2.

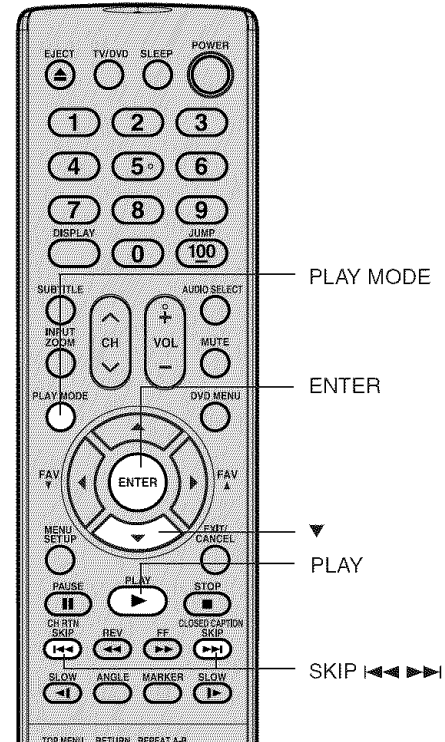

Note:

- Some discs may not work with the repeat operation.
- In case of Video CD with PBC, Repeat functions are prohibited during playback.
- Chapter/Track repeat function is canceled whenever SKIP ◀◀ or ▶▶ is pressed.

A-B Repeat playback

A-B repeat playback allows you to repeat a section between two selected points.

1. Press REPEAT A-B during playback.
The start point is selected.

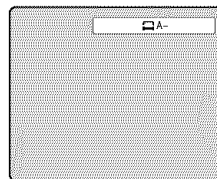

2. Press REPEAT A-B again.
The end point is selected. Playback starts at the point that you selected. Playback stops at the end point and returns to Point A automatically, then starts again.

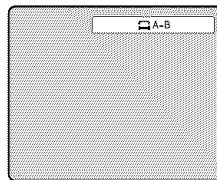

To resume normal playback

Press REPEAT A-B again.

"Off" appears on the screen.

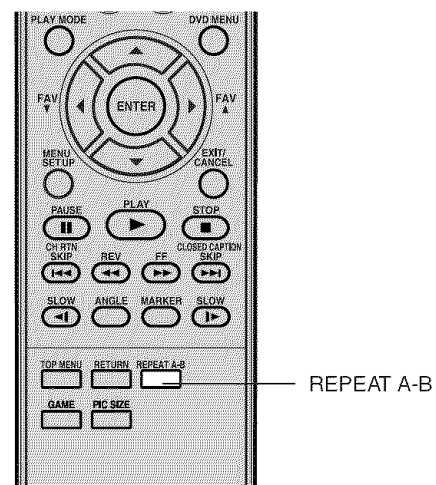

Note:

- In A-B Repeat mode, subtitles near the A or B locations may not be displayed.
- You cannot set the A-B Repeat for the scenes that include multiple angles.
- A-B Repeat playback does not work when Repeat playback is activated.
- You may not be able to set A-B Repeat during certain scenes of the DVD.
- A-B Repeat does not work with an interactive DVD, MP3/WMA/JPEG CD.
- A-B Repeat is prohibited when PBC is on.

Introduction

Connecting
your TV/DVD

Setting up
your TV/DVD

Using the
TV/DVD's Features

DVD Playback

Appendix

Program playback (VCD)

You can arrange the playback order of tracks or files on the disc. And the unit can also select tracks or files at random and playback them. These feature works for Video CD. For Audio CD and MP3/WMA CD, please see "Program playback" on page 58.

1. Press PLAY MODE in the stop mode.



2. Press ▲ or ▼ to select "Mode", then press ENTER to select "Program".



3. Press ◀ or ▶ to select the programming position. Use Number buttons (0–9) to input the Track on sequentially.
 - To program others, repeat step 3.
 - If you input a wrong number, press CANCEL.



4. Press ◀ or ▶ to return to the left column, then press ▲ or ▼ to select the "Program Playback" and press ENTER.

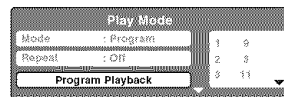

The programs you selected will start to playback in order.

- To resume normal playback, select Mode: "Off" in step 2.

To change the program

1. Select Mode to "Program" (as step 2), press ▲/▼/◀/▶ to select the track/file number you want to change, then press CANCEL.
2. Press Number buttons (0–9) to overwrite the new track/file number.

To clear the program one by one

Select Mode to "Program", press ▲/▼/◀/▶ to select the track/file number. Then press CANCEL.

To clear all the programs

In the left column, press ▲/▼ to select "Clear Program". Then press ENTER.

Random playback (VCD)

The unit selects tracks or files at random and playback. For Audio CD and MP3/WMA CD, please see "Random playback" on page 58.

1. Press PLAY MODE during playback or stop mode.
2. Press ▲/▼ to select "Mode", then press ENTER to select "Random".
3. Press PLAY.

The Random Playback will start.

- If you set "Random" during playback mode, Random playback will begin after the track/file that is currently being played has ended.
- To resume normal playback, select Mode: "Off" in step 2.

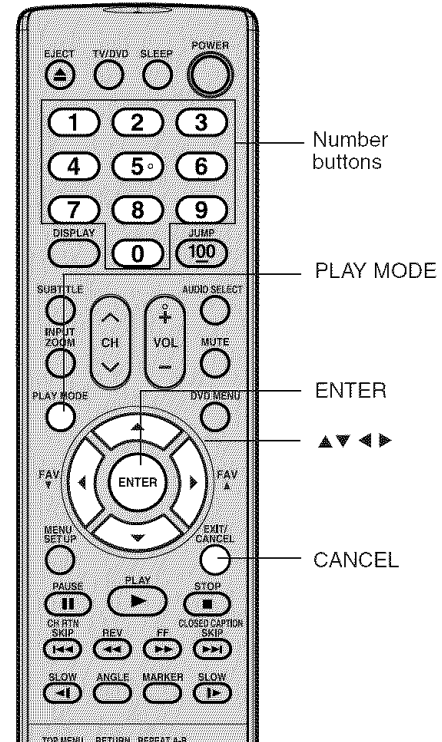

Note:

- The program is canceled when you eject the disc or turn the power off.
- In playing back the Video CD with PBC, you cannot set Program playback.

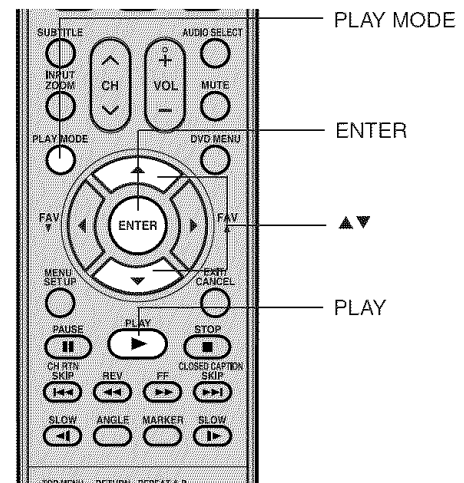

Note:

- In case of Video CD with PBC, you cannot set Random function during playback.

Changing angles (DVD)

When playing back a disc recorded with multi-angle facility, you can change the angle that you are viewing the scene from.

1. Press ANGLE during playback.
The current angle will appear.

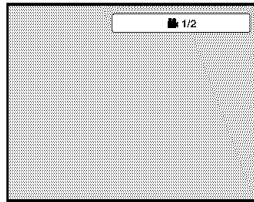

2. Press ANGLE repeatedly until the desired angle is selected.

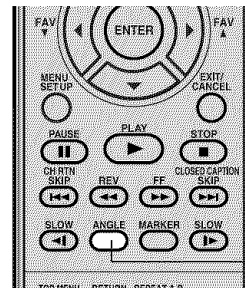

ANGLE

Note:

Depending on the DVD, you may not be able to change the angles even if multi-angles are recorded on the DVD.

Title selection (DVD)

Two or more titles are recorded on some discs. If the title menu is recorded on the disc, you can select the desired title.

1. Press TOP MENU during playback.
Title menu appears on the screen.
2. Press ▲/▼/◀/▶ to select the desired title.
3. Press ENTER or PLAY.
The playback of the selected title will start.

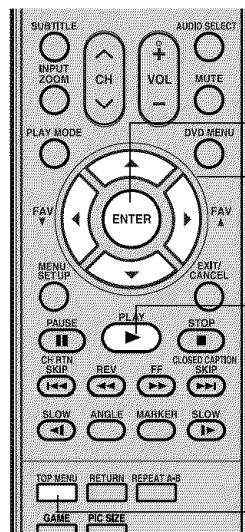

ENTER

▲▼◀▶

PLAY

TOP MENU

Note:

Depending on the DVD, you may not be able to select the title. Depending on the DVD, a "title menu" may simply be called a "menu" or "title" in the instructions supplied with the disc.

DVD menu (DVD)

Some DVDs allow you to select the disc contents using the menu. When you playback these DVDs, you can select the subtitle language and sound-track language, etc. using the menu.

1. Press DVD MENU during playback.
The DVD menu appears on the screen.
 - Press DVD MENU again to resume playback at the scene when you pressed DVD MENU.
2. Press ▲/▼/◀/▶ to select the desired item.
3. Press ENTER.
The menu continues to another screen. Repeat steps 2 and 3 to set the item completely.

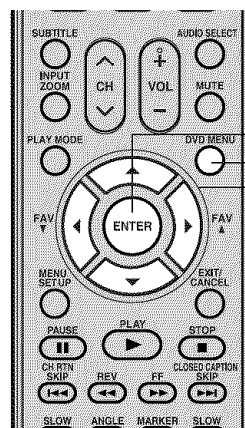

ENTER

DVD MENU

▲▼◀▶

Note:

Depending on the DVD, you may not be able to resume playback from the scene point when you pressed DVD MENU.

Introduction

Connecting
your TV/DVD

Setting up
your TV/DVD

Using the
TV/DVD's Features

DVD Playback

Appendix

Changing soundtrack language (DVD VCD)

You can select the language when you play a multilingual disc.

1. Press AUDIO SELECT during playback.
The current soundtrack language will appear.



2. Press AUDIO SELECT repeatedly until the desired language is selected.

- The on screen display will disappear after a few seconds.



In case of Video CD playback

Audio type changes as follows each time you press AUDIO SELECT.

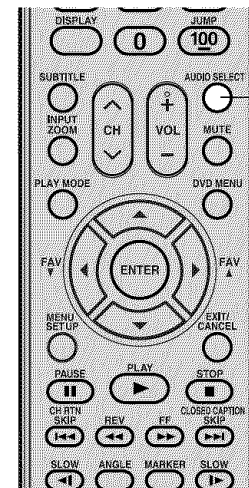
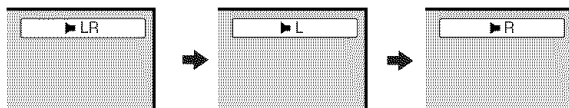

AUDIO SELECT

Note:

- If the desired language is not heard after pressing the button several times, the language is not recorded on the disc.
- The selected soundtrack language is canceled when you eject the disc. The initial default language or available language will be heard if the disc is played back again.
- If you select DTS in playing DTS-encoded disc, no sound will be heard from the TV/ DVD's speakers.

Subtitles (DVD)

When playing back a disc recorded with subtitles, you can select the subtitle language or turn the subtitle off.

1. Press SUBTITLE repeatedly during playback until the desired language selected.



2. To turn off the subtitle, press SUBTITLE until "Off" appears.

- The on screen display will disappear after a few seconds.

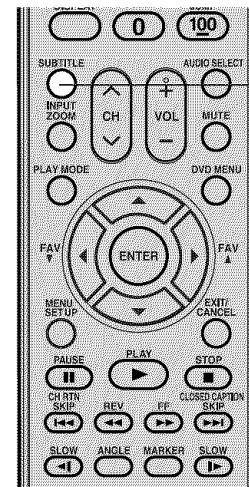
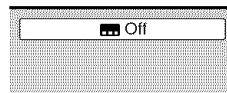

SUBTITLE

Note:

- Depending on the DVD, you may not be able to change subtitles, or to turn subtitles on or off.
- While playing a DVD, the subtitle may change when you loaded or eject the disc.
- In some cases, a selected subtitle language may not be changed immediately.

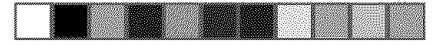
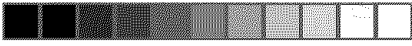

Disc status

With each press of DISPLAY, the status of the disc will appear on the screen and change as follows.

DVD

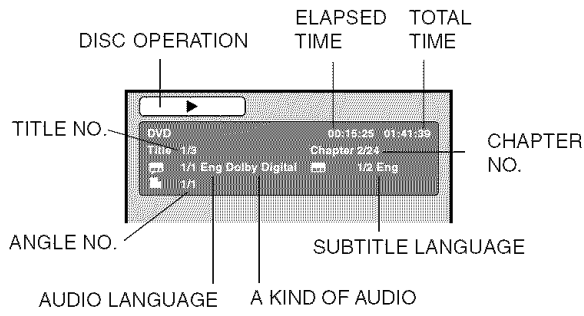

Video CD

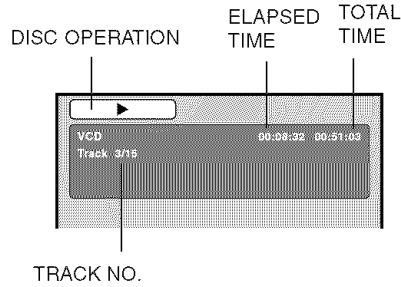

To turn off the PBC

1. Press PLAY MODE in the stop mode.
2. Press ▲/▼ to select "Mode", then press ENTER repeatedly until "Off" appear.
3. Press PLAY MODE again to clear the screen.



To turn on the PBC

Follow the above steps 1~2, then press ENTER repeatedly until "PBC" appear.

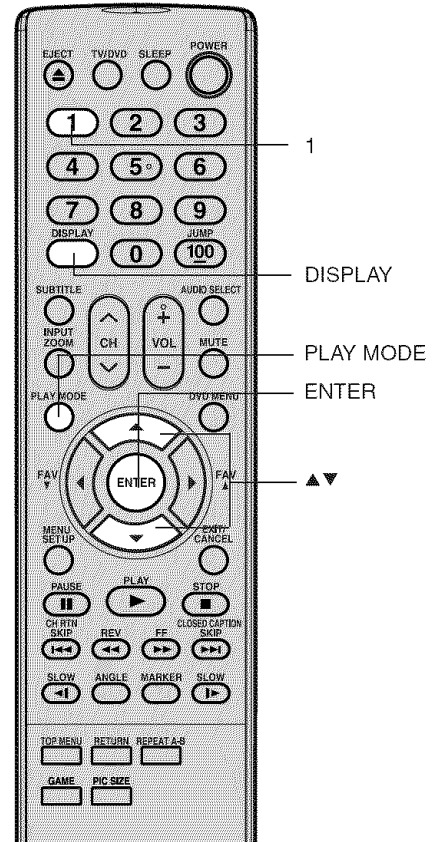

Note:

You can also turn off the PBC by pressing the number button 1 and ENTER in the stop mode.

Introduction

Connecting your TV/DVD

Setting up your TV/DVD

Using the TV/DVD's Features

DVD Playback

Appendix

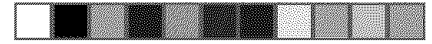
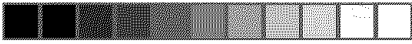

MP3/WMA/JPEG/DivX® and Audio CD operation

This player can playback the MP3/WMA/JPEG/DivX®-data which has been recorded on CD-R/RW. To produce the MP3/WMA/JPEG/DivX®-data, you need a Windows-PC with CD-RW drive and a MP3/WMA/JPEG/DivX®-encoding Software (not supplied). The Apple-HFS-System cannot be played.

This player requires discs/recordings to meet certain technical standards in order to achieve optimal playback quality. There are many different types of recordable disc formats (including CD-R containing MP3/WMA files). Not all recordable discs will produce optimal playback quality. The technical criteria set forth in this owner's manual are meant only as a guide. Use of CD-RW for MP3 files is not recommended.

You must obtain any required permission from copyright owners to download or use copyrighted content. Toshiba cannot and does not grant such permission.

MP3/WMA/JPEG/DivX® CD information

Limitations on MP3/WMA/JPEG/DivX® CD playback

- MP3/WMA/JPEG/DivX® CD is the disc that is standardized by ISO9660, its file name must include 3-digits extension letters, ".mp3", ".wma", ".jpg", ".div", ".divx", ".avi".
- MP3/WMA/JPEG/DivX® CD must be correspond to the ISO standardized files.
- This unit can read 600 files per disc. If one directory has more than 600 files, it reads up to 600 files, the remaining files will be omitted.
- The unit is able to recognize up to a maximum of 50 directories per disc.
- MP3/WMA/JPEG/DivX® CDs cannot be used for the purpose of recording.
- If the CD has both CDA audio tracks and MP3/WMA/JPEG/DivX® files, only the CDA audio tracks will be played.
- It may take more than one minute for this unit to read MP3/WMA/JPEG/DivX® files depending on its structure.
- Music recorded by "Joliet Recording Specification" can be played back, the file name is displayed (within 15 letters) on the screen. Long file names will be condensed.
- The music files recorded by "Hierarchical File System" (HFS) cannot be played.

Limitations on display

- The maximum number for display is 15 letters.
Available letters for display are the following:
capital or small alphabets of A through Z, numbers of 0 through 9, and _ (under score).
- Other letters than those above are replaced in hyphen.

Notes on MP3/WMA/JPEG/DivX® files

To playback MP3/WMA/JPEG/DivX® CD in the recorded order,

1. Use MP3/WMA/JPEG/DivX® software that records data alphabetically or numerically.
2. Name each file including two-digit or three-digit number (ex. "01" "02" or "001" "002").
3. Refrain from making too many sub-folders.

CAUTION:

- Some MP3/WMA/JPEG/DivX® CDs cannot be played back depending on the recording conditions.
- The CD-R/RW that has no music data or non MP3/WMA/JPEG/DivX® files cannot be played back.

Standard, sampling frequency, and the bit rate:

MP3

MPEG-1 Audio

32kHz, 44.1kHz, 48kHz

32kbps ~ 320kbps (constant bit rate or variable bit rate)

The recommend recording setting for a high-quality sound is 44.1kHz of sampling frequency and 128kbps of constant bit rate.

WMA

WMA version 7, and 8

32kHz/48kbps, 44.1kHz/48kbps~192kbps, 48kHz/128kbps~192kbps

The file recorded by mono, 48kHz, 48 kbps is not available to this unit.

DivX® video

DivX® version: DivX® 3, 4, 5, and 6 (specifically 3.1.1, 4.1.2, 5.0.2, 5.0.5, 5.1.1, 5.2.1, 6.0 at Home Theater profile).

Audio format: MPEG1 Layer2 (MP2), MPEG1 Layer3 (MP3)

Sampling frequencies: 32kHz, 44.1kHz, 48kHz

Bit rate: 32kbps ~ 320kbps

Resolution: Max 720 x 576 (at 25fps), Max 720 x 480 (at 30fps)

Microsoft, Windows Media, and Windows Logo are either registered trademarks or trademarks of Microsoft Corporation in the United States and/or other countries.

DivX, DivX Certified, and associated logos are trademarks of DivX, Inc. and are used under license.

Apple is a registered trademark of Apple Computer, Inc.

MP3/WMA CD and Audio CD playback

1. Load an Audio CD or a disc on which MP3 or WMA files have been recorded in the disc slot.

2. A file browser screen will appear on the screen.
Press ▲/▼ or ENTER to select folder.

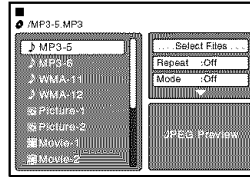

3. Press ▲/▼ to select the desired file.
 - In case the folder includes more than 8 files, press ▲ or ▼ to display next file list.
 - To see contents in folder, select the folder and then press ENTER. To return to the upstairs directory, select "Go Up ..." then press ENTER.

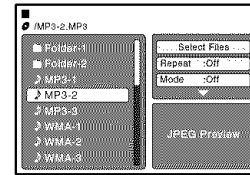



- When PLAY is pressed after the file browser displayed, playback begins automatically starting from the first file. In this case, if the first file is an MP3/WMA file, only MP3/WMA files are played back in order. If the first file is a JPEG file, the first JPEG file is played back. If the first file is a DivX® file, the first DivX® file is played back. If there is no file at a root directory, playback does not begin automatically.

4. Press ENTER.
The selected file starts playing back.
5. Press STOP to end playback.
 - The unit records the stopped point. "■" appears on the screen. Press PLAY to resume playback (from the scene point).
 - If you press STOP again or unload the disc, the unit will clear the stopped point.

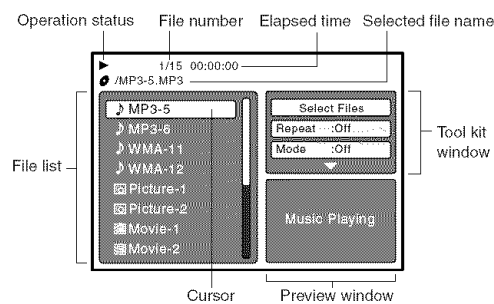
About file menu



File type

-  : Indicates Music file (Audio/MP3/WMA)
-  : Indicates Picture file (JPEG)
-  : Indicates Movie file (DivX@video)

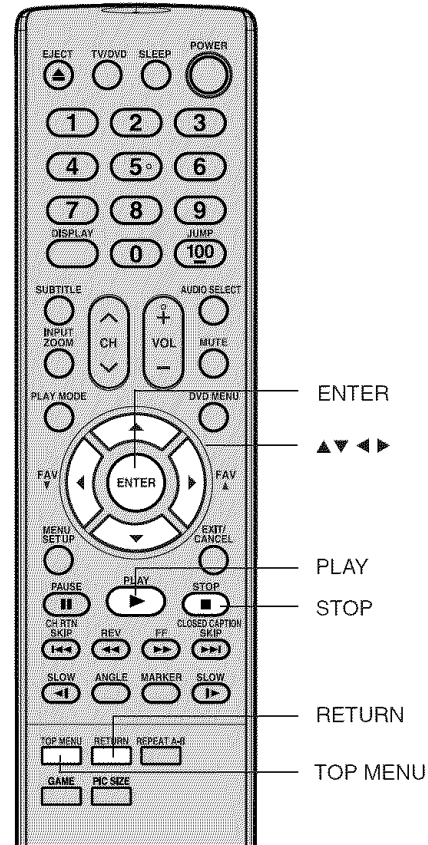

Note:

- During MP3/WMA/JPEG playback, you cannot use JUMP, A-B Repeat functions.
- You can use Repeat (Track or All), Random functions and Program playback for MP3/WMA/JPEG/DivX® CD playback (see page 58).
- The picture menu is displayed when the FUJICOLOR CD or the Kodak Picture CD are played. To display the file menu, press TOP MENU.
- In the case of a CD containing a mixture of MP3, WMA, JPEG and DivX® files, the files are played back by selecting them from the file menu.
- MP3 or WMA file on the Kodak Picture CD is not recognized on this unit.

Select Files

The file type to make it display in the file browser can be chosen.

1. Press ◀ or ▶ to highlight "Select Files" at right column in the file browser.
2. Press ENTER, then press ▲ or ▼ to select file type from the list (Music, Picture or Movie).
3. Press ENTER to add/remove check mark. Checked file type will be displayed in the file browser.
4. Press RETURN to save the setting.

Introduction

Connecting your TV/DVD

Setting up your TV/DVD

Using the TV/DVD's Features

DVD Playback

Appendix

JPEG CD playback

You can select your desired JPEG file on the file menu and picture menu. The selected JPEG file is automatically adjusted to the TV screen. (When the aspect ratio of a JPEG file is different from that of the TV screen, the black bars will appear at the top, bottom, and/or sides of the TV screen.)

1. Load a JPEG disc in the disc slot.
2. A file browser screen will appear on the screen.

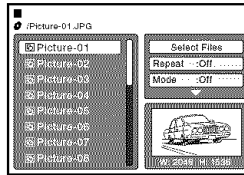



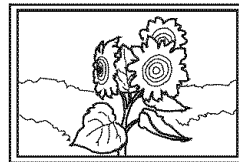

3. Press ▲/▼ to select the desired file. To display a thumbnail list, press DVD MENU. (To return to a file browser, press TOP MENU.) Press ◀/▶/▲/▼ to select the desired file.
 - When PLAY is pressed after displaying the file browser, playback begins automatically starting from the first file. In this case, if the first file is a JPEG file, the first JPEG file is played back. If the first file is a DivX® file, the first DivX® file is played back. If the first file is an MP3/WMA file, only MP3/WMA files are played back in order. If there is no file at a root directory, playback does not begin automatically.

4. Press ENTER or PLAY. The selected picture appears on the screen.



Rotating an image

You can rotate an image by 90 degrees. Pressing ANGLE during playback of the image.

“”, “”, “” or “” appears briefly on the screen.

Zooming an image







Zoom function also can be used in viewing JPEG files. Press ZOOM (See “Zooming” page 47).

5. Press STOP to end playback. The file browser appears on the screen. If you want to watch the other file, repeat steps 3 ~ 4.

Slide show playback

The slide show enables you to view pictures (files) one after another automatically.

Preparation:

- Set “JPEG Interval” setting to “5 Seconds”, “10 Seconds” or “15 Seconds”. (See page 60.)
1. Select your desired starting file for the slide show in the step 3 on the above.
 2. Press ENTER or PLAY to start slide show from the selected file.
 - If you press PAUSE during the slide show, the slide show stops temporarily. “” appears briefly on the screen. If the picture appears upside down or sideways, press ANGLE repeatedly until it’s right side up. “”, “”, “” or “” appears briefly on the screen. Press PLAY or SKIP  again to resume the slide show.
 - When slide show playback finished, the file browser appears.
 - To stop the slide show, press STOP. The file browser appears.

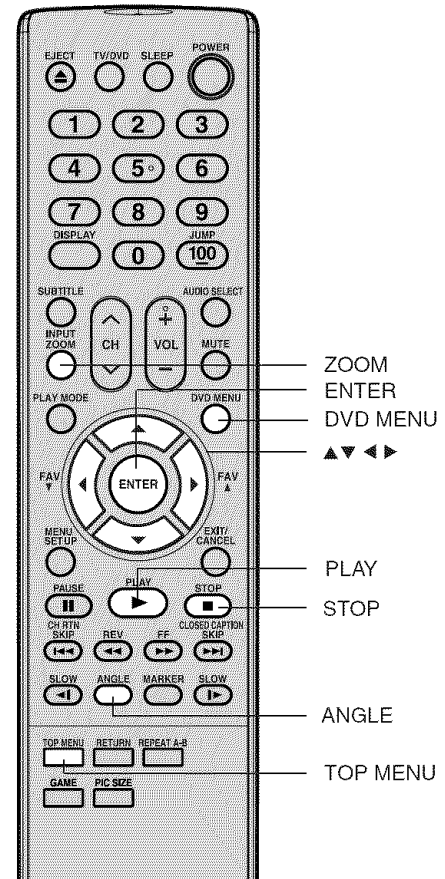

Note:

During JPEG playback, you cannot use Jump and A-B Repeat functions.

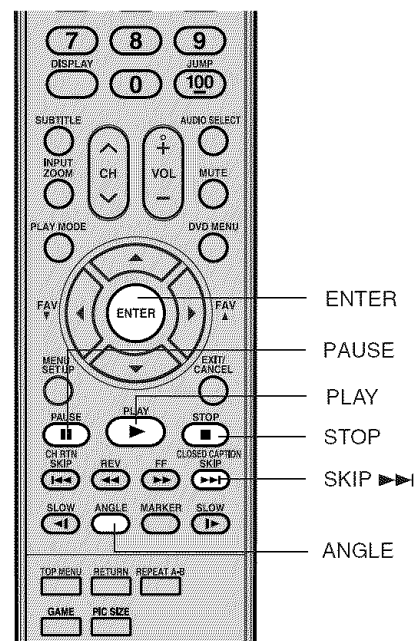

DivX® CD playback

1. Load a DivX® disc in the disc slot.
2. A file browser screen will appear on the screen.

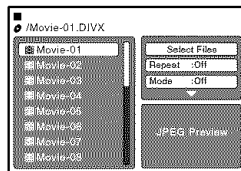

3. Press ▲/▼ to select the desired file.
When PLAY has been pressed after displaying the file browser, playback begins automatically starting from the first file. In this case, if the first file is a JPEG file, the first JPEG file is played back. If the first file is a DivX® file, the first DivX® file is played back. If the first file is an MP3/WMA file, only MP3/WMA file are played back in order. If there is no file at a root directory, playback does not begin automatically.
4. Press ENTER or PLAY. The selected DivX® movie will be played back on the screen.
5. Press STOP to end playback.
The file browser appears on the screen. If you want to watch the other file, repeat steps 3 ~ 4.

Playing DivX® VOD content

DivX® VOD content is protected by DRM (Digital Rights Management) system. This restricts playback of content to specific registered devices.

If the incorrect DRM file is loaded, "Authorization Error This player is not authorized to play this video." will appear on the screen.
When you attempt to play DivX® VOD, the number of plays is limited and the right message will appear on the screen. If you wish to play it, select "YES".

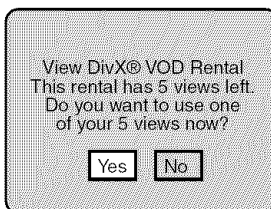

- If the number of plays goes over the limit, then "Rental Expired" will be displayed, in this case the file will not be played.

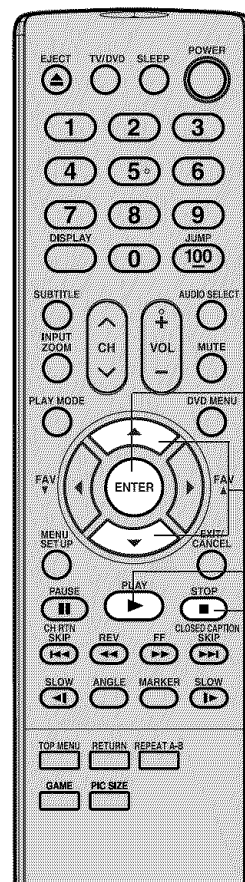

Note:

In order to play DivX® VOD content on this unit, you first need to register the unit with registration code. See page 61.

Introduction

Connecting
Your TV/DVD

Setting up
Your TV/DVD

Using the
TV/DVD's Features

DVD Playback

Appendix

Repeat and program playback using file browser

Repeat playback

1. In the file browser, press ◀/▶ or ▲/▼ to select "Repeat" in stop mode.

2. Press ENTER to select "Track" or "All".

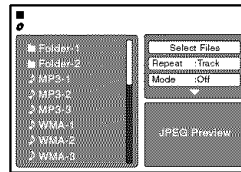

3. Press PLAY.
The unit automatically starts repeat playback after finishing the current track.

To resume normal playback

Select Repeat : "Off" in step 2.

Random playback

1. In the file browser, press ◀/▶ or ▲/▼ to select "Mode" in stop mode.

2. Press ENTER to select "Random".

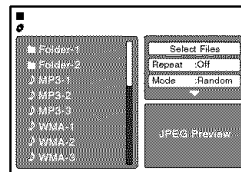

3. Press PLAY.
The Random playback will start.

To resume normal playback

Select Mode : "Off" in step 2.

Program playback

1. In the file browser, press ◀/▶ or ▲/▼ to select "Edit Mode", then press ENTER. When "Edit Mode" is in black screen, the files which you want to add into Program list can be marked.

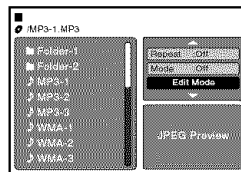

2. Press ◀/▶ or ▲/▼ to select file you want to add into the program list.
Press ENTER. Selected file was marked.
Repeat this procedure to select the other files.

3. Press ◀/▶ or ▲/▼ to select "Add To Program".
Then press ENTER. All marked files are added into the program list.
When you finish store all files which you want into the Program list, select "Edit Mode" and press ENTER to release Edit Mode.

4. Press ◀/▶ or ▲/▼ to select "Program View", then press ENTER. Program View shows only the programmed files that you have added in step 2.

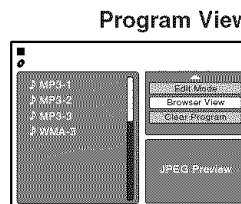

5. In the Program View, press PLAY. The files start to playback in programmed order that were added by you.

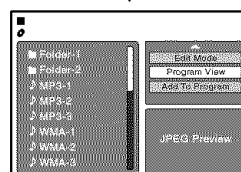

To remove file from program list

In the Edit Mode, switch to Program View. Select file you want to remove, then press ENTER.

Select "Clear Program" and press ENTER. Marked file is removed from program list.

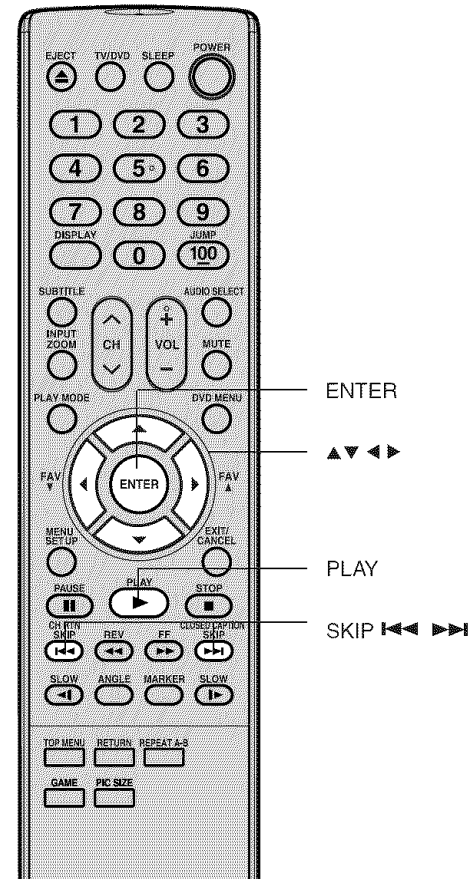

Note:

- The Repeat, Random and Program functions are canceled when you eject the disc or turn the power off.
- In case of Audio CD, the function of A-B Repeat can be used. See "A-B Repeat playback" on page 49.
- Track repeat function is canceled whenever SKIP ◀◀ or ▶▶ is pressed.

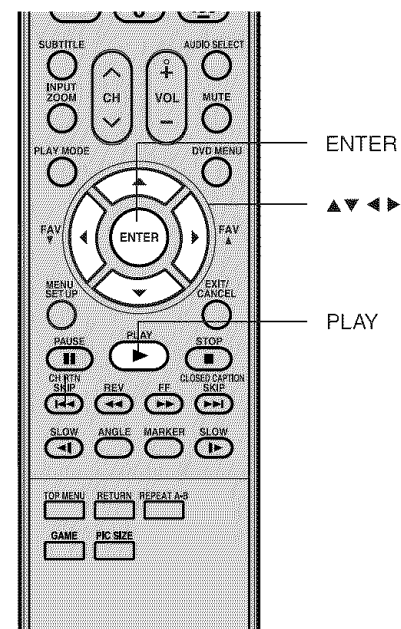

DVD function setup

Customizing the function settings



You can change the default settings of the DVD mode to customize performance to your preference.

Setting procedure **DVD** **VCD** **CD**

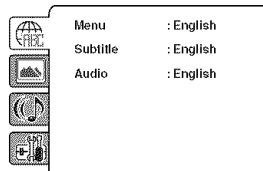
1. Press **SETUP** during stop mode.
The following on-screen display appears.

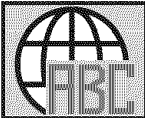

2. Press **▲** or **▼** to select the desired section, then press **▶**.
3. Press **▲** or **▼** to select the desired option.
4. Then press **▶** or **ENTER**. The selectable settings will appear.
5. Change the selection using **▲** or **▼**, by referring to the corresponding pages 60 to 61.
Press **ENTER** to save the setting.
 - Repeat steps 3 and 5 to change other option.
 - To select another section, go back to step 2 by pressing **◀** repeatedly.
6. To clear **SETUP** screen, press **SETUP** or **RETURN**.

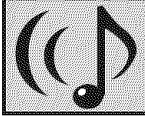
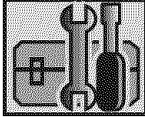
Section	Option	Details	Page
	Menu Subtitle Audio	To select the language of "Menu", "Subtitle" and "Audio" if more than one language are available on the disc.	60
	TV Screen	To select a picture size according to the aspect ratio of your TV.	
	Display	To turn On or Off the operational status display on the screen.	
	Picture Mode	To select a preferred picture mode from "Video", "Film" or "Auto".	
	JPEG Interval	To select a preferred setting for the slide show playback.	
	DRC	To select On or Off for DRC (Dynamic Range Control).	61
	Parental	To select a preferred parental level for the parental setting.	
	Password	Input 4-digit password to set the parental level.	
	DivX(R) VOD	To display your 8-character registration code.	

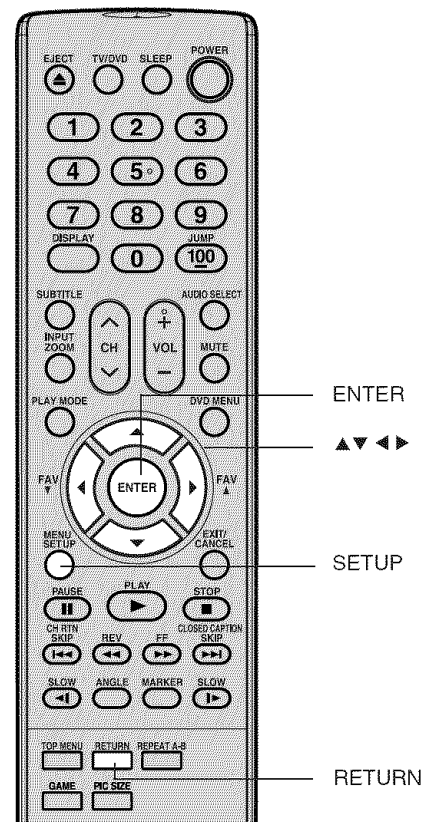

Introduction

Connecting
your TV/DVD

Setting up
your TV/DVD

Using the
TV/DVD's Features

DVD Playback

Appendix

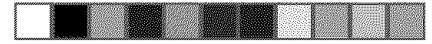
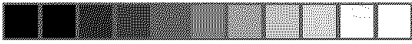

Setting details

Language

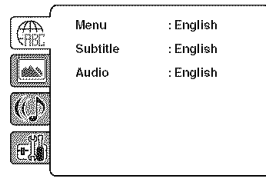

Menu, Subtitle, Audio

You can select the language of “Menu”, “Subtitle” and “Audio” if more than one language is recorded onto the disc.

English, Francais, Espanol:

The selected language will be heard or seen.

Other:

Other language can be selected (see “Language code list” page 63).

Off (Subtitle):

Subtitles do not appear.

Original (Audio):

The unit will select the first priority language of each disc.

Note:

- If the selected language is not recorded on the disc, the first-priority language is selected.
- If you want to change the OSD language, you can perform it by TV SETUP MENU (see page 23).

Picture

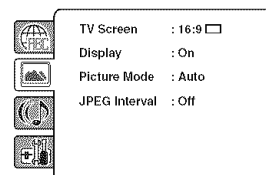

Tv Screen

You have the following screen sizes to choose from:

4:3 (Letter box):

Select this mode when connecting to a conventional TV.

When playing back a wide screen-DVD disc, it displays the wide picture with black bands at the top and bottom of screen.

4:3 (Pan & scan):

It displays the wide picture on the whole screen with left and right edges automatically cut off.

16:9 (Wide):

A wide screen picture is displayed full size.

Note:

If the DVD disc is not formatted in the pan & scan style, it will displays 4:3 style.

Display

On screen display can be switched on or off when you press any buttons.

On: On screen displays appear when you press the buttons (factory setting).

Off: On screen displays do not appear when you press any buttons.

Picture Mode

There are two types of source content in pictures recorded in DVD video discs: film content (pictures recorded from films at 24 frames per second) and video content (video signals recorded at 30 frames per second). Make this selection according to the type of content being viewed.

Auto: Select this position normally.

The DVD player automatically detects source content, film or video of playback source, and converts that signal in the progressive output format in an appropriate method.

Film: The DVD player converts film content pictures in the progressive output format appropriately. Suitable for playback of film content pictures. The progressive output feature will be most effective under this selection.

Video: The DVD player filters video signal, and converts it in the progressive output format appropriately. Suitable for playback of video content pictures.

Note:

Depending on the disc, pictures may be cut off or doubled. In this case, select “Video”.

JPEG Interval

You can continuously playback all JPEG files automatically. After the setting below, the disc will start playback on which JPEG files have been recorded.

Off:

Plays back one file at a time.

5 Seconds:

Plays back images in the form of a slide show at 5 second intervals.

10 Seconds:

Plays back images in the form of a slide show at 10 second intervals.

15 Seconds:

Plays back images in the form of a slide show in 15 second intervals.

Setting details

Sound

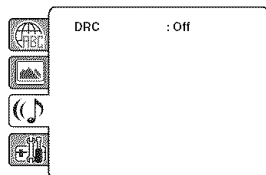

DRC

DRC (Dynamic Range Control) enables you to control the dynamic range so as to achieve a suitable sound for your equipment.

On: Loud sound such as explosion is toned down slightly when played back. This is suitable when it is connected to a stereo.

Off: It plays back at the recording level on the disc.

Note:

- This function works only during playback of Dolby Digital recorded discs.
- The level of Dynamic Range Reduction may differ depending on DVD video disc.

Parental

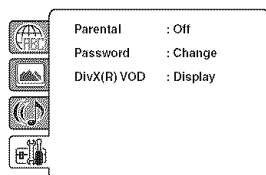

Parental control setting

Some discs are specified as not suitable for children. Such discs can be limited not to playback with the unit.

- 1) Press ▲ or ▼ to select "Parental", then press ENTER. "Enter Password" screen will appear.
- 2) Press "0000" using Number buttons (0–9). (Please note, this is pre-setting password of this unit). Then press ENTER. The parental level list will appear.
 - **Level Off:** The parental control setting does not function.
 - **Level 8:** Virtually all DVD software can be played back.
 - **Level 1:** DVD software for adults cannot be played back.
- 3) Press ▲ or ▼ to select from the level 1 to level 8. The limitation will be more severe as the level number is lower. Then press ENTER.

Note:

- Depending on the discs, the unit cannot limit playback.
- Some discs may not be encoded with specific rating level information though its disc jacket says "adult." For those discs, the age restriction will not work.
- The password is required every time when you change the parental level.
- If you input a wrong number, press CANCEL.

Set the new password

- 1) Press ▲ or ▼ to select "Password", then press ENTER. "Enter Current Password" screen will appear.
- 2) Press Number buttons (0–9) to input the current password (If the password has not been set yet after you purchase this unit, it is "0000").
- 3) Then press ENTER. "Enter New Password" screen will appear. Press Number buttons (0–9) to input the new password.
- 4) Press ENTER. Now your new password has been set. Be sure to remember this number!

If you forget the password.

- 1) Press EJECT to remove the disc.
- 2) While holding 7 down on the remote control and at the same time press STOP on the front panel. "Password Clear" appears on the screen. Now the password has been returned to the initial value ("0000").

DivX(R) VOD

In order to play DivX® VOD (Video On Demand) content on this unit, you first need to register the unit with your DivX® VOD content provider. You do this by generating a DivX® VOD registration code, which you submit to your provider.

Press ▲ or ▼ to select "DivX(R) VOD". Then press ENTER. Your 8-character registration code is displayed. Make a note of the code as you will need it when you register with a DivX® VOD provider. Then press ENTER to select Done.

Note:

If each setup (pages 60 to 61) has completed, the unit can always work under the same condition (especially with DVD discs). Each setup will be retained in the memory even if you turn the power off.

Introduction

Connecting
Your TV/DVD

Setting up
Your TV/DVD

Using the
TV/DVD's Features

DVD Playback

Appendix

Temporary cancel the rating level by DVD disc

Depending on the DVD disc, the disc may try to temporarily cancel the parental level that you have set. It is up to you to decide whether to cancel the rating level or not.

1. Load a DVD disc.

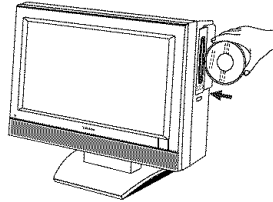

2. If the DVD disc has been designed to temporarily cancel the Rating level, the screen which follows the "Reading" screen will change, depending on which disc is played. If you select "YES" with the ENTER key, password input screen will then appear.
 - If "NO" is selected, press EJECT to remove the disc.

3. Enter the password with Number buttons (0–9). Then press ENTER.

To exit from the entry, press RETURN.

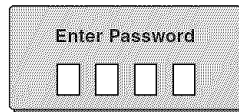

4. Playback will commence if the entered password is correct.

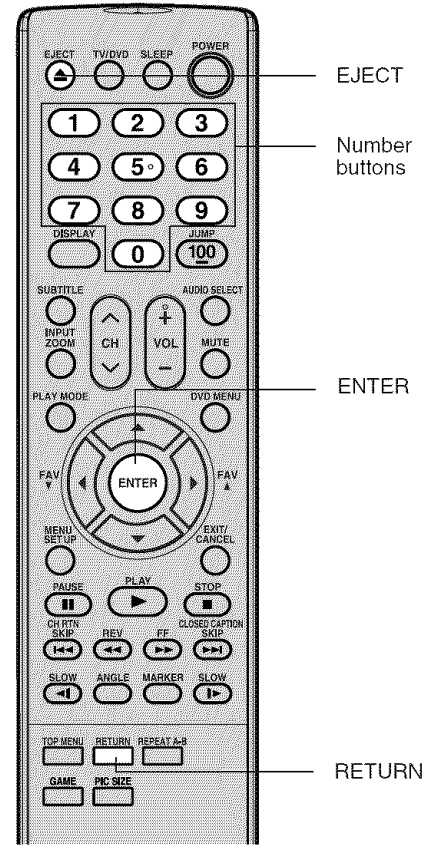

Note:

This temporary cancellation of rating level will be kept until the disc is ejected. When the disc is ejected, the original parental rating level will be set again automatically.

Appendix

Language code list

Enter the appropriate code number for the initial settings "Menu", "Subtitle" and/or "Audio." See page 60.

Language Name Code	Language Name Code	Language Name Code	Language Name Code
Abkhazian 1112	Fiji 1620	Lingala 2224	Singhalese 2919
Afar 1111	Finnish 1619	Lithuanian 2230	Slovak 2921
Afrikaans 1116	French 1628	Macedonian 2321	Slovenian 2922
Albanian 2927	Frisian 1635	Malagasy 2317	Somali 2925
Amharic 1123	Galician 1722	Malay 2329	Spanish 1529
Arabic 1128	Georgian 2111	Malayalam 2322	Sundanese 2931
Armenian 1835	German 1415	Maltese 2330	Swahili 2933
Assamese 1129	Greek 1522	Maori 2319	Swedish 2932
Aymara 1135	Greenlandic 2122	Marathi 2328	Tagalog 3022
Azerbaijani 1136	Guarani 1724	Moldavian 2325	Tajik 3017
Bashkir 1211	Gujarati 1731	Mongolian 2324	Tamil 3011
Basque 1531	Hausa 1811	Nauru 2411	Tatar 3030
Bengali; Bangla 1224	Hebrew 1933	Nepali 2415	Telugu 3015
Bhutani 1436	Hindi 1819	Norwegian 2425	Thai 3018
Bihari 1218	Hungarian 1831	Oriya 2528	Tibetan 1225
Breton 1228	Icelandic 1929	Panjabi 2611	Tigrinya 3019
Bulgarian 1217	Indonesian 1924	Pashto, Pushto 2629	Tonga 3025
Burmese 2335	Interlingua 1911	Persian 1611	Turkish 3028
Byelorussian 1215	Irish 1711	Polish 2622	Turkmen 3021
Cambodian 2123	Italian 1930	Portuguese 2630	Twi 3033
Catalan 1311	Japanese 2011	Quechua 2731	Ukrainian 3121
Chinese 3618	Javanese 2033	Rhaeto-Romance 2823	Urdu 3128
Corsican 1325	Kannada 2124	Romanian 2825	Uzbek 3136
Croatian 1828	Kashmiri 2129	Russian 2831	Vietnamese 3219
Czech 1329	Kazakh 2121	Samoan 2923	Volapük 3225
Danish 1411	Kirghiz 2135	Sanskrit 2911	Welsh 1335
Dutch 2422	Korean 2125	Scots Gaelic 1714	Wolof 3325
English 1524	Kurdish 2131	Serbian 2928	Xhosa 3418
Esperanto 1525	Laothian 2225	Serbo-Croatian 2918	Yiddish 2019
Estonian 1530	Latin 2211	Shona 2924	Yoruba 3525
Faroese 1625	Latvian, Lettish 2232	Sindhi 2914	Zulu 3631

Introduction

Connecting
Your TV/DVD

Setting up
Your TV/DVD

Using the
TV/DVD's Features

DVD Playback

Appendix

Appendix

Troubleshooting

Before calling a service technician, please check the following table for a possible cause of the symptom and some solutions.

Symptom	Solution
TV will not turn on	<ul style="list-style-type: none"> • Make sure the AC cord is connected securely and then press POWER. • The remote control batteries may be dead. Replace the batteries.
No picture, no sound	<ul style="list-style-type: none"> • Check the antenna/cable connections.
No sound, picture OK	<ul style="list-style-type: none"> • The sound may be muted. Press VOL +/-. • The station may have broadcast difficulties. Try another channel. • The MTS feature may be in SAP mode. Select STR or MONO in the MTS menu.
Poor sound, picture OK	<ul style="list-style-type: none"> • The station may have broadcast difficulties. Try another channel. • The MTS feature may be in SAP mode. Select STR or MONO in the MTS menu.
Poor picture, sound OK	<ul style="list-style-type: none"> • Check the antenna connections. • The station may have broadcast difficulties. Try another channel. • Adjust the PICTURE menu.
Picture and sound are out of sync	<p>As with all products that contain a digital display, in rare instances, when viewing certain content (e.g., television broadcasts, video games, DVDs), you may notice that the sound and picture are slightly out of sync. This phenomenon can be caused by various factors including, without limitation, video processing within the TV, video processing in an attached gaming system, and video processing/different compression rates used by broadcasters in their programming. You may want to try one or more of the following suggestions, which may help to reduce the effect of this phenomenon:</p> <ul style="list-style-type: none"> • If the TV is connected to an external A/V device (e.g., DVD player, video game system, set-top-box, etc.) always try to use the Color Stream video jacks and corresponding audio jacks or the HDMI input (if available on your TV) for connection to such external A/V device. • If the TV is connected to an A/V receiver that has a programmable audio delay feature, use this feature to help synchronize the sound to the picture. • If connected to a video game system and your TV has the Game Mode feature (see owner's manual for more information), enable this feature. • If you notice this phenomenon only on certain TV channels, please contact your local broadcast, cable, or satellite provider to inform them of this issue.
Poor reception of broadcast channels	<ul style="list-style-type: none"> • The station may have broadcast difficulties. Try another channel. • Check the antenna connections.
Cannot receive above channel 13	<ul style="list-style-type: none"> • Make sure TV/CABLE is set to CABLE mode.
Unable to select a certain channel	<ul style="list-style-type: none"> • The channel may be blocked by the V-Chip feature or CH LOCK feature, or erased with the add/erase feature.
Cannot access signal input sources (Video1, Video2, ColorStream HD, HDMI and PC) and/or Channels 3 and 4	<ul style="list-style-type: none"> • Check the VIDEO LOCK feature.
Multiple images	<ul style="list-style-type: none"> • The station may have broadcast difficulties. Try another channel. • Use a highly directional outdoor antenna.
Poor color or no color	<ul style="list-style-type: none"> • The station may have broadcast difficulties. Try another channel. • Adjust the TINT and/or COLOR in the PICTURE menu.
Black box on screen	<ul style="list-style-type: none"> • Select OFF in the Closed Caption menu to turn off the Closed Caption Text mode.
No stereo or SAP sound from a known MTS broadcast	<ul style="list-style-type: none"> • Make sure the MTS feature is set properly (AUDIO menu).
The V-Chip password does not work (U.S. V-Chip system only)	<ul style="list-style-type: none"> • Change or reset your password.
The remote control does not operate	<ul style="list-style-type: none"> • Remove all obstructions between the remote control and the TV. • The remote control batteries may be dead. Replace the batteries.
The top panel buttons do not operate	<ul style="list-style-type: none"> • Check the PANEL LOCK feature.

Troubleshooting (continued)

Symptom of DVD

Solution

Playback doesn't start	<ul style="list-style-type: none">• No disc is loaded.• The disc may be dirty. Clean the disc.• The unit cannot play CD-ROMs, etc.
No picture	<ul style="list-style-type: none">• TV/DVD selector is not set correctly.
No sound	<ul style="list-style-type: none">• Make sure the input selector of the amplifier is set properly.• The unit is in the special playback mode.• Select the correct Audio Output/Input position on AV amplifier.
Picture is distorted during fast reverse/forward playback	<ul style="list-style-type: none">• The picture will be distorted occasionally.
Stopping playback, search, slow-motion play, repeat play, or program play, etc. cannot be performed	<ul style="list-style-type: none">• Some discs may not perform certain functions.
No on-screen display	<ul style="list-style-type: none">• Set Display to On.
No surround sound	<ul style="list-style-type: none">• The setup does not match your stereo system.
The unit or remote operation key is not functioning	<ul style="list-style-type: none">• Turn off the unit and unplug the AC power cord for several minutes, then replug it.
Playback does not start when the title is selected	<ul style="list-style-type: none">• Check the Parental level setup.
Audio soundtrack and/or subtitle language is not changed when you playback a DVD	<ul style="list-style-type: none">• Multilingual language is not recorded on the DVD disc.
No subtitle	<ul style="list-style-type: none">• Some discs have no subtitles.• Subtitles are cleared. Press SUBTITLE.
Angle cannot be changed	<ul style="list-style-type: none">• Multi-angles are not recorded on the DVD discs.
"X" appears on the screen	<ul style="list-style-type: none">• The function is prohibited with the unit or the disc.

Introduction

Connecting
Your TV/DVD

Setting up
Your TV/DVD

Using the
TV/DVD's Features

DVD Playback

Appendix

Specifications

Note:

- This model complies with the specifications listed below.
- Designs and specifications are subject to change without notice.
- This model may not be compatible with features and/or specifications that may be added in the future.

Television	
LCD panel	22.95 inches (583.0 mm diagonal) (approx.) (Screen size is approximate.)
Display method	Color TFT LCD
Number of pixels	1366 (Horizon) x 768 (Vertical)
Television system	NTSC standard
Tuner type	F-Synth
Channel coverage	VHF: 2 – 13 UHF: 14 – 69 Cable TV: 4A, A-5 – A-1, A-I, J – W, W+1 – W+84
Antenna input	VHF/UHF 75 ohm
Power source	120V AC, 60 Hz
Power consumption	130 W
Audio power	2.5 W + 2.5 W
Speaker type	1.8 x 3.9 inches (45.7 x 99.1 mm), 8 ohm x 2
Video/Audio terminals	<p>S-VIDEO INPUT</p> <p>Y-INPUT: 1V (p-p), 75 ohm, negative sync., Mini DIN 4pin x 1 C-INPUT: 0.286V (p-p) (burst signal), 75 ohm</p> <p>VIDEO/AUDIO INPUT</p> <p>VIDEO: 1V (p-p), 75 ohm, negative sync., pin jack x 2 AUDIO: –8dBm, 50k ohm, negative sync., pin jack (L/R) x 4</p> <p>ColorStream® (component video) INPUT</p> <p>Y: 1V (p-p), 75 ohm P_R: 0.7V (p-p), 75 ohm P_B: 0.7V (p-p), 75 ohm</p> <p>DIGITAL AUDIO OUTPUT (Coaxial) DVD mode only</p> <p>0.5V (p-p), 75 ohm, pin jack x 1</p> <p>HEADPHONE</p> <p>Ø3.5mm stereo mini jack x 1</p> <p>HDMI INPUT: HDMI compliant (type A connector)</p> <p>HDCP compliant E-EDID* compliant Suggested scan rates: 1080i, 480p, 480i, 720p HDMI Audio: 2-channel PCM 32/44.1/48 kHz sampling frequency 16/20/24 bits per sample</p> <p>PC Monitor Input</p> <p>Mini-Dsub 15pin x 1</p>
Dimensions	Width: 23-9/16 inches (599 mm) Height: 19 inches (482.5 mm) Depth: 10-1/4 inches (260 mm)
Weight	25.4 lbs. (11.5 kg)
Supplied accessories	Remote control (DC-LWB1) with two size “AAA” batteries Owner’s Manual (This booklet)
DVD/CD Player	
Signal system	NTSC
Applicable disc	1. DVD (12cm, 8cm) 2. CD (12cm, 8cm)
Pickup	1-Lens, 2-Beams System

* E-EDID = Enhanced-Extended Display Identification.

WARNING: If you decide to wall mount this television, always use a UL-approved wall bracket appropriate for the size and weight of this television. The use of any wall bracket other than a UL-approved wall bracket appropriate for the size and weight of this television for wall mounting this television could result in serious bodily injury and/or property damage.

Limited United States Warranty

LCD TV/DVD Combination - Depot Repair Warranty

Toshiba America Consumer Products, L.L.C. ("TACP") makes the following limited warranties to original consumers in the United States. **THESE LIMITED WARRANTIES EXTEND TO THE ORIGINAL CONSUMER PURCHASER OR ANY PERSON RECEIVING THIS LCD TV/DVD COMBINATION AS A GIFT FROM THE ORIGINAL CONSUMER PURCHASER AND TO NO OTHER PURCHASER OR TRANSFEREE.**

LCD TV/DVD COMBINATIONS PURCHASED IN THE U.S.A. AND USED ANYWHERE OUTSIDE OF THE U.S.A., INCLUDING, WITHOUT LIMITATION, CANADA AND MEXICO, ARE NOT COVERED BY THESE WARRANTIES.

LCD TV/DVD COMBINATIONS PURCHASED ANYWHERE OUTSIDE OF THE U.S.A., INCLUDING, WITHOUT LIMITATION, CANADA AND MEXICO, AND USED IN THE U.S.A., ARE NOT COVERED BY THESE WARRANTIES.

Limited One (1) Year Warranty on Parts and Labor

TACP warrants this LCD TV/DVD Combination and its parts against defects in materials or workmanship for a period of one (1) year after the date of original retail purchase. **DURING THIS PERIOD, TACP WILL, AT TACP'S OPTION, REPAIR OR REPLACE A DEFECTIVE PART WITH A NEW OR REFURBISHED PART WITHOUT CHARGE TO YOU.**

Rental Units

The warranty for LCD TV/DVD Combination rental units begins on the date of the first rental or thirty (30) days after the date of shipment to the rental firm, whichever comes first.

Commercial Units

LCD TV/DVD Combinations sold and used for commercial purposes have a limited warranty for all parts and labor, which warranty begins on the date of original retail purchase and ends on the date that is ninety (90) days thereafter.

Owner's Manual and Product Registration Card

Read this owner's manual thoroughly before operating this LCD TV/DVD Combination.

Complete and mail the enclosed product registration card or register your LCD TV/DVD Combination on-line at <http://www.tacp.toshiba.com/service> as soon as possible. By registering your LCD TV/DVD Combination you will enable TACP to bring you new products specifically designed to meet your needs and help us to contact you in the unlikely event a safety notification is required under the U.S. Consumer Product Safety Act. Failure to complete and return the product registration card does not diminish your warranty rights.

Your Responsibility

THE ABOVE WARRANTIES ARE SUBJECT TO THE FOLLOWING CONDITIONS:

- (1) You must retain your bill of sale or provide other proof of purchase.
- (2) All warranty servicing of this LCD TV/DVD Combination must be made by the Depot Warranty Repair Center specified by the TACP Consumer Solutions Center.
- (3) The warranties from TACP are effective only if the LCD TV/ DVD Combination is purchased and operated in the Continental U.S.A. or Puerto Rico.
- (4) Labor service charges for set installation, setup, adjustment of customer controls, and installation or repair of antenna systems are not covered by this warranty. Reception problems caused by inadequate antenna systems, misaligned satellite dishes, cable television distribution, VCRs, DVD players/recorders,

personal computer level IEEE-1394 devices, and any other connected signal source device are your responsibility.

- (5) Warranties extend only to defects in materials or workmanship as limited above, and do not extend to any LCD TV/DVD Combination or parts that have been lost or discarded by you or to damage to the LCD TV/DVD Combination or parts caused by fires, misuse, accident, Acts of God (such as lightning or fluctuations in electric power), improper installation, improper maintenance, or use in violation of instructions furnished by TACP; use or malfunction through simultaneous use of this LCD TV/DVD Combination and connected equipment; or to units that have been modified or had the serial number removed, altered, defaced, or rendered illegible.

How to Obtain Warranty Services

If, after following all of the operating instructions in this manual and checking the section "Troubleshooting," you find that service is needed:

- (1) For instructions on how to obtain warranty service for your LCD Television, contact TACP's Consumer Solution Center toll free at 1-800-631-3811.
- (2) You must include a copy or original bill of sale or other proof of purchase along with the entire LCD TV/DVD Combination to the Depot Warranty Repair Center specified by the TACP Consumer Solutions Center. You are responsible for all inbound transportation and insurance charges for the LCD TV/DVD Combination to the Depot Warranty Repair Center specified by the TACP Consumer Solutions Center.

For additional information, visit TACP's website:

www.tacp.toshiba.com

ALL WARRANTIES IMPLIED BY THE LAW OF ANY STATE OF THE U.S.A., INCLUDING THE IMPLIED WARRANTIES OF MERCHANTABILITY AND FITNESS FOR A PARTICULAR PURPOSE, ARE EXPRESSLY LIMITED TO THE DURATION OF THE LIMITED WARRANTIES SET FORTH ABOVE. WITH THE EXCEPTION OF ANY WARRANTIES IMPLIED BY THE LAW OF ANY STATE OF THE U.S.A. AS HEREBY LIMITED, THE FOREGOING WARRANTY IS EXCLUSIVE AND IN LIEU OF ALL OTHER WARRANTIES, GUARANTEES, AGREEMENTS, AND SIMILAR OBLIGATIONS OF TACP WITH RESPECT TO THE REPAIR OR REPLACEMENT OF ANY PARTS. IN NO EVENT SHALL TACP BE LIABLE FOR CONSEQUENTIAL OR INCIDENTAL DAMAGES (INCLUDING, BUT NOT LIMITED TO, LOST PROFITS, BUSINESS INTERRUPTION, OR MODIFICATION OR ERASURE OF RECORDED DATA CAUSED BY USE, MISUSE OR INABILITY TO USE THIS LCD TV/DVD COMBINATION).

No person, agent, distributor, dealer, or company is authorized to change, modify, or extend the terms of these warranties in any manner whatsoever. The time within which an action must be commenced to enforce any obligation of TACP arising under the warranty or under any statute or law of the United States or any state thereof is hereby limited to ninety (90) days from the date you discover, or should have discovered, the defect. This limitation does not apply to implied warranties arising under state law.

THIS WARRANTY GIVES YOU SPECIFIC LEGAL RIGHTS AND YOU MAY ALSO HAVE OTHER RIGHTS WHICH MAY VARY FROM STATE TO STATE IN THE U.S.A. SOME STATES OF THE U.S.A. DO NOT ALLOW LIMITATIONS ON HOW LONG AN IMPLIED WARRANTY LASTS, WHEN AN ACTION MAY BE BROUGHT, OR THE EXCLUSION OR LIMITATION OF INCIDENTAL OR CONSEQUENTIAL DAMAGES, SO THE ABOVE PROVISIONS MAY NOT APPLY TO YOU UNDER SUCH CIRCUMSTANCES.

Introduction

Connecting
Your TV/DVD

Setting up
Your TV/DVD

Using the
TV/DVD's Features

DVD Playback

Appendix

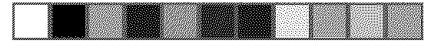
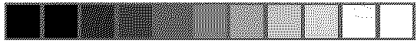

TOSHIBA AMERICA CONSUMER PRODUCTS, L.L.C.

Corporate Headquarters

82 Totowa Road, Wayne, NJ 07470

National Service Division

1420B Toshiba Drive, Lebanon, TN 37087

CableClear, ColorStream, TheaterWide and StableSound are registered trademarks of Toshiba America Consumer Products, L.L.C.

LC D VD[™] and GameTimer are trademarks of Toshiba America Consumer Products, L.L.C.

TOSHIBA



Printed in Thailand