

Electric Range

Use & Care Guide

Estufa eléctrica

Guía para el Uso y Cuidado

Models, Modelos **790.9654***, **9661***

* = color number, número de color

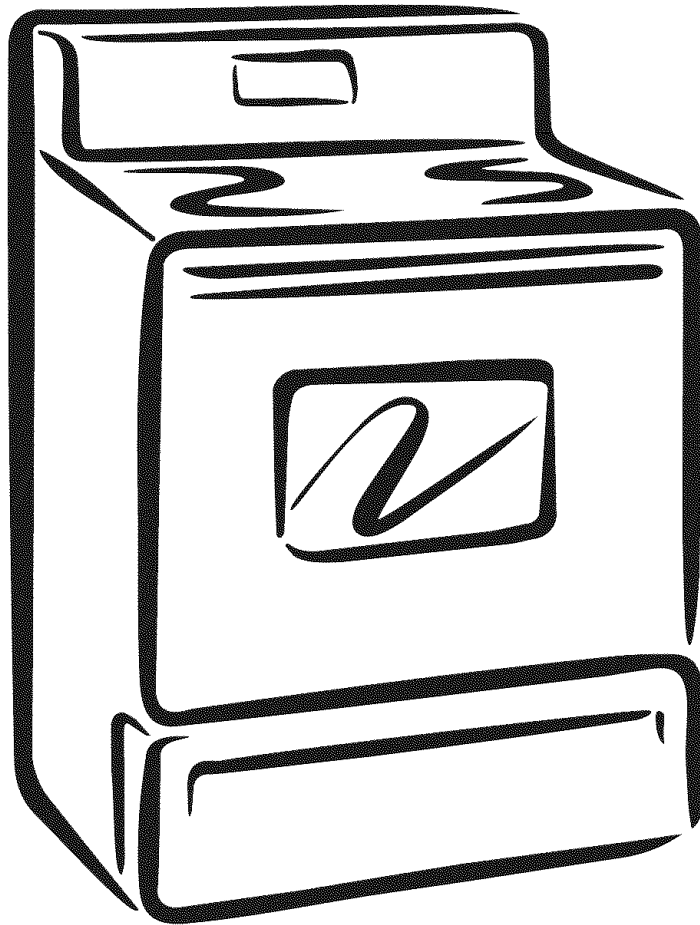

ENGLISH

ESPAÑOL

Table of Contents

Free-Standing Range Warranty	2
Product Record	2
IMPORTANT SAFETY INSTRUCTIONS	3-4
Protection Agreements	5
Range Features	6
Before Setting Oven Controls	7-8
Setting Surface Controls	9-10
Surface Cooking	11
Oven Control Functions	12
Setting Oven Controls	13-28
Setting Warmer Drawer Controls	29-30
Self Cleaning	31-33
Adjusting Your Oven Temperature	34
General Care & Cleaning	35-38
Before You Make a Service Call	39
Slow Cook Recipes	40
Sears Service	Back Page

Product Record

In the space below record the date of purchase, model and serial number of your product. You will find the model and serial number printed on an identification plate. This serial plate is located on the right side of the oven front frame in the storage or warmer drawer compartment. **See bottom of this page** for the serial plate location.

Model No. 790.

Serial No. _____

Date of Purchase _____

Save these instructions and your sales receipt for future reference.

Kenmore Appliance Warranty

One Year Limited Warranty

When installed, operated and maintained according to all instructions supplied with the product, if this appliance fails due to a defect in material or workmanship within one year from the date of purchase, call **1-800-4-MY-HOME®** to arrange for free repair. If this appliance is used for other than private family purposes, this warranty applies for only 90 days from the date of purchase.

This warranty covers only defects in material and workmanship. Sears will NOT pay for:

1. Expendable items that can wear out from normal use, including but not limited to filters, belts, light bulbs, and bags.
2. A service technician to instruct the user in correct product installation, operation or maintenance.
3. A service technician to clean or maintain this product.
4. Damage to or failure of this product if it is not installed, operated or maintained according to all instructions supplied with the product.
5. Damage to or failure of this product resulting from accident, abuse, misuse or use for other than its intended purpose.
6. Damage to or failure of this product caused by the use of detergents, cleaners, chemicals or utensils other than those recommended in all instructions supplied with the product.
7. Damage to or failure of parts or systems resulting from unauthorized modifications made to this product.

Disclaimer of implied warranties; limitation of remedies

Customer's sole and exclusive remedy under this limited warranty shall be product repair as provided herein. Implied warranties, including warranties of merchantability or fitness for a particular purpose, are limited to one year or the shortest period allowed by law. Sears shall not be liable for incidental or consequential damages. Some states and provinces do not allow the exclusion or limitation of incidental or consequential damages, or limitations on the duration of implied warranties of merchantability or fitness, so these exclusions or limitation may not apply to you.

This warranty applies only while this appliance is used in the United States and Canada.

This warranty gives you specific legal rights, and you may also have other rights which vary from state to state.

Sears, Roebuck and Co., Dept. 817WA, Hoffman Estates, IL 60179
Sears Canada Inc., Toronto, Ontario, Canada M5B 2B8

Serial Plate Location

You will find the model and serial number printed on the serial plate. The serial plate is located on the right side of the oven front frame in the storage or warmer drawer compartment.

Remember to record the serial number for future reference (See top of page under Product Record).

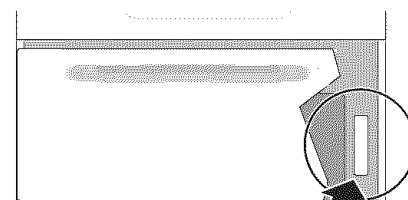

Serial plate location; Open the Warmer Drawer (some models) or storage drawer (some models).

Important Safety Instructions

Read all instructions before using this appliance. Save these instructions for future reference.

This manual contains important safety symbols and instructions. Please pay attention to these symbols and follow all instructions given.

⚠ WARNING This symbol will help alert you to situations that may cause serious bodily harm, death or property damage.

⚠ CAUTION This symbol will help alert you to situations that may cause bodily injury or property damage.

• **Remove all tape and packaging before using the range.** Destroy the carton and plastic bags after unpacking the range. Never allow children to play with packaging material.

• **Proper Installation—Be sure your appliance is properly installed and grounded by a qualified technician in accordance with the National Electrical Code ANSI/NFPA No. 70 latest edition and local electrical code requirements.** Install only per installation instructions provided in the literature package for this range.

Ask your dealer to recommend a qualified technician and an authorized repair service. Know how to disconnect the power to the range at the circuit breaker or fuse box in case of an emergency.

• **User servicing—Do not repair or replace any part of the appliance unless specifically recommended in the manuals.** All other servicing should be done only by a qualified technician. This may reduce the risk of personal injury and damage to the range.

• **Never modify or alter the construction of a range by removing leveling legs, panels, wire covers, anti-tip brackets/screws, or any other part of the product.**

⚠ WARNING Do not use the oven or warmer drawer (if equipped) for storage.

⚠ WARNING Never Use Your Appliance for Warming or Heating the Room.

• **Storage in or on Appliance—Flammable materials should not be stored in an oven, warmer drawer, near surface units or in the storage drawer.** This includes paper, plastic and cloth items, such as cookbooks, plasticware and towels, as well as flammable liquids. Do not store explosives, such as aerosol cans, on or near the range.

• **Do Not Leave Children Alone—Children should not be left alone or unattended in the area where appliance is in use.** They should never be allowed to sit or stand on any part of the appliance.

• **DO NOT TOUCH SURFACE UNITS, AREAS NEAR THESE UNITS, HEATING ELEMENTS OR INTERIOR SURFACES OF THE OVEN.** Both surface units and oven heating elements may be hot even though they are dark in color. Areas near surface units may become hot enough to cause burns. During and after use, do not touch, or let clothing or other flammable materials touch these areas until they have had sufficient time to cool. Among these areas are the cook top, surfaces facing the cook top, the oven vent openings and surfaces near these openings, oven door and window.

• **Wear Proper Apparel—Loose-fitting or hanging garments should never be worn while using the appliance.** Do not let clothing or other flammable materials contact hot surfaces.

• **Do Not Use Water or Flour on Grease Fires—Smother the fire with a pan lid, or use baking soda, a dry chemical or foam-type extinguisher.**

• **When heating fat or grease, watch it closely.** Fat or grease may catch fire if allowed to become too hot.

• **Use Only Dry Potholders - Moist or damp potholders on hot surfaces may result in burns from steam.** Do not let potholders touch hot heating elements. Do not use a towel or other bulky cloth instead of a potholder.

• **Do Not Heat Unopened Food Containers - Buildup of pressure may cause container to burst and result in injury.**

• **Remove the oven door from any unused range if it is to be stored or discarded.**

IMPORTANT—Do not attempt to operate the range during a power failure. If the power fails, always turn off the range. If the range is not turned off and the power resumes, the range will begin to operate again. Once the power resumes, reset the clock and oven function.

⚠ WARNING

- All ranges can tip.
- Injury to persons could result.
- Install anti-tip device packed with range.
- See Installation Instructions.



⚠ WARNING To reduce the risk of tipping, the range must be secured by properly installed anti-tip bracket provided with the range. To check if the bracket is installed properly, visually check that rear leveling leg is inserted into and fully secured by the anti-tip bracket by removing lower panel or storage drawer. For models with a warmer drawer, grasp the top rear edge of the range and carefully attempt to tilt it forward. Refer to the installation instructions for proper anti-tip bracket installation.



⚠ WARNING Stepping, leaning or sitting on the doors or drawers of this range can result in serious injuries and also cause damage to the range. Do not allow children to climb or play around the range. The weight of a child on an open door may cause the range to tip, resulting in serious burns or other injury.

⚠ CAUTION Do not store items of interest to children in the cabinets above a range or on the backguard of a range. Children climbing on the range to reach items could be seriously injured.

Important Safety Instructions

IMPORTANT INSTRUCTIONS FOR USING YOUR COOKTOP

- **Know which knob controls each surface heating unit.** Place a pan of food on the unit before turning it on, and turn the unit off before removing the pan.
- **Use Proper Pan Size**—This appliance is equipped with one or more surface units of different sizes. Select utensils having flat bottoms large enough to cover the surface unit heating element. The use of undersized utensils will expose a portion of the heating element to direct contact and may result in ignition of clothing. Proper relationship of utensil to element will also improve efficiency.
- **Utensil Handles Should Be Turned Inward and Not Extend Over Adjacent Surface Elements**—To reduce the risk of burns, ignition of flammable materials, and spillage due to unintentional contact with the utensil, the handle of the utensil should be positioned so that it is turned inward, and does not extend over adjacent surface units.
- **Never Leave Surface Elements Unattended at High Heat Settings**—Boilovers cause smoking and greasy spillovers that may ignite, or a pan that has boiled dry may melt.
- **Do Not Immerse or Soak Removable Heating Elements**—Heating elements should never be immersed in water. Heating elements clean themselves during normal operation.
- **Glazed Cooking Utensils**—Only certain types of glass, glass/ceramic, ceramic, earthenware, or other glazed utensils are suitable for cook top service without breaking due to the sudden change in temperature. Check the manufacturer's recommendations for cook top use.
- **When flaming foods under a ventilating hood, turn the fan on.**

SELF CLEANING OVENS

- **Clean in the self-cleaning cycle only the parts listed in this Use & Care Manual.** Before self cleaning the oven, remove the broiler pan and any utensils or foods from the oven.
- **Do Not Use Oven Cleaners**—No commercial oven cleaner or oven liner protective coating of any kind should be used in or around any part of the oven.
- **Do Not Clean Door Gasket**—The door gasket is essential for a good seal. Care should be taken not to rub, damage or move the gasket.
- The health of some birds is extremely sensitive to the fumes given off during the self-cleaning cycle of any range. Move birds to another well-ventilated room.

IMPORTANT INSTRUCTIONS FOR CLEANING YOUR RANGE

- **Clean the range regularly to keep all parts free of grease that could catch fire.** Pay particular attention to the area underneath each surface element. Do not allow grease to accumulate.
- **Kitchen cleaners and aerosols**—Always follow the manufacturer's recommended directions for use. Be aware that excess residue from cleaners and aerosols may ignite causing damage and injury.
- **Clean Ventilating Hoods Frequently**—Grease should not be allowed to accumulate on the hood or filter. Follow manufacturer's instructions for cleaning.

FOR CERAMIC-GLASS COOK TOP MODELS

- **Do Not Cook on Broken Cook Top**—If cook top should break, cleaning solutions and spillovers may penetrate the broken cook top and create a risk of electric shock. Contact a qualified technician immediately.
- **Clean Cook Top with Caution**—If a wet sponge or cloth is used to wipe spills on a hot cooking area, be careful to avoid a steam burn. Some cleaners can produce noxious fumes if applied to a hot surface.

Important Safety Notice

The California Safe Drinking Water and Toxic Enforcement Act requires the Governor of California to publish a list of substances known to the state to cause cancer, birth defects or other reproductive harm, and requires businesses to warn customers of potential exposure to such substances.

PROTECTION AGREEMENTS

In the U.S.A.

Master Protection Agreements

Congratulations on making a smart purchase. Your new Kenmore® product is designed and manufactured for years of dependable operation. But like all products, it may require preventive maintenance or repair from time to time. That's when having a Master Protection Agreement can save you money and aggravation.

Purchase a Master Protection Agreement now and protect yourself from unexpected hassle and expense.

The Master Protection Agreement also helps extend the life of your new product. Here's what's included in the Agreement:

- ✓ **Expert service** by our 12,000 professional repair specialists.
- ✓ **Unlimited service and no charge** for parts and labor on all covered repairs.
- ✓ **"No-lemon" guarantee** – replacement of your covered product if four or more product failures occur within twelve months.
- ✓ **Product replacement** if your covered product can't be fixed.
- ✓ **Annual Preventive Maintenance Check** at your request – no extra charge.
- ✓ **Fast help by phone** – phone support from a Sears technician on products requiring in-home repair, plus convenient repair scheduling.
- ✓ **Power surge protection** against electrical damage due to power fluctuations.
- ✓ **Rental reimbursement** if repair of your covered product takes longer than promised.

Once you purchase the Agreement, a simple phone call is all that it takes for you to schedule service. You can call anytime day or night, or schedule a service appointment online.

Sears has over 12,000 professional repair specialists, who have access to over 4.5 million quality parts and accessories. That's the kind of professionalism you can count on to help prolong the life of your new purchase for years to come. Purchase your Master Protection Agreement today!

Some limitations and exclusions apply.
For prices and additional information call 1-800-827-6655.

Sears Installation Service

For Sears professional installation of home appliances, garage door openers, water heaters, and other major home items, in the U.S.A. call **1-800-4-MY-HOME®**.

ACUERDOS DE PROTECCIÓN

En los EE.UU.

Acuerdos maestros de protección

Lo felicitamos por haber hecho una compra inteligente. Su nuevo producto Kenmore® fue diseñado y fabricado para ofrecer muchos años de servicio confiable. Sin embargo, como todo producto, el mismo podría requerir mantenimiento preventivo o reparaciones ocasionales. Es por eso que el tener un Acuerdo maestro de protección podría ahorrarle dinero y molestias.

Adquiera ya un Acuerdo maestro de protección y protéjase de gastos y frustraciones inesperados.

El Acuerdo maestro de protección también ayuda a extender la vida de su producto nuevo. El Acuerdo incluye lo siguiente:

- ✓ **Servicio profesional** por nuestros 12.000 profesionales especialistas en reparación.
- ✓ **Servicio ilimitado sin cargos adicionales** por piezas y servicio en todas las reparaciones cubiertas.
- ✓ **Garantía de "no-limón"** – reemplaza su producto cubierto si ocurren cuatro o más desperfectos en los primeros doce meses.
- ✓ **Reemplazo del producto** si el mismo no puede ser reparado.
- ✓ **Verificación de mantenimiento preventivo anual** a su petición y sin cargos adicionales.
- ✓ **Pronta ayuda por teléfono** – apoyo por teléfono por un técnico de Sears en los productos que requieran reparación en casa, además de la conveniencia de hacer una cita para la reparación.
- ✓ **Protección contra picos de energía** o daños eléctricos causados por fluctuaciones de la corriente eléctrica.
- ✓ **Reembolso del alquiler** si la reparación de su producto cubierto toma más del tiempo prometido.

Una vez que adquiera este Acuerdo, una simple llamada telefónica es todo lo que necesita para hacer una cita de servicio. Usted puede llamar a cualquier hora del día o de la noche para programar una cita de servicio por Internet.

Sears cuenta con más de 12.000 profesionales especialistas de reparación con acceso a más de 4,5 millones de piezas y accesorios de calidad. Esa es la clase de profesionalismo con la que puede contar para extender la vida útil de su nueva adquisición por muchos años. ¡Adquiera su Acuerdo maestro de protección hoy!

Algunas limitaciones y exclusiones podrían aplicarse.
Para precios e información adicional, llame al 1-800-827-6655.

Servicio de instalación Sears

Para una instalación profesional de Sears en electrodomésticos, abridores de puertas de garaje, calentadores de agua y otros artículos mayores del hogar, llame al **1-888-SU-HOGAR®**.

Range Features

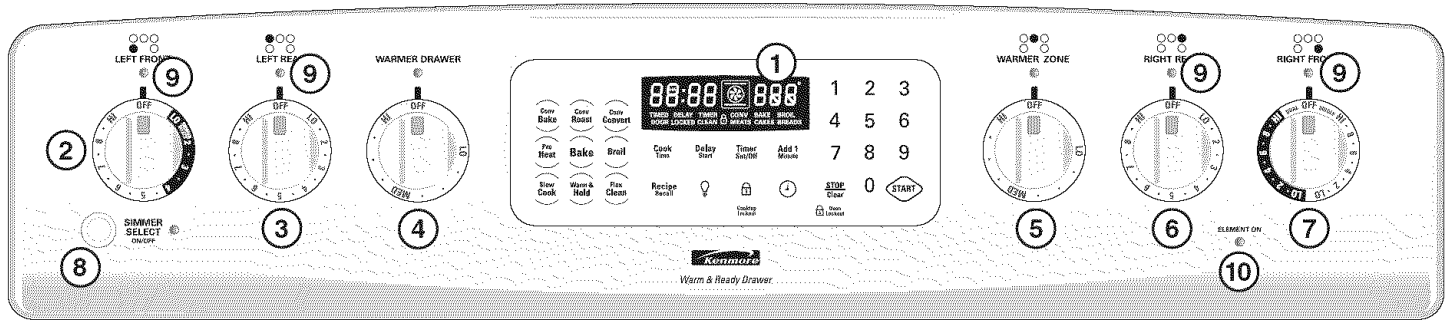

Your Electric Range Features Include:

1. Electronic Oven Control with Kitchen Timer.
2. Simmer Select Element Control (some models) or Single Radiant Element Control (some models) or Single Radiant Power Boil Control (some models).
3. Single Radiant Element Control.
4. Warm & Ready Drawer Control & Indicator Light (some models).
5. Warm & Ready Zone & Surface Indicator Light (some models).
6. Single Radiant Element Control.
7. Single Radiant Element Control (some models) or Dual Element Radiant Control (some models).
8. Simmer Select Push Button & Indicator Light (some models).
9. HOT SURFACE Indicator Lights.
10. "ELEMENT ON" Indicator Light.
11. Oven Interior Light with removable Cover.
12. Automatic Oven Door Light Switch (some models).
13. Self-Cleaning Oven interior.
14. Self-Clean Door Latch.
15. Adjustable Oven Rack(s).
16. Convection Fan & Cover.
17. Large 1 piece Oven Door Handle.
18. Full width Oven Door with Window.
19. Warm & Ready Drawer (some models) or Storage Drawer with Drawer Handle.
20. Easy to clean upswept Cooktop.
21. Ceramic Smoothtop.
22. 6" Single Radiant Element(s).
23. 9" Single Radiant Element (some models).
24. 9" Single Radiant "Power Element" (some models).
25. 6-9" Dual Radiant Element (some models).
26. 9-12" Dual Radiant Element (some models).
27. Warm & Ready Zone Radiant Element (some models).
28. Broil Pan (some models).
29. Broil Pan Insert (some models).
30. Roasting Rack.
31. Leveling Legs and Anti-tip Bracket (included).

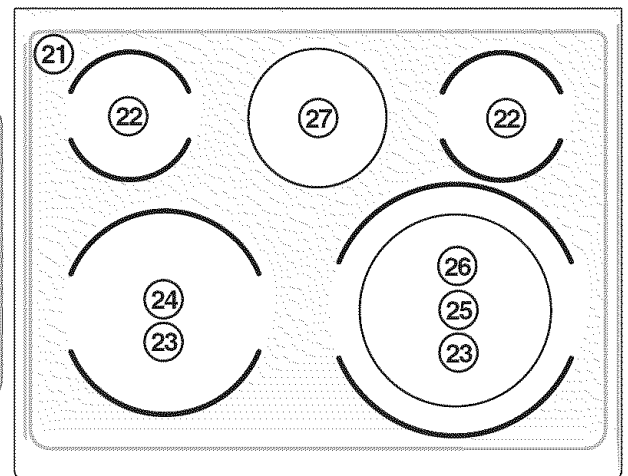
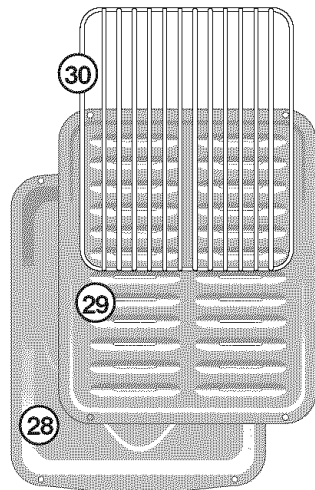
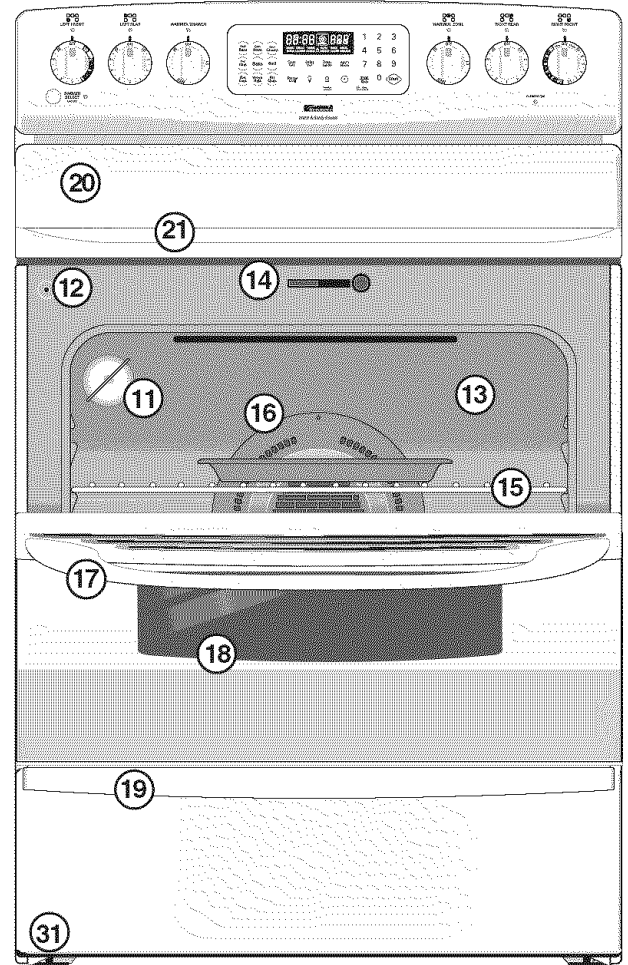

NOTE: The features of your range may vary according to model type & color.

Before Setting Oven Controls

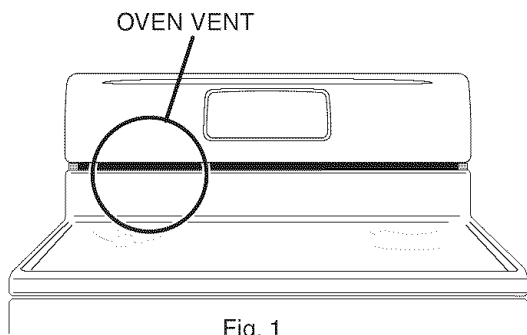

Oven Vent Location

The oven vent is located **under the left side of the control panel** (See Fig. 1). When the oven is on, warm air passes through the vent. This venting is necessary for proper air circulation in the oven and good baking results. **DO NOT BLOCK OVEN VENT.**

Removing & Replacing Oven Racks

To remove, pull the rack forward until it stops. Lift up front of rack and slide out. **To replace**, fit the rack onto the guides on the oven walls. Tilt the front of the rack upward and slide the rack back into place.

Arranging Oven Racks

ALWAYS ARRANGE OVEN RACKS WHEN THE OVEN IS COOL (PRIOR TO OPERATING THE OVEN). Refer to Fig. 2. Always use oven mitts when using the oven.

Recommended Rack Positions for Broiling, Baking & Roasting:

Food	Rack Position
Broiling hamburgers & steaks	See Broil
Broiling meats, chicken or fish	See Broil
Cookies, cakes, pies, biscuits & Muffins	3 or 4
Frozen pies, angel food cake, yeast, bread, casseroles, small cuts of meat or poultry	1 or 2
Turkey, roast or ham	1 or Roasting Shelf

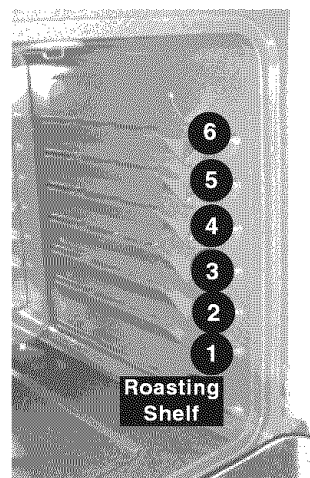
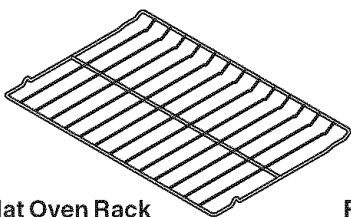
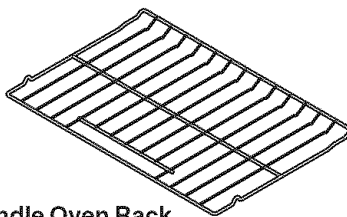

Fig. 2

Types of Oven Racks



Flat Oven Rack
Fig. 3



Flat Handle Oven Rack
Fig. 4

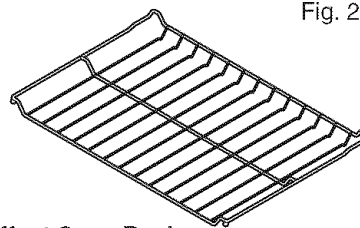

Offset Oven Rack
(some models)
Fig. 5

CAUTION Always use pot holders or oven mitts when adjusting the oven racks. Wait until the oven has completely cooled if possible. Oven racks may be HOT and may cause burns.

Your range may be equipped with one or more of the oven rack types shown; **Flat Rack** (Fig. 3), **Flat Handle Rack** (Fig. 4) and the **Offset Rack** (Fig. 5).

Baking Layer Cakes with 1 or 2 Oven Racks

For best results when baking cakes using 2 oven racks, place cookware on rack positions 2 (Flat Oven Rack or Flat Handle Oven Rack) & 5 with the Offset Oven Rack (some models; See Fig. 6). For best results when using a single oven rack, place cookware on rack positions 3 or 4 (See Fig. 7).

Air Circulation in the Oven

For best air circulation and baking results allow 2-4" (5-10 cm) around the cookware for proper air circulation and be sure pans and cookware do not touch each other, the oven door, sides or back of the oven cavity. The hot air must be able to circulate around the pans and cookware in the oven for even heat to reach around the food.

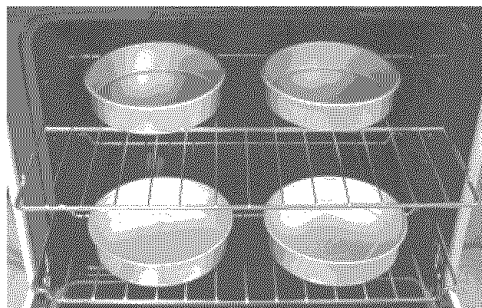

Fig. 6

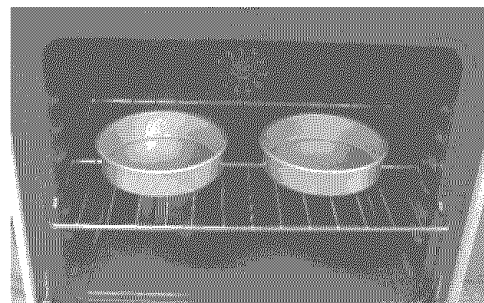

Fig. 7

Before Setting Oven Controls (cont'd)

About the Ceramic Glass Cooktop

The ceramic cooktop has radiant surface elements located below the surface of the glass. The design of the ceramic cooktop outlines the area of the surface element underneath. **Be sure** to match the pan size with the diameter of the element outline on the cooktop. Heat is transferred up through the surface of the cooktop to the cookware. Only flat-bottomed cookware should be used.

The type and size of cookware, the number of surface elements in use and their settings, are all factors that will affect the amount of heat that will spread to areas beyond the surface elements. The areas surrounding the elements may become **hot enough to cause burns**.

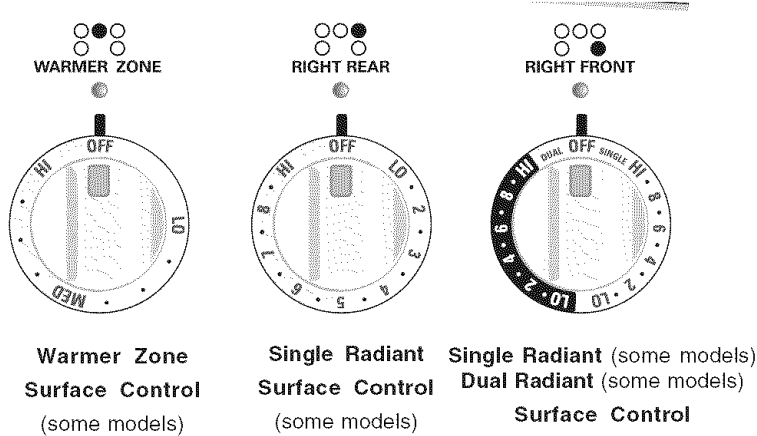

About the Radiant Surface Elements

The element temperature rises gradually and evenly. As the temperature rises, the element will glow red. To maintain the selected setting, the element will cycle on and off. The heating element retains enough heat to provide a uniform and consistent heat during the off cycle.

For efficient cooking, turn off the element several minutes before cooking is complete. This will allow residual heat to complete the cooking process.

NOTE: Please read detailed instructions for ceramic glass cooktop cleaning in the **General Care & Cleaning** and **Before You Call** checklist sections of this Use & Care Guide.

NOTE: Radiant elements have a limiter that allows the element to cycle ON and OFF, even at the HI setting. This helps to prevent damage to the ceramic smooth top. Cycling at the HI setting is normal and will occur more often if the cookware is too small for the radiant element or if the cookware bottom is not flat.

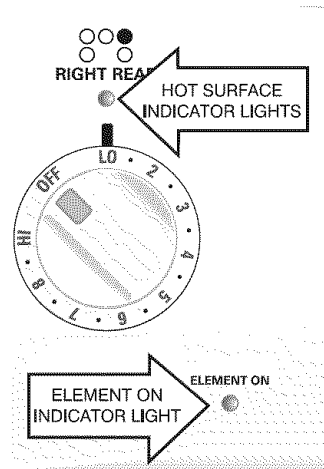

ELEMENT ON and Hot Surface Indicator Lights

Your range is equipped with two different types of radiant surface control indicator lights that will glow on your range—the **ELEMENT ON** indicator light and the **Hot Surface** indicator lights (See illustration at left). The **ELEMENT ON** located on the control panel and will glow when a surface element is turned ON. A quick glance at this indicator light after cooking is an easy check to be sure ALL surface controls are turned OFF.

The **Hot Surface** indicator lights **located above each surface radiant control knob** will glow as the surface cooking area heats up and will **REMAIN ON** until the glass cooktop has cooled to a **MODERATE** level.

CAUTION Radiant surface elements may appear to have cooled after they have been turned off. **The glass surface may still be hot** and burns may occur if the glass surface is touched before it has cooled sufficiently.

CAUTION Do not place plastic items such as salt and pepper shakers, spoon holders or plastic wrappings on top of the range when it is in use. These items could melt or ignite. Potholders, towels or wooden spoons could catch fire if placed too close to the surface elements.

CAUTION Do not allow aluminum foil, empty glass/porcelain cookware or ANY material that can melt to make contact with the ceramic cooktop. If these items melt on the cooktop they WILL damage the ceramic cooktop.

Setting Surface Controls

Single Radiant Surface Elements (all models)

To Operate a Single Radiant Element:

1. Place correctly sized cookware on the radiant surface element.
2. Push in and turn the surface control knob in either direction to the desired setting (See Fig. 1). Start most cooking operations on a higher setting and then turn to a lower setting to finish cooking. The surface control knobs do not have to be set exactly on a particular mark. Use the marks as a guide and adjust the control knob as needed. Each surface element provides a constant amount of heat at each setting. A glowing red surface heating area extending beyond the bottom edge of the cookware indicates the cookware is **too small** for the surface heating area.
3. When cooking is complete, turn the surface element OFF before removing the cookware.
 Note: The **ELEMENT ON** indicator light will glow when one or more elements are turned ON. A quick glance at this indicator light when cooking is finished is an easy check to be sure all control knobs are turned OFF. The **Hot Surface** indicator light will continue to glow AFTER the control knob is turned to the "OFF" position and will glow until the heating surface area has cooled sufficiently.

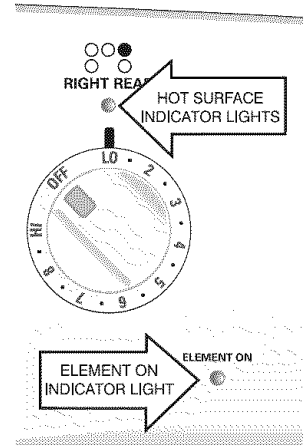

Fig. 1

Simmer Select Surface Element (some models)

The left front element control may be used as a normal element or as a simmer element. The "Simmer Select" feature heats the element at a much lower temperature than when used as a normal surface element. You may switch between normal cooking and the Simmer Select feature at any time during the cooking process. When using the element control for normal cooking all of the settings on the control knob (LO to HI) function as normal.

To Start Simmer Select:

1. Place correctly sized cookware on the radiant surface element.
2. Push in the Simmer button located below the left front control knob.
3. Turn the surface control knob to the desired simmer setting within the dark band on the control knob (LO to 4). Use the marks as a guide and adjust the control knob from LO to 4 as needed (see illustration below). The Simmer Select indicator light will glow and remain ON while simmering (See Fig. 2).
4. To return to normal cooking, push in and release the "Simmer Select" button and the indicator light will turn OFF. When cooking is complete, be sure to set the control knob to the OFF position.

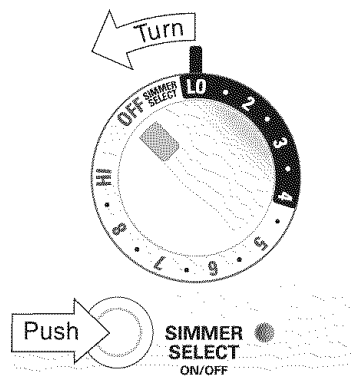

Simmer Select Surface Control shown in LO setting

Fig. 2

The suggested settings found in the table below are based on cooking in medium-weight aluminum pans with lids. Settings may vary when using other types of pans.

STANDARD SETTING FOR SURFACE ELEMENTS	
Setting	Type of Cooking
HIGH (HI - 9)	Start most foods, bring water to a boil, pan broiling
MEDIUM HIGH (7 - 8)	Continue a rapid boil, fry, deep fat fry
MEDIUM (5 - 6)	Maintain a slow boil, thicken sauces and gravies, steam vegetables
MEDIUM LOW (2 - 4)	Keep foods cooking, poach, stew
LOW (LO - 1)	Keep warm, melt, simmer
SIMMER SELECT SURFACE ELEMENT	
Max. Simmer (4)	Larger quantities of food, stews and soups
Min. Simmer (LO)	Smaller quantities of food, delicate foods, melting chocolate or butter

CAUTION Radiant surface elements may appear to have cooled after they have been turned off. **The glass surface may still be hot** and burns may occur if the glass surface is touched before it has cooled sufficiently.

CAUTION Do not place plastic items such as salt and pepper shakers, spoon holders or plastic wrappings on top of the range when it is in use. These items could melt or ignite. Potholders, towels or wooden spoons could catch fire if placed too close to the surface elements.

CAUTION Do not allow aluminum foil, empty glass/porcelain cookware or ANY material that can melt to make contact with the ceramic cooktop. If these items melt on the cooktop they WILL damage the ceramic cooktop.

Setting Surface Controls (cont'd)

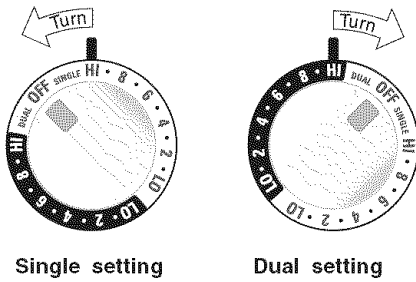

To Operate Dual Radiant Surface Element (some models)

The right front control knob offers flexibility for different sized cookware with the Dual Radiant surface element. The inner element alone can be used for smaller or both the inner and outer in combination for larger cookware.

To operate the Dual Radiant surface element push in the control knob and turn counterclockwise to operate the small inner coil or turn clockwise to operate both the inner and outer portions of the element together (See Fig 1).

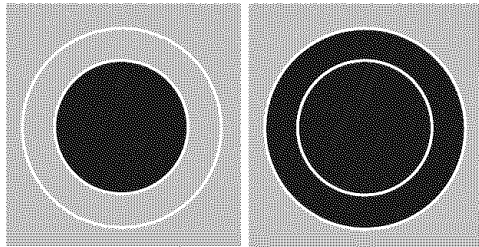

Dual Radiant heating areas
on ceramic smooth top (shown in black)
Fig. 1

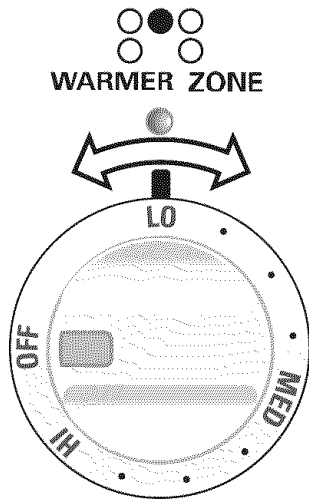

Fig. 2

Warmer Zone Recommended Food Settings Table	
Food Item	Heating Level
Breads/Pastries	LO
Casseroles	LO
Dinner Plates with Food	LO
Eggs	LO
Gravies	LO
Meats	MED
Sauces	MED
Soups (cream)	MED
Stews	MED
Vegetables	MED
Fried Foods	HI
Hot Beverages	HI
Soups (liquid)	HI

SINGLE AND DUAL RADIANT SURFACE ELEMENTS

Setting	Type of Cooking
HIGH (HI - 9)	Start most foods, bring water to a boil, pan broiling
MEDIUMHIGH (7 - 8)	Continue a rapid boil, fry, deep fat fry
MEDIUM (5 - 6)	Maintain a slow boil, thicken sauces and gravies or steam vegetables
MEDIUMLOW (2 - 4)	Keep foods cooking, poach, stew
LOW (LO - 1)	Keep warm, melt, simmer

Note: The size and type of utensil used, and the amount and type of food being cooked will influence the setting needed for best cooking results.

Setting the Warmer (Warm & Ready™) Zone (some models)

The purpose of the Warmer Zone is to *keep hot cooked foods at serving temperature*. Always start with hot food. It is not recommended to heat cold food on the Warmer Zone.

All food placed on the Warmer Zone should be covered with a lid or aluminum foil to maintain quality. For best results, when warming pastries or breads, the cover should have an opening to allow moisture to escape. **Do not use plastic wrap to cover food. Plastic may melt onto the surface and be very difficult to clean.**

Use only dishware, utensils and cookware recommended for oven and cooktop use on the Warmer Zone.

CAUTION Unlike the surface elements, the Warmer Zone will not glow red when it is hot.

CAUTION Always use potholders or oven mitts when removing food from the warm zone as cookware and plates will be hot.

Setting the Warmer (Warm & Ready™) Zone Control

- To set the control, push in either direction and turn the knob (See Fig 2). The temperatures are approximate, and are designated by HI, MED and LO. However, the control can be set at any position between HI and LO for different levels of heating.
- When ready to serve, turn the control to OFF. The Warmer Zone will remain warm until the **indicator light** goes OFF.

Temperature Selection - Refer to the chart at the side column for recommended heating levels. If a particular food is not listed, start with the medium level, and adjust as needed. Most foods can be kept at serving temperatures by using the medium level.

Note: Use the Warmer Zone to keep cooked foods hot such as; vegetables, gravies, casseroles, soups, stews, breads, pastries and oven-safe dinner plates.

Surface Cooking

To Set the Cooktop Lockout Feature

The  pad is used to activate the Cooktop Lockout feature which will lock all surface elements from being accidentally turned ON. This feature will only lock the cooktop.

To turn the Cooktop Lockout Feature ON:

1. BE SURE ALL surface element controls are set to the OFF position.
2. Press and hold  until one beep is heard (after 3 seconds; See Fig. 1). If a triple beep sounds instead, check all surface elements and turn them to the OFF position and repeat this step. The Cooktop Locked indicator light will turn ON and the cooktop controls and functions are locked out until the cooktop is unlocked.



Fig. 1

To turn the Cooktop Lockout Feature OFF:

1. BE SURE ALL surface element controls are set to the OFF position.
2. Press and hold  until one beep is heard (after 3 seconds). If a triple beep sounds instead, check all surface elements and turn them to the OFF position and repeat this step. The Cooktop Locked indicator light will turn OFF and the cooktop may be used normally (See Fig. 2). **Note:** Starting a Self-Clean cycle will also turn ON the Cooktop Lockout feature. The cooktop will remain locked until the Self-Clean cycle has completed and the oven door has unlocked. If a power failure occurs after the Cooktop Lockout has been activated, you must turn OFF the Cooktop Lockout feature before being able to use the cooktop features again.



Fig. 2

Using Power Element (some models)

The “Power Element” feature uses a higher wattage surface radiant element which can bring food items to boil much quicker. The left front radiant element will be clearly marked if this feature is available on your range (See Fig. 3). If equipped with the “Power Element” feature, place the cookware on the left front surface element and follow the instructions “To Operate a Single Radiant Element” in the **Settings Surface Controls** section.

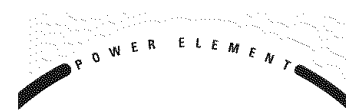

Fig. 3

Using proper cookware

The size and type of cookware used will influence the setting needed for best cooking results. Cookware should have flat bottoms that make good contact with the entire surface heating element (See Figs. 4). Check for flatness by rotating a ruler across the bottom of the cookware (See Fig.5).

Cookware Material Types

The cookware material determines how evenly and quickly heat is transferred from the surface element to the pan bottom. The most popular materials available are:

ALUMINUM - Excellent heat conductor. Some types of food will cause it to darken (Anodized aluminum cookware resists staining & pitting). If aluminum pans slide across the ceramic cooktop, they may leave metal marks which will resemble scratches. Remove these marks immediately.

COPPER - Excellent heat conductor but discolors easily. May leave metal marks on ceramic glass (see Aluminum above).

STAINLESS STEEL - Slow heat conductor with uneven cooking results. Is durable, easy to clean and resists staining.

CAST IRON - A poor heat conductor however will retain heat very well. Cooks evenly once cooking temperature is reached. Not recommended for use on ceramic cooktops.

PORCELAIN-ENAMEL on METAL - Heating characteristics will vary depending on base material. Porcelain-enamel coating must be smooth to avoid scratching ceramic cooktops.

GLASS - Slow heat conductor. Not recommended for ceramic cooktop surfaces because it may scratch the glass.

*CORRECT

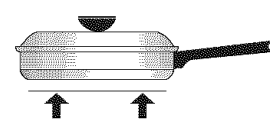

- Flat bottom and straight sides.
- Tight fitting lids.
- Weight of handle does not tilt pan. Pan is well balanced.
- Pan sizes match the amount of food to be prepared and the size of the surface element.
- Made of a material that conducts heat well.
- Easy to clean.
- Always match pot diameter to element surface diameter.

INCORRECT

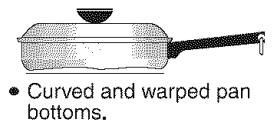

- Curved and warped pan bottoms.
- Pan overhangs element by more than one-half inch.
- Pan is smaller than element.
- Heavy handle tilts pan.

Fig. 4

Be sure to follow the recommendations for using proper cookware as illustrated in Figs. 4 & 5. For more information about the ceramic cooktop see “Cooktop Cleaning & Maintenance” in the **General Care & Cleaning** section.

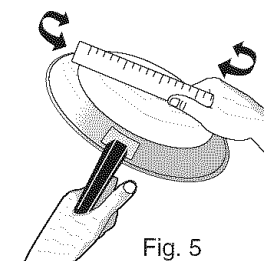

Fig. 5

Important Note: DO NOT place EMPTY aluminum, glass or porcelain-enamel coated cookware on the ceramic cooktop! The melting point of cookware made with these materials may be reached quickly especially if left empty & they may bond to the ceramic cooktop. If the cookware melts it WILL damage the cooktop! BE SURE to follow ALL the cookware manufacturer’s suggestions when using ANY type of cookware on the ceramic cooktop.

Oven Control Functions

READ THE INSTRUCTIONS CAREFULLY BEFORE USING THE OVEN. For satisfactory use of your oven, become familiar with the various features and functions of the oven as described below. **Detailed instructions for each feature and function follow later in this Use & Care Guide.**

CONV ROAST— Use to select the Convection Roast feature (See page 23).

CONV BAKE— Use to select the Convection Bake feature (See page 22).

BAKE— Use to enter the normal Bake feature. (See page 18).

PREHEAT— Use to pre-condition the oven temperature (See page 17).

BROIL— Use to select variable Broil feature (See page 21).

SLOW COOK— Use to Slow Cook feature (See page 26).

WARM & HOLD— Use to select the Warm & Hold feature (See page 28).

CONV CONVERT— Use to select the Convection Convert feature (See page 24).

COOK TIME— Use to enter the length of the baking time.

DELAY START— Use with **BAKE, COOK TIME, and CLEAN** to program a Delayed Timed Bake or Delay Self-Cleaning cycle start time.

TIMER SET/OFF— Use to set or cancel the Kitchen Timer (See page 14).

ADD 1 MINUTE— Use to select Add 1 Minute feature (See page 24).

0 THRU 9 NUMBER PADS— Use to enter temperature and times.

CONV Bake, **Conv Roast**, **Conv Convert**, **Pre Heat**, **Bake**, **Broil**, **Slow Cook**, **Warm & Hold**, **Flex Clean**, **Recipe Recall**, **Light**, **Cooktop Lockout**, **Clock**, **STOP Clear**, **START**

FLEX CLEAN— Use to select the Self-Cleaning feature (See page 30).

RECIPE RECALL— Use recall stored recipes (See page 25).

OVEN LIGHT— Use to turn the oven light ON and OFF (See page 28).

COOKTOP LOCKOUT— Use to enable or disable all cooktop features (See page 11).

CLOCK— Use to set the time of day (See page 13).

STOP/CLEAR— Use to cancel any oven mode previously entered except the Oven Lockout, Time of Day and Minute Timer. Press **STOP/CLEAR** to stop cooking.

START— Use to start all oven features (not used with Oven Light).

Minimum & Maximum Control Pad Settings

All of the features listed have minimum and maximum time or temperature settings that may be entered into the control. An ENTRY acceptance beep will sound each time a control pad is touched (the Oven Lockout pad is delayed by 3 seconds).

An ENTRY ERROR tone (3 short beeps) will sound if the entry of the temperature or time is below the minimum or above the maximum settings for the feature.

FEATURE		MIN. TEMP. /TIME	MAX. TEMP. /TIME
PREHEAT TEMP.		170°F / 77°C	550°F / 288°C
BAKE TEMP.		170°F / 77°C	550°F / 288°C
BROIL TEMP.		400°F / 205°C	550°F / 288°C
KITCHEN TIMER	12 Hr.	0:01 Min.	11:59 Hr./ Min.
	24 Hr.	0:01 Min.	11:59 Hr./ Min.
CLOCK TIME	12 Hr.	1:00 Hr./ Min.	12:59 Hr./ Min.
	24 Hr.	0:00 Hr./ Min.	23:59 Hr./ Min.
COOK TIME	12 Hr.	0:01 Min.	11:59 Hr./ Min.
	24 Hr.	0:01 Min.	23:59 Hr./ Min.
START TIME	12 Hr.	1:00 Hr./ Min.	12:59 Hr./ Min.
	24 Hr.	0:00 Hr./ Min.	23:59 Hr./ Min.
CLEAN TIME		2 hours	4 hours
CONVECTION BAKE		325°F / 149°C	550°F / 288°C

Setting Oven Controls

- Setting the Clock
- Changing between 12 or 24 hour display



Setting the Clock

The **CLOCK** (🕒) pad is used to set the clock. The clock may be set for 12 or 24 hour time of day operation. The clock has been preset at the factory for the 12 hour operation. When the range is first plugged in, or when the power supply to the range has been interrupted, the timer in the display will flash with power failure "PF" (See Fig. 1).



Fig. 1

INSTRUCTIONS

To set the clock (example below for 1:30):

1. Press (🕒). "CLO" will appear in the display (Fig. 2).
2. Press (1) (3) (0) pads to set the time of day to 1:30 (Fig. 3). "CLO" will appear in the display. Press (START). "CLO" will disappear and the clock will start (Fig. 4).

PRESS

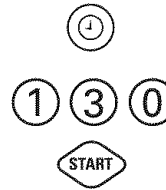

DISPLAY



Fig. 2



Fig. 3

Changing between 12 or 24 hour time of day display:

1. Press and hold (🕒) for 6 seconds (Fig. 3). While holding the pad down the current time of day will remain and "CLO" will disappear from the display (Fig. 4). CONTINUE holding the pad until a beep is heard.
2. The display will show either "12Hr"(Fig. 5) or "24Hr"(Fig. 6).
3. Press (Flex Clean) to switch between the 12 and 24 hour time of day display. The display will show either "12Hr" (Fig. 5) or "24Hr" (Fig. 6).
4. Press (START) to accept the desired change or press (STOP Clear) to reject the change.
5. Reset the correct time as described in **To set the Clock** above. Please note that if the 24 hour time of day mode was chosen, the clock will now display time from 0:00 through 23:59 hours.

(🕒) for 6 seconds



Fig. 4

(Flex Clean)



Fig. 5

(START) or (STOP Clear)





Fig. 6

Setting Oven Controls





- Continuous Bake or Twelve Hour Energy Saving Mode
- Kitchen Timer

Setting Continuous Bake or 12 Hour Energy Saving

The **TIMER SET/OFF**  and **FLEX CLEAN**  pads control the Continuous Bake or 12 Hour Energy Saving features. The oven control has a factory preset built-in 12 Hour Energy Saving feature that will shut off the oven if the oven control is left on for more than 11 hours and 59 minutes. The oven can be programmed to override this feature for Continuous Baking.

INSTRUCTIONS

To set the control for Continuous Bake or 12 Hour Energy Saving features:

1. Press and hold  for 6 seconds (Fig.1). "12:Hr" or "- :Hr" will appear in the display and the control will beep once.
2. Press  to switch between the 12 Hour Energy Saving and continuous bake features. Note: "12 Hr" (Fig. 2) in the display indicates the control is set for 12 Hour Energy Saving feature and "- : Hr" (Fig. 3) indicates the control is set for the Continuous Bake feature.
3. Press  to accept the change (Fig. 4; display will return to time of day) or press  to reject the change.

PRESS

DISPLAY

 for 6 seconds



Fig. 1





Fig. 2

 or 



Fig. 3







Fig. 4

Setting Kitchen Timer

The **TIMER SET/OFF**  pad controls the Kitchen Timer feature. The Kitchen Timer serves as an extra timer in the kitchen that will beep when the set time has run out. It does not start or stop cooking. The Kitchen Timer feature can be used during any of the other oven control functions. Refer to "Minimum & Maximum Control Pad Settings" on page 12 for time amount settings.

INSTRUCTIONS

To set the Kitchen Timer (example for 5 minutes):

1. Press . "0:00" will appear and "TIMER" will flash in the display (Fig. 5).
2. Press the number pads to set the desired time in the display (example ). Press . The time will count down with "5:00" and "TIMER" will show in the display (Fig. 6).
Note: If  is not pressed the timer will return to the time of day.
3. When the set time has run out, "End" and "TIMER" will show in the display (Fig. 7). The clock will sound with 3 beeps every 15 seconds until  is pressed.

PRESS

DISPLAY





Fig. 5



 



Fig. 6





Fig. 7

To cancel the Kitchen Timer before the set time has run out:

Press . The display will return to the time of day.



Setting Oven Controls

- Oven Lockout
- Temperature Display

Setting Oven Lockout Feature

The  pad controls the Oven Lockout feature. The Oven Lockout feature automatically locks the oven door, prevents the Warmer Drawer and most oven controls from being turned ON. It does not disable the clock, Kitchen Timer or the interior oven light.

INSTRUCTIONS

To activate the Oven Lockout feature:

1. Press and hold  for 3 seconds (Fig. 1).
2. After 3 seconds a beep will sound, **LOC** & "DOOR LOCKED" will flash in the display. Once the oven door is locked the "DOOR LOCKED" indicator will stop flashing.

PRESS

 for 3 seconds

DISPLAY



Fig. 1

To reactivate normal oven operation:

1. Press and hold  for 3 seconds. A beep will sound. **LOC** will clear. The "DOOR LOCKED" will continue to flash until the oven door has completely unlocked (See Fig. 2).
2. The oven is again fully operational.



 for 3 seconds







Fig. 2

Setting Temperature Display — Fahrenheit or Celsius

The **BROIL**  and **CLEAN**  pads control the Fahrenheit or Celsius temperature display modes. The oven control can be programmed to display temperatures in Fahrenheit or Celsius. The oven has been preset at the factory to display in Fahrenheit.

INSTRUCTIONS

To change display from Fahrenheit to Celsius or Celsius to Fahrenheit:

1. To tell if the display is set for Fahrenheit or Celsius press  (Fig. 3) and hold for 7 seconds; "550°" will first appear in the display and then a beep will sound. If "F" appears, the display is set to show temperatures in Fahrenheit (Fig. 4). If "C" appears, the display is set to show temperatures in Celsius (Fig. 5).
2. Press  to switch between Fahrenheit or Celsius display modes. The display will show either "F" (Fig. 4) or "C" (Fig. 5).
3. Press  to accept the change or press  to reject the change.

PRESS

 for 7seconds

DISPLAY



Fig. 3



Fig. 4





 or 





Fig. 5

Setting Oven Controls

- Silent Control Operation



Setting Silent Control Operation

The **DELAY START**  and **FLEX CLEAN**  pads control the Silent Control operation feature. The Silent Control operation feature allows the oven control to be operated without sounds or beeps whenever necessary. If desired the control can be programmed for silent operation and later returned to operating with all the normal sounds and beeps.

INSTRUCTIONS

PRESS

DISPLAY

To change control from normal sound operation to silent control operation:

1. To tell if your range is set for normal or silent operation press and hold  for 7 seconds. "0:00" will appear and "DELAY" will flash in the display (Fig. 1).

 for 7 seconds



Fig. 1



2. Press  to switch between normal sound operation and silent operation mode. The display will show either ":SP" (Fig. 2) or ":-" (Fig. 3).





Fig. 2

If ":SP" appears (Fig. 2), the control will operate with normal sounds and beeps. If ":-" appears (Fig.3), the control is in the silent operation mode.

3. Press  to accept the change or press  to reject the change.

 or 



Fig. 3

Setting Oven Controls





- Preheat for Electric Ranges

Setting Preheat

For the best baking performance use the **PREHEAT**  feature. The Preheat feature will bring the oven up to the set baking temperature and then indicate when to place the food in the oven. Use this feature in combination with the Bake pad when recipes call for preheating. Preheating is not necessary when roasting or cooking casseroles. The oven can be programmed to preheat at any temperature between 170°F to 550°F.

INSTRUCTIONS

To set the Preheat temperature for 350°F:







1. Arrange the interior oven racks.
2. Press . "--- °" and "BAKE" will appear in the display (See Fig. 1).
3. Press   . "350°" will appear in the display (See Fig. 2).
4. Press . "PRE" and "BAKE" will appear in the display as the oven heats and reaches 350°F (Fig 3).

Note: After the oven has reached the desired temperature (this example, 350°F) the control will sound a long beep, the "PRE" light will turn off and oven temperature will be displayed (Fig. 4). If the beep was missed, a quick glance at the display with oven temperature showing in the oven display is a good way to check that the oven has already reached the preheat temperature. Once the oven has preheated, **PLACE FOOD IN THE OVEN**. The "BAKE" light will stay on.

Press  when baking is complete or to cancel the Preheat feature.

To change Preheat temperature while oven is preheating (example changing from 350 to 425°F):

If it is necessary to change the preheat temperature while the oven is preheating to the original temperature:

1. While preheating, press . "--- °" and "BAKE" will appear in the display (Fig. 5).
2. Enter the new preheat temperature. Press   . "425°" and "BAKE" will appear in the display (Fig. 6).
3. Press . "PRE" and "BAKE" will appear in the display as the oven heats to 425°F (Fig. 7). A long beep will sound once the oven temperature reaches 425°F and the display will show "425°" and "BAKE" (See Fig. 8).
4. When baking is complete press .

PRESS

DISPLAY

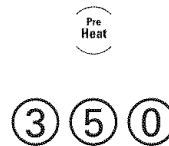

Fig. 1



Fig. 2

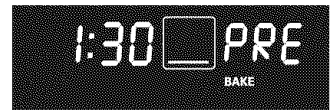

Fig. 3

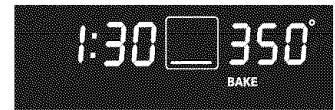

Fig. 4

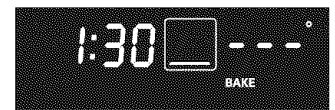
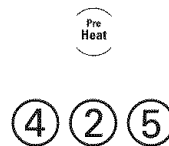

Fig. 5

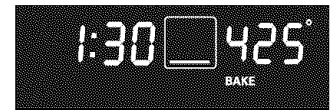

Fig. 6

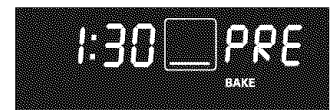

Fig. 7



Fig. 8

Setting Oven Controls

- Bake

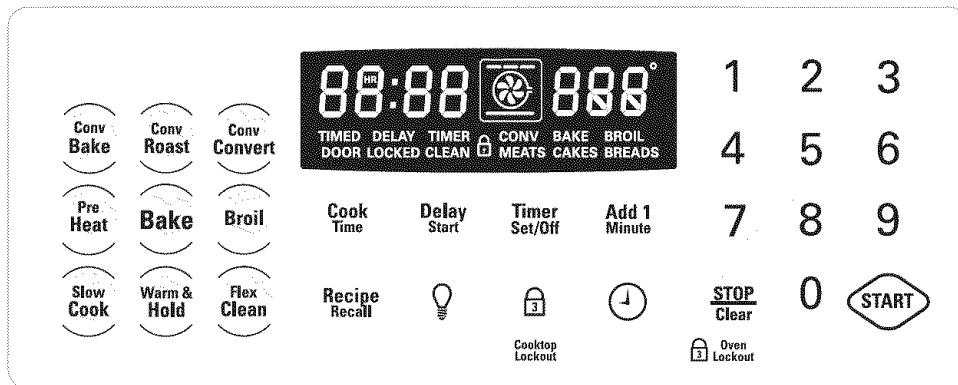

Setting Bake

The **BAKE** ^{Bake} pad controls normal baking. If preheating is necessary, refer to the **PREHEAT** ^{Pre Heat} feature for instructions. The oven can be programmed to bake at any temperature from 170°F to 550°F (The sample shown below is for 350°F).

INSTRUCTIONS

To set the Bake Temperature to 350°F:

1. Arrange interior oven racks and place food in oven.
2. Press ^{Bake}, "- - - °" will appear in the display (Fig. 1).
3. Press ³ ⁵ ⁰ (Fig. 2). "BAKE" will flash and "350°" will appear in the display.
4. Press ^{START}. A long beep will sound once the oven temperature reaches 350° F and the display will show "350°" and "BAKE" (Fig. 3).

Pressing ^{STOP Clear} will cancel the Bake feature at any time.

To change the Bake Temperature (example changing from 350° to 425°F):

1. After the oven has already been set to bake at 350°F and the oven temperature needs to be changed to 425°F, press ^{Bake} (Fig. 4) and "- - - °" will show in the display.
2. Press ⁴ ² ⁵ (Fig. 5). "BAKE" flashes and "425°" will appear in the display.
3. Press ^{START}. "BAKE" and "425°" will appear in the display (See Fig. 6).

PRESS

DISPLAY

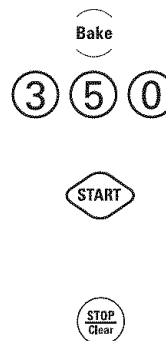

Fig. 1



Fig. 2



Fig. 3

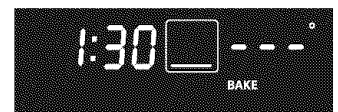
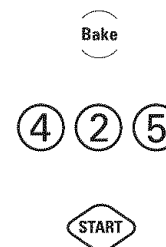

Fig. 4



Fig. 5





Fig. 6

Setting Oven Controls









- Timed Bake

Setting Timed Bake

The **BAKE**  and **COOK TIME**  pads control the Timed Bake feature. The automatic timer of the Timed Bake feature will turn the oven OFF after cooking for the desired amount of time you selected.

INSTRUCTIONS

To program the oven to begin baking immediately and to shut off automatically: (example below to bake at 350°F for 50 minutes):

1. Be sure the clock is set for the correct time of day.
2. Arrange interior oven rack(s) and place the food in the oven.
3. Press , "-- °" will appear in the display (Fig. 1).
4. Press    (Fig. 2). "BAKE" will flash and "350°" will appear in the display.
5. Press . "BAKE" and "350°" will appear in the display (See Fig. 3).
6. Press . "TIMED" will flash; "BAKE", "0:00" and "350°" will appear in the display (Fig. 4).
7. Enter the desired baking time by pressing  . "TIMED" will flash and "BAKE", "50:00" and "350°" will appear in the display (Fig. 5). Note: Baking time can be set for any amount of time between 1 minute to 11 hours and 59 minutes.
8. Press . Both "TIMED" and "BAKE" will remain on in the display (Fig. 6). Once the Timed Bake feature has started, the current time of day will appear in the display.

Note: After the Timed Bake feature has activated, press  to display the bake time remaining in the Timed Bake mode. Once Timed Bake has started baking, a long beep will sound when the oven temperature reaches the set temperature.

Press  when baking has finished or at any time to cancel the Timed Bake feature.

When the Timed Bake finishes:

1. "End" and the time of day will show in the display. The oven will shut off automatically (Fig. 7).
2. The control will beep 3 times. The control will continue to beep 3 times every 30 seconds until  is pressed.

PRESS

DISPLAY



Fig. 1



Fig. 2



Fig. 3

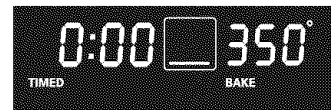

Fig. 4



Fig. 5



Fig. 6



Fig. 7

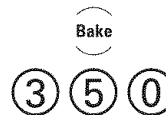

CAUTION Use caution with the **TIMED BAKE** or **DELAY START** (Delayed Timed Bake) features. Use the automatic timer when cooking cured or frozen meats and most fruits and vegetables. Foods that can easily spoil such as milk, eggs, fish, meat or poultry, should be chilled in the refrigerator first. Even when chilled, they should not stand in the oven for more than 1 hour before cooking begins, and should be removed promptly when cooking is completed. Eating spoiled food can result in sickness from food poisoning.

Setting Oven Controls







- Setting Delay Start (Delayed Timed Bake)

Setting Delay Start

The **BAKE** , **COOK TIME**  and **DELAY START**  pads control the Delayed Timed Bake feature. The automatic timer of the Delayed Timed Bake will turn the oven ON and OFF at the time you select in advance.

INSTRUCTIONS

To program the oven for a Delay Start (Delayed Timed Bake) and to shut off automatically (example for baking at 350°F for 50 minutes and starting at 5:30):

- Be sure that the clock is set with the correct time of day.
- Arrange interior oven rack(s) and place the food in the oven.
- Press **BAKE** . " --- °" will appear in the display (Fig. 1).
- Press **3** **5** **0** (Fig. 2). "BAKE" will flash and "350°" will appear in the display.
- Press **START** . "BAKE" and "350°" will appear in the display (See Fig. 3).
- Press **COOK TIME** . "TIMED" will flash; "BAKE", "0:00" and "350°" will appear in the display (Fig. 4).
- Enter the desired baking time using the number pads by pressing **5** **0**. "TIMED" will flash; "BAKE", "50:00" and "350°" will appear in the display (Fig. 5). Note: Baking time can be set for any amount of time from 1 minute to 11 hours and 59 minutes.
- Press **START** . "TIMED", "BAKE" and "350°" will be displayed (Fig. 6).
- Press **DELAY START** . Enter the desired start time using the number pads **5** **3** **0** (Fig. 7).
- Press **START** . When Delay Start starts, the set oven temperature will disappear, "TIMED", "DELAY", "BAKE" and the current time of time of day will appear in the display (Fig. 8).

Note: Once Delay Start has started, press **COOK TIME**  to display the bake time remaining. Once the Delayed Timed Bake has started baking, a long beep will sound when the oven temperature reaches the set temperature.

Press **STOP CLEAR**  when baking has finished or at any time to cancel the Delay Start (Delayed Timed Bake) feature.

When the set bake time runs out:

- "End" and the time of day will show in the display. The oven will shut off automatically (Fig. 9).
- The control will beep 3 times. The control will continue to beep 3 times every 30 seconds until **STOP CLEAR**  is pressed.

PRESS

DISPLAY



Fig. 1



Fig. 2



Fig. 3

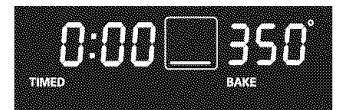

Fig. 4

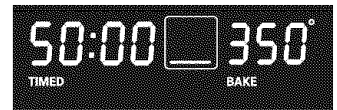

Fig. 5



Fig. 6



Fig. 7



Fig. 8



Fig. 9

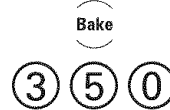

NOTE: If your clock is set for normal 12 hour display mode the **Delay Start** (Delayed Timed Bake) feature can never be set to start more than 12 hours in advance. To set the **Delay Start** 12-24 hours in advance see page 13 for instructions to set the control for the 24 hour time of day display mode.

Setting Oven Controls

- Setting Broil (Electric Range)



The  pad controls the Broil feature. When broiling, heat radiates downward from the oven broiler for even coverage. The Broil feature is preset to start broiling at 550°F however, the Broil feature temperature may be set at any temperature between 400°F and 550°F.

The broil pan and broil pan insert used together allows dripping grease to drain and be kept away from the high heat of the oven broiler. **DO NOT** use the broil pan without the insert (See Fig. 6; some models). **DO NOT cover the broil pan insert with foil.** The exposed grease could catch fire.

⚠ WARNING Should an oven fire occur, leave the oven door closed and turn the oven OFF. If the fire continues, throw baking soda on the fire or use a fire extinguisher. **DO NOT** put water or flour on the fire. Flour may be explosive and water can cause a grease fire to spread and cause personal injury.

INSTRUCTIONS

To set the oven to broil at the default setting (550°F):

- Place the broiler pan insert on the broiler pan. Then place the food on the broiler pan insert (some models). **DO NOT** use the broiler pan without the insert. **DO NOT** cover the broiler insert with foil. The exposed grease could ignite.
- Arrange the interior oven rack and place the broiler pan on the rack. Be sure to center the broiler pan directly under the broiler element. **Make sure the oven door is in the broil stop position** (See Fig. 5).
- Press . "BROIL" will flash and "550°" will appear (Fig. 1).
- If a lower broil temperature is desired (minimum broil temperature setting is 400°F), press the desired temperature before continuing to step 5.
- Press . The oven will begin to broil. "BROIL" and "550°" will appear in the display (Fig. 2).
- Broil on one side until food is browned; turn and cook on the second side. Season and serve. **Note:** Always pull the rack out to the stop position before turning or removing food.
- To cancel broiling or if finished broiling press  (Fig. 3).

PRESS

DISPLAY



Fig. 1

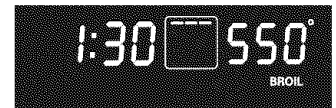

Fig. 2



Fig. 3

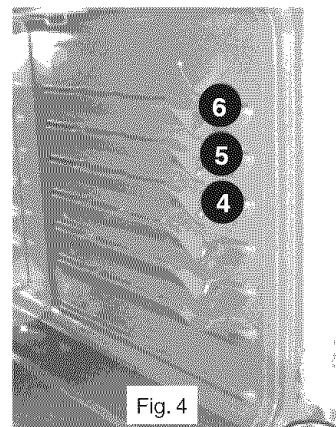

Fig. 4

Recommended Broiling Times

Use the following table for approximate broiling times. Increase or decrease broiling times, or move the broiling pan to a different rack position to suit for doneness. If the food you are broiling is not listed in the table, follow the instructions provided in your cookbook and watch the item closely.

Broiling Table (Refer to Fig. 4)

Food Item	Rack Position	Temp Setting	Cook Time		Doneness
			1st side	2nd side	
Steak 1" thick	5th or 6th	550° F	7:00	5:00	Medium
	5th or 6th	550° F	8:00	6:00	Medium-Well
Pork Chops 3/4" thick	5th	550° F	8:00	6:00	Well
Chicken - Bone In	4th	450° F	20:00	10:00	Well
Chicken - Boneless	5th	450° F	8:00	6:00	Well
Fish	5th	500° F	13:00	n/a	Well
Shrimp	4th	550° F	5:00	n/a	Well
Hamburger 1" thick	6th	550° F	9:00	7:00	Medium
	5th	550° F	10:00	8:00	Well

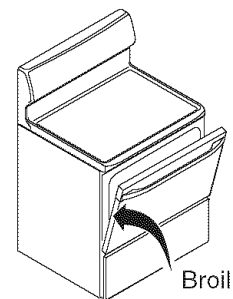

Fig. 5

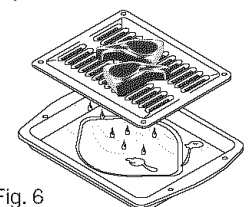



Fig. 6

Setting Oven Controls

- Setting Convection Bake

Benefits of Convection Bake:
 —Some foods cook up to 25 to 30% faster, saving time and energy.
 —Multiple rack baking.
 —No special pans or bakeware needed.

Setting Convection Bake

The **CONV BAKE**  pad controls the Convection Bake feature. Use the Convection Bake feature when cooking speed is desired. The oven can be programmed for Convection Bake at any temperature between 300° F (149° C) to 550° F (288° C).

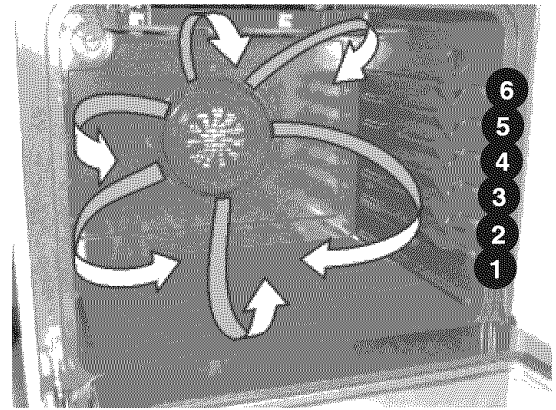

Air circulation of Convection Cooking
Fig. 1





Convection baking uses a fan to circulate the oven's heat evenly and continuously within the oven (See Fig. 1). This improved heat distribution allows for even cooking and excellent results using multiple racks at the same time. Foods cooked on a single oven rack will generally cook faster and more evenly with Convection Bake. Multiple oven rack cooking may slightly increase cook times for some foods, but the overall result is time saved. Breads and pastries brown more evenly.

Tips for Convection Bake

1. Time reductions will vary depending on the amount and type of food to be cooked. Cookies and biscuits should be baked on pans with no sides or very low sides to allow heated air to circulate around the food. Food baked on pans with a dark finish will cook faster.
2. Preheating is not necessary when cooking casseroles with Convection Bake.
3. When using Convection Bake with a single rack, place oven rack in position 3 or 4. If cooking on multiple racks, place the oven racks in positions 1, 3 and 6 (for 3 racks) and positions 2 and 5 (See Fig. 1).
4. Cakes have better results when baked using the **BAKE**  pad.

INSTRUCTIONS

To set the oven for Convection Bake and temperature to 350°F:

1. Arrange interior oven racks and place food in oven (See Fig. 1).
2. Press . "**CONV BAKE**" will flash and "---°" will appear in the display (Fig. 2).
3. Press   . "**CONV BAKE**" and "350°" will appear in the display (See Fig. 3).
4. Press . "**CONV BAKE**" and the oven temperature **adjustment** will appear in the display (for this example it is 325°F). A beep will sound once the **adjusted** oven temperature is reached. The display will show "325°", "**CONV BAKE**" and the fan icon (Fig. 4).

Note: The oven icon will show a rotating fan within the square. This rotating fan icon indicates when the Convection Fan is operating (See rotating fan in Fig. 4).

Press  to stop Convection Bake or cancel Convection Bake at any time.

PRESS

DISPLAY

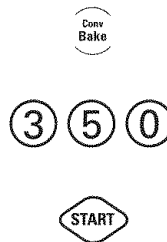

Fig. 2



Fig. 3



Fig. 4



Setting Oven Controls





- Setting Convection Roast

Setting Convection Roast

The **CONV ROAST**  pad is designed to give optimum cooking performance for this feature. The Convection Roast pad combines a cook cycle with the convection fan and element to roast meats and poultry. Preheating is not necessary for meats and poultry. Heated air circulates around the food from all sides, sealing in juices and flavors. Foods are crispy brown on the outside while staying moist on the inside.

INSTRUCTIONS

To set the Convection Roast feature (example for Meats to cook at 350°F):

1. Arrange interior oven racks and place food in oven.
2. Press . "CONV" will flash and "---°" will be displayed (See Fig. 1).
3. Press   . "CONV" will flash and "350°" will appear in the display (See Fig. 2).
4. Press . "CONV" and "350°" will appear in the display (See Fig. 3). The convection fan icon will come on.

Press  to stop Convection Roast at any time.

PRESS



DISPLAY



Fig. 1



Fig. 2



Fig. 3

Roasting Rack Instructions

When preparing meats for convection roasting, use the broiler pan and insert along with the roasting rack. The broiler pan will catch grease spills and the insert will help prevent grease splatters. The roasting rack will allow the heat to circulate around the meat.

⚠ WARNING To prevent food from contacting the broil element and to prevent grease splattering, **DO NOT** use the roasting rack when broiling.

1. Place oven rack on bottom or next to the bottom rack position. See Arranging Oven Racks in the **Before Setting Oven Controls** section.
2. Place the insert in the broiler pan. The roasting rack fits on the insert allowing the heated air to circulate under the food for even cooking and helps to increase browning on the underside. Make sure the roasting rack is securely seated on the insert in the broiler pan. **DO NOT** use the broiler pan without the insert. **DO NOT** cover the insert with aluminum foil.
3. Position food (fat side up) on the roasting rack (See Fig. 4).
4. Place the broiler pan on the oven rack.

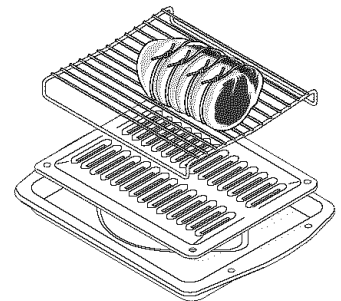



Fig. 4

Setting Oven Controls

- Setting Convection Convert Feature
- Setting Add 1 Minute Feature





To set the Convection Convert feature

The  **CONV CONVERT** pad is used to automatically convert a standard **baking** recipe for convection baking. When set properly, this feature is designed to display the actual converted (reduced) temperature in display.

Convection Convert may **ONLY** be used with a **Bake**, **Timed Bake** or a **Delay Start** (Delayed Timed Bake) setting. When used with a Timed Bake or a Delayed Timed Bake setting, the Convection Convert feature will display a "CF" for check food when the bake time is 75% complete (See Fig. 4). At this time the oven control will sound 3 long beeps at regular intervals until baking has finished. When the bake time has completely finished the control will display "End" and will sound 3 long beeps every 30 seconds until the  pad is pressed (See Fig. 5).

INSTRUCTIONS

Using Convection Convert (Bake) feature to automatically adjust oven temperature (example below when setting oven for 350°F):



1. Arrange interior oven racks and place food in oven.
2. Press  , "- - - °" will appear in the display (Fig. 1).
3. Press    . "BAKE" will flash and "350°" will appear in the display (See Fig. 2). If a Timed Bake or a Delayed Start (Delayed Timed Bake) is desired, enter the times now.
4. Press  . "CONV BAKE" and the oven temperature **adjustment** will appear in the display (for this example it is 325°F). A beep will sound once the **adjusted** oven temperature is reached. The display will show "325°", "CONV BAKE" and the fan icon (Fig. 3).



Note: The oven icon will show a rotating fan within the square. This rotating fan icon indicates when the Convection Fan is operating (See rotating fan in Fig. 3).

Press  to cancel Convection feature at any time.

Note: The minimum amount of cook time using the Convection Convert feature with a **Timed Bake** or a **Delay Start** (Delayed Timed Bake) is 20 minutes.

To Set Add 1 Minute Feature

The  **ADD 1 MINUTE** pad is used to set additional minutes to the Minute Timer. Each time the  pad is pressed, another minute is added to the Minute Timer if the Minute Timer is already active. If the Minute Timer is not active and the  pad is pressed, the Minute Timer feature will become active and will begin counting down from 1 minute.

When the Minute Timer reaches the end of the set time, the timer will display "End" and signal 3 long beeps at regular intervals until  is pressed. If a Minute Timer function has ended pressing  will restart the timer at 1 minute.

For further information on how to set the Minute Timer feature see **To Set the Minute Timer** instructions.

PRESS

DISPLAY



Fig. 1



Fig. 2



Fig. 3



Fig. 4



Fig. 5

Setting Oven Controls

- Setting the Recipe Recall Feature

To Set the Recipe Recall Feature

The  **RECIPE RECALL** pad is used to record and recall your favorite recipe settings. This feature may store and recall from 1 to 3 different settings. The Recipe Recall feature may be used with **Bake** or a **Timed Bake**. This feature will not work with any other function including a **Delay Start** (Delayed Timed Bake) setting.

INSTRUCTIONS

PRESS

DISPLAY

To Program the Oven to record a recipe setting and begin baking (sample shown is for bake at 350°F):









- Place the food in the oven.
- Press , "**BAKE**" flashes and " — — — ° " appears in the display (See Fig. 1)
- Within 5 seconds, press . (Note:  or  may also be used to store a recipe setting). "**BAKE**" flashes, "- 1-" and " — — — ° " appears in the display (See Fig. 2).
- Press   . "**BAKE**" flashes, "- 1-" and " 350°" appears in the display (See Fig. 3).
- Press and hold  pad for at least 3 seconds or until a beep sounds. The beep indicates that the recipe setting has been recorded for future recall. The display will show 350° and "**BAKE**" (See Fig. 4).



Fig. 1

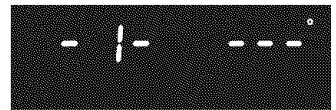

Fig. 2



Fig. 3

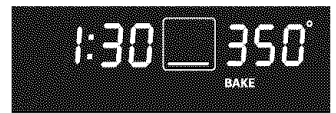

Fig. 4





NOTE: The oven will continue to bake unless  is pressed.



Fig. 5

To Begin Baking recalled setting (example below recalling from the number 1 pad) :

- Place the food in the oven.
- Press , "**BAKE**" flashes and " — — — ° " appears in the display (See Fig. 5).
- Within 5 seconds, press . "**BAKE**" flashes, "- 1-" and " 350°" appears in the display (See Fig. 3).
- Press . The oven will begin to immediately cook with the previously recorded recipe (See Fig. 4). The Temperature is recalled and if a Timed Bake was recorded this feature will also recall the cooking time.



English

Setting Oven Controls

- Setting the Slow Cook Feature

Setting the Slow Cook Feature

The  **SLOW COOK** pad is used to activate this feature. The Slow Cook feature may be used to cook foods more slowly, at lower oven temperatures and provides cooking results much the same way as a Slow Cooker or Crock-Pot. The Slow Cook feature is ideal for roasting beef, pork & poultry. Slow Cooking meats may result in the exterior of meats becoming dark but not burnt. This is normal.

There are 2 settings available, high (**HI**) or low (**LO**). The HI setting is best for cooking foods from a 4 to 5 hour time period. The LOW setting is best for cooking foods from a 8 to 9 hour time period. The maximum cook time for the Slow Cook feature is 12 hours unless the oven control has been changed to the Continuous Bake mode. This feature may be used with the additional settings of a **Timed Bake** or a **Delay Start** (Delayed Timed Bake).





Some tips you should review for best possible results using Slow Cook feature:

- Completely thaw all frozen foods before cooking with the Slow Cook.
- When using a single rack, place in position 2 or 3.
- Position multiple racks to accommodate size of cooking utensils when cooking multiple food item.
- Do not open the oven door often or leave the door open when checking foods. If the oven heat escapes often, the Slow Cook time may need to be extended.
- Cover the foods to keep them moist or use a loose or vented type cover to allow foods to turn crisp or brown.
- Roasts may be left uncovered so browning can occur. Cook times will vary; depending on the weight, fat content, bone & the shape of the roast.
- Use the recipe's recommended food temperature and a food thermometer to determine when the food is done.
- Preheating the oven will not be necessary when using the Slow Cook feature.
- Add any cream or cheese sauces during the last hour of cooking.

See the suggested Slow Cook feature recipes provided in the back of this Use & Care Guide.

INSTRUCTIONS

To Program the Oven to begin baking with the Slow Cook feature (example below shows clock at 1:30):

1. Place the food in the oven.
2. Press . “SLO” and “HI” (See Fig. 1) will appear in the display (If no further keypads are touched within 25 seconds the request for Slow Cook will clear).
3. If a low setting is desired, press the  a 2nd time to set the Slow Cook feature with a low setting. “SLO” and “LO” will appear in the display (See Fig. 2).
5. Press . The Slow Cook feature will activate (See Fig. 3).
4. If desired, add any **Timed Bake** or **Delay Start** (Delayed Timed Bake) settings at this time.
6. To cancel the Slow Cook feature press  at anytime.

PRESS



DISPLAY



Fig. 1



Fig. 2



Fig. 3

Setting Oven Controls



- Setting the Sabbath Day Feature

To Set the Sabbath Feature (for use on the Jewish Sabbath & Holidays)

The **COOK TIME** and **DELAY START** pads are used to set the Sabbath feature. The Sabbath feature may only be used with the **Bake** pad. The oven temperature may be set higher or lower after setting the Sabbath feature (the oven temperature adjustment feature should be used only during Jewish Holidays), however the display will not visibly show and no audible tones will be provided when a change occurs. Once the oven is properly set using Bake with the Sabbath feature active, the oven will remain continuously ON until cancelled. This will override the factory preset 12-Hour Energy Saving feature. If the oven light is needed during the Sabbath, press before activating the Sabbath feature. Once the oven light is turned ON and the Sabbath feature is active, the oven light will remain ON until the Sabbath feature is turned OFF. If the oven light needs to be OFF, be sure to turn the oven light OFF before activating the Sabbath feature.

IMPORTANT NOTES: It is not advised to attempt to activate any other program feature except **BAKE** while the Sabbath feature is active. ONLY the following key pads will function correctly with the Sabbath feature: **0-9 number pads**, ,

& . **ALL OTHER KEYPADS** should not be used once the Sabbath feature is activated.

INSTRUCTIONS

PRESS

DISPLAY

To Program the Oven for 350°F, Begin Baking Immediately and activate the Sabbath feature:

1. Be sure that the clock is set with the correct time of day.
2. Arrange the oven racks and place the food in the oven.
3. Press , " - - - ° " will appear in the display (Fig. 1).
3. Press (Fig. 2). "**BAKE**" will flash and "350°" will appear in the display.
4. Press . The display will show "350°" and "**BAKE**". The oven will turn ON and begin heating (See Fig. 3).
5. If a **Timed Bake** or **Delay Start** (Delayed Timed Bake) is needed then enter the time in this step. If not, skip this step and continue to step 6. Refer to the **Timed Bake** or **Delay Start** instructions on pages 19-20. Remember the oven will shut down after completing a **Timed Bake** or **Delay Start** and therefore may only be used once during the Sabbath/Jewish Holidays. The maximum **Delay Start** time is 11 hours & 59 minutes.
6. At the same time press and hold both the and pads for at least 3 seconds. The control will beep and **SAb** will appear in the display (See Fig. 4). Once **SAb** appears in the display the oven control will no longer beep or display any further changes and the oven is properly set for the Sabbath feature.



Fig. 1

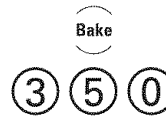

Fig. 2



Fig. 3

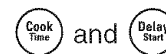

Fig. 4

Note: You may change the oven temperature once baking has started. Press , enter the oven temperature change (170 to 550F°) and press (for Jewish Holidays only). Remember that **the oven control will no longer beep or display any further changes** once the oven is set for the Sabbath feature.



7. The oven may be turned OFF at any time by pressing pad (this will turn the oven OFF only). To turn OFF the Sabbath feature press and hold at the same time both the and pads for at least 3 seconds. **SAb** will disappear from the display.

Setting Oven Controls

- Setting the Sabbath Day Feature (cont'd)
- Setting the Warm & Hold™ Feature
- Oven Light

It is recommended that any oven temperature change with the Sabbath feature activated be followed with 2 presses of the **START** pad. This will insure the oven remains ON even if the attempt to set the oven temperature was lower or higher than the oven control can accept. If the oven temperature is set incorrectly, the oven temperature will default to 170°F or 550°F. Try to set the desired oven temperature again.

Should you experience a power failure or interruption, the oven will shut off. When power is returned the oven will not turn back on automatically. The oven will remember that it is set for the Sabbath and the food may be safely removed from the oven while still in the Sabbath feature, however the oven cannot be turned back on until after the Sabbath/Holidays. After

the Sabbath observance turn OFF the Sabbath feature. At the same time press and hold both the  and  pads for at least 3 seconds. **SAb** will disappear from the display and the oven may be used with all normal functions. For further assistance, guidelines for proper usage, and a complete list of models with the Sabbath feature, please visit the web at <http://www.star-k.org>.

Setting the Warm & Hold™ Feature

The  pad turns ON the Warm & Hold feature and will maintain an oven temperature of 170° F. The **Warm & Hold** feature will keep oven baked foods warm for serving up to 3 hours after cooking has finished. After 3 hours the Warm & Hold feature will shut the oven OFF automatically. The Warm & Hold feature may be used without any other cooking operations or can be used after cooking has finished using **TIMED BAKE** or **DELAY START** (Delayed Timed Bake).

INSTRUCTIONS

PRESS

DISPLAY

To set Warm & Hold:

1. Arrange interior oven racks and place baked food in oven. If the food is already in the oven go to step 2.

2. Press . "HLd" will appear in the display (See Fig. 1).

Note: If no further pads are touched within 25 seconds the request to turn ON Warm & Hold will be cleared.

3. Press . "HLd" shows and the oven icon will appear in the display (See Fig. 2).



4. To turn Warm & Hold OFF at any time press  or .



Fig. 1

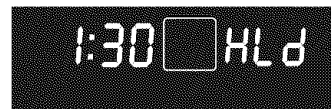
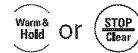



Fig. 2





To set Warm & Hold to turn ON automatically:

1. Arrange interior oven racks and place food in oven. Set the oven properly and start a **Timed Bake** or **Delay Start** (Delayed Timed Bake).

2. Press . "HLd" will appear in the display.

3. Press . "HLd" shows and the oven icon will appear in the display. Warm & Hold is set to turn ON automatically after completing a **Timed Bake** or **Delay Start** (Delayed Timed Bake).

4. To turn Warm & Hold OFF at any time press  or .



Note: The Warm & Hold feature can be turned ON or OFF at anytime without canceling Bake or any other cooking functions by pressing .

To turn ON/OFF the Oven Light

The oven light automatically turns ON when the door is opened. The oven light may also be manually turned ON or OFF by pressing the  pad.

Setting Warmer Drawer Controls

- Arranging Warmer Drawer Racks
- Operating the Warmer Drawer

Arranging Warmer Drawer (Warm & Ready™ Drawer) Rack Positions (some models)

Note: Use the warmer drawer to keep hot foods hot such as: vegetables, gravies, meats, casseroles, biscuits and rolls, pastries and heated dinner plates.

The rack can be used in 2 ways:

- In the **upright position** to allow low profile food items to be placed both under and on top of the rack (for example, rolls or biscuits on top of the rack and a casserole dish under - See Fig. 1).
- In the **downward position** to allow you to place light weight food items and empty dishware (for example, rolls or pastries and dinner plates - See Fig. 2).

The warmer drawer is equipped with a catch which may require extra force when opening and closing the drawer.

To Operate the Warmer (Warm & Ready™) Drawer

Always start with hot food. It is not recommended to heat cold food in the warmer drawer.

All food placed in the warmer drawer should be covered with a lid or aluminum foil to maintain quality. **Do not use plastic wrap to cover food. Plastic may melt onto the drawer and be very difficult to clean.**

Use only dishes, utensils and cookware recommended for oven use in the warmer drawer.

CAUTION Always use pot holders or oven mitts when removing food from the warmer drawer as cookware and plates will be HOT.

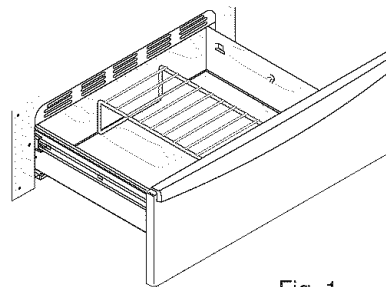

Fig. 1

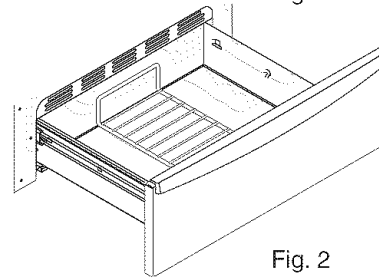

Fig. 2

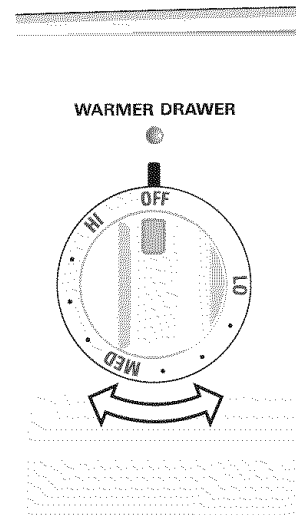

Fig. 3

ENGLISH

Warmer Drawer Recommended Food Settings Table	
Food Item	Setting
Bacon	HI
Hamburger Patties	HI
Poultry	HI
Pork Chops	HI
Fried Foods	HI
Pizza	HI
Gravies	MED
Casseroles	MED
Eggs	MED
Roasts (Beef, Pork, Lamb)	MED
Vegetables	MED
Biscuits	MED
Rolls, hard	MED
Pastries	MED
Rolls (soft)	LO
Empty Dinner Plates	LO

To Set the Warmer (Warm & Ready™) Drawer Thermostat Control (some models)

The thermostat control is used to select the temperature of the warmer drawer. It is located on the control panel (See Fig. 3). To set the thermostat, push in and turn the knob to the desired setting. The temperatures are approximate, and are designated by HI, MED and LO.

1. Turn the knob to select the desired temperature setting.
2. For best results, preheat the drawer before adding food. An empty drawer will preheat in approximately 15 minutes.
3. Turn the thermostat control to **OFF** after use.

Warmer (Warm & Ready™) Drawer Temperature Selection (some models)

Refer to the table in the side column for recommended settings. If a particular food is not listed, start with the medium setting. If more crispness is desired, remove the lid or aluminum foil.

Most foods can be kept at serving temperatures by using the medium setting.

When a combination of foods are to be kept warm (for instance, a meat with 2 vegetables and rolls), use the high setting.

Refrain from opening the warmer drawer while in use to eliminate loss of heat from the drawer.

Setting Warmer Drawer Controls

- Warmer Drawer Indicator Light
- Removing & Replacing Warmer Drawer

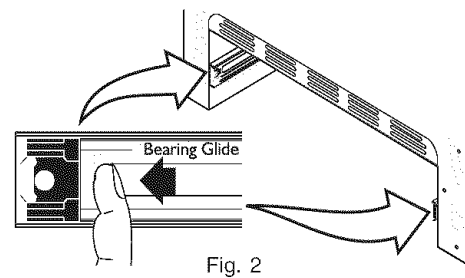
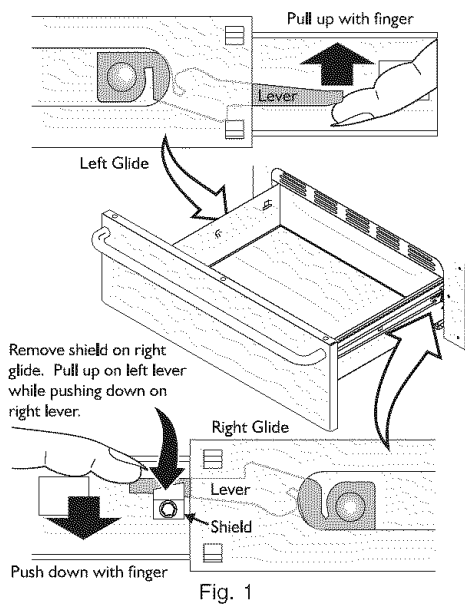

NOTE: The Warmer Drawer will **NOT** operate while in the Self-Clean and "Oven Lockout" modes

Warmer (Warm & Ready™) Drawer Indicator Light (some models)

The indicator light is located above the Warmer Drawer thermostat control. It turns on when the control is set, and stays on until the control is turned OFF. The warmer drawer is inoperable during the Self-Clean cycle. The indicator light will not come on during the Self-Clean cycle.



⚠ WARNING Electrical Shock Hazard can occur and result in serious injury or death. Disconnect appliance from electric power before cleaning and servicing the warmer drawer.

To Remove and Replace Warmer (Warm & Ready™) Drawer (some models)

To Remove Warmer Drawer:

1. **⚠ CAUTION** Turn power OFF before removing the warmer drawer.
2. Open the drawer to the fully opened position.
3. On the right glide you will find a shield attached with a hex-head screw (See Fig. 1). Use a 1/4" socket and ratchet remove the shield.
4. Locate glide lever on each side of drawer, pull up on the left glide lever and push down on the right glide lever.
5. Pull the drawer away from the range.

To Replace Warmer Drawer:

1. Replace shield on the right glide of the drawer body.
2. **Pull the bearing glides to the front** of the chassis glide (See Fig. 2).
3. Align the glide on each side of the drawer with the glide slots on the range.
4. Push the drawer into the range until levers "click" (approximately 2"). Pull the drawer open again to seat bearing glides into position. **If you do not hear the levers "click" or the bearing glides do not feel seated remove the drawer and repeat steps 2-4.** This will minimize possible damage to the bearing glides.

Self-Cleaning

- Preparing for a Self-Clean cycle

CAUTION During the Self-Cleaning cycle, the outside of the range can become very hot to the touch. **DO NOT** leave small children unattended near the appliance.

CAUTION The health of some birds is extremely sensitive to the fumes given off during the Self-Cleaning cycle of any range. Move birds to another well-ventilated room.

CAUTION **DO NOT** line the oven walls, racks, bottom or any other part of the range with **aluminum foil**. Doing so will destroy heat distribution, produce poor baking results and cause permanent damage to the oven interior (aluminum foil will melt to the interior surface of the oven).

CAUTION **DO NOT** force the oven door open. This can damage the automatic door locking system. Use caution when opening the door after the Self-Cleaning cycle is completed. The oven may still be **VERY HOT**.

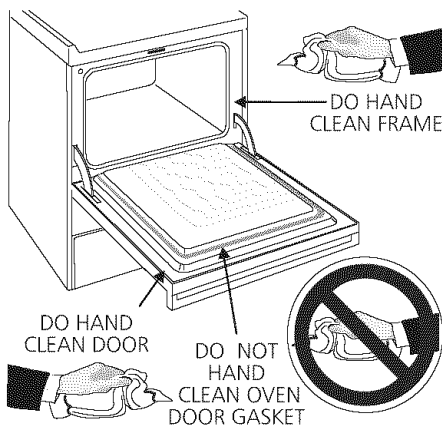

Note: See additional cleaning information for the oven door in the **General Care & Cleaning** section.



Self-Cleaning Oven



A Self-Cleaning oven cleans itself with high temperatures (well above cooking temperatures) which eliminate soils completely or reduces them to a fine powdered ash you can wipe away with a damp cloth.

Prepare for the Self-Cleaning Cycle with the following precautions:

- **DO NOT** use oven cleaners or oven protective coatings in or around any part of the Self-Cleaning oven.
- **DO NOT** clean the oven door gasket. The woven material of the oven door gasket is essential for a good seal. Care should be taken not to rub, damage or remove the gasket.
- **DO NOT** use any cleaning materials on the oven door gasket. Doing so could cause damage.
- **Remove the broiler pan & insert, all utensils & ANY aluminum foil. These items cannot withstand high cleaning temperatures.**
- Remove the oven racks. If the racks are left in the oven during the Self-Clean cycle their color will turn slightly blue & the finish will be dull. After the cycle is complete and the oven has cooled, rub the sides of the oven racks with wax paper or a cloth containing a small amount of salad oil (this will make the oven racks glide easier into the oven rack positions).
- **Remove any excessive spills** in the oven cavity **before** starting the Self-Cleaning cycle. To clean, use hot, soapy water and a cloth. Large spills can cause heavy smoke or fire when subjected to high temperatures. **DO NOT** allow food spills with a high sugar or acid content (such as milk, tomatoes, sauerkraut, fruit juices or pie filling) to remain on the surface as they may leave a dull spot even after cleaning.
- Clean any soil from the oven frame, the door liner outside the oven door gasket and the small area at the front center of the oven bottom. These areas heat sufficiently to burn soil on. Clean with soap and water.
- **NOTE:** Prior to setting the Self-Clean cycle, any spills remaining on the oven bottom should be removed.

Self-Cleaning

- Setting Flex Clean
- Setting Delay Flex Clean



The **FLEX CLEAN**  pad is used to start a Self-Cleaning cycle. When used with the **DELAY START**  pad, a delayed Self-Cleaning cycle may also be programmed. The **FLEX CLEAN** feature allows for any Self-Cleaning cycle time from 2 (2:00) to 4 hours (4:00) to be selected. You may also choose the clean time in 1 minute increments (for example 2 hours and 50 minutes) by pressing the number keypads **2 5 0**.

WARNING During the Self-Cleaning cycle, the outside of the range can become very hot to the touch. **DO NOT** leave small children unattended near the appliance.

CAUTION **DO NOT** force the oven door open. This can damage the automatic door locking system. Use care when opening the oven door after the Self-Cleaning cycle. Stand to the side of the oven when opening the door to allow hot air or steam to escape. The oven may still be **VERY HOT**.

INSTRUCTIONS

To start an immediate Self-Cleaning cycle or to set a delay start time of 9:00 o'clock and shut off automatically (example provided is a default 3 hour Self-Clean cycle):

1. Be sure the clock is set with the correct time of day, the oven is empty and the oven door is closed.
2. Press . "CLEAN" will flash, "3:00" (hours) and the Cooktop locked icon will show in the display (See Fig. 1). 2-4 hours of Self-Cleaning time may be chosen by pressing any amount of time from **2 0 0** (2 hours) through **4 0 0** (4 hours) in one minute increments. You may also skip the time entry and accept the default cleaning time of 3 hours by pressing the Start key pad (See Step 3).
3. Press . The "DOOR LOCKED" icon will flash; "CLEAN", Cooktop Lockout icon and the letters "CLn" will remain on in the display (Fig. 2).
4. As soon as the control is set, the motor driven oven door lock will begin to close automatically. Once the door has been locked the "DOOR LOCKED" indicator light will quit flashing and remain on. The Cooktop locked icon will remain on (Fig. 3).

PRESS

DISPLAY

2:00 to 4:00 using
number pads



Fig. 1





Fig. 2



Fig. 3



NOTE: If the optional delay Self-Clean feature is needed, finish steps 5-7. If Self-Clean is started immediately skip the remaining steps and continue with "When the Self-Clean cycle is done" on the following page.

5. Press  (See Fig. 4). Enter the desired Self-Clean starting time using the number pads **9 0 0** (See Fig. 5).
6. Press . "CLn" icon will turn off; "DELAY", "DOOR LOCKED", "CLEAN" and Cooktop locked icons will remain on.
7. The control will calculate forward from the set start time to determine when the Self-Cleaning cycle should end. The Self-Cleaning cycle will turn on automatically at the set time. At that time the icon "DELAY" will go out; the oven icon will come on, the start time, Cooktop locked icon, "CLEAN" and "CLn" will remain in the display (See Fig. 6).

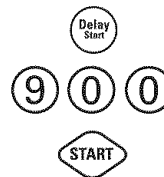

Fig. 4



Fig. 5



Fig. 6

Self-Cleaning

- Setting Flex Clean
- Setting Delay Flex Clean

INSTRUCTIONS

PRESS

DISPLAY

When the Self-Clean cycle is done:

1. The time of day, "DOOR LOCKED" and "CLEAN" icon will remain in the display.
2. Once the oven has cooled down for approximately 1 HOUR, and the "DOOR LOCKED" icon is no longer displayed, the oven door can then be opened.

Stopping or Interrupting a Self-Cleaning cycle:

If it becomes necessary to stop or interrupt a Self-Cleaning cycle due to excessive smoke or fire in the oven:

1. Press .
2. Once the oven has cooled down for approximately 1 HOUR and the "DOOR LOCKED" icon is no longer displayed, the oven door can then be opened (Fig. 7).



Fig.7

IMPORTANT NOTES when using the Self-Clean feature:

1. The Self-Clean feature will not operate whenever a radiant surface remains ON.
2. A Self-Clean cycle may be started if the appliance has the **Cooktop Lockout** active. A Self-Clean cycle cannot be started if **Oven Lockout** feature is active.
3. If a Self-Cleaning-Cycle has started but not finished and a power failure occurs, the appliance may not have thoroughly cleaned. Once power is restored, set for another Self-Clean cycle to finish.
4. If your clock is set for normal 12 hour display mode the Delay Self-Clean cycle can never be set to start more than 12 hours in advance. To set for Delay Flex-Clean 12-24 hours in advance see page 13 for instructions to set the control for the 24 hour time of day display mode.

Adjusting Oven Temperature

- How to adjust the oven temperature higher or lower

The temperature in the oven has been pre-set at the factory. When first using the oven, be sure to follow recipe times and temperatures. If you think the oven is too hot or too cool, the temperature in the oven can be adjusted. Before adjusting, test a recipe by using a temperature setting that is higher or lower than the recommended temperature. The baking results should help you to decide how much of an adjustment is needed.

Note: The oven temperature adjustments made with this feature will not change the Self-Clean cycle temperature.

INSTRUCTIONS

To adjust the oven temperature higher:

1. Press **Bake** for 6 seconds (Fig. 1).
2. To increase the temperature use the number pads to enter the desired change. (Example 30°F) **3** **0** (Fig. 2). The temperature may be increased as much as 35°F (19°C).
3. Press **START** to accept the temperature change and the display will return to the time of day (Fig. 3). Press **STOP Clear** to reject the change if necessary.

To adjust the oven temperature lower:

1. Press **Bake** for 6 seconds (Fig. 4).
2. To decrease the temperature use the number pads to enter the desired change. (Example -30°F) **3** **0** and then press **Flex Clean** (Fig. 5). The temperature may be decreased as much as 35°F (19°C).
3. Press **START** to accept the temperature change and the display will return to the time of day (Fig. 6). Press **STOP Clear** to reject the change if necessary.

PRESS



DISPLAY



Fig. 1



Fig. 2



Fig. 3



Fig. 4



Figure 5



Figure 6

General Care & Cleaning

Cleaning Table

Surfaces	How to Clean
Glass, Painted Plastic Body Parts & Control Knobs	<p>For general cleaning, use a soft cloth, clean with mild dish detergent & water or a 50/50 solution of vinegar & water. Follow by rinsing the area with clean water; dry & polish with a soft cloth. Glass cleaners may be used if sprayed on a soft cloth. DO NOT spray liquids directly on the control pad and display areas. DO NOT use large amounts of water on the control panel - excess water on the control area may cause damage to the appliance. DO NOT use other liquid cleaners, abrasive cleaners, scouring pads, or some paper towels - they will damage the finish.</p>
Painted Control Panels & Display areas	<p>Before cleaning the control panel, turn all controls to OFF & remove the control knobs. To remove, pull each knob straight off the shaft. Use the <i>general cleaning</i> instructions provided in the paragraph above.</p>
Porcelain Enamel Burner Grates, Cooktop Surface, Below Cooktop, Broiler Pan & Insert, Broiler Drawer, Door Liner & Oven Bottom	<p>Clean burner grates, broiler pan & insert in the dishwasher and dry upon removal. If soils are not removed, follow the cooktop cleaning instructions below.</p> <p>Gentle scouring with a soapy scouring pad will remove most spots. Rinse with a 1:1 solution of clean water & ammonia. <i>If necessary</i>, cover difficult spots with an ammonia-soaked paper towel for 30 to 40 minutes. Rinse with clean water and a damp cloth, then scrub with a soap-filled scouring pad. Rinse & wipe dry with a clean cloth. Remove all cleaners or the porcelain may become damaged during future heating. DO NOT use spray oven cleaners on the range top.</p>
Oven Racks	<p>Remove racks. See "Removing & Replacing Oven Racks" under Before Setting Oven Controls. Use a mild, abrasive cleaner, following the cleaner's recommendations. Rinse with clean water & let dry. After cleaning the racks, rub the sides of the racks with wax paper or a cloth containing a small amount of salad oil (this will make the racks glide easier into the oven rack positions).</p>
Oven Door	<p>Use soap & water to thoroughly clean the top, sides & front of the oven door. Rinse well. You may use a glass cleaner on the outside glass of the oven door. DO NOT immerse the door in water. DO NOT spray or allow water or the glass cleaner to enter the door vents. DO NOT use oven cleaners, cleaning powders or any harsh abrasive cleaning materials on the outside of the oven door. DO NOT clean the oven door gasket. The oven door gasket is made of a woven material, on Self-Cleaning models, which is essential for a good seal. Care should be taken not to rub, damage or remove this gasket.</p>
Stainless Steel	<p>Clean stainless steel with hot soapy water & a dishcloth. Rinse with clean water and a cloth. DO NOT use cleaners with high concentrations of chlorides or chlorines. DO NOT use harsh scrubbing cleaners. Only use kitchen cleaners that are especially made for cleaning stainless steel. Always be sure to rinse the cleaners from the surface as bluish stains may occur during heating that cannot be removed.</p>
Ceramic Cooktop	<p>See "Cooktop Cleaning & Maintenance" in this section for complete instructions.</p>

General Care & Cleaning

- Cooktop Cleaning & Maintenance
- Cleaning Recommendations for the Ceramic Glass Cooktop

Cooktop Cleaning & Maintenance

Consistent and proper cleaning is essential to maintaining your ceramic glass cooktop.

Prior to using your cooktop for the first time, apply the recommended CookTop® Cleaning Creme to the ceramic surface (on the web visit www.sears.com for replacement cooktop cleaner, item number 40079). Buff with a **non-abrasive** cloth or no-scratch cleaning pad. This will make cleaning easier when soiled from cooking. The special cooktop cleaning cream leaves a protective finish on the glass to help prevent scratches and abrasions.

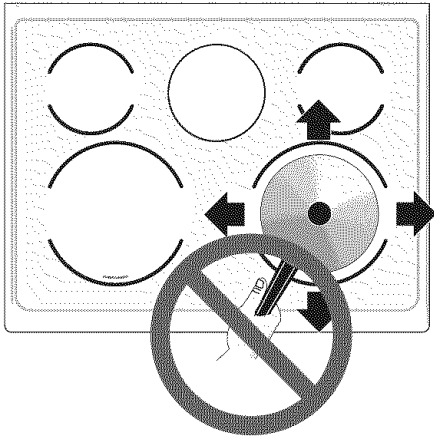

Sliding aluminum or copper clad bottom pans on the cooktop can cause metal markings on the cooktop surface. These marks should be removed **immediately** after the cooktop has cooled using the cooktop cleaning cream. Metal marks can become permanent if not removed prior to future use.

Cookware (cast iron, metal, ceramic or glass) with rough bottoms can mark or scratch the cooktop surface. **Do not slide anything metal or glass** across the cooktop. **Do not** use your cooktop as a cutting board or work surface in the kitchen. **Do not** cook foods directly on the cooktop surface without a pan. **Do not** drop heavy or hard objects on the glass cooktop, they may cause it to crack.

CAUTION Before cleaning the cooktop, be sure the controls are turned to **OFF** and the cooktop is **COOL**.

WARNING **DO NOT** use a cooktop cleaner on a hot cooktop. The fumes can be hazardous to your health, and can chemically damage the ceramic-glass surface.

Cleaning Recommendations for the Ceramic Glass Cooktop

For light to moderate soil:

Apply a few drops of CookTop® Cleaning Creme directly to the cooktop. Use a paper towel or use a **non-abrasive** plastic type no-scratch cleaning pad to clean the entire cooktop surface. Make sure the cooktop is cleaned thoroughly, leaving no residue.

For heavy, burned on soil:

Apply a few drops of CookTop® Cleaning Creme directly to the soiled area. Rub the soiled area using a **non-abrasive** plastic type no-scratch cleaning pad, applying pressure as needed. Do not use the pad you use to clean the cooktop for any other purpose.

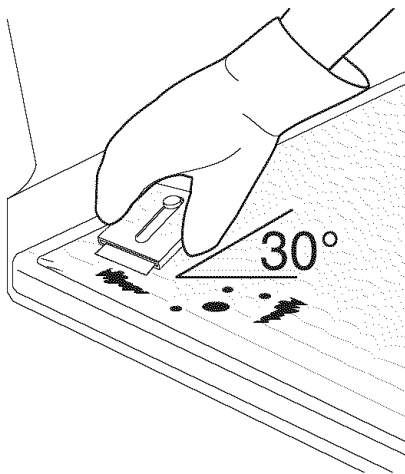

If soils remain, carefully scrape soils with a metal razor blade scraper, holding scraper at a 30 degree angle to the surface. Remove loosened soils with cooktop cleaning cream and buff surface clean.

IMPORTANT NOTE: Damage to the ceramic glass cooktop may occur if you use an abrasive type cleaning pad. Only use cleaning products that have been specifically designed for ceramic glass cooktops.

Plastic or foods with a high sugar content:

These types of soils need be removed immediately if spilled or melted onto the ceramic cooktop surface. Permanent damage (such as pitting of the cooktop surface) may occur if not removed **immediately**. After turning the surface elements **OFF**, use a razor blade scraper or a metal spatula with a mitt and scrape the soil from the hot surface (as illustrated). Allow the cooktop to cool, and use the same method for heavy or burned on soils.

General Care & Cleaning

- Cleaning Recommendations for the Ceramic Glass Cooktop (cont'd)
- Special Caution for Aluminum Use on the Ceramic Cooktop
- Removing & Replacing the Lift-Off Oven Door



Do not use the following on the ceramic glass cooktop:

- Do not use abrasive cleaners and scouring pads, such as metal and some nylon pads. They may scratch the cooktop, making it more difficult to clean.
- Do not use harsh cleaners, such as chlorine bleach, ammonia or oven cleaners, as they may etch or discolor the cooktop.
- Do not use dirty sponges, cloths or paper towels, as they can leave soil or lint on the cooktop which can burn and cause discoloration.

Special Caution for Aluminum Use on the Ceramic Cooktop:

- **Aluminum Foil** - Use of aluminum foil on a hot cooktop will damage the ceramic cooktop. Do not use thin aluminum cooking utensils or allow aluminum foil to touch the ceramic cooktop under ANY circumstances.
- **Aluminum utensils** - The melting point of aluminum is much lower than that of other metals. Care must be taken when aluminum pots or pans are used on the cooktop. If allowed to boil dry, not only will the utensil be destroyed, but it may fuse to, break or mark the ceramic glass surface, permanently damaging the cooktop surface.

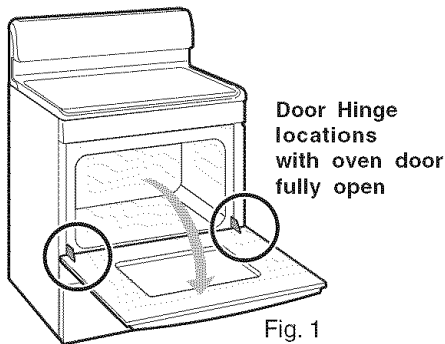

Fig. 1

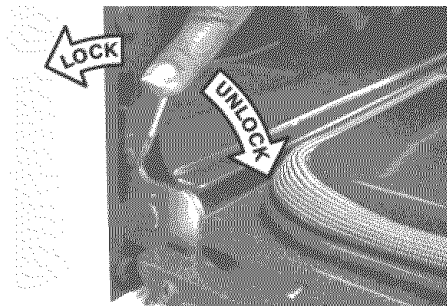

Fig. 2

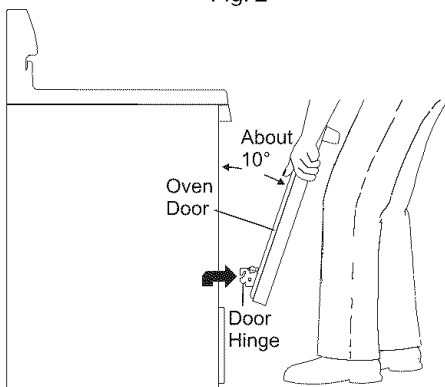

Fig. 3

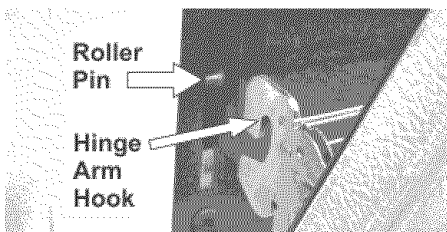

Fig. 4

Removing & Replacing the Lift-Off Oven Door

⚠ CAUTION The door is heavy. For safe, temporary storage, lay the door flat with the inside of the door facing down.

To Remove Oven Door:

1. Open oven door completely (horizontal with floor - See Fig. 1).
2. Pull the door hinge locks on both left and right door hinges down from the oven frame completely towards the oven door (See Fig. 2). A tool such as a small flat-blade screwdriver may be required.
3. Firmly grasp both sides of oven door along the door sides (Do not use the oven door handle - See Fig. 3).
4. Close the door to the broil stop position (the oven door will stop into this position just before fully closing).
5. With the oven door in the broil stop position, lift the oven door hinge arms over the roller pins located on each side of the oven frame (See Fig. 4).

To Replace Oven Door:

1. Firmly grasp both sides of oven door along the door sides (Do not use the oven door handle - See Fig. 3).
2. Holding the oven door at the same angle as the removal position, seat the hook of the hinge arm over the roller pins located on each side of the oven door frame (See Fig. 4). The hook of the hinge arms must be fully seated onto the roller pins.
3. Fully open the oven door (horizontal with floor - See Fig. 1).
4. Push the door hinge locks up towards and into the oven frame on both left and right oven door hinges (See Fig. 2) to the locked position.
5. Close the oven door.

Door Care Instructions - Most oven doors contain glass that can break. Read the following recommendations:

1. Do not close the oven door until all the oven racks are fully in place.
2. Do not hit the glass with pots, pans, or any other object.
3. Scratching, hitting, jarring or stressing the glass may weaken its structure causing an increased risk of breakage at a later time.

General Care & Cleaning

- Changing the Oven Light

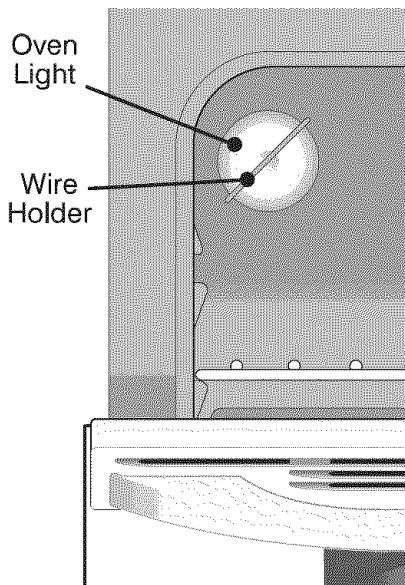

Changing the Oven Light

The oven light automatically turns ON when the door is opened. The oven light may also be manually operated by pressing the  pad.

The oven light bulb is located at the rear of the oven and is covered with a glass shield held by a wire holder. The glass shield must be in place whenever the oven is in use.

To replace the oven light bulb:

1. Turn electrical power off at the main source or unplug the range.
2. Press wire holder to one side to release the glass shield.
3. Replace bulb with a new 40 watt appliance bulb.
4. Replace glass shield over bulb and snap wire holder into place.
5. Turn power back on again at the main source (or plug the range back in).
6. The clock will then need to be reset. To reset, see **Setting the Clock and Minute Timer** in this Use & Care Guide.

CAUTION Be sure the range is unplugged and all parts are COOL before replacing oven light. Wear a leather-faced glove for protection against possible broken glass.

Care and Cleaning of Stainless Steel (some models)

Some models are equipped with stainless steel exterior parts. Special care and cleaning are **required** for maintaining the appearance of stainless parts. Refer to the **Care & Cleaning Table** for detailed cleaning instructions.

Before You Call

Solutions to Common Problems

Before you call for service, review the following list. It may save you time & expense. The list includes common occurrences (shown in bold) that are not the result of defective workmanship or materials in this appliance. The possible corrections to these problems are provided with the problem listed:

Range is not level - (1) Poor installation. Place oven rack in center of oven. Place a level on the oven rack. Adjust leveling legs at base of range until the oven rack is level. (2) Be sure floor is level, strong & stable enough to adequately support range. (3) If floor is sagging or sloping, contact a carpenter to correct the situation. (4) Kitchen cabinet alignment may make range appear not level. Be sure cabinets are square & have sufficient room for range clearance.

Cannot move appliance easily. Appliance must be accessible for service - (1) Cabinets not square or are built in too tightly. Contact builder or installer to make appliance accessible. (2) Carpet interferes with range. Provide sufficient space so range can be lifted over carpet.

Surface element too hot or not hot enough - Incorrect control setting. Be sure the correct control is ON for the element to be used.

Surface element does not heat - (1) Lightweight or warped pans used. Use only flat, evenly balanced, medium or heavyweight cookware. Flat pans heat better than warped pans. Cookware materials and weight of the material affect heating. Heavy & medium-weight pans heat evenly. Because lightweight pans heat unevenly, foods may burn easily. (2) No power to the appliance. Check steps under "**Entire Appliance Does Not Operate**" in this checklist. (3) Incorrect control setting. Make sure the correct control is ON for the surface element to be used.

Entire appliance does not operate - (1) The time of day is not set. The time of day **must** first be set in order to operate the oven. See "To Set the Clock" in the **Setting Oven Controls** section. (2) Make sure cord/plug is plugged correctly into outlet. (3) Service wiring is not complete. Call **1-800-4-MY-HOME®** for assistance (See back cover). (4) Electrical power outage. Check house lights to be sure. Call your local electric company for service.

Oven does not operate - Be sure the oven controls are set properly for the desired function. See **Setting Oven Controls** in this Use & Care Manual or read the instructions "**Entire appliance does not operate**" in this checklist.

Oven light does not work (some models) - Replace or tighten bulb. See **Changing Oven Light** section in this Use & Care Manual.

Oven control beeps and displays any "F" code error (for example F11) - Electronic control has detected a fault condition. Press **CLEAR/OFF** to clear the display & stop beeping. Reprogram oven. If fault recurs, record fault number. Press **CLEAR/OFF** & call **1-800-4-MY-HOME®** for assistance (See back cover).

Flames inside oven or smoking from oven vent - Excessive spillovers in oven. For example this will happen for pie spillovers or large amounts of grease left on the oven bottom. Wipe up excessive spillovers before starting oven. If flames or excessive smoke are present see "Broiling" in the **Setting Oven Controls** section.

Oven smokes excessively during broiling - (1) Control(s) not set properly. Follow Broil instructions under **Setting Oven Controls**. (2) Make sure oven door is opened to **broil stop position**. (3) Meat too close to the broil element. Reposition the broil rack to provide proper clearance between the meat & the element. Preheat the broil element for searing. (4) Meat not properly prepared. Remove excess fat from meat. Cut fatty edges to prevent curling, but do not cut into lean. (5) Insert on broiler pan wrong side up & grease not draining. Always place grid on the broiler pan with ribs up & slots down to allow grease to drip into pan (some models). (6) Grease has built up on oven surfaces. Regular cleaning is necessary when broiling frequently. Old grease or food spatters cause excessive smoking.

Poor baking results - Many factors affect baking results. Make sure the proper oven rack position is used. Center food in the oven & space pans to allow air to circulate. Allow the oven to preheat to the set temperature before placing food in the oven. Try adjusting the recipe's recommended temperature or baking time. If you feel the oven is too hot or cool, see **Adjusting Your Oven Temperature** in this Use & Care Manual.

Soil not completely removed after Self-Cleaning cycle - Failure to clean bottom, front top of oven, frame of oven or door area outside oven seal. These areas are not in the Self-Cleaning area, but get hot enough to burn on residue. Clean these areas before the Self-Cleaning cycle is started. Burned-on residue can be cleaned with a stiff nylon brush and water or a nylon scrubber. Be careful not to damage the oven gasket.

Self-Cleaning cycle does not work - (1) Oven control not set properly. Follow instructions under **Self-Cleaning**. (2) Self-Cleaning cycle was interrupted. Follow steps under "Stopping or Interrupting a Self-Cleaning Cycle" under **Self-Cleaning**.

Metal marks (Ceramic Cooktop models) - Sliding or scraping of metal utensils on cooktop surface. Do not slide metal utensils on cooktop surface. Use a ceramic-glass cooktop cleaning creme to remove the marks. See "Cooktop Cleaning and Maintenance" in the **Care & Cleaning** section.

Scratches or abrasions on cooktop surface (Ceramic Cooktop models) - (1) Coarse particles such as salt or sand between cooktop and utensils can cause scratches. Be sure cooktop surface and bottoms of utensils are clean before usage. Small scratches do not affect cooking and will become less visible with time. (2) Cleaning materials not recommended for ceramic-glass cooktop have been used. See "**Cooktop Cleaning & Maintenance**." (3) Cookware with rough bottom has been used. Use smooth, flat-bottomed cookware.

Brown streaks or specks on cooktop surface (Ceramic Cooktop models) - Boilovers are cooked onto surface. Use razor blade scraper to remove soil. See "Cooktop Cleaning and Maintenance" in the **Care & Cleaning** section.

Areas of discoloration with metallic sheen (Ceramic Cooktop models) - Mineral deposits from water and food. Remove using a ceramic-glass cooktop cleaning creme. Use cookware with clean, dry bottoms.

Recipes for Slow Cook

Slow Cook Turkey Breast

1 turkey breast
2 cups chicken broth
1 medium onion, sliced
2 teaspoons minced garlic
1 teaspoon salt
½ teaspoon pepper

In a roasting pan, place turkey breast meat-side up. Rub salt and pepper under the skin, and inside the cavity. Pour chicken broth around turkey breast, adding the onions and garlic. Cover roasting pan with lid or foil. Using the Slow Cook feature pad, set control on "Lo" setting for 7 to 8 hours, or the "Hi" setting for 4 to 5 hours. 4 to 6 servings.

Parmesan Green Beans and Potatoes

32oz frozen whole green beans
6 medium red potatoes, sliced
1 large onion, sliced
1 tablespoon seasoning salt
½ cup margarine
1 cup parmesan cheese, grated

Combine green beans, potatoes, onions, seasoning salt, margarine and parmesan cheese in large casserole dish. Cover with lid or aluminum foil.

Using the Slow Cook feature pad, set control on "Lo" setting for 7 to 8 hours, or the "Hi" setting for 4 to 5 hours. 4 to 6 servings.

Orange Surprise Cake

1 - pkg. orange cake mix
1 - 3.3oz pkg. white chocolate instant pudding
1 - 16oz. container sour cream
¾ cup vegetable oil
1 cup orange juice
4 eggs
1 - 9oz pkg. white chocolate pieces

Combine all ingredients, except white chocolate pieces. Blend well; then add white chocolate pieces. Pour mixture into a 5 quart oven safe dish coated with nonstick cooking spray.

Using the Slow Cook feature pad, set control on "Lo" setting for 5 to 6 hours, or the "Hi" setting for 3 to 4 hours. Spoon into bowl while still warm and serve with vanilla bean ice cream, or whipped cream.

4 to 6 servings.

Pork Chops with Potatoes

1 can (10 ¾ oz) cream of mushroom soup
¼ cup dry white wine
¼ cup Dijon mustard
1 teaspoon dry thyme, crushed
1 teaspoon garlic, minced
6 pork chops, cut ¾" thick
1 teaspoon pepper seasoning
1 teaspoon salt seasoning
1 tablespoon parsley
6 medium potatoes, sliced
1 medium onion, sliced

In a large mixing bowl, combine first 5 ingredients; blend well. In a roasting pan, spread potatoes and onions over the bottom of the pan. Pour soup mixture over potatoes and onions; topping

with the pork chops. Sprinkle pepper seasoning and parsley on top of pork chops. Cover pan with lid or aluminum foil and place on rack in the oven.

Using the Slow Cook feature pad, set control on "Lo" setting for 5 to 6 hours, or the "Hi" setting for 3 to 4 hours. 4 to 6 servings.

Apple Bread Pudding

5 cups sour dough bread cubes (½ ")
½ cup butter, melted
¾ cup brown sugar
½ teaspoon cinnamon
¼ teaspoon nutmeg
pinch of salt
4 to 5 cups apples, peeled and sliced thickly
1 cup raisins
1 cup walnuts, chopped

In large mixing bowl, combine all ingredients; blend well. Pour mixture into a 5quart oven safe dish. Cover with lid or aluminum foil and place on rack in oven.

Using the Slow Cook feature pad, set control on "Lo" setting for 5 to 6 hours, or the "Hi" setting for 3 to 4 hours. 4 to 6 servings.

Roast Beef with Vegetables

3 to 3 ½ lb sirloin tip roast
2 cups water
4 to 5 medium potatoes, quartered
1 lb. small carrots
2 large onion, quartered
4 garlic cloves
¼ cup worstershire sauce
salt
pepper

Center roast in large roasting pan. Add water. Spread potatoes, carrots, onions and garlic cloves evenly around roast. Pour worstershire sauce on top of roast. Sprinkle all with salt and pepper to taste. Cover with lid or aluminum foil.

Using the Slow Cook feature pad, set control on "Lo" setting for 5 to 6 hours, or the "Hi" setting for 3 to 4 hours. 4 to 6 servings.

Peach Cobbler

1 cup self rising flour
1 cup sugar
1 cup milk
½ cup butter, melted
1 lb. frozen peaches

In 5 quart oven safe dish, combine first four ingredients. Blend well. Stir in peaches. Place on rack in oven.

Using the Slow Cook feature pad, set control on "Lo" setting for 5 to 6 hours, or the "Hi" setting for 3 to 4 hours. 4 to 6 servings.

Get it fixed, at your home or ours!

Your Home

For repair – **in your home** – of **all** major brand appliances, lawn and garden equipment, or heating and cooling systems, **no matter who made it, no matter who sold it!**

For the replacement parts, accessories and owner's manuals that you need to do-it-yourself.

For Sears professional installation of home appliances and items like garage door openers and water heaters.

1-800-4-MY-HOME® (1-800-469-4663)

Call anytime, day or night (U.S.A. and Canada)

www.sears.com www.sears.ca

Our Home

For repair of carry-in items like vacuums, lawn equipment, and electronics, call or go on-line for the location of your nearest **Sears Parts & Repair Center.**

1-800-488-1222

Call anytime, day or night (U.S.A. only)

www.sears.com

To purchase a protection agreement (U.S.A.) or maintenance agreement (Canada) on a product serviced by Sears:

1-800-827-6655 (U.S.A.)

1-800-361-6665 (Canada)

Para pedir servicio de reparación a domicilio, y para ordenar piezas:

1-888-SU-HOGAR®

(1-888-784-6427)

Au Canada pour service en français:

1-800-LE-FOYER^{MC}

(1-800-533-6937)

www.sears.ca

The Sears logo is displayed in a large, bold, serif font. The word "Sears" is written in a dark color, with a thin, curved line underneath the letters "e" and "a".

® Registered Trademark / ™ Trademark / ™ Service Mark of Sears Brands, LLC

® Marca Registrada / ™ Marca de Fábrica / ™ Marca de Servicio de Sears Brands, LLC

^{MC} Marque de commerce / ^{MD} Marque déposée de Sears Brands, LLC

© Sears Brands, LLC