

Installation Instructions

27" Built In Wall Oven W/Microwave

JKP85

"If you have questions, call 800-GE-CARES or visit our website at www.GEAppliances.com"

CAUTION: Before you begin- read these instructions completely and carefully.

- **IMPORTANT-** Save these instructions for local inspector's use.
- **IMPORTANT-OBSERVE ALL GOVERNING CODES AND ORDINANCES.**
- **Note to Installer-** Be sure to leave these instructions with the Consumer.

- **Note to Consumer-** Keep these instructions for future reference.
- Installation of this Built-In Wall Oven w/ Microwave requires basic mechanical and electrical skills. Proper installation is the responsibility of the installer. Product failure due to improper installation is not covered under the GE Appliance Warranty.

Parts Included



8 screws (double)



Bottom Trim

Materials Needed

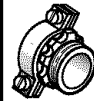

Strain Relief
Clamp

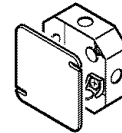
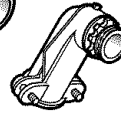

Junction
Box

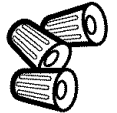

Wire Nuts



36" of String

Tools You Will Need

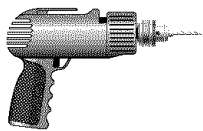

1/8" Drill Bit &
Electric or
Hand Drill



Phillips
Screwdriver

Installation Instructions

IMPORTANT SAFETY INSTRUCTIONS

For Your Safety

- Be sure your oven is installed properly by a qualified installer or service technician.
- Be sure the oven is securely installed in a cabinet that is firmly attached to the house structure. Weight on the oven door could cause the oven to tip and result in injury. Never allow anyone to climb, sit, stand or hang on the oven door.
- Make sure the cabinets and wall coverings around the oven can withstand the temperatures (up to 200°F.) generated by the oven.



CAUTION: The electrical power to the oven supply line must be shut off while line connections are being made. Failure to do so could result in serious injury or death.

Electrical Requirements

This appliance must be supplied with the proper voltage and frequency, and connected to an individual properly grounded branch circuit, protected by a circuit breaker or fuse having amperage as noted on rating plate. (Rating Plate is located on the wall inside the microwave oven.)

We recommend you have the electrical wiring and hookup of your oven connected by a qualified electrician. After installation, have the electrician show you where your main oven disconnect is located.

Check with your local utilities for electrical codes which apply in your area. Failure to wire your oven according to governing codes could result in a hazardous condition. If there are not local codes, your range must be wired and fused to meet the requirements of the National Electrical Code, ANSI/NFPA No. 70-Latest Edition. You can get a copy by writing:

National Fire Protection Association
Battery March Park
Quincy, MA 02269

Effective January 1, 1996, the National Electrical Code requires that new, but not existing, construction utilize a 4 conductor connection to an electric range. When installing an electric range in new construction, follow the instructions in **NEW CONSTRUCTION AND FOUR CONDUCTOR BRANCH CIRCUIT CONNECTION.**

You must use a three-wire, single-phase AC 208Y/120 Volt or 240/120 Volt, 60 hertz electrical system. If you connect to aluminum wiring, properly installed connectors approved for use with aluminum wiring must be used.

Installation Instructions



Pre- Installation Checklist

Remove packaging materials.

Check inside microwave, behind hinges, and under false bottom. Remove labels on door, plastic on trims and panel, and all tape around oven.

- Open oven door and remove literature prepack, broiler pan and grid, and oven racks. Open microwave door and remove shelves and turntable package.

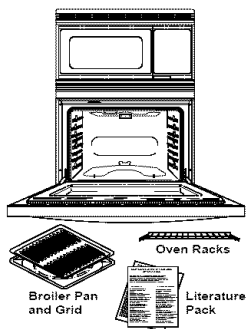

- Remove Installation Instruction from literature prepack and read them carefully before you begin. Be sure to place all literature, Use and Care, Installations, etc. in a safe place for future reference.



Remove the Oven Door

Open the oven door to the stop broil position.



DO NOT LIFT THE DOOR BY THE HANDLE!

- Grasp the door on both sides and lift up and off the hinges.

NOTE: The oven door is very heavy. Be sure you have a firm grip before lifting the oven door off the hinges. Use caution once the door is removed. Do not lay the door on its handle. This could cause dents or scratches.

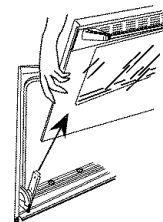

- Cover hinge with paper towel rolls or toweling.

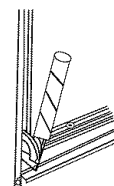

CAUTION: When the door is removed and the hinge arms are at the stop position, **DO NOT** bump or try to move the hinge arms. The hinges could snap back causing an injury to the hands. Cover the hinges with toweling or empty towel rolls while working in the oven area.

Installation Instruction



Pre- Installation Checklist cont.



Place the Oven on a Platform

Place the oven on a table or platform even with the cutout opening. (Platform must support 225 lbs.)

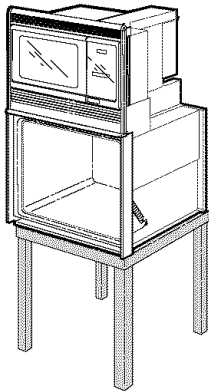

Remove the Bottom Trim

Remove the bottom trim from the top of the oven. It will be installed at the end of installation. The trim is wrapped separately and taped to the top of the unit.

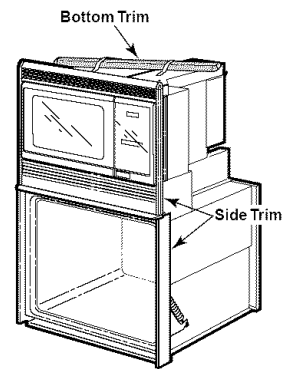

Installation Instructions

A Cutout for Built-In Oven W/Microwave

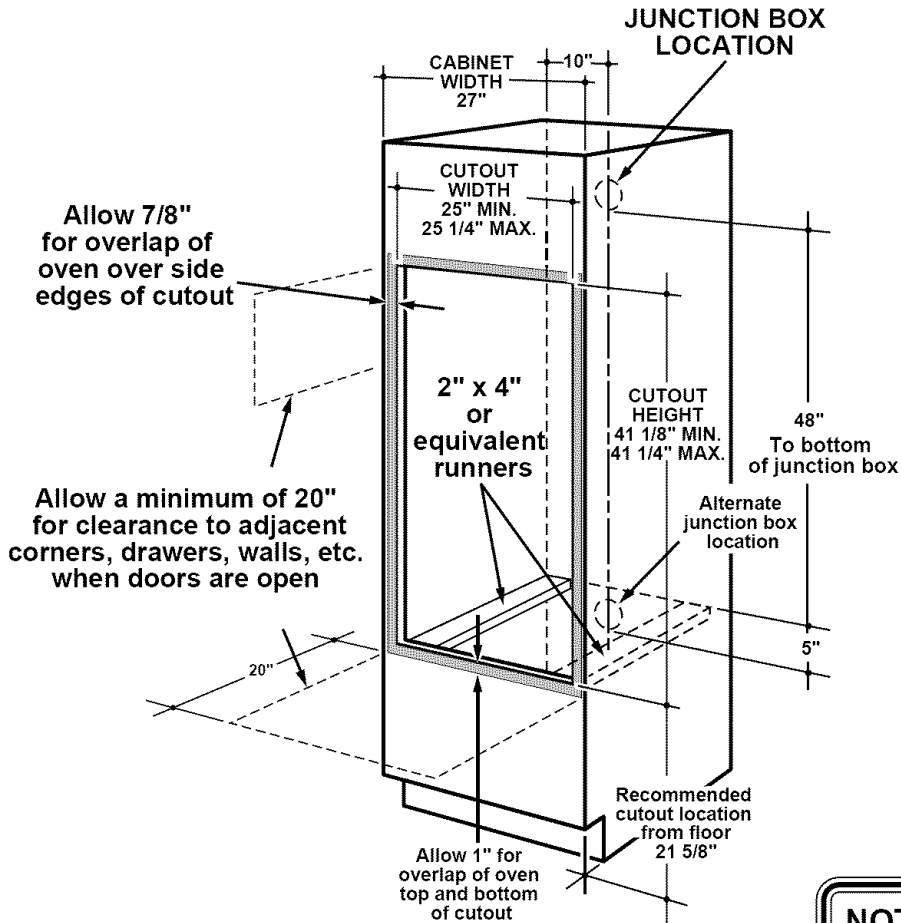

- Cabinet Width 27"
- Recommended Cutout Location From Floor 21 5/8"
- Cutout Depth . 23 1/2"
- Cutout Width .. 25" Min. 25 1/4" Max.
- Cutout Height 41 1/8" Min. 41 1/4" Max.
- Overall Height 41 5/8"
- Overall Width .. 26 5/8"

Allow 7/8" for overlap of oven over side edges of cutout

Allow a minimum of 20" for clearance to adjacent corners, drawers, walls, etc. when doors are open

Allow 1" for overlap of oven top and bottom of cutout

NOTE: If the cabinet does not have a front frame and the sides are less than 3/4" thick, shim both sides equally to establish the cutout width.

If the cabinets do not have a solid bottom, then two braces or runners must be installed to support the weight of the oven. The runners and braces must support 275 pounds.

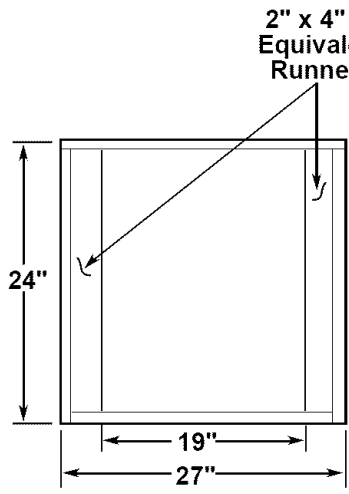

NOTE: If using equivalent runners, then the center of the equivalent runners should be 20 1/2".

Installation Instructions

B Electrical Connections

B1 Turn off the circuit breaker or remove fuses to the oven branch circuit.

B2 With the oven in front of the cabinet opening on a table or platform, connect the flexible conduit to the electrical junction box as shown below. **You will need to purchase a strain relief clamp to complete the connection of the conduit to the junction box.**

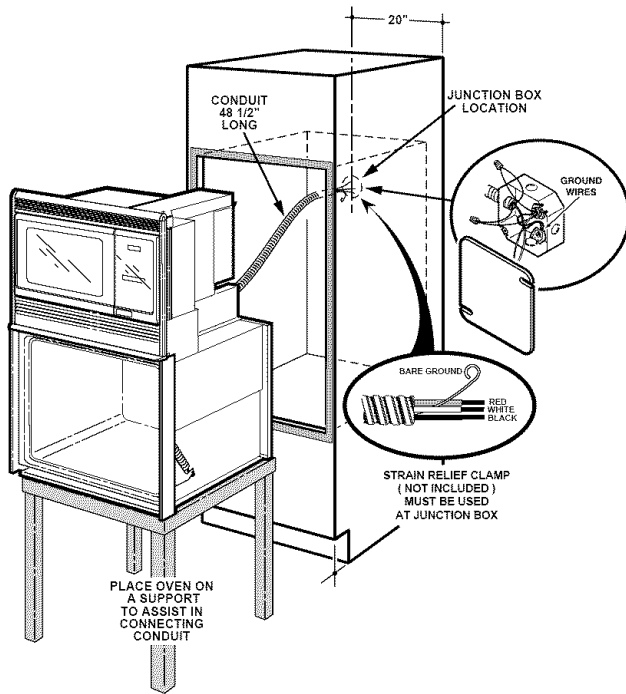

B3 New Construction and Four-Conductor Branch Circuit Connection

- When installing in a new construction, or
- When installing oven in a mobile home, or
- When local codes do not permit grounding through neutral:

a. Cut the neutral (White) lead from the crimp. Re-strip the neutral (white) lead to expose the proper length of conductor.

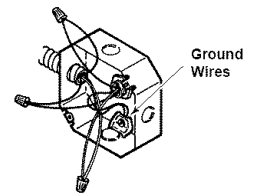

b. Attach the appliance grounding lead (green or bare copper) in accordance with local codes. If the residence grounding conductor is aluminum, see WARNING note on the following page.

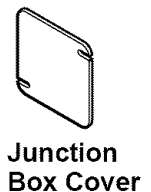

c. Connect the oven neutral (white) lead to the branch circuit neutral (white or gray) in accordance with local codes.

d. Connect the oven red lead to the branch circuit red lead and the oven black lead to the branch circuit black lead in accordance with local codes. If the residence red, black or white leads are aluminum conductors, see "WARNING" note on the following page.

e. Install the Junction Box Cover.

OR

Installation Instructions

B Electrical Connections cont.

B4 Three-Conductor Branch Circuit Connection

When connecting to a 3-conductor branch circuit, if local codes permit:

- a. Connect the bare oven ground conductor with the crimped neutral (white) lead to the branch circuit neutral (white or gray in color).
- b. The oven red lead to the branch circuit red lead.
- c. The oven black lead to the branch circuit black lead in accordance with local codes.
- d. Install Junction Box Cover.

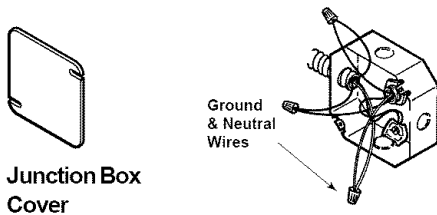

NOTE TO ELECTRICIAN: The 3 power leads supplied with this appliance are UL recognized for connection to larger gauge household wiring. The insulation of these 3 leads is rated at temperatures much higher than the temperature rating of household wiring. The current carrying capacity of the conductor is governed by the temperature rating of the insulation around the wire, rather than the wire gauge alone.

WARNING: Improper connection of aluminum house wiring to copper leads can result in an electrical hazard or fire. Use only connectors designed for joining copper to aluminum and follow the manufacturer's recommended procedure closely.

Do not shorten this flexible conduit. The conduit strain relief clamp must be securely attached to the junction box and the flexible conduit must be securely attached to the clamp. If the flexible conduit will not fit within the clamp, do not install the oven until a clamp of the proper size is obtained.

Installation Instructions

C Placing the Oven In the Opening

C1 Sliding the Oven Into the Opening.

- Loop a 36" string around the conduit before the oven is slid into place. This will keep the conduit from falling behind the oven.

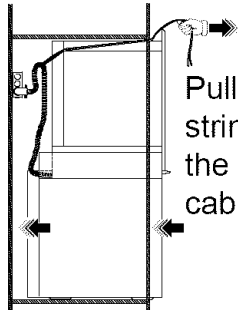

Pull out on the string while pushing the oven into the cabinet.

- Lift oven into cabinet cutout using the oven opening as an grip. Carefully push against oven front frame. Do not push against outside edges.
- As the oven is slid back, pull the string so that the conduit will lie behind the oven in a natural loop.
- When you are sure the conduit is out of the way, slide the oven 3/4 the way back into the opening. Remove the string.

C2 Installing the Bottom Trim

- Slide the oven 3/4 way into the cabinet cutout.
- Attach the bottom trim to the front frame with the 3 screws provided.
- Slide the oven all the way into the cabinet cutout.

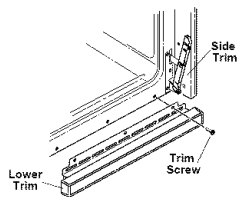

Caution: Be sure you do not tip the oven forward during installation or you may bend the bottom trim. The bottom trim provides an opening for cooling air to enter the cabinet. This opening should never be blocked.

C3 Drilling the Pilot Holes

NOTE: Before drilling the pilot holes, make sure the oven is pushed as far back into the opening as it will go, and that it is centered.

- Drill four-1/8" pilot holes through the mounting holes (top and bottom) of the side trim, for the four #8 screws provided.

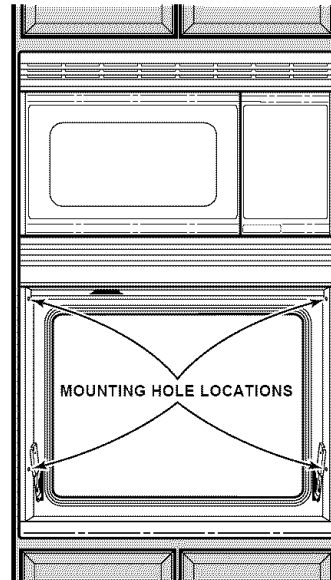

The screws must be a minimum of 1/4" from the front edge of the cutout.

NOTE: Mounting screws must be used. Failure to do so could result in the oven falling out of the cabinet causing serious injury.

- Secure the Oven to Cabinet with screws provided.

NOTE: If the cabinet is particle board, you must use 4 #8 x 3/4" particle board screws. These may be purchased at any hardware store.

Installation Instructions

D Replacing the Oven Door

- D1** Make sure the hinge is in the door stop position.
- D2** Remove the toweling or paper towel holder from the hinge.
- D3** Grasp the door on both sides.
- D4** Hold the door over the hinges aligning the hinges with the hinge slots on the bottom of the door.
- D5** Slide the door down onto the hinges as far as it will go.
- D6** Close the door.

The oven door is heavy. You may need help lifting the door high enough to slide it down onto the hinges. Do not lift the door by the handle.

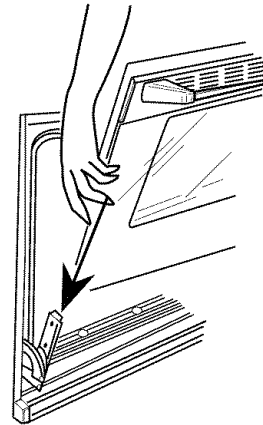

Installation Instruction



PRE-TEST CHECK LIST



Remove all protective film if present, and any stickers.



Check to be sure that all wiring is secure and not pinched or in contact with moving parts.



Check that the bottom trim is installed properly (see page 7).



Check to be sure the mounting screws are installed and flush with the side trim, (see page 7).



Operation Checklist



Remove all items from the inside of the oven.



Turn on the power to the oven. (Refer to your Use and Care Manual.) Verify that the bake and broil units, and all cooking functions operate properly.



Check that the circuit breaker is not tripped or the house fuse is blown.



Check that conduit is securely connected to the junction box.



See Use & Care manual for troubleshooting list.



NOTE TO ELECTRICIAN:

The power leads supplied with this appliance are UL recognized for connections to larger gauge household wiring. The insulation of these leads is rated at temperatures much higher than the temperature rating of household wiring. The current carrying capacity of a conductor is governed by the wire gauge and also the temperature rating of the insulation around the wire.

NOTE: ALUMINUM WIRING

A. WARNING:

IMPROPER CONNECTION OF ALUMINUM HOUSE WIRING TO THE COPPER LEADS CAN RESULT IN A SERIOUS PROBLEM.

B. Splice copper wires to aluminum wiring using special connectors designed and UL approved for joining copper to aluminum and follow the manufacturer's recommended connector procedure closely.

NOTE: Wire used, location and enclosure of splices, etc., must conform to good wiring practice and local codes.

NOTES
