

2.1 CH Stylish Home Theater System HT-Q100

SAMSUNG ELECTRONICS AMERICA, INC.

SERVICE DIVISION
400 Valley Road, Suite 201
Mount Arlington, NJ 07856
1-800-SAMSUNG (1-800-726-7864)
www.samsung.com

Instruction Manual

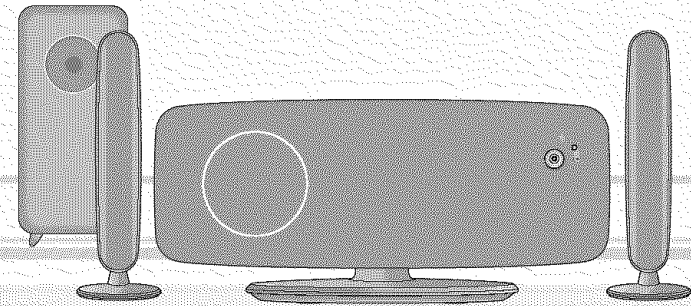

AH68-01851R



Safety Warnings

**CLASS 1 LASER PRODUCT
KLASSE 1 LASER PRODUKT
LUOKAN 1 LASER LAITE
KLASS 1 LASER APPARAT
PRODUCTO LASER CLASE 1**



CAUTION:
TO REDUCE THE RISK OF ELECTRIC SHOCK, DO NOT REMOVE REAR COVER. NO USER SERVICEABLE PARTS INSIDE. REFER SERVICING TO QUALIFIED SERVICE PERSONNEL.

Note to CATV system installer :

This reminder is provided to call the CATV system installer's attention to Section 820-40 of the NEC which provides guidelines for proper grounding and, in particular, specifies that the cable ground shall be connected to the grounding system of the building, as close to the point of cable entry as practical

CLASS 1 LASER PRODUCT

This Compact Disc player is classified as a CLASS 1 LASER product.

Use of controls, adjustments or performance of procedures other than those specified herein may result in hazardous radiation exposure.

CAUTION-INVISIBLE LASER RADIATION WHEN OPEN AND INTERLOCKS DEFEATED, AVOID EXPOSURE TO BEAM.



This symbol indicates that dangerous voltage which can cause electric shock is present inside this unit.



This symbol alerts you to important operating and maintenance instructions accompanying the unit.

WARNING: To reduce the risk of fire or electric shock, do not expose this appliance to rain or moisture.

CAUTION: TO PREVENT ELECTRIC SHOCK, MATCH WIDE BLADE OF PLUG TO WIDE SLOT, FULLY INSERT.

Precautions

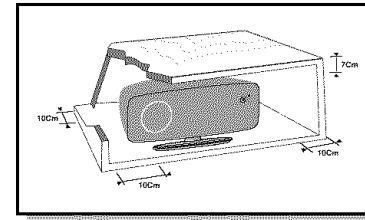

Ensure that the AC power supply in your house complies with the identification sticker located on the back of your player. Install your player horizontally, on a suitable base (furniture), with enough space around it for ventilation (3-4inches). Make sure the ventilation slots are not covered. Do not stack anything on top of the player. Do not place the player on amplifiers or other equipment which may become hot. Before moving the player, ensure the Disc Insert Hole is empty. This player is designed for continuous use. Switching off the Home Theater to the stand-by mode does not disconnect the electrical supply. In order to disconnect the player completely from the power supply, remove the main plug from the wall outlet, especially when left unused for a long period of time.

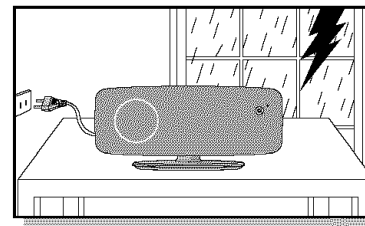
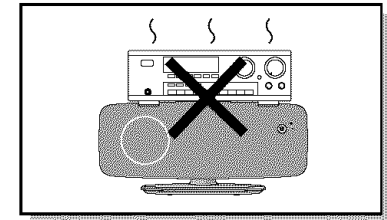

During thunderstorms, disconnect AC main plug from the wall outlet. Voltage peaks due to lightning could damage the unit.

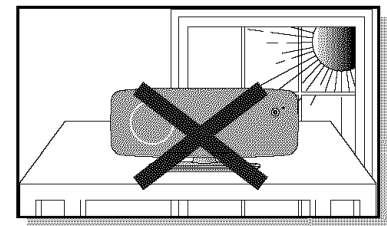

Do not expose the unit to direct sunlight or other heat sources. This could lead to overheating and malfunction of the unit.

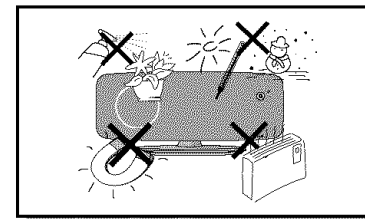

Protect the player from moisture (i.e. vases), and excess heat (e.g. fireplace) or equipment creating strong magnetic or electric fields (i.e. speakers...). Disconnect the power cable from the AC supply if the player malfunctions. Your player is not intended for industrial use. Use of this product is for personal use only. Condensation may occur if your player or disc has been stored in cold temperatures. If transporting the player during the winter, wait approximately 2 hours until the unit has reached room temperature before using.

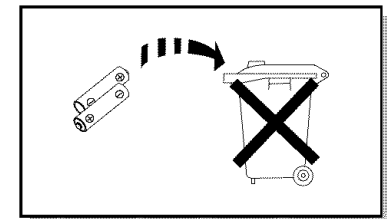

The batteries used with this product contain chemicals that are harmful to the environment. Do not dispose of batteries in the general household trash.

Safety Instructions

READ INSTRUCTIONS

All the safety and operating instructions should be read before the appliance is operated.

RETAIN INSTRUCTIONS

The safety and operating instructions should be retained for future reference.

HEED WARNINGS

All warnings on the appliance and in the operating instructions should be adhered to.

FOLLOW INSTRUCTIONS

All operating and use instructions should be followed.

WATER AND MOISTURE

Do not use this video product near water—for example, near a bathtub, wash bowl, kitchen sink, or laundry tub, in a wet basement, or near a swimming pool, and the like.

OVERLOADING

Do not overload wall outlets and extension cords as this can result in the risk of fire or electric shock.

VENTILATION

Slots and openings in the cabinet are provided for ventilation and to ensure reliable operation of the video product and to protect it from overheating these openings must not be blocked or covered. The openings should never be blocked by placing the video product on a bed, sofa, rug, or other similar surface. This video product should never be placed near or over a radiator or heat register.

This video product should not be placed in a built-in installation such as a bookcase or rack unless proper ventilation is provided or the manufacturer's instructions have been followed.

POWER CORD PROTECTION

Power-supply cords should be routed so that they are not likely to be walked on or pinched by items placed upon or against them paying particular attention to cords at plugs, convenience receptacles, and the point where they exit from the appliance.

CLEANING

Unplug this video product from the wall outlet before cleaning. Do not use liquid cleaners or aerosol cleaners. Use a damp cloth for cleaning.

LIGHTNING

For added protection of this video product receiver during a lightning storm, or when it is left unattended and unused for long periods of time, unplug it from the wall outlet and disconnect the antenna or cable system. This will prevent damage to the video product due to lightning and power-line surges.

OBJECT AND LIQUID ENTRY

Never push objects of any kind into this product through openings as they may touch dangerous voltage points or short-out parts that could result in a fire or electric shock.

Never spill liquid of any kind on the video product.

ACCESSORIES

Do not place this video product on an unstable cart, stand, tripod, bracket, or table.

The video product may fall, causing serious injury to a child or adult, and serious damage to the appliance.

Use only with a cart, stand, tripod, bracket, or table recommended by the manufacturer, or sold with the video product. Any mounting of the appliance should follow the manufacturer's instructions and should use a mounting accessory recommended by the manufacturer.

CART

An appliance and cart combination should be moved with care. Quick stops, excessive force, and uneven surfaces may cause the appliance and cart combination to overturn.

POWER SOURCES

This video product should be operated only from the type of power source indicated on the marking label. If you are not sure of the type of supply to your home, consult your appliance dealer or local power company. For video products intended to be operated from battery power, or other sources, refer to the operating instructions.

POWER LINES

An outside antenna system should not be located in the vicinity of overhead power lines or other electric light or power circuits, or where it can fall into such power lines or circuits. When installing an outside antenna system, extreme care should be taken to keep from touching such power lines or circuits as contact with them might be fatal.

POLARIZATION

This video product is equipped with a polarized alternating current line plug (a plug having one blade wider than the other.) This plug will fit into the power outlet only one way. This is a safety feature. If you are unable to insert the plug fully into the outlet, try reversing the plug. If the plug should still fail to fit, contact your electrician to replace your obsolete outlet. Do not defeat the safety purpose of the polarized plug.

OUTDOOR ANTENNA GROUNDING

- If an outside antenna is connected to the antenna terminal, be sure the antenna system is grounded so as to provide some protection against voltage surges and built-up static charges.
- In the U.S.A section 810 of the National Electrical Code, ANSI/NFPA No. 70-1984, provides information with respect to proper grounding of the mast and supporting structure, grounding of the lead-in wire to an antenna discharge unit, size of grounding conductors, location of antenna discharge unit, connection to grounding electrodes, and requirements for the grounding electrode. See the figure below.

ATTACHMENTS

Do not use attachments not recommended by the video product manufacturer as they may cause hazards.

SERVICING

- Do not attempt to service this product yourself as opening or removing covers may expose you to dangerous voltage or other hazards.
- Refer all servicing to qualified service personnel.

REPLACEMENT PARTS

When replacement parts are required, be sure the service technician has used replacement parts specified by the manufacturer or having the same characteristics as the original part. Unauthorized substitutions may result in fire, electric shock or other hazards.

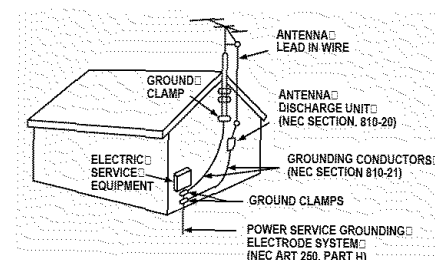

SAFETY CHECK

Upon completion of any service or repairs to this video product, ask the service technician to perform safety checks to determine that the video product is in proper operating condition.

DAMAGE REQUIRING SERVICE

- Unplug this video product from the wall outlet and refer servicing to qualified service personnel under the following conditions.
- When the power-supply cord or plug is damaged.
 - If liquid has been spilled, or objects have fallen into the video product.
 - If the video product has been exposed to rain or water.
 - If the video product does not operate normally by following the operating instructions. Adjust only those controls that are covered by the operating instructions as an improper adjustment of other controls may result in damage and will often require extensive work by a qualified technician to restore the video product to its normal operation.
 - If the video product has been dropped or the cabinet has been damaged.
 - When the video product exhibits a distinct change in performance - this indicates a need for service.

HEAT

This video unit should be situated away from heat sources such as radiators, stoves, or other products (including amplifiers) that produce heat.

Features

● Multi-Disc Playback & FM Tuner

The HT-Q100 combines the convenience of multi-disc playback capability, including DVD-AUDIO, DVD-VIDEO, CD, MP3-CD, WMA-CD, DivX, CD-R/RW, and DVD-R/RW, with a sophisticated FM tuner, all in a single player.

● DVD-Audio compatible

Experience the super high-quality audio performance of DVD-Audio. The on-board 24-bit/192kHz DAC enables this player to deliver exceptional sound quality in terms of dynamic range, low-level resolution and high-frequency detail.

● TV Screen Saver Function

The HT-Q100 automatically brightens and darkens your TV screen after 3 minutes in the stop mode. The HT-Q100 automatically switches itself into the power saving mode after 20 minutes in the screen saver mode.

● Power Saving Function

The HT-Q100 automatically shuts itself off after 20 minutes in stop mode.

● Customized TV Screen Display

The HT-Q100 allows you to select your favorite image during JPEG and DVD playback and set it as your background wallpaper.

● HDMI

HDMI transmits DVD video and audio signals simultaneously, and provides a clearer picture.

● AV SYNC Function

Video may lag behind the audio if the unit is connected to a digital TV. To compensate for this, you can adjust the audio delay time to sync up with the video.

Contents

● PREPARATION

Safety Warnings	1
Precautions	2
Safety Instructions	3
Features	5
Notes on Discs	7
Description	9

● CONNECTIONS

Before Connecting the Speakers	13
Installing the DVD player	15
Connecting the Video Out to TV	16
HDMI Function	17
Connecting External Components	19
Connecting the FM Antenna	20

● OPERATION

Before Using Your Home Theater	21
Disc Playback	24
MP3-CD Playback	25
Displaying Disc Information	26
JPEG File Playback	27
DivX Playback	29
Checking the Remaining Time	31
Fast/Slow Playback	32
Skipping Scenes/Songs	32
Repeat Playback	33
A-B Repeat Playback	34
Step Function	35
Zoom (Screen Enlarge) Function	36
EZ VIEW Function	36
Bonus Group / Navigating Pages	37
Selecting Audio/Subtitle Language	38
Playing Media Files using the USB HOST feature	39
Moving Directly to a Scene/Song	41
Using Disc Menu	42
Using the Title Menu	42

● SETUP

Setting the Language	43
Setting TV Screen type	45
Setting Parental Controls (Rating Level)	47
Setting the Password	48
Setting the Wallpaper	49
DVD Playback Mode	51
Setting the DRC (Dynamic Range Compression)	52
AV SYNC Setup	53

● RADIO OPERATION

Listening to Radio	54
Presetting Stations	55

● MISCELLANEOUS

Convenient Functions	57
Operating a TV with the Remote Control	59
Before Calling for Service	61
Cautions on Handling and Storing Discs	63
Language Code List	64
USB Host Feature Supported Products	65
Specifications	66

Notes on Discs



DVD (Digital Versatile Disc) offers fantastic audio and video, thanks to Dolby Digital surround sound and MPEG-2 video compression technology. Now you can enjoy these realistic effects in the home, as if you were in a movie theater or concert hall.



DVD players and the discs are coded by region. These regional codes must match in order for the disc to play. If the codes do not match, the disc will not play.

The Region Number for this player is given on the rear panel of the player.
(Your DVD player will only play DVDs that are labeled with identical region codes.)

Playable Discs

Disc Type	Mark (Logo)	Recorded Signals	Disc Size	Max. Playing Time
DVD		Audio + Video	5"	Approx. 240 min. (single-sided) Approx. 480 min. (double-sided)
			3 1/2"	Approx. 80 min. (single-sided) Approx. 160 min. (double-sided)
AUDIO-CD		Audio	5"	74 min.
			3 1/2"	20 min.
DivX		MPEG4 MP3	5"	74 min.
			3 1/2"	20 min.

Do not use the following types of disc!

- LD, CD-G, CD-I, CD-ROM and DVD-ROM discs cannot be played on this player. If such discs are played, a "WRONG DISC FORMAT" message appears on the TV screen.
- DVD discs purchased abroad may not play on this player. If such discs are played, a "WRONG REGION CODE" message appears on the TV screen.

Copy Protection

- Many DVD discs are encoded with copy protection. Because of this, you should only connect your DVD player directly to your TV, not to a VCR. Connecting to a VCR results in a distorted picture from copy-protected DVD discs.
- This product incorporates copyright protection technology that is protected by methods claims of certain U.S. patents and other intellectual property rights owned by Macrovision Corporation and other rights owners. Use of this copyright protection technology must be authorized by Macrovision Corporation, and is intended for home and other limited viewing uses only unless otherwise authorized by Macrovision Corporation. Reverse engineering or disassembly is prohibited.

Disc Recording Format

- This product does not support Secure (DRM) Media files.

CD-R Discs

- Some CD-R discs may not be playable depending on the disc recording device (CD-Recorder or PC) and the condition of the disc.
- Use a 650MB/74 minute CD-R disc.
Do not use CD-R disc over 700MB/80 minute as it may not be play back.
- Some CD-RW (Rewritable) media, may not be playable.
- Only CD-Rs that are properly "closed" can be fully played. If the session is closed but the disc is left open, you may not be able to fully play the disc.

CD-R MP3 Discs

- Only CD-R discs with MP3 files in ISO 9660 or Joliet format can be played.
- MP3 file names should be 8 characters or less in length and contain no blank spaces or special characters (. / = +).
- Use discs recorded with a compression/decompression data rate greater than 128Kbps.
- Only files with the ".mp3" and ".MP3" extensions can be played.
- Only a consecutively written Multisession disc can be played. If there is a blank segment in the Multisession disc, the disc can be played only up to the blank segment.
- If the disc is not closed, it will take longer to begin playback and not all of the recorded files may be played.
- For files encoded in Variable Bit Rate (VBR) format, i.e. files encoded in both low bit rate and high bit rate (e.g., 32Kbps ~ 320Kbps), the sound may skip during playback.
- A maximum of 500 tracks can be played per CD.
- A maximum of 300 folders can be played per CD.

CD-R JPEG Discs

- Only files with the ".jpeg" and ".JPEG" extensions can be played.
- If the disc is not closed, it will take longer to start playing and not all of the recorded files may be played.
- Only CD-R discs with JPEG files in ISO 9660 or Joliet format can be played.
- JPEG file names should be 8 characters or less in length and contain no blank spaces or special characters (. / = +).
- Only a consecutively written multisession disc can be played. If there is a blank segment in the multisession disc, the disc can be played only up to the blank segment.
- A maximum of 9,999 images can be stored on a single CD.
- When playing a Kodak/Fuji Picture CD, only the JPEG files in the picture folder can be played.
- Picture discs other than Kodak/Fuji Picture CDs may take longer to start playing or may not play at all.

CD-R/RW DivX Discs

- Since this product only provides encoding formats authorized by DivX Networks, Inc., a DivX file created by the user might not be played.
- Software update for unsupported formats is not supported.
(Example: QPEL, GMC, resolution higher than 720 x 480 pixels, etc.)
- Sections with high frame rate might not be played while playing a DivX file.
- For more information about the formats authorized by DivX Networks, Inc., visit "www.divxnetworks.net".

Description

—Front Panel—

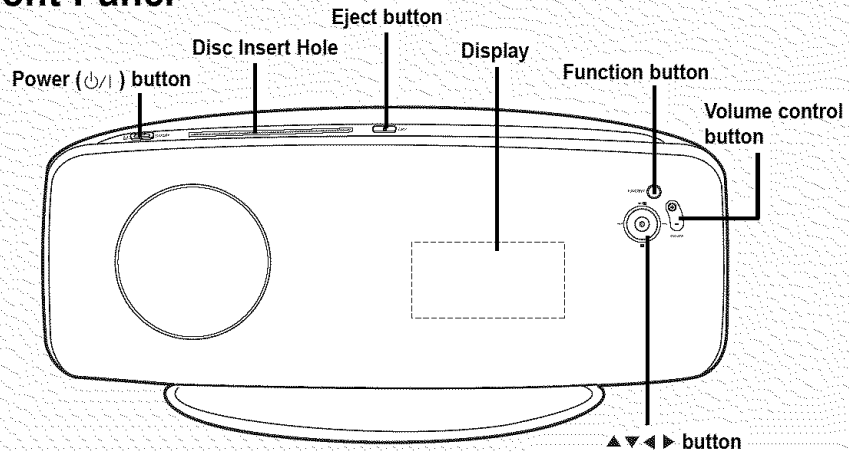

- Play/Pause (▶||) button
- Stop (■) button
- Tuning up & Skip (▶▶) button
- Tuning down & Skip (◀◀) button

—Rear Panel—

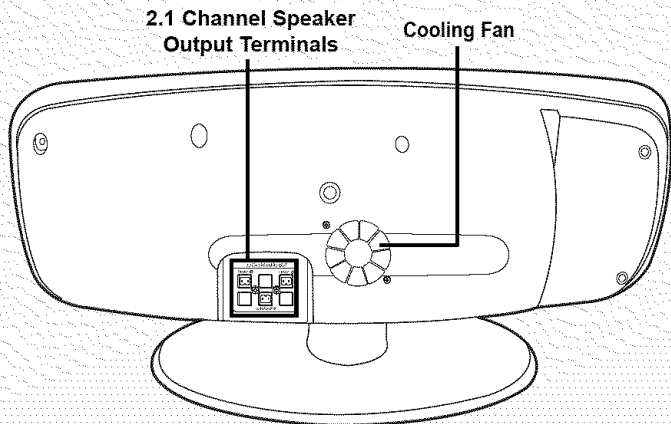

—Side Panel—

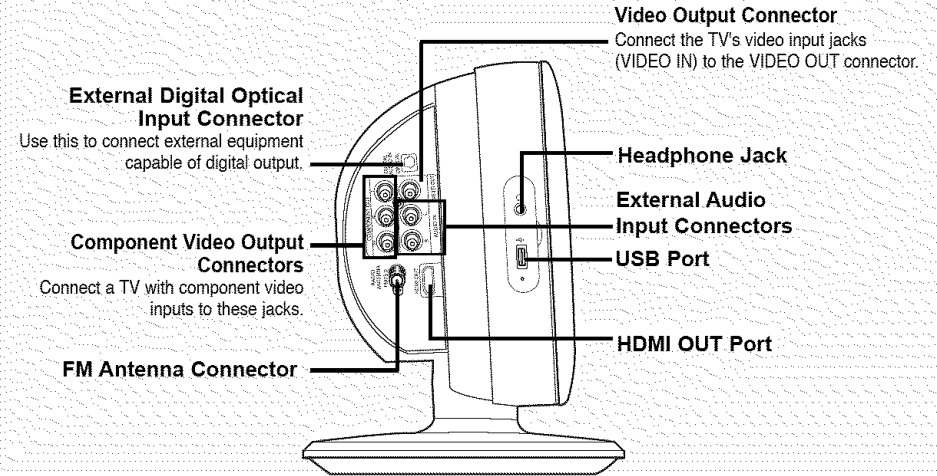

Accessories

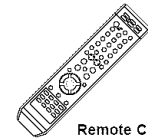

Remote Control
(AH59-01643J)



Video Cable
(AH39-40001V)



FM Antenna
(AH42-00017A)



User's Manual
(AH68-01851R)

Description

—Remote Control—

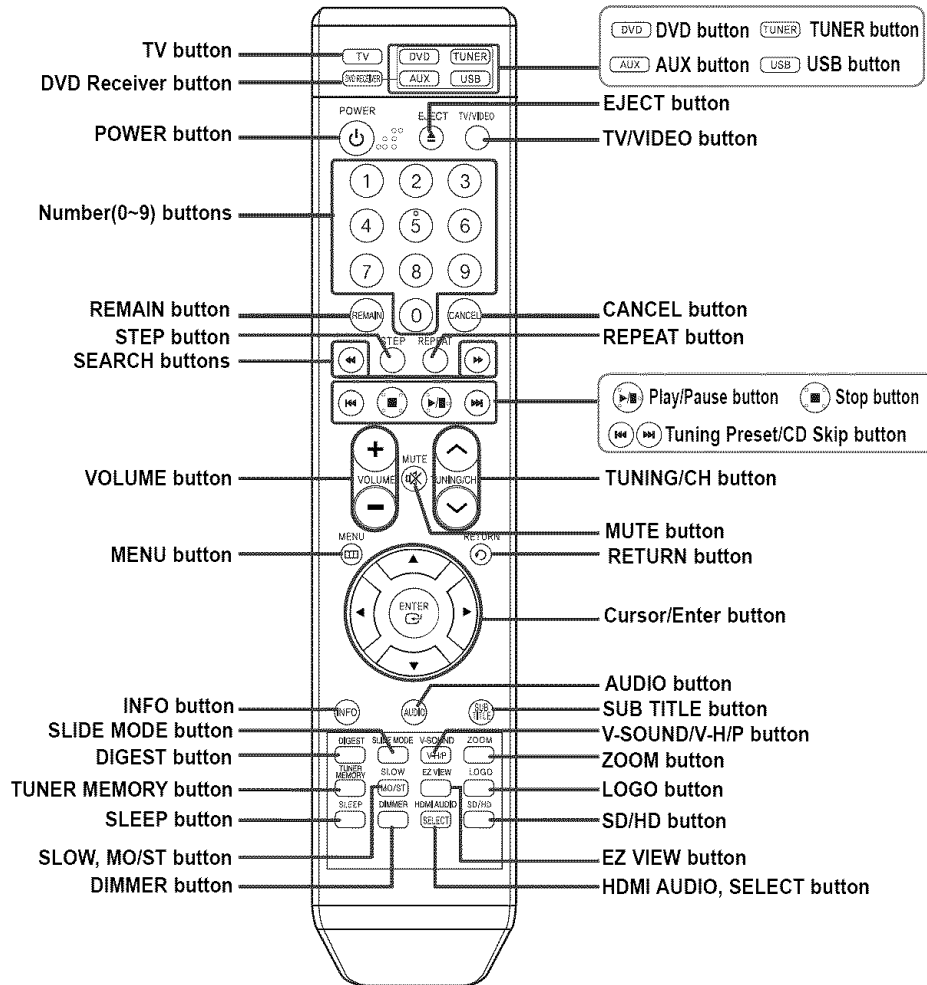

Insert Remote Batteries

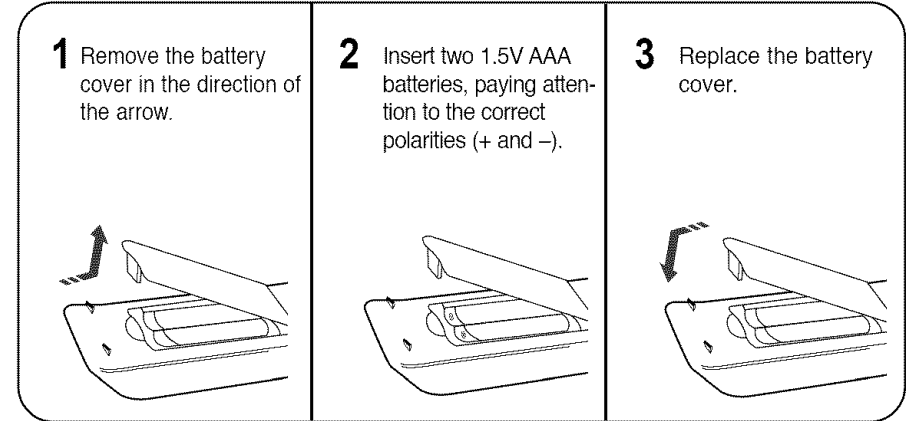

- Caution** Follow these precautions to avoid leaking or cracking cells:
- Place batteries in the remote control so they match the polarity:(+) to (+)and (-)to (-).
 - Use the correct type of batteries.Batteries that look similar may differ in voltage.
 - Always replace both batteries at the same time.
 - Do not expose batteries to heat or flame.

Range of Operation of the Remote Control

The remote control can be used up to approximately 23 feet/7 meters in a straight line. It can also be operated at a horizontal angle of up to 30° from the remote control sensor.

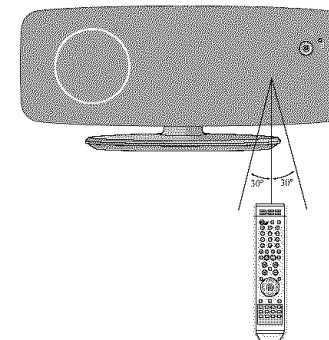

Before Connecting the Speakers

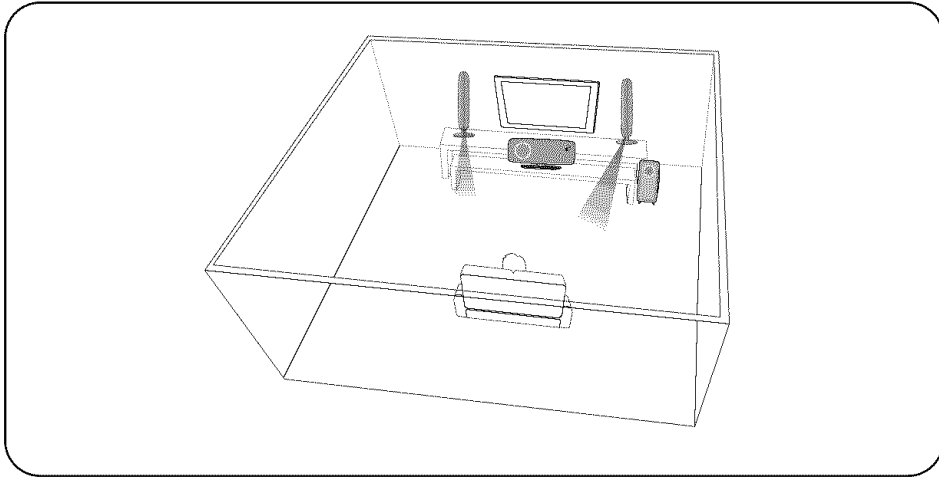

Speaker Packages

Please confirm that all the following contents are included in the package.

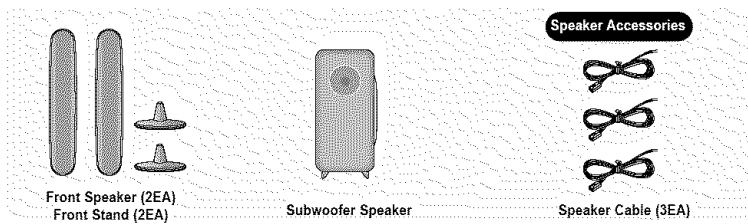

Assembling the Speakers

Set the front speaker on the front stand.

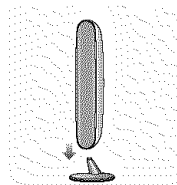

To mount the speaker on the wall

Drive a screw into the wall for each speaker and then hook the front speaker over them.

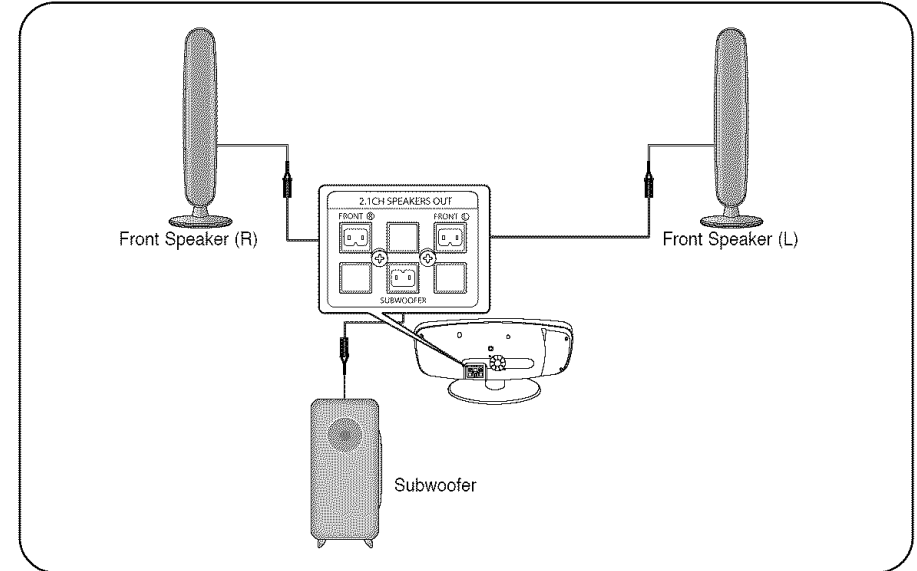
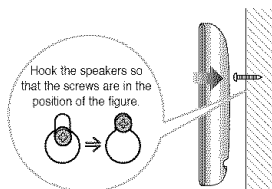

Connecting the Speakers

- 1 Press down the terminal tab on the back of the speaker.
- 2 Insert the black wire into the black terminal (-) and the red wire into the red (+) terminal, and then release the tab.
- 3 Connect the connecting plugs to the back of the Home Theater.
 - Make sure the colors of the speaker terminals match the colors of the connecting plugs.

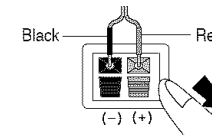
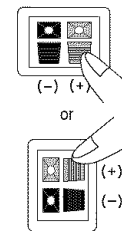

Caution

- Do not let children play with or near the speakers. They could get hurt if a speaker falls.
- When connecting the speaker wires to the speakers, make sure that the polarity (+/-) is correct.

Note

- If you place a speaker near your TV set, screen color may be distorted because of the magnetic field generated by the speaker. If this occurs, place the speaker away from your TV set.

Installing the DVD player

1 Separate the rear cover(A).

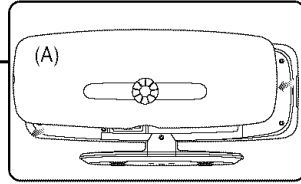

2 Remove the 1 screw of the cover(B).

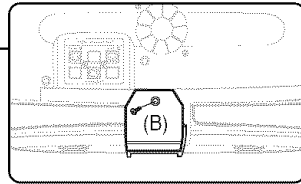

3 Put the speaker cable connected to the Speaker OUT port into the left groove.

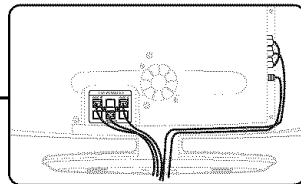

4 Put the cables connected to the Video OUT, Component OUT and Audio IN ports into the right groove.

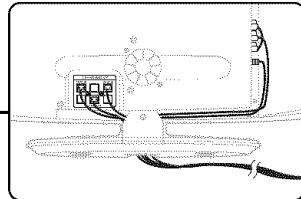

5 Fasten the 1 screw on the cover(B).

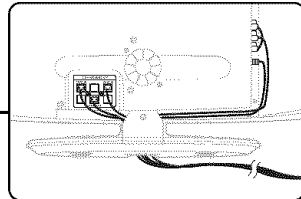

6 Close the rear cover(A).

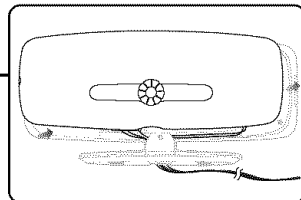

Connecting the Video Out to TV

Choose one of the three methods for connecting to a TV.

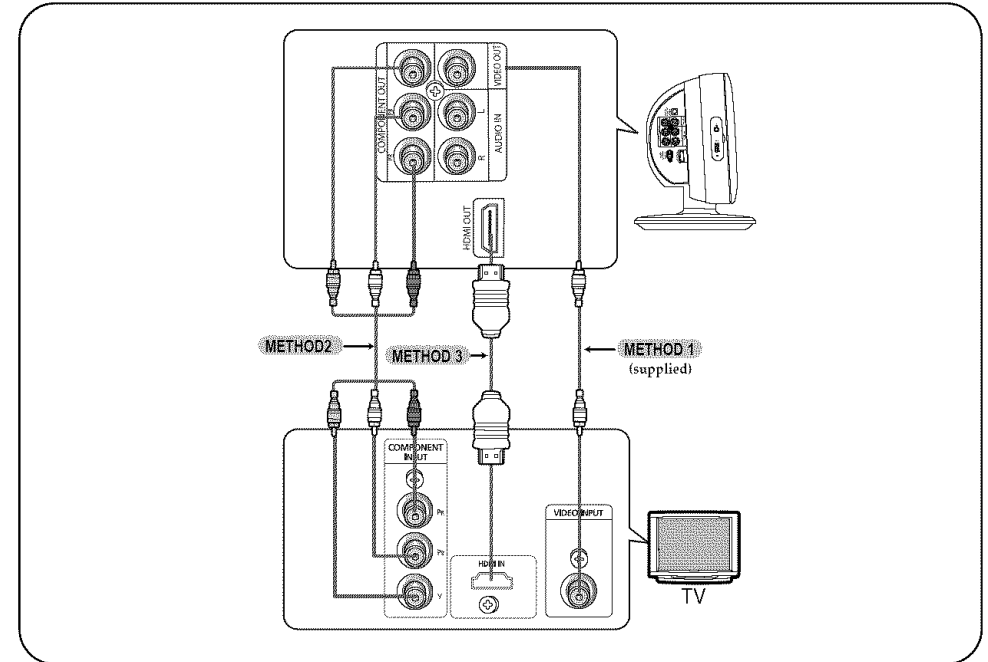

METHOD 1 Composite Video (Good Quality)

- Connect the supplied video cable from the VIDEO OUT jack on the back panel of the system to the VIDEO IN jack on your TV.

METHOD 2 Component (Better Quality)

- If your television is equipped with Component Video inputs, connect a component video cable (not supplied) from the Pr, Pb and Y jacks on the side panel of the system to the corresponding jacks on your TV.

METHOD 3 HDMI (Best Quality)

- Connect the HDMI out to the HDMI input on your TV.

- Note**
- This product operates in Progressive scan mode(480p Only) for Component Output.
 - If the TV only supports a resolution of 576i(480i), the screen may be divided into 2 screens, or display nothing.
 - After making the video connection, set the Video input source on your TV to match the corresponding Video output (HDMI, Component or Composite) on your Home theater. See your TV owner's manual for more information on how to select the TV's Video Input source.

HDMI Function

What is HDMI (High Definition Multimedia Interface)?

This device transmits DVD video signal digitally without the process of converting to analog. You can get sharper digital pictures by connecting the video to your TV using an HDMI connection cable.

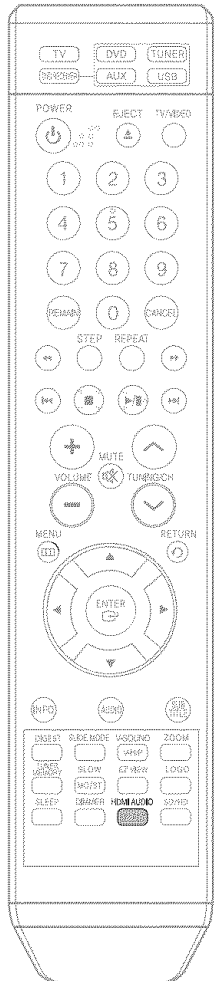

HDMI Audio ON/OFF function

- The audio signals transmitted over the HDMI Cable can be toggled ON/OFF.

Press the **HDMI AUDIO** button on the remote control.

- This toggles between "AUDIO ON" and "AUDIO OFF" on the display.
- **AUDIO ON** : Both video and audio signals are transmitted over the HDMI connection cable, and audio is output through your TV speakers only.
- **AUDIO OFF** : Video is transmitted over the HDMI connection cable only, and audio is output through the home theater speakers only.

- Note**
- The default setting value of this product is HDMI AUDIO OFF.
 - HDMI AUDIO is automatically down-mixed to 2ch for TV speakers.
 - If you turn the unit off and on, or switch functions when the HDMI AUDIO is set to ON, the HDMI AUDIO is automatically set to OFF.

Resolution Selection

- This function allows the user to select screen resolution for HDMI output.

In Stop mode, press and hold the **SD/HD** (Standard Definition/High Definition) button on the remote control.

- Resolutions available for the HDMI output are 480P, 720P and 1080i.
- SD(Standard Definition) resolution is 480p and HD(High Definition) resolution is 720p/1080i.

Example: If the TV supports resolution up to 480p:

Press the **SD/HD** button.

- A 480p video signal is output through the HDMI output.
- If the TV does not support the configured resolution, you will not be able to see the picture properly.

- Note**
- Since this product has an embedded Video Upscaler function with Faroudja DCDi technology, it can enhance a 576i(480i) DVD resolution output to 480p/720p/1080i.
 - You do not have to make separate adjustments, since the Home Theater and TV will be automatically adjust themselves to the optimal resolution and aspect ratio if connected to HDMI. (If the TV is an HDTV and has an HDMI Input jack, output is automatically converted to 1080i resolution (if supported by the TV).)
 - For component video output, only 480P is supported.
 - When both HDMI and COMPONENT jacks are connected, COMPONENT video is not displayed.
 - See your TV owner's manual for more information on how to select the TV's Video Input source.

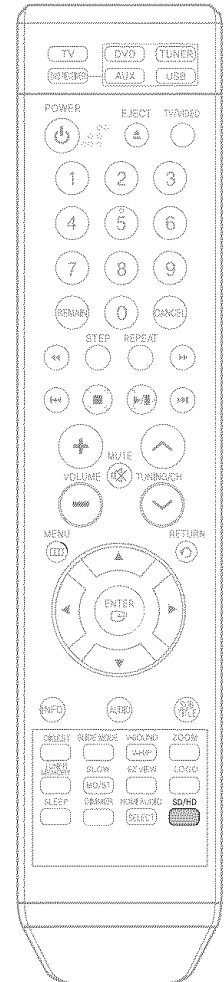

Connecting External Components

Connecting an External Digital / Analog Component

Example: Digital signal components such as a Set-Top Box or CD Recorder.
Analog signal components such as a VCR.

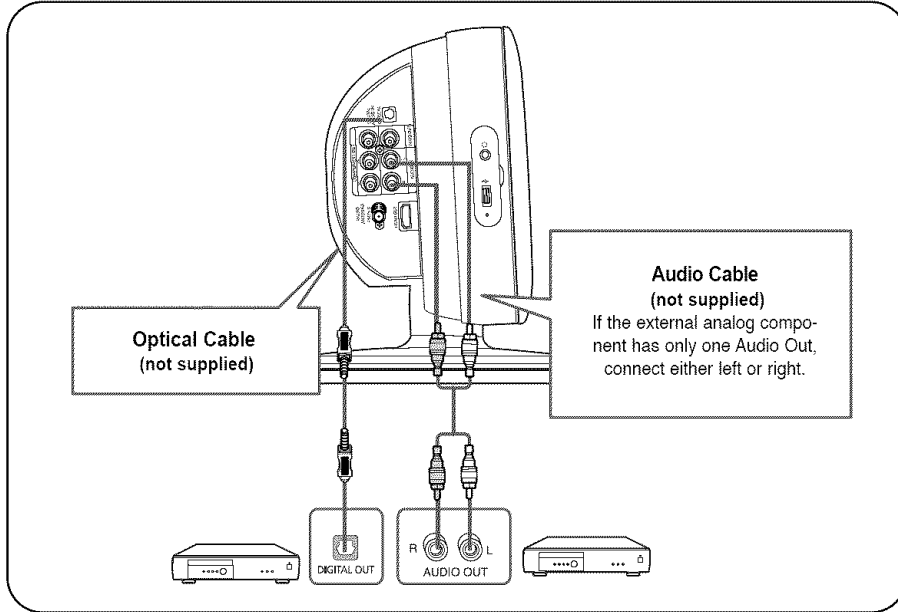

- 1 Connect the Digital Input (OPTICAL) to the Digital Output on the external digital component.
- 2 Connect AUX (Audio) In on the Home Theater to Audio Out on the external analog component.
 - Be sure to match connector colors.
- 3 Press **AUX** on the remote control to select 'D.IN / AUX' input.
 - Each time the button is pressed, the selection changes as follows: D.IN → AUX
 - You can also use the **FUNCTION** button on the main unit.
The mode switches as follows: DVD → D.IN → AUX → USB → FM

Note • You can connect the Video Output jack on your VCR to the TV, and connect the Audio Output jacks on the VCR to this product.

Connecting the FM Antenna

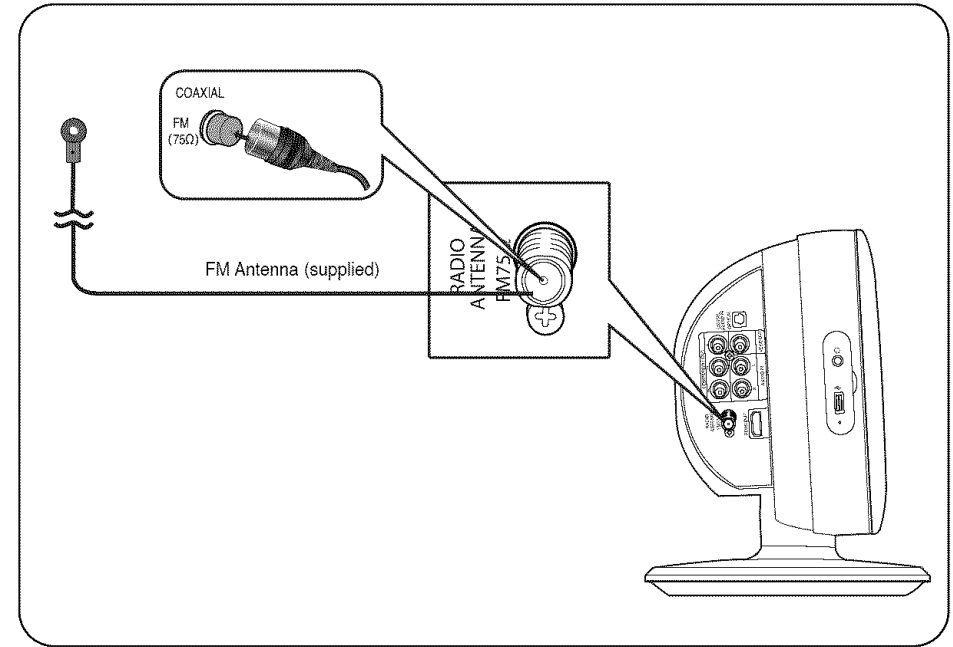

- 1 Connect the FM antenna supplied to the FM 75Ω COAXIAL terminal.
- 2 Slowly move the antenna wire around until you find a location where reception is good, then fasten it to a wall or other rigid surface.

Cooling Fan The cooling fan supplies cool air to the unit to prevent overheating.

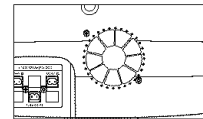

Please observe the following cautions for your safety.

- Make sure the unit is well-ventilated. If the unit has poor ventilation, the temperature inside the unit could rise and may damage it.
- Do not obstruct the cooling fan or ventilation holes. (If the cooling fan or ventilation holes are covered with a newspaper or cloth, heat may build up inside the unit and fire may result.)

Notes • This unit does not receive AM broadcasts.

Before Using Your Home Theater

Your Home Theater is capable of playing DVD, CD, MP3/WMA and JPEG discs. Depending on the disc you are using, these instructions may vary slightly. Read the instructions carefully before using.

To Operate the TV and DVD Player with a Single Remote Control

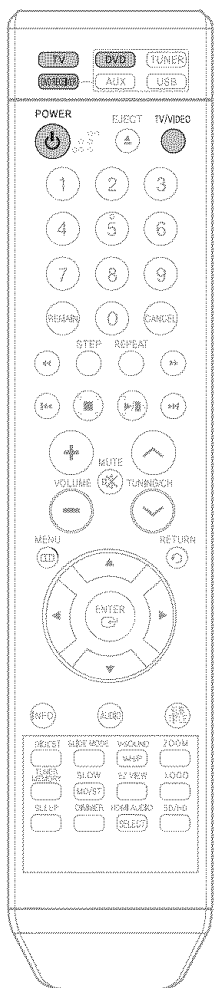

1 Plug the main unit's power cord into the AC power supply.

4 Press **TV/VIDEO** button to select **VIDEO** mode on your TV.



2 Press **TV** button to set the remote to TV mode.

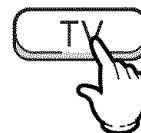

3 Press the **POWER** button to turn on your Samsung TV with this remote.



5 Press **DVD RECEIVER** button to switch to DVD RECEIVER mode.



6 Press **FUNCTION** button on the main unit or DVD button on the remote to enable DVD/CD playback.

Note

- Buttons Enabled for TV Operation: POWER, CHANNEL, VOLUME, TV/VIDEO, and Numeric (0-9) buttons.
- By default, the remote control is set to work with Samsung TVs.
See page 59 for more information about remote control operation with other manufacturer's TVs.

Before Using Your Home Theater

Disc terminology

Groups and tracks (DVD-AUDIO)

- DVD-audio is divided into several large sections called "groups" and smaller sections called "tracks". Numbers are allotted to these sections. These numbers are called "group numbers" and "track numbers".

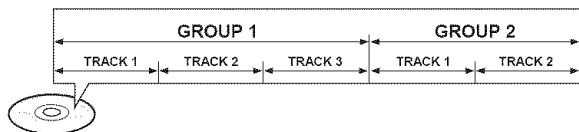

Titles and chapters (DVD-VIDEO)

- DVD-video is divided into several large sections called "titles" and smaller sections called "chapters". Numbers are allotted to these sections. These numbers are called "title numbers" and "chapter numbers".

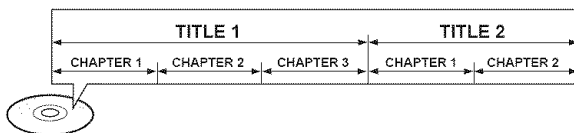

Tracks (Video and music CDs)

- Video and music CDs are divided into sections called "tracks". Numbers are allotted to these sections. These numbers are called "track numbers".

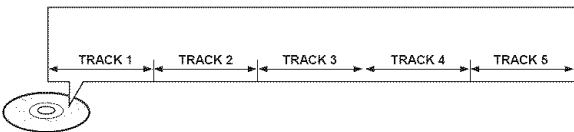

Files (DivX)

- DivX is divided into sections called "files". Numbers are allotted to these sections. These numbers are called "file numbers".

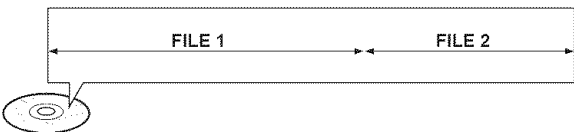

Note • In this manual, the instructions marked with "DVD (DVD)" are applicable to DVD-VIDEO, DVD-AUDIO, and DVD-R/RW discs.

Where a particular DVD type is mentioned, it is indicated separately.

- Depending on the content of the disc, the initial screen may appear different.

Disc Playback

1 Load a disc vertically into the Disc Insert Hole.

- Insert a disc so that the label side faces forward.

2 To eject the disc, press the **EJECT** button

DVD CD

- Playback starts automatically.

Note • Depending on the content of the disc, the initial screen may appear different.

Caution • Avoid getting fingerprints on the writing surface of a disc. It may cause the disc to not read properly.

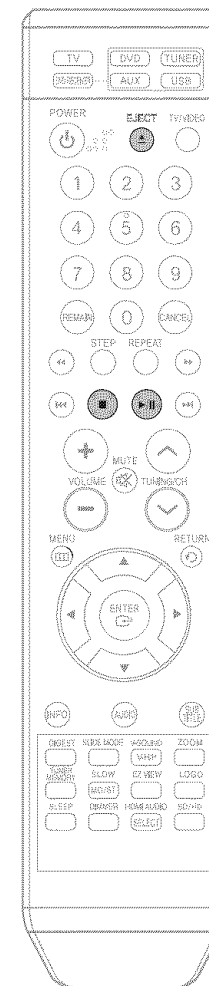

MP3/WMA-CD Playback

Data CDs (CD-ROM, CD-R, CD-RW) encoded in MP3/WMA format can be played.

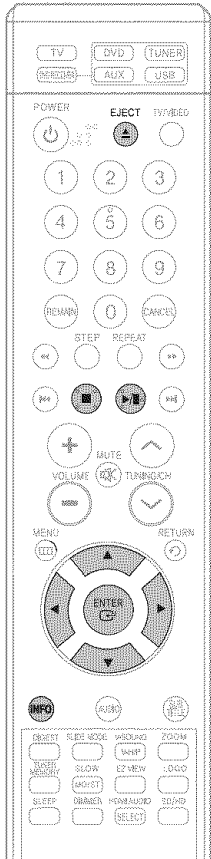

1 Load the MP3/WMA disc.

- The MP3/WMA menu screen will appear and playback will start.
- The appearance of the menu depends on the MP3/WMA disc.
- WMA-DRM files cannot be played.

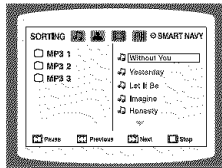

2 In Stop mode, use ◀ ▶ ▲ ▼ to select the album, and then press the ENTER button.

- Use ▲ ▼ to select the track.

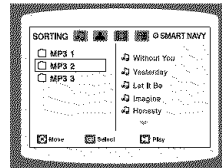

3 To change the album, use ◀ ▶ ▲ ▼ to select another album in Stop mode, and then press the ENTER button.

- To select another album and track, repeat Steps 2 and 3 above.

Note

- Depending on the recording mode, some MP3/WMA-CDs may not play.
- Table of contents of a MP3-CD varies depending on the MP3/WMA track format recorded on the disc.

4 Press the STOP button to stop playback.

To play a file icon in the screen,

Press the ◀ ▶ ▲ ▼ button when it is in stop status and select a desired icon from the top part of the menu.

- To play music files only, select the icon.
- To view image files only, select the icon.
- To view movie files only, select the icon.
- To select all files select the icon.

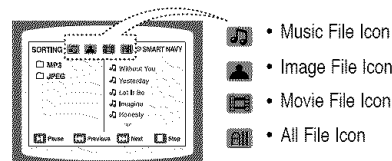

Displaying Disc Information

You can view disc playback information on the TV screen.

Press INFO button.

- Each time the button is pressed, the display changes as follows:

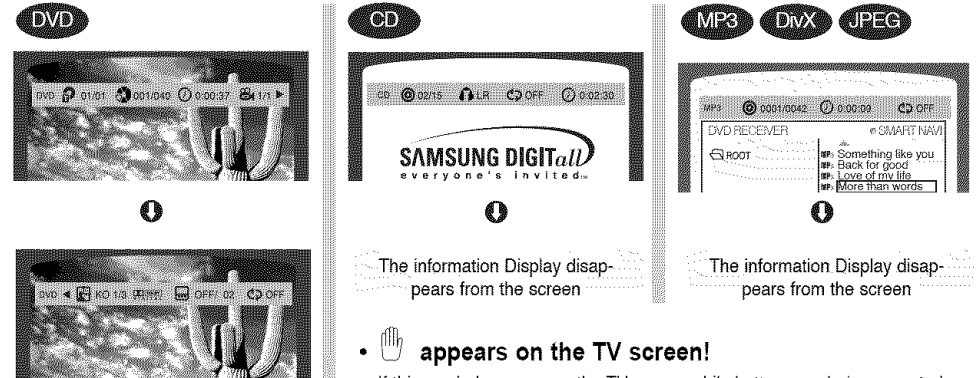

The information Display disappears from the screen

The information Display disappears from the screen

appears on the TV screen!

If this symbol appears on the TV screen while buttons are being operated, that operation is not possible with the disc currently being played.

The information Display disappears from the screen

Note

- Depending on the disc, the disc information display may appear different.
- Depending on the disc, you can also select DOLBY DIGITAL, or PRO LOGIC.

- **What is a Group?**
A section of tracks contained in a DVD-AUDIO disc.
- **What is a Title?**
A movie contained in a DVD-VIDEO disc.
- **What is a Chapter?**
Each title on a DVD disc is divided into several smaller sections called "chapters".
- **What is a Track (File)?**
A section of video or a music file recorded on a DVD-AUDIO, CD, or MP3-CD

Screen Display

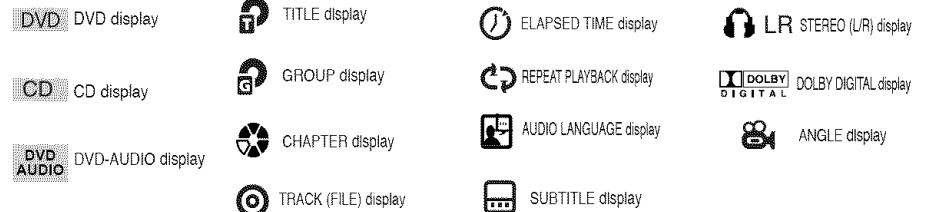

JPEG File Playback JPEG

Images captured with a digital camera or camcorder, or JPEG files on a PC can be stored on a CD and then played back with this Home Theater.

Slide Mode

1 Load the JPEG disc.

2 Press **SLIDE MODE** button.

- Playback starts automatically.
- Each time the button is pressed, the image makes the transition as follows:

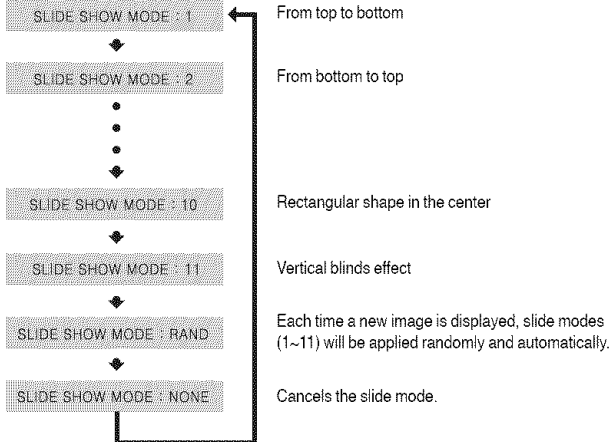

Press **◀▶▶▶** to skip to the next slide.

- Each time the button is pressed, the slide moves backward or forward.

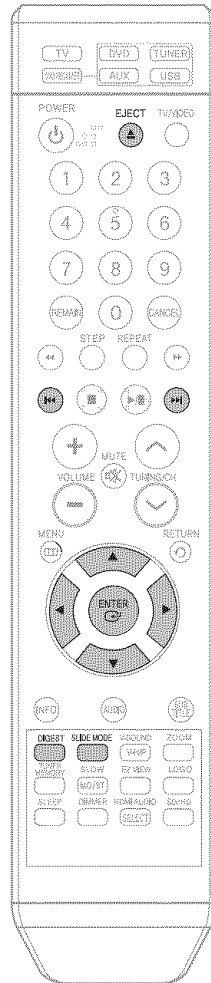

Digest Function

You can view 9 JPEG images on the TV screen.

1 Press **DIGEST** button during playback.

- JPEG files will be shown in 9 windows.



2 Press Cursor **▲, ▼, ◀, ▶** buttons to select the desired image and then press **ENTER** button.

- The selected image is played for 5 seconds before moving to the next image.

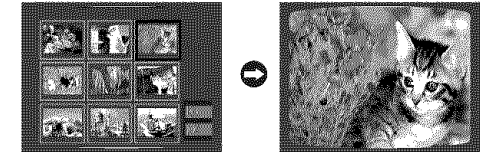

To view the previous or next image with 9 windows, press **◀▶▶▶**.

Rotate/Flip Function

Press Cursor **▲, ▼, ◀, ▶** buttons during playback.

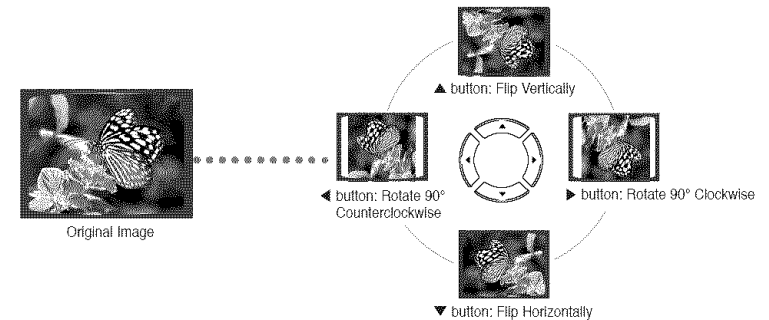

- Note**
- The maximum resolutions supported by this product are 5120 x 3480 (or 19.0 MPixel) for standard JPEG files and 2048 x 1536 (or 3.0 MPixel) for progressive image files.

Checking the Remaining Time

Press the **REMAIN** button.

- For checking the total and remaining time of a title or chapter being played.

Each time the **REMAIN** button is pressed

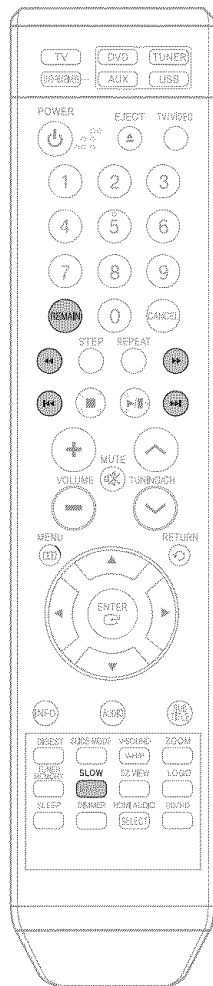
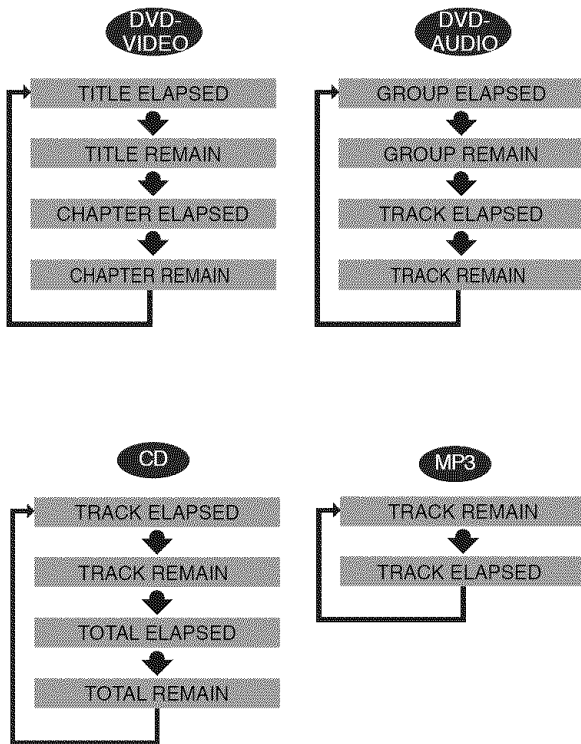

Fast/Slow Playback

Fast Playback

DVD CD MP3

Press **◀▶▶▶**.

- Each time the button is pressed during playback, the playback speed changes as follows:

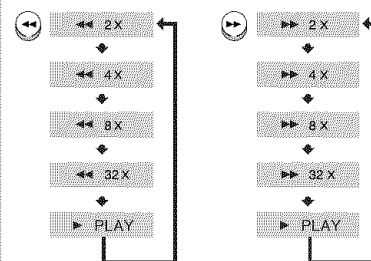

Note

- During fast playback of a CD or MP3-CD, sound is heard only at 2x speed, and not at 4x, 8x, and 32x speeds.

Slow Playback

Press **SLOW** button.

- Each time the button is pressed during playback, the playback speed changes as follows:

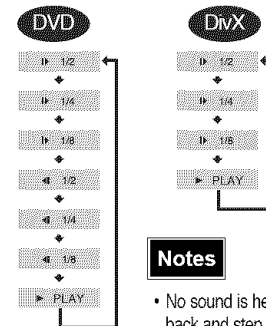

Notes

- No sound is heard during slow playback and step motion playback.
- Reverse slow playback does not work with DivX.

Skipping Scenes/Songs

Press **◀▶▶▶**.

- Each time the button is pressed briefly during playback, the previous or next chapter, track, or directory (file) will be played.
- You cannot skip chapters consecutively.

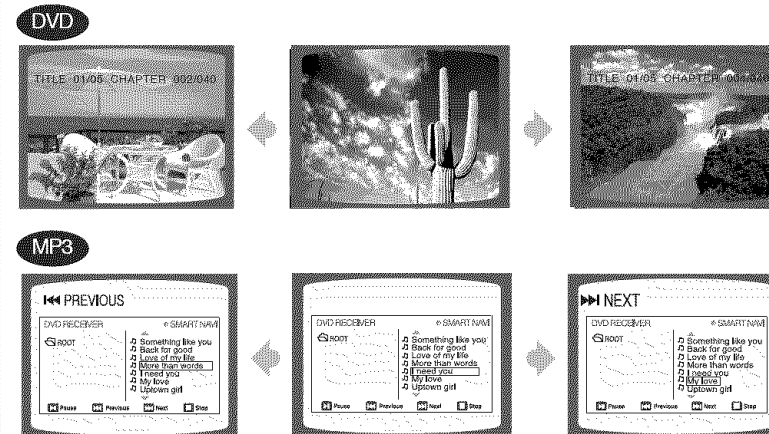

Repeat Playback

Repeat playback allows you to repeatedly play a chapter, title, track (song), or directory (MP3 file).

DVD CD MP3 JPEG

Press **REPEAT** button.

- Each time the button is pressed during playback, the repeat playback mode changes as follows:

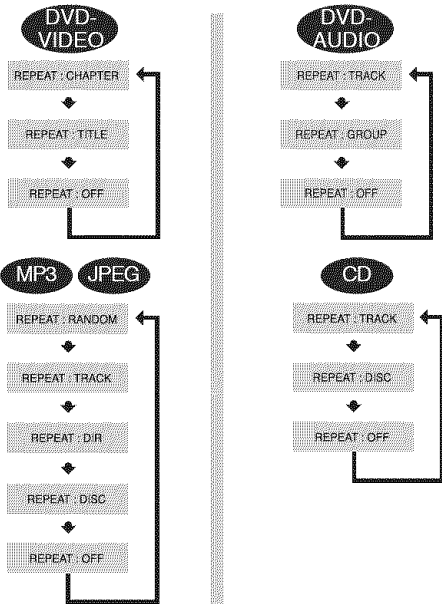

Repeat Playback Options

- CHAPTER**
Repeatedly plays the selected chapter.
- TITLE**
Repeatedly plays the selected title.
- GROUP**
Repeatedly plays the selected group.
- RANDOM**
Plays tracks in random order.
(A track that has already been played may be played again.)
- TRACK**
Repeatedly plays the selected track.
- DIR**
Repeatedly plays all tracks in the selected folder.
- DISC**
Repeatedly plays the entire disc.
- OFF**
Cancels Repeat Playback.

To Select a Repeat Playback Mode in the Disc Information Screen

- Press **INFO** button twice.
- Press Cursor **▶** button to move to REPEAT PLAYBACK (⌂) display.
- Press Cursor **▼** button to select the desired Repeat Playback mode.
- Press **ENTER** button.

* For MP3 and JPEG discs, you cannot select Repeat Play from the information display screen.

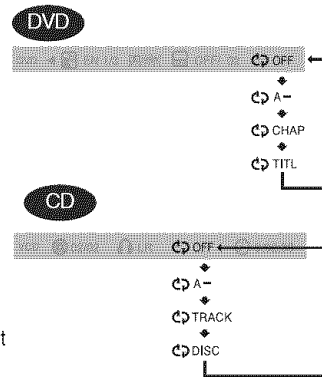

A-B Repeat Playback

You can repeatedly play back a designated section of a DVD.

DVD

- Press **INFO** button twice.

- Press Cursor **▶** button to move to REPEAT PLAYBACK (⌂) display.

- Press Cursor **▲**, **▼** buttons to select 'A-' and then press **ENTER** button at the beginning of the desired segment.

- Press **ENTER** button at the end of the desired

• When **ENTER** button is pressed, the selected position will be stored in memory.

• The specified segment will be played repeatedly.

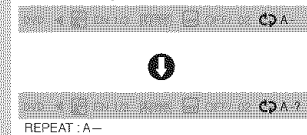

To return to normal playback, press Cursor **▲**, **▼** buttons to select **⌂ OFF**.

Note

- The A-B Repeat function does not operate with MP3, CD or JPEG discs.

Step Function DVD

Press **STEP** button.

- The picture moves forward one frame each time the button is pressed during playback.

Note • No sound is heard during slow playback and step motion playback.

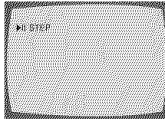

Angle Function DVD

This function allows you to view the same scene in different angles.

1 Press **INFO** button.

2 Press Cursor **▶** button to move to **ANGLE** () display.



3 Press Cursor **▲**, **▼** or numeric buttons to select the desired angle.

- Each time the button is pressed, the angle changes as follows:

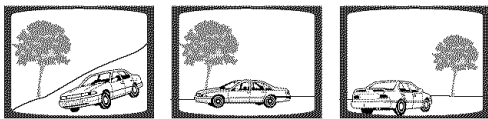
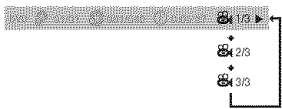

Note • The Angle function works only with discs on which multiple angles have been recorded.

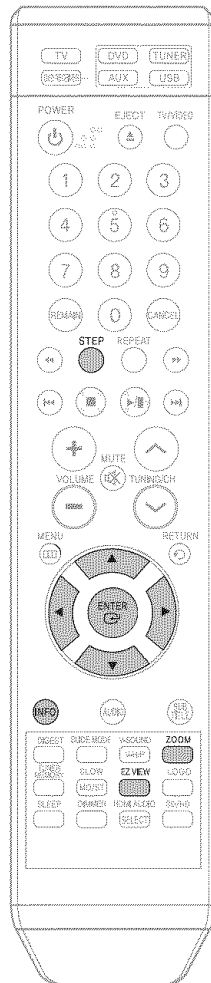

Zoom (Screen Enlarge) Function DVD

This function allows you to enlarge a particular area of the displayed image.

1 Press **ZOOM** button.

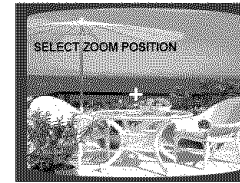

2 Press Cursor **▲**, **▼**, **◀**, **▶** buttons to move to the area you want to enlarge.

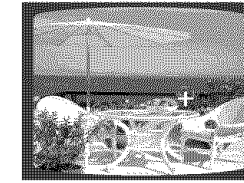

3 Press **ENTER** button.

- Each time the button is pressed, the zoom level changes as follows:

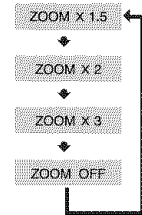

Note • When a DivX disc is being played, only the 2:1 zoom-in is available.

EZ VIEW Function DVD

Press **EZ VIEW** button.

- Each time the button is pressed, the zoom function will switch between On and Off.
- When a movie is played in Widescreen format, black bars at the top and bottom of the TV screen can be removed by pressing the **EZ VIEW** button.

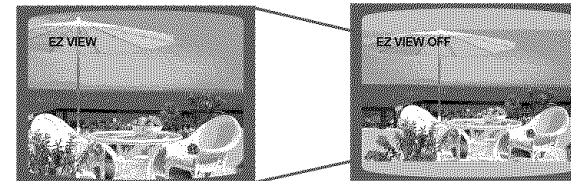

Note

- This function will not work if the DVD is recorded with multi-camera angle format.
- Black bars may not disappear because some DVD discs have a built-in horizontal to vertical ratio.
- This feature is not supported for DivX discs.

Bonus Group / Navigating Pages

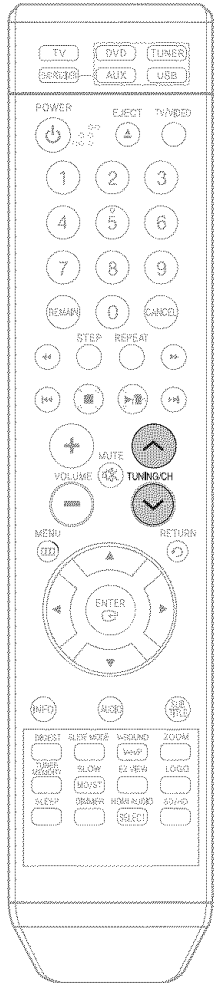

Bonus Group DVD-AUDIO

Some DVD-Audio discs have an extra 'bonus' group that requires a 4-digit key number to access. See the disc packaging for details and the key number.

When you play a DVD-Audio disc that has a bonus group, the key number input screen appears automatically.

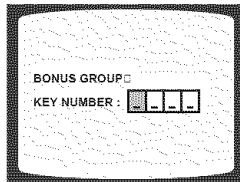

Note

- If you eject the disc, switch the power off, or unplug the player, you will need to re-enter the key number.

Navigating Pages DVD-AUDIO

During playback, press the **TUNING/CH** button on the remote control.

- You can select the desired image from a DVD-Audio disc containing still images.
- With some discs, you may not be able to select images.

Selecting Audio/Subtitle Language

Audio Language Selection Function DVD

1 Press **INFO** button twice.



2 Press Cursor **▲** **▼** buttons or numeric buttons to select the desired audio language.

- Depending on the number of languages on a DVD disc, a different audio language (ENGLISH, SPANISH, FRENCH, etc.) is selected each time the button is pressed.

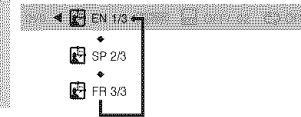

Subtitle Language Selection Function DVD

1 Press **INFO** button twice.



2 Press Cursor **▶** button to move to **SUBTITLE** () display.



3 Press Cursor **▼** button or numeric buttons to select the desired subtitle.

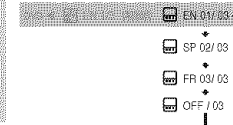

Note

- To operate this function, you can also press the Select AUDIO or Select SUBTITLE buttons on the remote control.
- Depending on the disc, the Subtitle and Audio Language functions may not be available.

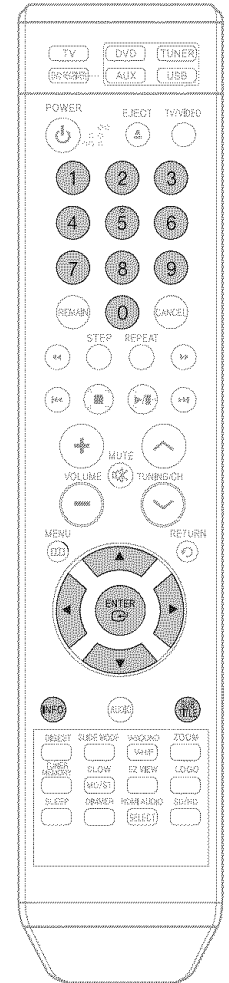

Playing Media Files using the USB HOST feature

You can enjoy media files such as pictures, movies and music saved in an MP3 player, USB memory or digital camera in high quality video with 5.1 channel home theater sound by connecting the storage device to the USB port of the home theater.

1 Connect the USB device to the USB port on the side of the unit.

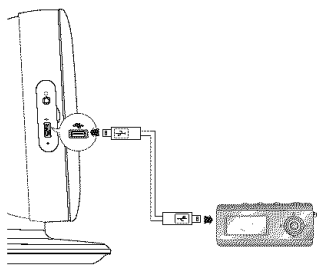

2 Press the **FUNCTION** button on the main unit or the **USB** button on the remote control to select the USB mode.

- "USB" appears on the display screen and then disappears.
- USB MENU screen appears on the TV screen and the saved file is played.

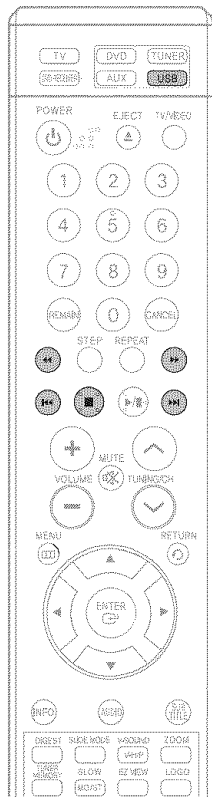
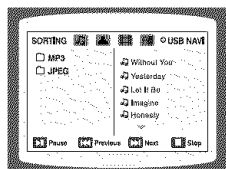

To stop playback, press the **STOP** (■) button.

Safe USB Removal

To prevent damage to the memory stored in the USB device, perform safe removal before disconnecting the USB cable.

- (1) Press the Stop button twice in a row.
The display will show REMOVE → USB.
- (2) Remove the USB cable.

Skip Forward/Back

During playback, press the **◀▶▶▶** button.

- When there is more than one file, when you press the **▶▶▶▶** button, the next file is selected.
- When there is more than one file, when you press the **◀◀◀◀** button, the previous file is selected.

Fast playback

To play back the disc at a faster speed, press **◀◀** or **▶▶** during playback.

- Each time you press either button, the playback speed will change as follows:
2x → 4x → 8x → 32x → Normal.

Compatible Devices

1. USB devices that support USB Mass Storage v1.0. (USB devices that operate as a removable disk in Windows (2000 or later) without additional driver installation.)
2. MP3 Player: HDD and flash type MP3 players.
3. Digital camera: Cameras that support USB Mass Storage v1.0.
 - Cameras that operate as a removable disk in Windows (2000 or later) without additional driver installation.
4. USB HDD and USB Flash Drive: Devices that support USB2.0 or USB1.1.
 - You may experience a difference in playback quality when you connect a USB1.1 device.
 - For a USB HDD, make sure to connect an auxiliary power cord to the USB HDD for proper operation.
5. USB card Reader: One slot USB card reader and Multi slot USB card reader
 - Depending on the manufacturer, the USB card reader may not be supported.
 - If you install multiple memory devices into a multi card reader, you may experience problems.
6. If you use a USB extension cable, the USB device might not be recognized.

Supported Formats

	File name	File extension	Bit rate	Version	Pixel	Sampling Frequency
Still Picture	JPG	.JPEG	-	-	640*480	-
	MP3	.MP3	80~384kbps	-	-	44.1kHz
Music	WMA	.WMA	56~128kbps	V8	-	44.1kHz
	Movie	WMV	.WMV	4Mbps	V1,V2,V3,V7	720*480
DivX		.AVI, .ASF	4Mbps	DivX3.11~DivX5.1,Xvid	720*480	44.1KHz-48KHz

- CBI (Control/Bulk/Interrupt) is not supported.
- Digital Cameras that use PTP protocol or require additional program installation when connected to a PC are not supported.
- A device using NTFS file system is not supported. (Only FAT 16/32 (File Allocation Table 16/32) file system is supported.)
- Some MP3 players, when connected to this product, may not operate depending on the sector size of their file system.
- The USB HOST function is not supported if a product that transfers media files by its manufacturer-specific program is connected.
- Does not operate with Janus enabled MTP(Media Transfer Protocol) devices.
- **The USB host function of this product does not support all USB devices. For information on the supported devices, see pages 65.**

Moving Directly to a Scene/Song

DVD CD

1 Press **INFO** button.



Moving to a Title/Track

2 Press Cursor **▲**, **▼** buttons or numeric buttons to select the desired title/track and then press **ENTER** button.



Moving to a Chapter

3 Press Cursor **◀**, **▶** buttons to move to Chapter () display.



Moving to a Chapter

4 Press Cursor **▲**, **▼** buttons or numeric buttons to select the desired chapter and then press **ENTER** button.



Moving to a Specific Time

5 Press Cursor **◀**, **▶** buttons to move to time display.



Moving to a Specific Time

6 Press the numeric buttons to select the desired time and then press **ENTER** button.



MP3 JPEG

Press the **numeric** buttons.

- The selected file will be played.
- When playing an MP3 or JPEG disc, you cannot use **▲**, **▼** to move to a folder. To move a folder, press **■** (Stop) and then press **▲**, **▼**.

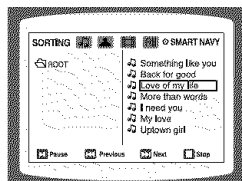

Note

- You can press **◀◀▶▶** on the remote control to move directly to the desired title, chapter, or track.
- Depending on the disc, you may not be able to move to the selected title or time.

Using Disc Menu DVD

You can use the menus for the audio language, subtitle language, profile, etc. DVD menu contents differ from disc to disc.

1 In Stop mode, press **MENU** button.



2 Press Cursor **▲**, **▼** buttons to move to 'DISC MENU' and then press **ENTER** button.



- When you select Disc Menu and it is not supported by the disc, the "This menu is not supported" message appears on the screen.

3 Press Cursor **▲**, **▼**, **◀**, **▶** buttons to select the desired item.

- Press **ENTER** button.

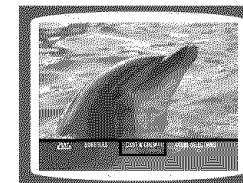

Note • Disc menu display may be different depending on the disc.

Using the Title Menu DVD

For DVDs containing multiple titles, you can view the title of each movie. Depending on the disc, the availability of this feature may vary.

1 In Stop mode, press **MENU** button.



2 Press Cursor **▲**, **▼** button to move to 'Title Menu'.



3 Press **ENTER** button.

- The title menu appears.

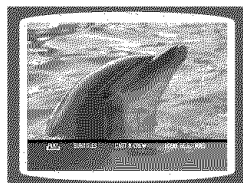

Press **MENU** button to exit the setup screen.

Note • Title menu display may be different depending on the disc.

Setting the Language

OSD (On-Screen Display) language is set to English by default.

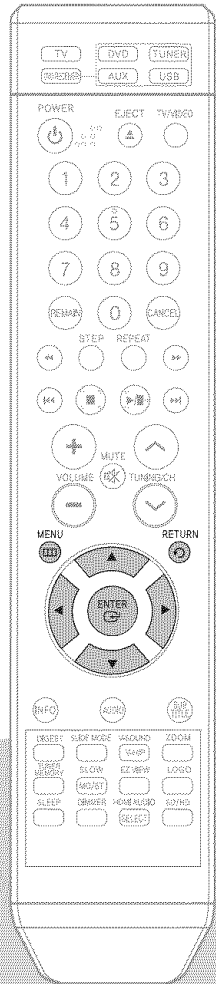

1 In Stop mode, press **MENU** button.



2 Press Cursor **▼** button to move to 'Setup' and then press **ENTER** button.



3 Select 'Language' and then press **ENTER** button



4 Press Cursor **▲, ▼** button to select 'OSD Language' and then press **ENTER** button.

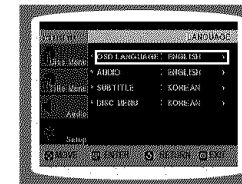

5 Press Cursor **▲, ▼** button to select the desired language and then press **ENTER** button.

- Once the setup is complete, the OSD will be English if English has been selected as language.

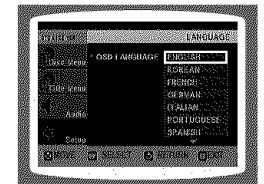

Press **RETURN** button to return to the previous level.

Press **MENU** button to exit the setup screen.

Note

- To select another language, select OTHER and enter the language code of your country. (See page 64 for language codes)
AUDIO, SUB TITLE and DISC MENU language can be selected.



Selecting the OSD Language



Selecting the Audio Language (recorded on the disc)



Selecting the Subtitle Language (recorded on the disc)



Selecting the Disc Menu Language (recorded on the disc)

- * If the language you selected is not recorded on the disc, menu language will not change even if you set it to your desired language.

Setting TV Screen type

Depending on your TV type (Wide Screen or conventional 4:3), you can select the TV's aspect ratio.

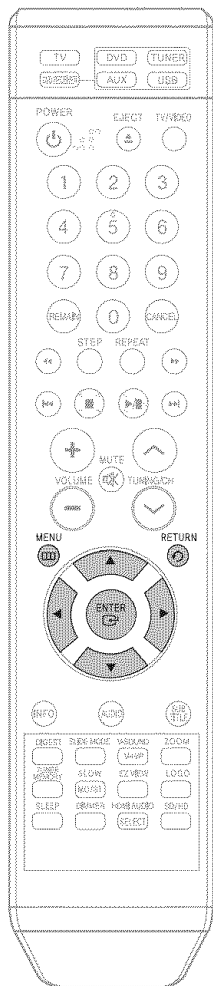

1 In Stop mode, press **MENU** button.



2 Press Cursor \blacktriangledown button to move to 'Setup' and then press **ENTER** button.



3 Press Cursor \blacktriangledown button to move to 'TV DISPLAY' and then press **ENTER** button.

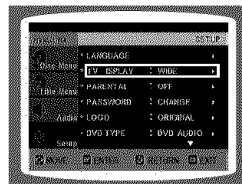

4 Press Cursor \blacktriangle , \blacktriangledown button to select the desired item and then press **ENTER** button.

• Once the setup is complete, you will be taken to the previous screen.



Adjusting the TV Aspect Ratio (Screen Size)

The horizontal to vertical screen size ratio of conventional TVs is 4:3, while that of widescreen and high definition TVs is 16:9. This ratio is called the aspect ratio. When playing DVDs recorded in different screen sizes, you should adjust the aspect ratio to fit your TV or monitor.

• For a standard TV, select either "4:3LB" or "4:3PS" option according to personal preference. Select "16:9" if you have a widescreen TV.

WIDE

: Select this to view a 16:9 picture in the full-screen mode on your widescreen TV.
• You can enjoy the widescreen aspect.



4:3LB (4:3 Letterbox)

: Select this to play a 16:9 picture in the letter box mode on a conventional TV.
• Black bars will appear at the top and bottom of the screen.

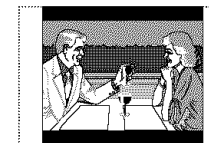

4:3PS (4:3 Pan&Scan)

: Select this to play a 16:9 picture in the pan & scan mode on a conventional TV.
• You can see the central portion of the screen only (with the sides of the 16:9 picture cut off).



Note

• If a DVD is in the 4:3 ratio, you cannot view it in widescreen.
• Since DVD discs are recorded in various image formats, they will look different depending on the software, the type of TV, and the TV aspect ratio setting.

Press **RETURN** button to return to the previous level.

Press **MENU** button to exit the setup screen.

Setting Parental Controls (Rating Level)

Use this to restrict playback of adult or violent DVDs you do not want children to view.

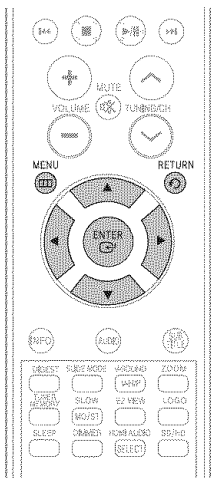

1 In Stop mode, press **MENU** button.



2 Press Cursor **▼** button to move to 'Setup' and then press **ENTER** button.



3 Press Cursor **▼** button to move to 'PARENTAL' and then press **ENTER** button.

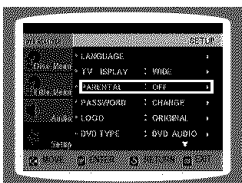

4 Press Cursor **▲▼** button to select the desired rating level and then press **ENTER** button.

- If you have selected Level 6, you cannot view DVDs with Level 7 or higher.
- The higher the level, the closer the content is to violent or adult material.

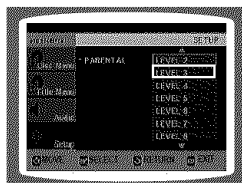

5 Enter the password and then press **ENTER** button.

- The password is set to "7890" by default.
- Once the setup is complete, you will be taken to the previous screen.

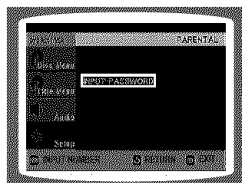

Note • This function works only if a DVD disc contains the rating level information.

Press **RETURN** button to return to the previous level.

Press **MENU** button to exit the setup screen.

Setting the Password

You can set the password for the Parental (rating level) setting.

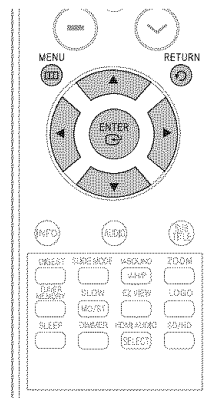

1 Press **MENU** button.



2 Press Cursor **▼** button to move to 'Setup' and then press **ENTER** button.



3 Press Cursor **▼** button to move to 'PASSWORD' and then press **ENTER** button.



4 Press **ENTER** button.



5 Enter the password and then press **ENTER** button.

- Enter the old password, a new password, and confirm new password.
- The setting is complete.



Note • The password is set to "7890" by default.

If you have forgotten the rating level password, do the following:

- While the player is in the no disc mode, hold the main unit's **■** button for longer than 5 seconds. "INITIALIZE" appears on the display and all settings will return to the default values.
 - Press the POWER button.
- Using the **RESET** function will erase all stored settings.
Do not use this unless necessary.

Setting the Wallpaper

JPEG DVD

While watching a DVD or JPEG CD, you can set the image you like as background wallpaper.

Setting the Wallpaper

1 During playback, press **PLAY/PAUSE** button when an image you like appears.



2 Press **LOGO** button.

• "COPY LOGO DATA" will be displayed on the TV screen.



3 The power will turn off and then back on.

- The selected wallpaper will be displayed.
- You can select up to 3 wallpaper settings.

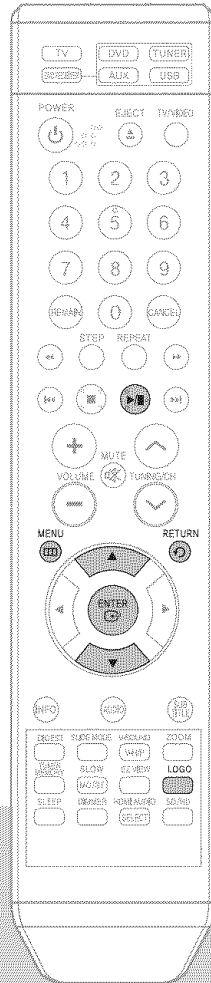

Select this to set the Samsung Logo image as your wallpaper.



Select this to set the desired image as your wallpaper.

To select one of the 3 wallpaper settings you've made

1 In Stop mode, press **MENU** button.



2 Press **Cursor** button to move to 'Setup' and then press **ENTER** button.

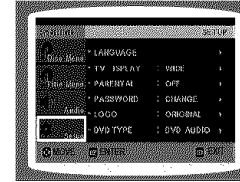

3 Press **Cursor** button to move to 'LOGO' and then press **ENTER** button.



4 Press **▼** to select the desired 'USER', and then press **ENTER**.

- This selects one of the 3 wallpaper screens



5 Press **MENU** button to exit the setup screen.

Press **RETURN** button to return to the previous level.

Press **MENU** button to exit the setup screen.

DVD Playback Mode

Some DVD-Audio discs contain DVD-Video as well as DVD-Audio.
To play back the DVD-Video portion of the DVD-Audio disc, set the unit to DVD-Video mode.

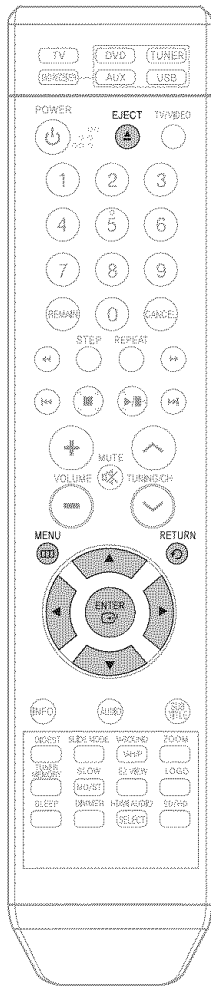

1 Press the **EJECT** button and then press the **MENU** button.



2 Press Cursor **▼** button to move to 'Setup' and then press **ENTER** button.

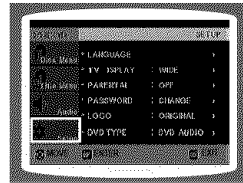

3 Press Cursor **▼** button to move to 'DVD TYPE' and then press **ENTER** button.

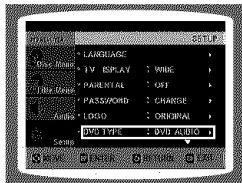

Note

- DVD Play mode is set to DVD Audio as factory default setting.
- Powering off the main unit will automatically switch to the DVD Audio mode.

4 Press Cursor **▲, ▼** button to move to 'DVD VIDEO' and then press **ENTER** button.

- Set steps 1 ~ 4 again if you want to switch to DVD AUDIO Play mode.



When Selecting DVD Play Mode:

- **DVD VIDEO** : set to play the DVD video contents contained on a DVD audio disc.
- **DVD AUDIO** : set to play the default DVD audio.

DivX (R) registration

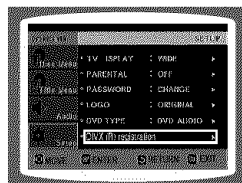

- Please use the Registration code to register this player with the DivX (R) video on demand format. To learn more, go to www.divx.com/vod.

Setting the DRC (Dynamic Range Compression)

This feature balances the range between the loudest and quietest sounds.
You can use this function to enjoy Dolby Digital sound when watching movies at low volume at night.

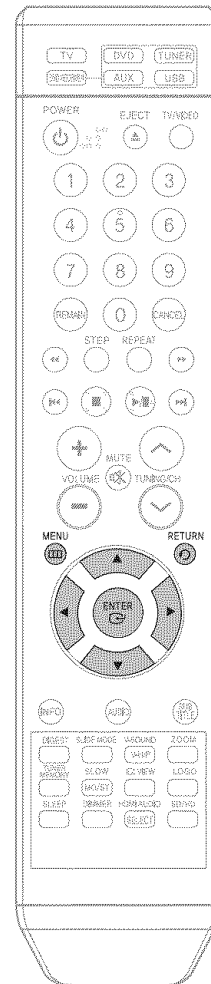

1 In Stop or no disc mode, press **MENU** button.

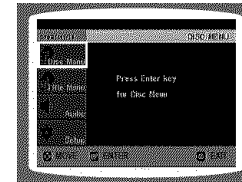

2 Press Cursor **▼** button to move to 'Audio' and then press **ENTER** button.

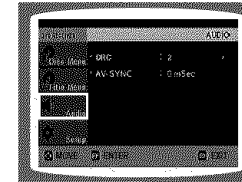

3 Press Cursor **▼** button to move to 'DRC' and then press **ENTER** button.

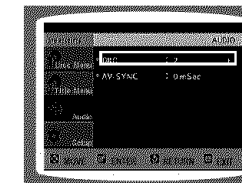

4 Press Cursor **▲, ▼** to adjust the 'DRC'.

- When the Cursor **▲** button is pressed, the effect is greater, and when the Cursor **▼** button is pressed, the effect is smaller.

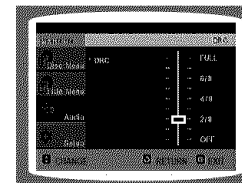

Press **RETURN** button to return to the previous level.

Press **MENU** button to exit the setup screen.

AV SYNC Setup

Video may look slower than the audio if it is connected to a digital TV.
If this occurs, adjust the audio delay time to match the video.

1 Press the **MENU** button.

- Setup menu appears.

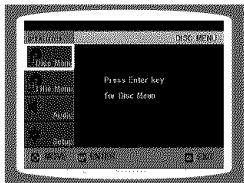

2 Press Cursor **▲**, **▼** buttons to move to 'Audio' and then press **ENTER** button.



3 Press Cursor **▲**, **▼** buttons to move to 'AV-SYNC Delay Time' and then press **ENTER** button.

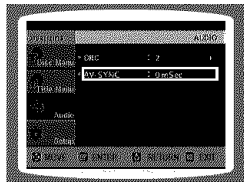

4 Press Cursor **▲**, **▼** buttons to select the AV-SYNC Delay Time and then press the **ENTER** button.

- You can set the audio delay time between 0 ms and 300 ms. Set it to the optimal status.

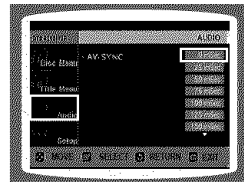

Press **RETURN** button to return to the previous level.

Press **MENU** button to exit the setup screen.

Listening to Radio

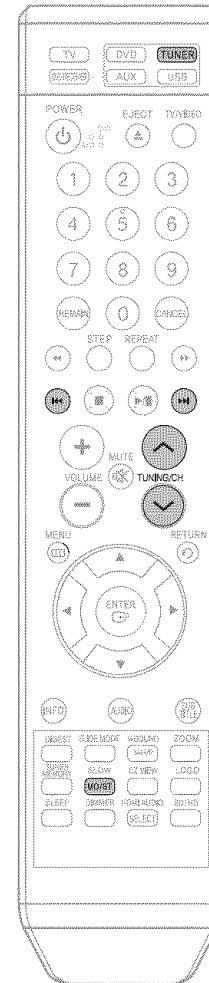

Remote Control Unit

1 Press the **TUNER** button to select the FM band.

2 Tune in to the desired station.

Automatic Tuning 1 When **◀▶▶▶** is pressed, a preset broadcast station is selected.

Automatic Tuning 2 Press and hold **TUNING/CH** to automatically search for active broadcasting stations.

Manual Tuning Briefly press **TUNING/CH** to increase or decrease the frequency incrementally.

Main Unit

1 Press the **Function** button to select the FM band.

2 Select a broadcast station.

Automatic Tuning 1 Press the **STOP** (■) button to select PRESET and then press **◀▶▶▶** button to select the preset station.

Automatic Tuning 2 Press the **STOP** (■) button to select "MANUAL" and then press and hold **◀▶▶▶** button to automatically search the band.

Manual Tuning Press **STOP** (■) to select MANUAL and then briefly press **◀▶▶▶** to tune in to a lower or higher frequency.

Press **MO/ST** button to listen in Mono/Stereo.
(This applies only when listening to an FM station.)

- Each time the button is pressed, the sound switches between "STEREO" and "MONO".
- In a poor reception area, select MONO for a clear, interference-free broadcast.

Presetting Stations

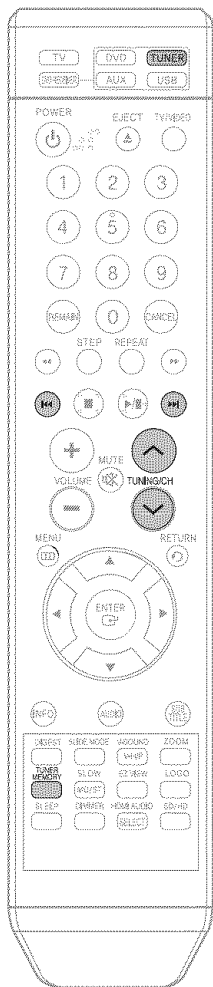

Example: Presetting FM 89.1 in the memory

1 Press the **TUNER** button to select the FM band.

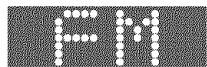

4 Press **◀▶▶▶▶** to select preset number.

- You can select between 1 and 15 presets.



Note • This unit does not receive AM broadcasts.

2 Press **TUNING/CH** to select "89.10".

- Refer to Step 2 on page 54 to automatically or manually tune in to a station.



3 Press the **TUNER MEMORY** button.

- "1" flashes in the display.



5 Press the **TUNER MEMORY** button again.

- Press the **TUNER MEMORY** button before 'number' disappears from the display.
- 'number' disappears from the display and the station is stored in memory.



6 To preset another station, repeat steps 2 to 5.

To tune in to a preset station, press **◀▶▶▶▶** on the remote control to select a channel.

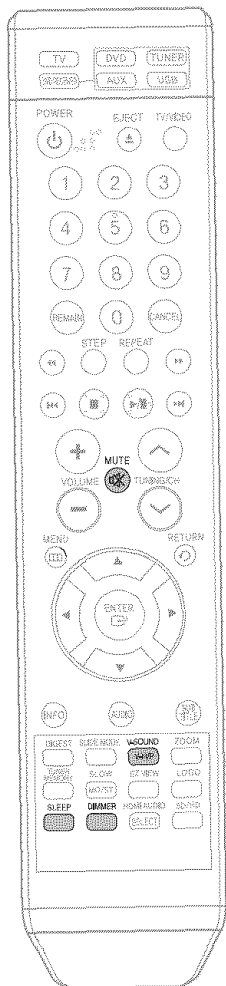

Sleep Timer Function

You can set the time that the Home Theater will shut itself off.

Press **SLEEP** button.

- " ⌚ " will be displayed. Each time the button is pressed, the preset time changes as follows: 10 → 20 → 30 → 60 → 90 → 120 → 150 → OFF.

To confirm the sleep timer setting, press **SLEEP** button.

- The remaining time before the Home Theater will shut itself off is displayed.
- Pressing the button again changes the sleep time from what you have set earlier.

To cancel the sleep timer, press **SLEEP** button until OFF appears on the display.

Adjusting Display Brightness

You can adjust the brightness of the display on the main unit so it won't interfere with your movie viewing.

Press **DIMMER** button.

- Each time the button is pressed, the brightness changes as follows: DARK → BRIGHT.

Mute Function

This is useful when answering a doorbell or telephone call.

Press **MUTE** button.

- ■00 appears in the display.
- To restore the sound, press the button again.

V-SOUND(Virtual Sound)

The 2-channel sounds can be listened with virtual effects for producing much more realistic sounds as in 5.1 channels.

Press **V-SOUND** button.

- Each time the button is pressed, the selection changes as follows: VIRTUAL SOUND ONE → VIRTUAL SOUND TWO → VIRTUAL SOUND OFF.

Virtual Headphone Function

Use headphones (not supplied) for private listening pleasure. You can enjoy dynamic sound effects similar to that of 5.1 channel surround sound using conventional stereo headphones.

1 Plug the headphones into the headphone jack.

- You can purchase headphones from most Electronics stores.

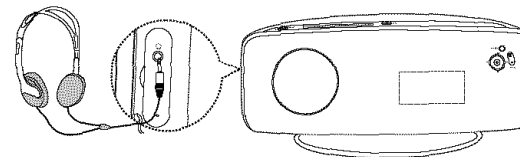

2 Press **V-H/P** button.

- Each time the button is pressed, the selection alternates between V.HP and OFF.
- **V.HP(VIRTUAL HEADPHONE ON)** : Select to enjoy a 5.1-channel surround sound that gives the feeling of being in a baseball park or concert hall.
- **OFF(VIRTUAL HEADPHONE OFF)** : Select to listen to a standard 2-channel stereo sound.

Note • Do not listen at extremely high volume levels when using headphones. Extended, high-volume listening can lead to permanent hearing loss.

Operating a TV with the Remote Control

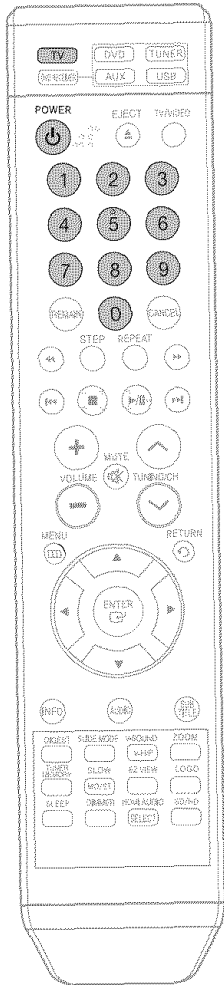

When operating a TV with the remote control

1 Press TV button to select TV mode.

2 Press POWER button to turn on the TV.

3 Point the remote control toward the TV.

4 While holding down POWER, enter the code corresponding to your brand of TV.

- If the code matches the TV's code, the TV will be turned off.
- If there is more than one code listed for your TV in the table, enter one at a time to determine which code works.

Example: For a Samsung TV
While holding down POWER, use the number buttons to enter 00, 15, 16, 17 and 40.

5 Point the remote control toward the TV and press POWER. If the TV turns off or on, the setting is complete.

- You can use the TV POWER, VOLUME, CHANNEL, and Numeric buttons (0~9).

Note

- The remote control may not work on some brands of TVs. Also, some operations may not be possible depending on your brand of TV.
- If you do not set the remote control with the code for your brand of TV, the remote control will work on a Samsung TV by default.

TV Brand Code List

No.	Brand	Code	No.	Brand	Code
1	Admiral (M.Wards)	56, 57, 58	44	MTC	18
2	A Mark	01, 15	45	NEC	18, 19, 20, 40, 59, 60
3	Anam	01, 02, 03, 04, 05, 06, 07, 08, 09, 10, 11, 12, 13, 14	46	Nikei	03
4	AOC	01, 18, 40, 148	47	Onking	03
5	Beli & Howell (M.Wards)	57, 58, 81	48	Onwa	03
6	Brocsonic	59, 60	49	Panasonic	06, 07, 08, 09, 54, 66, 67, 73, 74
7	Candle	18	50	Penney	18
8	Cetronic	03	51	Philco	03, 15, 17, 18, 48, 54, 59, 62, 69, 90
9	Citizen	03, 18, 25	52	Philips	15, 17, 18, 40, 48, 54, 62, 72
10	Cinema	97	53	Pioneer	63, 66, 80, 91
11	Classic	03	54	Portland	15, 18, 59
12	Concerto	18	55	Proton	40
13	Contec	46	56	Quasar	06, 66, 67
14	Coronado	15	57	Radio Shack	17, 48, 56, 60, 61, 75
15	Craig	03, 05, 61, 82, 83, 84	58	RCA/Proscan	18, 59, 67, 76, 77, 78, 92, 93, 94
16	Croslex	62	59	Realistic	03, 19
17	Crown	03	60	Sampo	40
18	Curtis Mates	59, 61, 63	61	Samsung	00, 15, 16, 17, 40, 43, 46, 47, 48, 49, 59, 60, 98
19	CXC	03	62	Sanyo	19, 61, 65
20	Daewoo	02, 03, 04, 15, 16, 17, 18, 19, 20, 21, 22, 23, 24, 25, 26, 28, 29, 30, 32, 34, 35, 36, 48, 59, 90	63	Scott	03, 40, 60, 61
21	Daytron	40	64	Sears	15, 18, 19
22	Dynasty	03	65	Sharp	15, 57, 64
23	Emerson	03, 15, 40, 46, 59, 61, 64, 82, 83, 84, 85	66	Signature 2000 (M.Wards)	57, 58
24	Fisher	19, 65	67	Sony	50, 51, 52, 53, 55
25	Funai	03	68	Soundesign	03, 40
26	Futuretech	03	69	Spectricon	01
27	General Electric (GE)	06, 40, 56, 59, 66, 67, 68	70	SSS	18
28	Hall Mark	40	71	Sylvania	18, 40, 48, 54, 59, 60, 62
29	Hitachi	15, 18, 50, 59, 69	72	Symphonic	61, 95, 96
30	Inkel	45	73	Tatung	06
31	JC Penny	56, 59, 67, 86	74	Techwood	18
32	JVC	70	75	Teknika	03, 15, 18, 25
33	KTV	59, 61, 87, 88	76	TMK	18, 40
34	KEC	03, 15, 40	77	Toshiba	19, 57, 63, 71
35	KMC	15	78	Vidtech	18
36	LG (Goldstar)	01, 15, 16, 17, 37, 38, 39, 40, 41, 42, 43, 44	79	Videch	59, 60, 69
37	Luxman	18	80	Wards	15, 17, 18, 40, 48, 54, 60, 64
38	LXI (Sears)	19, 54, 56, 59, 60, 62, 63, 65, 71	81	Yamaha	18
39	Magnavox	15, 17, 18, 48, 54, 59, 60, 62, 72, 89	82	York	40
40	Marantz	40, 54	83	Yupiteru	03
41	Matsui	54	84	Zenith	58, 79
42	MGA	18, 40	85	Zonda	01
43	Mitsubishi/MGA	18, 40, 59, 60, 75	86	Dongyang	03, 54

Before Calling for Service

Refer to the chart below when this unit does not function properly. If the problem you are experiencing is not listed below or if the instruction below does not help, turn off the unit, disconnect the power cord, and contact the nearest authorized dealer or Samsung Electronics Service Center.

Symptom	Check/Remedy
I cannot eject the disc.	<ul style="list-style-type: none"> Is the power cord plugged securely into the outlet? Turn off the power and then turn it back on.
Playback does not start.	<ul style="list-style-type: none"> Check the region number of the DVD. DVD discs purchased from abroad may not be playable. CD-ROMs and DVD-ROMs cannot be played on this Home Theater. Make sure that the rating level is correct.
Playback does not start immediately when the Play/Pause button is pressed.	<ul style="list-style-type: none"> Are you using a deformed disc or a disc with scratches on the surface? Wipe the disc clean.
Sound is not produced.	<ul style="list-style-type: none"> No sound is heard during fast playback, slow playback, and step motion playback. Are the speakers connected properly? Is the speaker setup correctly customized? Is the disc severely damaged?
<ul style="list-style-type: none"> Disc is rotating but no picture is produced. Picture quality is poor and picture is shaking. 	<ul style="list-style-type: none"> Is the TV power on? Are the video cables connected properly? Is the disc dirty or damaged? A poorly manufactured disc may not be playable.
The remote control does not work.	<ul style="list-style-type: none"> Is the remote control being operated within its operation range of angle and distance? Are the batteries exhausted? Have you selected the mode(TV/DVD) functions of the remote control (TV or DVD) correctly?

Symptom	Check/Remedy
Audio language and subtitles do not work.	<ul style="list-style-type: none"> Audio language and subtitles will not work for DVDs not containing them. And depending on the disc, they may work differently.
Menu screen does not appear even when the menu function is selected.	<ul style="list-style-type: none"> Are you using a disc that does not contain menus?
Aspect ratio cannot be changed.	<ul style="list-style-type: none"> You can play 16:9 DVDs in 16:9 WIDE mode, 4:3 LETTER BOX mode, or 4:3 PAN SCAN mode, but 4:3 DVDs can be seen in 4:3 ratio only. Refer to the DVD disc jacket and then select the appropriate function.
Can't receive radio broadcast.	<ul style="list-style-type: none"> Is the antenna connected properly? If the antenna's input signal is weak, install an external FM antenna in an area with good reception.
<ul style="list-style-type: none"> The main unit is not working. (Example: The power goes out or strange noise is heard.) The Home Theater is not working normally. 	<ul style="list-style-type: none"> Turn off the power and hold the ■ button on the main unit for longer than 5 seconds. <p>Using the RESET function will erase all stored settings. Do not use this unless necessary.</p>
The password for rating level has been forgotten.	<ul style="list-style-type: none"> While "NO DISC" message appears on the display of main unit, hold the main unit's ■ button for longer than 5 seconds. "INITIALIZE" appears on the display and all settings will return to the default values. Press the POWER button. <p>Using the RESET function will erase all stored settings. Do not use this unless necessary.</p>

Cautions on Handling and Storing Discs

Small scratches on the disc may reduce sound and picture quality or cause skipping. Be especially careful not to scratch discs when handling them.

Handling discs

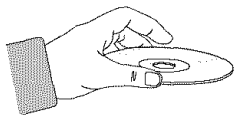

Do not touch the playback side of the disc. Hold the disc by the edges so that fingerprints will not get on the surface. Do not stick paper or tape on the disc.

Disc Storage

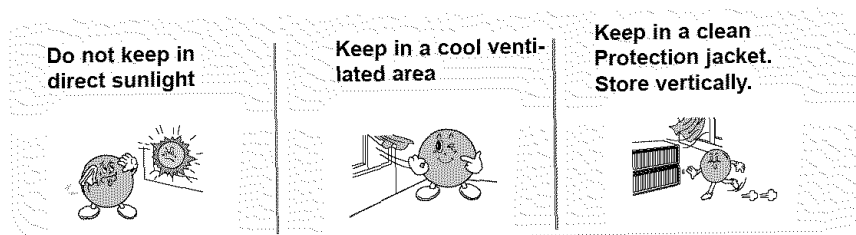

Caution

- Do not allow the discs to become contaminated with dirt.
- Do not load cracked or scratched discs.

Handling and Storing Discs



When you get fingerprints or dirt on the disc, clean it with a mild detergent diluted in water and wipe with a soft cloth.

- When cleaning, wipe gently from the inside to the outside of the disc.

Note

- Condensation may form if warm air comes into contact with cold parts inside the player. When condensation forms inside the player, the player may not operate correctly. If this occurs, remove the disc and let the player stand for 1 or 2 hours with the power on.

Language Code List

Enter the appropriate code number for the initial settings "Disc Audio", "Disc Subtitle" and/or "Disc Menu" (See page 43).

Code	Language	Code	Language	Code	Language	Code	Language
1027	Afar	1181	Frisian	1334	Latvian, Lettish	1506	Slovenian
1028	Abkhazian	1183	Irish	1345	Malagasy	1507	Samoa
1032	Afrikaans	1186	Scots Gaelic	1347	Maori	1508	Shona
1039	Amharic	1194	Galician	1349	Macedonian	1509	Somali
1044	Arabic	1196	Guarani	1350	Malayalam	1511	Albanian
1045	Assamese	1203	Gujarati	1352	Mongolian	1512	Serbian
1051	Aymara	1209	Hausa	1353	Moldavian	1513	Siswati
1052	Azerbaijani	1217	Hindi	1356	Marathi	1514	Sesotho
1053	Bashkir	1226	Croatian	1357	Malay	1515	Sundanese
1057	Byelorussian	1229	Hungarian	1358	Maltese	1516	Swedish
1059	Bulgarian	1233	Armenian	1363	Burmese	1517	Swahili
1060	Bihari	1235	Interlingua	1365	Nauru	1521	Tamil
1069	Bislama	1239	Interlingue	1369	Nepali	1525	Tegulu
1066	Bengali, Bangla	1245	Inupiak	1376	Dutch	1527	Tajik
1067	Tibetan	1248	Indonesian	1379	Norwegian	1528	Thai
1070	Breton	1253	Icelandic	1393	Occitan	1529	Tigrinya
1079	Catalan	1254	Italian	1403	(Afan) Oromo	1531	Turkmen
1093	Corsican	1257	Hebrew	1408	Oriya	1532	Tagalog
1097	Czech	1261	Japanese	1417	Punjabi	1534	Setswana
1103	Welsh	1269	Yiddish	1428	Polish	1535	Tonga
1105	Danish	1283	Javanese	1435	Pashto, Pushto	1538	Turkish
1109	German	1287	Georgian	1436	Portuguese	1539	Tsonga
1130	Bhutani	1297	Kazakh	1463	Quechua	1540	Tatar
1142	Greek	1298	Greenlandic	1481	Rhaeto-Romance	1543	Twi
1144	English	1299	Cambodian	1482	Kirundi	1557	Ukrainian
1145	Esperanto	1300	Kannada	1483	Romanian	1564	Urdu
1149	Spanish	1301	Korean	1489	Russian	1572	Uzbek
1150	Estonian	1305	Kashmiri	1491	Kinyarwanda	1581	Vietnamese
1151	Basque	1307	Kurdish	1495	Sanskrit	1587	Volapuk
1157	Persian	1311	Kirghiz	1498	Sindhi	1613	Wolof
1165	Finnish	1313	Latin	1501	Sangro	1632	Xhosa
1166	Fiji	1326	Lingala	1502	Serbo-Croatian	1665	Yoruba
1171	Faeroese	1327	Laothian	1503	Singhalese	1684	Chinese
1174	French	1332	Lithuanian	1505	Slovak	1697	Zulu

USB Host Feature Supported Products

Digital Camera

Product	Company	Type
Finepix-A340	Fuji	Digital Camera
Finepix-F810	Fuji	Digital Camera
Finepix-F610	Fuji	Digital Camera
Finepix-1450	Fuji	Digital Camera
Finepix 37000	Fuji	Digital Camera
Finepix A310	Fuji	Digital Camera
KD-310Z	Konica	Digital Camera
Finecam SL300R	Kyocera	Digital Camera
Finecam SL400R	Kyocera	Digital Camera
Finecam S5R	Kyocera	Digital Camera
Finecam Xt	Kyocera	Digital Camera
Dimage-Z1	Minolta	Digital Camera
Dimage Z1	Minolta	Digital Camera
Dimage X21	Minolta	Digital Camera
Coolpix4200	Nikon	Digital Camera
Coolpix4300	Nikon	Digital Camera
Coolpix 2200	Nikon	Digital Camera
Coolpix 3500	Nikon	Digital Camera
Coolpix 3700	Nikon	Digital Camera
Coolpix 4100	Nikon	Digital Camera
Coolpix 5200	Nikon	Digital Camera
Stylus 410 digital	Olympus	Digital Camera
300-digital	Olympus	Digital Camera
U300	Olympus	Digital Camera
X-350	Olympus	Digital Camera
C-760	Olympus	Digital Camera
C-5060	Olympus	Digital Camera
X1	Olympus	Digital Camera
U-mini	Olympus	Digital Camera
Lumix-FZ20	Panasonic	Digital Camera
DMC-FX7GD	Panasonic	Digital Camera
Lumix LC33	Panasonic	Digital Camera
LUMIX DMC-F1	Panasonic	Digital Camera
Optio-S40	Pentax	Digital Camera
Optio-S50	Pentax	Digital Camera
Optio 93LF	Pentax	Digital Camera
Optio MX	Pentax	Digital Camera
Digimax-420	Samsung	Digital Camera
Digimax-400	Samsung	Digital Camera
Sora PDR-T30	Toshiba	Digital Camera
Coolpix 5900	Nikon	Digital Camera
Coolpix S1	Nikon	Digital Camera
Coolpix 7600	Nikon	Digital Camera
DMC-FX7	Panasonic	Digital Camera
Dimage Xt	Minolta	Digital Camera
AZ.1	Olympus	Digital Camera

USB Flash Disk

Product	Company	Type
Cruzer Micro	Sandisk	USB 2.0 USB Flash Drive 128M
Cruzer Mini	Sandisk	USB 2.0 128M
Cruzer Mini	Sandisk	USB 2.0 256M
SONY Micro Vault	Sony	USB 2.0 64MB
FLEX DRIVE	Serotech	USB 2.0 32MB
AnyDrive	A.L tech	USB 2.0 128MB
XTICK	LG	USB 2.0 128M
Micro Mini	Imega	USB 2.0 128M
iFlash	Imation	USB 2.0 64M
LG	XTICK(M)	USB 2.0 64M
RIDATA	EZdrive	USB 2.0 64M

MP3 Player

Product	Company	Type
Creative MuVo NX128M	Creative	128 MB MP3 Player
Inver H320	Inver	20G HDD MP3 Player
YH-920	Samsung	20G HDD MP3 Player
YP-T7	Samsung	MP3 Player
YP-MT6	Samsung	MP3 Player
YP-T6	Samsung	MP3 Player
YP-53	Samsung	MP3 Player
YP-ST5	Samsung	MP3 Player
YP-T5	Samsung	MP3 Player
YP-60	Samsung	MP3 Player
YP-780	Samsung	MP3 Player
YP-35	Samsung	MP3 Player
YP-55	Samsung	MP3 Player
iAUDIO U2	Cowon	MP3 Player
iAUDIO G3	Cowon	MP3 Player
iAudio M3	Cowon	HDD MP3 Player
SI-M500L	Sharp	256MB MP3 Player
H10	Inver	MP3 Player
YP-T5 VB	Samsung	MP3 Player
YP-53	Samsung	256MB MP3 Player

Multi Card Reader

Product	Company	Type
UNICORN	Unicorn	USB 2.0 7 IN 1 CARD READER UC-601R
USB 2.0 Card Reader	Billion(Taiwan)	USB 2.0 Card Reader for SD/MMC/RS-MMC/CF/MS

USB External HDD

Product	Company	Type
CUTIE	Serotech	POCKET HARD DISK DRIVE
MOMOBAY UX-2	Dvico	USB 2.0

Specifications

GENERAL	Power Consumption	80W	
	Weight	11lbs	
	Dimensions (W x H x D)	20.5 x 12.6 x 7 inches	
	Operating Temperature Range	41°F ~ 95°F	
	Operating Humidity Range	10% ~ 75%	
TUNER	Usable Sensitivity	10dB	
	S/N Ratio	60dB	
	Distortion	0.5%	
OUTPUT	Composite Video	1.0Vp-p(75Ω load)	
	Component Video	Y:1.0Vp-p(75Ω load)	
		Pb:0.70Vp-p(75Ω load)	
	HDMI	Impedance: 85~115	
AMPLIFIER	Front speaker output	100W x 2(3Ω)	
	Subwoofer speaker output	100W(3Ω)	
	Frequency range	20Hz~20KHz	
	S/N Ratio	70dB	
	Channel separation	60dB	
	Input sensitivity	(AUX)400mV	
SPEAKER	Speaker system	2.1ch speaker system	
		Front speaker	Subwoofer speaker
	Impedance	3Ω	3Ω
	Frequency range	150Hz~20kHz	40Hz~200Hz
	Output sound pressure level	82dB/W/M	85dB/W/M
	Rated input	100W	100W
	Maximum input	200W	200W
	Dimensions (W x H x D)	3.8 x 18.9x 3 inches	7x 14.3 x 14.9 inches
Weights	1.45 lbs	3.2 lbs	

SAMSUNG Home Theater

Memo

LIMITED WARRANTY TO ORIGINAL PURCHASER

This SAMSUNG brand product, as supplied and distributed by Samsung Electronics America, Inc. (SAMSUNG) and delivered new, in the original carton to the original consumer purchaser, is warranted by SAMSUNG against manufacturing defects in materials and workmanship for a limited warranty period of:

One (1) Year Parts and Labor*
(*90 Days Parts and Labor for Commercial Use)

This limited warranty begins on the original date of purchase, and is valid only on products purchased and used in the United States. To receive warranty service, the purchaser must contact SAMSUNG for problem determination and service procedures. Warranty service can only be performed by a SAMSUNG authorized service center. The original dated bill of sale must be presented upon request as proof of purchase to SAMSUNG or SAMSUNG's authorized service center. Transportation of the product to and from the service center is the responsibility of the purchaser.

SAMSUNG will repair or replace this product, at our option and at no charge as stipulated herein, with new or reconditioned parts or products if found to be defective during the limited warranty period specified above. All replaced parts and products become the property of SAMSUNG and must be returned to SAMSUNG. Replacement parts and products assume the remaining original warranty, or ninety (90) days, whichever is longer.

SAMSUNG's obligations with respect to software products distributed by SAMSUNG under the SAMSUNG brand name are set forth in the applicable end user license agreement. Non-SAMSUNG hardware and software products, if provided, are on an "AS IS" basis. Non-SAMSUNG manufacturers, suppliers, publishers, and service providers may provide their own warranties.

This limited warranty covers manufacturing defects in materials and workmanship encountered in normal, and except to the extent otherwise expressly provided for in this statement, noncommercial use of this product, and shall not apply to the following, including, but not limited to: damage which occurs in shipment; delivery and installation; applications and uses for which this product was not intended; altered product or serial numbers; cosmetic damage or exterior finish; accidents, abuse, neglect, fire, water, lightning or other acts of nature; use of products, equipment, systems, utilities, services, parts, supplies, accessories, applications, installations, repairs, external wiring or connectors not supplied and authorized by SAMSUNG, or which damage this product or result in service problems; incorrect electrical line voltage, fluctuations and surges; customer adjustments and failure to follow operating instructions, cleaning, maintenance and environmental instructions that are covered and prescribed in the instruction book; product removal or reinstallation; reception problems and distortion related to noise, echo, interference or other signal transmission and delivery problems. SAMSUNG does not warrant uninterrupted or error-free operation of the product.

THERE ARE NO EXPRESS WARRANTIES OTHER THAN THOSE LISTED AND DESCRIBED ABOVE, AND NO WARRANTIES WHETHER EXPRESS OR IMPLIED, INCLUDING, BUT NOT LIMITED TO, ANY IMPLIED WARRANTIES OF MERCHANTABILITY OR FITNESS FOR A PARTICULAR PURPOSE, SHALL APPLY AFTER THE EXPRESS WARRANTY PERIODS STATED ABOVE, AND NO OTHER EXPRESS WARRANTY OR GUARANTY GIVEN BY ANY PERSON, FIRM OR CORPORATION WITH RESPECT TO THIS PRODUCT SHALL BE BINDING ON SAMSUNG. SAMSUNG SHALL NOT BE LIABLE FOR LOSS OF REVENUE OR PROFITS, FAILURE TO REALIZE SAVINGS OR OTHER BENEFITS, OR ANY OTHER SPECIAL, INCIDENTAL OR CONSEQUENTIAL DAMAGES CAUSED BY THE USE, MISUSE OR INABILITY TO USE THIS PRODUCT, REGARDLESS OF THE LEGAL THEORY ON WHICH THE CLAIM IS BASED, AND EVEN IF SAMSUNG HAS BEEN ADVISED OF THE POSSIBILITY OF SUCH DAMAGES. NOR SHALL RECOVERY OF ANY KIND AGAINST SAMSUNG BE GREATER IN AMOUNT THAN THE PURCHASE PRICE OF THE PRODUCT SOLD BY SAMSUNG AND CAUSING THE ALLEGED DAMAGE. WITHOUT LIMITING THE FOREGOING, PURCHASER ASSUMES ALL RISK AND LIABILITY FOR LOSS, DAMAGE OR INJURY TO PURCHASER AND PURCHASER'S PROPERTY AND TO OTHERS AND THEIR PROPERTY ARISING OUT OF THE USE, MISUSE OR INABILITY TO USE THIS PRODUCT SOLD BY SAMSUNG NOT CAUSED DIRECTLY BY THE NEGLIGENCE OF SAMSUNG. THIS LIMITED WARRANTY SHALL NOT EXTEND TO ANYONE OTHER THAN THE ORIGINAL PURCHASER OF THIS PRODUCT, IS NONTRANSFERABLE AND STATES YOUR EXCLUSIVE REMEDY.

Some states do not allow limitations on how long an implied warranty lasts, or the exclusion or limitation of incidental or consequential damages, so the above limitations or exclusions may not apply to you. This warranty gives you specific legal rights, and you may also have other rights which vary from state to state.

To obtain warranty hardware service, please contact SAMSUNG at:

SAMSUNG CUSTOMER CARE CENTER
400 Valley Road, Suite 201, Mt. Arlington, NJ 07856
1-800-SAMSUNG (1-800-726-7864) and www.samsung.com