



# Electric Built-In Cooktop

*Safety Information* ..... 2-4

*Operating Instructions* ..... 5

*Care and Cleaning*

Control Knobs ..... 6

Drip Pans ..... 8

Lift-Up Cooktop ..... 6

Metal Parts ..... 7

Packaging Tape ..... 6

Porcelain Enamel Cooktop .. 7

Stainless Steel Cooktop ..... 7

Surface Units ..... 8

*Installation Instructions*

Electrical Connections ..... 11

Electrical Requirements .... 10

Installation of the Cooktop .. 11

Location ..... 10

Tools You Will Need ..... 9

*Troubleshooting Tips* ..... 12

*Consumer Support*

Consumer Support ..... 14

Warranty ..... 13

**Owner's Manual &  
Installation Instructions**

JP328  
JP626

**Write the model and serial numbers here:**

**Model #** \_\_\_\_\_

**Serial #** \_\_\_\_\_

You can find them on a label under the cooktop.



## IMPORTANT SAFETY INFORMATION. READ ALL INSTRUCTIONS BEFORE USING.

### **WARNING!**

For your safety, the information in this manual must be followed to minimize the risk of fire or explosion, electric shock, or to prevent property damage, personal injury, or loss of life.

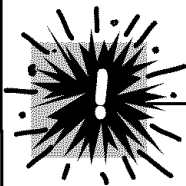

### SAFETY PRECAUTIONS

When using electrical appliances, basic safety precautions should be followed, including the following:

- Use this appliance only for its intended use as described in this manual.
  - Do not attempt to repair or replace any part of your cooktop unless it is specifically recommended in this manual. All other servicing should be referred to a qualified technician.
  - Before performing any service, disconnect the cooktop power supply at the household distribution panel by removing the fuse or switching off the circuit breaker.
  - Be sure your appliance is properly installed and grounded by a qualified technician in accordance with the provided installation instructions.
  - Have the installer show you the location of the circuit breaker or fuse. Mark it for easy reference.
  - Do not leave children alone—children should not be left alone or unattended in an area where an appliance is in use. They should never be allowed to sit or stand on any part of the appliance.
  - Teach children not to play with the controls or any other part of the cooktop.
  - Do not allow anyone to climb, stand or hang on the cooktop.
- **CAUTION:** Items of interest to children should not be stored in cabinets above a cooktop—children climbing on the cooktop to reach items could be seriously injured.
  - Always keep combustible wall covering, curtains or drapes a safe distance from your cooktop.
  - Always keep dish towels, dish cloths, pot holders and other linens a safe distance away from your cooktop.
  - Always keep wooden and plastic utensils and canned food a safe distance away from your cooktop.
  - Never wear loose-fitting or hanging garments while using the appliance. Flammable material could be ignited if brought in contact with hot surface units and may cause severe burns.
  - Use only dry pot holders—moist or damp pot holders on hot surfaces may result in burns from steam. Do not let pot holders touch hot surface units. Do not use a towel or other bulky cloth. Such cloths can catch fire on a hot surface unit.

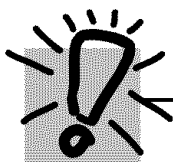

### COOK MEAT AND POULTRY THOROUGHLY...

Cook meat and poultry thoroughly—meat to at least an INTERNAL temperature of 160°F. and poultry to at least an INTERNAL temperature of 180°F. Cooking to these temperatures usually protects against foodborne illness.

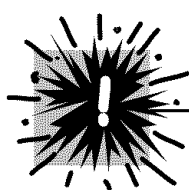

## **⚠ WARNING!** SAFETY PRECAUTIONS

- For your safety, never use your appliance for warming or heating the room.
- Do not use water on grease fires. Never pick up a flaming pan. Turn the controls off. Smother a flaming pan on a surface unit by covering the pan completely with well fitting lid, cookie sheet or flat tray. Use a multi-purpose dry chemical or foam-type extinguisher.
- Flaming grease outside a pan can be put out by covering with baking soda or, if available, by using a multi-purpose dry chemical or foam-type fire extinguisher.
- Do not flame foods on the cooktop. If you do flame foods under the hood, turn the fan on.
- Do not let cooking grease or other flammable materials accumulate on the cooktop.
- Do not touch surface units. These surfaces may be hot enough to burn even though they are dark in color. During and after use, do not touch, or let clothing or other flammable materials contact the surface units or areas nearby the surface units; allow sufficient time for cooling first.  
Potentially hot surfaces include the cooktop and areas facing the cooktop.
- To minimize the possibility of burns, ignition of flammable materials and spillage, the handle of a container should be turned toward the center of the cooktop without extending over any nearby surface units.
- Always turn the surface unit control to off before removing the cookware.
- To avoid the possibility of a burn or electric shock, always be certain that the controls for all surface units are at off position and all coils are cool before attempting to lift or remove the unit.
- Do not immerse or soak removable surface units. Do not put them in a dishwasher.
- Use proper pan size—Select cookware having flat bottoms large enough to cover the surface unit heating element. The use of undersized cookware will expose a portion of the surface unit to direct contact and may result in ignition of clothing. Proper relationship of cookware to burner will also improve efficiency.
- Never leave surface units unattended at high heat settings. Boilovers cause smoking and greasy spillovers that may catch on fire.
- Be sure the drip pans are not covered and are in place. Their absence during cooking could damage cooktop parts and wiring.
- Do not use aluminum foil to line the drip pans. Misuse could result in a shock, fire hazard or damage to the cooktop.

## **IMPORTANT SAFETY INFORMATION. READ ALL INSTRUCTIONS BEFORE USING.**



### **⚠ WARNING!** **SAFETY PRECAUTIONS**

- Only certain types of glass, glass/ceramic, earthenware or other glazed containers are suitable for cooktop cooking; others may break because of the sudden change in temperature.
- Never clean the cooktop surface when it is hot. Some cleaners produce noxious fumes and wet cloths could cause steam burns if used on a hot surface.
- Keep an eye on foods being fried at high or medium high heat settings.
- Foods for frying should be as dry as possible. Frost on frozen foods or moisture on fresh foods can cause hot fat to bubble up and over the sides of the pan.
- Use little fat for effective shallow or deep-fat frying. Filling the pan too full of fat can cause spillovers when food is added.
- If a combination of oils or fats will be used in frying, stir together before heating, or as fats melt slowly.
- Always heat fat slowly, and watch as it heats.
- Use a deep fat thermometer whenever possible to prevent overheating fat beyond the smoking point.
- Never try to move a pan of hot fat, especially a deep fat fryer. Wait until the fat is cool.
- Do not store flammable materials near the cooktop.
- Keep the hood and grease filters clean to maintain good venting and to avoid grease fires.
- Do not store or use combustible materials, gasoline or other flammable vapors and liquids in the vicinity of this or any appliance.
- Clean only parts listed in this Owner's Manual.
- Do not leave paper products, cooking utensils or food on the cooktop when not in use.
- Keep cooktop clean and free of accumulation of grease or spillovers which may ignite.
- Never heat unopened food containers. Pressure buildup may make container burst and cause injury.
- Never leave jars or cans of fat drippings on or near your cooktop.



**READ AND FOLLOW THIS SAFETY INFORMATION CAREFULLY.  
SAVE THESE INSTRUCTIONS**

# Using the surface units.

ge.com

Throughout this manual, features and appearance may vary from your model.

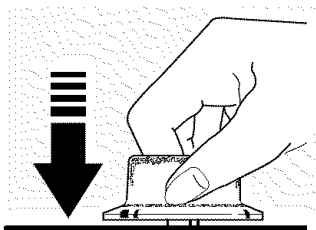

## How to Set

Push the knob in and turn in either direction to the setting you want.

At both **OFF** and **HI** the control **clicks** into position. You may hear slight **clicking** sounds during cooking, indicating the control is keeping the power level you set.

The control must be pushed in to set only from the **OFF** position. When the control is in any position other than **OFF**, it may be rotated without pushing it in.

If boiling water, for more efficient use, turn the knob to **HI** to bring it to a boil faster. After the water has come to a boil, reduce the knob setting to medium-high. The heat will still be great enough to maintain a boil, but you will be using less energy.

An indicator light will glow when **any** surface unit is on.

Be sure you turn the control knob to **OFF** when you finish cooking.

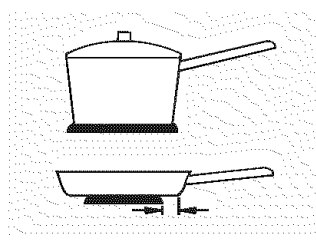

Not over 1 inch.

## Surface Cookware Tips

Use medium- or heavy-weight cookware. Aluminum cookware conducts heat faster than other metals. Cast-iron and coated cast-iron cookware are slow to absorb heat, but generally cook evenly at low to medium heat settings. Steel pans may cook unevenly if not combined with other metals.

For best cooking results, pans should be flat on the bottom. Match the size of the saucepan to the size of the surface unit. The pan should not extend over the edge of the surface unit more than 1 inch.

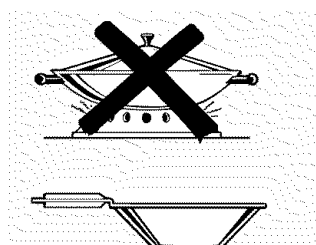

Use only flat-bottomed woks.

## Wok Cooking

We recommend that you use only a flat-bottomed wok. They are available at your local retail store.

Do not use woks that have support rings. Use of these types of woks, with or without the ring in place, can be dangerous.

Placing the ring over the surface unit will cause a buildup of heat that will damage the porcelain cooktop. Do not try to use such woks without the ring. You could be seriously burned if the wok tipped over.

## Deep Fat Frying

Foods for frying should be as dry as possible. Frost on frozen foods or moisture on fresh foods can cause hot fat to bubble up and over the sides of the pan.

Safety Instructions

Operating Instructions

Care and Cleaning

Troubleshooting Tips

Consumer Support

## Care and cleaning of the cooktop.

Be sure electrical power is off and all surfaces are cool before cleaning any part of the cooktop.

### How to Remove Packaging Tape

To assure no damage is done to the finish of the product, the safest way to remove the adhesive left from packaging tape on new appliances is an application of a household liquid dishwashing detergent, mineral oil or cooking oil.

Apply with a soft cloth and allow to soak. Wipe dry and then apply an appliance polish to thoroughly clean and protect the surface.

**NOTE:** The plastic tape must be removed from all chrome trim. It cannot be removed if it is baked on.

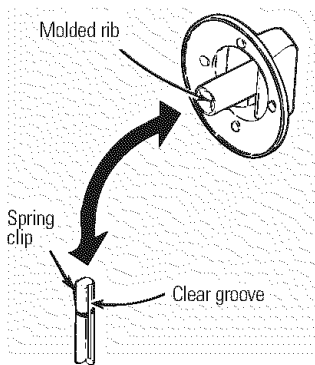

### Control Knobs

The control knobs may be removed for easier cleaning.

Make sure the knobs are in the **OFF** positions and pull them straight off the stems for cleaning.

The knobs can be cleaned in a dishwasher or they may also be washed with soap and water. Make sure the insides of the knobs are dry before replacing.

Replace the knobs in the **OFF** position to ensure proper placement.

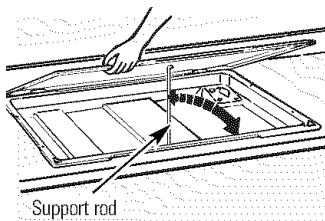

### Lift-Up Cooktop

Clean the area under the cooktop often. Built-up soil, especially grease, may catch on fire.

To make cleaning easier, the entire cooktop may be lifted. Be sure all surface units are turned off and are cool before raising the cooktop.

#### To clean the cooktop:

Use hot, soapy water and a clean cloth to clean the surface under the cooktop. To remove burned-on spills, use a cleansing powder. Rinse well, then polish with a dry cloth.

#### To lower the cooktop:

- 1 While holding the cooktop up with one hand, carefully disengage the support rod and return it to its original location.
- 2 Gently lower the cooktop.
- 3 Replace any drip pans and surface units that you removed.
- 4 Replace the control knobs.

#### To raise the cooktop:

- 1 Remove all four control knobs. See the *Control Knobs* section.
- 2 Remove one of the front surface units and drip pans and use this opening to grasp the cooktop. See the *Surface Units* and *Drip Pans* sections.
- 3 Lift the cooktop.
- 4 Raise the support rod into place and hook it onto the front lip of the cooktop to hold it in place while cleaning.

Be sure to secure the cooktop support rod in the cooktop front lip.

---

**Stainless Steel Surfaces** *(on some models)*

**Do not use a steel wool pad; it will scratch the surface.**

To clean the stainless steel surface, use warm sudsy water or a stainless steel cleaner or polish. Always wipe the surface in the direction of the grain. Follow the cleaner instructions for cleaning the stainless steel surface.

To inquire about purchasing stainless steel appliance cleaner or polish, or to find the location of a dealer nearest you, please call our toll-free number:

**National Parts Center**      **800.626.2002**  
**ge.com**

---

**Porcelain Enamel Cooktop** *(on some models)*

*The porcelain enamel finish is sturdy but breakable if misused.*

This finish is acid-resistant. However, any acidic foods spilled (such as fruit juices, tomato or vinegar) should not be permitted to remain on the finish.

If acids spill on the cooktop while it is hot, use a dry paper towel or cloth to wipe it up right away. When the surface has cooled, wash with soap and water. Rinse well.

For other spills such as fat splatterings, wash with soap and water or cleansing powders after the surface has cooled. Rinse well. Polish with a dry cloth.

---

**Metal Parts**

Do not use steel wool, abrasives, ammonia or commercial oven cleaners. To safely clean surfaces, wash, rinse and then dry with a soft cloth.

## Care and cleaning of the cooktop.

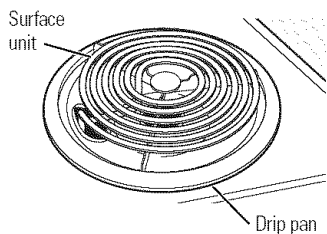

### Surface Units

To clean the surface units, turn the control to the highest setting for a minute. The coils will burn off any soil.

*Do not immerse the surface units in liquids of any kind.*

*Do not clean the surface units in a dishwasher.*

*Do not bend the surface unit plug terminals.*

*Do not attempt to clean, adjust or in any way repair the plug-in receptacle.*

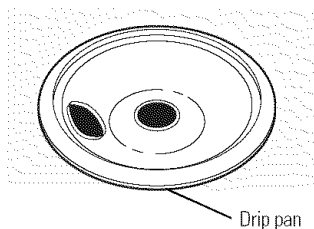

### Drip Pans

To remove the drip pans for cleaning, the surface units must be removed first.

#### To remove a surface unit:

Make sure the surface units and drip pans are completely cool before touching them.

Lift the surface unit about 1 inch above the drip pan and pull it out.

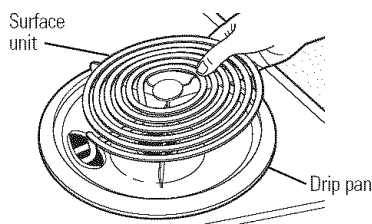

#### To replace the surface unit/drip pan:

**IMPORTANT:** Do not install the surface unit and drip pan separately into the cooktop because the surface unit may not lie flat on the drip pan when plugged in.

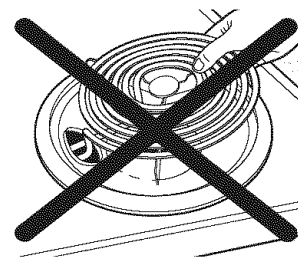

- Put the surface unit plug terminals through the side opening of the drip pan.

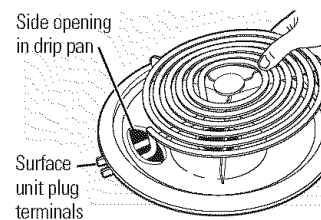

- Hold the assembled surface unit and drip pan together and slide the plug terminals into the plug-in receptacle.

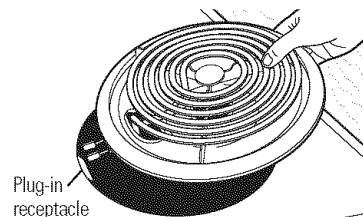

- Press the assemblies down to make sure they are flat on the cooktop.

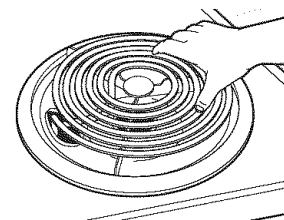

Do not lift the surface unit more than 1 inch. If you do, it may not lie flat on the drip pan when you plug it back in.

Repeated lifting of the surface unit more than 1 inch above the drip pan can permanently damage the receptacle.

#### To clean the drip pans:

Clean the drip pans by hand with warm, soapy water.

To remove burned-on foods, soak them in hot, soapy water for several hours. Then scrub with a soap-filled plastic scouring pad if necessary.

Rinse with clean water and polish with a clean soft cloth.

The drip pans may also be cleaned in a dishwasher.

Clean the area under the drip pans often. Built-up soil, especially grease, may catch fire.

*Do not cover the drip pans with foil. Using foil so close to the receptacle could cause shock, fire or damage to the cooktop.*



# Installation Instructions

# Electric Cooktop

JP328, JP626

**Questions?** Visit our Website at: [ge.com](http://ge.com) or Call 1.800.GE.CARES (800.432.2737).

## BEFORE YOU BEGIN

Read these instructions completely and carefully.

- **IMPORTANT** — Save these instructions for local inspector's use.
- **IMPORTANT** — Observe all governing codes and ordinances.
- **Note to Installer** — Be sure to leave these instructions with the Consumer.
- **Note to Consumer** — Keep these instructions for future reference.
- **WARNING:** For personal safety, this appliance must be properly grounded. See the **GROUNDING INSTRUCTIONS** section in these Installation Instructions.
- Proper installation is the responsibility of the installer.
- Product failure due to improper installation is not covered under the Warranty.

## TOOLS YOU WILL NEED

- Electric or hand drill and 1/8" drill bit
- Flat blade screwdriver
- Phillips screwdriver
- Pencil
- Ruler
- Hand or saber saw

## FOR TILE COUNTERTOP INSTALLATION

- Electric drill and 5/32" drill bit
- 4 1/16" x 1 1/4" masonry screws

## FOR YOUR SAFETY:

- **WARNING** — Before beginning the installation, switch power off at the service panel and lock the service disconnecting means to prevent power from being switched on accidentally. When the service disconnecting means cannot be locked, securely fasten a prominent warning device, such as a tag, to the service panel.
- To eliminate the risk of burns or fire by reaching over heated surface elements, cabinet storage located above the surface units should be avoided. If cabinet storage space is to be provided, the risk can be reduced by installing a range hood that projects horizontally a minimum of 5" beyond the bottom of the cabinets. Cabinet installation above the cooktop may be no deeper than 13".
- The cooktop should be easy to reach and lighted with natural light during the day.

## UNPACKING THE COOKTOP

Take cooktop from box and remove packing material:

- Paper under burner bowls
- Cardboard between cooktop and tub (must lift cooktop)
- Tape holding support rod

**This cooktop cannot be installed in countertops that cannot accept screws, such as granite or marble, etc.**

# Installation Instructions

## ELECTRICAL REQUIREMENTS

**ATTENTION:** All electric cooktops must be hard wired (direct wired) into an approved junction box. A plug and receptacle is not permitted for these products.

We recommend you have the electrical wiring and hookup of your cooktop done by a qualified electrician. After installation, have the electrician show you where your main disconnect is located.

Check with your local utilities for electrical codes which apply in your area. Failure to wire your cooktop according to governing codes could result in a hazardous condition. If there are no local codes, your cooktop must be wired and fused to meet the requirements of the National Electrical Code, ANSI/NFPA No. 70 Latest Edition. You can get a copy by writing:

National Fire Protection Association  
Batterymarch Park  
Quincy, MA 02269

You should use a single phase, three wire 240/120 Volt, 60 Hertz electrical power system. If aluminum wiring is used, all connections **MUST** be listed for use with aluminum and copper wiring. It is strongly recommended that if aluminum wiring is used, the special terminal grease for use with aluminum wiring, preferably with "grit", is put into the connection to keep it from corroding over time.

At a minimum, the National Electrical Code wire sizing in Section 310 should be followed. It is further recommended that No. 8 AWG copper (or No. 6 AWG aluminum) wire or larger if required, protected with either a double pole 40 Ampere circuit breaker or two 40 Ampere fuses, be used to supply power to the cooktop.

See the section on Electrical Connections for detailed instructions on hookup of your cooktop.

## PRODUCT DIMENSIONS AND CLEARANCES

This cooktop cannot be installed in countertops that cannot accept screws, such as granite or marble, etc. Counter space must be provided for installation of the cooktop. To insure accuracy, it is best to make a template when cutting the opening in the counter. See illustration below for all necessary dimensions.

When choosing a location, the following minimum clearances must be maintained between the cooktop and adjacent combustible surfaces:

- 30" (76.2 cm) minimum vertical clearance from the cooktop to the nearest overhead surface.
- 15" (38.1 cm) minimum vertical clearance to adjacent cabinets.

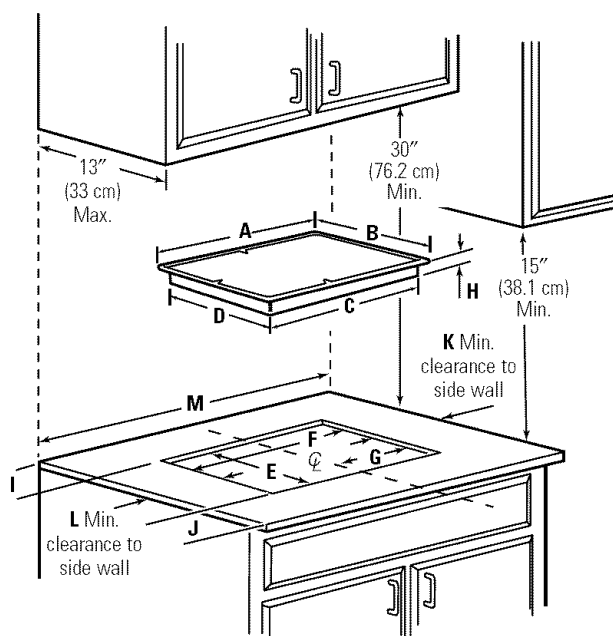

Cooktop and cutout dimensions

	Model		Model	
	JP328	JP626	JP328	JP626
<b>A</b>	30 $\frac{1}{4}$ " 76.8 cm	35 $\frac{1}{2}$ " 90.2 cm	<b>H</b>	3" min. 7.6 cm
<b>B</b>	21 $\frac{1}{4}$ " 54.0 cm	21" 53.3 cm	<b>I</b>	1 $\frac{3}{4}$ " min. 4.4 cm
<b>C</b>	28 $\frac{3}{8}$ " 72.1 cm	33 $\frac{1}{16}$ " 85.6 cm	<b>J</b>	3 $\frac{1}{2}$ " min. 8.9 cm
<b>D</b>	19 $\frac{3}{8}$ " 49.2 cm	18 $\frac{5}{16}$ " 48.1 cm	<b>K</b>	2" min. 5.1 cm
<b>E</b>	19 $\frac{1}{2}$ " 49.5 cm	19 $\frac{1}{8}$ " 48.6 cm	<b>L</b>	5 $\frac{1}{2}$ " min. 14.0 cm
<b>F</b>	28 $\frac{1}{2}$ " 72.4 cm	33 $\frac{3}{8}$ " 86.0 cm	<b>M</b>	33 $\frac{1}{4}$ " min. 84.5 cm
<b>G</b>	14 $\frac{1}{4}$ " 36.2 cm	16 $\frac{15}{16}$ " 43.0 cm		41 $\frac{1}{8}$ " min. 105 cm

# Installation Instructions

## 1 PREPARATION

Before installing the cooktop or moving it to another location, have the electrician verify:

- That your home is provided with adequate electrical service.
- That the addition of the cooktop will not overload the household circuit on which it is used.

## 2 INSTALL THE JUNCTION BOX

Install an approved junction box where it will be easily accessible through the front of the cabinet where cooktop will be located. See the illustration at right for the suggested mounting location.

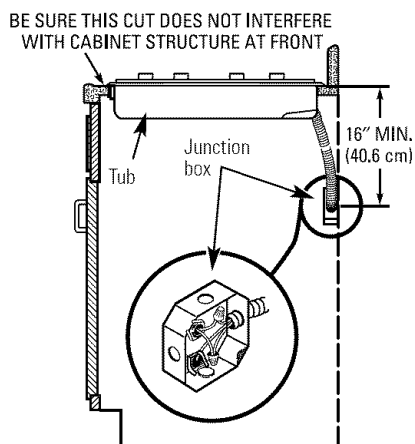

## 3 INSTALL THE COOKTOP

Install the cooktop in the cutout opening.

**NOTE:** If the cooktop is being installed in a blind counter (one with no cabinet opening below), wire connections must be made before putting the cooktop into the cutout.

Maintain 5" (12.7 cm) minimum vertical clearance between the cooktop bottom and any combustible surfaces.

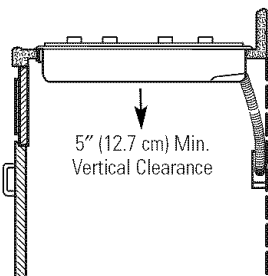

## 4 SECURE THE COOKTOP

Secure the tub of the cooktop to a standard counter with the wood screws shipped with the cooktop.

Secure the tub of the cooktop to a tile counter with 4 masonry screws. These can be purchased at any hardware store.

## 5 MAKE ELECTRICAL CONNECTIONS

### ⚠ WARNING

The electrical power to the cooktop supply line must be shut off while line connections are being made. Failure to do so could result in serious injury or death.

When making the wire connections, use the entire length of conduit provided (3 feet). The conduit must not be cut.

Connect the red and black leads from the cooktop conduit to the corresponding leads in the junction box.

The power leads supplied with this appliance are UL recognized for connection to larger gauge household wiring. The insulation of the leads is rated at much higher temperatures than the temperature rating of household wiring. The current carrying capacity of the conductor is governed by the wire gauge and also the temperature rating of the insulation around the wire.

### GROUNDING INSTRUCTIONS

The bare ground wire in the conduit is connected to the cooktop frame.

When connecting to a 3 conductor branch circuit, if local codes permit, connect the bare ground connector lead of the cooktop to the branch circuit neutral (gray or white in color).

**Effective January 1, 1996, the National Electrical Code requires that new construction use a (4) conductor connection and will not permit grounding through neutral. If used in new construction after January 1, 1996, in a mobile home or recreational vehicle, or if local codes do not permit grounding through the neutral white lead, do the following:**

Attach the appliance grounding lead (green or bare copper) to the residence grounding conductor (green or bare copper) in accordance with local codes.

## MODEL AND SERIAL NUMBER LOCATION

You can find them on a nameplate label under the cooktop.

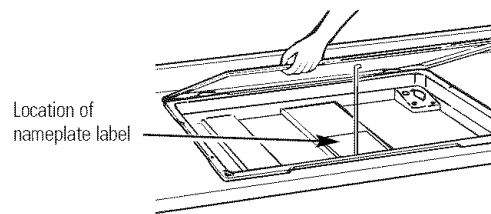

## Before you call for service...



### Troubleshooting Tips

Save time and money! Review the chart on this page first and you may not need to call for service.

<b>Problem</b>	<b>Possible Causes</b>	<b>What To Do</b>
<b>Surface units not functioning properly</b>	The surface units are not plugged in solidly.	<ul style="list-style-type: none"> <li>• With the controls off, check to make sure the surface unit is plugged completely into the receptacle.</li> </ul>
	The surface unit controls improperly set.	<ul style="list-style-type: none"> <li>• Check to see the correct control is set for the surface unit you are using.</li> </ul>
	The drip pans are not set securely in the cooktop.	<ul style="list-style-type: none"> <li>• With the controls off, check to make sure the drip pan is in the recess in the cooktop and that the opening in the pan lines up with the receptacle.</li> </ul>
	A fuse in your home may be blown or the circuit breaker tripped.	<ul style="list-style-type: none"> <li>• Replace the fuse or reset the circuit breaker.</li> </ul>

# GE Built-In Cooktop Warranty.

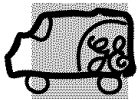

All warranty service provided by our Factory Service Centers, or an authorized Customer Care® technician. To schedule service, on-line, 24 hours a day, visit us at [ge.com](http://ge.com), or call 800.GE.CARES (800.432.2737). Please have serial number and model number available when calling for service.

Staple your receipt here.  
Proof of the original purchase date is needed to obtain service under the warranty.

## For The Period Of: We Will Replace:

### One Year

From the date of the original purchase

**Any part** of the cooktop which fails due to a defect in materials or workmanship. During this **limited one-year warranty**, GE will also provide, **free of charge**, all labor and in-home service to replace the defective part.

## What GE Will Not Cover:

- Service trips to your home to teach you how to use the product.
- Improper installation, delivery or maintenance.
- Failure of the product if it is abused, misused, or used for other than the intended purpose or used commercially.
- Replacement of house fuses or resetting of circuit breakers.
- Damage to the product caused by accident, fire, floods or acts of God.
- Incidental or consequential damage caused by possible defects with this appliance.
- Damage caused after delivery.
- Product not accessible to provide required service.

**EXCLUSION OF IMPLIED WARRANTIES**—Your sole and exclusive remedy is product repair as provided in this Limited Warranty. Any implied warranties, including the implied warranties of merchantability or fitness for a particular purpose, are limited to one year or the shortest period allowed by law.

This warranty is extended to the original purchaser and any succeeding owner for products purchased for home use within the USA. If the product is located in an area where service by a GE Authorized Servicer is not available, you may be responsible for a trip charge or you may be required to bring the product to an Authorized GE Service Location for service. In Alaska, the warranty excludes the cost of shipping or service calls to your home.

Some states do not allow the exclusion or limitation of incidental or consequential damages. This warranty gives you specific legal rights, and you may also have other rights which vary from state to state. To know what your legal rights are, consult your local or state consumer affairs office or your state's Attorney General.

Warrantor: General Electric Company, Louisville, KY 40225

Safety Instructions

Operating Instructions

Care and Cleaning

Troubleshooting Tips

Consumer Support

## Consumer Support

---



### GE Appliances Website

**ge.com**

Have a question or need assistance with your appliance? Try the GE Appliances Website 24 hours a day, any day of the year! For greater convenience and faster service, you can now download Owner's Manuals, order parts, catalogs, or even schedule service on-line. You can also "Ask Our Team of Experts™" your questions, and so much more...

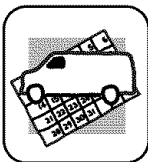

### Schedule Service

**ge.com**

Expert GE repair service is only one step away from your door. Get on-line and schedule your service at your convenience 24 hours any day of the year! Or call 800.GE.CARES (800.432.2737) during normal business hours.

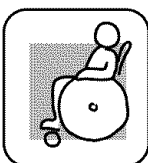

### Real Life Design Studio

**ge.com**

GE supports the Universal Design concept—products, services and environments that can be used by people of all ages, sizes and capabilities. We recognize the need to design for a wide range of physical and mental abilities and impairments. For details of GE's Universal Design applications, including kitchen design ideas for people with disabilities, check out our Website today. For the hearing impaired, please call 800.TDD.GEAC (800.833.4322).



### Extended Warranties

**ge.com**

Purchase a GE extended warranty and learn about special discounts that are available while your warranty is still in effect. You can purchase it on-line anytime, or call 800.626.2224 during normal business hours. GE Consumer Home Services will still be there after your warranty expires.

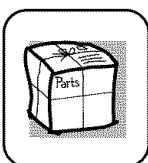

### Parts and Accessories

**ge.com**

Individuals qualified to service their own appliances can have parts or accessories sent directly to their homes (VISA, MasterCard and Discover cards are accepted). Order on-line today, 24 hours every day or by phone at 800.626.2002 during normal business hours.

**Instructions contained in this manual cover procedures to be performed by any user. Other servicing generally should be referred to qualified service personnel. Caution must be exercised, since improper servicing may cause unsafe operation.**



### Contact Us

**ge.com**

If you are not satisfied with the service you receive from GE, contact us on our Website with all the details including your phone number, or write to: General Manager, Customer Relations  
GE Appliances, Appliance Park  
Louisville, KY 40225



### Register Your Appliance

**ge.com**

**Register your new appliance on-line—at your convenience!** Timely product registration will allow for enhanced communication and prompt service under the terms of your warranty, should the need arise. You may also mail in the pre-printed registration card included in the packing material.