

DVD Recorder

Operating Instructions

RDR-GX330



WARNING

To reduce the risk of fire or electric shock, do not expose this apparatus to rain or moisture.

To avoid electrical shock, do not open the cabinet. Refer servicing to qualified personnel only.

The AC power cord must be changed only at a qualified service shop.

CAUTION

The use of optical instruments with this product will increase eye hazard. As the laser beam used in this DVD recorder is harmful to eyes, do not attempt to disassemble the cabinet.

Refer servicing to qualified personnel only.

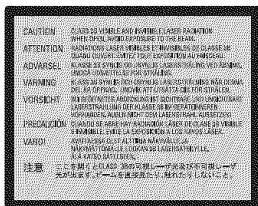

This label is located on the laser protective housing inside the enclosure.



This symbol is intended to alert the user to the presence of uninsulated "dangerous voltage" within the product's enclosure that may be of sufficient magnitude to constitute a risk of electric shock to persons.



This symbol is intended to alert the user to the presence of important operating and maintenance (servicing) instructions in the literature accompanying the appliance.

For customers in the U.S.A. Owner's Record

The model and serial numbers are located at the rear of the unit.

Record the serial number in the space provided below. Refer to them whenever you call upon your Sony dealer regarding this product.

Model No. RDR-GX330

Serial No. _____

CAUTION

You are cautioned that any changes or modifications not expressly approved in this manual could void your authority to operate this equipment.

Note

This equipment has been tested and found to comply with the limits for a Class B digital device, pursuant to Part 15 of the FCC Rules. These limits are designed to provide reasonable protection against harmful interference in a residential installation. This equipment generates, uses, and can radiate radio frequency energy and, if not installed and used in accordance with the instructions, may cause harmful interference to radio communications. However, there is no guarantee that interference will not occur in a particular installation. If this equipment does cause harmful interference to radio or television reception, which can be determined by turning the equipment off and on, the user is encouraged to try to correct the interference by one or more of the following measures:

- Reorient or relocate the receiving antenna.
- Increase the separation between the equipment and receiver.
- Connect the equipment into an outlet on a circuit different from that to which the receiver is connected.
- Consult the dealer or an experienced radio/TV technician for help.

Precaution

Install this system so that the AC power cord can be unplugged from the wall socket immediately in the event of trouble.

Precautions

This equipment has been tested and found to comply with the limits set out in the EMC Directive using a connection cable shorter than 3 meters.

On safety

Should any solid object or liquid fall into the cabinet, unplug the recorder and have it checked by qualified personnel before operating it any further.

On power sources

- The recorder is not disconnected from the AC power source as long as it is connected to the wall outlet, even if the recorder itself has been turned off.
- If you are not going to use the recorder for a long time, be sure to disconnect the recorder from the wall outlet. To disconnect the AC power cord, grasp the plug itself; never pull the cord.

On placement

- Place the recorder in a location with adequate ventilation to prevent heat build-up in the recorder.
- Do not place the recorder on a soft surface such as a rug that might block the ventilation holes.
- Do not place the recorder in a confined space such as a bookshelf or similar unit.
- Do not place the recorder in a location near heat sources, or in a place subject to direct sunlight, excessive dust, or mechanical shock.
- Do not place the recorder in an inclined position. It is designed to be operated in a horizontal position only.
- Keep the recorder and discs away from equipment with strong magnets, such as microwave ovens, or large loudspeakers.
- Do not place heavy objects on the recorder.

- To prevent fire or shock hazard, do not place objects filled with liquids, such as vases, on the apparatus.

On recording

Make trial recordings before making the actual recording.

On compensation for lost recordings

Sony is not liable and will not compensate for any lost recordings or relevant losses, including when recordings are not made due to reasons including recorder failure, or when the contents of a recording are lost or damaged as a result of recorder failure or repair undertaken to the recorder. Sony will not restore, recover, or replicate the recorded contents under any circumstances.

Copyrights

- Television programs, films, video tapes, discs, and other materials may be copyrighted. Unauthorized recording of such material may be contrary to the provisions of the copyright laws. Also, use of this recorder with cable television transmission may require authorization from the cable television transmitter and/or program owner.
- This product incorporates copyright protection technology that is protected by U.S. patents and other intellectual property rights. Use of this copyright protection technology must be authorized by Macrovision, and is intended for home and other limited viewing uses only unless otherwise authorized by Macrovision. Reverse engineering or disassembly is prohibited.

Copy guard function

Since the recorder has a copy guard function, programs received through an external tuner (not supplied) may contain copy protection signals (copy guard function) and as such may not be recordable, depending on the type of signal.

IMPORTANT NOTICE

Caution: This recorder is capable of holding a still video image or on-screen display image on your television screen indefinitely. If you leave the still video image or on-screen display image displayed on your TV for an extended period of time you risk permanent damage to your television screen. Plasma display panels and projection televisions are especially susceptible to this.

If you have any questions or problems concerning your recorder, please consult your nearest Sony dealer.

Important Safety Instructions

- 1) Read these instructions.
- 2) Keep these instructions.
- 3) Heed all warnings.
- 4) Follow all instructions.
- 5) Do not use this apparatus near water.
- 6) Clean only with dry cloth.
- 7) Do not block any ventilation openings. Install in accordance with the manufacturer's instructions.
- 8) Do not install near any heat sources such as radiators, heat registers, stoves, or other apparatus (including amplifiers) that produce heat.
- 9) Do not defeat the safety purpose of the polarized or grounding-type plug. A polarized plug has two blades with one wider than the other. A grounding type plug has two blades and a third grounding prong. The wide blade or the third prong are provided for your safety. If the provided plug does not fit into your outlet, consult an electrician for replacement of the obsolete outlet.
- 10) Protect the power cord from being walked on or pinched particularly at plugs, convenience receptacles, and the point where they exit from the apparatus.
- 11) Only use attachments/accessories specified by the manufacturer.
- 12) Use only with the cart, stand, tripod, bracket, or table specified by the manufacturer, or sold with the apparatus. When a cart is used, use caution when moving the cart/apparatus combination to avoid injury from tip-over.



- 13) Unplug this apparatus during lightning storms or when unused for long periods of time.

- 14) Refer all servicing to qualified service personnel. Servicing is required when the apparatus has been damaged in any way, such as power-supply cord or plug is damaged, liquid has been spilled or objects have fallen into the apparatus, the apparatus has been exposed to rain or moisture, does not operate normally, or has been dropped.

About this manual

- In this manual, “disc” is used as a general reference for the DVDs or CDs unless otherwise specified by the text or illustrations.
- Icons, such as **DVD**, listed at the top of each explanation indicate what kind of media can be used with the function being explained.
- Instructions in this manual describe the controls on the remote. You can also use the controls on the recorder if they have the same or similar names as those on the remote.
- The on-screen display illustrations used in this manual may not match the graphics displayed on your TV screen.
- The explanations regarding DVDs in this manual refer to DVDs created on this recorder. The explanations do not apply to DVDs that are created on other recorders and played back on this recorder.

Table of Contents

WARNING	2
Precautions	3
Quick Guide to Disc Types	8
Recordable and playable discs	8
Playable discs	10

Hookups and Settings 12

Hooking Up the Recorder	12
Step 1: Connecting the Antenna Cable	12
A: Cable box or satellite receiver with a video/audio output	13
B: Cable box with an antenna output only	14
C: Cable without cable box, or antenna only (no cable TV)	15
Step 2: Connecting the Video Cords	16
Step 3: Connecting the Audio Cords	18
Step 4: Connecting the AC Power Cord	19
Step 5: Preparing the Remote	20
Controlling TVs with the remote	20
If you have a Sony DVD player or more than one Sony DVD recorder	21
Changing channels of the recorder using the remote	22
Step 6: Easy Setup	23
Connecting a VCR or Similar Device	24
Connecting to the LINE 1 IN jacks	24
Connecting to the LINE 2 IN jacks on the front panel	25
Connecting to a Satellite or Digital Tuner	26

Eight Basic Operations — Getting to Know Your DVD Recorder















1. Inserting a Disc	27
2. Recording a Program	27
Checking the disc status while recording	28
3. Playing the Recorded Program (Title List)	28
4. Displaying the Playing/Remaining Time and Play Information	30
Checking the playing/remaining time	31
Checking the remaining disc space	32
5. Changing the Name of a Recorded Program	33
6. Labeling and Protecting a Disc	34
Labeling a disc	34
Protecting a disc	35
7. Playing the Disc on Other DVD Equipment (Finalize)	35
Finalizing the disc using ▲ OPEN/CLOSE button	36
Finalizing the disc using “Disc Information” display	36
Unfinalizing a disc	37
8. Reformatting a disc	37

Timer Recording	39
Before Recording	39
Recording mode	39
Recording a stereo/SAP program	40
Unrecordable pictures	40
Timer Recording	40
Using the Quick Timer function	42
Adjusting the recording picture quality and size	42
Creating chapters in a title	43
Checking/Changing/Canceling Timer Settings (Timer List)	44
Changing the priority of overlapped settings	45
Recording From Connected Equipment	47
Recording from connected equipment with a timer (Synchro Rec)	47
Recording from connected equipment without a timer	48
Playback	49
Playing	49
Playback options	51
Adjusting the picture quality	52
Adjusting the delay between the picture and sound (AV SYNC)	53
Playing from the beginning of the program you are recording (Chasing Playback)	53
Playing a previous recording while making another (Simultaneous Rec and Play)	54
Searching for a Title/Chapter/Track, etc.	54
Playing MP3 Audio Tracks or JPEG Image Files	55
About MP3 audio tracks and JPEG image files	56
MP3 audio tracks or JPEG image files that the recorder can play	57
About playback order of albums, tracks, and files	57
Erasing and Editing	59
Before Editing	59
Erasing and Editing a Title	60
Erasing multiple titles (Erase Titles)	60
Erasing a section of a title (A-B Erase)	61
Creating chapters manually	62
Creating and Editing a Playlist	62
Moving a Playlist title (Change Order)	64
Combining multiple Playlist titles (Combine Titles)	64
Dividing a Playlist title (Divide Title)	65
DV/Digital8 Dubbing	66
Before DV/Digital8 Dubbing	66
Preparing for DV/Digital8 dubbing	66
Recording an Entire DV Format Tape (One Touch Dubbing)	68
Program Edit	68

Settings and Adjustments	71
Antenna Reception and Language Settings (Basic)	71
Tuner Preset	71
Clock	72
OSD (On-Screen Display)	73
Video Settings (Video)	74
Audio Settings (Audio)	76
Recording Settings (Recording)	78
Disc Settings (DVD)	79
Remote Control Settings/Factory Settings (Others)	81
Easy Setup (Resetting the Recorder)	82
<hr/>	
Additional Information	83
Troubleshooting	83
Self-diagnosis Function (When letters/numbers appear in the display)	88
Notes About This Recorder	88
Specifications	89
About i.LINK	90
Guide to Parts and Controls	92
Language Code List	95
Area Code	95
Index	96

Quick Guide to Disc Types

Recordable and playable discs

Type		Disc Logo	Icon used in this manual	Formatting (new discs)	Compatibility with other DVD players (finalizing)
DVD+RW		 DVD+ReWritable  DVD+ReWritable		Automatically formatted in +VR mode (DVD+RW VIDEO)	Playable on DVD+RW compatible players (automatically finalized)
DVD-RW	VR mode	 DVD-RW		Format in VR mode (page 27)	Playable only on VR mode compatible players (finalization unnecessary)
	Video mode	 DVD-RW 		Format in Video mode (page 27)	Playable on most DVD players (finalization necessary) (page 35)
DVD+R		 DVD+R		Automatically formatted in +VR mode (DVD+R VIDEO)	Playable on most DVD players (finalization necessary) (page 35)
DVD+R DL		 DVD+R DL			
DVD-R	VR mode	 DVD-R R4.7		Format in VR mode (page 27)*1 Formatting is performed using the "Disc Information" display.	Playable only on DVD-R in VR mode compatible players (finalization necessary) (page 35)
	Video mode			Automatically formatted in Video mode	Playable on most DVD players (finalization necessary) (page 35)

Usable disc versions (as of March 2006)

- 8x-speed or slower DVD+RWs
- 6x-speed or slower DVD-RWs (Ver.1.1, Ver.1.2 with CPRM^{*2})
- 16x-speed or slower DVD+Rs
- 16x-speed or slower DVD-Rs (Ver.2.0, Ver.2.1 with CPRM^{*2})
- 8x-speed or slower DVD+R DL (Double Layer) discs

“DVD+RW,” “DVD-RW,” “DVD+R,” “DVD+R DL,” and “DVD-R” are trademarks.









^{*1} When an unformatted DVD-R is inserted into this recorder, it is automatically formatted in Video mode. To format a new DVD-R in VR mode, format using the “Disc Information” display (page 27).

^{*2} CPRM (Content Protection for Recordable Media) is a coding technology that protects copyrights for images.

Discs that cannot be recorded on

- 8 cm discs
- DVD-R DL (Dual Layer) discs

Playable discs

Type	Disc Logo	Icon used in this manual	Characteristics
DVD VIDEO			Discs such as movies that can be purchased or rented This recorder also recognizes DVD-R Dual Layer (Video mode) discs as DVD Video compatible discs.
VIDEO CD			VIDEO CDs or CD-Rs/CD-RWs in VIDEO CD/Super VIDEO CD format
CD			Music CDs or CD-Rs/CD-RWs in music CD format
DATA DVD	—		DVD+RWs/DVD+Rs/DVD-RWs/ DVD-Rs/DVD-ROMs containing JPEG image files
DATA CD	—		CD-ROMs/CD-Rs/CD-RWs containing either MP3 audio tracks or JPEG image files
8 cm DVD+RW/ DVD-RW/DVD-R	—	—	8 cm DVD+RW, DVD-RW, and DVD-R recorded with a DVD video camera (Still images recorded with a DVD video camera cannot be played.)

“DVD VIDEO” and “CD” are trademarks.

Discs that cannot be played

- PHOTO CDs
- CD-ROMs/CD-Rs/CD-RWs that are recorded in a format different from the formats mentioned in the table above.
- Data part of CD-Extras
- DVD-ROMs/DVD+RWs/DVD-RWs/
DVD+Rs/DVD-Rs that do not contain DVD Video or JPEG image files.
- DVD Audio discs
- DVD-RAMs
- HD layer on Super Audio CDs
- DVD VIDEOS with a different region code (page 11).
- DVDs that were recorded on a different recorder and not correctly finalized.
- A disc recorded in a color system other than NTSC, such as PAL

Maximum recordable number of titles

Disc	Number of titles*
DVD-RW/DVD-R	99
DVD+RW/DVD+R	49
DVD+R DL	49

* The maximum length for one title is eight hours.

Note on playback operations of DVD VIDEOS/VIDEO CDs

Some playback operations of DVD VIDEOS/VIDEO CDs may be intentionally set by software producers. Since this recorder plays DVD VIDEOS/VIDEO CDs according to the disc contents the software producers designed, some playback features may not be available. See the instructions supplied with the DVD VIDEOS/VIDEO CDs.

Region code (DVD VIDEO only)

Your recorder has a region code printed on the rear of the unit and will only play DVD VIDEOS (playback only) labeled with identical region codes. This system is used to protect copyrights.

DVD VIDEOS labeled  will also play on this recorder.

If you try to play any other DVD VIDEO, the message "Playback prohibited by region code." will appear on the TV screen.

Depending on the DVD VIDEO, no region code indication may be labeled even though playing the DVD VIDEO is prohibited by area restrictions.

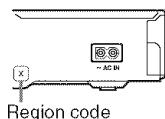

Music discs encoded with copyright protection technologies

This product is designed to play back discs that conform to the Compact Disc (CD) standard.

Recently, various music discs encoded with copyright protection technologies are being marketed by some record companies. Please be aware that among those discs, there are some that do not conform to the CD standard and may not be playable by this product.

Note on DualDiscs

A DualDisc is a two sided disc product which mates DVD recorded material on one side with digital audio material on the other side. However, since the audio material side does not conform to the Compact Disc (CD) standard, playback on this product is not guaranteed.

Notes

- Some DVD+RWs/DVD+Rs, DVD-RWs/DVD-Rs, or CD-RWs/CD-Rs cannot be played on this recorder due to the recording quality or physical condition of the disc, or the characteristics of the recording device and authoring software. The disc will not play if it has not been correctly finalized. For more information, see the operating instructions for the recording device.
- You cannot mix VR mode and Video mode on the same DVD-RW. To change the disc's format, reformat the disc (page 37). Note that the disc's contents will be erased after reformatting.
- You cannot shorten the time required for recording even with high-speed discs.
- It is recommended that you use discs with "For Video" printed on their packaging.
- You cannot add new recordings to DVD+Rs, DVD-Rs, or DVD-RWs (Video mode) that contain recordings made on other DVD equipment.
- In some cases, you may not be able to add new recordings to DVD+RWs that contain recordings made on other DVD equipment. If you do add a new recording, note that this recorder will rewrite the DVD menu.
- You cannot edit recordings on DVD+RWs, DVD-RWs (Video mode), DVD+Rs, or DVD-Rs that are made on other DVD equipment.
- If the disc contains PC data unrecognizable by this recorder, the data may be erased.
- You may not be able to record on some recordable discs, depending on the disc.

Hooking Up the Recorder

Follow steps 1 through 6 to hook up and adjust the settings of the recorder. Do not connect the AC power cord until you reach “Step 4: Connecting the AC Power Cord” on page 19.

Notes

- See “Specifications” (page 89) for a list of supplied accessories.
- Plug in cords securely to prevent unwanted noise.
- Refer to the instructions supplied with the components to be connected.
- You cannot connect this recorder to a TV that does not have a video input jack.
- Be sure to disconnect the AC power cord of each component before connecting.

Step 1: Connecting the Antenna Cable

Select one of the following antenna hookups.

If you have	Hookup
A: Cable box or satellite receiver with a video/audio output	A (page 13)
B: Cable box with an antenna output only	B (page 14)
C: Cable without cable box, or antenna only (no cable TV)	C (page 15)

NOTE TO CATV SYSTEM INSTALLER (IN USA)

This reminder is provided to call the CATV system installer’s attention to Article 820- 40 of the NEC that provides guidelines for proper grounding and, in particular, specifies that the cable ground shall be connected to the grounding system of the building, as close to the point of cable entry as practical.

Notes

- If your antenna is a flat cable (300-ohm twin lead cable), use an external antenna connector (not supplied) to connect the antenna to the recorder.
- If you have separate cables for VHF and UHF antennas, use a UHF/VHF band mixer (not supplied) to connect the antenna to the recorder.

A: Cable box or satellite receiver with a video/audio output

With this hookup, you can record any channel on the cable box or satellite receiver. Be sure that the satellite receiver or cable box is turned on.

To watch cable or satellite channel, you need to match the channel on the recorder (L1) to the input jack connected to the cable box or satellite receiver (LINE 1 IN).

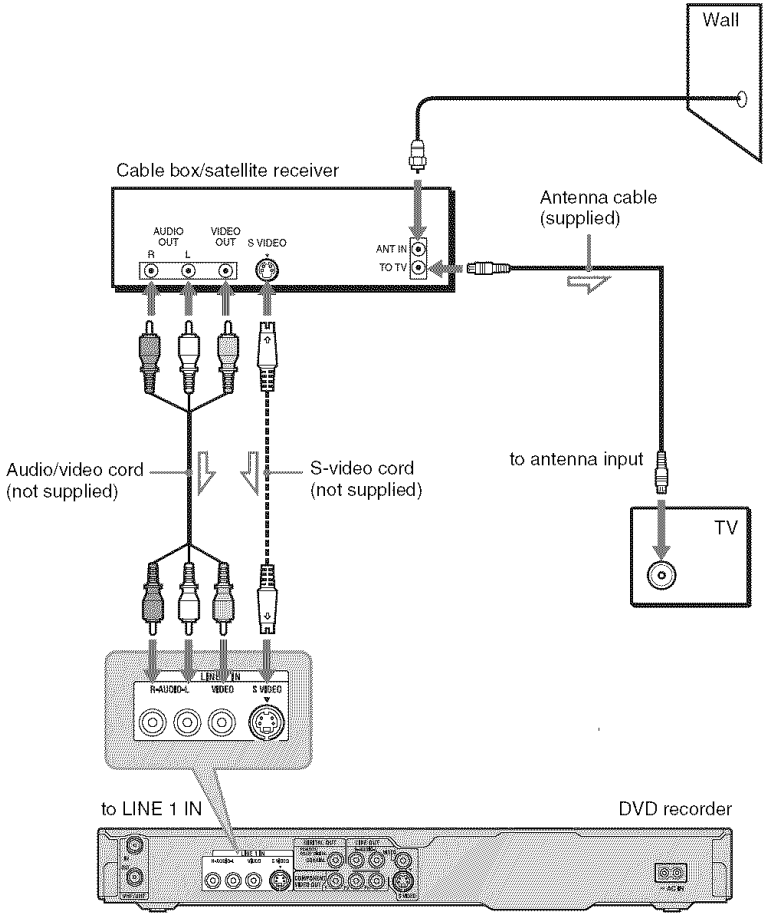

: Signal flow

Hints

- If your cable box or satellite receiver has an S-video jack, you can use an S-video cord (not supplied) instead of the audio/video cord.
- If you connect an S-video cord to the LINE 1 IN jack, set “Line1 Input” of the “Line Input” to “S Video” in the “Video” setup (page 75).

B: Cable box with an antenna output only

With this hookup, you can record any channel on the satellite receiver or cable box. Be sure that the satellite receiver or cable box is turned on.

To watch cable programs, you need to match the channel on the recorder (2ch, 3ch, or 4ch) to the antenna output channel on the cable box (2ch, 3ch, or 4ch).

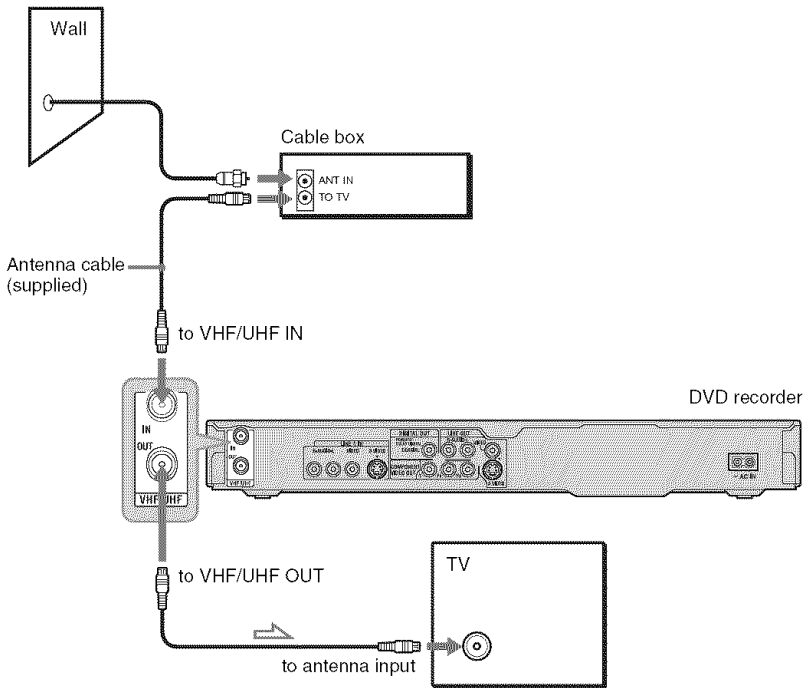

 : Signal flow

Note

When using this connection, set "Antenna / Cable" of the "Tuner Preset" to "Antenna" in the "Basic" setup (page 71).

C: Cable without cable box, or antenna only (no cable TV)

Use this hookup if you watch cable channels without a cable box. Also use this hookup if you are using a VHF/UHF antenna or separate VHF and UHF antennas. With this hookup, you can record any channel by selecting the channel on the recorder.

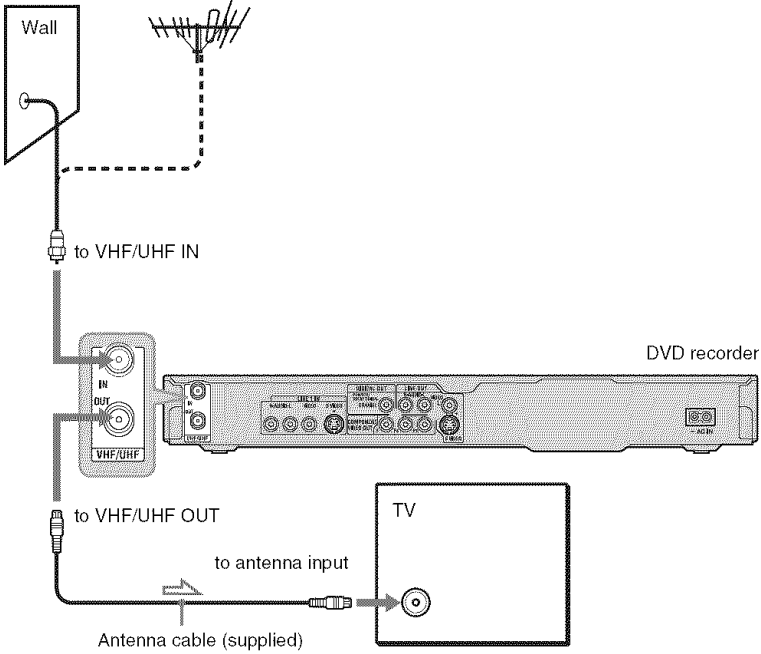

: Signal flow

Step 2: Connecting the Video Cords

Select one of the following patterns, **A** through **C**, according to the input jack on your TV monitor, projector, or AV amplifier (receiver). This will enable you to view pictures.

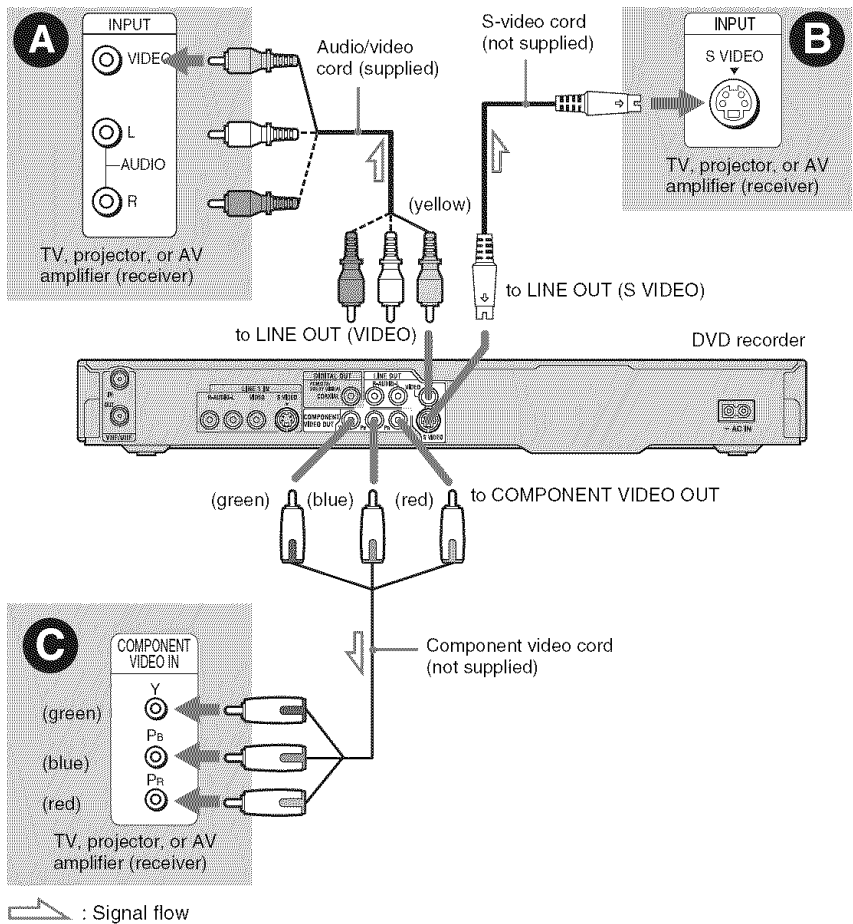

A Video input jack

You will enjoy standard quality images.

B S VIDEO input jack

You will enjoy high quality images.

C Component video input jacks (Y, P_B, P_R)

You will enjoy accurate color reproduction and high quality images.

If your TV accepts progressive 480p format signals, you must use this connection. Then set "Progressive Output" of "Video Output" to "On" in the "Video" setup to send progressive video signals. For details, see "Progressive Output" on page 74.

When playing “wide screen” images

Some recorded images may not fit your TV screen. To change the picture size, see page 74.

If you are connecting to a VCR

Connect your VCR to the LINE IN jack on the recorder (page 24).

 Note

Do not connect more than one type of video cord between the recorder and your TV at the same time.

Step 3: Connecting the Audio Cords

Select one of the following patterns, **A** or **B**, according to the input jack on your TV monitor, projector, or AV amplifier (receiver). This will enable you to listen to sound.

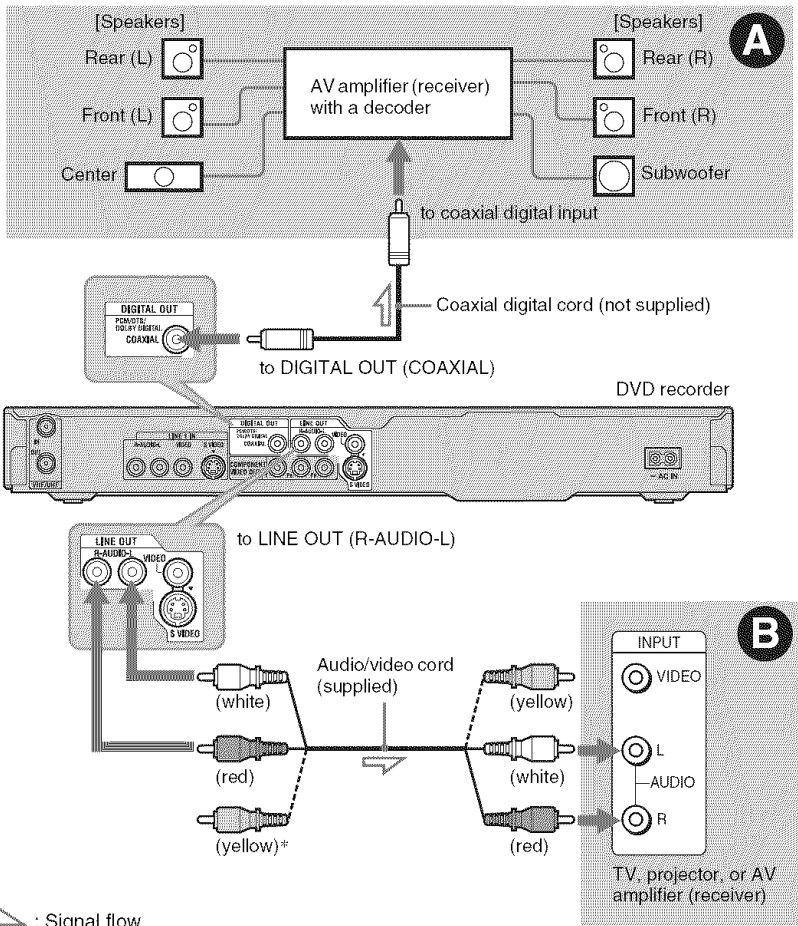

* The yellow plug is used for video signals (page 16).

A Digital audio input jack

If your AV amplifier (receiver) has a Dolby[®] Digital or DTS[®] decoder and a digital input jack, use this connection. You can enjoy Dolby Digital (5.1ch) and DTS (5.1ch) surround effects.

B Audio L/R (left/right) input jacks

This connection will use your TV's or stereo amplifier's (receiver's) two speakers for sound.

Hint

For correct speaker location, see the operating instructions supplied with the connected components.

Notes

- Do not connect your TV's audio output jacks to the LINE IN (R-AUDIO-L) jacks at the same time. This will cause unwanted noise to come from your TV's speakers.
- With connection **B**, do not connect the LINE IN (R-AUDIO-L) and LINE OUT (R-AUDIO-L) jacks to your TV's audio output jacks at the same time. This will cause unwanted noise to come from your TV's speakers.
- With connection **A**, after you have completed the connection, make the appropriate settings under "Easy Setup - Audio Connection" (page 23). Otherwise, no sound or a loud noise will come from your speakers.

*1 Manufactured under license from Dolby Laboratories.

"Dolby" and the double-D symbol are trademarks of Dolby Laboratories.

*2 "DTS" and "DTS Digital Out" are trademarks of Digital Theater Systems, Inc.

Step 4: Connecting the AC Power Cord

Connect the supplied AC power cord to the AC IN terminal of the recorder. Then plug the recorder and TV power cords into the AC outlet. After you connect the AC power cord, **you must wait for a short while before operating the recorder.** You can operate the recorder once the front panel display lights up and the recorder enters standby mode.

If you connect additional equipment to this recorder (page 24), be sure to connect the AC power cord after all connections are complete.

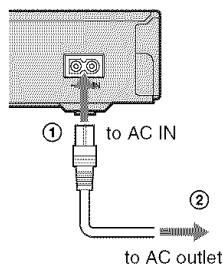

Step 5: Preparing the Remote

You can control the recorder using the supplied remote. Insert two Size AA (R6) batteries by matching the ⊕ and ⊖ ends on the batteries to the markings inside the battery compartment. When using the remote, point it at the remote sensor  on the recorder.

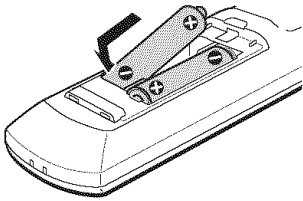

Notes

- If the supplied remote interferes your other Sony DVD recorder or player, change the command mode number for this recorder (page 21).
- Use the batteries correctly to avoid possible leakage and corrosion. Should leakage occur, do not touch the liquid with bare hands. Observe the following:
 - Do not use a new battery with an old battery, or batteries of different manufacturers.
 - Do not attempt to recharge the batteries.
 - If you do not intend to use the remote for an extended period of time, remove the batteries.
 - If battery leakage occurs, wipe out any liquid inside the battery compartment, and insert new batteries.
- Do not expose the remote sensor (marked  on the front panel) to strong light, such as direct sunlight or a lighting apparatus. The recorder may not respond to the remote.

Controlling TVs with the remote

You can adjust the remote's signal to control your TV.

Notes

- Depending on the connected unit, you may not be able to control your TV with some or all of the buttons below.
- If you enter a new code number, the code number previously entered will be erased.
- When you replace the batteries of the remote, the code number may be reset to the default setting. Set the appropriate code number again.

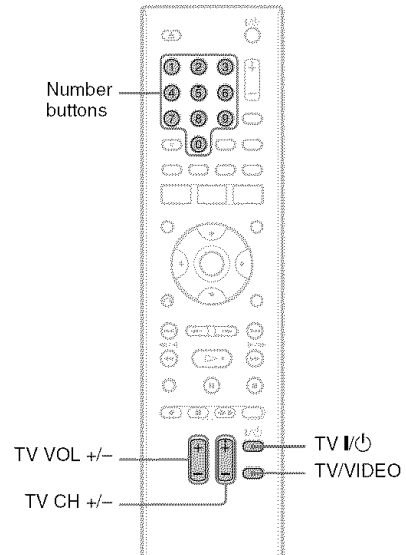

1 Hold down the TV I/ON button located at the bottom of the remote.

Do not press the I/ON button at the top of the remote.

2 With the TV I/ON button pressed down, enter the TV's manufacturer code using the number buttons.

For instance, to enter "09," press "0" then "9." After you enter the last number, release the TV I/ON button.

Code numbers of controllable TVs

If more than one code number is listed, try entering them one at a time until you find the one that works with your TV.

Manufacturer	Code number
Sony	01 (default)
Hitachi	02
MGA/Mitsubishi	13
NEC	04
Panasonic	19
Philips	21
Pioneer	16
RCA	10
Samsung	20
Sharp	18
Toshiba	07

The remote performs the following:

Buttons	Operations
TV	Turns your TV on or off
TV VOL +/-	Adjusts the volume of your TV
TV CH +/-	Selects the channel on your TV
TV/VIDEO	Switches your TV's input source

If you have a Sony DVD player or more than one Sony DVD recorder

If the supplied remote interferes with your other Sony DVD recorder or player, set the command mode number for this recorder and the supplied remote to one that differs from the other Sony DVD recorder or player after you have completed "Step 6: Easy Setup." The default command mode setting for this recorder and the supplied remote is DVD3.

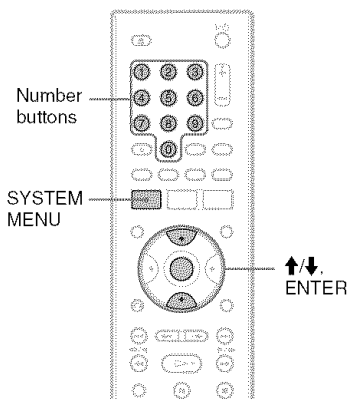

- 1 Check that "Easy Setup" (page 23) has been finished. If "Easy Setup" has not been finished, first perform "Easy Setup."
- 2 Press SYSTEM MENU.
The System Menu appears.
- 3 Select "SETUP," and press ENTER.

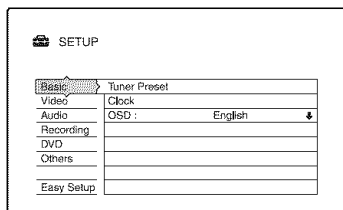

4 Select "Others," and press ENTER.

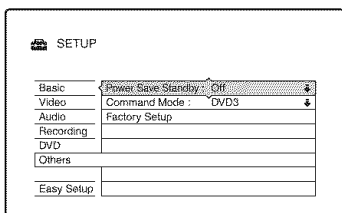

5 Select "Command Mode," and press ENTER.

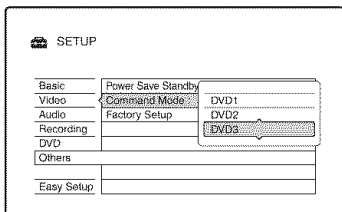

6 Select a Command Mode (DVD1, DVD2, or DVD3), and press ENTER.

7 Set the Command Mode for the remote so it matches the Command Mode for the recorder you set above.

Follow the steps below to set the Command Mode on the remote.

- 1 Hold down ENTER.
- 2 While holding down ENTER, enter the Command Mode code number using the number buttons.

Command Mode	Code number
DVD1	number button 1
DVD2	number button 2
DVD3	number button 3

- 3 Hold down both the number and ENTER buttons at the same time for more than three seconds.

To check the Command Mode for the recorder

Press ■ STOP on the recorder when the recorder is turned off. The Command Mode for the recorder appears in the front panel display.

If the Command Mode for the recorder has not been changed, set the Command Mode for the remote to the default setting of DVD3. If the Command Mode for the remote is changed to DVD1 or DVD2, you will be unable to operate this recorder.

Changing channels of the recorder using the remote

You can change channels of the recorder using the number buttons.

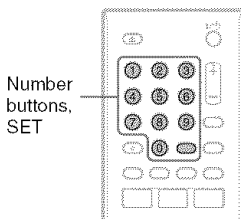

Example: for channel 50
Press "5," "0," then press SET.

Step 6: Easy Setup

Make the basic adjustments by following the on-screen instructions in “Easy Setup.”

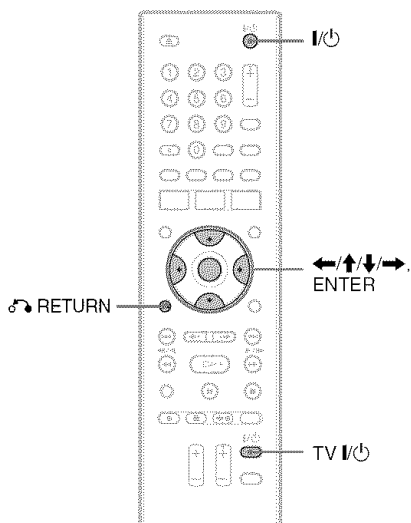

- 1 **Turn on the recorder and your TV. Then switch the input selector on your TV so that the signal from the recorder appears on your TV screen.**

The initial settings message appears.

- If this message does not appear, select “Easy Setup” from “SETUP” in the System Menu (“Settings and Adjustments” on page 71).

- 2 **Press ENTER.**

Follow the on-screen instructions to make the following settings.

◆ Easy Setup - OSD

Select a language for the on-screen displays.

◆ Easy Setup - Clock

Select “Manual” and set the clock using **←/↑/↓/→**, then press ENTER. The day of the week is set automatically.

If you used antenna hookup C (page 15), you can select “Auto.” The recorder will automatically search for a channel that carries a time signal when you turn off the recorder after finishing Easy Setup.

◆ Easy Setup - Tuner Preset

Select whether or not you have a cable connection.

The Tuner Preset function automatically searches for all of the receivable channels and presets them.

To set the channels manually, see page 71.

◆ Easy Setup - TV Type (page 74)

If you have a wide-screen TV, select “16:9.” If you have a standard TV, select either “4:3 Letter Box” (shrink to fit) or “4:3 Pan Scan” (stretch to fit). This will determine how “wide-screen” images are displayed on your TV.

◆ Easy Setup - Audio Connection

If you connected an AV amplifier (receiver) using a coaxial cord, select “Yes : DIGITAL OUT” and set the digital output signal (page 76).

- 3 **Press ENTER when “Finish” appears.** “Easy Setup” is finished.

To return to the previous step

Press **↶** RETURN.

💡 Hint

If you want to run “Easy Setup” again, select “Easy Setup” from “SETUP” in the System Menu (page 82).

⚠ Notes

- If you use an S-video cord to connect your cable box or satellite receiver, set “Line1 Input” of the “Line Input” to “S Video” in the “Video” setup (page 75).
- If there are only a few channels in your area that carry time signals, setting the clock automatically may take up to about 20 minutes after the recorder turns off. If nothing happens even after you wait about 20 minutes, set the clock manually in “Clock” of “Basic” (page 72).

Connecting a VCR or Similar Device

After disconnecting the recorder's AC power cord from the AC outlet, connect a VCR or similar recording device to the LINE IN jacks of this recorder. Use the DV IN jack on the front panel if the equipment has a DV output jack (i.LINK jack) (page 66).

For details, refer to the instruction manual supplied with the connected equipment. To record on this recorder, see "Recording from connected equipment without a timer" on page 48.

Connecting to the LINE 1 IN jacks

Connect a VCR or similar recording device to the LINE 1 IN of this recorder. If the equipment has an S-video jack, you can use an S-video cord instead of an audio/video cord.

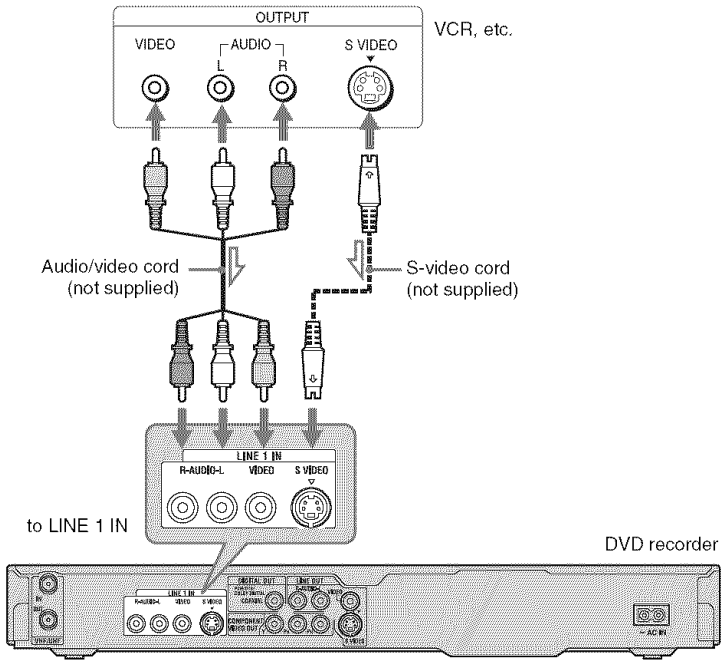

⚡ Notes

- Pictures containing copy protection signals that prohibit any copying cannot be recorded.
- If you pass the recorder signals through a VCR, you may not receive a clear image on your TV screen.



Be sure to connect your VCR to the DVD recorder and to your TV in the order shown below. To watch video tapes, watch the tapes through a second line input on your TV.

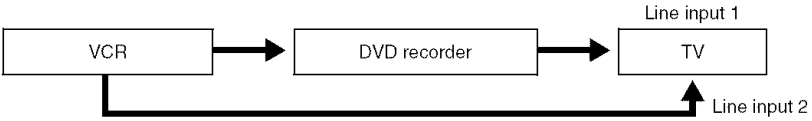

- If you disconnect the recorder's AC power cord, you will not be able to view the signals from the connected VCR.

Connecting to the LINE 2 IN jacks on the front panel

Connect a VCR or similar recording device to the LINE 2 IN jacks of this recorder. If the equipment has an S-video jack, you can use an S-video cord instead of an audio/video cord.

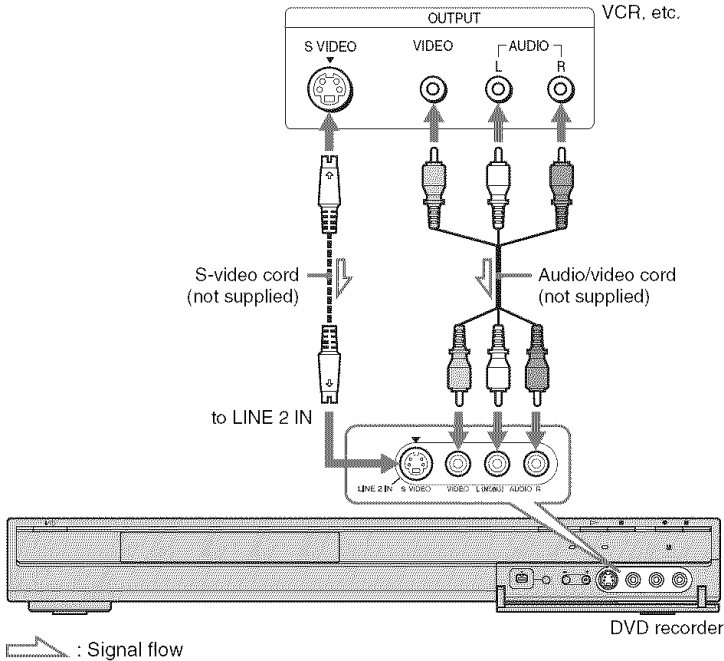

💡 Hint

When the connected equipment outputs only monaural sound, connect to just the L (MONO) and VIDEO input jacks on the front of the recorder. Do not connect the R input jack.

⚡ Notes

- Do not connect the yellow LINE IN (VIDEO) jack when using an S-video cord.
- Do not connect the output jack of this recorder to another equipment's input jack with the other equipment's output jack connected to the input jack of this recorder. This may cause noise (feedback).
- Do not connect more than one type of video cord between the recorder and your TV at the same time.

Connecting to a Satellite or Digital Tuner

Connect a satellite or digital tuner to this recorder using the LINE 1 IN jacks. Disconnect the recorder's AC power cord from the AC outlet when connecting the tuner. To use the Synchro-Rec function, see below.

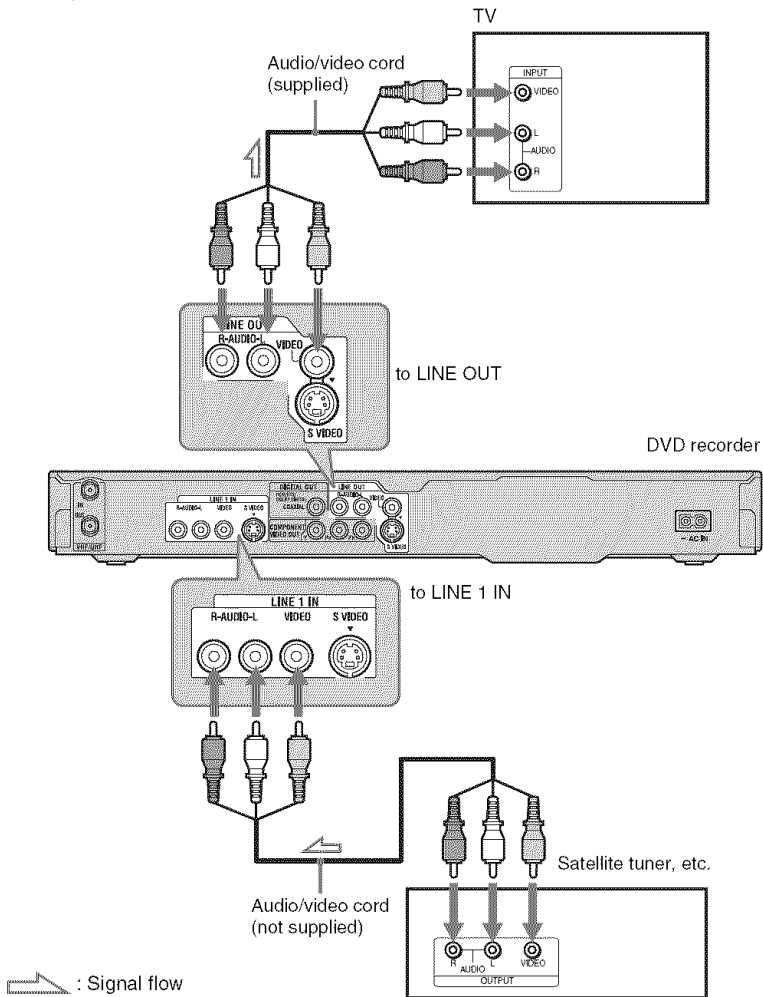

If you want to use the Synchro Rec function

This connection is necessary to use the Synchro-Recording function. See "Recording from connected equipment with a timer (Synchro Rec)" on page 47.

Notes

- Synchro-Recording does not work with some tuners. For details, see the tuner's operating instructions.
- If you disconnect the recorder's AC power cord, you will not be able to view the signals from the connected tuner.

Eight Basic Operations

— Getting to Know Your DVD Recorder

1. Inserting a Disc

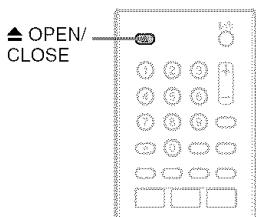

- 1 Press **▲ OPEN/CLOSE**, and place a disc on the disc tray.

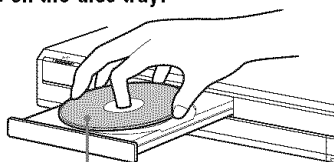

Recording/playing side facing down

- 2 Press **▲ OPEN/CLOSE** to close the disc tray.

Wait until “LOAD” disappears from the front panel display.

Unused DVDs are formatted automatically.

- For DVD-RW discs
DVD-RWs are formatted in the recording format (VR mode or Video mode) set by “Format DVD-RW” in the “DVD” setup.
- For DVD-R discs
DVD-Rs are automatically formatted in Video mode. To format an unused DVD-R in VR mode, format the disc using the “Disc Information” display (page 37) **before** you make a recording.

If the disc is recordable on this recorder, you can manually re-format the disc to make a blank disc (page 37).

2. Recording a Program



This section introduces the basic operation to record a current TV program to a disc (DVD). For an explanation of how to make timer recordings, see page 39.

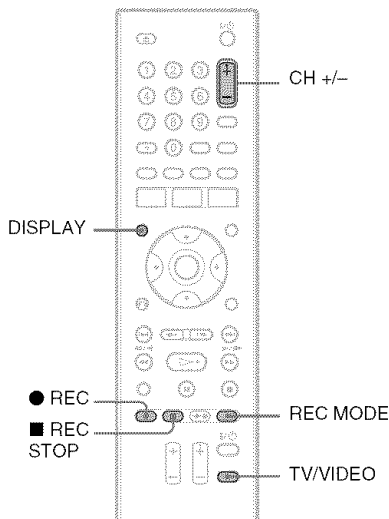

- 1 Insert a recordable DVD.
- 2 Press **CH +/-** to select the channel or input source you want to record.
- 3 Press **REC MODE** repeatedly to select the recording mode.

Each time you press the button, the display on the TV screen changes as follows:



For more details about the recording mode, see page 39.

- 4 Press **● REC**.
Recording starts.
Recording stops automatically after 8 hours of continuous recording or when the DVD is full.

To stop recording

Press **■ REC STOP**.

Note that it may take a few seconds for recorder to stop recording.

To watch another TV program while recording

Set your TV to the TV input using the TV/VIDEO button (page 20).

Hint

If you do not want to watch TV while recording, you can turn off the TV. When using a decoder, make sure to leave it on.

Notes

- After pressing **● REC**, it may take a short while to start recording.
- You cannot change the recording mode while recording.
- If there is a power failure, the program you are recording may be erased.

Checking the disc status while recording

You can check the recording information such as recording time or disc type.

Press **DISPLAY** during recording.

The recording information appears.



- 1 Disc type/format
- 2 Recording status
- 3 Recording mode
- 4 Recording time

Press **DISPLAY** to turn off the display.

3. Playing the Recorded Program (Title List)



To play a recorded title, select the title from the Title List.

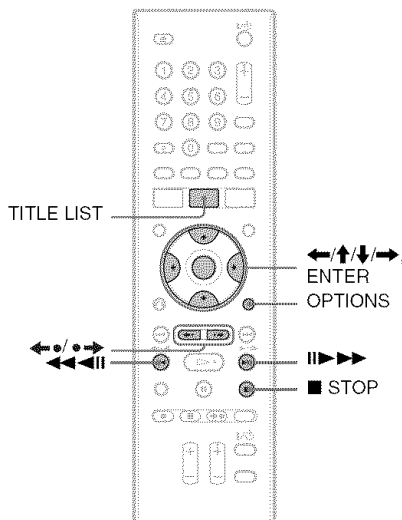

1 Insert a DVD.

See "1. Inserting a Disc" on page 27. Playback starts automatically depending on the disc.

2 Press TITLE LIST.

To show the extended Title List, press **OPTIONS** to select “Display List,” and press **ENTER**.

Title List with Thumbnail Images
(Example: DVD+RW)

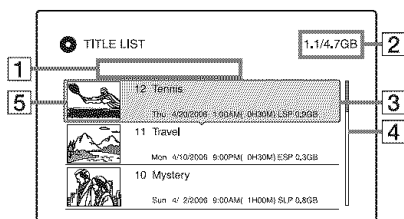

Extended Title List



1 Title type:

Displays the title type (Original or Playlist) for DVD-RWs/DVD-Rs (VR mode).

2 Disc space (remainder/total)

3 Title information:

Displays the title number, title name, and recording date. Title size is shown in the Thumbnail title list.

● (red): Indicates that the title is currently being recorded.

🔒: Indicates the protected title.

4 Scroll bar:

Appears when all of the titles do not fit on the list. To view the hidden titles, press **↑/↓**.

5 Title's thumbnail picture:

The still images for each title are displayed.

3 Select a title, and press ENTER.

The sub-menu appears.

The sub-menu displays options applicable only to the selected item. The displayed options differ depending upon the model, situation, and disc type.

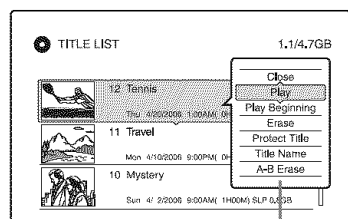

Sub-menu

4 Select “Play,” and press ENTER.

Playback starts from the selected title.

To stop playback

Press **■ STOP**.

To scroll the list display by page (Page mode)

Press **◀• REPLAY/ADVANCE •▶** while the list display is turned on. Each time you press **◀• REPLAY/ADVANCE •▶**, the entire Title List changes to the next/previous page of titles.

About the Title List for DVD-RWs/DVD-Rs (VR mode)

You can switch the Title List to show Original or Playlist titles.

While the Title List menu is turned on, press **◀/▶**.

To change the title order (Sort)

While the Title List menu is turned on, press **OPTIONS** to select “Sort Titles.” Press **↑/↓** to select the item, and press **ENTER**.

Order	Sorted
By Date	In order of when the titles were recorded. The title that is recorded most recently is listed at the top.
By Title	In alphabetical order.
By Number	In order of recorded title number.

➡ continued

To change a title thumbnail picture (Thumbnail) (DVD-RW/DVD-R in VR mode only)

You can select a favorite scene for the thumbnail picture shown in the Title List menu.

- 1 Press **TITLE LIST**.
Press **←/→** to switch the Title Lists, if necessary.
- 2 Select a title, and press **ENTER**.
The sub-menu appears.
- 3 Select "Set Thumbnail," and press **ENTER**.
The display for setting the thumbnail point appears and the title starts to play.
- 4 While watching the playback picture, press **◀▶** to select the scene you want to set for a thumbnail picture, and press **ENTER**.
Playback pauses.
- 5 Press **ENTER** if the scene is correct. If the scene is incorrect, press **◀|||▶** to select the scene you want to set for a thumbnail picture, and press **ENTER**.
The display asks for confirmation.
 - To change the thumbnail, press **↑**.
- 6 Select "OK," and press **ENTER**.
The scene is set for the title's thumbnail picture.

To turn off the Title List

Press **TITLE LIST**.

💡 Hints

- After recording, the first scene of the recording (the title) is automatically set as the thumbnail picture.
- You can select "TITLE LIST" from the System Menu.

⚡ Notes

- The title names may not appear for DVDs created on other DVD recorders.
- It may take a few seconds for the thumbnail pictures to be displayed.
- After editing, the title thumbnail picture may change to the first scene of the recording (title).

4. Displaying the Playing/Remaining Time and Play Information



You can check the playing time and remaining time of the current title, chapter, track, or disc. Also, you can check the disc name recorded on the DVD/CD.

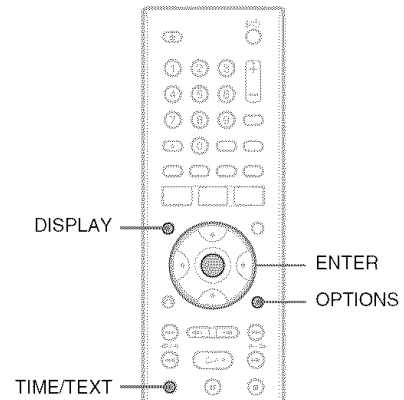

Press **DISPLAY**.

The displays differ depending on the disc type or playing status.

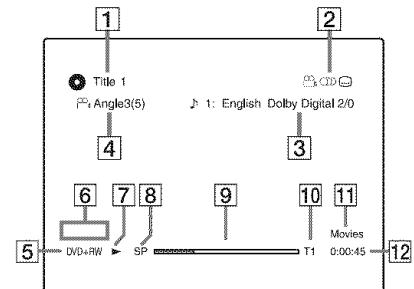

- 1 Title number/name
(Shows either track number, track name, scene number, or file name for CDs, VIDEO CDs, DATA DVDs, or DATA CDs.)

- 2** Available functions for DVD VIDEOS (angle/ audio/ subtitle, etc.), or playback data for DATA DVDs and DATA CDs
- 3** The current selected function or audio setting (appears only temporarily)
Example: Dolby Digital 5.1 ch

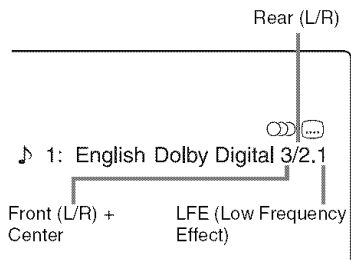

- 4** The current selected angle
- 5** Disc type^{*1}/format (page 8)
- 6** Title type (only appears for Playlists)
- 7** Play mode
- 8** Recording mode (page 39)
- 9** Playing status bar^{*2}
- 10** Title number (chapter number^{*3}) (page 54)
(Shows either track number, scene number, album number^{*3}, or file number for CDs, VIDEO CDs, DATA DVDs, or DATA CDs.)
- 11** Album name appears for DATA DVDs or DATA CDs.
For CDs with CD text, press TIME/TEXT.
- 12** Playing time (remaining time^{*3})

^{*1} Displays Super VIDEO CDs as "SVCD," DATA CDs as "CD" and DATA DVDs as "DVD."

^{*2} Does not appear with VIDEO CDs, DATA DVDs, and DATA CDs.

^{*3} Displayed when you press TIME/TEXT repeatedly.

Hints

- If "DTS" of "Audio Connection" is set to "Off" in the "Audio" setup, the DTS track selection option will not appear on the screen even if the disc contains DTS tracks (page 76).
- When "Auto Display" is set to "On" (default) in the "Video" setup (page 75), information automatically appears on the screen when the recorder is operated.

Note

Playing time of MP3 audio tracks may not be displayed correctly.

Checking the playing/remaining time

You can view the playing or time information displayed on the front panel display.

Press TIME/TEXT repeatedly.

The displays differ depending on the disc type or playing status.

Example: When playing a DVD

Playing time and number of the current title

T 1 103:24



Remaining time of the current title

T - 1:15:36



Playing time and number of the current chapter

C 2 0:22:30



Remaining time of the current chapter

C - 0:13:20

Example: When playing a VIDEO CD

Playing time and number of the current scene or track

3 2:15

Example: When playing a CD
Track playing time and the current track/index number



Remaining time of the current track



Playing time of the disc



Remaining time of the disc



CD text (when available)

Example: When playing an MP3 audio track
Playing time and number of the current track



Current album number

Example: When viewing a JPEG image
Current file number and total number of files in the current album



Current album number and total number of albums

⚡ Notes

- The recorder can only display the first level of a CD's text, such as the disc name.
- The letters or symbols that cannot be displayed are replaced with "*".
- Playing time of MP3 audio tracks may not be displayed correctly.

Checking the remaining disc space

You can check the remaining disc space using the "Disc Information" display.

1 Insert a disc.

See "1. Inserting a Disc" on page 27.

2 Press **OPTIONS** to select "Disc Information," and press **ENTER**.

The "Disc Information" display appears. Available settings differ depending on the disc type.

Example: When a DVD+RW is inserted.

Disc Information	
Media	DVD+RW
Disc Name	
Date	10/13/2006 - 10/28/2006
Title no.	3
Remainder	HQ :0H30M HSP:0H45M SP :1H00M LSP:1H16M ESP:1H30M LP :2H00M EP :3H00M SLP:4H00M 2,3/4,7GB

Buttons: Close, Disc Name, Finalize, Format

"Remainder" (approximate)

- The remaining recording time in each of the recording modes
- Disc space bar
- Remaining disc space/total disc space

💡 Hint

To increase disc space, see "To open up disc space" (page 59).

5. Changing the Name of a Recorded Program



You can label a DVD, title, or program by entering characters. You can enter up to 64 characters for a title or disc name, but the actual number of characters displayed in the menus such as the Title List will vary. The steps below explain how to change the name of the recorded program.

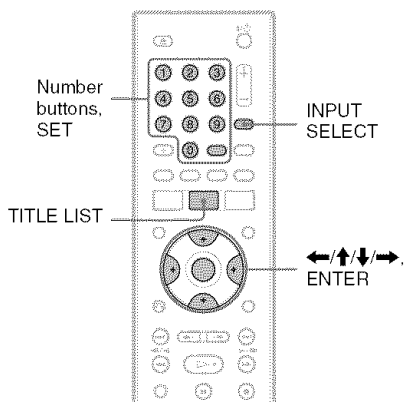

- 1 Press **TITLE LIST**.
- 2 Select a title, and press **ENTER**.
The sub-menu appears.
- 3 Select **"Title Name,"** and press **ENTER**.
The display for entering characters appears.
- 4 Press $\leftarrow/\uparrow/\downarrow/\rightarrow$ to move the cursor to the right of the display and select **"A" (upper-case), "a" (lower-case), or "Symbol,"** and press **ENTER**.
The characters for the selected type are displayed.

- 5 Press $\leftarrow/\uparrow/\downarrow/\rightarrow$ to select the character you want to enter, and press **ENTER**.

The selected character appears at the top of the display.

Example: Input Title Name

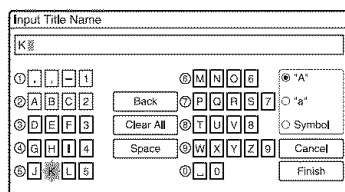

The type of characters will change according to the language you select in "Easy Setup." Some languages allow you to enter an accent mark.

To enter a letter with an accent mark, select an accent followed by the letter. Example: Select "`" and then "a" to enter "à."

To insert a space, select "Space."

- 6 Repeat steps 4 and 5 to enter the remaining characters.

Input row

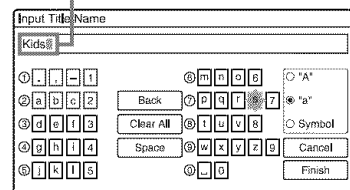

To erase a character, move the cursor to the right of the character at the input row. Select **"Back"** and press **ENTER**.

To insert a character, move the cursor to the right of the point where you want to insert the character. Select the character and press **ENTER**.

To erase all of the characters, select **"Clear All"** and press **ENTER**.

- 7 Select **"Finish,"** and press **ENTER**.
To cancel the setting, select **"Cancel."**

To use the number buttons

You can also use the number buttons to enter characters. Refer to the number next to each row of letters on your TV screen.

- 1 In step 5 above, press a number button repeatedly to select a character.
Example:
Press the number 3 button once to enter "D."
Press the number 3 button three times to enter "F."
- 2 Press ENTER or SET and select the next character.
- 3 Select "Finish" and press ENTER.

Hint

You can switch between "A" (upper-case), "a" (lower-case), or "Symbol" by pressing INPUT SELECT.

6. Labeling and Protecting a Disc

You can execute options effective for the entire disc using the "Disc Information" display.

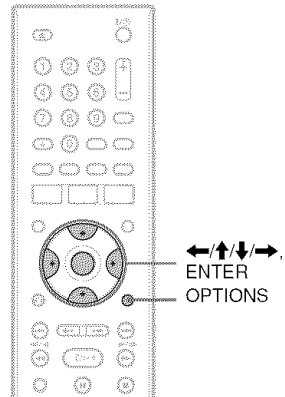

Labeling a disc



- 1 Insert a disc.
See "1. Inserting a Disc" on page 27.
- 2 Press **OPTIONS** to select "Disc Information," and press **ENTER**.
The "Disc Information" display appears.
Available settings differ depending on the disc type.
Example: When the inserted disc is a DVD+RW.

Disc Information	
Media	DVD+RW
Disc Name	
Date	10/13/2006-10/28/2006
Title no.	3
Remainder	HQ :0H30M HSP:0H45M SP :1H00M LSP:1H15M ESP:1H30M LP :2H00M EP :3H00M SLP:4H00M
	2,3/4,7GB

- 3 Select "Disc Name," and press **ENTER**.

Enter the disc name in the "Input Disc Name" display (page 33).

Note

You can enter up to 64 characters for a DVD's disc name. The disc name may not appear when the disc is played on other DVD equipment.

Protecting a disc

-RWVR -RVR

1 Insert a disc.

See "1. Inserting a Disc" on page 27.

2 Press **OPTIONS** to select "Disc Information," and press **ENTER**.

The "Disc Information" display appears. Available settings differ depending on the disc type.

Example: When the inserted disc is a DVD-RW (VR mode).

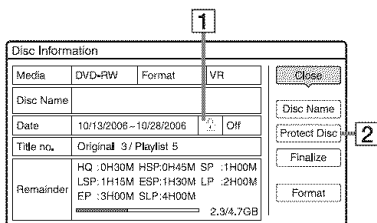

1 "On"/"Off": Indicates whether protection is set (DVD-RW/DVD-R in VR mode only)

2 "Protect Disc"

3 Select "Protect Disc," and press **ENTER**.

4 Select "Protect," and press **ENTER**.

To cancel the protection

Select "Unprotected" in step 4.

Hint

You can set protection for individual titles (page 60).

7. Playing the Disc on Other DVD Equipment (Finalize)

+RW -RWVR -RWVideo +R -RVR

-RVideo

Finalizing is necessary when you play discs recorded with this recorder on other DVD equipment.

When you finalize a DVD+RW, DVD-RW (Video mode), DVD+R, or DVD-R (Video mode), a DVD menu will be automatically created, which can be displayed on other DVD equipment.

Before finalizing, check the differences between the disc types in the table below.

Differences between the disc types

+RW

Discs are automatically finalized when removed from the recorder. However, you may need to finalize the disc for certain DVD equipment, or if the recording time is short. You can edit or record on the disc even after finalizing.

-RWVR

Finalizing is unnecessary when playing a disc on VR format compatible equipment. Even if your other DVD equipment is VR format compatible, you may need to finalize the disc, especially if the recording time is short. You can edit or record on the disc even after finalizing.

-RWVideo

Finalizing is necessary when playing on any equipment other than this recorder. After finalizing, you cannot edit or record on the disc. If you want to record on it again, unfinalize (page 37) or reformat the disc (page 37). However, if you reformat the disc, all recorded contents will be erased.

-RVR

Finalizing is necessary. The disc can be played only on equipment that supports DVD-R in VR mode. After finalizing you cannot edit or record on the disc using this recorder.



Finalizing is necessary when playing on any equipment other than this recorder. After finalizing, you cannot edit or record on the disc.

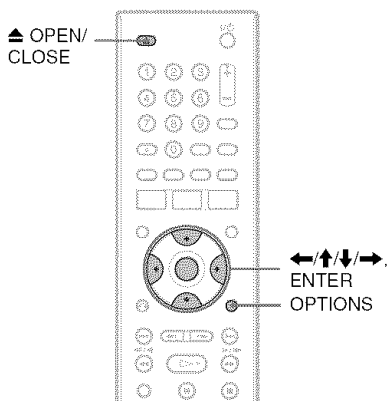

Finalizing the disc using **▲ OPEN/CLOSE** button

- 1 Make a recording.**
See “2. Recording a Program” on page 27.
- 2 Press ▲ OPEN/CLOSE.**
The display shows the approximate time required for finalizing and asks for confirmation.
For DVD+RWs, the recorder automatically starts finalizing the disc. After finalizing, the disc will be ejected automatically.
- 3 Select “OK,” and press ENTER.**
The recorder starts finalizing the disc. After finalizing, the disc will be ejected automatically.

Finalizing the disc using “Disc Information” display

- 1 Insert a disc.**
See “1. Inserting a Disc” on page 27.
- 2 Press OPTIONS to select “Disc Information,” and press ENTER.**
The “Disc Information” display appears.
- 3 Select “Finalize,” and press ENTER.**
The display shows the approximate time required for finalizing and asks for confirmation.

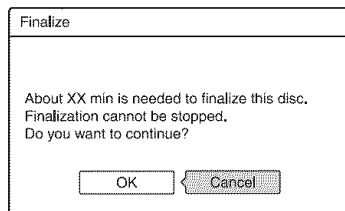

- 4 Select “OK,” and press ENTER.**
The recorder starts finalizing the disc.

Hint

You can check whether the disc has been finalized or not. If you cannot select “Finalize” in step 3 above, the disc has already been finalized.

Notes

- Depending on the condition of the disc, recording, or the DVD equipment, discs may not play even if the discs are finalized.
- The recorder may not be able to finalize the disc if it was recorded on another recorder.

Unfinalizing a disc

-RWVR **-RWVideo**

For DVD-RWs (Video mode)

DVD-RWs (Video mode) that have been finalized to prohibit additional recording or editing can be unfinalized to allow further recording or editing.

For DVD-RWs (VR mode)

If you cannot record or edit on a DVD-RW (VR mode) that has been finalized with other DVD equipment, unfinalize the disc.

Note

The recorder is not able to unfinalize DVD-RWs (Video mode) that have been finalized on another recorder.

1 Insert a disc.

See "1. Inserting a Disc" on page 27.

2 Press **OPTIONS** to select "Disc Information," and press **ENTER**.

The "Disc Information" display appears.

3 Select "Unfinalize," and press **ENTER**.

The recorder starts unfinalizing the disc. Unfinalizing may take several minutes.

8. Reformatting a disc

+RW **-RWVR** **-RWVideo**

New discs are automatically formatted when inserted. If necessary, you can manually reformat a DVD+RW or DVD-RW disc to make a blank disc. For DVD-RWs, you can select a recording format (VR mode or Video mode) according to your needs (page 59).

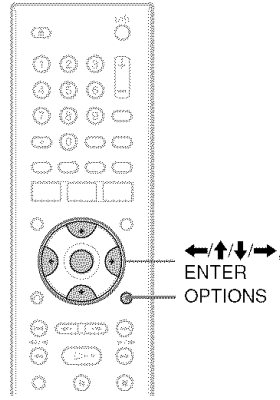

1 Insert a disc.

See "1. Inserting a Disc" on page 27.

2 Press **OPTIONS** to select "Disc Information," and press **ENTER**.

Example: When a DVD+RW is inserted.

Disc Information	
Media	DVD+RW
Disc Name	
Date	10/13/2006 - 10/28/2006
Title no.	3
Remainder	HQ :0H30M HSP:0H45M SP :1H00M LSP:1H15M ESP:1H30M LP :2H00M EP :3H00M SLP:4H00M
	2,3/4,7GB

3 Select "Format," and press **ENTER**.

4 Select "OK," and press **ENTER**.

For DVD-RWs and unrecorded DVD-Rs (Video mode), select "VR" or "Video," and press **ENTER**.

All contents on the disc are erased.

 **Hint**

By reformatting, you can change the recording format on DVD-RWs, or record again on DVD-RWs that have been finalized.

 **Note**

On this model, 1 GB (read “gigabyte”) is equivalent to 1 billion bytes. The larger the number, the larger the disc space.

Before Recording

Before you start recording...

- Check that the disc has enough available space for the recording (page 32). For DVD+RWs and DVD-RWs, you can free up disc space by erasing titles (page 59).
- Adjust the recording picture quality and picture size if necessary (page 42).

Hint

Timer recordings will be made regardless whether or not the recorder is turned on. You can turn off the recorder without affecting the recording even after recording starts.

Note

To play a recorded disc on other DVD equipment, finalize the disc (page 35).





Recording mode

Like the standard $\times 3$ recording modes of video tapes, you can select the desired recording mode using the REC MODE button.

Recording modes with higher quality provide a more beautiful recording, but the large data volume also results in a shorter recording time.

Conversely, a longer duration provides a longer recording time, but the lower data volume results in a coarser picture quality.

Press REC MODE repeatedly to switch the recording modes.

Recording mode	Approx. recording time (hours)	
	DVD	DVD+R DL
HQ (High quality)	1	1 hr. 48 min.
HSP 	1 hr. 30 min.	2 hr. 42 min.
SP (Standard mode)	2	3 hr. 37 min.
LSP 	2 hr. 30 min.	4 hr. 31 min.
ESP 	3	5 hr. 25 min.
LP 	4	7 hr. 14 min.
EP 	6	10 hr. 51 min.
SLP (Long duration)	8	14 hr. 28 min.

Notes

- The maximum continuous recording time for a single title is eight hours.
- Situations below may cause slight inaccuracies with the recording time.
 - Recording a program with poor reception, or a program or video source of low picture quality
 - Recording on a disc that has already been edited
 - Recording only a still picture or just sound

Recording a stereo/SAP program

The recorder can receive and record stereo/SAP programs.

Recording stereo programs

If there is noise in the stereo program, set "Auto Stereo" in the "Audio" setup to "Off" (page 76). The sound will be recorded in monaural but with less noise.

SAP (Second Audio Program)

When a SAP (Second Audio Program) is received, the "SAP" indicator lights up on the front panel display. To record only SAP sound, set "Tuner Audio" in the "Audio" setup to "SAP" (page 76).

Unrecordable pictures

Pictures with copy protection cannot be recorded on this recorder. When the recorder receives a copy guard signal, the recorder continues to record but only a blank, grey colored screen will be recorded.

Copy control signals

Recordable discs

Copy-Free



Copy-Once



Copy-Never

None (a blank screen is recorded)

* The recorded disc can be played only on CPRM compatible equipment (page 8).

Timer Recording



You can set the timer for a total of 40 programs, up to 30 days in advance. Set the date, time, and channel of the program manually.

Note

Do not operate your cable box or satellite receiver just before or during a timer recording. This may prevent the accurate recording of a program.

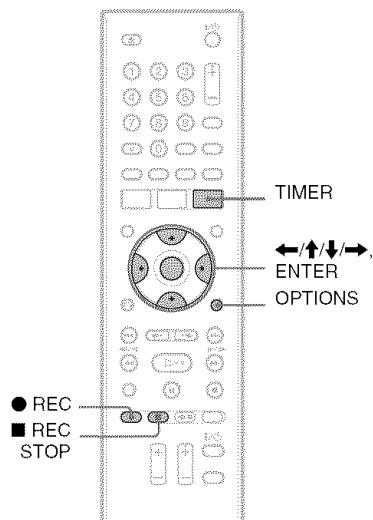

1 Press TIMER.

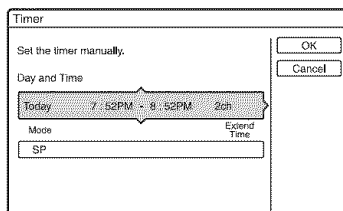

2 Press ↑/↓ to select the "Day and Time" or "Mode" row. Then press ENTER.

3 Select an item using ←/→ and adjust using ↑/↓. Then press ENTER.

To make additional changes to items in different rows, return to step 2. The adjustable items are listed below.

“Day and Time”:

Sets the date, start time, and stop time, and selects the channel or input source.

The date item changes as follows:

Today ↔ ↔ Sat 12/2 (30 days later) ↔ Sun (every Sunday) ↔

↔ Sat (every Saturday) ↔ Mon - Fri (Monday to Friday) ↔ Mon - Sat (Monday to Saturday) ↔ Daily ↔ Today

“Mode”:

Selects the recording mode (page 39).

“Extend Time”:

Sets the duration in increments of 10 minutes, for a maximum of 60 minutes when a timer recording is in progress. If the program set to be recorded daily or weekly is extended, the manually extended time set here will be added to the subsequent timer recording times.

• If you make a mistake, select the item and change the setting.

4 Select “OK,” and press ENTER.

The “TIMER LIST” display (page 44) appears. The TIMER REC indicator lights up on the front panel and the recorder is ready to start recording.

Unlike a VCR, there is no need to turn off the recorder before the timer recording starts.

To stop recording during timer recording

Press ■ REC STOP.

Note that it may take a few seconds for the recorder to stop recording.

Rec Mode Adjust

If there is not enough available disc space for the recording, the recorder automatically adjusts the recording mode to enable the entire program to be recorded. Set “Rec Mode Adjust” of the “Timer Settings” to “On” in the “Recording” setup (page 78).

If the timer settings overlap

Overlapped timer settings are shown as follows.

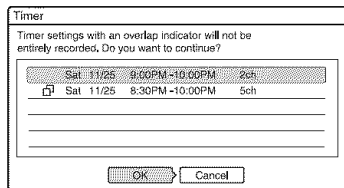

To store the setting as shown, select “OK.”

The program that does not have a mark next to it has priority and the overlapped programs start recording only after the first program has finished.

To cancel the overlapped setting, select “Cancel.”

To confirm, change, or cancel a timer recording

See “Checking/Changing/Canceling Timer Settings (Timer List)” on page 44.

To extend the recording duration time while recording

- 1 Press OPTIONS during recording to select “Extend Rec Time,” and press ENTER.

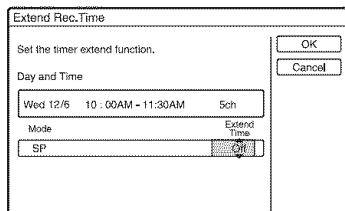

- 2 Press ↑/↓ to select the duration time. You can set the duration in increments of 10 minutes, for a maximum of 60 minutes.
- 3 Select “OK” and press ENTER.

💡 Hint

If you are recording to a DVD-RW (VR mode) at a recording mode that is SP or lower and is a 2x speed or higher disc, you can play the title as it is being recorded by selecting the program title on the Title List (page 53).

Notes

- If a message indicating that the disc is full appears on the screen, change the disc, or make available space for the recording (DVD+RW/DVD-RW only) (page 60).
- Check that the clock is correctly set before setting the timer recording. If not, the timer recording cannot be made.
- To record a satellite program, turn on the satellite tuner and select the satellite program you want to record. Leave the satellite tuner turned on until the recorder finishes recording. If you connect equipment with a timer function, you can use the Synchro Rec function (page 47).
- Even if the timer is set for the same daily or weekly program, the timer recording cannot be made if it overlaps with a program that has priority. "□" will appear next to the overlapped setting in the Timer List. Check the priority order of the settings.
- Even if the timer is set, timer recordings cannot be made while recording a program that has priority.
- The Rec Mode Adjust function only works with a timer recording. It does not function with Quick Timer or Synchro Rec.

Using the Quick Timer function

You can set the recorder to record in 30 minute increments.

Press ● REC repeatedly to set the duration.

Each press advances the time in 30 minute increments. The maximum duration is six hours.

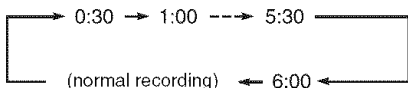

The time counter decreases minute by minute to 0:00, then the recorder stops recording (the power does not turn off). Even if you turn off the recorder during recording, the recorder continues to record until the time counter runs out.

To cancel the Quick Timer

Press ● REC repeatedly until the counter appears in the front panel display. The recorder returns to normal recording mode.

Adjusting the recording picture quality and size

You can adjust the recording picture quality and picture size.

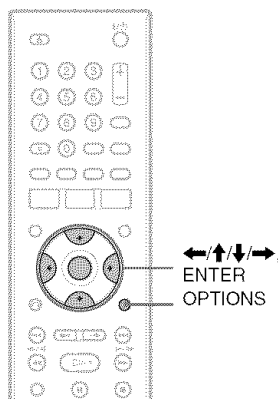

- 1 Before recording starts, press **OPTIONS** to select "Rec Settings," and press **ENTER**.

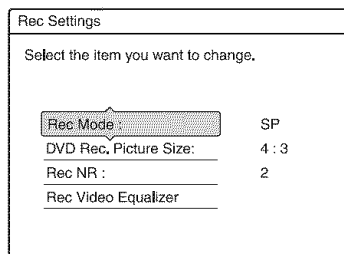

- 2 Select the item you want to adjust, and press **ENTER**.

The adjustment display appears.

Example: Rec NR

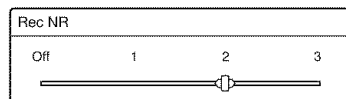

"Rec Mode":

Selects the recording mode for the desired recording time and picture quality. For more information, see "Recording mode" on page 39.

“DVD Rec. Picture Size”:

Sets the picture size of the program to be recorded.

- 4:3 (default): Sets the picture size to 4:3.
- 16:9: Sets the picture size to 16:9 (wide mode).

“DVD Rec. Picture Size” works with DVD-RWs/DVD-Rs (Video mode) when the recording mode is set to HQ, HSP, SP, LSP, or ESP. For all other recording modes, the screen size is fixed at “4:3.”

For DVD-Rs/DVD-RWs (VR mode), the actual picture size is recorded regardless of the setting. For example, if a 16:9 size picture is received, the disc records the picture as 16:9 even if “DVD Rec. Picture Size” is set to “4:3.”

For DVD+RWs/DVD+Rs, the screen size is fixed at “4:3.”

“Rec NR” (noise reduction): Reduces noise contained in the video signal.

“Rec Video Equalizer”: Adjusts the picture in greater detail.

Press **↑/↓** to select the item you want to adjust, then press ENTER.

- Contrast: Changes the contrast.
- Brightness: Changes the overall brightness.
- Color: Makes the colors deeper or lighter.
- Hue: Changes the color balance.

3 Adjust the setting using **←/↑/↓/→**, and press ENTER.

The default setting is underlined.

“Rec NR”: (weak) Off 1 ~ 2 ~ 3 (strong)

“Rec Video Equalizer”:

- Contrast: (weak) -3 ~ 0 ~ 3 (strong)
- Brightness: (dark) -3 ~ 0 ~ 3 (bright)
- Color: (light) -3 ~ 0 ~ 3 (deep)
- Hue: (red) -3 ~ 0 ~ 3 (green)

Repeat steps 2 and 3 to adjust any other items.

Notes

- When playing a 16:9 size picture recorded as 4:3, the image is fixed to 4:3 Letter Box regardless of the setting in “TV Type” of “Video” setup (page 74).
- Remnants of images may appear on your screen when using “Rec NR.”
- “Rec Video Equalizer” does not affect the input of the DV IN jack.

Creating chapters in a title

The recorder can automatically divide a recording (a title) into chapters by inserting chapter marks at approximately 6 minute intervals during recording. To disable this function, set “Auto Chapter” in the “Recording” setup to “Off” (page 78). When recording to a DVD-R (VR mode) or DVD-RW (VR mode), you can insert and erase chapter marks manually (page 62).

Checking/Changing/ Canceling Timer Settings (Timer List)



You can check, change, or cancel timer settings using the Timer List.

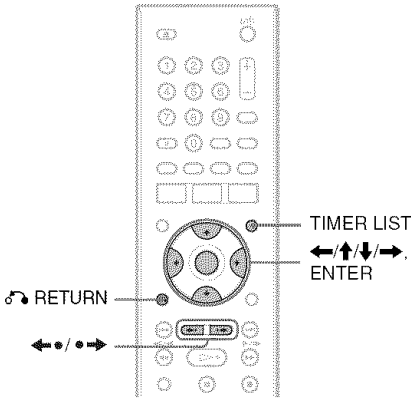

1 Press **TIMER LIST**.

The Timer List appears.

TIMER LIST		10:30AM
●	Mon - Sat 10:00PM - 10:15PM 4ch SP	
	Sat 11/25 8:30PM - 9:30PM 25ch SP	
☐	Sat 11/25 9:00PM - 10:00PM 3ch SLP	
●	Sun 11/26 4:00PM - 5:00PM 125ch SLP	

Timer information displays the recording date, time, recording mode, etc.



Indicates that the setting is overlapped by another setting.

● (red):

Indicates the setting is currently being recorded.



Indicates that the timer recording cannot be recorded as set, such as for a timer recording that cannot be recorded in the selected Rec mode.

When all of the timer settings do not fit on the list, the scroll bar appears.

To view the hidden timer settings, press **↑/↓**.

2 Select the timer setting you want to check/change/cancel, and press **ENTER**.

The sub-menu appears.

3 Select one of the options, and press **ENTER**.

“Modify”:

Changes the timer setting.

Select an item using **←/→** and adjust using **↑/↓**. Select “OK,” and press **ENTER**.

Modify

Modify the timer setting.

Day and Time

Wed 12/6 10:00AM - 11:30AM 2ch

Mode Extend Time

SP

“Erase”:

Erases the timer setting. Select “OK,” and press **ENTER**.

Erase



Are you sure you want to erase this timer setting?

Mon - Sat 10:00PM - 10:15PM 2ch

“Check Overlap”:

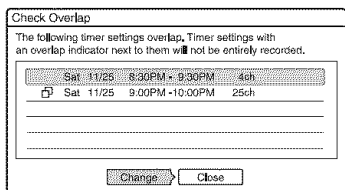



Checks for overlapped settings.
The timer setting without the  mark has priority over the other settings.



To change the priority of a program, press /  to select “Change.” For details, see “Changing the priority of overlapped settings” on page 45.

Select “Close” to return to the Timer List. To change or cancel the setting, repeat steps 2 and 3 above.

To scroll the list display by page (Page mode)

Press  REPLAY/ADVANCE  while the list display is turned on. Each time you press  REPLAY/ADVANCE , the entire Timer List changes to the next/previous page of timer settings.

To turn off the Timer List

Press TIMER LIST or  RETURN.

Hint

While recording, you cannot modify the timer setting for the current recording, but you can extend the duration of the recording time (page 41).

Notes

- Even if the timer is set, timer recordings cannot be made while recording a program that has priority.
- Even if the timer is set for the same daily or weekly program, the timer recording cannot be made if it overlaps with a program that has priority. “” will appear next to the overlapped setting in the Timer List. Check the priority order of the settings.

Changing the priority of overlapped settings

If the timer settings overlap, the program that was set last has priority and will be recorded. A timer recording of lower priority may be canceled, start from the middle or stop midway through the program. You can change the priority of a program if necessary.

When the timer settings overlap

The program set last has priority.

Example: You set the timer in order of A, B, and C (setting C has first priority)

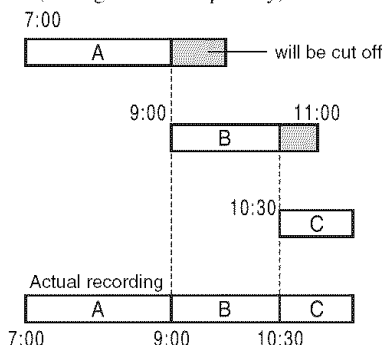

If you give setting B priority over setting C, all of program B will be recorded and program C is recorded only after program B has ended.

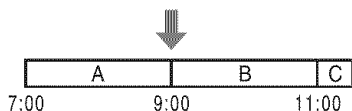

If the end time of one recording and the start time of another are the same

If program B has priority, the end of program A will be cut off.

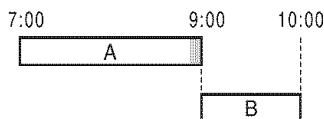

If program A has priority, recording of program B may be delayed.

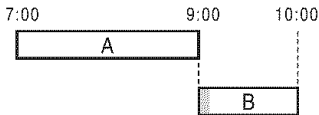

💡 Hint

You can change the priority of a timer setting while recording.

1 Press TIMER LIST.

The Timer List appears.

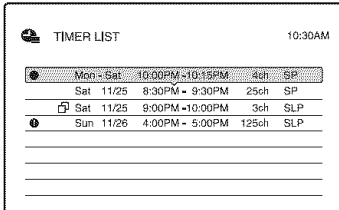

2 Select an overlapped timer setting, and press ENTER.

☐ indicates that the timer setting is overlapped by another timer setting.

3 Select “Check Overlap,” and press ENTER.

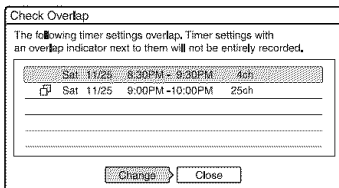

4 Select “Change,” and press ENTER.

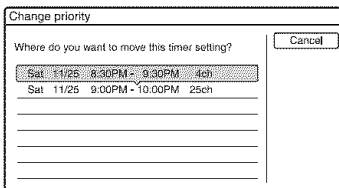

5 Press ↑/↓ to change the timer setting’s priority, and press ENTER.

The setting moves to its new location in the list. A timer setting higher up in the list has higher priority.

To return to the Timer List, select “Cancel.”

Recording From Connected Equipment

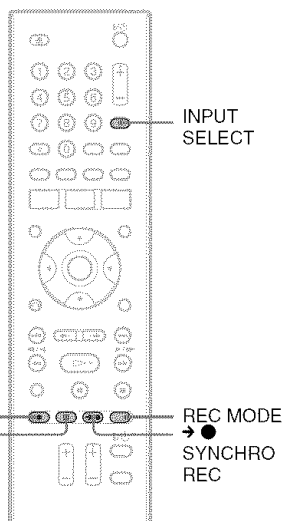

Recording from connected equipment with a timer (Synchro Rec)

You can set the recorder to automatically record programs from connected equipment that has a timer function (such as a satellite tuner). Connect the equipment to the LINE 1 IN jacks of the recorder (page 26). When the connected equipment turns on, the recorder starts recording a program from the LINE 1 IN jacks.

- 1 Insert a recordable DVD.**
See "1. Inserting a Disc" on page 27.
- 2 Press INPUT SELECT repeatedly to select "L1."**
- 3 Press REC MODE repeatedly to select the recording mode.**
For details about the recording mode, see page 39.

- 4 Set the timer on the connected equipment to the time of the program you want to record, and turn it off.**
- 5 Press → ● SYNCHRO REC.**
The SYNCHRO REC indicator lights up on the front panel. The recorder is ready to start Synchro-Recording.
The recorder automatically starts recording when it receives an input signal from the connected equipment.
The recorder stops recording when the connected equipment turns off.

To stop recording

Press ■ REC STOP or → ● SYNCHRO REC.

To cancel Synchro Rec

Press → ● SYNCHRO REC.
The SYNCHRO REC indicator on the recorder turns off.

Notes

- The recorder starts recording only after detecting a video signal from the connected equipment. The beginning of the program may not be recorded regardless of whether or not the recorder's power is on or off.
- During Synchro-Recording, other operations, such as normal recording, cannot be performed.
- To use the connected equipment while the recorder is standing by for Synchro-Recording, cancel Synchro-Recording by pressing → ● SYNCHRO REC. Be sure to turn off the connected equipment and press → ● SYNCHRO REC to reset Synchro-Recording before the timer recording starts.
- The Synchro Rec function does not work with some tuners. For details, see the tuner's operating instructions.
- While the recorder is standing by for Synchro-Recording, the Auto Clock Set function (page 72) does not work.
- To use the Synchro Rec function, you must first set the recorder's clock correctly.

If the timer settings of a Synchro-Recording and another timer recording overlap

Regardless of whether or not the program is a Synchro Rec program, the program that starts first has priority and the second program starts recording only after the first program has finished.

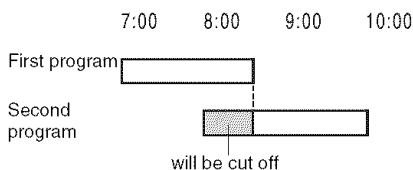

Recording from connected equipment without a timer

You can record from a connected VCR or similar device. To connect a VCR or similar device, see “Connecting a VCR or Similar Device” on page 24. Use the DV IN jack on the front panel if the equipment has a DV output jack (i.LINK jack).

1 Insert a recordable DVD.

See “1. Inserting a Disc” on page 27.

2 Press INPUT SELECT to select an input source according to the connection you made.

The front panel display changes as follows:

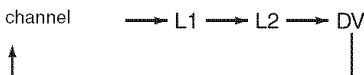

3 Press REC MODE repeatedly to select the recording mode.

For details about the recording mode, see page 39.

4 Insert the source tape into the connected equipment and set to playback pause.

5 Press ● REC.

This recorder starts recording.

6 Press the pause (or play) button on the connected equipment to cancel the playback pause status.

The connected equipment starts playback and the playback image is recorded by this recorder.

To stop recording, press ■ REC STOP on this recorder.

If you connect a digital video camera with a DV IN jack

See “DV/Digital8 Dubbing” on page 66 for an explanation of how to record from the DV IN jack.

💡 Hint

You can adjust the settings for the recording picture before recording. See “Adjusting the recording picture quality and size” on page 42.

🔍 Notes

- When recording a video game image, the screen may not be clear.
- Any program that contains a Copy-Never copy guard signal cannot be recorded. The recorder continues to record, but a blank screen will be recorded.

Playing

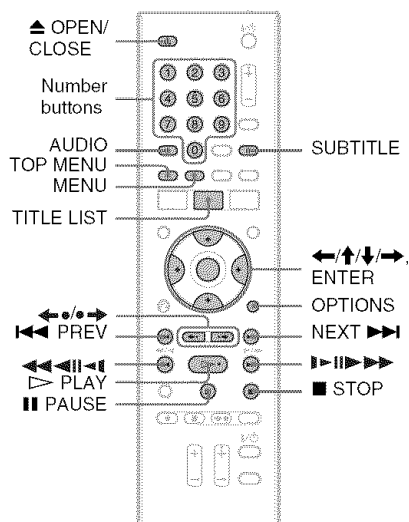

1 Insert a disc.

- See “1. Inserting a Disc” on page 27.
- If you insert a DVD VIDEO, VIDEO CD, CD, DATA DVD, or DATA CD, press **▶ PLAY**. Playback starts.

2 Press TITLE LIST.

For details about the Title List, see “3. Playing the Recorded Program (Title List)” on page 28.

Example: DVD+RW

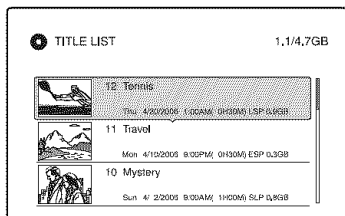

3 Select the title, and press ENTER.

The sub-menu appears.

4 Select “Play,” and press ENTER.

Playback starts from the selected title.

To use the DVD’s Menu

When you play a DVD VIDEO, or a finalized DVD+RW, DVD-RW (Video mode), DVD+R, or DVD-R (Video mode), you can display the disc’s menu by pressing **TOP MENU** or **MENU**.

To play VIDEO CDs with PBC functions

PBC (Playback Control) allows you to play VIDEO CDs interactively using the menu on your TV screen.

When you start playing a VIDEO CD with PBC functions, the menu appears.

Select an item using the number buttons and press **ENTER**. Then, follow the instructions in the menu (press **▶ PLAY** when “Press SELECT” appears).

The PBC function of Super VIDEO CDs does not work with this recorder. Super VIDEO CDs are played in continuous play mode only.

To change the angles

If various angles (multi-angles) for a scene are recorded on the disc, “ ” appears in the front panel display. Press **OPTIONS** during playback to select “Change Angle,” and press **ENTER**.

To stop playback

Press **■ STOP**.

To resume playback from the point where you stopped (Resume Play)

When you press \triangleright PLAY again after you stop playback, the recorder resumes playback from the point where you pressed \blacksquare STOP. To start from the beginning, press OPTIONS to select "Play Beginning," and press ENTER. Playback starts from the beginning of the title/track/scene.

The point where you stopped playing is cleared when:

- you open the disc tray.
- you play another title.
- you switch the Title List menu to Original or Playlist (DVD-RWs/DVD-Rs in VR mode only).
- you edit the title after stopping playback.
- you change the settings on the recorder.
- you turn off the recorder (VIDEO CD/CD/DATA DVD/DATA CD only).
- you make a recording (except for DVD-RWs/DVD-Rs in VR mode).
- you disconnect the AC power cord.

To play restricted DVDs (Parental Control)

If you play a restricted DVD, the message "Do you want to temporarily change the Parental Control level to *?" appears on your TV screen.

- 1 Select "OK" and press ENTER.
The display for entering your password appears.
- 2 Enter your four-digit password using the number buttons.
- 3 Press ENTER to select "OK."
The recorder starts playback.

To register or change the password, see "Parental Control (DVD VIDEO only)" on page 79.

To lock the disc tray (Child Lock)

You can lock the disc tray to prevent children from ejecting the disc.

When the recorder is turned on, hold down \blacksquare STOP until "LOCKED" appears in the front panel display. The \blacktriangle OPEN/CLOSE button does not work while the Child Lock is set.







To unlock the disc tray, hold down \blacksquare STOP until "UNLOCKED" appears in the front panel display when the recorder is turned on.

Hints

- You can also use the \triangleright PLAY button in step 3 (page 49) to start playback.
- Even if you select "Factory Setup" in the "Others" setup (page 81), the Child Lock remains set.

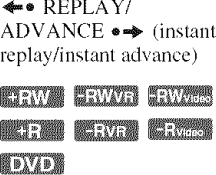
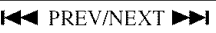
Playback options

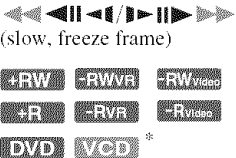
To check the position of the buttons below, see the illustration on page 49.
 For MP3 or JPEG operations, see “Playing MP3 Audio Tracks or JPEG Image Files” on page 55.

Buttons	Operations								
AUDIO 	Selects one of the audio tracks recorded on the disc when pressed repeatedly in normal playback mode. DVD : Selects the language. -RWVR -RVR : Selects the main or sub sound. VCD CD : Selects stereo or monaural audio tracks.								
SUBTITLE 	Selects a subtitle language when pressed repeatedly.								
	Replays the scene/briefly fast forwards the scene.								
	Goes to the beginning of the previous/next title/chapter/scene/track.								
	Fast reverses/fast forwards the disc when pressed during playback. Search speed changes as follows: <div style="text-align: center; margin: 10px 0;"> <table style="margin: auto; border: none;"> <tr> <td style="padding: 0 10px;">fast reverse</td> <td style="padding: 0 10px;">fast forward</td> </tr> <tr> <td style="text-align: center;">◀◀1 ←</td> <td style="text-align: center;">→1▶▶</td> </tr> <tr> <td style="text-align: center;">◀◀2 ← ←</td> <td style="text-align: center;">→→2▶▶▶</td> </tr> <tr> <td style="text-align: center;">◀◀3* ← ← ←</td> <td style="text-align: center;">→→→3▶▶▶*</td> </tr> </table> </div> When you press and hold the button, fast forward/fast reverse continues at the selected speed until you release the button. * ◀◀3 and ▶▶3 are only available for DVDs.	fast reverse	fast forward	◀◀1 ←	→1▶▶	◀◀2 ← ←	→→2▶▶▶	◀◀3* ← ← ←	→→→3▶▶▶*
fast reverse	fast forward								
◀◀1 ←	→1▶▶								
◀◀2 ← ←	→→2▶▶▶								
◀◀3* ← ← ←	→→→3▶▶▶*								
	Plays in slow motion when pressed for more than one second in pause mode. Plays one frame at a time when pressed briefly in pause mode.								
* Playback direction only									
	Pauses playback.								

To resume normal playback, press  PLAY.

Notes

- Angles and subtitles cannot be changed with titles recorded on this recorder.
- Slideshows made with a DVD camcorder can only be played. Other play functions, such as fast forward, cannot be used.

Notes on playing DTS sound tracks on a CD

- When playing DTS-encoded CDs, excessive noise will be heard from the analog stereo jacks. To avoid possible damage to the audio system, the consumer should take proper precautions when the analog stereo jacks of the recorder are connected to an amplification system. To enjoy DTS Digital Surround™ playback, an external DTS decoder must be connected to the DIGITAL OUT jack of the recorder.
- Set the sound to “Stereo” using the AUDIO button when you play DTS sound tracks on a CD (page 51).

Notes on playing DVDs with a DTS sound track

DTS audio signals are output only through the DIGITAL OUT (COAXIAL) jack.

When you play a DVD with DTS sound tracks, set “DTS” to “On” in the “Audio” setup (page 76).

Adjusting the picture quality



- 1 Press **OPTIONS** during playback to select “Video Settings,” and press **ENTER**.

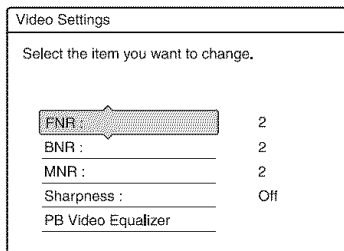

- 2 Select an item, and press **ENTER**.

The adjustment display appears.

“FNR” (frame noise reduction):

Reduces noise contained in the luminance element of the video signal.

“BNR” (block noise reduction):

Reduces “block noise” or mosaic like patterns in the picture.

“MNR” (mosquito noise reduction):

Reduces the faint noise appearing around the outlines of the images. The noise reduction effects are automatically adjusted within each setting range according to the video bit rate and other factors.

“Sharpness”:

Sharpens the outlines of the images.

“PB Video Equalizer” (Playback video equalizer):

Adjusts the picture in greater detail.

Select an item and press **ENTER**.

- Contrast: changes the contrast.
- Brightness: changes the overall brightness.
- Color: makes the colors deeper or lighter.
- Hue: changes the color balance.

- 3 Press **←/→** to adjust the setting, and press **ENTER**.

The default settings are underlined.

“FNR”: (weak) Off 1 2 3 (strong)

“BNR”: (weak) Off 1 2 3 (strong)

“MNR”: (weak) Off 1 2 3 (strong)

“Sharpness”*: (weak) Off 1 2 3 (strong)

“PB Video Equalizer”:

• Contrast: (weak) -3 ~ 0 ~ 3 (strong)

• Brightness: (dark) -3 ~ 0 ~ 3 (bright)

• Color: (light) -3 ~ 0 ~ 3 (deep)

• Hue: (red) -3 ~ 0 ~ 3 (green)

Repeat steps 2 and 3 to adjust any other items.

* “1” softens the outlines of the images. “2” enhances the outlines and “3” enhances them more than “2.”

⚡ Notes

- If the outlines of the images on your screen become blurred, set “BNR” and/or “MNR” to “Off.”
- Depending on the disc or the scene being played, the above BNR, MNR, or FNR effects may be hard to discern. And, these functions may not work with some screen sizes.
- When using the “Sharpness” function, noise found in the title may become more apparent. In this case, it is recommended that you use the BNR function with the “Sharpness” function. If the condition still does not improve, set the “Sharpness” level to “Off.”

Adjusting the delay between the picture and sound (AV SYNC)



- 1 Press **OPTIONS** during playback to select “Audio Settings,” and press **ENTER**.
- 2 Select “AV SYNC”, and press **ENTER**. “AV SYNC”:
When the video is delayed, this function delays the audio for synchronization with the video (0 to 120 milliseconds). Larger numbers indicate a longer audio delay for synchronization with the video. When dubbing to a VCR or other video recording equipment, be sure to return this setting to 0 ms (default).
- 3 Press **←/→** to adjust the setting, and press **ENTER**.

Playing from the beginning of the program you are recording (Chasing Playback)

-RWVR

“Chasing Playback” allows you to view the recorded part of a program while the recording is being made. You do not need to wait until the recording finishes.

Press **OPTIONS** while recording to select “Chasing Playback,” and press **ENTER**.

Playback starts from the beginning of the program you are recording.

When you fast forward to the point that you are recording, Chasing Playback returns to normal playback.

⚡ Notes

- For DVD-RWs (VR mode), this function does not work when recording:
 - on a 1x-speed DVD-RW.
 - in the HQ or HSP recording mode.
- The DVD’s picture on your TV screen freezes for a few seconds when you fast forward/fast reverse or instant replay/advance the recording.
- Chasing Playback is possible from one minute or more after recording starts.
- Even if you fast forward the recorded program, there will always be a time difference of about one minute or more between the recorded program and the current TV broadcast.

Playing a previous recording while making another (Simultaneous Rec and Play)

-RWvR

You can play a previously recorded program while recording another on the same disc. Playback continues even if the recording is a timer recording.

- 1 While recording, press TITLE LIST.**
The Title List appears.
- 2 Select the title you want to play, and press ENTER.**
The sub-menu appears.
- 3 Select "Play", and press ENTER.**
Playback starts from the selected title.

Notes

- This function does not work when recording:
 - on a 1x-speed DVD-RW.
 - in the HQ or HSP recording mode.
- When playing a title recorded in the HQ or HSP recording mode, picture noise may appear depending upon the condition of the recording.
- Picture noise may appear depending upon the condition of the recording, or when playing a title recorded in the HQ or HSP recording mode. The picture freezes for a few seconds when you use fast forward/fast reverse or instant replay/advance.

Searching for a Title/Chapter/Track, etc.

+RW -RWvR -RWvideo +R -RvR
-Rvideo DVD VCD CD DATA DVD
DATA CD

You can search a disc by title, chapter, scene or track. As titles and tracks are assigned individual numbers, select the title or track by entering its number. You can also search for a scene using the time code.

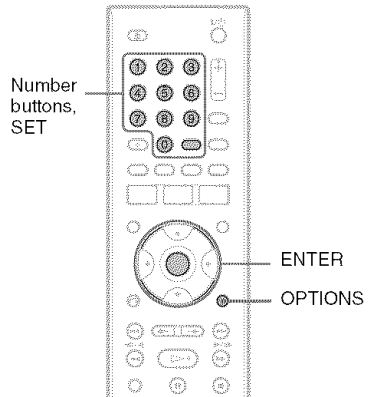

- 1 Press OPTIONS during playback to select a search method, and press ENTER.**

"Title Search" (for DVDs)
"Chapter Search" (for DVDs)
"Track Search" (for CDs/DATA CDs)
"Search" (for VIDEO CDs)
"Album Search" (for DATA DVDs/
DATA CDs)
"Time Search" (for DVDs): Searches for a starting point by entering the time code.
"File Search" (for DATA DVDs/DATA CDs)

The display for entering the number appears.

Example: Title Search



The number in parentheses indicates the total number of titles, tracks, etc.

2 Press the number buttons to select the number of the title, chapter, track, time code, etc., you want.

For example: Time Search

To find a scene at 2 hours, 10 minutes, and 20 seconds, enter "21020."

If you make a mistake, select another number.

3 Press ENTER or SET.

The recorder starts playback from the selected number.

Playing MP3 Audio Tracks or JPEG Image Files

DATA DVD DATA CD

You can play MP3 audio tracks and JPEG image files on DATA CDs (CD-ROMs/CD-Rs/CD-RWs) or JPEG image files on DATA DVDs (DVD-ROMs/DVD+RWs/DVD+Rs/DVD-RWs/DVD-Rs).

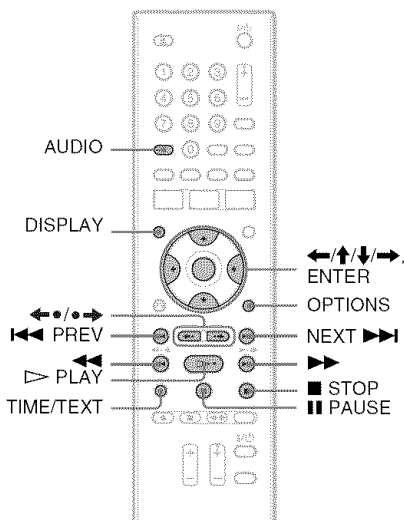

1 Insert a disc.

See "1. Inserting a Disc" on page 27.

2 Press ▷ PLAY.

For MP3 discs, playback starts from the first MP3 audio track on the disc.

For JPEG files, a slideshow of the pictures on the disc begins.

If the disc contains MP3 audio tracks and JPEG image files, only the JPEG image files are played back when ▷ PLAY is pressed.

To stop playback or slideshow

Press ■ STOP.

To pause playback or slideshow

Press ■ PAUSE.

To play the beginning of the track

Press **OPTIONS** to select "Play Beginning," and press **ENTER**.

To fast forward or review a track

Press **◀◀/▶▶** during playback.

To go to the next or previous MP3 audio track or JPEG image file

Press **◀◀ PREV** or **NEXT ▶▶** during playback. If you repeatedly press **◀◀ PREV** or **NEXT ▶▶**, you will go to the next or previous album. (MP3 audio track only)

To go to the next or previous album

Press **◀• REPLAY/ADVANCE •▶** during playback or slideshow.

To rotate a picture

Press **OPTIONS** while the JPEG image is displayed to select "Rotate Right" or "Rotate Left," and press **ENTER**.

Hints

- Press the **AUDIO** button to switch between stereo or monaural audio tracks.
- You can rotate a JPEG image by using the **◀/▶** buttons when the image is displayed.
- Press **DISPLAY** repeatedly to show information about the JPEG album or image on your TV screen. Then press **TIME/TEXT** to toggle between the current selected image number and album number.

Notes

- Some JPEG files, especially files of three million pixels or more, may lengthen the slideshow interval.
- Rotated JPEG images will not be saved when you switch to another folder.
- Images larger than 720 × 480 will be reduced to 720 × 480 when displayed.
- The following images are not displayed:
 - progressive JPEG image files
 - grayscale JPEG image files
 - 4:1:1 JPEG image files
- When you attempt to play a broken file or a file that does not satisfy the play conditions,  appears but the recorder cannot play the file.

About MP3 audio tracks and JPEG image files

MP3 is an audio compression technology that satisfies certain ISO/MPEG regulations.

JPEG is an image compression technology. You can play MP3 (MPEG1 Audio Layer 3) format audio tracks and JPEG image files on DATA CDs (CD-ROMs/CD-Rs/CD-RWs) or JPEG image files on DATA DVDs (DVD-ROMs/DVD+RWs/DVD+Rs/DVD-RWs/DVD-Rs).

DATA CDs must be recorded according to ISO9660 Level 1, Level 2 or Joliet format for the recorder to recognize the MP3 tracks.

You can also play discs recorded in MultiSession/Border.

See the instructions supplied with the disc drives and the recording software (not supplied) for details on the recording format.

Note on MultiSession/Border discs

If audio tracks and images in Music CD format or Video CD format are recorded in the first session/border, only the first session/border will be played back.

Note

The recorder may not be able to play some DATA CDs created in the Packet Write format.

MP3 audio tracks or JPEG image files that the recorder can play

The recorder can play the following tracks and files:

- MP3 audio tracks with the extension “.mp3.”
- JPEG image files with the extension “.jpeg” or “.jpg.”
- JPEG image files that conform to the DCF* image file format.

* “Design rule for Camera File system”: Image standards for digital cameras regulated by JEITA (Japan Electronics and Information Technology Industries Association).

Notes

- The recorder will play any data with the extension “.mp3,” “.jpeg,” or “.jpg,” even if they are not in MP3 or JPEG format. Playing these data may generate a loud noise which could damage your speaker system.
- The recorder does not conform to audio tracks in mp3PRO format.
- Some files cannot be played.
- The letters that cannot be displayed are replaced with “*.”

About playback order of albums, tracks, and files

Albums play in the following order:

Structure of disc contents

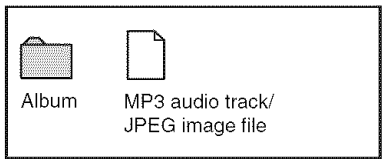
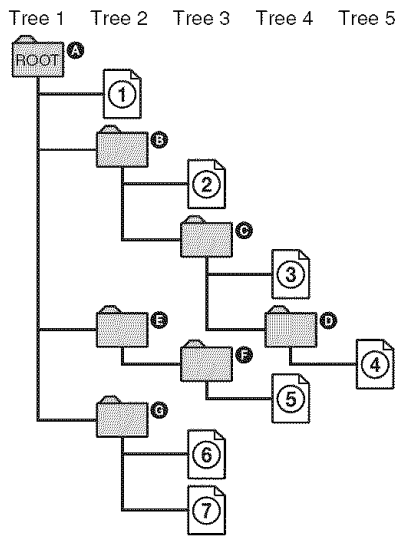

When you insert a DATA CD/DATA DVD and press \triangleright PLAY, the numbered tracks (or files) are played sequentially, from ① through ⑦. For JPEG image files, press ADVANCE $\bullet\rightarrow$ to go to the next album. (For instance, when you want to go from ① to ②.) Any sub-albums/tracks (or files) contained within a currently selected album take priority over the next album in the same tree. (Example: C contains D so ④ is played before ⑤.)

Hints

- If you add numbers (01, 02, 03, etc.) to the front of the track/file names when you store the tracks (or files) in a disc, the tracks and files will be played in that order.
- Since a disc with many trees takes longer to start playback, it is recommended that you create albums with no more than two trees.

Notes

- Depending on the software you use to create the DATA DVD/DATA CD, the playback order may differ from the above illustration.
- No more than a total of 999 individual folders can be played. (Folders that do not contain JPEG/MP3 files are counted as well.)
- No more than a total of 999 folders and 9999 files can be played. (Files other than JPEG/MP3 files, and folders that do not contain JPEG/MP3 files are counted as well.)
- No more than 999 folders and files can be recognized in a single folder. (Folders that do not contain JPEG/MP3 files are counted as well.)
- Proceeding to the next or another album may take some time.
- This recorder supports MP3 audio bit rates up to 320 kbps.

Before Editing

This recorder offers various edit options for various disc types.

Notes

- You may lose the edited contents if you remove the disc or a timer recording starts while editing.
- DVD discs created by DVD video cameras cannot be edited on this recorder.
- If a message appears and indicates that the disc's control information is full, erase or edit unnecessary titles.
- When editing a DVD+R or DVD-R, finish all editing before finalizing the disc. You cannot edit a finalized disc.

Edit features	-RW/R		+RW	
	Original title	Playlist title	-RW _{Video}	+R
Erase (page 60)	Yes	Yes	Yes	
Protect Title (page 60)	Yes	No	Yes	
Title Name (page 60)	Yes	Yes	Yes	
A-B Erase (page 61)	Yes	Yes	Yes*	
Erase Titles (page 60)	Yes	Yes	Yes	
Divide Title (page 65)	No	Yes	No	
Set Thumbnail (page 60)	Yes	Yes	No	
Chapter mark (page 62)	Yes	Yes	No	
Playlist creation (page 62)	Yes	Yes	No	
Change Order (page 64)	No	Yes	No	
Combine Titles (page 64)	No	Yes	No	

* DVD+RW only

To open up disc space

To open up disc space on a DVD+RW or DVD-RW (Video mode), erase the title with the largest number in the title list.

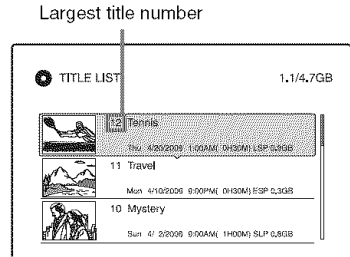

For the DVD-RWs (VR mode), you can erase any title.

For DVD-Rs and DVD+Rs, the available disc space does not increase even if you erase titles.

See “Erasing and Editing a Title” on page 60 or “Erasing multiple titles (Erase Titles)” on page 60.

To switch between the Playlist and Original Title List

You can display the Playlist titles in the Title List (Playlist), or the Original titles in the Title List (Original). To switch the two Title Lists, press **←/→** while a Title List is displayed. To create and edit a Playlist, see page 62.

Erasing and Editing a Title



This section explains the basic edit functions. Note that editing is irreversible. To edit DVD-RWs/DVD-Rs (VR mode) without changing the original recordings, create a Playlist title (page 62).

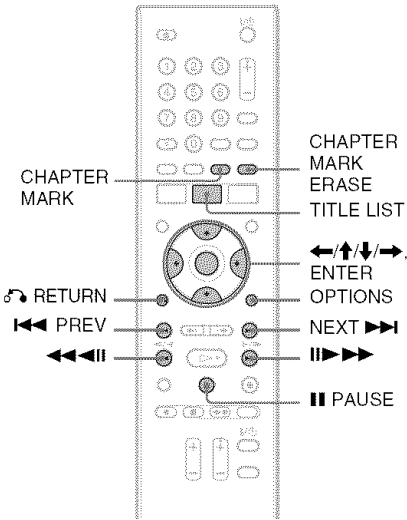

1 Press TITLE LIST.

For DVD-RWs/DVD-Rs in VR mode, press **←/→** to switch the Title Lists, if necessary.

2 Select a title, and press ENTER.

The sub-menu appears.

3 Select an option, and press ENTER.

You can make the following edits to the title.

“Erase”: Erases the selected title. Select “OK” when asked for confirmation.

“Protect Title”: Protects the title. “” appears next to the protected title.

“Title Name”: Allows you to enter or re-enter a title name (page 33).

“A-B Erase”: Erases a section of the title (page 61).

“Set Thumbnail”: Changes the title’s thumbnail picture that appears in the Title List (page 30).
“Make a Playlist”: Adds the entire title to the Playlist title as one scene (page 64).

Hints

- You can erase multiple titles at one time (page 60).
- You can label or re-label DVDs (page 34).

Note

DVD-RW/DVD-R (VR mode) playlist titles cannot be protected.

Erasing multiple titles (Erase Titles)



You can select and erase more than one title at one time using the OPTIONS menu.

1 Press TITLE LIST.

For DVD-RWs/DVD-Rs in VR mode, press **←/→** to switch the Title Lists, if necessary.

2 Press OPTIONS to select “Erase Titles,” and press ENTER.

The display for selecting titles to be erased appears.

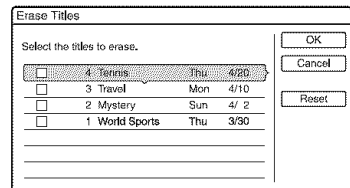

3 Select a title, and press ENTER.

A check mark appears in the check box next to the selected title.

- To clear the check mark, press ENTER again.
- To clear all of check marks, select “Reset.”

4 Repeat step 3 to select all of the titles you want to erase.

5 When you finish selecting titles, select “OK,” and press ENTER.

The list of the titles to be erased appears for confirmation.

- To change the selection, select “Change,” and repeat from step 3.

6 Select “OK” and press ENTER.

The titles are erased.

To erase all titles on the disc

You can reformat a DVD+RW or DVD-RW to make the disc blank.

See “8. Reformatting a disc” on page 37.

Erasing a section of a title (A-B Erase)

+RW -RWVR -RVR

You can select a section (scene) in a title and erase it. Note that erasing scenes in a title cannot be undone.

1 After step 2 of “Erasing and Editing a Title,” select “A-B Erase” and press ENTER.

The display for setting point A appears. The title starts to play.

- To return to the beginning of the title, press **II/III** PAUSE and then press **IIII** PREV.

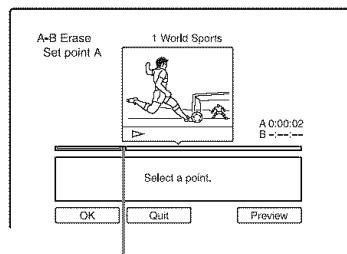

Playback point

2 Select point A using **◀◀/▶▶**, and press ENTER.

Playback pauses.

3 Press ENTER if point A is correct.

If point A is incorrect, select point A using **◀II/III▶**, and press ENTER. The display for setting point B appears.

4 Select point B using **◀◀/▶▶**, and press ENTER.

Playback pauses.

5 Press ENTER if point B is correct.

If point B is incorrect, select point B using **◀II/III▶**, and press ENTER. The display asks for confirmation.

- To reset point A, press **↑** and **↶** RETURN, and go to step 2.
- To reset point B, press **↑** and repeat step 4.
- To preview the title without scenes to be erased, select “Preview” (except for DVD+RWs).

6 Select “OK,” and press ENTER.

The scene is erased. The display for setting point A appears.

- To continue, go to step 2.
- To finish, select “Quit.”

💡 Hint

A chapter mark is inserted after the scene was erased. The chapter mark divides the title into separate chapters on either side of the mark.

⚡ Notes

- Images or sound may be momentarily interrupted at the point where you erase a section of a title.
- Sections shorter than five seconds may not be erased.
- For DVD+RWs, the erased section may be slightly different from the points you selected.

Creating chapters manually

-RWVR -RVR

You can manually insert a chapter mark at any point you like during playback or recording.

Press CHAPTER MARK at the point where you want to divide the title into chapters.

Each time you press the button, "Marking ..." appears on the screen and the scenes to the left and right of the mark become separate chapters.

To erase chapter marks

You can combine two chapters by erasing the chapter mark during playback.

Press ◀◀ PREV/NEXT ▶▶ to search for a chapter number, and while displaying the chapter containing the chapter mark you want to erase, press CHAPTER MARK ERASE. The current chapter combines with the previous chapter.

Note

To insert a chapter mark manually during recording, set "Auto Chapter" to "Off" in the "Recording" setup.

Creating and Editing a Playlist

-RWVR -RVR

Playlist edit allows you to edit or re-edit without changing the actual recordings. You can create up to 97 Playlist titles.

Example: You have recorded the final few matches of a football tournament on a DVD-RW/DVD-R (VR mode). You want to create a digest with the goal scenes and other highlights, but you also want to keep the original recording.

Original

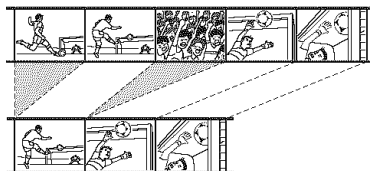

Playlist

In this case, you can compile highlight scenes as a Playlist title. You can even rearrange the scene order within the Playlist title.

The Playlist title calls up data from the original titles for playback. When an original title is used for a Playlist title, the original title cannot be edited and erased.

1 Press TITLE LIST.

If the Title List (Original) appears, press ←.

2 Press OPTIONS to select "Create a Playlist," and press ENTER.

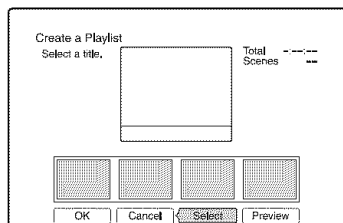

3 Select "Select," and press ENTER.

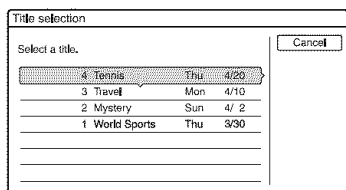

4 Select the title you want to include in the Playlist title, and press ENTER.

The display for setting the start point (IN) appears. The title starts to play.

- To return to the beginning of the title, press **II** PAUSE and then press **◀◀** PREV.

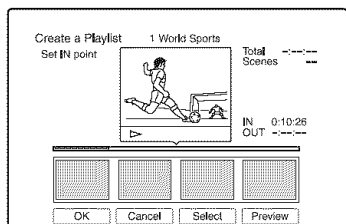

5 Select the IN point using **◀◀/▶▶**, and press ENTER.

Playback pauses.

6 Press ENTER if the IN point is correct.

If the IN point is incorrect, select the IN point using **◀II/II▶**, and press ENTER. The display for setting the end point (OUT) appears.

7 Select the OUT point using **◀◀/▶▶**, and press ENTER.

Playback pauses.

8 Press ENTER if the OUT point is correct.

If the OUT point is incorrect, select the OUT point using **◀II/II▶**, and press ENTER.

The selected scene is added to the scene list.

- To add more scenes, go to step 5.

9 When you finish adding scenes, press **↓**.

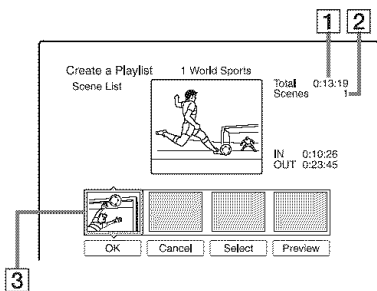

1 Total duration of the selected scene

2 Total number of scenes

3 Selected scene

10 Select the scene you want to re-edit, and press ENTER.

The sub-menu appears.

“Move”: Changes the scene order using **◀/▶** and press ENTER.

“Erase”: Erases the scene. When asked for confirmation, select “OK.”

- To add more scenes, press **↑** and go to step 5.
- To add more scenes from another title, select “Select” and go to step 4.
- To preview all of the captured scenes in the listed order, select “Preview.”

11 When you finish editing the scene list, select “OK,” and press ENTER.

The title of the created Playlist is added to the Title List (Playlist). The title name is the title name of the first scene.

💡 Hint

When a Playlist title is created, the IN and OUT points will become chapter marks, and each scene will become a chapter.

📌 Note

The picture may pause when the edited scene is played.

To add the entire title to the Playlist title as one scene (Make a Playlist)

- 1 Press TITLE LIST. If the Title List (Playlist) appears, press **→**.
- 2 Select the title and press ENTER. The sub-menu appears.
- 3 Select "Make a Playlist," and press ENTER. The selected title is added to the Title List (Playlist). The title name is the same as the Original title name.

To play the Playlist title

- 1 Press TITLE LIST. If the Title List (Original) appears, press **←**.
- 2 Select a title, and press ENTER. The sub-menu appears.
- 3 Select "Play," and press ENTER.

Moving a Playlist title (Change Order)

-RWVR **-RVR**

You can change the Playlist title order within the Title List (Playlist).

- 1 Press TITLE LIST. If the Title List (Original) appears, press **←**.
- 2 Press OPTIONS to select "Change Order," and press ENTER.

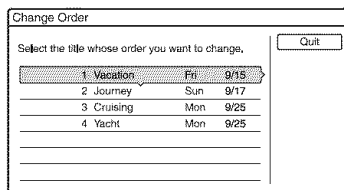

- 3 Select the title you want to move, and press ENTER.
- 4 Select a new location for the title using **↑/↓**, and press ENTER. The title moves to the new location.
 - To move more titles, go to step 3.
 - To finish, select "Quit," and press ENTER.

Combining multiple Playlist titles (Combine Titles)

-RWVR **-RVR**

- 1 Press TITLE LIST. If the Title List (Original) menu appears, press **←**.
- 2 Press OPTIONS to select "Combine Titles," and press ENTER. The display for selecting titles appears.
- 3 Select a title, and press ENTER. A number indicating the order in which you selected the title appears. To cancel the selection, press ENTER again.

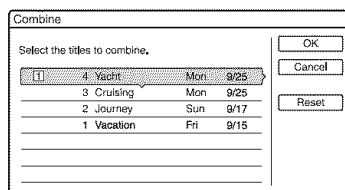

- 4 Repeat step 3 to select all of the titles you want to combine. To cancel all of the selections, select "Reset."
- 5 Select "OK," and press ENTER. The list of titles to be combined appears. To change the selection, select "Change" and go to step 3.

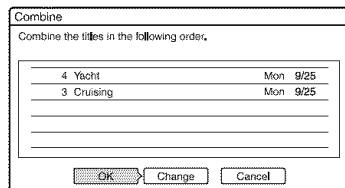

- 6 Select "OK," and press ENTER. The titles are combined.

Hint

After titles are combined, the title name is the title name of the first title prior to combination.

Note

When the number of chapters in the title to be combined exceeds the limit, the chapters at the end are combined into a single chapter.

Dividing a Playlist title (Divide Title)

-RWVR **-RVR**

You can divide a Playlist title.

1 Press TITLE LIST.

If the Title List (Original) appears, press **←**.

2 Select a title, and press ENTER.

The sub-menu appears.

3 Select “Divide Title,” and press ENTER.

The display for setting the dividing point appears, and the title starts to play.

- To return to the beginning of the title, press **⏮** PAUSE and then press **⏪** PREV.

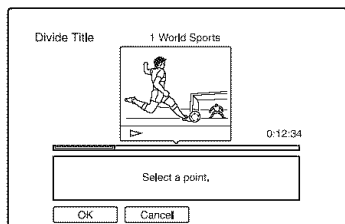

4 Select the dividing point by pressing **⏮/⏭**, and press ENTER.

Playback pauses.

5 Press ENTER if the dividing point is correct.

If the dividing point is incorrect, select the dividing point using **⏮/⏭**, and press ENTER.

The display asks for confirmation.

- To change the dividing point, press **↑**.

6 Select “OK,” and press ENTER.

The title is divided in two.

Hint

After a title is divided, the title name prior to division is assigned to both the first and second parts.

DV/Digital8 Dubbing

Before DV/Digital8 Dubbing

This section explains dubbing with a digital video camera via the DV IN jack on the front panel. If you want to dub by way of the LINE IN jacks, see “Recording from connected equipment without a timer” on page 48.

The DV IN jack on this recorder conforms to the i.LINK standard.

Follow the instructions in “Preparing for DV/Digital8 dubbing,” and then move on to the section on dubbing. For more information about i.LINK, see “About i.LINK” on page 90.

Preparing for DV/Digital8 dubbing

You can connect a digital video camera to the DV IN jack on the recorder to record or edit from a DV/Digital8 format tape. Operation is straightforward because the recorder will fast forward and rewind the tape for you – you do not need to operate your digital video camera. Do the following to start using the “DV/D8 Edit” functions of this recorder. See the instruction manual supplied with the digital video camera as well before connecting.

Hint

If you plan to do additional editing on a disc after the initial dub, use the DV IN jack and record on a DVD-RW/DVD-R (VR mode).

Notes

- You cannot make a recording while DV dubbing.
- The DV IN jack is for input only. It will not output signals.
- You cannot use the DV IN jack when:
 - signal input to the DV IN jack on the front panel or recorder operation cannot be performed correctly when using a digital video camera (see “About i.LINK” on page 90). Connect the camera to the LINE IN jack and follow the instructions of “Recording from connected equipment without a timer” on page 48.
 - the input signal is not in DVC-SD format. Do not connect a MICRO MV format digital video camera even if it has an i.LINK jack.
 - the images on the tape contain copy protection signals, which limit recording.
- If you want to play the disc on other DVD equipment, finalize the disc (page 35).

Hookups

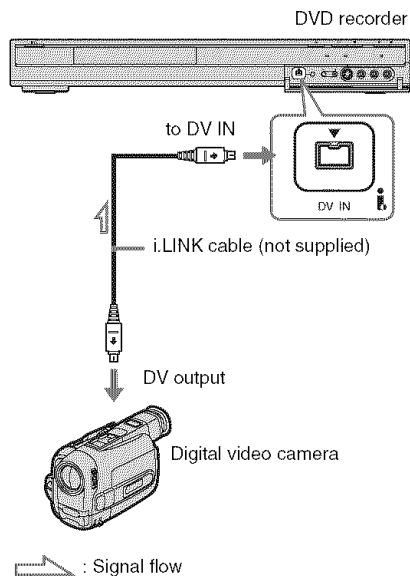

1 Insert a disc.

See “1. Inserting a Disc” on page 27.

2 Insert the source DV/Digital8 format tape into your digital video camera.

For the recorder to record or edit, your digital video camera must be set to video playback mode.

3 Press INPUT SELECT on the remote repeatedly to select "DV."

The front panel display changes as follows:

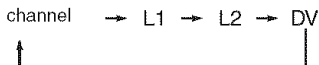

4 Press REC MODE on the remote repeatedly to select the recording mode.

The recording mode changes as follows:



For details about the recording mode, see page 39.

5 Press OPTIONS on the remote to select "DV / D8 Audio Input," and press ENTER. Then, select the setting for the audio input.

"Stereo1" (default): Records original sound only. Normally select this when dubbing a DV format tape.

"Mix": Records both stereo 1 and 2.

"Stereo2": Records additional audio only.

Select "Mix" or "Stereo2" only if you have added a second audio channel when recording with your digital video camera. You are ready to start dubbing. Select one of the dubbing methods on the following pages.

6 Adjust the dubbing picture quality and size.

Before dubbing starts, press OPTIONS to select "Rec Settings," and adjust the recording settings (page 42).

Notes

- You cannot connect more than one piece of digital video equipment to the recorder.
- You cannot control the recorder using another device or another recorder of the same model.
- You cannot record date, time, or the contents of the cassette memory onto the disc.
- If you record from a DV/Digital8 format tape that is recorded in multiple sound tracks, such as a tape with multiple sampling frequencies (48 kHz, 44.1 kHz, or 32 kHz), no sound or an unnatural sound will be output when playing back the sampling frequency switch point on the disc.
- In order to use this recorder's "Auto Chapter" setting (page 68), be sure to correctly set the clock on your digital video camera before shooting.
- The recorded picture may be momentarily affected or the start and end points of a program may be different from what you have set if the source DV/Digital8 format tape is in any of the following conditions. In this case, see "Recording from connected equipment without a timer" (page 48).
 - There is a blank space in the recorded portion of the tape.
 - The tape's time code is not sequential.
 - If the picture size or the recording mode on the tape being dubbed changes.

Hint

You can turn off the recorder during dubbing. The recorder completes dubbing even after being turned off.

Recording an Entire DV Format Tape (One Touch Dubbing)



You can record the entire contents of a DV/Digital8 format tape onto a disc with a single press of the ONE-TOUCH DUB button on the recorder. The recorder controls the digital video camera for the whole process, and completes the recording.

◆ How chapters are created

The contents dubbed to DVD become a single title. When “Auto Chapter” is set to “On” in the “Recording” setup, this title is divided into chapters. When dubbing a DVD-RW/DVD-R (VR mode), each shooting session on the tape becomes a chapter on the disc. For other discs, the recorder divides the title into chapters at approximately 6 minute intervals.

Follow steps 1 to 6 of “Preparing for DV/Digital8 dubbing” on page 66, and press ONE-TOUCH DUB on the recorder.

The recorder rewinds the tape and then starts recording the tape contents. When the recording is finished, the recorder rewinds the tape in the digital video camera.

To stop during recording

Press ■ REC STOP.

Note that it may take a few seconds for the recorder to stop recording.

💡 Hint

If you set “Finalize Disc” of “One Touch Dubbing” to “Auto” in the “DVD” setup (page 80), the recorded disc (except DVD-RW (VR mode)) will automatically be finalized after recording is finished.

⚡ Notes

- When a blank space between the recordings on the tape continues for more than five minutes, One Touch Dubbing ends automatically.
- The recorder records a blank for five minutes before it stops dubbing. To stop the blank recording, press ■ REC STOP.

Program Edit



You can select scenes from a DV/Digital8 format tape, and then automatically record selected scenes to a DVD.

To use this function, do the following:

Connect your digital video camera and prepare for recording



Select and edit the scenes you want to dub

Using the recorder’s remote control, fast forward or rewind the tape to select the scenes. At this point, the selected scenes are not copied to the disc. The recorder only remembers the IN and OUT points of the scenes that you selected for dubbing. You can also erase or change the order of the scenes.



Dub the selected scenes

After you have selected the scenes, the recorder will fast forward and rewind the tape automatically and record the scenes to a DVD.

◆ How chapters are created

The contents dubbed to DVD become a single title. When “Auto Chapter” is set to “On” in the “Recording” setup, this title is divided into chapters. When dubbing to a DVD-RW/DVD-R (VR mode), each shooting session on the tape and each selected scene becomes a chapter on the disc. For other discs, the recorder divides the title into chapters at approximately 6 minute intervals.

1 Follow steps 1 to 6 of “Preparing for DV/Digital8 dubbing” on page 66, and press SYSTEM MENU.

2 Select "DV / D8 EDIT," and press ENTER.

The display asks if you want to start selecting scenes.

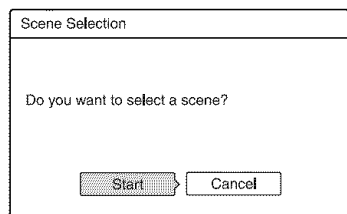

- If you have previously saved a program, the display asks if you want to edit an existing program or to create a new program. To resume editing the existing program, select "Saved Data," and go to step 9.

3 Select "Start," and press ENTER.

The display for setting the IN point (start of the scene) appears. The scene starts to play.

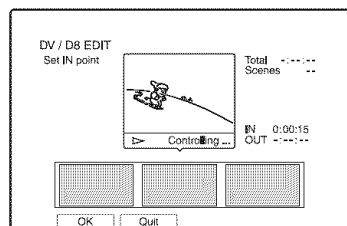

4 Select the IN point using ◀◀/▶▶, and press ENTER.

Playback pauses.

5 Press ENTER if the IN point is correct.

If the IN point is incorrect, select the IN point using ◀◀/▶▶, and press ENTER. The display for setting the OUT point (end of the scene) appears.

6 Select the OUT point using ◀◀/▶▶, and press ENTER.

Playback pauses.

7 Press ENTER if the OUT point is correct.

If the OUT point is incorrect, select the OUT point using ◀◀/▶▶, and press ENTER.

The selected scene is added to the scene information block.

- To add more scenes, go to step 4.

8 When you finish adding scenes, press ↓.

The scene list is displayed.

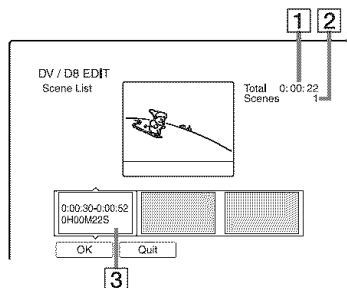

1 Total duration of the program

2 Total number of scenes

3 Scene information block

9 Select the scene information block you want to edit using ◀/▶, and press ENTER.

The sub-menu appears.

"Move": Changes the scene order using ◀/▶ and ENTER.

"Erase": Erases the scene. When asked for confirmation, select "OK."

"Preview": Plays the selected scene.

- To add more scenes, press ↑ and go to step 4.

10 When you finish editing the scene list, select "OK," and press ENTER.

The display for entering the title name appears. To enter a new name, select "Enter," and follow the explanations on page 33.

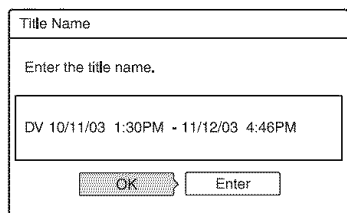

11 Select "OK," and press ENTER.

The title name is fixed, and the display asks if you want to start recording.

To change the dubbing mode, select "Dub Mode" and press \uparrow/\downarrow .

Data capacity required for the dubbing.
This is displayed in red when the size exceeds the available space on the dubbing target media.

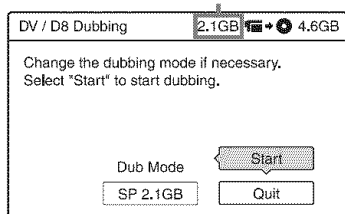

12 Select "Start," and press ENTER.

The recorder starts recording the tape contents as programmed.

To stop during recording

Press \blacksquare REC STOP.

Note that it may take a few seconds for the recorder to stop recording.

To automatically adjust the dubbing mode

If there is not enough available space on the target disc, the recorder automatically selects a dubbing mode with lower picture quality according to the available space. The same dubbing mode is set for all of the titles. If disc space is insufficient for the selected dubbing mode, the following display appears after step 12.

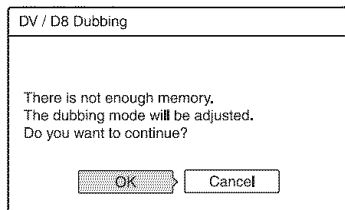

Select "OK" and go to step 12.

If you do not want to change the dubbing mode, select "Cancel." However, note that dubbing will end before the program is finished.

Notes

- If you set the beginning of the tape as the IN point and the end point as the OUT point, the IN and OUT points may move slightly during dubbing.
- You cannot set a scene to be shorter than one second.

Antenna Reception and Language Settings (Basic)

The “Basic” setup helps you to make tuner, clock, and channel settings for the recorder.

- 1 Press **SYSTEM MENU** while the recorder is in stop mode.
 - 2 Select “**SETUP**,” and press **ENTER**.
 - 3 Select “**Basic**,” and press **ENTER**.
The options for “Basic” appear. The default settings are underlined.
- To turn off the display, press **SYSTEM MENU** repeatedly.

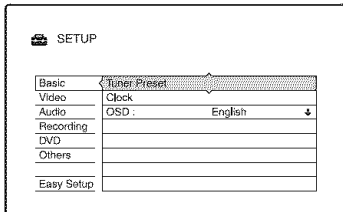

Tuner Preset

Note
You cannot preset channels for the connected cable box or satellite receiver.

Auto Preset

Automatically presets the receivable channels. The recorder can receive VHF channels 2 to 13, UHF channels 14 to 69, and unscrambled CATV channels 1 to 125. First, we recommend that you preset the receivable channels in your area using automatic presetting methods.

- 1 Select “**Tuner Preset**” in “**Basic**,” and press **ENTER**.

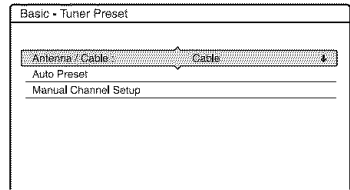

- 2 Select “**Antenna / Cable**,” and press **ENTER**.

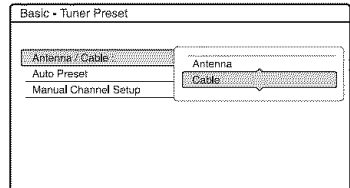

Antenna	Presets VHF and UHF channels.
<u>Cable</u>	Presets cable TV channels.

- 3 Select an option, and press **ENTER**.
- 4 Select “**Auto Preset**,” and press **ENTER**.
All receivable channels are preset in numerical sequence.

Manual Channel Setup

Presets or disables channels manually. If some channels could not be set using the “Auto Preset” or “Easy Setup” function, you can set them manually.

- 1 Select “**Tuner Preset**” in “**Basic**,” and press **ENTER**.

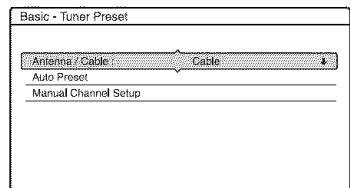

- 2 Select "Antenna / Cable," and press ENTER.

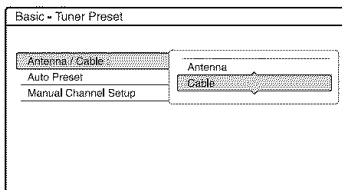

Antenna	Presets VHF and UHF channels.
Cable	Presets cable TV channels.

- 3 Select an option, and press ENTER.
4 Select "Manual Channel Setup," and press ENTER.

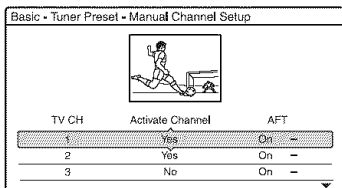

- 5 Press \uparrow/\downarrow to select the channel you want to activate, and press ENTER.

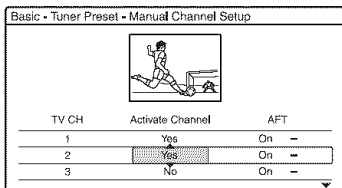

- 6 Press \leftarrow/\rightarrow to select "Activate Channel," and press ENTER. The disabled channel will be skipped when you press CH +/-.

Yes	Activates the channels.
No	Disables the channels.

- 7 Press \uparrow/\downarrow to select "Yes" to activate the channel.

- 8 Press \rightarrow to select "AFT."

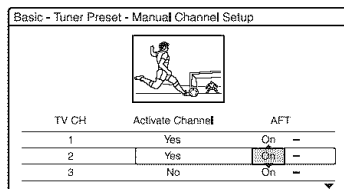

On	Turns on the Auto Fine Tuning function. Normally, select this.
Off	Allows you to adjust the picture manually.

- 9 Select "On" to turn on AFT, and press ENTER.
• If the Auto Fine Tuning function does not work effectively, select "Off" in step 8 and press \rightarrow . Press \uparrow/\downarrow to obtain a clearer picture, and press ENTER.

- 10 To preset or disable another channel, repeat from step 5.

Clock

Auto (Auto Clock Set)

Turns on the Auto Clock Set function when a channel in your local area broadcasts a time signal.

- 1 Select "Clock" in "Basic," and press ENTER.
- 2 Select "Auto," and press ENTER.

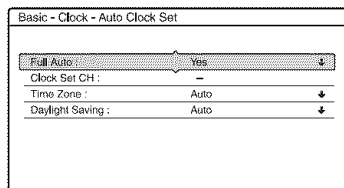

- 3 Select "Full Auto," and press ENTER.

Yes	Automatically sets your time zone and Daylight Saving Time (if applicable).
No	Allows you to adjust your time zone and Daylight Saving Time manually, without turning off the Auto Clock Set function.

- 4 Select "Yes," and press ENTER. The recorder automatically sets the clock by searching for a channel that carries a time signal and sets your time zone and Daylight Saving Time (if applicable).
- If the clock does not activate, your clock setting is incorrect. After repeating steps 1 to 3 above, select "No" in step 4 and press ENTER. Then select "Clock Set CH," "Time Zone," or "Daylight Saving" and press ENTER. Adjust these settings by pressing \uparrow/\downarrow and ENTER.

◆ Clock Set CH

Select a channel that carries a time signal using the number buttons. Use this option if you know of a channel that carries a time signal. Most PBS member stations broadcast a time signal. For the fastest response select your local PBS station. Leave the setting at "--" to have the recorder automatically search for a channel that carries a time signal. To return to "--," enter "0."

Basic - Clock - Auto Clock Set	
Full Auto :	No \downarrow
Clock Set CH :	-- \downarrow
Time Zone :	Auto \downarrow
Daylight Saving :	Auto \downarrow

◆ Time Zone

Select the time zone for your area, or select "Auto" to have the recorder automatically set your time zone. The options are:

Auto \leftrightarrow Atlantic \leftrightarrow Eastern \leftrightarrow
 Central \leftrightarrow Mountain \leftrightarrow Pacific \leftrightarrow
 Alaska \leftrightarrow Hawaii \leftrightarrow Auto

◆ Daylight Saving

Select "On" or "Off" (standard time), or select "Auto" to have the recorder automatically set the daylight saving time.

💡 Hint

If you set "Full Auto" to "Yes," the Auto Clock Set function is activated whenever the recorder is turned off.

Manual (Manual Clock Set)

If the Auto Clock Set function did not set the clock correctly for your local area, set the clock manually.

- 1 Select "Clock" in "Basic," and press ENTER.
- 2 Select "Manual," and press ENTER.

Basic - Clock - Present Time	
Set the time and date manually.	
Sun	1 / 2006 12:00AM

- 3 Press \uparrow/\downarrow to set the month, and press \rightarrow . Set the day, year, hour, and minutes in sequence. Press \leftarrow/\rightarrow to select the item to be set, then press \uparrow/\downarrow to set the numbers. The day of the week is set automatically.
- 4 Press ENTER to start the clock.

💡 Hint

To change the numbers in step 3, press \leftarrow to return to the item to be changed, and select the numbers by pressing \uparrow/\downarrow .

OSD (On-Screen Display)

Switches the display language on the screen.

Video Settings (Video)

Video settings will adjust items related to the image, such as size and color.

Choose the settings according to the type of TV, tuner, or decoder connected to the DVD recorder.

- 1** Press **SYSTEM MENU** while the recorder is in stop mode.
- 2** Select **"SETUP,"** and press **ENTER.**
- 3** Select **"Video,"** and press **ENTER.**

The "Video" setup appears with the following options. The default settings are underlined.

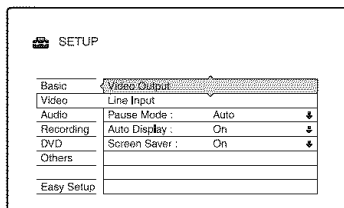

Video Output

◆ TV Type

Sets the picture size when playing back a title recorded from 16:9 size video (page 42) or a 16:9 size commercial DVD video.

Select the playback picture size according to the type of connected TV (wide-screen/wide mode TV or conventional 4:3 screen TV).

16:9	Select this when connecting to a wide-screen TV or TV with a wide mode function.
<u>4:3 Letter Box</u>	Select this when connecting to a 4:3 screen TV. Displays a wide picture with bands on the upper and lower portions of the screen.
4:3 Pan Scan	Select this when connecting to a 4:3 screen TV. Automatically displays a wide picture on the entire screen and cuts off the portions that do not fit.

16:9

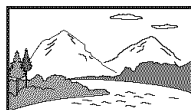

4:3 Letter Box



4:3 Pan Scan

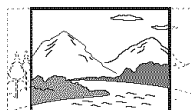

⚡ Note

Depending on the disc, "4:3 Letter Box" may be selected automatically instead of "4:3 Pan Scan" or vice versa.

◆ Y/Ph/Pr Out Black Level

Selects the black level (setup level) for the video signals output from the COMPONENT VIDEO OUT jacks (page 16).

This setting is not effective when the recorder outputs progressive signals.

On	Raises the standard black level. Select this when the picture appears too dark.
<u>Off</u>	Sets the black level of the output signal to the standard level. Normally, select this.

◆ Progressive Output

If your TV accepts progressive (480p) format signals, set "Progressive Output" to "On." You will enjoy accurate color reproduction and high quality images.

- 1** Select "Progressive Output," and press **ENTER.**
- 2** Select "On," and press **ENTER.** The display asks for confirmation.
- 3** Select "Start," and press **ENTER.** The video switches to a progressive signal for 5 seconds.
- 4** If video signal appears OK, select "Yes," and press **ENTER.** If picture is distorted, select "No," and press **ENTER.**

◆ Progressive Mode

DVD software can be divided into two types: film based software and video based software. Video based software is derived from TV and displays images at 30 frames/60 fields per second. Film based software is derived from film and displays images at 24 frames per second. Some DVD software contains both Video and Film.

In order for these images to appear natural on your screen when output in progressive mode, the progressive video signal needs to be converted to match the type of DVD software that you are watching.

You can fine-tune the progressive 480p video signal that is output when you set “Progressive Output” to “On.”

Note that you must connect to a progressive format TV using the COMPONENT VIDEO OUT jacks (page 16).

<u>Auto</u>	Automatically detects the software type (Film-based or Video-based) and selects the appropriate conversion mode. Normally select this position.
Video	Fixes the conversion mode to the mode for Video-based software.

⚡ Note

When picture noise appears after you set the recorder to progressive format, hold down ■ STOP, and press CHANNEL – (minus) on the unit.

Line Input

Sets the method of inputting video signals from the LINE IN jacks on the rear panel of the recorder. Select an option for each of the items below according to the combination of jacks and methods that you are going to use.

◆ Line1 Input

Selects a method of inputting video signals for the LINE 1 IN jack on the rear panel of the recorder.

<u>Video</u>	Inputs video signals.
S Video	Inputs S video signals.

Pause Mode (DVDs only)

Selects the picture quality in pause mode.

<u>Auto</u>	The picture, including subjects that move dynamically, is output with no jitter. Normally select this position.
Frame	The picture, including subjects that do not move dynamically, is output in high resolution.

Auto Display

<u>On</u>	Automatically displays information on the screen when the recorder is turned on, etc.
Off	Displays information only when DISPLAY is pressed.

Screen Saver

The screen saver image appears when you do not use the recorder for more than 10 minutes while an on-screen display, such as the System Menu, is displayed on your TV screen. The screen saver image helps prevent your display device from becoming damaged (ghosting).

<u>On</u>	Turns on the screen saver function.
Off	Turns off the function.

Audio Settings (Audio)

The “Audio” setup allows you to adjust the sound according to the playback and connection conditions.

- 1** Press **SYSTEM MENU** while the recorder is in stop mode.
- 2** Select **“SETUP,”** and press **ENTER.**
- 3** Select **“Audio,”** and press **ENTER.**

The “Audio” setup appears with the following options. The default settings are underlined.

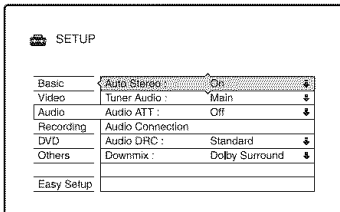

Auto Stereo

This function is effective only when “Tuner Audio” is set to “Main.”

<u>On</u>	Receives stereo programs. Normally select this.
Off	Select this to reduce noise. The sound changes to monaural.

Tuner Audio

Selects the sound to be recorded.

<u>Main</u>	Records only the main sound.
SAP	Records only the SAP (Second Audio Program) sound.

Note

If no SAP sound is received, the main sound is recorded regardless of the setting.

Audio ATT (attenuation)

If the playback sound is distorted, set this item to “On.” The recorder reduces the audio output level.

This function affects the output of the following jacks:

– LINE OUT R-AUDIO-L jacks

On	Select this when the playback sound from the speakers is distorted.
<u>Off</u>	Normally select this position.

Audio Connection

The following setup items switch the method of outputting audio signals when you connect a component such as an amplifier (receiver) with a digital input jack.

For connection details, see “Step 3:

Connecting the Audio Cords” on page 18. Select “Dolby Digital,” “DTS,” and “48kHz/96kHz PCM” after setting “Digital Out” to “On.”

If you connect a component that does not accept the selected audio signal, a loud noise (or no sound) will come out from the speakers, and may affect your ears or cause speaker damage.

- 1** Select “Audio Connection” in “Audio,” and press **ENTER.**

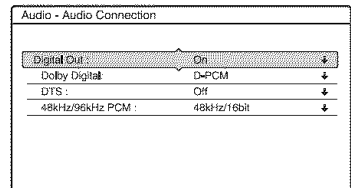

- 2** Select “Digital Out,” and press **ENTER.**

<u>On</u>	Normally select this position.
Off	The influence of the digital circuit upon the analog circuit is minimal.

- 3** Select “On,” and press **ENTER.**

4 Set the digital output signal.

- Dolby Digital (DVDs only)

Selects the type of Dolby Digital signal.

<u>D-PCM</u>	Select this when the recorder is connected to an audio component lacking a built-in Dolby Digital decoder. The surround effects of output signals are determined by the “Downmix” setting item in the “Audio” setup.
Dolby Digital	Select this when the recorder is connected to an audio component with a built-in Dolby Digital decoder.

- DTS (DVD VIDEOS only)

Selects whether or not to output DTS signals.

On	Select this when the recorder is connected to an audio component with a built-in DTS decoder.
<u>Off</u>	Select this when the recorder is connected to an audio component without a built-in DTS decoder.

- 48kHz/96kHz PCM (DVD VIDEOS only)

Selects the sampling frequency of the audio signal.

<u>48kHz/16bit</u>	The audio signals of DVD VIDEOS are converted to 48 kHz/16 bit and output.
96kHz/24bit	All signals containing 96 kHz/24 bit are output without conversion. However, the signals are output at 48 kHz/16 bit if copyright-protected signals are contained.

Note

“48kHz/96kHz PCM” setting has no effect when audio signals are output from the LINE OUT (R-AUDIO-L) jacks. If the sampling frequency is 96kHz, signals are simply converted to analog signals and output.

Audio DRC (Dynamic Range Control) (DVDs only)

Selects the dynamic range (difference between soft and loud sounds) setting when playing a DVD that conforms to Audio DRC. This affects the output from the following jacks:

- LINE OUT R-AUDIO-L jacks
- DIGITAL OUT (COAXIAL) jack only when “Dolby Digital” is set to “D-PCM” (page 76).

<u>Standard</u>	Normally select this position.
TV Mode	Makes low sounds clear even if you turn the volume down.
Wide Range	Gives you the feeling of being at a live performance.

Downmix (DVDs only)

Switches the method for mixing down to two channels when you play a DVD which has rear sound elements (channels) or is recorded in Dolby Digital format. For details on the rear signal components, see “4. Displaying the Playing/Remaining Time and Play Information” on page 30. This function affects the output of the following jacks:

- LINE OUT R-AUDIO-L jacks
- DIGITAL OUT (COAXIAL) jack when “Dolby Digital” is set to “D-PCM” (page 76).

<u>Dolby Surround</u>	Normally select this position. Multi-channel audio signals are output to two channels for enjoying surround sounds.
Normal	Multi-channel audio signals are downmixed to two channels for use with your stereo.

Recording Settings (Recording)

The “Recording” setup allows you to adjust recording settings.

- 1 Press **SYSTEM MENU** while the recorder is in stop mode.
- 2 Select “**SETUP**,” and press **ENTER**.
- 3 Select “**Recording**,” and press **ENTER**.

The “Recording” setup appears with the following options. The default settings are underlined.

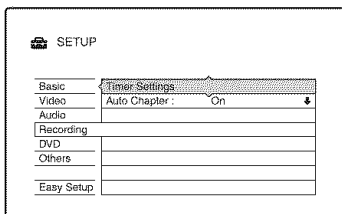

⚡ Notes

- The actual chapter mark interval may vary depending on the amount of information contained in the video to be recorded.
- Chapter marks are automatically inserted where the recordings start on the tape when “Auto Chapter” is set to “On” during DV/Digital8 dubbing to a DVD-RW/DVD-R (VR mode).

Timer Settings

◆ Rec Mode Adjust

<u>On</u>	Automatically adjusts the recording mode to enable the entire program to be recorded (page 41).
<u>Off</u>	Turns off the function.

Auto Chapter

Selects whether to automatically divide a recording (a title) into chapters during recording or dubbing.

<u>On</u>	Inserts chapter marks at approximately 6 minute intervals.
<u>Off</u>	No chapter mark is inserted.

Disc Settings (DVD)

The “DVD” setup allows you to adjust parental control, language and other DVD related settings.

- 1 Press **SYSTEM MENU** while the recorder is in stop mode.
- 2 Select “**SETUP**,” and press **ENTER**.
- 3 Select “**DVD**,” and press **ENTER**.

The “DVD” setup appears with the following options. The default settings are underlined.

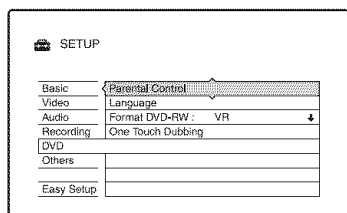

Parental Control (DVD VIDEO only)

Playback of some DVD VIDEOS can be limited according to a predetermined level, such as the age of the users. Scenes may be blocked or replaced with different scenes.

- 1 Select “Parental Control” in “DVD,” and press **ENTER**.
 - If you have not entered a password, the display for registering a new password appears.

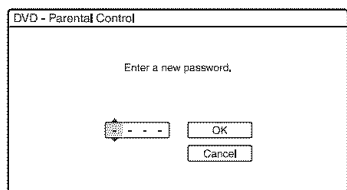

- When you have already registered a password, the display for entering the password appears.

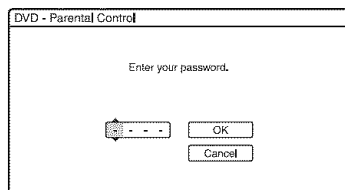

- 2 Enter your four-digit password using the number buttons, then select “OK” and press **ENTER**.

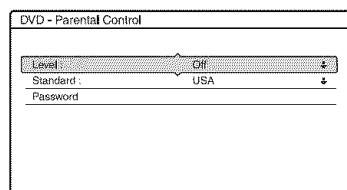

- 3 Select “Standard,” and press **ENTER**. The selection items for “Standard” are displayed.

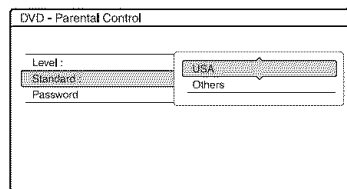

- 4 Select a geographic area as the playback limitation level, and press **ENTER**. The area is selected.
 - When you select “Others,” press the number buttons to select and enter an area code in the table (page 95). Then select “OK” and press **ENTER**.

- 5 Select “Level,” and press ENTER. The selection items for “Level” are displayed.

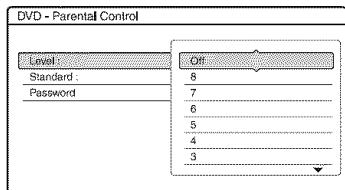

The lower the value, the stricter the limitation.

Discs rated higher than the selected level will be restricted.

- 6 Select the level, and press ENTER. The Parental Control setting is complete.

To cancel the Parental Control setting for the disc, set “Level” to “Off” in step 6.

To change the password, select “Password” in step 3, and press ENTER.

When the display for registering a password appears, enter a new four-digit password using the number buttons, then select “OK” and press ENTER.

Notes

- If you forget your password, you will have to reset it by selecting “Parental Control” of “Factory Setup” in the “Others” setup (page 81).
- When you play discs which do not have the Parental Control function, playback cannot be limited on this recorder.
- Depending on the disc, you may be asked to change the Parental Control level while playing the disc. In this case, enter your password, then change the level.

Language (DVD VIDEO only)

◆ DVD Menu

Switches the language for the DVD menu.

◆ Audio

Switches the language of the sound track. When you select “Original,” the language given priority in the disc is selected.

◆ Subtitle

Switches the language of the subtitles recorded on the disc.

When you select “Audio Follow,” the subtitle language changes according to the language you selected for the sound track.

💡 Hint

If you select “Others” in “DVD Menu,” “Subtitle,” or “Audio,” select and enter a language code from “Language Code List” on page 95 using the number buttons.

🚫 Note

If you select a language in “DVD Menu,” “Subtitle,” or “Audio” that is not recorded on the DVD VIDEO, one of the recorded languages will be automatically selected.

Format DVD-RW (DVD-RW only)

The recorder automatically starts formatting in VR mode or Video mode, whichever is selected below, when a new, unformatted DVD-RW is inserted.

VR	Automatically formats the disc in VR mode.
Video	Automatically formats the disc in Video mode.

One Touch Dubbing

Displays the following options for the One Touch Dub function.

◆ Finalize Disc (for all recordable discs except DVD-RW in VR mode)

Selects whether or not to finalize the disc automatically following One Touch Dubbing (page 68).

Auto	Automatically finalizes the disc following One Touch Dubbing.
Manual	Allows you to finalize the disc manually.

Remote Control Settings/ Factory Settings (Others)

The “Others” setup allows you to set up other operational settings.

- 1 Press **SYSTEM MENU** while the recorder is in stop mode.
- 2 Select “**SETUP,**” and press **ENTER**.
- 3 Select “**Others,**” and press **ENTER**.

The “Others” setup appears with the following options. The default settings are underlined.

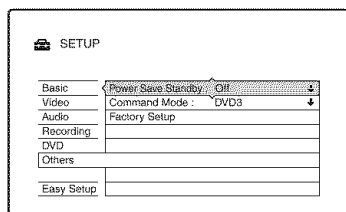

Power Save Standby

Selects whether this recorder is in power save mode and adjusts the lighting of the front panel display.

On	Sets to power save mode to make the lighting dark. Turn off the lighting when the power is off.
<u>Off</u>	Does not set to power save mode and make the lighting bright.

Command Mode

Changes the Command Mode of the recorder if other DVD equipment is assigned the same Command Mode. For details, see “If you have a Sony DVD player or more than one Sony DVD recorder” on page 21.

Factory Setup

Allows you to select the setup settings by group, and return them to their default settings. Note that all of your previous settings will be lost.

- 1 Select “**Factory Setup**” in “**Others,**” and press **➡** or **ENTER**.
The display for selecting a group of settings appears.
- 2 Select the group of settings you want to return to default from “**Basic,**” “**Video,**” “**Audio,**” “**Recording,**” “**DVD,**” “**Others,**” “**Parental Control,**” and “**All,**” and press **➡** or **ENTER**.
- 3 Select “**Start,**” and press **ENTER**.
The selected settings return to their default settings.
- 4 Press **ENTER** when “**Finish**” appears.

Easy Setup (Resetting the Recorder)

Select this to run the “Easy Setup” program.

- 1** Press **SYSTEM MENU** while the recorder is in stop mode.
- 2** Select “**SETUP**,” and press **ENTER**.
- 3** Select “**Easy Setup**,” and press **ENTER**.

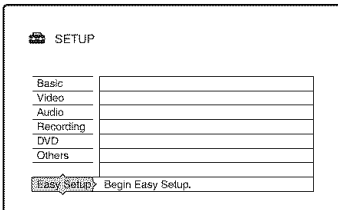

- 4** Select “**Start**.”
- 5** Follow the instructions for “**Easy Setup**” (page 23) from step 2.

Additional Information

Troubleshooting

If you experience any of the following difficulties while using the recorder, use this troubleshooting guide to help remedy the problem before requesting repairs. Should any problem persist, consult your nearest Sony dealer.

Power

The power does not turn on.

- ➔ Check that the AC power cord is connected securely.

Picture

There is no picture.

- ➔ Re-connect all connecting cords securely.
- ➔ The connecting cords are damaged.
- ➔ Check the connection to your TV (page 12).
- ➔ Switch the input selector on your TV (such as to "VCR") so that the signal from the recorder appears on the TV screen.
- ➔ When playing a double-layer DVD, the video and audio may be momentarily interrupted at the point where the layers switch.

Picture noise appears.

- ➔ If the picture output signal from your recorder passes through your VCR to get to your TV, or if you are connected to a combination TV/VIDEO player, the copy-protection signal applied to some DVD programs could affect picture quality. If you still experience this problem even when you connect your recorder directly to your TV, try connecting your recorder to your TV's S VIDEO input.
- ➔ You have set the recorder to progressive format even though your TV cannot accept the progressive signal. In this case, hold down ■ STOP, and press CHANNEL – (minus) on the unit.

- ➔ Even if your TV is compatible with progressive format (480p) signals, the image may be affected when you set the recorder to progressive format. In this case, hold down ■ STOP, and press CHANNEL – (minus) on the unit and the recorder is set to normal (interlace) format.
- ➔ When playing a double-layer DVD, the video and audio may be momentarily interrupted at the point where the layers switch.

There is no picture or the picture noise appears when connected to the DV IN jack.

- ➔ Try the following:
 - ① Turn the recorder off and on again.
 - ② Turn the connected equipment off and on again.
 - ③ Disconnect and then connect the i.LINK cable again.

TV program reception does not fill the screen.

- ➔ Set the channel manually in "Tuner Preset" in the "Basic" setup (page 71).
- ➔ Select the correct source using the INPUT SELECT button, or select a channel of any TV program using the CH +/- buttons.

TV program pictures are distorted.

- ➔ Reorient the TV antenna.
- ➔ Adjust the picture (see the TV's instruction manual).
- ➔ Place the recorder and TV farther apart.
- ➔ Place the TV and any bunched antenna cables farther apart.
- ➔ The antenna cable is connected to the VHF/UHF OUT jack on the recorder. Connect the cable to the VHF/UHF IN jack.

TV channels cannot be changed.

- ➔ The channel is disabled (page 71).
- ➔ A timer recording started, which changed the channels.

The picture from equipment connected to the recorder's input jack does not appear on the screen.

➔ If the equipment is connected to the LINE 1 IN jack, select "L1" in the front panel display by pressing CH +/- or INPUT SELECT.

If the equipment is connected to the LINE 2 IN jacks, select "L2" in the front panel display by pressing CH +/- or INPUT SELECT.

If the equipment is connected to the DV IN jack, (this is usually for a digital video camera connection), select "DV" in the front panel display by pressing INPUT SELECT.

➔ When an S video cable is connected to the recorder's LINE 1 IN jack, set "Line 1 Input" of the "Line Input" to "S Video" in the "Video" setup (page 75).

The playback picture or TV program from the equipment connected through the recorder is distorted.

➔ If the playback picture output from a DVD player, VCR, or tuner goes through your recorder before reaching your TV, the copy-protection signal applied to some programs could affect picture quality. Disconnect the playback equipment in question and connect it directly to your TV.

The picture does not fill the screen.

➔ Set "TV Type" of the "Video Output" in the "Video" setup in accordance with the screen size of your TV (page 74).

The picture does not fill the screen, even though the picture size is set in "TV Type" of the "Video Output" in the "Video" setup.

➔ The picture size of the title is fixed.

Sound**There is no sound.**

- ➔ Re-connect all connections securely.
- ➔ The connecting cord is damaged.
- ➔ The input source setting on the amplifier or the connection to the amplifier is incorrect.

- ➔ The recorder is in reverse play, fast-forward, slow motion, or pause mode.
- ➔ If the audio signal does not come through the DIGITAL OUT (COAXIAL) jack, check the "Audio Connection" settings in the "Audio" setup (page 76).

Sound distortion occurs.

➔ Set "Audio ATT" in the "Audio" setup to "On" (page 76).

Sound is noisy.

➔ When playing a CD with DTS sound tracks, noise will come from the LINE OUT R-AUDIO-L jacks (page 52).

The sound volume is low.

- ➔ The sound volume is low on some DVDs. The sound volume may improve if you set "Audio DRC" in the "Audio" setup to "TV Mode" (page 77).
- ➔ Set "Audio ATT" in the "Audio" setup to "Off" (page 76).

An alternate audio track cannot be recorded or played.

- ➔ Second Audio Program (SAP) is not available for all programs. The program you are recording does not have a second audio program.
- ➔ You have set "Tuner Audio" in the "Audio" setup to "Main" (page 76). Select "SAP" to record alternate audio programs.
- ➔ If you have connected an AV amplifier to the DIGITAL OUT (COAXIAL) jack and want to change the audio track for DVD-RWs/DVD-Rs (VR mode) during playback, set "Dolby Digital" of the "Audio Connection" in the "Audio" setup to "D-PCM" (page 76).

Playback**The recorder does not play any type of disc.**

- ➔ The disc is upside down. Insert the disc with the labeled side facing up.
- ➔ The disc is not correctly inserted.
- ➔ Moisture has condensed inside the recorder. In this case, if the recorder is on, leave it on (if it is off, leave it off) for about an hour until the moisture evaporates.

- ➔ If the disc was recorded on another recorder and was not finalized (page 35), the recorder cannot play the disc.

The recorder does not start playback from the beginning.

- ➔ Resume play was activated (page 50).
- ➔ You have inserted a DVD whose Title menu or DVD menu automatically appears on the TV screen when it is first inserted. Use the menu to start playback.

The recorder starts playing automatically.

- ➔ The DVD VIDEO features an auto playback function.

Playback stops automatically.

- ➔ If the DVD has an auto pause signal, the recorder stops playback at the auto pause signal.

Some functions such as Stop, Search, or Slow-motion Play cannot be performed.

- ➔ Depending on the DVD, you may not be able to do some of the operations above. See the instruction manual supplied with the disc.

The language for the sound track cannot be changed.

- ➔ Multilingual tracks are not recorded on the DVD being played.
- ➔ The DVD VIDEO prohibits the changing of the language for the sound track.
- ➔ Try changing the language using the DVD VIDEO's menu.

The subtitle language cannot be changed or turned off.

- ➔ Multilingual subtitles are not recorded on the DVD VIDEO.
- ➔ The DVD VIDEO prohibits changing of the subtitles.
- ➔ Try changing the subtitle using the DVD VIDEO's menu.
- ➔ The subtitles cannot be changed for the titles recorded on this recorder.

The angles cannot be changed.

- ➔ Multi-angles are not recorded on the DVD VIDEO being played.

- ➔ You are trying to change the angles when "⏏" does not appear on the TV screen (page 49).

- ➔ The DVD VIDEO prohibits changing angles.
- ➔ Try changing the angle using the DVD VIDEO's menu.
- ➔ The angles cannot be changed for the titles recorded on this recorder.
- ➔ The angles cannot be changed during slow motion playback or when playback is paused.

The MP3 audio tracks do not play.

- ➔ The MP3 audio tracks are not recorded in a format that the recorder can play (page 55).

The JPEG image files do not play.

- ➔ The JPEG image files are not recorded in a format that the recorder can play (page 55).
- ➔ Progressive JPEG images cannot be played.

Recording/Timer recording/ Editing

The channel cannot be changed from the channel you are recording.

- ➔ Set the TV's input source to "TV."

Recording does not start immediately after you press ● REC.

- ➔ Operate the recorder only after "LOAD," "FORMAT," or "INFOWRITE" disappears from the front panel display.

Nothing was recorded even though you set the timer setting correctly.

- ➔ There was a power failure during recording.
- ➔ The recorder's internal clock stopped due to a power failure that lasted for more than 1 hour. Reset the clock (page 72).
- ➔ The channel was disabled after the timer recording was set. See "Tuner Preset" on page 71.
- ➔ Disconnect the AC power cord from the AC outlet, and connect it again.
- ➔ The program contains copy protection signals that restrict copying.
- ➔ The timer setting overlapped another setting that was set later.
- ➔ There is no DVD inside the recorder.

- ➔ There is not enough disc space for the recording.
- ➔ A separate recording was in the process of being made without the use of the timer (page 47).
- ➔ The recorder was in the process of DV/Digital8 Dubbing.

Recording does not stop immediately after you press ■ REC STOP.

- ➔ It will take a few seconds for the recorder to input disc data before recording can stop.

Recording does not stop after you press ■ STOP.

- ➔ Press ■ REC STOP.

Timer recording is not complete or did not start from the beginning.

- ➔ There was a power failure during recording. If the power recovers when there is a timer recording, the recorder resumes recording. Should the power failure continue for more than 1 hour, reset the clock (page 72).
- ➔ Disc space was not enough.

Contents previously recorded were erased.

- ➔ Data that is not playable on this recorder but was recorded on a DVD with a PC will be erased from the disc when the disc is inserted.

Recording from the equipment with a timer

Nothing was recorded even though you set the Synchro-Rec setting correctly.

- ➔ You forgot to turn off the connected equipment. Turn off the connected equipment and set the recorder to Synchro-Rec standby mode (page 47).
- ➔ The recorder was not set to the Synchro-Recording standby mode. Press
➔ ● SYNCHRO REC to have the recorder stand by for recording. Make sure the SYNCHRO REC indicator lights up on the front panel (page 47).
- ➔ The equipment is not connected to the LINE 1 IN jacks of the recorder.

- ➔ The recorder is connected to the TV output jack of the connected equipment.

Synchro-Recording does not complete.

- ➔ The timer setting for the connected equipment overlapped the recorder's timer setting (page 48).
- ➔ There was a power failure during the recording.

The recorder automatically starts recording when the satellite receiver is turned on.

- ➔ The Synchro-Rec function was activated. Turn off the satellite receiver and cancel the Synchro-Rec function (page 47).

Display

The clock has stopped.

- ➔ Set the clock again (page 72).
- ➔ The clock stopped due to a power failure that lasted for more than 1 hour. Reset the clock (page 72).

The TIMER REC indicator is flashing.

- ➔ The disc does not have enough space.
- ➔ Insert a recordable disc inside the recorder.
- ➔ The inserted DVD is protected (page 35).

The recording mode indication is incorrect.

- ➔ When the recording or dubbing is less than ten minutes, or if a picture with little movement is displayed for more than ten minutes, the recording mode indication may be displayed incorrectly. Note that the actual recording or dubbing itself was correctly made in the selected recording mode.
- ➔ After playing titles recorded in EP and SLP mode, the recording mode indication may change depending on the recorded program.

The clock does not appear in the front panel display when the recorder is turned off.

- ➔ "Power Save Standby" in the "Others" setup is set to "On" (page 81), and the recorder is in standby mode.

Remote control

The remote does not function.

- ➔ Batteries are weak.
- ➔ The remote is too far from the recorder.
- ➔ The remote's manufacturer code returned to the default setting when you replaced the batteries. Reset the code (page 20).
- ➔ The remote is not pointed at the remote sensor on the recorder.
- ➔ Different command modes are set for the recorder and remote. Set the same command mode (page 21). The default command mode setting for this recorder and the supplied remote is DVD3.
- ➔ Press ■ STOP on the unit while the recorder is turned off to check the current command mode.

Others

The recorder does not operate properly.

- ➔ Restart the recorder. Press down I/⏻ on the recorder for more than ten seconds until "WELCOME" appears in the front panel display.
- ➔ When static electricity, etc., causes the recorder to operate abnormally, turn off the recorder and wait until the clock appears in the front panel display. Then, unplug the recorder and after leaving it off for a while, plug it in again.

Five numbers or letters are displayed in the front panel display.

- ➔ The self-diagnosis function was activated (see the table on page 88).

The disc tray does not open after you press **△ OPEN/CLOSE**.

- ➔ It may take a few seconds for the disc tray to open after you have recorded or edited a DVD. This is because the recorder is adding disc data to the disc.

The disc tray does not open and "LOCKED" appears in the front panel display.

- ➔ The disc tray is locked. Cancel the Child Lock (page 50).

The disc tray does not open and "TRAY LOCKED" appears in the front panel display.

- ➔ Contact your Sony dealer or local authorized Sony service facility.

The disc tray does not open and you cannot remove the disc after you press **△ OPEN/CLOSE**.

- ➔ Turn off the recorder. Once the clock appears in the front panel display, disconnect the AC power cord. (If the recorder does not turn off or if the clock does not appear in the front panel display, disconnect the AC power cord anyway.) Connect the AC power cord again while pressing down △ on the recorder, and release the button when the disc tray opens. Then, keep I/⏻ on the recorder pressed for about ten seconds until "WELCOME" appears in the front panel display.

"RECOVERY" appears in the front panel display.

- ➔ The recorder's recovery function was activated when the recorder was turned on because the power was turned off or failed during recording. Leave the recorder on until "RECOVERY" disappears from the front panel display.

"FAN ERROR" appears in the front panel display.

- ➔ Check that the vent on the rear of the recorder is not blocked. Then, immediately disconnect the AC power cord. Leave the recorder off for a while, then re-connect the AC power cord, and press I/⏻ on the recorder.

Mechanical sound is heard when the recorder is off.

- ➔ While the recorder is adjusting the clock for the Auto Clock Set function or during a timer recording, operational noises (such as the internal fan) may be heard, even when the power is off. This is not a malfunction.

Self-diagnosis Function (When letters/numbers appear in the display)

When the self-diagnosis function is activated to prevent the recorder from malfunctioning, a five-character service number (e.g., C 13 00) with a combination of a letter and four numbers appears in the front panel display. In this case, check the following table.

First three characters of the service number	Cause and/or corrective action
C 13	The DVD is dirty. ➔ Clean the disc with a soft cloth.
C 31	The DVD/CD is not inserted correctly. ➔ Re-insert the disc correctly.
E XX (xx is a number)	To prevent a malfunction, the recorder has performed the self-diagnosis function. ➔ Contact your nearest Sony dealer or local authorized Sony service facility and give the five-character service number. Example: E 61 10

Notes About This Recorder

On operation

- If the recorder is brought directly from a cold to a warm location, or is placed in a very damp room, moisture may condense on the lenses inside the recorder. Should this occur, the recorder may not operate properly. In this case, if the recorder is on, leave it on (if it is off, leave it off) for about an hour until the moisture evaporates.
- When you move the recorder, take out any discs. If you don't, the disc may be damaged.

On adjusting volume

Do not turn up the volume while listening to a section with very low level inputs or no audio signals. If you do, the speakers may be damaged when a peak level section is played.

On cleaning

Clean the cabinet, panel, and controls with a soft cloth slightly moistened with a mild detergent solution. Do not use any type of abrasive pad, scouring powder or solvent such as alcohol or benzine.

On cleaning discs, disc/lens cleaners

Do not use a commercially available cleaning disc or disc/lens cleaner (wet or spray type). These may cause the recorder to malfunction.

Notes about the discs

- To keep the disc clean, handle the disc by its edge. Do not touch the surface. Dust, fingerprints, or scratches on the disc may cause it to malfunction.



- Do not expose the disc to direct sunlight or heat sources such as hot air ducts, or leave it in a car parked in direct sunlight as the temperature may rise considerably inside the car.
- After playing, store the disc in its case.
- Clean the disc with a cleaning cloth. Wipe the disc from the center out.



- Do not use solvents such as benzene, thinner, commercially available cleaners, or anti-static spray intended for vinyl LPs.
- Do not use the following discs.
 - A disc that has a non-standard shape (e.g., card, heart).
 - A disc with a label or sticker on it.
 - A disc that has cellophane tape or sticker adhesive on it.

Specifications

System

Laser: Semiconductor laser

Channel coverage:

NTSC

VHF: 2 to 13

UHF: 14 to 69

CATV: A-8 to A-1, A to W, W+1 to W+84

Video reception: Frequency synthesizer system

Audio reception: Inter carrier system

Antenna: 75-ohm antenna terminal for VHF/UHF

Timer: Clock: Quartz locked/Timer indication: 12-hour cycle (digital)/Power back-up duration: 1 hour

Video recording format: MPEG-2, MPEG-1

Audio recording format/applicable

bit rate: Dolby Digital 2 ch
256 kbps/128 kbps (in EP and SLP mode)

Inputs and outputs

LINE OUT

(AUDIO): Phono jack/2 Vrms/10 kilohms

(VIDEO): Phono jack/1.0 Vp-p

(S VIDEO): 4-pin mini DIN/Y: 1.0 Vp-p,
C: 0.286 Vp-p

LINE 1 IN/LINE 2 IN

(AUDIO): Phono jack/2 Vrms/more than
22 kilohms

(VIDEO): Phono jack/1.0 Vp-p

(S VIDEO): 4-pin mini DIN/Y: 1.0 Vp-p,
C: 0.286 Vp-p

DV IN: 4-pin/i.LINK S100

DIGITAL OUT (COAXIAL): Phono jack/
0.5 Vp-p/75 ohms

COMPONENT VIDEO OUT (Y, P_B, P_R):

Phono jack/Y: 1.0 Vp-p/
P_B, P_R: 0.7 Vp-p

General

Power requirements: 120 V AC, 60 Hz

Power consumption: 22 W

Dimensions (approx.):

430 × 58 × 291 mm

(17 × 2 $\frac{3}{8}$ × 11 $\frac{1}{2}$ in.) (width/height/

depth) incl. projecting parts

Mass (approx.): 3.1 kg (6.83 lb)

Operating temperature:

5°C to 35°C (41°F to 95°F)

Operating humidity: 25% to 80%

Supplied accessories:

Audio/video cord (1)

Power cord (1)

Antenna cable (1)

Remote commander (remote) (1)

Size AA (R6) batteries (2)

Specifications and design are subject to change without notice.

About i.LINK

The DV IN jack on this recorder is i.LINK-compliant for digital video cameras. This section describes the i.LINK standard and its features.

What is i.LINK?

i.LINK is a digital serial interface for handling digital video, digital audio and other data in two directions between equipment having the i.LINK jack, and for controlling other equipment.

i.LINK-compatible equipment can be connected by a single i.LINK cable. Possible applications are operations and data transactions with various digital AV equipment. When two or more i.LINK-compatible equipment are connected to this recorder in a daisy chain, operations and data transactions are possible with not only the equipment that this recorder is connected to but also with other devices via the directly connected equipment.

Note, however, that the method of operation sometimes varies according to the characteristics and specifications of the equipment to be connected, and that operations and data transactions are sometimes not possible on some connected equipment.

Note

Normally, only one piece of equipment can be connected to this recorder by the i.LINK cable (DV connecting cable). When connecting this recorder to i.LINK-compatible equipment having two or more i.LINK jacks (DV jacks), see the instruction manual of the equipment to be connected.

About the name “i.LINK”

i.LINK is a more familiar term for IEEE 1394 data transport bus proposed by SONY, and is a trademark approved by many corporations. IEEE 1394 is an international standard standardized by the Institute of Electrical and Electronics Engineers.

i.LINK baud rate

i.LINK's maximum baud rate varies according to the equipment. Three maximum baud rates are defined:

S100 (approx. 100 Mbps*)

S200 (approx. 200 Mbps)

S400 (approx. 400 Mbps)

The baud rate is listed under "Specifications" in the instruction manual of each equipment. It is also indicated near the i.LINK jack on some equipment.

The maximum baud rate of equipment on which it is not indicated such as this unit is "S100."

When units are connected to equipment having a different maximum baud rate, the baud rate sometimes differs from the indicated baud rate.

* What is Mbps?

Mbps stands for megabits per second, or the amount of data that can be sent or received in one second. For example, a baud rate of 100 Mbps means that 100 megabits of data can be sent in one second.

i.LINK functions on this recorder

For details on how to dub when this recorder is connected to other video equipment having DV jacks, see page 66.

The DV jack on this recorder can only input DVC-SD signals. It cannot output signals.

The DV jack will not accept MICRO MV signals from equipment such as a MICRO MV digital video camera with an i.LINK jack.

For further precautions, see the notes on page 66.

For details on precautions when connecting this recorder, also see the instruction manuals for the equipment to be connected.

Required i.LINK cable

Use the Sony i.LINK 4-pin-to-4-pin cable (during DV/Digital8 dubbing).

i.LINK and  are trademarks.

Guide to Parts and Controls

For more information, see the pages in parentheses.

Remote

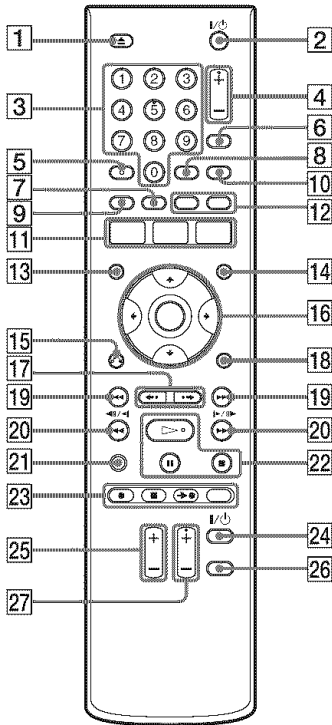

- 1 ▲ OPEN/CLOSE button (27)
- 2 I/⏻ (on/standby) button (23)
- 3 Number buttons (54)
The number 5 button has a tactile dot*.
- 4 CH (channel) +/- buttons (27)
The + button has a tactile dot*.
- 5 AUDIO button (51)
The AUDIO button has a tactile dot*.
- 6 INPUT SELECT button (48, 66)
- 7 MENU button (49)
- 8 SET button (22)
- 9 TOP MENU button (49)

- 10 SUBTITLE button (51)
- 11 SYSTEM MENU button (68, 71)
TITLE LIST button (28, 49, 60)
TIMER button (40)
- 12 CHAPTER MARK button (62)
CHAPTER MARK ERASE button (62)
- 13 DISPLAY button (30)
- 14 TIMER LIST button (44)
- 15 ↻ RETURN button (44)
- 16 ←/↑/↓/→/ENTER button (23)
- 17 ⏮ REPLAY/ADVANCE ⏭ buttons (28, 55)
- 18 OPTIONS button (37)
- 19 ⏪ PREV/NEXT ⏩ buttons (51)
- 20 ⏪⏪ || ⏩⏩ (search/slow/freeze frame) buttons (51)
- 21 TIME/TEXT button (30)
- 22 ▷ PLAY button (49)
|| PAUSE button (51)
■ STOP button (49)
The ▷ PLAY button has a tactile dot*.
- 23 ● REC button (27)
■ REC STOP button (27)
→ ● SYNCHRO REC button (47)
REC MODE button (27)
- 24 TV I/⏻ (TV on/standby) button (20)
- 25 TV VOL (TV volume) +/- buttons (20)
- 26 TV/VIDEO button (20)
- 27 TV CH (TV channel) +/- buttons (20)
The + button has a tactile dot*.

* Use the tactile dot as a reference when operating the recorder.

Front panel

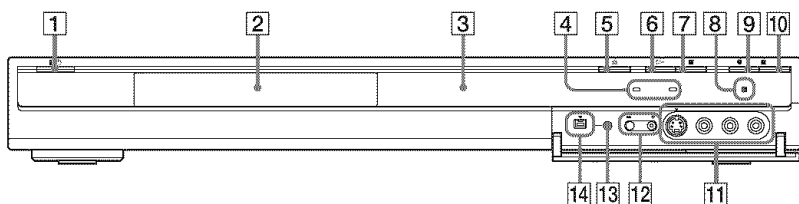

1 I/⏻ (on/standby) button (23)

2 Disc tray (27)

3 Front panel display (31, 94)

4 TIMER REC indicator (40)
SYNCHRO REC indicator (47)

5 ≡ (open/close) button (27)

6 ▷ (play) button (49)

7 ■ (stop) button (49)

8 □ (remote sensor) (20)

9 ● REC button (27)

10 ■ REC STOP button (27)

11 LINE 2 IN (S VIDEO/VIDEO/
L(MONO) AUDIO R) jacks (25)

12 CHANNEL +/- buttons (27)
The + button has a tactile dot*.

13 ONE-TOUCH DUB button (68)

14 DV IN jack (66)

* Use the tactile dot as a reference when operating the recorder.

Front panel display

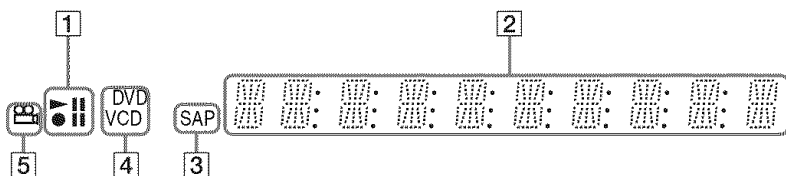

1 Playing/recording status

2 Displays the following (31):

- Playing time/remaining time
- Current title/chapter/track/index number
- Recording time/recording mode

* Displays DATA CDs as "CD."

- Clock
- Channel

3 SAP indicator (40)

4 Disc type*

5  (angle) indicator (49)

Hint

You can turn off the front panel display when the recorder is turned off by setting "Power Save Standby" to "On" in the "Others" setup (page 81).

Rear panel

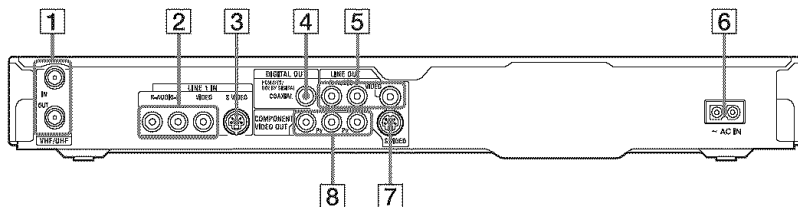

1 VHF/UHF IN/OUT jacks (12)

2 LINE 1 IN (R-AUDIO-L/VIDEO) jacks (16)

3 LINE 1 IN (S VIDEO) jack (24)

4 DIGITAL OUT (COAXIAL) jack (18)

5 LINE OUT (R-AUDIO-L/VIDEO) jacks (16, 18)

6 AC IN terminal (19)

7 LINE OUT (S VIDEO) jack (16)

8 COMPONENT VIDEO OUT (Y, Pb, Pr) jacks (16)

Language Code List

For details, see page 80.

The language spellings conform to the ISO 639: 1988 (E/F) standard.

Code Language	Code Language	Code Language	Code Language
1027 Afar	1183 Irish	1347 Maori	1507 Samoan
1028 Abkhazian	1186 Scots Gaelic	1349 Macedonian	1508 Shona
1032 Afrikaans	1194 Galician	1350 Malayalam	1509 Somali
1039 Amharic	1196 Guarani	1352 Mongolian	1511 Albanian
1044 Arabic	1203 Gujarati	1353 Moldavian	1512 Serbian
1045 Assamese	1209 Hausa	1356 Marathi	1513 Siswati
1051 Aymara	1217 Hindi	1357 Malay	1514 Sesotho
1052 Azerbaijani	1226 Croatian	1358 Maltese	1515 Sundanese
1053 Bashkir	1229 Hungarian	1363 Burmese	1516 Swedish
1057 Byelorussian	1233 Armenian	1365 Nauru	1517 Swahili
1059 Bulgarian	1235 Interlingua	1369 Nepali	1521 Tamil
1060 Bihari	1239 Interlingue	1376 Dutch	1525 Telugu
1061 Bislama	1245 Inupiak	1379 Norwegian	1527 Tajik
1066 Bengali;	1248 Indonesian	1393 Occitan	1528 Thai
Bangla	1253 Icelandic	1403 (Afan)Oromo	1529 Tigrinya
1067 Tibetan	1254 Italian	1408 Oriya	1531 Turkmen
1070 Breton	1257 Hebrew	1417 Punjabi	1532 Tagalog
1079 Catalan	1261 Japanese	1428 Polish	1534 Setswana
1093 Corsican	1269 Yiddish	1435 Pashto;	1535 Tonga
1097 Czech	1283 Javanese	Pushto	1538 Turkish
1103 Welsh	1287 Georgian	1436 Portuguese	1539 Tsonga
1105 Danish	1297 Kazakh	1463 Quechua	1540 Tatar
1109 German	1298 Greenlandic	1481 Rhaeto-	1543 Twi
1130 Bhutani	1299 Cambodian	Romance	1557 Ukrainian
1142 Greek	1300 Kannada	1482 Kirundi	1564 Urdu
1144 English	1301 Korean	1483 Romanian	1572 Uzbek
1145 Esperanto	1305 Kashmiri	1489 Russian	1581 Vietnamese
1149 Spanish	1307 Kurdish	1491 Kinyarwanda	1587 Volapük
1150 Estonian	1311 Kirghiz	1495 Sanskrit	1613 Wolof
1151 Basque	1313 Latin	1498 Sindhi	1632 Xhosa
1157 Persian	1326 Lingala	1501 Sangho	1665 Yoruba
1165 Finnish	1327 Laothian	1502 Serbo-	1684 Chinese
1166 Fiji	1332 Lithuanian	Croatian	1697 Zulu
1171 Faroese	1334 Latvian;	1503 Singhalese	
1174 French	Lettish	1505 Slovak	
1181 Frisian	1345 Malagasy	1506 Slovenian	1703 Not specified

Area Code

For details, see page 79.

Code Area	Code Area	Code Area	Code Area
2044 Argentina	2165 Finland	2362 Mexico	2149 Spain
2047 Australia	2174 France	2376 Netherlands	2499 Sweden
2046 Austria	2109 Germany	2390 New Zealand	2086 Switzerland
2057 Belgium	2248 India	2379 Norway	2528 Thailand
2070 Brazil	2238 Indonesia	2427 Pakistan	2184 United Kingdom
2079 Canada	2254 Italy	2424 Philippines	
2090 Chile	2276 Japan	2436 Portugal	
2092 China	2304 Korea	2489 Russia	
2115 Denmark	2363 Malaysia	2501 Singapore	

Index

Words in quotations appear in the on-screen displays.

Numerics

- 16:9 23, 74
- 4:3 Letter Box 23, 74
- 4:3 Pan Scan 23, 74
- “48kHz/96kHz PCM” 77

A

- “A-B Erase” 61
- AC Power Cord 19
- Adjusting
 - playback picture 52
 - playback sound 53
 - recording picture 42
- “AFT” 72
- Album 31, 57
- Album number 31
- “Album Search” 54
- Angle 49
- Antenna 12
- Area code 95
- AUDIO 51
- “Audio” 76, 80
- “Audio ATT” 76
- “Audio Connection” 23, 76
- Audio cord 18
- “Audio DRC” 77
- “Audio Settings” 53
- “Auto” 72
- “Auto Chapter” 78
- Auto Clock Set 72
- “Auto Display” 75
- “Auto Preset” 71
- “Auto Stereo” 76
- “AV SYNC” 53

B

- “Basic” 71
- Batteries 20
- “BNR” 52
- “Brightness” 43, 52

C

- Cable box 13, 14
- CD 10
- “Change” 45
- “Change Angle” 49
- “Change Order” 64
- Chapter 31, 43, 62
- CHAPTER MARK 62
- CHAPTER MARK ERASE 62
- Chapter number 31
- “Chapter Search” 54
- Chasing Playback 53
- “Check Overlap” 45, 46
- Checking/changing/canceling timer settings (Timer List) 44
- Child Lock 50
- “Clock” 72
- Clock 23
- “Color” 43, 52
- “Combine Titles” 64
- “Command Mode” 22, 81
- COMPONENT VIDEO OUT 16
- Connecting
 - the antenna cable 12
 - the audio cords 18
 - the video cords 16
- “Contrast” 43, 52
- Controlling TVs with the remote 20
- Copy control signals 40
- Copy-Free 40
- Copy-Never 40
- Copy-Once 40
- CPRM 9
- “Create a Playlist” 62
- Creating chapters 62

D

- DATA CD 10
- “Digital Out” 76
- Digital video camera 66
- “Disc Information” 32, 34, 37
- Disc Settings 34, 37, 79
- Disc space 32, 59
- Disc types 8, 59
- “Divide Title” 65
- Dolby Digital 77
- “Downmix” 77
- DTS 77
- “DV / D8 Audio Input” 67
- “DV / D8 EDIT” 69
- DV IN 66
- DV/Digital8 Dubbing 66
 - One Touch Dubbing 68, 80
 - Program Edit 68
- “DVD” 79
- “DVD Menu” 80
- “DVD Rec. Picture Size” 43
- DVD VIDEO 10
- DVD+R 8, 59
- DVD+RW 8, 59
- DVD-R 8, 59
- DVD-RW 8, 59

E

- Easy Setup 23, 82
- Editing 59, 62
 - DV/D8 Edit 66
- Enter characters 33
- “Erase” 44, 60, 63, 69
- Erase all titles 61
- “Erase Titles” 60
- “Extend Rec Time” 41

- F**
- “Factory Setup” 81
 - “File Search” 54
 - “Finalize” 36
 - “Finalize Disc” 80
 - Finalizing 35
 - “FNR” 52
 - “Format” 37
 - “Format DVD-RW” 80
 - Formatting 37
 - Freeze Frame 51
 - Front panel 93
 - Front panel display 31, 94
- G**
- GB 38
- H**
- Handling discs 89
 - “Hue” 43, 52
- I**
- i.LINK 90
 - INPUT SELECT 48, 67
- J**
- JPEG image files 55
- L**
- Labeling 34
 - “Language” 80
 - LINE 1 IN 24
 - LINE 2 IN 25
 - “Line Input” 75
 - “Line1 Input” 75
- M**
- Main sound 51
 - “Make a Playlist” 64
 - “Manual Channel Setup” 71
 - Manual Clock Set 73
 - MENU 49
 - Menu
 - DVD’s Menu 49
 - Top menu 49
 - “Mix” 67
 - “MNR” 52
 - “Modify” 44
 - “Move” 63, 69
 - MP3 audio tracks 55
- N**
- Number buttons 34
- O**
- One Touch Dubbing 68, 80
 - Original 29, 59
 - “OSD” 23, 73
 - “Others” 81
- P**
- Page mode 29, 45
 - Parental Control 50, 79
 - Parts and controls 92
 - “Pause Mode” 75
 - “PB Video Equalizer” 52
 - PBC 49
 - Picture quality 42, 52
 - Picture size 42
 - “Play Beginning” 50, 56
 - Play mode 31
 - Playable discs 10
 - Playback 10, 49
 - fast forward 51
 - fast reverse 51
 - freeze frame 51
 - instant advance 51
 - instant replay 51
 - JPEG image files 55
 - MP3 audio tracks 55
 - resume play 50
 - slow-motion play 51
 - Playing status bar 31
 - Playlist 29, 59, 62
 - “Power Save Standby” 81
 - “Preview” 63, 69
 - Program Edit 68
 - “Progressive Mode” 75
 - “Progressive Output” 74
 - “Protect Disc” 35
 - “Protect Title” 60
 - Protection
 - disc 35
 - title 60

Q

Quick guide to disc types 8
Quick Timer 42

R

Rear panel 94
REC 27
“Rec Mode” 42
“Rec Mode Adjust” 41, 78
“Rec NR” 43
“Rec Settings” 42
REC STOP 28, 68
“Rec Video Equalizer” 43
Recordable discs 8
“Recording” 78
Recording 39

- picture adjustment 42
- recording format 8
- recording mode 28, 39
- recording time 28, 39
- while watching
 - another program 28

Recording time 39
Region code 11
Remaining time 31
Remote 20, 92
Resetting the recorder 82
Resume Play 50

S

S VIDEO 16
SAP (Second Audio Program) 40
Satellite receiver 13, 26
Scene List 63
“Screen Saver” 75
“Search” 54
Searching

- fast reverse/fast forward 51
- locating the beginning of the title/ chapter/track 51
- search mode 54

SET 22, 34, 54
“Set Thumbnail” 60
“Sharpness” 52
Simultaneous Rec and Play 54
Slow-motion play 51
Sort 29
Stereo 40
Stereo programs 40
“Stereo1” 67
“Stereo2” 67
Sub sound 51
SUBTITLE 51
“Subtitle” 80
Super VIDEO CD 10
Synchro Rec 47

T

Thumbnail picture 30
“Time Search” 54
TIME/TEXT 31
TIMER 40
Timer List 44
Timer recording 40

- check/change/cancel 44
- “Rec Mode Adjust” 41
- Synchro Rec 47

“Timer Settings” 78
Title 31
TITLE LIST 49
Title List 28, 49

- Sort 29
- Thumbnail 30

“Title Name” 60
Title number 31
“Title Search” 54
TOP MENU 49
“Track Search” 54
Troubleshooting 83
“Tuner Audio” 76
“Tuner Preset” 71
Tuner Preset 23
“TV Type” 23, 74
TV/VIDEO 20, 28

U

“Unfinalize” 37
Unfinalizing 37
Usable discs 8, 10

V

“Video” 74
VIDEO CD 10
Video cord 16
Video input 16
Video mode 8
“Video Output” 74
“Video Settings” 52
VR mode 8

Y

“Y/Pb/Pr Out Black Level” 74



Printed on 100% recycled paper using
VOC (Volatile Organic Compound)-free
vegetable oil based ink.



1-2672839117

2-672-839-11(1)