

DVD Camcorder

SC-DC163/DC164/DC165

- AF** Auto Focus
CCD Charge Coupled Device
LCD Liquid Crystal Display

Owner's Instruction Book

Before operating the unit, please read this Instruction Book thoroughly, and retain it for future reference.

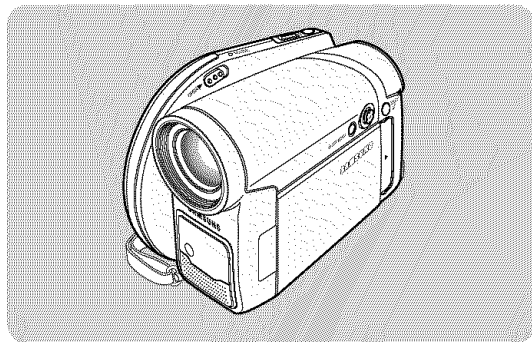

SAMSUNG

US PATENT 4415844

Use only approved battery packs.
Otherwise, there is a danger of overheating, fire or explosion.
Samsung is not responsible for problems occurring due to
using unapproved batteries.



Notices and Safety Instructions

Safety Instructions

Shock Hazard Marking and Associated Graphical Symbols



Explanation of Safety Related Symbols



This symbol is intended to alert the user to the presence of uninsulated "dangerous voltage" within the product's enclosure that may be of sufficient magnitude to constitute a risk of electric shock to persons.



This symbol is intended to alert the user to the presence of important operating and maintenance (servicing) instructions in the literature accompanying the appliance.

WARNING - To Reduce The Risk Of Fire Or Electric Shock, Do Not Expose This Apparatus To Rain Or Moisture.

1. Read these instructions.
2. Keep these instructions.
3. Heed all warnings.
4. Follow all instructions.
5. Do not use this apparatus near water.
6. Clean only with dry cloth.
7. Do not block any ventilation openings. Install in accordance with the manufacturer's instructions.
8. Do not install near any heat sources such as radiators, heat registers, stoves, or other apparatus (including amplifiers) that produce heat.
9. Do not defeat the safety purpose of the polarized or grounding type plug. A polarized plug has two blades with one wider than the other. A grounding type plug has two blades and a third grounding prong. The wide blade or the third prong are provided for your safety. If the provided plug does not fit into your outlet. Consult an electrician for replacement of the obsolete outlet.
10. Protect the power cord from being walked on or pinched particularly at plugs, convenience receptacles, and the point where they exit from the apparatus.
11. Only use attachments/accessories specified by the manufacturer.
12. Use only with the cart, stand, tripod, bracket, or table specified by the manufacturer, or sold with the apparatus. When a cart is used, use caution when moving the cart/apparatus combination to avoid injury from tip-over.
13. Unplug this apparatus during lightning storms or when unused for long periods of time.
14. Refer all servicing to qualified service personnel. Servicing is required when the apparatus has been damaged in any way, such as power-supply cord or plug is damaged, liquid has been moisture, does not operate normally, or has been dropped.



Figure 10-10 © 2010 Philips North America

Notices and Safety Instructions

15. The apparatus shall not be exposed to dripping or splashing and that no objects filled with liquids, such as vases, shall be placed on the apparatus.

16. VENTILATION:

Slots and openings in the cabinet are provided for ventilation to ensure reliable operation of the CAMCORDER and to protect it from overheating. These openings must not be blocked or covered. Never place your CAMCORDER on a bed, sofa, rug, or other similar surface: on or near a radiator or heat register. This CAMCORDER should not be placed in a built-in installation such as a bookcase or rack unless proper ventilation is provided or the manufacturer's instructions have been adhered to.

17. POWER SOURCES:

The CAMCORDER should be operated only from the type of power source indicated on the label. If you are not sure of the type of power supply at your home, consult your appliance dealer or local power company. A CAMCORDER is intended to be operated from battery power, or other sources, refer to the operating instructions.

18. GROUNDING OR POLARIZATION:

This CAMCORDER may be equipped with either a polarized 2-wire AC line plug (a plug having one blade wider than the other) or a 3-wire grounding type plug, a plug having a third (grounding) pin. If you are unable to insert the plug fully into the outlet, try reversing the plug. If the plug still fails to fit, contact your electrician to replace your outlet. Do not defeat the safety purpose of the polarized plug.

19. POWER-CORD PROTECTION:

Power-supply cords should be routed so that they are not likely to be walked on or pinched by items placed upon or against them, paying particular attention to cords or plugs, convenient receptacles, and the point where they exit from the unit.

20. OUTDOOR ANTENNA GROUNDING:

If an outside antenna or cable system is connected to the CAMCORDER, be sure the antenna or cable system is grounded to provide some protection against voltage surges and built-up static charges, Section 810 of the National Electrical Code, ANSI/NFPA No. 70-1984, provides information with respect to proper grounding of the mast and supporting structure, grounding of the lead-in wire and supporting structure, grounding of the mast and supporting structure, grounding of the lead-in wire to an antenna discharge unit, size of grounding to conductors, location of antenna-discharge unit, connection to grounding electrodes and requirements for the grounding electrode.

See figure below.

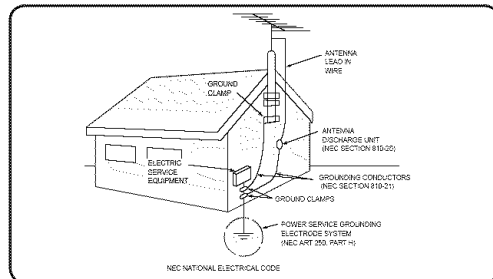

Notices and Safety Instructions

21. LIGHTNING:

For added protection of this CAMCORDER during a lightning storm or when it is left unattended and unused for long periods of time, unplug it from the wall outlet and disconnect the antenna or cable system. This will prevent damage to the CAMCORDER due to lightning and power-line surges.

22. POWER LINES:

An outside antenna system should not be located in the vicinity of overhead power lines or other electric light or power circuits where it can fall into such power lines or circuits. When installing an outside antenna system, extreme care should be taken to keep from touching such power lines or circuits as contact with them might be fatal.

23. OVERLOADING:

Do not overload wall outlets and extension cords as this can result in a risk of fire or electric shock.

24. OBJECTS AND LIQUIDS:

Never push objects of any kind into this CAMCORDER through openings as they may touch dangerous voltage points or short out a part that could result in a fire or electric shock. Never spill liquids of any kind onto the CAMCORDER. Should spillage occur, unplug unit and have it checked by a technician before use.

25. SERVICING:

Do not attempt to service this CAMCORDER yourself. Opening or removing covers may expose you to dangerous voltage or other hazards. Refer all servicing to qualified service personnel.

26. DAMAGE REQUIRING SERVICE:

Unplug this CAMCORDER from the wall outlet and refer servicing to qualified service personnel under the following conditions:

- a. When the power-supply cord or plug is damaged.
- b. If any liquid has been spilled onto, or objects have fallen into the CAMCORDER.
- c. If the CAMCORDER has been exposed to rain or water.
- d. If the CAMCORDER does not operate normally by following the operating instructions, adjust only those controls that are covered by the operating instructions. Improper adjustment of other controls may result in damage and will often require extensive work by a qualified technician to restore the CAMCORDER to its normal operation.
- e. If the CAMCORDER has been dropped or the cabinet has been damaged.
- f. When the CAMCORDER exhibits a distinct change in performance, this indicates a need for service.

27. REPLACEMENT PARTS:

When replacement parts are required, be sure the service technician has used replacement parts specified by the manufacturer and having the same characteristics as the original part. Unauthorized substitutions may result in fire, electric shock or other hazards.

28. SAFETY CHECK:

Upon completion of any service or repairs to this CAMCORDER, ask the service technician to perform safety checks to determine that the CAMCORDER is in safe operating order.

Notices and Safety Instructions

29. To prevent damage which may result in fire or shock hazard, do not expose this appliance to rain or moisture.
30. If this power supply is used at 240V ac, a suitable plug adapter should be used.

USER INSTALLER CAUTION:

Your authority to operate this FCC certified equipment could be voided if you make changes or modifications not expressly approved by this party responsible for compliance to part 15 FCC rules.

NOTE:

Hg LAMP(S) INSIDE THIS PRODUCT CONTAIN MERCURY AND MUST BE RECYCLED OR DISPOSED OF ACCORDING TO LOCAL, STATE OR FEDERAL LAWS. For details see lamprecycle.org, eiae.org, or call 1-800-Samsung (7267864)

CLASS 1 LASER PRODUCT
 KLASSE 1 LASER PRODUKT
 LUOKAN 1 LASER LAITE
 KLASSE 1 LASER APPARAT
 PRODUCTO LÁSER CLASE 1

NOTE: This equipment has been tested and found to comply with the limits for a Class B digital device, pursuant to part 15 of the FCC Rules. These limits are designed to provide reasonable protection against harmful interference in a residential installation. This equipment generates, uses and can radiate radio frequency energy and, if not installed and used in accordance with the instructions, may cause harmful interference to radio communications. However, there is no guarantee that interference will not occur in a particular installation. If this equipment does cause harmful interference to radio or television reception, which can be determined by turning the equipment off and on, the user is encouraged to try to correct the interference by one or more of the following measures:

- Reorient or relocate the receiving antenna.
- Increase the separation between the equipment and receiver.
- Connect the equipment into an outlet on a circuit different from that to which the receiver is connected.
- Consult the dealer or an experienced radio/TV technician for help and for additional suggestions.

The user may find the following booklet prepared by the Federal Communications Commission helpful: "How to Identify and Resolve Radio-TV Interference Problems."

This Booklet is available from the U.S. Government Printing Office, Washington, D.C. 20402, Stock No. 004-000-00345-4.

FCC Warning

The user is cautioned that changes or modifications not expressly approved by the manufacturer could void the user's authority to operate the equipment.

FCC ID : A3L06RAINBOW1

This device complies with Part 15 of FCC Rules.

Operation is subject to the following two conditions;

- (1) This device may not cause harmful interference, and
- (2) This device must accept any interference received, including interference that may cause undesired operation.

Contents

Notes and Safety Instructions	6	Initial Setting : System Menu Setting	30
Getting to Know Your DVD Camcorder	9	Setting the Clock (Clock Set)	30
Features	9	Setting the Wireless Remote Control Acceptance (Remote) (SC-DC164/DC165 only)	31
About Disc	10	Setting the Beep Sound (Beep Sound)	32
Disc Type Description	11	Setting the Shutter Sound (Shutter Sound)	33
How to use the DVD Camcorder easily	12	Selecting the OSD Language (Language)	34
Accessories Supplied with the DVD Camcorder	13	Viewing the Demonstration (Demonstration)	35
Front & Left View	14	Initial Setting : Display Menu Setting	36
Left Side View	15	Adjusting the LCD Screen (LCD Bright/LCD Color)	36
Right & Top View	16	Displaying the Date/Time (Date/Time)	37
Rear & Bottom View	17	DVD Camcorder: Before Recording	38
Remote Control (SC-DC164/DC165 only)	18	Using the Viewfinder	38
Preparation	19	Various Recording Techniques	39
Using the Hand Strap & Lens Cover	19	Inserting and Removing a Disc	40
Lithium Battery Installation	20	Selecting the Record Mode (Rec Mode)	42
Using the Lithium Ion Battery Pack	21	DVD Camcorder: Basic Recording	43
Connecting a Power Source	25	Making your First Recording	43
About the Operating Modes	26	Recording with Ease for Beginners (EASY.Q Mode)	44
Using the Joystick	26	Using External Microphone	45
Using the QUICK MENU	27	Zooming In and Out	45
OSD (On Screen Display) in Camera Mode/Player Mode	28	Using the Fade In and Out (FADE)	46
OSD (On Screen Display) in M.Cam Mode/M.Player Mode	29	Using Back Light Compensation Mode (BLC)	47
Turning the OSD (On Screen Display) On/Off	29		

Contents

Using the Color Nite	48	Deleting a Title (Delete)	70
Using the LED LIGHT (SC-DC165 only)	49	Deleting a Section of a Title (Partial Delete)	71
DVD Camcorder: Advanced Recording..... 50		DVD Camcorder: Playlist..... 72	
Cutting Off Wind Noise (Wind Cut)	50	Creating a New Playlist (New Playlist)	72
Setting the Shutter Speed & Exposure (Shutter/Exposure)	51	Renaming a Playlist (Playlist Name)	73
Auto Focus / Manual Focus	52	Playing the Playlist	74
Programmed Automatic Exposure Modes (Program AE) ...	53	Playlist Information (Playlist Info)	75
Setting the White Balance (White Balance)	55	Deleting a Playlist (Delete)	76
Applying Digital Effects (Digital Effect)	57	Adding Scenes to Playlist (Edit Playlist-Add)	77
Setting the 16:9 Wide mode (16:9 Wide)	59	Changing the Order of Scene Playing within a Playlist (Edit Playlist-Move)	78
Setting the Digital Image Stabilizer (DIS)	60	Deleting Scenes from Playlist (Edit Playlist-Delete)	79
Zooming In and Out with Digital Zoom (Digital Zoom)	61	Deleting a Section of a Playlist (Edit Playlist - Partial Delete)	80
DVD Camcorder: What's Title List and Playlist... 62		DVD Camcorder: Disc Manager 82	
What's a Title List?	62	Disc Information (Disc Info)	82
What's a Playlist?	62	Editing the Disc Name (Disc Info-Rename)	83
DVD Camcorder: Title List..... 63		Formatting a Disc (Disc Format)	84
Playing Title Lists	63	Finalizing a Disc (Disc Finalize)	85
Adjusting the Volume	63	Playing Back on a PC with DVD drive	86
Various Functions while in Player Mode	64	Playing back a finalized disc on a DVD Player/Recorder ..	86
Zooming during Playback (PB ZOOM)	66	Unfinalizing a Disc (Disc Unfinalize)	87
Renaming a Title (Title Name)	67		
Title Information (Title Info)	68		
Protecting a Title (Protect)	69		

Contents

DVD Camcorder: Connection	88	PictBridge™	109
Setting the AV In/Out (SC-DC165 only).....	88	Printing Your Pictures-Using the PictBridge™.....	109
Viewing Recordings on TV.....	89	Connecting To a Printer (USB Connect).....	109
Copying a Disc onto a Tape.....	91	Setting the Number of Prints.....	110
Recording (Copying) a TV Program or Video Tape onto a Disc (SC-DC165 only).....	92	Setting the Date/Time Imprint Option.....	110
		Printing Images.....	110
		Canceling the Printing.....	110
Digital Still Camera Mode	93	USB Interface	111
Using a Memory Card (Usable Memory Card) (not supplied).....	93	Using USB Interface.....	111
Memory Card Functions.....	93	Selecting the USB Device (USB Connect).....	113
Inserting a Memory Card.....	93	Installing DV Media PRO Program.....	114
Ejecting a Memory Card.....	93	Ulead Video Studio.....	115
Structure of Folders and Files on the Memory Card.....	94	Connecting to a PC.....	116
Selecting the Photo Quality (Photo Quality).....	95	Disconnecting the USB Cable.....	116
Setting the File Number (File No.).....	96	Using the PC Camera Function.....	117
Taking a Photo Image (JPEG) on the Memory Card.....	97	Using the USB Streaming Function.....	118
Viewing Photo Images (JPEG).....	98	Using the removable Disk Function.....	118
Protection from accidental Erasure (Protect).....	100	Maintenance	119
Deleting Photo Images and Moving Images (Delete).....	101	Using Your DVD Camcorder Abroad.....	119
Formatting the Memory Card (Format).....	103		
Recording Moving Images (MPEG) on the Memory Card...	104		
Playing the Moving Images (MPEG) on the Memory Card...	105		
Recording Still images onto a Memory Card during DVD playback.....	106		
Marking Images for Printing (Print Mark).....	107		

Contents

Troubleshooting	120
Troubleshooting	120
Setting menu items	125
Specifications	127
Index	128
Warranty (SEA users only)	129

Notes and Safety Instructions

Notes regarding the Rotation of the LCD Screen

Please rotate the LCD Screen carefully as illustrated. Over-rotation may cause damage to the inside of the hinge that connects the LCD Screen to the DVD Camcorder.

1. Open the LCD Screen 90 degrees with your finger.
2. Rotate it to the best angle to record or play.
 - If you rotate the LCD Screen 180 degrees to the lens side, you can close the LCD Screen with it facing out.
 - This is convenient during playback operations.

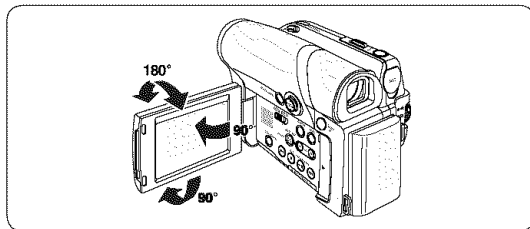

Note

Refer to page 36 to adjust brightness and color of the LCD Screen.

Notes regarding the LCD Screen, Viewfinder, Lens

1. Direct sunlight can damage the LCD Screen, the inside of the Viewfinder or the Lens. Take pictures of the sun only in low light conditions, such as at dusk.
2. The LCD Screen has been manufactured using high precision technology. However, there may be tiny dots (red, blue or green in color) that appear on the LCD Screen. These dots are normal and do not affect the recorded picture in any way.
3. Do not pick up the DVD Camcorder by holding the Viewfinder, LCD Screen or Battery Pack.
4. Applying excessive force to the Viewfinder may damage it.

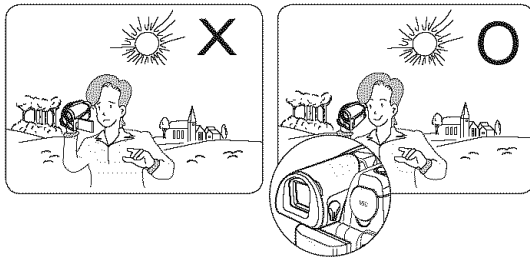

Notes and Safety Instructions

Notes regarding the Disc Cleaning and Handling

- Take care not to touch the recording side (the rainbow colored side) of the disc with fingers. Discs contaminated by fingerprints or foreign substances may not play properly.
- Use a soft cloth to clean the disc.
- Clean lightly from the center of a disc to the outside edge. Circling or cleaning too hard may create scratches on the disc and further cause the disc to play abnormally.
- Do not use benzene, thinner, detergent, alcohol or anti-static spray when cleaning the disc. It may cause a malfunction.
- Press the supporting holder in the center of the disc case for easy removal of the disc.
- Handle discs by the edges and the center hole to avoid finger marks on the recording side.
- Do not bend or apply heat to the disc.
- Always store discs vertically in their plastic cases when not in use.
- Store discs away from direct sunlight, heating elements, moisture or dust.

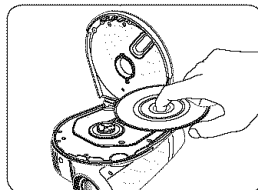
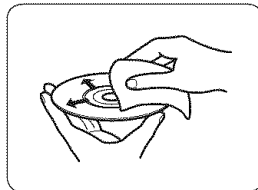

Notes and Safety Instructions

Notes regarding DVD Camcorder

- Do not leave the DVD Camcorder exposed to high temperatures (above 60 °C or 140 °F).
For example, in a parked car in the sun or exposed to direct sunlight.
- Do not let the DVD Camcorder get wet. Keep the DVD Camcorder away from rain, sea water, and any other form of moisture.
If the DVD Camcorder gets wet, it may get damaged. Sometimes a malfunction due to exposure to liquids cannot be repaired.
- A sudden rise in atmospheric temperature may cause condensation to form inside the DVD Camcorder.
 - When you move the DVD Camcorder from a cold location to a warm location (e.g. from outside to inside during the winter.)
 - When you move the DVD Camcorder from a cool location to a hot location (e.g. from inside to outside during the summer.)

Notices regarding Copyright (SC-DC165 only)

Television programs, video tapes, DVD titles, films, and other program materials may be copyrighted.

Unauthorized copying of copyrighted material may be against the law.

All the trade names and registered trademarks mentioned in this manual or other documentation provided with your Samsung product are trademarks or registered trademarks of their respective holders.

Servicing & Replacement Parts

- Do not attempt to service this DVD Camcorder yourself.
- Opening or removing covers may expose you to dangerous voltage or other hazards.
- Refer all servicing to qualified service personnel.
- When replacement parts are required, be sure the service technician has used replacement parts specified by the manufacturer that have the same characteristics as the original parts.
- Unauthorized substitutions may result in fire, electric shock or other hazards.

Getting to Know Your DVD Camcorder



Features

- **DVD Disc Camcorder**
DVD-VIDEO Title Production with 3 1/2inch (8cm) DVD-RW/+RW/DVD-R/+R DL(Dual Layer) discs.
- **High Power Zoom Lens**
Offers you 30x (SC-DC163 only), 33x (SC-DC164/DC165 only) High Power Zoom Lens.
- **USB Interface for Digital Image Data Transfer**
You can transfer images to a PC using the USB interface without an add-on card.
- **Photo Capture**
The Photo Capture function lets you capture the scene you want while the disc is in play, and save as a still image on the Memory Card.
- **1200x Digital Zoom**
Allows you to magnify an image up to 1200 times its original size.
- **Color TFT LCD**
A high-resolution color TFT LCD gives you clean, sharp images as well as the ability to review your recordings immediately.
- **Digital Image Stabilizer (DIS)**
The DIS compensates for any handshake, reducing unstable images particularly at high magnification.
- **Various Digital Effects**
The Digital Effects allow you to give your recordings a special look.
- **Back Light Compensation (BLC)**
The BLC function compensates for the bright background behind a subject you're recording.
- **Program AE**
The Program AE enables you to alter the shutter speed and aperture to suit the type of scene/action to be recorded.
- **Digital Still Camera Function**
 - Using Memory Card, you can easily record and playback standard photo images.
 - You can transfer standard photo images on the Memory Card to your PC using the USB interface.
- **Moving Image Recording**
Moving image recording makes it possible to record video onto a Memory Card.
- **Multi Memory Card Slot**
Multi Memory Card slot is able to use Memory Stick (Duo), Memory Stick PRO, MMC and SD.
- **Multi OSD Language**
You can select the desired OSD language from OSD list.

Getting to Know Your DVD Camcorder

About Disc

Playable Discs

DVD-R / DVD-RW (3 1/2inch (8cm))	
DVD+RW (3 1/2inch (8cm))	
DVD+R DL (Dual Layer) (3 1/2inch (8cm))	

Unplayable Discs

- You may not use 5inch (12cm) CD/DVD discs.
- Unplayable 3 1/2inch (8cm) Discs
 - CD
 - CD-R
 - CD-RW
 - DVD-ROM
 - DVD+R (Single Layer)
 - DVD-RAM
 - DVD-R(Dual Layer)
- Floppy Disk, MO, MD, iD, LD

Notes

- We are not responsible for the life span of the recording based on the quality of the disc in the DVD Camcorder and how long the data can be kept.
- You may not be able to play discs recorded from a PC or DVD recorder. When such a case occurs, the message, **Bad Disc!** may be displayed.
- We do not warranty any damage or loss incurred due to recording and playback failure caused by disc or card malfunction.
- We take no responsibility and offer no compensation for any recording failure, loss of recorded or edited material and/or damage to the recorder arising from the misuse of discs.

Getting to Know Your DVD Camcorder

Disc Type Description

Disc Type	DVD-R (3 1/2inch (8cm))	DVD+R DL (3 1/2inch (8cm))	DVD-RW (3 1/2inch (8cm))		DVD+RW (3 1/2inch (8cm))
	Mode	-	VR (Video Recording)	Video	-
Capacity	1.4G	2.6G	1.4G	1.4G	1.4G
Formatting a new disc ^① ↪ page 41	Auto	Auto	○ [Ⓞ]		○ [Ⓞ]
Recording ↪ page 43	○	○	○	○	○
Rewrite	X	X	○	○	○
Playback on other DVD Players [Ⓞ] (Finalize [Ⓞ]) ↪ page 86	○	○	X	○	○ [Ⓞ]
Playback on other DVD Recorders [Ⓞ] ↪ page 86	○	○	○	○	○ [Ⓞ]
Additional recording after finalization (Unfinalize) ↪ page 87	X	X	○	○	- [Ⓞ]
Editing ↪ page 71	X	X	○	X	X
Reusing a disc by formatting [Ⓞ] (Format) ↪ page 84	X	X	○	○	○

▪ ○: possible / X: not possible / -: not needed

- ① You must format new disc before recording on it.
- ② When loading a DVD-RW disc you must format it in Video or VR mode.
- ③ When loading a DVD+RW disc you must format it.
- ④ **We cannot guarantee that you will be able to play back in all other manufacturer's DVD camcorders, DVD Players/ Recorders, or PC's. For compatibility information, please refer to the manual of the device you wish to play back on.**
- ⑤ Discs must be finalized before they can be played on standard DVD Players/Recorders. Refer to the page 12 for Finalized disc compatibility.
- ⑥ You can play back DVD+RW discs on DVD Players/Recorders without finalizing them. DVD+RW disc does not need the Finalize/Unfinalize feature.
- ⑦ When formatting a recorded disc, the data recorded on the disc is deleted and disc capacity is restored, enabling you to re-use the disc.

Getting to Know Your DVD Camcorder

How to use the DVD Camcorder easily

You can record any desired image and edit and playback the disc on a DVD Camcorder, most DVD players, and PCs after finalizing the disc.

Step 1 Inserting and Formatting a Disc

Selecting the desired disc and disc formatting ↪page 41

Step 2 Recording the Desired Image

Step 3 Editing Recorded Images

You may edit only in DVD-RW (VR Mode). ↪page 71

Step 4 Finalizing a Disc

- Discs must be finalized before they can be played on standard DVD Players/Recorders.
- You may play back DVD+RW discs on other devices without finalizing them.

Step 5 Playback on a DVD Camcorder, DVD Player/Recorder, or PC

DVD-RW(VR mode) : You may play back only on DVD Recorders that support DVD-RW VR mode. ↪page 86

Playing the finalized disc

Disc Type	Mode	Player/Recorder
DVD-R/+R DL	-	DVD Player, DVD Recorder
DVD-RW	Video	DVD Player, DVD Recorder
	VR	DVD Recorder that supports DVD-RW VR mode.

- Playback is not guaranteed in all DVD Players/Recorders. For compatibility details, refer to your DVD Players/Recorder's owner's manual.
- You can play back DVD+RW discs on other DVD Players/Recorders without finalizing them.

Getting to Know Your DVD Camcorder

Accessories Supplied with the DVD Camcorder

Make sure that the following basic accessories are supplied with your DVD Camcorder.

Basic Accessories

1. Lithium Ion Battery Pack (SB-LSM80)
2. AC Power Adapter (AA-E8 TYPE)
3. AC Cord
4. Multi-AV Cable
5. Instruction Book/Quick Guide
6. Lithium Batteries for Remote Control (SC-DC164/DC165 only) and Clock. (TYPE: CR2025)
7. Remote Control (SC-DC164/DC165 only)
8. USB Cable
9. Software CD (DV Media PRO, Ulead Video Studio)
10. Lens Cover
11. Lens Cover Strap
12. 3 1/2inch (8cm) DVD-RW Disc (SC-DC165 only)

Optional Accessory

13. Carrying Case

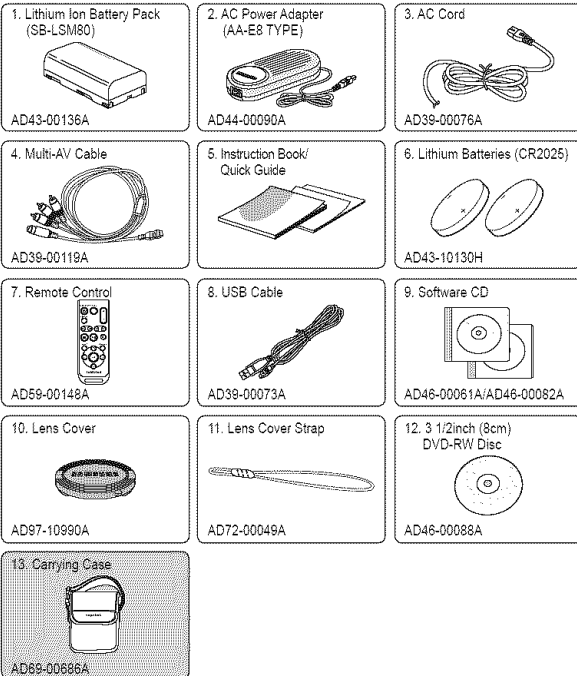

Note

Parts and accessories are available at your local Samsung dealer and service center.

Getting to Know Your DVD Camcorder

Front & Left View

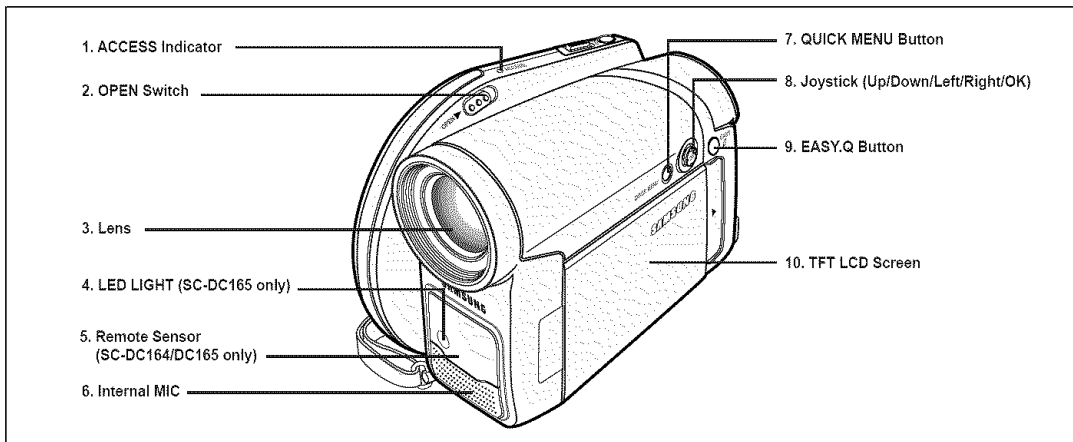

1. ACCESS Indicator ↪page 40

2. OPEN Switch ↪page 40

3. Lens

4. LED LIGHT (SC-DC165 only) ↪page 49

5. Remote Sensor (SC-DC164/DC165 only)

6. Internal MIC

7. QUICK MENU Button ↪page 27

8. Joystick (Up/Down/Left/Right/OK) ↪page 26

9. EASY.Q Button ↪page 44

10. TFT LCD Screen

Getting to Know Your DVD Camcorder

Left Side View

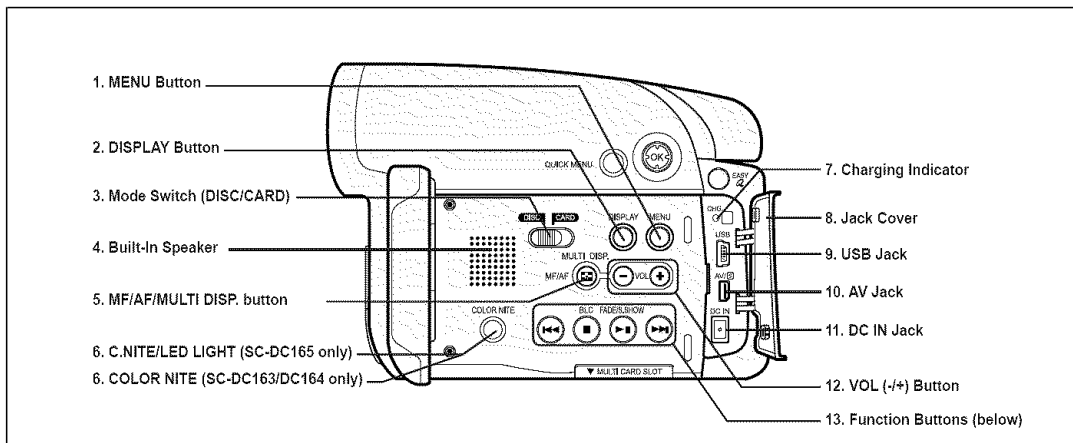

1. MENU Button
2. DISPLAY ↪ page 29
3. Mode Switch (DISC/CARD)
4. Built-In Speaker
5. MF/AF/MULTI DISP. button ↪ page 52/98
6. C.NITE/LED LIGHT (SC-DC165 only) ↪ page 49
6. COLOR NITE (SC-DC163/DC164 only) ↪ page 48
7. Charging Indicator
8. Jack Cover
9. USB Jack
10. AV Jack

11. DC IN Jack
12. VOL (-/+) Button
13. Function Buttons



• M.Player Mode : Memory Player Mode

Button \ Mode	<Player Mode>	<Camera Mode>	<M.Player Mode>	
			Photo image	Moving image
⏮	Backward Search/ Skip	-	Backward Skip	Backward Search
⏭	Forward Search/ Skip	-	Forward Skip	Forward Search
⏸	Play/Still	FADE	Slide Show	Play/Still
■	Stop	BLC	-	Stop

Getting to Know Your DVD Camcorder

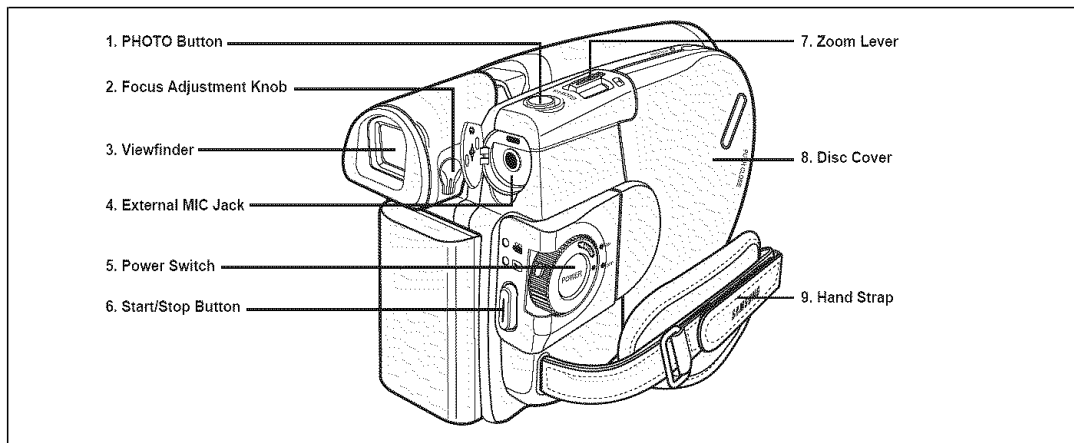
Right & Top View



1. PHOTO Button ↪ page 97
2. Focus Adjustment Knob ↪ page 38
3. Viewfinder
4. External MIC Jack
5. Power Switch (ON/OFF/  (Camera)/  (Player))

6. Start/Stop Button
7. Zoom Lever
8. Disc Cover
9. Hand Strap

Getting to Know Your DVD Camcorder

Rear & Bottom View

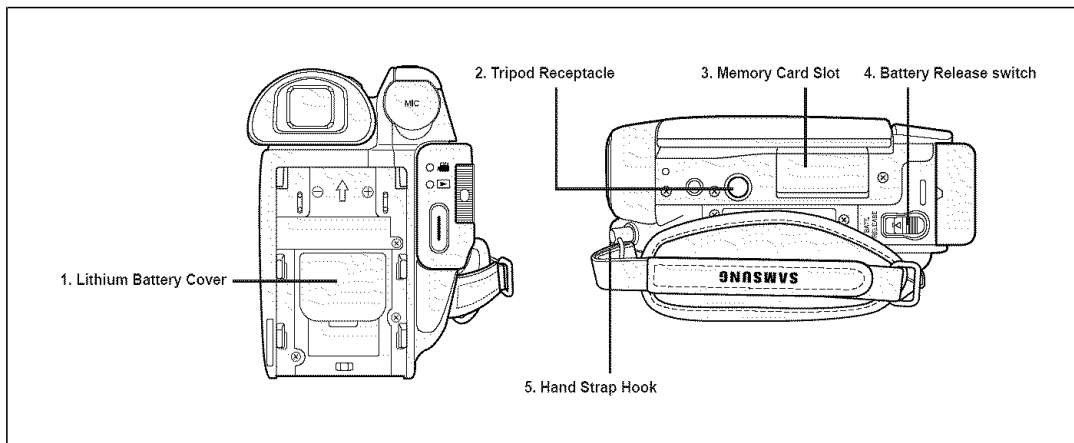

1. Lithium Battery Cover
2. Tripod Receptacle
3. Memory Card Slot
4. Battery Release switch
5. Hand Strap Hook

Usable Memory Cards

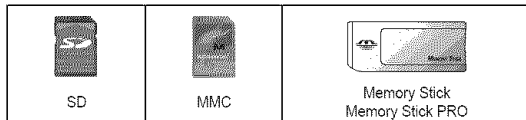

Getting to Know Your DVD Camcorder

Remote Control (SC-DC164/DC165 only)

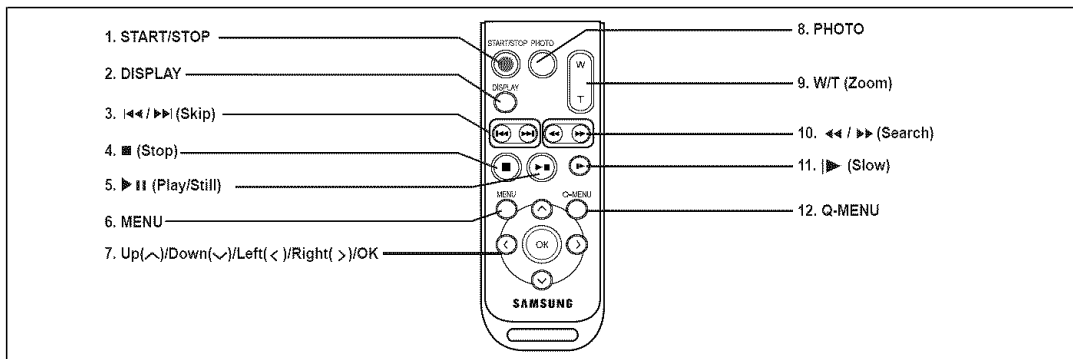

1. START/STOP
2. DISPLAY ↪ page 29
3. ⏮/⏭ (Skip)
4. ■ (Stop)
5. ▶⏪ (Play/Still)
6. MENU
7. Up(⤴)/Down(⤵)/Left(<)/Right(>)/OK

8. PHOTO ↪ page 97
9. W/T (Zoom) ↪ page 45
10. ⏮/⏭ (Search)
11. |▶ (Slow)
12. Q-MENU

Preparation

Using the Hand Strap & Lens Cover

It is very important to ensure that the Hand Strap has been correctly adjusted before you begin your recording.

The Hand Strap enables you to:

- Hold the DVD Camcorder in a stable, comfortable position.
- Press the **[Zoom]** lever and **[Start/Stop]** button without having to change the position of your hand.

Hand Strap

1. Pull and open the Hand Strap and release the Hand Strap Hook.
Insert the Hand Strap into the Hand Strap Hook.
2. Insert your hand into the Hand Strap and adjust its length.
3. Close the Hand Strap.

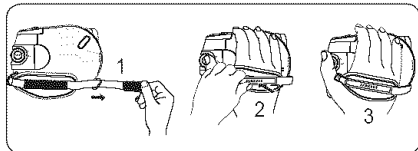

Lens Cover

1. Hook up the Lens Cover with the Lens Cover Strap as illustrated.
2. Pull and open the Hand Strap and release the Hand Strap.
3. Hook up the Lens Cover Strap to the Hand Strap and adjust it following the steps as described for the Hand Strap.
4. Close the Hand Strap.

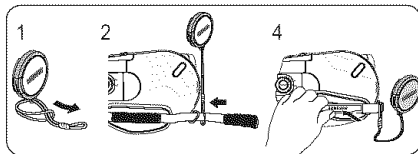

Installing the Lens Cover after Operation

Press buttons on both sides of the Lens Cover, then insert it so it covers the DVD Camcorder Lens.

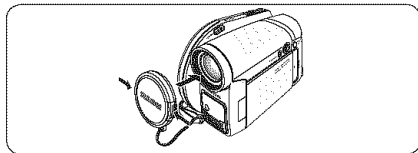

Preparation

Lithium Battery Installation

Lithium Battery Installation for the Internal Clock

1. Remove the Battery Pack from the rear of the DVD Camcorder.
2. Open the Lithium Battery Cover on the rear of the DVD Camcorder.
3. Position the Lithium Battery in the Lithium Battery Holder, with the positive (+) terminal face up.
Be careful not to reverse the polarity of the Battery.
4. Close the Lithium Battery Cover.

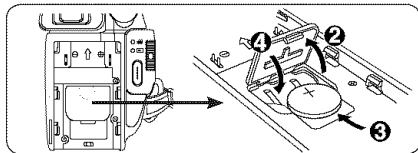

Installing the Lithium Battery in the Remote Control (SC-DC164/DC165 only)

1. Turn the battery holder counterclockwise (as indicated with [⊖] mark), using your fingernail or a coin to open it. The battery holder opens.
2. Insert the battery while the positive (+) terminal faces down and press it firmly until you hear locking sound.
3. Place the battery holder to match its [⊖] mark with the [⊖] mark on the remote control, and turn the battery holder clockwise to fix it.

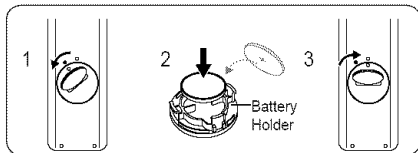

Precautions regarding the Lithium Battery

1. The Lithium Battery maintains the clock function and preset contents of the memory; even if the Battery Pack or AC Power adapter is removed.
2. The Lithium Battery for the DVD Camcorder lasts about 6 months under normal operation from time of installation.
3. When the Lithium Battery becomes weak or dead, the date/time indicator will display **12:00 AM JAN.01.2006** when you set the **Date/Time to On**. When this occurs, replace the Lithium Battery with a new one (type CR2025).
4. There is a danger of explosion if Lithium Battery is incorrectly replaced. Replace only with the same or equivalent type.

Warning: Keep the Lithium Battery out of reach of children. Should a battery be swallowed, consult a doctor immediately.

Preparation

Using the Lithium Ion Battery Pack

- ❖ Use SB-LSM80 or SB-LSM160 Battery Pack only.
- ❖ The Battery Pack may be charged a little at the time of purchase.

Charging the Lithium Ion Battery Pack

1. Turn the **[Power]** switch to **[Off]**.
2. Attach the Battery Pack to the DVD Camcorder.
3. Connect the AC Power Adapter to an AC Cord and connect the AC Cord to a wall socket.
4. Open the LCD Screen and Jack Cover.
5. Connect the DC cable to the DC IN jack on the DVD Camcorder.
The charging indicator will start to blink, showing that the Battery is charging.
6. When the Battery is fully charged, disconnect the Battery Pack and the AC Power Adapter from the DVD Camcorder. Even with the Power switched Off, the Battery Pack will still discharge.

Blinking time	Charging rate
Once per second	Less than 50%
Twice per second	50% ~ 75%
Three times per second	75% ~ 90%
Blinking stops and stays on	90% ~ 100%
On for a second and off for a second	Error - Reset the Battery Pack and the DC Cable

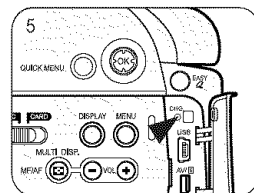
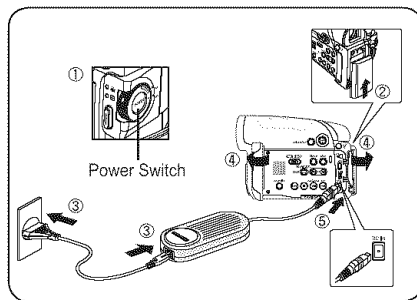

Preparation

Charging, Recording Times based on Battery Type

- If you close the LCD Screen, it switches off and the Viewfinder switches on automatically.
- The continuous recording times given in the table below are approximations.
Actual recording time depends on usage.
- The continuous recording times in the operating instructions are measured using a fully charged Battery Pack at 77 °F (25 °C).
- Even when the Power is switched Off, the Battery Pack will still discharge if it is left attached to the device.

Battery Type	SB-LSM80 (AD43-00136A)			SB-LSM160 (Option)		
Charging time	Approx. 1hr 20min			Approx. 3hr		
	Mode	Continuous recording time	Playback time	Mode	Continuous recording time	Playback time
LCD ON	XP	Approx. 55min	Approx. 1hr 10min	XP	Approx. 1hr 45min	Approx. 2hr 15min
Viewfinder						
LCD ON	SP	Approx. 1hr	Approx. 1hr 15min	SP	Approx. 1hr 55min	Approx. 2hr 25min
Viewfinder						
LCD ON	LP	Approx. 1hr 5min	Approx. 1hr 20min	LP	Approx. 2hr 5min	Approx. 2hr 35min
Viewfinder						

• Measured figures shown above are based on model SC-DC163.

The amount of continuous recording time available depends on;

- The type and capacity of the Battery Pack you are using.
- Ambient temperature.
- How often the Zoom function is used.
- Type of use (DVD Camcorder/Camera/With LCD Screen etc.).
It is recommended that you have several batteries available.

Preparation

Battery Level Display

The battery level display indicates the amount of power remaining in the Battery Pack.

- Fully charged
- 20~40% used
- 40~80% used
- 80~95% used
- Completely used (Blinking)
(The DVD Camcorder will turn off soon, change the battery as soon as possible.)

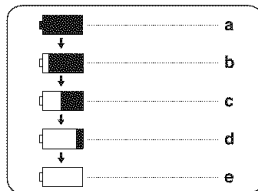

The Finalize/Format functions are not available at battery level 'd' and 'e'

- At battery level 'd'
Each time you select **Finalize/Format** from menu, the message of **<Please connect AC adapter>** will be displayed for 5 seconds.
- At battery level 'e'
The battery becomes low in capacity and the **<□>** indicator blinks on the display.
The screen will turn blue when the battery is almost completely discharged.

Battery Pack Management

- The Battery Pack should be recharged in an environment between 32 °F (0 °C) and 104 °F (40 °C).
- The Battery Pack should never be charged in a room with a temperature that is below 32 °F (0 °C).
- The life and capacity of the Battery Pack will be reduced if it is used in temperatures below 32 °F (0 °C) or left in temperatures above 104 °F (40 °C) for a long period of time, even when it is fully recharged.
- Do not put the Battery Pack near any heat source (i.e. fire or a heater).
- Do not disassemble, apply pressure to, or heat the Battery Pack.
- Do not allow the + and – terminals of the Battery Pack to be short-circuited. It may cause leakage, heat generation, induce overheating or fire.

Preparation

Maintaining the Battery Pack

- Please refer to the Table on page 22 for approximate continuous recording time.
- The recording time is affected by temperature and environmental conditions.
- The recording time shortens dramatically in a cold environment. As the environmental temperature and conditions vary. The continuous recording times in the operating instructions are measured using a fully charged Battery Pack at 77 °F (25 °C). The remaining battery time may differ from the approximate continuous recording times given in the instructions.
- We recommend only using the original Lithium Ion Battery Pack that is available from your SAMSUNG retailer. When the Battery reaches the end of its life, please contact your local dealer. The batteries have to be dealt with as chemical waste.
- Make sure that the Battery Pack is fully charged before starting to record.
- A brand new Battery Pack is not charged. Before using the Battery Pack, you need to charge it completely.
- Fully discharging a Lithium Ion Battery damages the internal cells. The Battery Pack may be prone to leakage when fully discharged.
- To preserve battery power, keep your DVD Camcorder turned off when you are not operating it.
- If your DVD Camcorder is in **Camera Mode**, and it is left in STBY mode without being operated for more than 5 minutes with a disc inserted, it will automatically turn itself off to protect against unnecessary battery discharge.
- Make sure that the Battery Pack is fitted firmly into place.
Do not drop the Battery Pack. Dropping the Battery Pack may damage it.

Preparation

Connecting a Power Source

- ❖ There are two types of power source that can be connected to your DVD Camcorder.
 - The AC Power adapter and AC Cord: used for indoor recording.
 - The Battery Pack: used for outdoor recording.

Using a Household Power Source

Connect to a household power source to use the DVD Camcorder without worrying about the battery power. You can keep the Battery Pack attached; the battery power will not be consumed.

1. Connect the AC Power adapter (AA-E8 Type) to the AC Cord.
2. Connect the AC Cord to a wall socket.
The plug and wall socket type may differ according to your resident country.
3. Open the LCD Screen and Jack Cover.
4. Connect the DC cable to the DC IN jack of the DVD Camcorder.
5. Set the DVD Camcorder to each mode by holding down the Green Tab on the **[Power]** switch and turning it to **[On]** or **[Off]**.

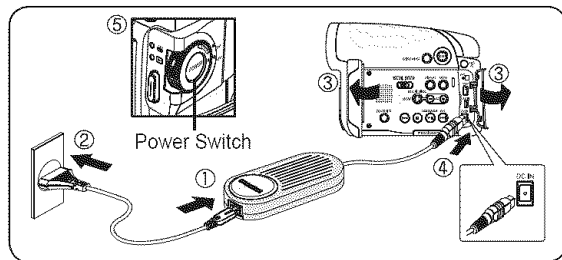

Preparation

About the Operating Modes

- ❖ The operating modes are determined by the position of the **[Power]** switch and the **[Mode]** switch.
- ❖ Set the Operation Mode by adjusting **[Power]** switch and **[Mode]** switch before operating any functions.
- ❖ Each time you move the **[Power]** switch downward, it toggles between **[CAMERA]** (Camera) and **[PLAYER]** (Player) mode.

Mode Name	<Camera Mode>	<Player Mode>	<M.Cam Mode>	<M.Player Mode>
[Power] Switch				
[Mode] Switch				

• M.Cam Mode : Memory Camera Mode / M.Player Mode : Memory Player Mode

Using the Joystick

- ❖ The Joystick is used to make a selection and to move the cursor left, right, up and down. Using the Joystick, you can easily make your selection and navigate the menu.
1. Move to a previous menu item / Adjust the selected item (to the left).
 2. Move to a sub menu item / Adjust the selected item (to the right).
 3. Move to a lower menu item.
 4. Move to an upper menu item.
 5. Press to select the chosen item.

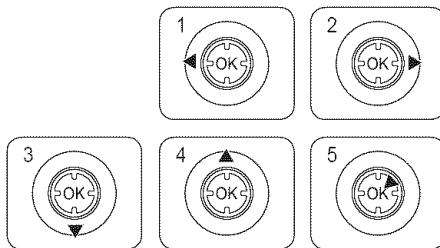

Preparation

Using the QUICK MENU

- ❖ QUICK MENU is used to access DVD Camcorder functions by using the [QUICK MENU] button.
- ❖ QUICK MENU provides easier access to frequently used menus without using the [MENU] button.

Functions available using the QUICK MENU are as below:

<Camera Mode>		DIS	↪ page 60
		Program AE	↪ page 53
<Player Mode>		White Balance	↪ page 55
		Digital Effect	↪ page 57
		Shutter	↪ page 51
		Exposure	↪ page 51
		Title List	
Playlist		Partial Delete	↪ page 71
		Protect	↪ page 69
		Title Name	↪ page 67
		Title Info	↪ page 68
		New Playlist	
<M.Cam Mode>		Delete	↪ page 76
		Edit Playlist	↪ pages 77~81
		Playlist Name	↪ page 73
		Playlist Info	↪ page 75
<M.Player Mode>		White Balance	↪ page 55
		Photo Quality	↪ page 95
		Exposure	↪ page 51
<M.Player Mode>		Delete	↪ page 101
		Delete All (Thumbnail index only)	↪ page 102
		Protect	↪ page 100
		Print Mark	↪ page 107
		Format	↪ page 103

For example: Setting the White Balance

- Press the [QUICK MENU] button.
 - The quick menu list will appear.
- Move the [Joystick] up or down to select <White Balance>, then press the [Joystick(OK)].
- Move the [Joystick] up or down to select desired mode (Auto, Indoor, Outdoor, or Custom WB), then press the [Joystick(OK)].
- To exit, press the [QUICK MENU] button.

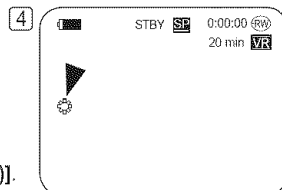
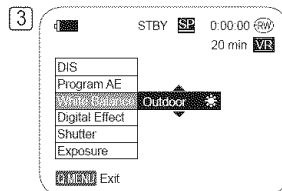
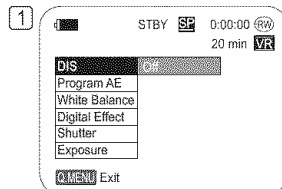

<When the White Balance option in Camera mode was selected.>

Preparation

OSD (On Screen Display) in Camera Mode/Player Mode

- | | |
|---|------------------------------|
| 1. Battery Level ↪ page 23 | 21. Record Mode ↪ page 42 |
| 2. Manual focus ↪ page 52 * | 22. Operating Mode |
| EASY.Q ↪ page 44 * | 23. Zoom Position ↪ page 45 |
| 3. DIS ↪ page 60 | 24. PB Zoom ↪ page 66 |
| 4. Program AE ↪ page 53 | 25. Message Line ↪ page 120 |
| 5. White Balance Mode ↪ page 55 | 26. Volume Control ↪ page 63 |
| 6. Digital Effects Mode ↪ page 57 | 27. AV IN ↪ page 88 * |
| 16:9 Wide ↪ page 59 | (SC-DC165 only) |
| 7. Shutter Speed ↪ page 51 * | 28. Playback Speed ↪ page 64 |
| 8. Exposure ↪ page 51 * | |
| 9. Date/Time ↪ page 37 | |
| 10. Color Nite ↪ pages 48~49 * | |
| 11. USB ↪ page 113 | |
| 12. Remote ↪ page 31 | |
| (SC-DC164/DC165 only) | |
| 13. Wind Cut ↪ page 50 | |
| 14. BLC (Back Light Compensation) ↪ page 47 | |
| 15. LED LIGHT ↪ page 49 | |
| (SC-DC165 only) | |
| 16. Title List Number | |
| 17. Disc Format ↪ page 84 | |
| 18. Disc Type | |
| 19. Counter | |
| 20. Remaining Time | |

Notes

- Functions not marked with * will be retained when the DVD Camcorder powered on after turning it off.
- OSD (On Screen Display) and printed names for each part of the DVD Camcorder are based on model SC-DC163.

OSD in Camera Mode

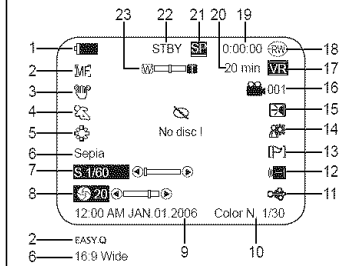

OSD in Player Mode

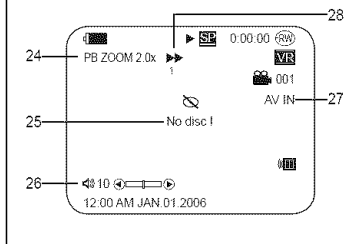

Preparation

OSD (On Screen Display) in M.Cam Mode/M.Player Mode

1. Photo Quality ↪ page 95
2. CARD (Memory Card) Indicator
3. Image Counter (Total number of recordable photo images)
4. Slide Show ↪ page 99
5. Erase Protection Indicator ↪ page 100
6. Print Mark ↪ page 107
7. Folder Number-File Number ↪ page 94
8. Image Counter (Current Image/ Total number of recorded images)

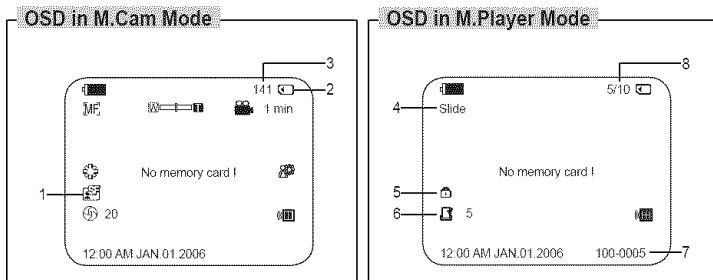

Turning the OSD (On Screen Display) On/Off

Turning OSD On/Off

Press the **[DISPLAY]** button on the left side control panel.

- Each press of the button toggles the OSD function on and off.

Turning the Date/Time On/Off

To turn the Date/Time on or off, access the menu and change the **Date/Time** mode. ↪ page 37

Initial Setting : System Menu Setting

Setting the Clock (Clock Set)

- ❖ Clock setup works in **Camera Mode/Player Mode/M.Cam Mode/M.Player Mode**. ↪ page 26
- ❖ The date/time is automatically recorded onto a disc. Before recording, please set the date/time.

1. Set the **[Mode]** switch to **[DISC]** or **[CARD]**.
2. Set the **[Power]** switch to **[CAMERA]** or **[PLAYER]**.
3. Press the **[MENU]** button.
 - The menu list will appear.
4. Move the **[Joystick]** up or down to select **<System>**, then press the **[Joystick(OK)]**.
5. Move the **[Joystick]** up or down to select **<Clock Set>**, then press the **[Joystick(OK)]**.
 - The month will highlight first.
6. Move the **[Joystick]** up or down to set current month, then press the **[Joystick(OK)]**.
 - The day will be highlighted.
7. You can set the day, year, hour, minute, and AM/PM following the same procedure after setting the month.
8. Press the **[Joystick(OK)]** after setting AM/PM.
 - A message **<Complete !>** is displayed.
 - To adjust the clock, select the Year, Month, Day, Hour, Min, or AM/PM by pressing the **[Joystick(OK)]**, then move the **[Joystick]** up or down to set respective values.
9. To exit, press the **[MENU]** button.

Notes

- After the Lithium Battery loses its charge (after about 6 months), the date/time appears on the screen as **12:00 AM JAN.01.2006**.
- You can set the year up to 2040.
- If the Lithium Battery is not installed, data inputted will not be backed up.

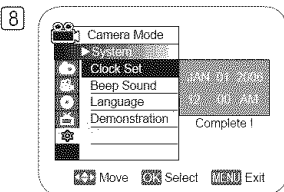
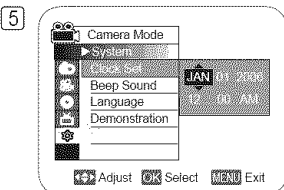
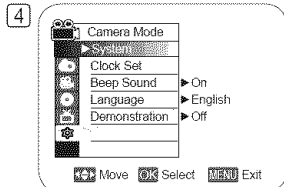

Initial Setting : System Menu Setting

Setting the Wireless Remote Control Acceptance (Remote) (SC-DC164/DC165 only)

- ❖ The **Remote** function works in **Camera Mode/Player Mode/M.Cam Mode/M.Player Mode**. ↪page 26
- ❖ The **Remote** function allows you to enable or disable the remote control for use with the DVD Camcorder.

1. Set the **[Mode]** switch to **[DISC]** or **[CARD]**.
2. Set the **[Power]** switch to **[CAMERA]** or **[PLAYER]**.
3. Press the **[MENU]** button.
 - The menu list will appear.
4. Move the **[Joystick]** up or down to select **<System>**, then press the **[Joystick(OK)]**.
5. Move the **[Joystick]** up or down to select **<Remote>**, then press the **[Joystick(OK)]**.
6. Move the **[Joystick]** up or down to select **<On>** or **<Off>**, then press the **[Joystick(OK)]**.
7. To exit, press the **[MENU]** button.

Note

If you set the **Remote** to **Off** in the menu and try to use it, the remote control icon (📡) will blink for 3 seconds on the LCD Screen and then disappear.

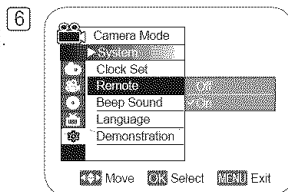
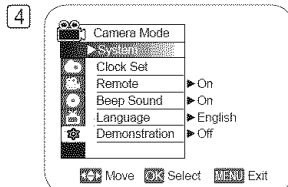

Initial Setting : System Menu Setting

Setting the Beep Sound (Beep Sound)

- ❖ The **Beep Sound** function works in **Camera Mode/Player Mode/M.Cam Mode/M.Player Mode**. →page 26
- ❖ You can turn the **Beep Sound** on or off, when on, each press of a button sounds a beep.

1. Set the **[Mode]** switch to **[DISC]** or **[CARD]**.
2. Set the **[Power]** switch to **[CAMERA]** or **[PLAYER]**.
3. Press the **[MENU]** button.
 - The menu list will appear.
4. Move the **[Joystick]** up or down to select **<System>**, then press the **[Joystick(OK)]**.
5. Move the **[Joystick]** up or down to select **<Beep Sound>**, then press the **[Joystick(OK)]**.
6. Move the **[Joystick]** up or down to select **<On>** or **<Off>**, then press the **[Joystick(OK)]**.
7. To exit, press the **[MENU]** button.

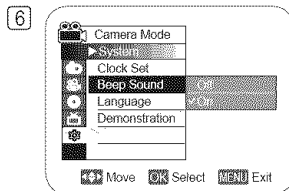
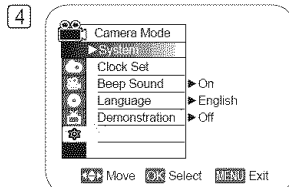

Initial Setting : System Menu Setting

Setting the Shutter Sound (Shutter Sound)

- ❖ The **Shutter Sound** function works only in **M.Cam Mode**. →page 26
- ❖ You can turn the **Shutter Sound** on or off, when on, with each press of the **[PHOTO]** button the Shutter will sound.

1. Set the **[Mode]** switch to **[CARD]**.
2. Set the **[Power]** switch to **[CAMERA (Camera)]**.
3. Press the **[MENU]** button.
 - The menu list will appear.
4. Move the **[Joystick]** up or down to select **<System>**, then press the **[Joystick(OK)]**.
5. Move the **[Joystick]** up or down to select **<Shutter Sound>**, then press the **[Joystick(OK)]**.
6. Move the **[Joystick]** up or down to select **<On>** or **<Off>**, then press the **[Joystick(OK)]**.
7. To exit, press the **[MENU]** button.

Note

If **Beep Sound** is set to **Off**, you will not hear the shutter sound even if it is set to **On**.

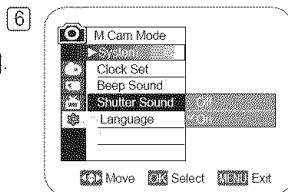
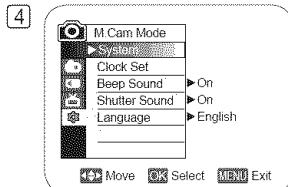

Initial Setting : System Menu Setting

Selecting the OSD Language (Language)

- ❖ The **Language** function works in **Camera Mode/Player Mode/M.Cam Mode/M.Player Mode**. ↪page 26
 - ❖ You can select the desired language to display the menu screen and the messages.
1. Set the **[Mode]** switch to **[DISC]** or **[CARD]**.
 2. Set the **[Power]** switch to **[CAMERA]** or **[PLAYER]**.
 3. Press the **[MENU]** button.
 - The menu list will appear.
 4. Move the **[Joystick]** up or down to select **<System>**, then press the **[Joystick(OK)]**.
 5. Move the **[Joystick]** up or down to select **<Language>**, then press the **[Joystick(OK)]**.
 - The available language options are listed.
 6. Move the **[Joystick]** up or down to select desired OSD language, then press the **[Joystick(OK)]**.
 - The OSD language is refreshed in the selected language.
 7. To exit, press the **[MENU]** button.

Note

The word **Language** in the menu is always indicated in English.

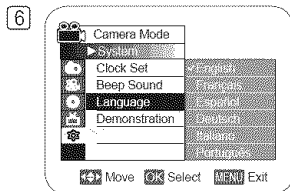
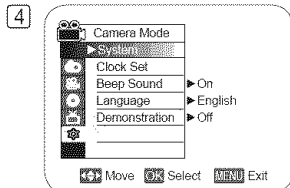

Initial Setting : System Menu Setting

Viewing the Demonstration (Demonstration)

- ❖ The **Demonstration** function may only be used in the **Camera Mode** with no disc inserted in the unit. ↪ page 26
- ❖ Before you begin: Make Sure that there is no disc inserted in the DVD Camcorder. ↪ page 40
- ❖ Demonstration automatically shows you the major functions that are included with your DVD Camcorder so that you may use them more easily.
- ❖ The Demonstration operates repeatedly until it is switched Off.

1. Set the **[Mode]** switch to **[DISC]**.
2. Set the **[Power]** switch to **[CAMERA (Camera)]**.
3. Press the **[MENU]** button.
 - The menu list will appear.
4. Move the **[Joystick]** up or down to select **<System>**, then press the **[Joystick(OK)]**.
5. Move the **[Joystick]** up or down to select **<Demonstration>**, then press the **[Joystick(OK)]**.
6. Move the **[Joystick]** up or down to select **<On>**, then press the **[Joystick(OK)]**.
7. Press the **[MENU]** button.
 - The Demonstration will begin.
8. To quit the Demonstration, press the **[MENU]** button.

Note

When you press FADE, BLC, EASY Q, MF/AF, or COLOR NITE button during the Demonstration operation, the operation will be deactivated and the function of the button pressed will be activated.

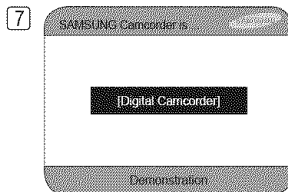
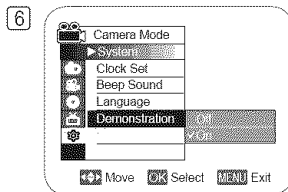
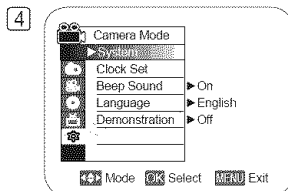

Initial Setting : Display Menu Setting

Adjusting the LCD Screen (LCD Bright/LCD Color)

- ❖ Adjusting the LCD Screen works in **Camera Mode/Player Mode/M.Cam Mode/M.Player Mode**. → page 26
- ❖ Your DVD Camcorder is equipped with a 2.5 inch (SC-DC163) / 2.7 inch wide (SC-DC164/DC165) color Liquid Crystal Display (LCD) Screen, which enables you to view what you are recording or playing back directly.
- ❖ Depending on the conditions under which you are using the DVD Camcorder (indoors or outdoors for example), you can adjust;
 - LCD Bright
 - LCD Color

1. Set the **[Mode]** switch to **[DISC]** or **[CARD]**.
2. Set the **[Power]** switch to **[CAMERA]** or **[PLAYER]**.
3. Press the **[MENU]** button.
 - The menu list will appear.
4. Move the **[Joystick]** up or down to select **<Display>**, then press the **[Joystick(OK)]**.
5. Move the **[Joystick]** up or down to select the item you want to adjust (**LCD Bright** or **LCD Color**), then press the **[Joystick(OK)]**.
6. Move the **[Joystick]** left or right to adjust the value of the selected item (**LCD Bright** or **LCD Color**), then press the **[Joystick(OK)]**.
 - You can set values for **<LCD Bright>** and **<LCD Color>** between **<00>** ~ **<35>**.
7. To exit, press the **[MENU]** button.
 - Adjusting the LCD Screen does not affect the brightness and color of the image to be recorded.

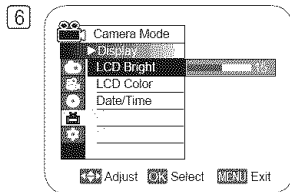
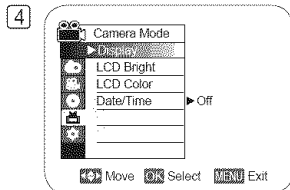

Initial Setting : Display Menu Setting

Displaying the Date/Time (Date/Time)

- ❖ The **Date/Time** function works in **Camera Mode/Player Mode/M.Cam Mode/M.Player Mode**. ↪page 26
- ❖ The date and time are automatically recorded on a special data area of the disc.

1. Set the **[Mode]** switch to **[DISC]** or **[CARD]**.
2. Set the **[Power]** switch to **[CAMERA]** or **[PLAYER]**.
3. Press the **[MENU]** button.
 - The menu list will appear.
4. Move the **[Joystick]** up or down to select **<Display>**, then press the **[Joystick(OK)]**.
5. Move the **[Joystick]** up or down to select **<Date/Time>**, then press the **[Joystick(OK)]**.
6. Move the **[Joystick]** up or down to select the display type of the Date/Time, then press the **[Joystick(OK)]**.
 - Display type of the Date/Time: **<Off>**, **<Date>**, **<Time>**, **<Date&Time>**.
7. To exit, press the **[MENU]** button.

Notes

- The Date/Time will read **12:00 AM JAN.01.2006** in the following conditions.
 - During playback of a blank section of a disc.
 - If the disc was recorded before setting the **Date/Time** in the DVD Camcorder.
 - When the Lithium Battery becomes weak or dead.
- Before you use the **Date/Time** function, you must set the clock. ↪page 30

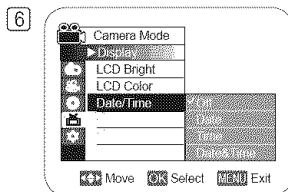
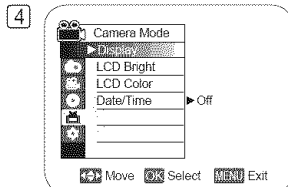

DVD Camcorder: Before Recording

Using the Viewfinder

❖ In the [📷(Camera)] or [▶(Player)] mode, the Viewfinder will work when the LCD Screen is closed.

Adjusting the Focus

The focus adjustment knob of the Viewfinder enables individuals with vision problems to see clearer images.

1. Close the LCD Screen and pull out the Viewfinder.
2. Use the Focus Adjustment Knob of the Viewfinder to focus the picture.

Note

Viewing the sun or any strong light source through the Viewfinder for a prolonged period may be harmful, or cause temporary impairment.

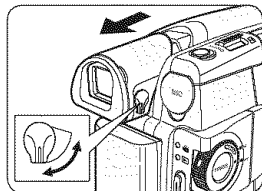

DVD Camcorder: Before Recording

Various Recording Techniques

❖ In some situations, different recording techniques may be required for more dramatic results.

1. **General recording.**
2. **Downward recording.**
Making a recording with a top view of the LCD Screen.
3. **Upward recording.**
Making a recording viewing the LCD Screen from below.
4. **Self recording.**
Making a recording viewing the LCD Screen from the front.
5. **Recording with the Viewfinder.**
In circumstances where it is difficult to use the LCD Screen, the Viewfinder can be used as a convenient alternative.

Note

Please rotate the LCD Screen carefully as excessive rotation may cause damage to the inside of the hinge that connects the LCD Screen to the DVD Camcorder.

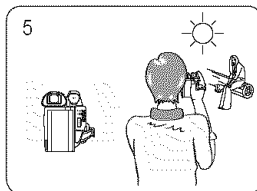
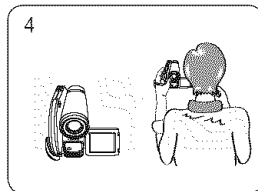
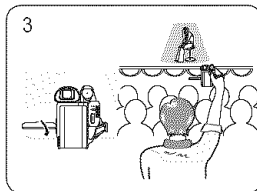
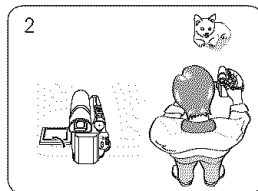
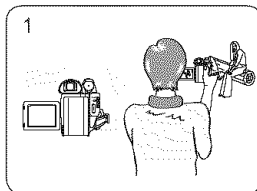

DVD Camcorder: Before Recording

Inserting and Removing a Disc

- ❖ When inserting a disc or closing the disc cover, do not apply excessive force. It may cause a malfunction.
- ❖ You cannot open the disc cover while loading.
- ❖ Set the **[Mode]** switch to **[DISC]** and the **[Power]** switch to **[CAMERA (Camera)]** to view menus and messages displayed on the LCD Screen.

Inserting a Disc

1. Push the **[OPEN]** switch in the direction of the arrow.
 - The cover of disc insertion block will open.
2. Gently open the cover by hand until it stops.
3. Push the disc against the turntable at the center to lock until a click is heard.
 - The recording side of the disc must face the inside of the DVD camcorder.
 - Do not touch the pickup lens.
4. Gently push the section marked **[PUSH CLOSE]** on the cover of the disc insertion block, to close the cover.
 - Once inserted, the disc is recognized with the **[ACCESS]** indicator blinking. Do not cut off the power supply during this time. Do not shake nor apply impact. It may cause a malfunction.

Notes

- Move the Hand Strap so it does not interfere with inserting or ejecting the disc.
- The disc cover can be opened when the device is connected to an AC power adapter or the battery pack, even if the power is off.

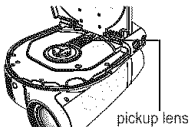
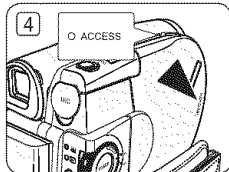
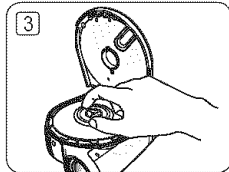
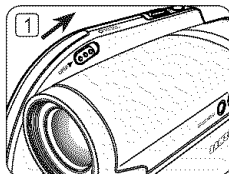

Caution

This product utilizes a laser. Use of controls or adjustments or performance of procedures other than those specified herein may result in hazardous radiation exposure. Do not open covers and do not look inside the product if interlock mechanism is damaged.

Warning

Be careful not to damage the interlock mechanism.

DVD Camcorder: Before Recording

When using a New Disc: Formatting a new Disc

Formatting may be required if a new disc is inserted. Recognition of the disc will start.

For a DVD-R/+R DL disc: Formatting will automatically begin.

For a DVD-RW disc: You are prompted with the **<Disc is not formatted. Format?>** message.

Differences between Video and VR mode	Video (Video Mode) : If the disc has been finalized, you will be able to play the disc on most DVD Players/Recorders.
	VR (VR Mode) : You can edit the disc on a DVD Camcorder, but playback is only possible on a DVD Recorder.

• Refer to page 12 for Finalized disc compatibility.

Move the **[Joystick]** left or right to select **<Video>** or **<VR>**, then press **[Joystick(OK)]**.

- Please refer to Page 11 for applications by mode.
- Upon completion, the **<Complete !>** message will appear.
- If you select **<Cancel>**, the **<Not formatted!>** warning message will appear. Formatting a new disc is required to record on it. To format later, use the **<Disc Manager>** menu. ↪page 84

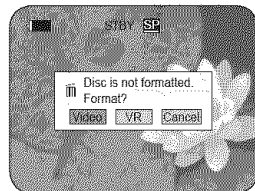

<When a DVD-RW disc is formatted.>

For a DVD+RW disc: You are prompted with the **<Disc format? All files will be deleted!>** message.

Move the **[Joystick]** left or right to select **<Yes>**, then press **[Joystick(OK)]**.

- Upon completion the **<Complete !>** message will appear.
- If you select **<No>**, the **<Not formatted!>** warning message will appear. Formatting a new disc is required to record on it. To format later, use the **<Disc Manager>** menu. ↪page 84

Removing a Disc

1. Push the **[OPEN]** switch in the direction of the arrow.
 - The cover of the disc compartment will open.
2. Gently open the cover by hand until it stops.
3. Remove the disc.
 - While pushing down the center portion of the turntable, pick up the disc by the edges to remove.
4. Gently push the section marked **[PUSH CLOSE]** on the cover of the disc insertion block, to close the cover.

DVD Camcorder: Before Recording

Selecting the Record Mode (Rec Mode)

- ❖ The Record Mode function works in both **Camera Mode** and **Player Mode**. →page 26
- ❖ This DVD Camcorder can film in the XP (extra play), the SP (standard play) and the LP (long play) modes. The SP mode is set as the factory default.

1. Set the **[Mode]** switch to **[DISC]**.
2. Set the **[Power]** switch to **[CAMERA (Camera)]** or **[PLAYER (Player)]**.
3. Press the **[MENU]** button.
 - The menu list will appear.
4. Move the **[Joystick]** up or down to select **<Record>**, then press the **[Joystick(OK)]**.
5. Move the **[Joystick]** up or down to select **<Rec Mode>**, then press the **[Joystick(OK)]**.
6. Move the **[Joystick]** up or down to select desired record mode (**XP**, **SP** or **LP**), then press the **[Joystick(OK)]**.
7. To exit, press the **[MENU]** button.
 - The icon of the selected mode is displayed.

Recording Times based on Disc Type

	DVD-RW/+RW/-R (1.4G)	DVD+R DL (2.6G)
XP	Approx. 20min	Approx. 35min
SP	Approx. 30min	Approx. 53min
LP	Approx. 60min	Approx. 106min

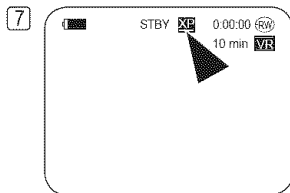
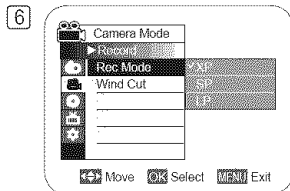
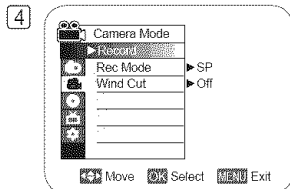

DVD Camcorder: Basic Recording

Making your First Recording

- Connect a power source to the DVD Camcorder. ↪ pages 21, 25
 - (A Battery Pack or a AC Power adapter)
 - Insert a disc. ↪ page 40
- Remove the Lens Cover.
- Open the LCD Screen
 - Set the **[Mode]** switch to **[DISC]**.
 - Set the **[Power]** switch to **[CAMERA]**.
Make sure that **<STBY>** is displayed.
 - Make sure the image you want to record appears on the LCD Screen or Viewfinder.
 - Make sure the Battery Level indicates that there is enough remaining power for your expected recording time.
- To start recording, press the **[Start/Stop]** button.
 - <REC>** is displayed on the LCD Screen.
The record mode, recording time, the disc type, the format mode and the title list number are displayed on the LCD Screen.
- To stop recording, press the **[Start/Stop]** button again.
 - <STBY>** is displayed on the LCD screen after blinking.
 - If you press the **[Start/Stop]** button to record again, a new Title List will be created.
The title list number will not appear in the STBY mode but in the REC mode.

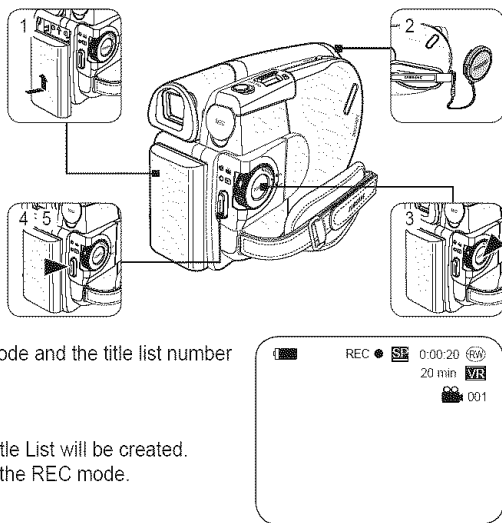

Notes

- Playing Title list ↪ page 63
- DVD-RW/-R discs can create up to 99 Title Lists, DVD+RW/+R DL discs can create up to 49 Title Lists.
- Detach the Battery Pack when you have finished recording to prevent unnecessary battery power consumption.
- If the power cable/batteries are disconnected, or recording is disabled during recording an error message will appear and the system is switched to the data recovery mode.
While data is being recovered, no other function is enabled. After data recovery, the system will be switched to the STBY mode.

DVD Camcorder: Basic Recording

Recording with Ease for Beginners (EASY.Q Mode)

- ❖ The EASY.Q function works only in **Camera Mode**. →page 26
 - ❖ The EASY.Q function allows a beginner to easily make good recordings.
1. Set the **[Mode]** switch to **[DISC]**.
 2. Set the **[Power]** switch to **[CAMERA (Camera)]**.
 3. By pressing the **[EASY.Q]** button, all functions on the DVD Camcorder will be set to off and the recording settings will be set to the following basic modes (DIS, AF(Auto Focus), AWB(Auto White Balance), AE(Auto Exposure) ON:
 - The word **<EASY.Q>** and DIS () appear on the display at the same time.
 4. Press the **[Start/Stop]** button to start recording.
 - Recording will begin using the basic automatic settings.
 5. Press the **[EASY.Q]** button again in the STBY mode to turn the EASY.Q mode off.
 - The EASY.Q function will not turn off while you are recording.
 - The DVD Camcorder will return to the settings that were set prior to activating EASY.Q mode.

Notes

- In EASY.Q mode, certain functions are not available, such as Menu, BLC, Manual focus, Color Nite. If you want to use these functions, you must first turn the EASY.Q mode off.
- The EASY.Q mode settings are deleted when the Battery Pack is removed from the DVD Camcorder and must be reset when the Battery Pack is replaced.

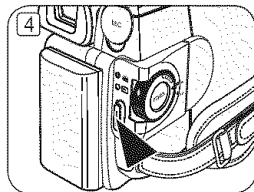
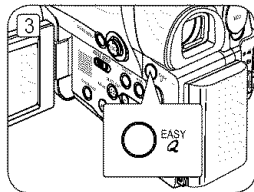

DVD Camcorder: Basic Recording

Using External Microphone

Connect external microphone (not supplied) to the external microphone jack of this DVD Camcorder. Clearer sound can be recorded.

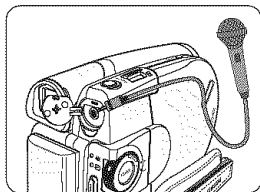

Zooming In and Out

- ❖ The Zoom function works in both **Camera Mode** and **M.Cam Mode**. ↪ page 26
 - ❖ Zooming is a recording technique that lets you change the size of the subject in a scene.
 - ❖ You can zoom using variable zoom speeds.
 - ❖ Use these features for different shots. Please note that over-use of the Zoom feature can lead to unprofessional looking results and a reduction of battery usage time.
1. Move the **[Zoom]** lever slightly for a gradual zoom, move it further for a high-speed zoom.
 - Your zooming is monitored on the OSD.
 2. **[T]** (Telephoto) side: Subject appears closer.
 3. **[W]** (Wide angle) side: Subject appears farther away.
 - You can record a subject that is about 10mm (about 0.5 inch) away from the lens surface in the Wide position.

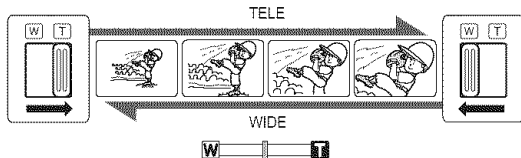

DVD Camcorder: Basic Recording

Using the Fade In and Out (FADE)

- ❖ The Fade function works only in **Camera Mode**. → page 26
- ❖ You can give your recording a professional look by using special effects such as fade in at the beginning of a sequence or fade out at the end of a sequence.

To Start Recording

1. Set the **[Mode]** switch to **[DISC]**.
2. Set the **[Power]** switch to **[CAMERA (Camera)]**.
3. Before recording, hold down the **[FADE]** button.
 - The picture and sound gradually disappear (fade out).
4. Press the **[Start/Stop]** button and at the same time release the **[FADE]** button.
 - Recording starts and the picture and sound gradually appear (fade in).

To Stop Recording

5. When you wish to stop recording, hold down the **[FADE]** button.
 - The picture and sound gradually disappear (fade out).
6. When the picture has disappeared, press the **[Start/Stop]** button to stop recording.

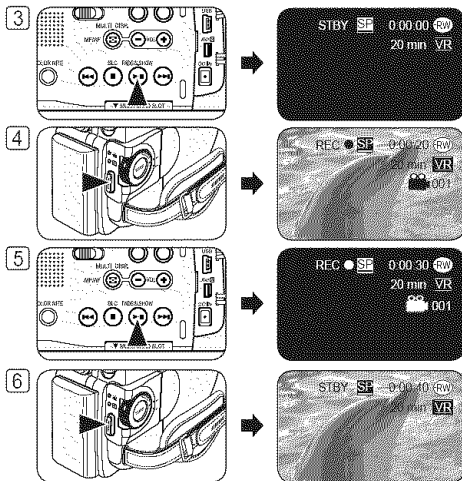

a. Fade Out (Approx. 4 seconds)

Hold down the **[FADE]** button

a. Fade Out

Gradual disappearance

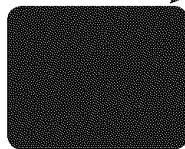
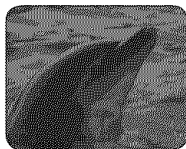
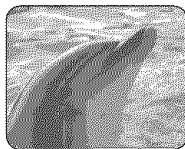

b. Fade In (Approx. 4 seconds)

Gradual appearance

b. Fade In

Release the **[FADE]** button

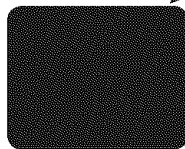
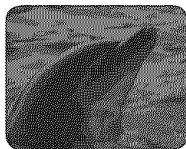
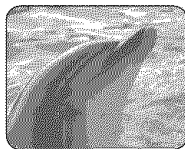

DVD Camcorder: Basic Recording

Using Back Light Compensation Mode (BLC)

- ❖ BLC works in both **Camera Mode** and **M.Cam Mode**. → page 26
- ❖ Back lighting exists when the subject is darker than the background:
 - The subject is in front of a window.
 - The person to be recorded is wearing white or shiny clothes and is placed against a bright background; the person's face is too dark to distinguish his/her features.
 - The subject is outdoors and the background is overcast.
 - The light sources are too bright.
 - The subject is against a snowy background.



<BLC Off>



<BLC On>

1. Set the **[Mode]** switch to **[DISC]** or **[CARD]**.
2. Set the **[Power]** switch to **[CAMERA]**.
3. Press the **[BLC]** button.
 - BLC icon (☀) is displayed.
4. To exit BLC mode, press the **[BLC]** button again.
 - Each press of the **[BLC]** button toggles: Normal → BLC → Normal.

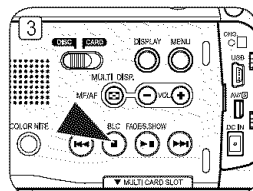

Note

The BLC function will not operate in EASY.Q mode.

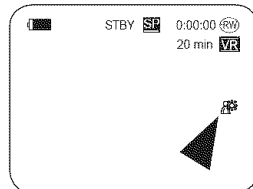

DVD Camcorder: Basic Recording

Using the Color Nite

- ❖ Color Nite function works only in **Camera Mode**. → page 26
- ❖ You can take a shot of an object in slow motion by controlling the shutter speed, or a brighter image in dark places without a compromise in colors.

1. Set the **[Mode]** switch to **[DISC]**.
2. Set the **[Power]** switch to **[CAMERA]**.
3. Press the **[COLOR NITE]** (SC-DC163/DC164 only) or **[C.NITE/LED LIGHT]** (SC-DC165 only) button.
4. Each time you press the **[COLOR NITE]** (SC-DC163/DC164 only) or **[C.NITE/LED LIGHT]** (SC-DC165 only) button, shutter speed is changed to;
 - ▶ <Color N. 1/30>, <Color N. 1/15> and off. (SC-DC163/DC164 only)
 - ▶ <Color N. 1/30>, <Color N. 1/15>, <Color N. 1/15(☒)> and off. (SC-DC165 only)

Notes

- When using the Color Nite, the image takes on a slow motion like effect.
- When using the Color Nite, the focus adjusts slowly and white dots may appear on the screen, this is not a defect.
- **Digital Zoom, Mosaic, Mirror, Emboss2, Pastel2 or 16:9 Wide** is not available in the Color Nite mode.
- If DIS or EASY.Q is set, Color Nite mode will be released.

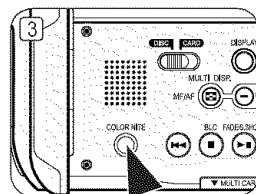

<SC-DC163/DC164 only>

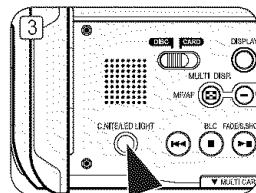

<SC-DC165 only>

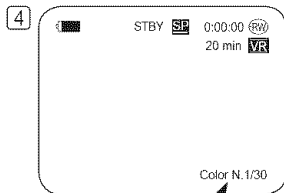

Color N. 1/30

DVD Camcorder: Basic Recording

Using the LED LIGHT (SC-DC165 only)

- ❖ The LED LIGHT function works only in **Camera Mode**. →page 26
- ❖ The LED LIGHT enables you to record a subject in dark places.
- ❖ The LED LIGHT can be used with Color Nite function only.

1. Set the **[Mode]** switch to **[DISC]**.
2. Set the **[Power]** switch to **[CAMERA (Camera)]**.
3. Press the **[C.NITE/LED LIGHT]** button until **<Color N. 1/15(☞)>** appears.

Danger

- The LED LIGHT can become extremely hot.
- Do not touch it while in operation or soon after turning it off, otherwise serious injury may result.
- Do not place the DVD Camcorder into the carrying case immediately after using the LED LIGHT, since it remains extremely hot for some time.
- Do not use near flammable or explosive materials.

Note

The range of the LED LIGHT is limited. (up to 6.6ft (2m))

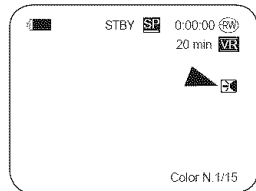
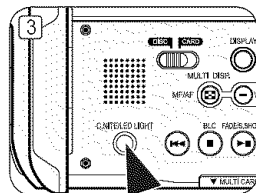

DVD Camcorder: Advanced Recording

Cutting Off Wind Noise (Wind Cut)

- ❖ The **Wind Cut** function works only in **Camera Mode**. → page 26
- ❖ Use the Wind Cut when recording in windy places such as the beach or near buildings.
- ❖ The Wind Cut function minimizes wind noise or other noise while recording.
 - When the Wind Cut is on, some low pitched tones are eliminated along with the sound of the wind.

1. Set the **[Mode]** switch to **[DISC]**.
2. Set the **[Power]** switch to **[CAMERA (Camera)]**.
3. Press the **[MENU]** button.
4. Move the **[Joystick]** up or down to select **<Record>**, then press the **[Joystick(OK)]**.
5. Move the **[Joystick]** up or down to select **<Wind Cut>**, then press the **[Joystick(OK)]**.
6. To activate the Wind Cut function, move the **[Joystick]** up or down to select **<On>**, then press the **[Joystick(OK)]**.
7. To exit, press the **[MENU]** button.
 - Wind Cut icon ([F]) is displayed.

Note

Make sure **Wind Cut** is set to **off** when you want the microphone to be as sensitive as possible.

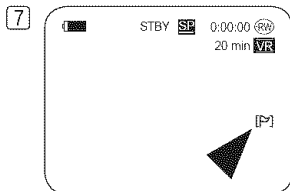
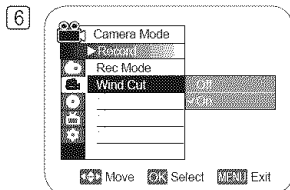
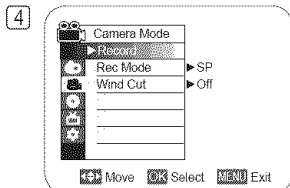

DVD Camcorder: Advanced Recording

Setting the Shutter Speed & Exposure (Shutter/Exposure)

- ❖ The Shutter Speed function works only in **Camera Mode**. ↪page 26
 - ❖ The Exposure function works in both **Camera Mode** and **M.Cam Mode**. ↪page 26
 - ❖ The Shutter Speed and Exposure functions can be set in the QUICK MENU.
1. Set the **[Mode]** switch to **[DISC]** or **[CARD]**.
 2. Set the **[Power]** switch to **[CAMERA]**.
 3. Press the **[QUICK MENU]** button.
 - QUICK MENU list will appear.
 4. Move the **[Joystick]** up or down to select **<Shutter>** or **<Exposure>**, then press the **[Joystick(OK)]**.
 5. Move the **[Joystick]** up or down to select **<Manual>**, then press the **[Joystick(OK)]**.
 6. Move the **[Joystick]** left or right to select desired shutter speed or exposure value, then press the **[Joystick(OK)]**.
 - Shutter speed can be set to **<1/60>**, **<1/100>**, **<1/250>**, **<1/500>**, **<1/1000>**, **<1/2000>**, **<1/4000>** or **<1/10000>**.
 - Exposure value can be set between **<00>** and **<29>**.
 7. To exit, press the **[QUICK MENU]** button.
 - Selected settings are displayed.

Recommended Shutter Speeds when Recording

- ❖ Outdoor sports such as golf or tennis: 1/2000 or 1/4000
- ❖ Moving cars or trains or other rapidly moving vehicles such as roller coasters: 1/1000, 1/500 or 1/250
- ❖ Indoor sports such as basketball: 1/100

Notes

- If you manually change the Shutter Speed and the Exposure value when **Program AE** option is selected, manual changes are applied first.
- The image may not seem as smooth when a high Shutter Speed is set.
- The DVD Camcorder returns to the auto shutter and auto exposure settings when you change to the EASY.Q mode.
- When recording with a Shutter Speed of 1/1000 or higher, make sure the sun is not shining into the lens.

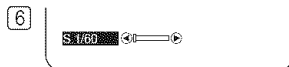
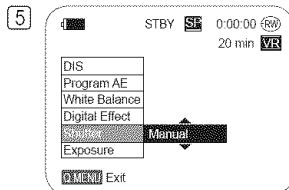
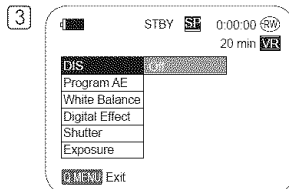

DVD Camcorder: Advanced Recording

Auto Focus / Manual Focus

- ❖ The Auto Focus/Manual Focus function works in both **Camera Mode** and **M.Cam Mode**. → page 26
- ❖ In most situations, it is better to use the automatic focus feature, as it enables you to concentrate on the creative side of your recording.
- ❖ Manual focusing may be necessary under certain conditions that make automatic focusing difficult or unreliable.

Auto Focus

- ❖ If you are inexperienced in the use of DVD Camcorders, we recommend that you use Auto Focus.

Manual Focus

- ❖ In the following situations, you may obtain better results by adjusting the focus manually.
 - A picture containing several objects, some close to the DVD Camcorder, others further away.
 - A person enveloped in fog or surrounded by snow.
 - Very shiny or glossy surfaces like a car.
 - People or objects moving constantly or quickly like an athlete or a crowd.
1. Set the **[Mode]** switch to **[DISC]** or **[CARD]**.
 2. Set the **[Power]** switch to **[CAMERA]**.
 3. Press the **[MF/AF]** button.
 - The manual focus icon (MF) will blink.
 4. Focus with the **[VOL-]** and **[VOL+]** buttons.
 - Pressing the **[VOL-]** button will focus on the foreground image while pressing the **[VOL+]** button will focus on the background image.

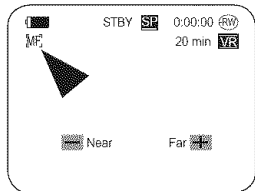
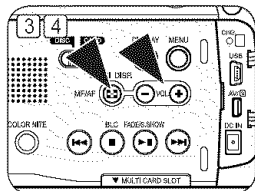
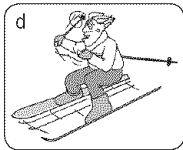
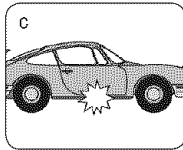
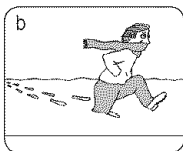
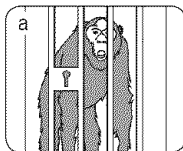

Note

Manual Focus is not available in the EASY.Q mode.

DVD Camcorder: Advanced Recording

Programmed Automatic Exposure Modes (Program AE)

- ❖ The **Program AE** function works only in **Camera Mode**. → page 26
 - ❖ The **Program AE** mode allows you to adjust shutter speeds and apertures to suit different recording conditions.
 - ❖ They give you creative control over the depth of field.
- **<Auto (A)> mode**
 - Auto balance between the subject and the background.
 - To be used in normal conditions.
 - The shutter speed automatically varies from 1/60 to 1/250 per second, depending on the scene.
 - **<Sports (S)> mode**
For recording people or objects moving quickly.
 - **<Portrait (P)> mode**
 - For focusing on the background of the subject, when the background is out of focus.
 - The Portrait mode is most effective when used outdoors.
 - The shutter speed automatically varies from 1/60 to 1/1000 per second.
 - **<Spotlight (L)> mode**
For recording correctly when there is only light on the subject and not the rest of the picture.
 - **<Sand/Snow (S/S)> mode**
For recording when people or objects are darker than the background because of reflected light from sand or snow.
 - **<High Speed (H)> (High Shutter Speed) mode**
For recording fast-moving subjects such as players in golf or tennis games.



DVD Camcorder: Advanced Recording

Setting the Program AE

1. Set the **[Mode]** switch to **[DISC]**.
2. Set the **[Power]** switch to **[CAMERA]** (Camera).
3. Press the **[MENU]** button.
 - The menu list will appear.
4. Move the **[Joystick]** up or down to select **<Camera>**, then press the **[Joystick(OK)]**.
5. Move the **[Joystick]** up or down to select **<Program AE>**, then press the **[Joystick(OK)]**.
 - The available options are listed.
6. Move the **[Joystick]** up or down to select desired program AE option, then press the **[Joystick(OK)]**.
7. To exit, press the **[MENU]** button.
 - The icon of the selected mode is displayed.
 - When the **<Auto>** mode is selected, no icon is displayed.



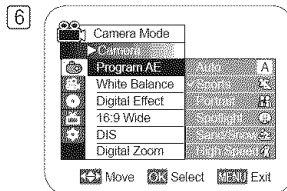
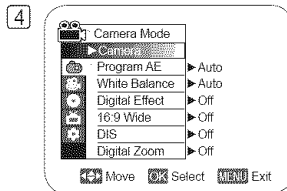

Notes

- Direct accessing the **Program AE** function is available simply using the **[QUICK MENU]** button. → page 27
- The **Program AE** function will not operate in EASY.Q mode



DVD Camcorder: Advanced Recording

Setting the White Balance (White Balance)

- ❖ The **White Balance** function works in both **Camera Mode** and **M.Cam Mode**. → page 26
- ❖ The **White Balance** is a recording function that preserves the unique image color of the subject in any recording condition.
- ❖ You may select the appropriate White Balance mode to obtain good quality image color.
 - **Auto** (): This mode is generally used to control the White Balance automatically.
 - **Indoor** (): This controls the White Balance according to indoor ambience.
 - Under halogen or studio/video lighting
 - Subject is of one dominant color
 - Close up
 - **Outdoor** (): This controls the White Balance according to the outdoor ambience.
 - In daylight, especially for close up and where the subject is of one dominant color.
 - **Custom WB** (): This controls the White Balance according to the recording environment.

1. Set the **[Mode]** switch to **[DISC]** or **[CARD]**.
2. Set the **[Power]** switch to **[ (Camera)]**.
3. Press the **[MENU]** button.
 - The menu list will appear.
4. Move the **[Joystick]** up or down to select **<Camera>**, then press the **[Joystick(OK)]**.
5. Move the **[Joystick]** up or down to select **<White Balance>**, then press the **[Joystick(OK)]**.
6. Move the **[Joystick]** up or down to select desired mode (**Auto**, **Indoor**, **Outdoor** or **Custom WB**), then press the **[Joystick(OK)]**.
 - Refer to page 56 for details on setting Custom WB.
7. To exit, press the **[MENU]** button.
 - The icon of the selected mode is displayed.
 - When the **<Auto>** mode is selected, no icon is displayed.

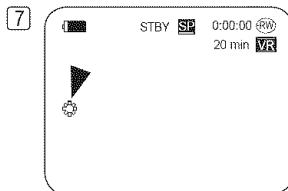
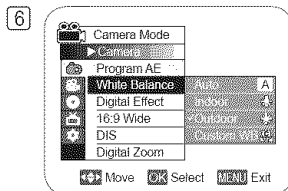
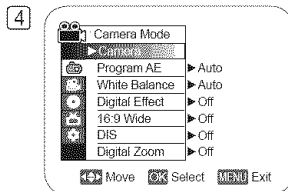

DVD Camcorder: Advanced Recording

Setting the Custom White Balance

❖ You can adjust the white balance as you wish based on the recording environment.

1. Set the **[Mode]** switch to **[DISC]** or **[CARD]**.
2. Set the **[Power]** switch to **[CAMERA]**.
3. Press the **[MENU]** button.
 - The menu list will appear.
4. Move the **[Joystick]** up or down to select **<Camera>**, then press the **[Joystick(OK)]**.
5. Move the **[Joystick]** up or down to select **<White Balance>**, then press the **[Joystick(OK)]**.
6. Move the **[Joystick]** up or down to select **<Custom WB>**, then press the **[Joystick(OK)]**.
 - The **<Set White Balance>** will blink.
7. Place the white object under the desired lighting, then press the **[Joystick(OK)]** button.
 - The **<Set White Balance>** will disappear and the white balance setting will commence.
8. To exit, press the **[MENU]** button.
 - Custom WB icon () is displayed.

Notes

- You can directly access the **White Balance** function by using the **[QUICK MENU]** button.
 - ↳ page 27
- The **White Balance** function will not operate in EASY.Q mode.
- Turn the **Digital Zoom** off (if necessary) to set a more accurate white balance.
- Reset the white balance if lighting conditions change.
- During normal outdoor recording, setting to Auto may provide better results.

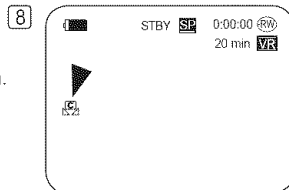
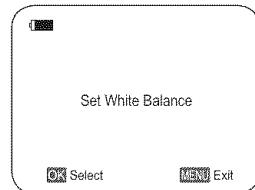
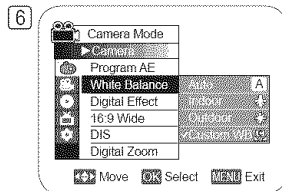

DVD Camcorder: Advanced Recording

Applying Digital Effects (Digital Effect)

- ❖ The **Digital Effect** function works only in **Camera Mode**. →page 26
- ❖ The Digital Effects enable you to give a creative look to your recording.
- ❖ Select the appropriate Digital Effect for the type of picture that you wish to record and the effect you wish to create.
- ❖ There are 10 Digital Effect modes.

1. **<Art> mode**

This mode gives the images a coarse effect.

2. **<Mosaic> mode**

This mode gives the images a mosaic effect.

3. **<Sepia> mode**

This mode gives the images a reddish-brown pigment.

4. **<Negative> mode**

This mode reverses the colors, creating a negative image.

5. **<Mirror> mode**

This mode cuts the picture in half, using a mirror effect.

6. **<BLK & WHT> mode**

This mode changes the images to black and white.

7. **<Emboss1> mode**

This mode creates a 3D effect (embossing).

8. **<Emboss2> mode**

This mode creates a 3D effect (embossing) on surrounding area of an image.

9. **<Pastel1> mode**

This mode applies a pale pastel drawing effect to an image.

10. **<Pastel2> mode**

This mode applies a pale pastel drawing effect to surrounding area of an image.

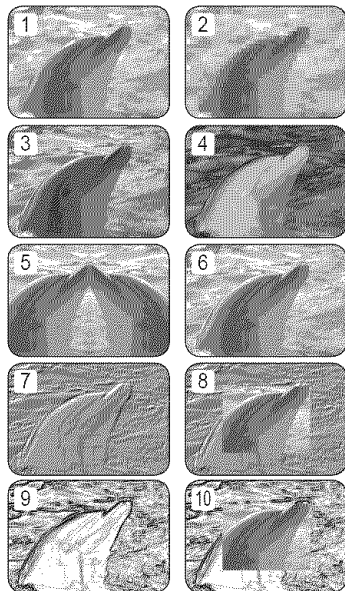

DVD Camcorder: Advanced Recording

Selecting the Digital Effects

1. Set the [Mode] switch to [DISC].
2. Set the [Power] switch to [CAMERA (Camera)].
3. Press the [MENU] button.
 - The menu list will appear.
4. Move the [Joystick] up or down to select <Camera>, then press the [Joystick(OK)].
5. Move the [Joystick] up or down to select <Digital Effect>, then press the [Joystick(OK)].
6. Move the [Joystick] up or down to select the desired Digital Effect option, then press the [Joystick(OK)].
 - The display mode is set to the selected mode.
7. To exit, press the [MENU] button.

Notes

- You can directly access the **Digital Effect** function by using the [QUICK MENU] button.
↳ page 27
- The **Mosaic**, **Mirror**, **Emboss2**, or **Pastel2** mode is not available while **DIS** or **Color Nite** is in use.
- Digital Effect modes are not available while **EASY.Q** is in use.
- Once **DIS**, **EASY.Q**, **Color Nite**, or **16:9 Wide** is set, **Mosaic**, **Mirror**, **Emboss2**, or **Pastel2** mode will be released.
- **Digital Zoom** is not available in the **Mosaic**, **Mirror**, **Emboss2**, or **Pastel2** mode.

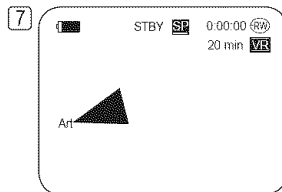
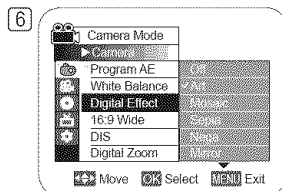
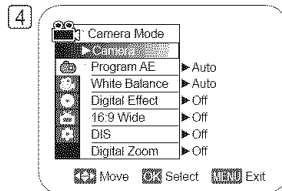

DVD Camcorder: Advanced Recording

Setting the 16:9 Wide mode (16:9 Wide)

- ❖ The **16:9 Wide** function works only in **Camera Mode**. ↪ page 26
 - ❖ Select to record a picture to be played back on a 16:9 Wide TV.
1. Set the **[Mode]** switch to **[DISC]**.
 2. Set the **[Power]** switch to **[CAMERA (Camera)]**.
 3. Press the **[MENU]** button.
 - The menu list will appear.
 4. Move the **[Joystick]** up or down to select **<Camera>**, then press the **[Joystick(OK)]**.
 5. Move the **[Joystick]** up or down to select **<16:9 Wide>**, then press the **[Joystick(OK)]**.
 6. To activate the 16:9 Wide function, move the **[Joystick]** up or down to select **<On>**, then press the **[Joystick(OK)]**.
 - If you do not want to use the 16:9 Wide function, set the **<16:9 Wide>** menu to **<Off>**.
 7. To exit, press the **[MENU]** button.
 - The display mode is set to the selected mode.

Notes

- The **16:9 Wide** mode is not available while **DIS**, **EASY.Q** or **Color Nite** is in use.
- Once **DIS**, **EASY.Q** or **Color Nite** is set, **16:9 Wide** mode will be released.
- **Digital Zoom** is not available in the **16:9 Wide** mode.

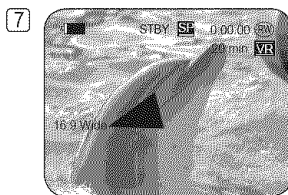
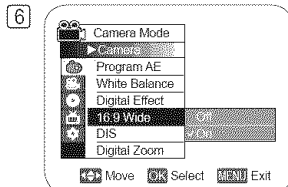

DVD Camcorder: Advanced Recording

Setting the Digital Image Stabilizer (DIS)

- ❖ The **DIS** function works only in **Camera Mode**. ↪ page 26
 - ❖ DIS (Digital Image Stabilizer) is a function that compensates for any shaking or hand movement while holding the DVD Camcorder (within reasonable limits).
 - ❖ It provides more stable pictures when:
 - Recording with the zoom (If the **DIS** is set, **Digital Zoom** mode will be released.)
 - Recording a small object close-up
 - Recording and walking at the same time
 - Recording through the window of a vehicle
1. Set the **[Mode]** switch to **[DISC]**.
 2. Set the **[Power]** switch to **[CAMERA (Camera)]**.
 3. Press the **[MENU]** button.
 - The menu list will appear.
 4. Move the **[Joystick]** up or down to select **<Camera>**, then press the **[Joystick(OK)]**.
 5. Move the **[Joystick]** up or down to select **<DIS>**, then press the **[Joystick(OK)]**.
 6. To activate the DIS function, move the **[Joystick]** up or down to select **<On>**, then press the **[Joystick(OK)]**.
 - If you do not want to use the DIS function, set the **<DIS>** menu to **<Off>**.
 7. To exit, press the **[MENU]** button.
 - DIS icon () is displayed.

Notes

- You can directly access the DIS function by using the **[QUICK MENU]** button. ↪ page 27
- **Digital Zoom**, **Color Nite**, **16:9 Wide**, **Mosaic**, **Mirror**, **Emboss2**, or **Pastel2** is not available in the **DIS** mode.
- It is recommended that you deactivate the **DIS** function when using a tripod.
- If you use the **DIS** function, the picture quality may deteriorate.
- **EASY.Q** mode automatically sets the **DIS** to **On**.

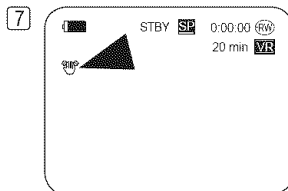
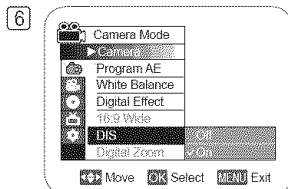
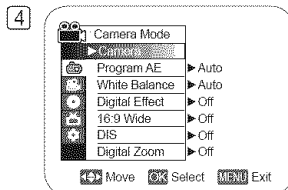

DVD Camcorder: Advanced Recording

Zooming In and Out with Digital Zoom (Digital Zoom)

- ❖ The **Digital Zoom** works only in **Camera Mode**. ↪ page 26
- ❖ Zooming more than 30x (SC-DC163 only), 33x (SC-DC164/DC165 only) is achieved digitally, up to 1200x when combined with optical zoom.
- ❖ The picture quality may deteriorate depending on how much you zoom in on the subject.

Selecting the Digital Zoom

1. Set the **[Mode]** switch to **[DISC]**.
2. Set the **[Power]** switch to **[CAMERA (Camera)]**.
3. Press the **[MENU]** button.
 - The menu list will appear.
4. Move the **[Joystick]** up or down to select **<Camera>**, then press the **[Joystick(OK)]**.
5. Move the **[Joystick]** up or down to select **<Digital Zoom>**, then press the **[Joystick(OK)]**.
6. Move the **[Joystick]** up or down to select desired zoom value (**Off**, **100x**, **200x**, **400x** or **1200x**), then press the **[Joystick(OK)]**.
7. To exit, press the **[MENU]** button.
 - When using the digital zoom switch, an indicator appears on the screen.

Notes

- Maximum zooming may result in lower picture quality.
- **Digital Zoom** is not available while **DIS**, **EASY.Q**, **Color Nite**, **16:9 Wide**, **Mosaic**, **Mirror**, **Emboss2**, or **Pastel2** is in use.
- Once **Color Nite**, **16:9 Wide**, **Mosaic**, **Mirror**, **Emboss2**, or **Pastel2** is set, **Digital Zoom** mode will be released. (The **Digital Zoom** mode will be backed up.)
- Once **DIS** or **EASY.Q** is set, **Digital Zoom** mode will be released.

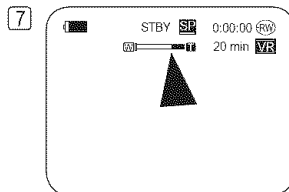
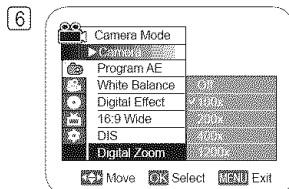
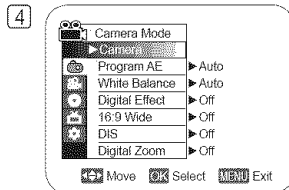

DVD Camcorder: What's Title List and Playlist

What's a Title List?

- ❖ The Title List displays multiple titles (scenes) that have been recorded.
- ❖ A title is created between the points where you start and stop a recording. Once deleted, you cannot recover the title again.

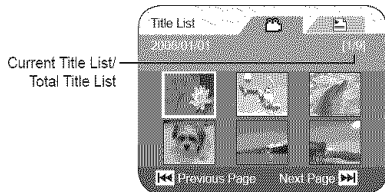

What's a Playlist? DVD-RW(VR mode)

- ❖ You can create a Playlist on the same disc by gathering your favorite scene from the recorded titles (title lists). You can edit the Playlist without changing the original recordings.
- ❖ Even if the Playlist is deleted, the original title lists remain undeleted.
- ❖ Up to 199 playlists can be created, and up to 999 title scenes can be registered on a Playlist.

Example: You have recorded a few scenes on a DVD-RW in VR mode. You want to save the original recording, but you also want to create a digest by putting your favorite scenes together. In this case, you can create a Playlist by selecting your favorite scenes, leaving the original recording as it is.

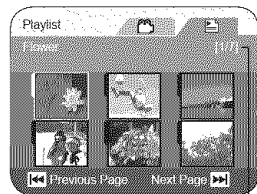

- ❖ A title is created between the points where you start and stop a recording. Once deleted you cannot recover the title again.

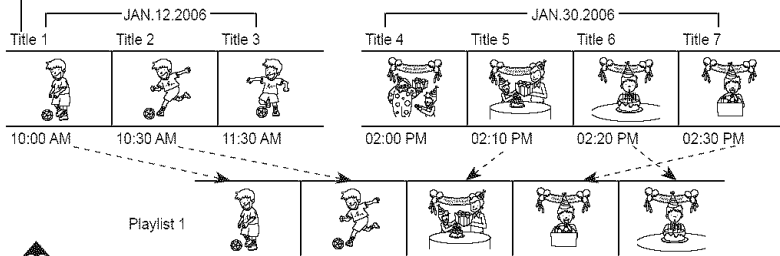

DVD Camcorder: Title List

Playing Title Lists **DVD-RW/+RW/-R/+R DL**

The recorded Title List scenes are displayed as a thumbnail index (multiple images) on the LCD Screen.

You can find the desired scene quickly using this convenient index. If the LCD is closed, you can view the recording through the viewfinder. Use the Playback related buttons on the DVD Camcorder or on the remote control. ↪ page 64

1. Insert the disc you want to view.
2. Open the LCD Screen.
3. Set the **[Mode]** switch to **[DISC]**.
4. Set the **[Power]** switch to **[▶(Player)]**.
 - The thumbnail index of the Title List will appear.
 - Use the **[MENU]** button to adjust brightness or color of the LCD Screen. ↪ page 36
5. Use the **[Joystick]** to select a Title List scene to be played, then press the **[Joystick(OK)]** or **[▶ II]** button.
 - To stop playback, press the **[■(Stop)]** button.

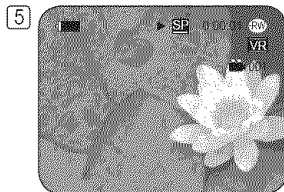

Adjusting the Volume **DVD-RW/+RW/-R/+R DL**

- ❖ When you use the LCD Screen for playback, you can hear recorded sound from the built-in speaker.
- ❖ When you hear sound once the disc is in play, use the **[VOL -,+]** buttons to adjust the volume.
 - A volume level display will appear on the LCD Screen.
 - Levels may be adjusted from anywhere between **00** to **19**.
 - If you close the LCD Screen while playing, you will not hear sound from the speaker.

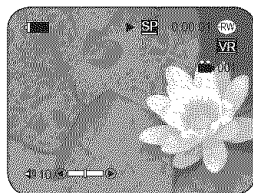

DVD Camcorder: Title List

Various Functions while in Player Mode **DVD-RW/+RW-R/+R DL**

- ❖ These functions work only in **Player Mode**. → page 26
- ❖ Play, Still, Stop, Fast Forward, Rewind, Forward Skip, and Reverse Skip functions are accessible using the remote control. (SC-DC164/DC165 only)
- ❖ Slow function is accessible only using the remote control. (SC-DC164/DC165 only)

Playback/Still

- Press the [▶||] button to pause during playback.
- To resume playback, press the [▶||] button.

Picture Search (Forward/Reverse)

- Pressing the [◀◀]/[▶▶] button once makes the play speed to approx x2, and pressing twice plays at approx x16.
- When the number 1 appears on the OSD, it means X2 speed. Number 2 = X16.
- To resume normal playback, press the [▶||] button.
- Same as [◀◀]/[▶▶] buttons on the remote control.

Skip Playback (Forward/Reverse)

- Press and hold the [◀◀]/[▶▶] buttons during playback.
- When playing a disc, if you press and hold the [▶▶] button, it moves to the next scene. If you press and hold the [◀◀] button, it moves to the beginning of the scene. One more press and hold makes it move to the beginning of the previous scene. If you press and hold the [◀◀] button at a portion 3 seconds from the start of scene, it moves to the beginning of the previous scene.

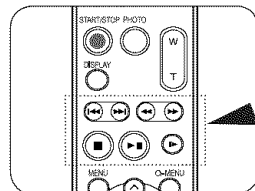
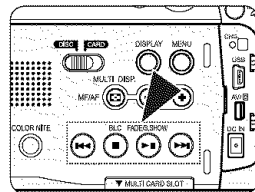
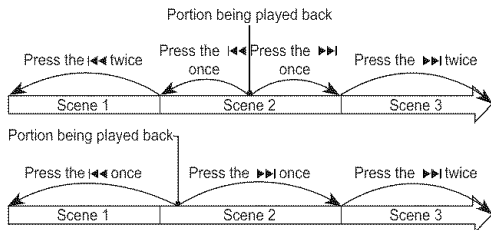

DVD Camcorder: Title List

Slow Playback (Forward/Reverse) (SC-DC164/DC165 only)

Forward Slow Playback

- Press the [▶] button on the remote control during playback.
 - To resume normal playback, press the [▶||] button.

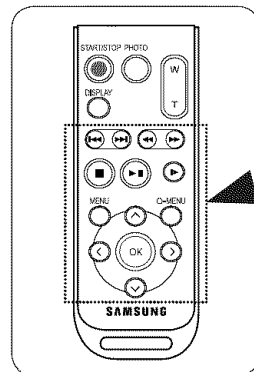

DVD Camcorder: Title List

Zooming during Playback (PB ZOOM) DVD-RW/+RW/R/+R DL

- ❖ The **PB Zoom** function works only in **Player Mode**. ↪ page 26
 - ❖ The **PB Zoom** function enables you to magnify the playback.
1. Set the **[Mode]** switch to **[DISC]**.
 2. Set the **[Power]** switch to **[▶(Player)]**.
 3. Move the **[Zoom]** lever toward **[T(Tele)]** to activate the PB Zoom during playback.
 - The image is magnified starting from the center of image.
 4. You can zoom in from 2.0x to 8.0x by moving the **[Zoom]** lever.
 - It zooms 2.0x → 4.0x → 8.0x progressively.
 - Zoom ratio is displayed.
 5. Use the **[Joystick]** to move the screen up, down, right or left.
 6. To cancel the PB Zoom function, move the **[Zoom]** lever toward **[W(Wide)]**.

Notes

- You cannot apply the **PB Zoom** function to pictures which are being input from an external video source.
- The **PB Zoom** images cannot be exported to a PC.
- To stop operating PB Zoom function, press the **[■(Stop)]** button.

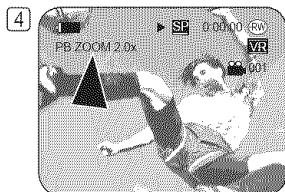
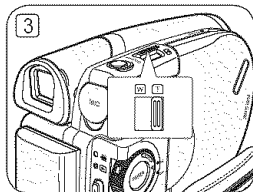

DVD Camcorder: Title List

Renaming a Title (Title Name) DVD-RW/+RW-R/+R DL

- ❖ **Title Name** function works only in **Player Mode**. ↪page 26
 - ❖ The recording date automatically becomes the title name if date had been set in the system menu. ↪page 37
You can change the recording date to any desired title name.
1. Set the **[Mode]** switch to **[DISC]**.
 2. Set the **[Power]** switch to **[▶(Player)]**.
 - The Title List screen appears.
 3. Press the **[QUICK MENU]** button.
 4. Move the **[Joystick]** up or down to select **<Title Name>**, then press the **[Joystick(OK)]**.
 5. Use the **[Joystick]** to select a title scene you want to rename from the Title List scenes, then press the **[Joystick(OK)]**.
 - Title Name screen will appear.
 6. Use the **[Joystick]** to move the cursor to the first character of the current title name.
 7. Use the **[Joystick]** to move the cursor to **<Delete>**, then press the **[Joystick(OK)]** to delete the existing title name.
 8. Use the **[Joystick]** to select the desired characters and items, then press the **[Joystick(OK)]**.
 - **<Delete>**: Deletes the character at the cursor position.
 - **<Space>**: Enter a blank and moves the cursor one forward (to the right).
 - **<Done>**: Registers the character inputs.
 - **<Back>**: Returns to the previous mode.
 9. Use the **[Joystick]** to select **<Done>**, then press the **[Joystick(OK)]**.
 - The title name is now changed.
 - Use the **[Joystick]** to select **<Back>**, then press the **[Joystick(OK)]** to return to Title List.

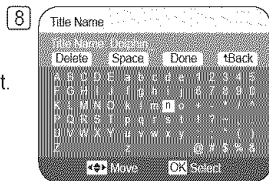
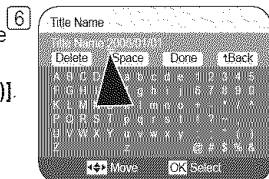
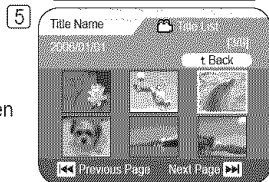
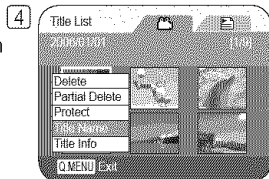

DVD Camcorder: Title List

Title Information (Title Info) DVD-RW/+RW-R/+R DL

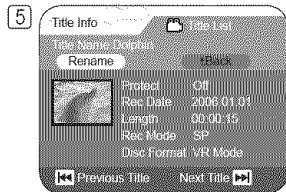

- ❖ **Title Info** function works only in **Player Mode**. ↪ page 26
- ❖ It shows you the title information.
- ❖ You can view the **Title name**, **Protect**, **Rec Date**, **Length**, **Rec Mode** and **Disc Format**.

1. Set the **[Mode]** switch to **[DISC]**.
2. Set the **[Power]** switch to **[▶](Player)**.
 - The Title List screen appears.
3. Press the **[QUICK MENU]** button.
4. Move the **[Joystick]** up or down to select **<Title Info>**, then press the **[Joystick(OK)]**.
5. Use the **[Joystick]** to select a scene you want to display the title information from the Title List scenes, then press the **[Joystick(OK)]**.
 - It shows the information on the selected title.
 - The title information includes the **<Title Name>**, **<Protect>**, **<Rec Date>**, **<Length>**, **<Rec Mode>** and **<Disc Format>**.
6. To exit, press the **[Joystick(OK)]**.
 - Use the **[Joystick]** to select **<Back>**, then press the **[Joystick(OK)]** to return to Title List.



DVD Camcorder: Title List

Protecting a Title (Protect) DVD-RW/+RW/+R DL

- ❖ **Protect** function works only in **Player Mode**. ↪ page 26
 - ❖ You can set protection for a title so that the title cannot be deleted.
1. Set the **[Mode]** switch to **[DISC]**.
 2. Set the **[Power]** switch to **[▶(Player)]**.
 - The Title List screen appears.
 3. Press the **[QUICK MENU]** button.
 4. Move the **[Joystick]** up or down to select **<Protect>**, then press the **[Joystick(OK)]**.
 5. Move the **[Joystick]** up or down to select **<Select>** or **<Select All>**, then press the **[Joystick(OK)]**.
 - **Select**: Protects individual files
To protect individual files, use the **[Joystick]** to select files to protect, then press the **[Joystick(OK)]**.
The selected files will be marked with .
 - **Select All**: Protects all files
To protect all files, simply press the **[Joystick(OK)]** after **<Select All>** is selected.
All files will be marked with .
 6. Move the **[Joystick]** up to select **<Execute>**, then press the **[Joystick(OK)]**.
 - Protect is set on all selected titles.
 - The above procedure will release the lock on the title if previously set.

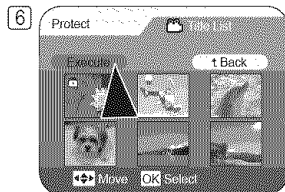
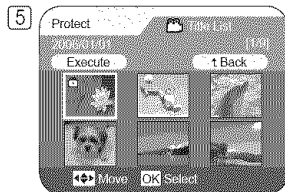

DVD Camcorder: Title List

Deleting a Title (Delete) DVD-RW/+RW/+R DL

- ❖ Delete function works only in **Player Mode**. →page 26
 - ❖ Individual or All Title scenes can be deleted.
1. Set the **[Mode]** switch to **[DISC]**.
 2. Set the **[Power]** switch to **[▶(Player)]**.
 - The Title List screen appears.
 3. Press the **[QUICK MENU]** button.
 4. Move the **[Joystick]** up or down to select **<Delete>**, then press the **[Joystick(OK)]**.
 5. Move the **[Joystick]** up or down to select **<Select>** or **<Select All>**, then press the **[Joystick(OK)]**.
 - **Select:** Delete individual files
To delete individual files, use the **[Joystick]** to select files to delete, then press the **[Joystick(OK)]**.
The selected files will be marked <☒>.
 - **Select All:** Delete all files
To delete all files, simply press the **[Joystick(OK)]** after **<Select All>** is selected.
All files will be marked with <☒>.
 6. Move the **[Joystick]** up to select **<Execute>**, then press the **[Joystick(OK)]**.
 - The **<Delete?>** message will appear.
 7. Move the **[Joystick]** left or right to select **<Yes>**, then press the **[Joystick(OK)]**.
 - All selected titles will be deleted.
 - Related files in Playlist will be deleted. (DVD-RW(VR mode only))

Note

An audible warning will be heard if you try to delete a title that had previously been protected. You must release the protect function to delete the title. →page 69

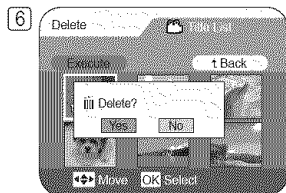

DVD Camcorder: Title List

Deleting a Section of a Title (Partial Delete) DVD-RW(VR mode)

- ❖ **Partial Delete** function works only in **Player Mode**. ↪ page 26
 - ❖ A Title scene can be partially deleted.
 - ❖ The editing function only works on a DVD-RW (VR Mode).
You should format the DVD-RW to VR Mode before recording. ↪ page 41
1. Set the **[Mode]** switch to **[DISC]**.
 2. Set the **[Power]** switch to **[▶(Player)]**.
 3. Press the **[QUICK MENU]** button.
 4. Move the **[Joystick]** up or down to select **<Partial Delete>**, then press the **[Joystick(OK)]**.
 5. Move the **[Joystick]** to select a title scene you want to delete partially from the Title List scenes, then press the **[Joystick(OK)]**.
 - The selected title will be paused, then the **<Start>** will be highlighted.
 6. Search the start point of deletion by pressing the **[◀◀/▶▶]** or **[▶▶]** button.
 7. Press the **[▶▶]** button at the start point to pause the screen, then press the **[Joystick(OK)]**.
 - The **<End>** will be highlighted.
 8. Press the **[◀◀/▶▶]** or **[▶▶]** button to search the end point of deletion.
 9. Press the **[▶▶]** button at the end point to pause the screen, then press **[Joystick(OK)]**.
 - The **<Execute>** will be highlighted.
 10. Press the **[Joystick(OK)]**.
 - The **<Delete selected part? Please confirm.>** message will appear.
 11. Move the **[Joystick]** left or right to select **<Yes>**, then press the **[Joystick(OK)]**.
 - The selected part of the title will be deleted.
 - Use the **[Joystick]** to select **<Back>**, then press the **[Joystick(OK)]** to return to Title List.

Note

An audible warning will be heard if you try to delete a title that had previously been protected. You must release the protect function to delete. ↪ page 69

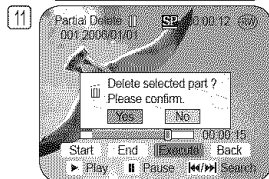
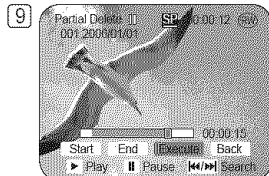
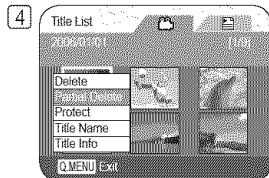

DVD Camcorder: Playlist

Creating a New Playlist (New Playlist) DVD-RW/VR mode

- ❖ This function works only in **Player Mode**. ↪ page 26
 - ❖ The editing function only works on a DVD-RW (VR Mode).
You should format the DVD-RW to VR Mode before recording. ↪ page 41
1. Set the **[Mode]** switch to **[DISC]**.
 2. Set the **[Power]** switch to **[▶(Player)]**.
 - The Title List scenes will appear.
 3. Move the **[Joystick]** up to highlight the Title List icon (📁), then move the **[Joystick]** right to highlight the Playlist icon (📄).
 - The Playlist scenes will be displayed in the form of a thumbnail index.
 - No thumbnail index is provided before creating a Playlist.
 4. Press the **[QUICK MENU]** button.
 5. Move the **[Joystick]** up or down to select **<New Playlist>**, then press the **[Joystick(OK)]**.
 - Title List scenes will appear.
 6. Use the **[Joystick]** to select a scene to create, then press the **[Joystick(OK)]**.
 - Keep selecting in the order of your preference.
 - The selected scene will be marked with <✓>.
 7. Move the **[Joystick]** up to **<Add>**, then press the **[Joystick(OK)]**.
 - A new Playlist will be created.

Notes

- Up to 199 playlists can be created.
- Up to 999 title scenes can be registered on a Playlist.

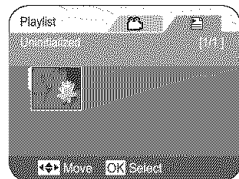
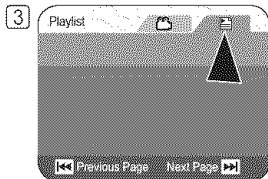

DVD Camcorder: Playlist

Renaming a Playlist (Playlist Name) DVD-RW(VR mode)

- ❖ **Playlist Name** function works only in **Player Mode**. ↪ page 26
 - ❖ The recording date automatically becomes the title name if date had been set in the system menu.
You can change the recording date to any desired title name.
 - ❖ The editing function only works on a DVD-RW (VR Mode).
You should format the DVD-RW to VR Mode before recording. ↪ page 41
1. Set the **[Mode]** switch to **[DISC]**.
 2. Set the **[Power]** switch to **[▶(Player)]**.
 - The Title List scenes will appear.
 3. Move the **[Joystick]** up to highlight the Title List icon (📄), then move the **[Joystick]** right to highlight the Playlist icon (📁).
 - The Playlist scenes will be displayed in the form of a thumbnail index.
 4. Press the **[QUICK MENU]** button.
 5. Move the **[Joystick]** up or down to select **<Playlist Name>**, then press the **[Joystick(OK)]**.
 6. Use the **[Joystick]** to select a Playlist scene you want to rename from the Playlist scenes, then press the **[Joystick(OK)]**.
 - Title Name screen will appear.
 7. Use the **[Joystick]** to move the cursor to the first character of the current title name.
 8. Use the **[Joystick]** to move the cursor to **<Delete>**, then press the **[Joystick(OK)]** to delete the existing title name.
 9. Use the **[Joystick]** to select the desired characters and items, then press the **[Joystick(OK)]**.
 - **<Delete>**: Deletes the character at the cursor position.
 - **<Space>**: Enters a blank and moves the cursor one forward (to the right).
 - **<Done>**: Registers the character inputs.
 - **<Back>**: Returns to the previous mode.
 10. Use the **[Joystick]** to select **<Done>**, then press the **[Joystick(OK)]**.
 - The Playlist name is now changed.
 - Use the **[Joystick]** to select **<Back>**, then press the **[Joystick(OK)]** to return to Playlist.

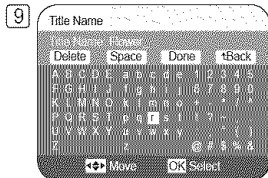
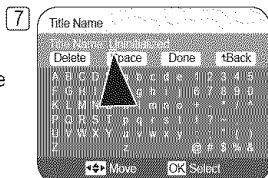

DVD Camcorder: Playlist

Playing the Playlist DVD-RW/VR mode

- ❖ This function works only in **Player Mode**. ↪ page 26
- ❖ The Playlist scenes are displayed in the form of a thumbnail index on the LCD Screen. If the LCD is closed, you can view the recording through the viewfinder.
Use the Playback related buttons on the DVD Camcorder or on the remote control. ↪ page 64
- ❖ The editing function only works on a DVD-RW (VR Mode). You should format the DVD-RW to VR Mode before recording. ↪ page 41

1. Insert the disc you want to view.
2. Set the **[Mode]** switch to **[DISC]**.
3. Set the **[Power]** switch to **[▶(Player)]**.
 - The Title List scenes will appear.
4. Move the **[Joystick]** up to highlight the Title List icon (☰), then move the **[Joystick]** right to highlight the Playlist icon (☰).
 - The Playlist scenes will be displayed in the form of a thumbnail index.
5. Use the **[Joystick]** to select a Playlist to be played, then press the **[▶||]** button.
6. Press the **[VOL -,+]** buttons to adjust volume.
 - The sound will be heard through the built-In speaker.

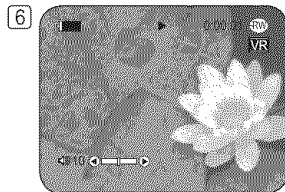
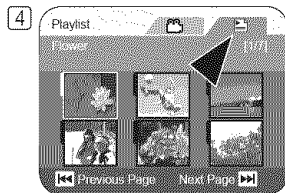

DVD Camcorder: Playlist

Playlist Information (Playlist Info) DVD-RW/VR mode

- ❖ **Playlist Info** function works only in **Player Mode**. ↪ page 26
- ❖ It shows you the Playlist information.
You can view the **Playlist Name**, **Protect**, **Rec Date**, **Length**, **Rec Mode** and **Disc Format**.
- ❖ The editing function only works on a DVD-RW (VR Mode).
You should format the DVD-RW to VR Mode before recording. ↪ page 41

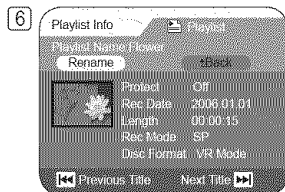
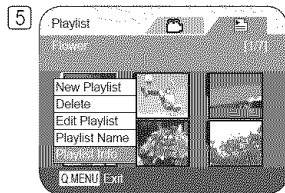

1. Set the **[Mode]** switch to **[DISC]**.
2. Set the **[Power]** switch to **[▶(Player)]**.
 - The Title List screen will appear.
3. Move the **[Joystick]** up to highlight the Title List icon (📄), then move the **[Joystick]** right to highlight the Playlist icon (📁).
 - The Playlist scenes will be displayed in the form of a thumbnail index.
4. Press the **[QUICK MENU]** button.
5. Move the **[Joystick]** up or down to select **<Playlist Info>**, then press the **[Joystick(OK)]**.
6. Use the **[Joystick]** to select the desired Playlist info, then press the **[Joystick(OK)]**.
 - It shows you information on the selected Playlist.
 - Playlist information includes **Playlist Name**, **Protect**, **Rec Date**, **Length**, **Rec Mode** and **Disc Format**.
7. To exit, press the **[Joystick(OK)]**.
 - Use the **[Joystick]** to select **<Back>**, then press the **[Joystick(OK)]** to return to Playlist.



DVD Camcorder: Playlist

Deleting a Playlist (Delete) DVD-RW (VR mode)

- ❖ **Delete** function works only in **Player Mode**. ↪page 26
- ❖ Individual or all undesired playlists can be deleted.
- ❖ The editing function only works on a DVD-RW (VR Mode). You should format the DVD-RW to VR Mode before recording. ↪page 41

1. Set the **[Mode]** switch to **[DISC]**.
2. Set the **[Power]** switch to **[▶(Player)]**.
 - The Title List screen will appear.
3. Move the **[Joystick]** up to highlight the Title List icon (📄), then move the **[Joystick]** right to highlight the Playlist icon (📁).
 - The Playlist scenes will be displayed in the form of a thumbnail index.
4. Press the **[QUICK MENU]** button.
5. Move **[Joystick]** up or down to select **<Delete>**, then press the **[Joystick(OK)]**.
6. Move the **[Joystick]** up or down to select **<Select>** or **<Select All>**, then press the **[Joystick(OK)]**.
 - **Select:** Delete individual files
To delete individual files, use the **[Joystick]** to select files to delete, then press the **[Joystick(OK)]**.
The selected files will be marked with .
 - **Select All:** Delete all files
To delete all files, simply press the **[Joystick(OK)]** after **<Select All>** is selected.
All files will be marked with .
7. Move the **[Joystick]** up to select **<Execute>**, then press the **[Joystick(OK)]**.
 - **<Delete?>** message will appear.
8. Move the **[Joystick]** left or right to select **<Yes>**, then press the **[Joystick(OK)]**.
 - All selected playlists will be deleted.

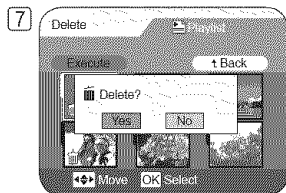
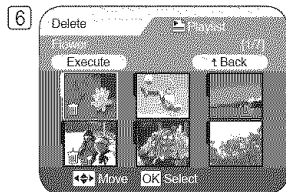
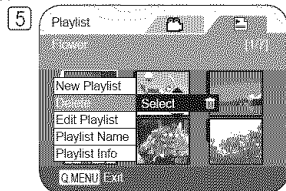

DVD Camcorder: Playlist

Adding Scenes to Playlist (Edit Playlist-Add) DVD-RW(VR mode)

- ❖ This function works only in **Player Mode**. ↪ page 26
 - ❖ You can add more scenes in an existing Playlist.
 - ❖ The editing function only works on a DVD-RW (VR Mode). You should format the DVD-RW to VR Mode before recording. ↪ page 41
1. Set the **[Mode]** switch to **[DISC]**.
 2. Set the **[Power]** switch to **[▶(Player)]**.
 - The Title List screen will appear.
 3. Move the **[Joystick]** up to highlight the Title List icon (☰), then move the **[Joystick]** right to highlight the Playlist icon (📁).
 - The Playlist scenes will be displayed in the form of a thumbnail index.
 4. Press the **[QUICK MENU]** button.
 5. Move the **[Joystick]** up or down to select **<Edit Playlist>**, then press the **[Joystick(OK)]**.
 - The screen will be switched to the Edit Playlist mode.
 6. Use the **[Joystick]** to select the Playlist to which the scenes are to be added, then press the **[Joystick(OK)]**.
 - The scenes inside the Playlist will appear.
 7. Press the **[QUICK MENU]** button.
 8. Move the **[Joystick]** up or down to select **<Add>**, then press the **[Joystick(OK)]**.
 - The Title List scenes to be added to the Playlist will appear.
 9. Use the **[Joystick]** to select the Title List scenes to be added to the Playlist, then press the **[Joystick(OK)]**.
 - The selected scenes will be marked with **<✓>**.
 10. Move the **[Joystick]** up to select **<Execute>**, then press the **[Joystick(OK)]**.
 - **<Want to add?>** message will appear.
 11. Move the **[Joystick]** left or right to select **<Yes>**, then press the **[Joystick(OK)]**.
 - The **<Now adding...>** message will appear.
 - The selected scenes will be added to the Playlist. The new scene will be added as the last scene.

Note

While the Quick Menu is displayed on the screen, pressing the **[▶II]** button plays back, and pressing the **[■(Stop)]** button while in play goes back to the thumbnail, and the Quick Menu disappears.

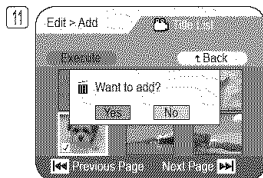
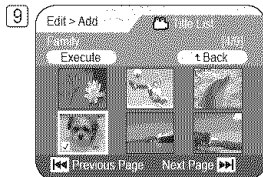
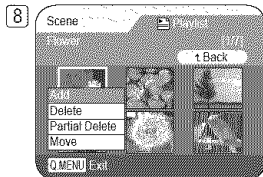

DVD Camcorder: Playlist

Changing the Order of Scene Playing within a Playlist (Edit Playlist-Move) **DVD-RW/VR mode**

- ❖ This function works only in **Player Mode**. ↪page 26
 - ❖ You can change the order of scene playing within a Playlist.
 - ❖ The editing function only works on a DVD-RW (VR Mode). You should format the DVD-RW to VR Mode before recording. ↪page 41
1. Set the **[Mode]** switch to **[DISC]**.
 2. Set the **[Power]** switch to **[▶(Player)]**.
 - The Title List scenes will appear.
 3. Move the **[Joystick]** up to highlight the Title List icon (📄), then move the **[Joystick]** right to highlight the Playlist icon (📁).
 - The Playlist scenes will be displayed in the form of a thumbnail index.
 4. Press the **[QUICK MENU]** button.
 5. Move the **[Joystick]** up or down to select **<Edit Playlist>**, then press the **[Joystick(OK)]**.
 - The screen will be switched to the Edit Playlist mode.
 6. Use the **[Joystick]** to select the Playlist which contains the scenes whose order you want to change then press the **[Joystick(OK)]**.
 - The scenes inside the Playlist will appear.
 7. Press the **[QUICK MENU]** button.
 8. Move the **[Joystick]** up or down to select **<Move>**, then press the **[Joystick(OK)]**.
 9. Use the **[Joystick]** to select the scene to be moved, then press the **[Joystick(OK)]**.
 - The Selected scenes will be marked with **<✓>**.
Also a bar next to the scenes will appear.
 10. Use the **[Joystick]** to move the bar to the position of your choice, then press the **[Joystick(OK)]**.
 - The selected scene will be moved to the new position.
 11. Move the **[Joystick]** up to select **<Execute>**, then press the **[Joystick(OK)]**.
 - The **<Want to move?>** message will appear.
 12. Move the **[Joystick]** left or right to select **<Yes>**, then press the **[Joystick(OK)]**.
 - The **<Now moving...>** message will appear.
 - You can move the scenes as many times as you wish.

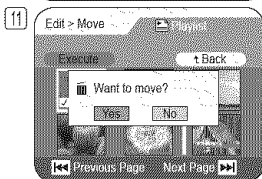
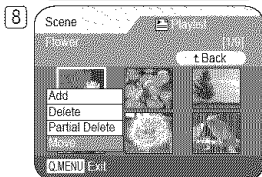

DVD Camcorder: Playlist

Deleting Scenes from Playlist (Edit Playlist-Delete) DVD-RW(VR mode)

- ❖ This function works only in **Player Mode**. ↪page 26
 - ❖ You can delete the scenes from a Playlist.
 - ❖ The editing function only works on a DVD-RW (VR Mode). You should format the DVD-RW to VR Mode before recording. ↪page 41
1. Set the **[Mode]** switch to **[DISC]**.
 2. Set the **[Power]** switch to **[▶(Player)]**.
 - The Title List screen will appear.
 3. Move the **[Joystick]** up to highlight the Title List icon (📁), then move the **[Joystick]** right to highlight the Playlist icon (📁).
 - The Playlist scenes will be displayed in the form of a thumbnail index.
 4. Press the **[QUICK MENU]** button.
 5. Move the **[Joystick]** up or down to select **<Edit Playlist>**, then press the **[Joystick(OK)]**.
 - The screen will be switched to the Edit Playlist mode.
 6. Use the **[Joystick]** to select the Playlist which contains the scenes to be deleted, then press the **[Joystick(OK)]**.
 - The scenes inside the Playlist will appear.
 7. Press the **[QUICK MENU]** button.
 8. Move the **[Joystick]** up or down to select **<Delete>**, then press the **[Joystick(OK)]**.
 9. Use the **[Joystick]** to select the scenes to be deleted, then press the **[Joystick(OK)]**.
 - The selected scenes will be marked with **<✓>**.
 10. Move the **[Joystick]** up to select **<Execute>**, then press the **[Joystick(OK)]**.
 - The **<Delete?>** message will appear.
 11. Move the **[Joystick]** left or right to select **<Yes>**, then press the **[Joystick(OK)]**.
 - The **<Now deleting...>** message will appear.
 - The selected scenes will be deleted.

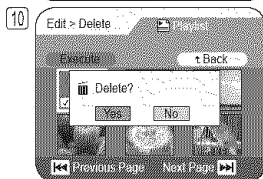
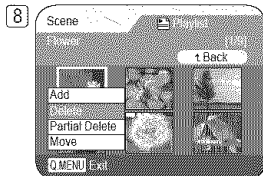

DVD Camcorder: Playlist

Deleting a Section of a Playlist (Edit Playlist - Partial Delete) DVD-RW(VR mode)

- ❖ This function works only in **Player Mode**. ↪page 26
- ❖ You can delete a part from a Playlist.
- ❖ The editing function only works on a DVD-RW (VR Mode). You should format the DVD-RW to VR Mode before recording. ↪page 41

1. Set the **[Mode]** switch to **[DISC]**.
2. Set the **[Power]** switch to **[▶(Player)]**.
 - The Title List screen will appear.
3. Move the **[Joystick]** up to highlight the Title List icon (📄), then move the **[Joystick]** right to highlight the Playlist icon (📂).
 - The Playlist scenes will be displayed in the form of a thumbnail index.
4. Press the **[QUICK MENU]** button.
5. Move the **[Joystick]** up or down to select **<Edit Playlist>**, then press the **[Joystick(OK)]**.
 - The screen will be switched to the Edit Playlist mode.
6. Use the **[Joystick]** to select the Playlist which contains the scenes to be partially deleted within, then press the **[Joystick(OK)]**.
 - The scenes inside the Playlist will appear.
7. Press the **[QUICK MENU]** button.
8. Move the **[Joystick]** up or down to select **<Partial Delete>**, then press the **[Joystick(OK)]**.
9. Use the **[Joystick]** to select the scene to be partially deleted, then press the **[Joystick(OK)]**.
 - The Partial Delete screen will appear. The Scene will be paused and the **<Start>** will be highlighted.

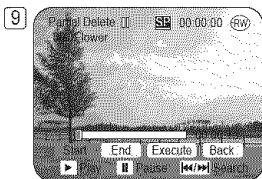
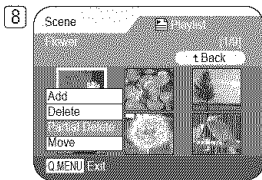

DVD Camcorder: Playlist

10. Press the [◀◀/▶▶] or [▶▶] to search the starting point of deletion.
11. Press the [▶▶] button to pause the screen at the starting point of deletion, then press the [Joystick(OK)].
 - The <End> will be highlighted.
12. Press the [◀◀/▶▶] or [▶▶] to search the end point of deletion.
13. Press the [▶▶] button to pause the screen at the end point of deletion, then press the [Joystick(OK)].
 - The <Execute> will be highlighted.
14. Press the [Joystick(OK)].
 - The <Delete selected part? Please confirm.> message will appear.
15. Move the [Joystick] left or right to select <Yes>, then press the [Joystick(OK)].
 - The <Now deleting...> message will appear.

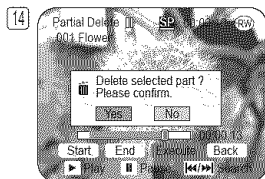
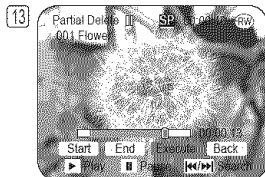

DVD Camcorder: Disc Manager

Disc Information (Disc Info) DVD-RW/+RW/R/+R DL

- ❖ This function works in both **Camera Mode** and **Player Mode**. →page 26
 - ❖ It provides disc information.
1. Set the **[Mode]** switch to **[DISC]**.
 2. Set the **[Power]** switch to **[CAMERA (Camera)]** or **[PLAYER (Player)]**.
 3. Press the **[MENU]** button.
 - The menu list will appear.
 4. Move the **[Joystick]** up or down to select **<Disc Manager>**, then press the **[Joystick(OK)]**.
 5. Move the **[Joystick]** up or down to select **<Disc Info>**, then press the **[Joystick(OK)]**.
 - **<Disc Name>**, **<Disc Type>**, **<Disc Format>**, **<Used Space>** and **<Free Space>** will be displayed.
 6. To exit, press the **[Joystick(OK)]**.

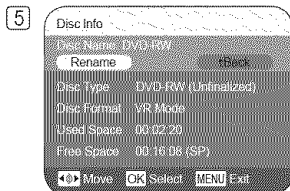
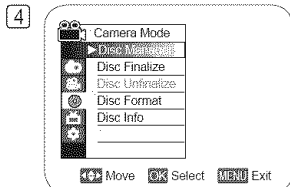

DVD Camcorder: Disc Manager

Editing the Disc Name (Disc Info-Rename) DVD-RW/+RW/R/+R DL

- ❖ This function works in both **Camera Mode** and **Player Mode**. → page 26
- ❖ You can specify a disc name.

1. Set the **[Mode]** switch to **[DISC]**.
2. Set the **[Power]** switch to **[CAMERA (Camera)]** or **[PLAYER (Player)]**.
3. Press the **[MENU]** button.
 - The menu list will appear.
4. Move the **[Joystick]** up or down to select **<Disc Manager>**, then press the **[Joystick(OK)]**.
5. Move the **[Joystick]** up or down to select **<Disc Info>**, then press the **[Joystick(OK)]**.
6. Move the **[Joystick]** left or right to select **<Rename>**, then press the **[Joystick(OK)]**.
 - Disc Title screen will appear.
7. Use the **[Joystick]** to move the cursor to the first character of the current disc title.
8. Use the **[Joystick]** to move the cursor to **<Delete>**, then press the **[Joystick(OK)]** to delete the existing disc title.
9. Use the **[Joystick]** to select the desired characters and items, then press the **[Joystick(OK)]**.
10. Use the **[Joystick]** to select **<Done>**, then press the **[Joystick(OK)]**.
 - The Disc Name will be changed.
 - Use the **[Joystick]** to select **<Back>**, then press the **[Joystick(OK)]** to return to Disc Manager menu.

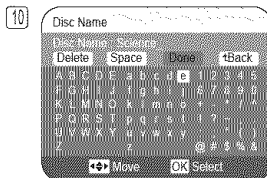
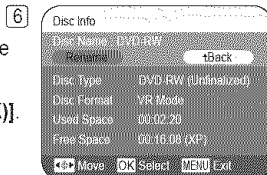
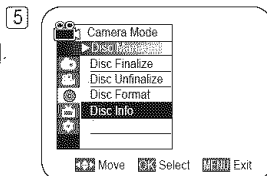
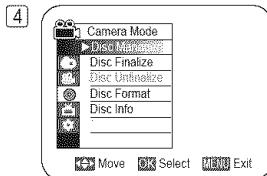

DVD Camcorder: Disc Manager

Formatting a Disc (Disc Format) DVD-RW/+RW

- ❖ This function works only in **Camera Mode**. → page 26
- ❖ You can format a recorded disc to be used again. By formatting, all existing data will be deleted.

1. Set the **[Mode]** switch to **[DISC]**.
2. Set the **[Power]** switch to **[CAMERA (Camera)]**.
3. Press the **[MENU]** button.
 - The menu list will appear.
4. Move the **[Joystick]** up or down to select **<Disc Manager>**, then press the **[Joystick(OK)]**.
5. Move the **[Joystick]** up or down to select **<Disc Format>**, then press the **[Joystick(OK)]**.
6. Move the **[Joystick]** up or down to select **<Video Mode>** or **<VR Mode>**, then press the **[Joystick(OK)]**. (DVD-RW only) Set the mode depending on the application.
 - If you insert DVD-RW disc, the **<Disc format? (Video or VR) All files will be deleted !>** message will appear.

Video (Video Mode)	If the disc has been finalized, it enables the disc to be played back on other DVD Players/Recorders.
VR (VR Mode)	You can edit the disc on a DVD Camcorder, but playback is only possible on DVD Recorder.

- Refer to page 12 for Finalized disc compatibility.
 - If you insert DVD+RW disc **<Disc format? All files will be deleted !>** message will appear.
7. Move the **[Joystick]** left or right to select **<Yes>**, then press the **[Joystick(OK)]**.
 - When formatting is complete, the **<Complete !>** message will appear.

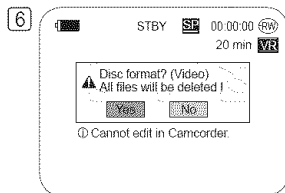
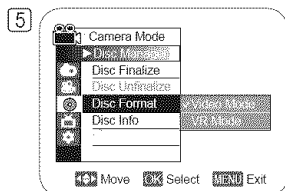
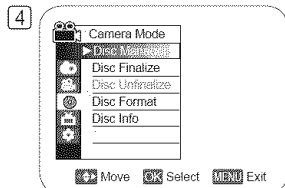

DVD Camcorder: Disc Manager

Finalizing a Disc (Disc Finalize) DVD-RW/R/+R DL

- ❖ This function works only in **Camera Mode**. ↪ page 26
 - ❖ To play the contents of a DVD-RW on other DVD players you must finalize the disc. When finalizing, there should be enough power in the batteries. If an the AC Power adapter is to be used, make sure that the jack is properly connected. A power cut during finalizing may disrupt the disc from replaying.
1. Set the **[Mode]** switch to **[DISC]**.
 2. Set the **[Power]** switch to **[CAMERA (Camera)]**.
 3. Press the **[MENU]** button.
 - The menu list will appear.
 4. Move the **[Joystick]** up or down to select **<Disc Manager>**, then press the **[Joystick(OK)]**.
 5. Move the **[Joystick]** up or down to select **<Disc Finalize>**, then press the **[Joystick(OK)]**.
 6. Move the **[Joystick]** left or right to select **<Finalize>**, then press the **[Joystick(OK)]**.
 - The **<Finalizing, please wait...>** message will appear. When finalizing is complete the **<Complete !>** message will appear.

Notes

- Once finalized, the Title Lists or Playlists in the disc cannot be deleted or edited.
- Time required for finalizing may differ by disc type.
- Refer to page 12 for Finalized disc compatibility.
- **Playback is not guaranteed in all DVD Players/Recorders. For compatibility details, refer to your DVD Players/Recorders owner's manual.**
- Once the DVD-R/+R DL disc is finalized, you cannot re-record it in the DVD Camcorder.
- You may play back DVD+RW discs on other devices without finalizing them.
- You can not make an additional recording on a DVD-RW disc without unfinalizing it after it is finalized.
- The finalized disc will not support in a Macintosh.

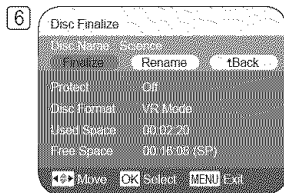
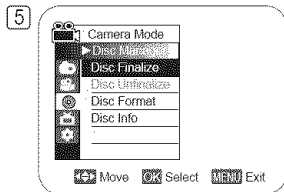
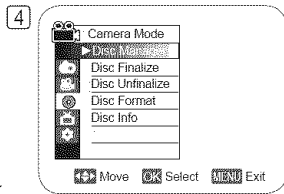

DVD Camcorder: Disc Manager

Playing Back on a PC with DVD drive

- ❖ The DVD disc can be played on a PC with a DVD running media (DVD drive).
1. Turn on your PC.
 2. Insert a finalized disc into the DVD drive of the PC.
 - Starts DVD playback application software and the disc will play.
 - If a DVD playback application does not start automatically, run the application by navigating through the Start menu.

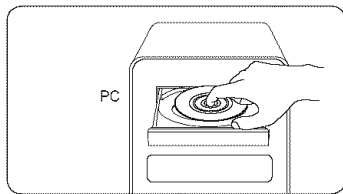

Notes

- Use a DVD drive compatible to 3 1/2inch (8m) discs. ↪page 10
- A DVD playback application software should have been installed before playing back a disc. ↪page 114
- Video and audio may be paused or skipped when you play back from a DVD disc directly. In this case, copy the data into your hard disk drive.
- The finalized disc will not support in a Macintosh.

Playing back a finalized disc on a DVD Player/Recorder

To Playback a disc

You can playback finalized DVD-R/-RW (Video mode)/+R DL discs on a DVD Players/Recorders.

Playback is not guaranteed in all DVD Players/Recorders. For compatibility details, refer to your DVD Player/Recorder owner's manual.

Most DVD Players/Recorders can play back a DVD+RW disc that has not been finalized.

- Refer to the page 12 for Finalized disc compatibility.
1. Turn on the DVD Player/Recorder.
 2. Insert the finalized DVD disc into the tray of a DVD Players/Recorders.
 - It may start playing automatically or press the PLAY button to start.
 - For further details on playing back DVD discs, refer to the DVD Player/Recorder user's manual.

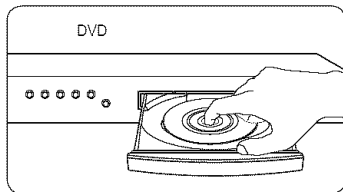

To Playback DVD-RW discs recorded in VR mode:

A finalized DVD-RW in VR mode can be played back using a DVD Recorder which is capable of playing VR mode DVD-RW discs.

DVD Camcorder: Disc Manager

Unfinalizing a Disc (Disc Unfinalize) DVD-RW

- ❖ This function works only in **Camera Mode**. ↪ page 26
- ❖ If a DVD-RW disc had been finalized in the VR mode or Video mode, you can unfinalize the disc for further recording.

1. Set the **[Mode]** switch to **[DISC]**.
2. Set the **[Power]** switch to **[CAMERA (Camera)]**.
3. Press the **[MENU]** button.
 - The menu list will appear.
4. Move the **[Joystick]** up or down to select **<Disc Manager>**, then press the **[Joystick(OK)]**.
5. Move the **[Joystick]** up or down to select **<Disc Unfinalize>**, then press the **[Joystick(OK)]**.
6. Move the **[Joystick]** left or right to select **<Unfinalize>**, then press the **[Joystick(OK)]**.
 - The **<Unfinalizing, please wait...>** message will appear. When unfinalizing is complete, the **<Complete !>** message will appear.

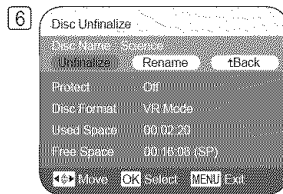
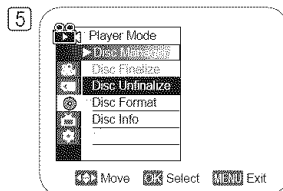
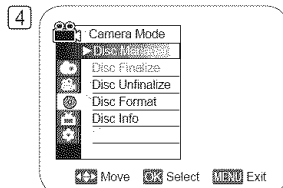

DVD Camcorder: Connection

Setting the AV In/Out (SC-DC165 only)

- ❖ AV In/Out function works only in **Player Mode**. ↪ page 26
- ❖ AV In/Out setting enables you to record signal from external sources and display it on LCD Screen. Also, you can send your video or image to external devices to record or play back.

1. Set the **[Mode]** switch to **[DISC]**.
2. Set the **[Power]** switch to **[▶(Player)]**.
3. Press the **[MENU]** button.
 - The menu list will appear.
4. Move the **[Joystick]** up or down to select **<Record>**, then press the **[Joystick(OK)]**.
5. Move the **[Joystick]** up or down to select **<AV In/Out>**, then press the **[Joystick(OK)]**.
6. Move the **[Joystick]** up or down to select **<AV In>**, **<S-Video In>** or **<Out>**, then press the **[Joystick(OK)]**.
 - If you want to see the DVD Camcorder picture with a TV, set **<AV In/Out>** menu to **<Out>**.
7. To exit, press the **[MENU]** button.

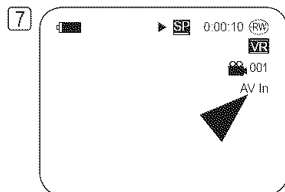
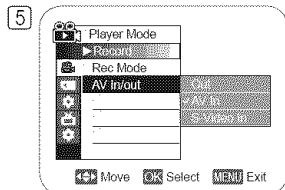
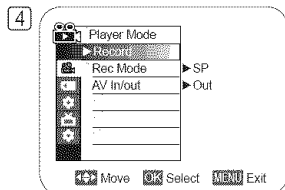

DVD Camcorder: Connection

Viewing Recordings on TV

- ❖ The Playback function works only in **Player Mode**. ↪page 26

Playing back on a TV Monitor

- ❖ To play back a disc, the television must be NTSC compatible. ↪page 119
- ❖ We recommend that you use the AC Power adapter as the power source for the DVD Camcorder.

Connecting to a TV which has Audio/Video Input Jacks

1. Connect the DVD Camcorder to your TV with the Multi-AV cable.

- The yellow jack: Video
- The white jack: Audio(L)-mono
- The red jack: Audio(R)
- If you connect to a monaural TV, connect the yellow jack (Video) to the video input of the TV and the white jack (Audio L) to the audio input of the TV.

2. Set the **[Mode]** switch to **[DISC]**.
3. Set the **[Power]** switch to **[▶(Player)]**.
4. Turn on the TV and set the TV/VIDEO selector on the TV to Video.
 - Refer to the TV user's manual.
5. Play the disc. ↪page 63

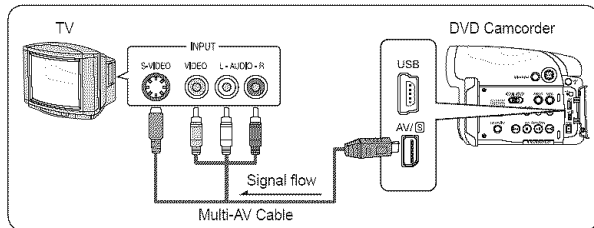

Notes

- You may use an S-Video connector on the cable to obtain better quality pictures if you have a S-Video connector on your TV.
- Even if you use an S-Video connector, you need to connect an audio cable.
- If you connect the cable to the AV/S jack, you will hear sound from the DVD Camcorder's speakers.
- If only a mono audio input is available on the TV set, use the audio cable with the white jack (Audio L).

DVD Camcorder: Connection

Connecting to a TV which has no Audio/Video Input Jacks

❖ You can connect your DVD Camcorder to a TV through a VCR.

1. Connect the DVD Camcorder to your VCR with the Multi-AV cable.
 - The yellow jack: Video
 - The white jack: Audio(L) - Mono
 - The red jack: Audio(R)
2. Connect a TV to the VCR.
3. Set the **[Mode]** switch to **[DISC]**.
4. Set the **[Power]** switch to **[▶(Player)]**.
5. Turn on both the TV and VCR.
 - Set the input selector on the VCR to Line.
 - Select the channel reserved for your VCR on the TV set.
6. Play the disc. →page 63

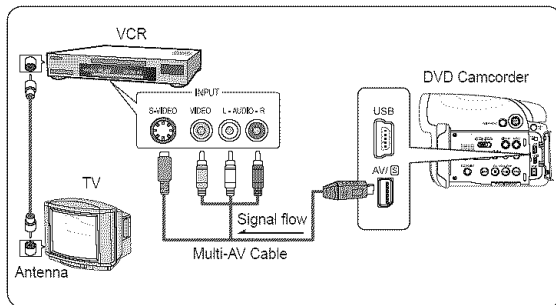

Notes

- If the VCR has an S-Video input terminal, you may use S-Video for better quality.
- Even if you use an S-Video connector, you need to connect an audio cable.
- If only a mono audio input is available on the VCR set, use the audio cable with the white jack (Audio L).

DVD Camcorder: Connection

Copying a Disc onto a Tape

- ❖ The copying function works only in **Player Mode**. ↪ page 26
- ❖ Connect your DVD Camcorder to a VCR using the AV/S jack to dub the recording from a disc onto a VCR tape.

1. Set the **[Mode]** switch to **[DISC]**.
2. Set the **[Power]** switch to **[▶(Player)]**.
3. Insert the disc you want to copy in your DVD Camcorder.
4. Insert a new tape in your VCR.
5. Connect the DVD Camcorder to your VCR with Multi-AV cable.
 - Connect the Multi-AV cable to the input jack on your VCR.
 - The yellow jack: Video
 - The white jack: Audio(L)-mono
 - The red jack: Audio(R)
6. Press the Record button on your VCR to start recording.
7. Play the disc on your DVD Camcorder. Please refer to Page 63 for Playing.
 - Press the **[DISPLAY]** button so as not to display OSD.

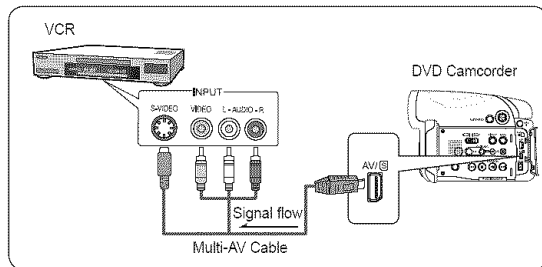

When Copying is Complete:

Stop recording on your VCR, then press the **[■(Stop)]** button on your DVD Camcorder.

DVD Camcorder: Connection

Recording (Copying) a TV Program or Video Tape onto a Disc (SC-DC165 only)

- ❖ The Recording (Copying) function works only in **Player Mode**. ↪ page 26
- ❖ Connect your DVD Camcorder to a VCR or a TV using the AV/S jack to record a TV program or copy a video tape to a disc. Set the **AV In/Out** before Recording (Copying). ↪ page 88

Recording (Copying) onto a Disc

1. Get your TV or VCR ready.
2. Connect the DVD Camcorder to your VCR or TV with Multi-AV cable.
 - Connect the Multi-AV cable to the output jack on your VCR or TV
 - The yellow jack: Video
 - The white jack: Audio (L) – Mono
 - The red jack: Audio (R)
3. Insert an empty disc in your DVD Camcorder.
 - Please refer to page 11 for selecting and formatting of discs.

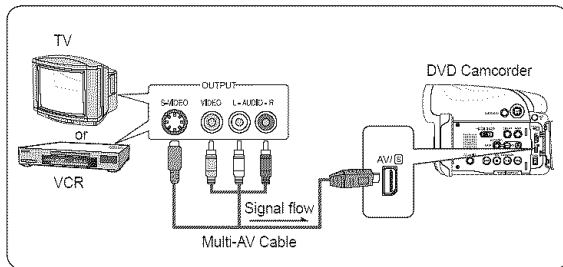

To record from a VCR

4. Insert the tape to be played in your VCR.
 - Pause at the starting point of playing.
5. Start copying by pressing the **[Start/Stop]** button on your DVD Camcorder.
6. Press the **PLAY** button on your VCR to play the tape.

To record from a TV

4. Select a TV channel to be recorded.
5. Start recording by pressing the **[Start/Stop]** button on your DVD Camcorder.

When Recording (Copying) is Complete:

Press the **[■(Stop)]** button on your DVD Camcorder to stop recording(copying).

Digital Still Camera Mode

Using a Memory Card (Usable Memory Card) (not supplied)

- ❖ The Memory Card stores and manages Photo/Moving images recorded by the DVD Camcorder.
- ❖ Before inserting or ejecting the Memory Card, set the [Power] switch to [Off] and open the LCD Screen.

Memory Card Functions

- ❖ Recording/Viewing Photo/Moving Images
- ❖ Protecting Images from accidental erasure (except Memory Stick Duo/MMC)
- ❖ The Memory Stick Duo/MMC does not have a Protection Tab. When using the Memory Stick Duo/MMC, be careful not to edit or delete data by mistake.
- ❖ Deleting Photo Images stored in Memory Card
- ❖ Marking Photo Images with Print Information
- ❖ Formatting Memory Cards

Inserting a Memory Card

1. Open the LCD Screen.
2. Open the Memory Card Cover.
3. Insert the Memory Card.
 - Please insert the Memory Card with its terminals facing upward.
4. Insert the Memory Card into the slot until it softly clicks.
5. Close the Memory Card Cover.

Ejecting a Memory Card

1. Open the LCD Screen.
2. Open the Memory Card Cover.
3. Slightly push the Memory Card inwards to pop it out.
4. Pull the Memory Card out of the slot and close the Memory Card Cover.

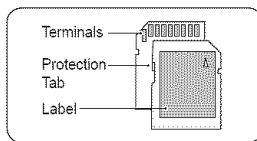

<MMC/SD>

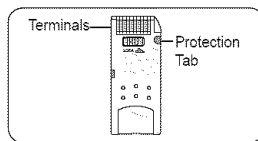

<Memory Stick/Memory Stick PRO>

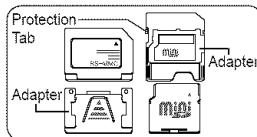

<RS MMC/Mini SD>

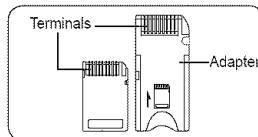

<Memory Stick Duo>

Memory Stick Duo, RS MMC or Mini SD should be inserted by using an Adapter (not supplied).

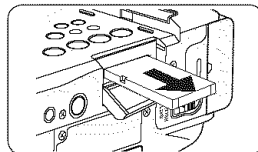
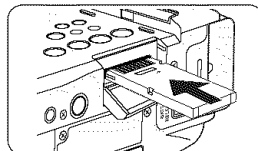

Digital Still Camera Mode

Notes

- Do not apply excessive force when you insert/eject the Memory Card.
- Do not turn the power off while recording, loading, erasing photo images or formatting the Memory Card.
- Do not place the Memory Card near a strong electro-magnetic device.
- Do not allow metal substances to come in contact with the terminals on the Memory Card.
- Do not bend, drop or apply strong shock to Memory Card.
- After removing the Memory Card from the DVD Camcorder, keep it in a soft case to prevent static shock.
- The data stored on the Memory Card may be changed or lost as a result of misuse, static electricity, electric noise or repair. Save important images separately. Samsung is not responsible for data loss due to misuse.
- The DVD Camcorder supports 2GB SD/MMC and lower. SD/MMC above 2GB may not record or play properly.

Structure of Folders and Files on the Memory Card

- The photo images that you recorded are saved in JPEG file format on the Memory Card.
- The moving images that you recorded are saved in MPEG4 file format on the Memory Card.
- Each file has a file number and all files are assigned to a folder.
 - A file number from DCAM0001 is sequentially assigned to each recorded image.
 - Each folder is numbered from 100SSDVC and recorded on the Memory Card.

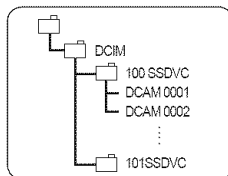

<Photo Image>

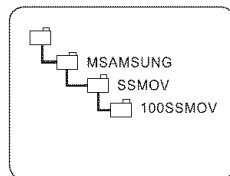

<Moving Image>

Image Format

Photo Image

- Images are compressed in JPEG (Joint Photographic Experts Group) format.
- The picture size is 800x600

Moving Image

- Images are compressed in MPEG4 (Moving Picture Experts Group) format.
- The picture size is 720x480.

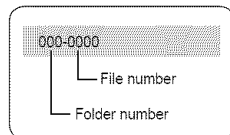

<M.Player Mode>

Digital Still Camera Mode

Selecting the Photo Quality (Photo Quality)

- ❖ **Photo Quality** function works in both **Player Mode** and **M.Cam Mode**. ↪ page 26
- ❖ You can select the quality of a photo image to be recorded.

Select the photo Quality

- Set the **[Mode]** switch to **[DISC]** or **[CARD]**.
- If the **[Mode]** switch is set to **[DISC]**, set the **[Power]** switch to **[▶] (Player)**.
If the **[Mode]** switch is set to **[CARD]**, set the **[Power]** switch to **[📷] (Camera)**.
- Press the **[MENU]** button.
 - The menu list will appear.
- Move the **[Joystick]** up or down to select **<Memory>**, then press the **[Joystick(OK)]**.
- Move the **[Joystick]** up or down to select **<Photo Quality>**, then press the **[Joystick(OK)]**.
- Move the **[Joystick]** up or down to select desired photo quality (**Super Fine** or **Fine**, **Normal**), then press the **[Joystick(OK)]**.
 - The icon of the selected option is displayed.
- To exit, press the **[MENU]** button.

Number of Images on the Memory Card

Quality	128MB	256MB	512MB	1GB	2GB
<Super Fine>	Approx. 600	Approx. 1200	Approx. 2400	Approx. 4960	Approx. 9740
<Fine>	Approx. 790	Approx. 1580	Approx. 3150	Approx. 6520	Approx. 12800
<Normal>	Approx. 1270	Approx. 2540	Approx. 5070	Approx. 10490	Approx. 20580

The actual number of images that you can record varies depending on the nature of the subject to be recorded.

Notes

- You can directly access the Photo Quality function by using the **[QUICK MENU]** button. ↪ page 27
- The above approximate figures are based on number of images under normal recording conditions.
- The number of images that can be stored on a Memory Card depends on various conditions.

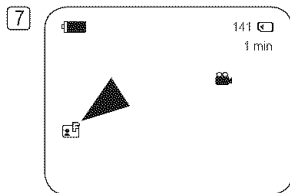
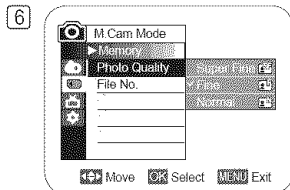
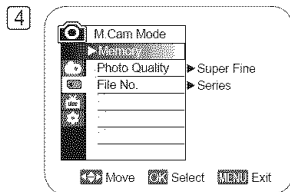

Digital Still Camera Mode

Setting the File Number (File No.)

- ❖ File Number setting works only in **M.Cam Mode**. →page 26
 - ❖ File Numbers are given to images in the order they were recorded when they are stored on the Memory Card.
 - ❖ File numbers may be set as follows:
 - **<Series>**: When there are existing files, the new image will be named as the next number in the sequence.
 - **<Reset>**: When there are no files stored on the Memory Card, the file numbering starts from 0001.
1. Set the **[Mode]** switch to **[CARD]**.
 2. Set the **[Power]** switch to **[CAMERA (Camera)]**.
 3. Press the **[MENU]** button.
 - The menu list will appear.
 4. Move the **[Joystick]** up or down to select **<Memory>**, then press the **[Joystick(OK)]**.
 5. Move the **[Joystick]** up or down to select **<File No.>**, then press the **[Joystick(OK)]**.
 6. Move the **[Joystick]** up or down to select desired option (**Series** or **Reset**), then press the **[Joystick(OK)]**.
 - The selected option is applied.
 7. To exit, press the **[MENU]** button.

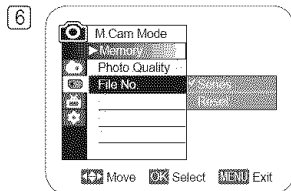
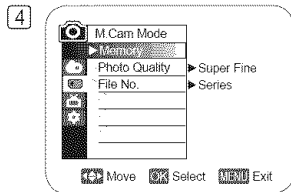

Digital Still Camera Mode

Taking a Photo Image (JPEG) on the Memory Card

- ❖ You may take photo images while in **M.Cam Mode** and store the images on the Memory Card. ↪ page 26
- ❖ You can take photo images using the remote control.(SC-DC164/DC165 only)
- ❖ Audio will not be recorded with a photo image on to the Memory Card.
- ❖ Please check the protection tab setting on your memory card before recording. You may not be able to record when it is set to lock.

1. Insert the Memory Card.
2. Set the **[Mode]** switch to **[CARD]**.
3. Set the **[Power]** switch to **[📷 (Camera)]**.
4. After framing your object to record, fully press the **[PHOTO]** button to take the picture.
 - The picture is taken and saved into the Memory Card within a few seconds.
 - Taking another picture within this interval is not possible.
 - The **<Photo capture>** indicator appears during the time it takes to save the image.

Notes

- Photo images are saved in the Memory Card in an 800x600 format.
- The number of photo images that can be stored depends on the quality of the image.

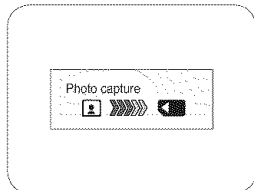
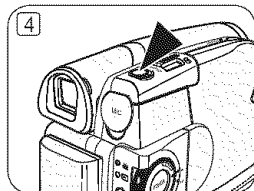

Digital Still Camera Mode

Viewing Photo Images (JPEG)

- ❖ This function works only in **M.Player Mode**. →page 26
 - ❖ You can playback and view photo images recorded on the Memory Card.
1. Set the **[Mode]** switch to **[CARD]**.
 2. Set the **[Power]** switch to **[▶(Player)]**.
 - The thumbnail index of photo image appears. If there are no recorded images on the Memory Card, **<No file!>** is displayed.
 3. Use the **[Joystick]** to select a desired photo image, then press the **[Joystick(OK)]**.
 - To display the previous six images, press and hold the **[◀◀]** button.
 - To display the next six images, press the **[▶▶]** button.

To view a Single Image

1. Use the **[Joystick]** to select a desired photo image, then press the **[Joystick(OK)]**.
2. Use the **[◀◀/▶▶]** buttons, search for the desired photo image.
 - To view the next image: press the **[▶▶]** button.
 - To view the previous image: press the **[◀◀]** button.
 - Keep pressing **[◀◀]** or **[▶▶]** to search for an image quickly. Holding the **[◀◀]** or **[▶▶]** buttons will not change the displayed image while the file number displayed changes until it is released. When the button is released, selected file will be displayed.
3. To return to thumbnail index, press the **[📄]** button.

Notes

- Loading time may vary depending on the image size.
- Any large sized image taken with another device will be displayed as a thumbnail image.

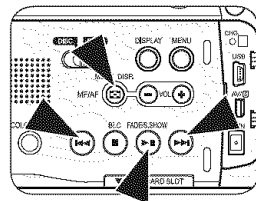
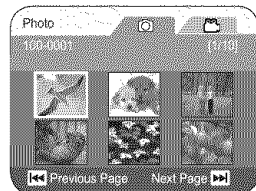

Digital Still Camera Mode

To view a Slide Show

1. Use the [Joystick] to select a desired photo image, then press the [Joystick(OK)].
2. Press the [▶ II(S.SHOW)] button in the single image display mode.
 - All images will be played back consecutively for 2~3 seconds each.
 - The <Slide> is displayed. The Slide Show will start from the current picture.
To stop the slide show, press the [▶ II(S.SHOW)] button again.

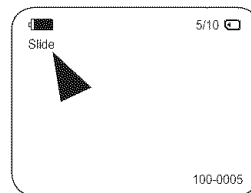
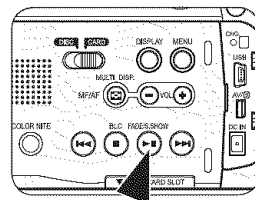

Digital Still Camera Mode

Protection from accidental Erasure (Protect)

- ❖ The **Protect** function works only in **M.Player Mode**. ↪page 26
 - ❖ You can protect important images from accidental erasure.
If you execute format, all images including protected images will be erased.
1. Set the **[Mode]** switch to **[CARD]**.
 2. Set the **[Power]** switch to **[▶(Player)]**.
 - The thumbnail index of photo image appears. If there are no recorded images on the Memory Card, **<No file!>** is displayed.
 3. Use the **[Joystick]** to select images to be protected.
 4. Press the **[MENU]** button.
 - The menu list will appear.
 5. Move the **[Joystick]** up or down to select **<Memory>**, then press the **[Joystick(OK)]**.
 6. Move the **[Joystick]** up or down to select **<Protect>**, then press the **[Joystick(OK)]**.
 7. Move the **[Joystick]** up or down to select **<On>**, then press the **[Joystick(OK)]**.
 - The protection icon () is displayed.

Notes

- It operates identically in Single Image Display mode.
- You can directly access the Protect function by using the **[QUICK MENU]**. ↪page 27
- Protected images will show the () mark when they are displayed.
- If the write protection tab on the Memory Card is set to LOCK, you cannot set image protection.

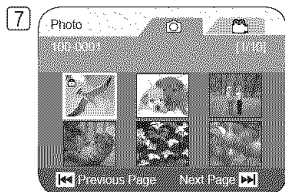
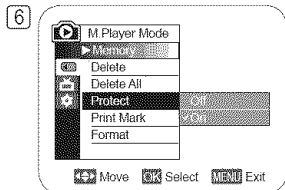

Digital Still Camera Mode

Deleting Photo Images and Moving Images (Delete)

- ❖ The **Delete** function works only in **M.Player Mode**. ↪page 26
- ❖ You can erase the photo images and moving images recorded on the Memory Card.
- ❖ If you want to delete protected images, you must first deactivate the image protection.
- ❖ An image which has been deleted cannot be recovered.

1. Set the **[Mode]** switch to **[CARD]**.
2. Set the **[Power]** switch to **[▶(Player)]**.
 - The thumbnail index of photo image appears. If there are no recorded images on the Memory Card, **<No file!>** is displayed.
3. Use the **[Joystick]** to select an image to be deleted.
4. Press the **[MENU]** button.
 - The menu list will appear.
5. Move the **[Joystick]** up or down to select **<Memory>**, then press the **[Joystick(OK)]**.
6. Move the **[Joystick]** up or down to select **<Delete>**, then press the **[Joystick(OK)]**.
 - The **<Delete?>** message will appear.
7. Move the **[Joystick]** left or right to select **<Yes>**, then press the **[Joystick(OK)]**.
 - The selected image will be deleted.
 - Press the **[MENU]** button to finish setting.

Notes

- It operates identically in Single Display.
- You can directly access the Delete function by using the **[QUICK MENU]**.
↪page 27
- If an erroneous image file is found on the Memory Card, the message **Memory card error!** will be displayed. It may be caused by copying images from different digital devices.
- Formatting the Memory Card will Delete All the stored images. ↪page 103
- To protect important pictures from accidental deletion, activate the image protection.
↪page 100

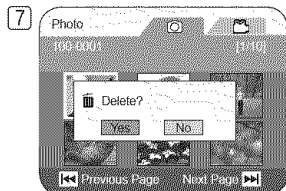
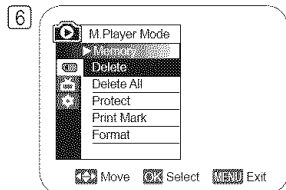
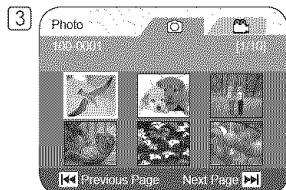

Digital Still Camera Mode

Deleting All Images at Once

Steps from 1 to 5 are the same as described in p.102.

6. Move the [Joystick] up or down to select <Delete All>, then press the [Joystick(OK)].
 - A message <Delete all?> is displayed.
7. Move the [Joystick] left or right to select <Yes> or <No>, then press the [Joystick(OK)].
8. To exit, press the [MENU] button.

Notes

- You can directly access the Delete All function by using the [QUICK MENU].
↳ page 27
- Deleting all files using the **Delete All** menu may take a while. To Delete All files much faster, format the Memory Card after backing up the files into other storage device.
↳ page 103

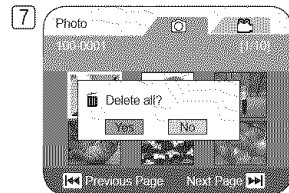
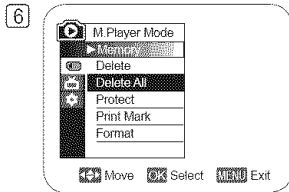

Digital Still Camera Mode

Formatting the Memory Card (Format)

- ❖ The **Format** function works only in **M.Player Mode**. ↪ page 26
- ❖ You can use the **Format** functions to completely Delete All images and options on the Memory Card, including protected images.
- ❖ The **Format** function restores the Memory Card to its initial state.

Attention

- ❖ If you execute the **Format** function, all images will be erased completely and erased images cannot be recovered.
1. Set the **[Mode]** switch to **[CARD]**.
 2. Set the **[Power]** switch to **[▶(Player)]**.
 - The thumbnail index of photo image appears. If there are no recorded images on the Memory Card, **<No file!>** is displayed.
 3. Press the **[MENU]** button.
 - The menu list will appear.
 4. Move the **[Joystick]** up or down to select **<Memory>**, then press the **[Joystick(OK)]**.
 5. Move the **[Joystick]** up or down to select **<Format>**, then press the **[Joystick(OK)]**.
 - The **<Format? All files will be deleted !>** message will appear.
 6. Move the **[Joystick]** to the left or right to select **<Yes>**, then press the **[Joystick(OK)]**.
 - The **<Complete !>** message will appear when the format is completed.
 7. To exit, press the **[MENU]** button.

Notes

- It operates identically in Single Display.
- You can directly access the **Format** function by using the **[QUICK MENU]**. ↪ page 27
- If you execute the **Format** function, all photo/moving images will be erased completely and erased photo/moving images cannot be recovered.
- Formatting the Memory Card using a different device will cause Memory Card read errors.
- Do not turn the power off in the middle of the formatting.
- A Memory Card with the protection tab set to save will not be formatted. ↪ page 93
- Do not format the Memory Card on a PC. **Not formatted** message may appear if a Memory Card formatted on a PC was inserted.

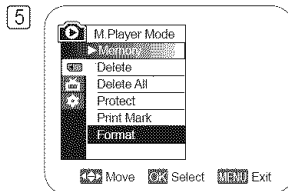
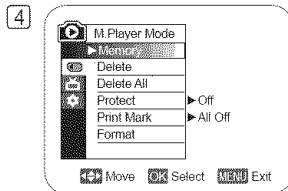

Digital Still Camera Mode

Recording Moving Images (MPEG) on the Memory Card

- ❖ You can record moving images while in **M.Cam Mode**. →page 26
- ❖ You can record moving images with audio on the Memory Card.
- ❖ The screen format of the moving image to be recorded is 720x480.

Saving Moving Images onto a Memory Card

1. Insert the Memory Card.
2. Set the **[Mode]** switch to **[CARD]**.
3. Set the **[Power]** switch to **[CAMERA (Camera)]**.
4. Press the **[Start/Stop]** button, the moving images are recorded on the Memory Card in MPEG4.
 - You can record a photo image on Memory Card by pressing the **[PHOTO]** button instead of the **[Start/Stop]** button. →page 97
5. Press the **[Start/Stop]** button to stop the recording.

Recording time available on the Memory Card

	128MB	256MB	512MB	1GB	2GB
Moving Image	Approx. 8min	Approx. 16min	Approx. 32min	Approx. 66min	Approx. 130min

Notes

- The DVD Camcorder supports memory cards ranging up to 2GB.
- Recording time is limited to one minute if 16MB memory card (or less) is used.
- Moving images that you recorded are saved in *.avi (avi 1.0) file format on the Memory Card.
- The moving images on a Memory Card are a smaller size and lower definition than images on Disc.
- The sound is recorded in stereo.
- The following functions are not allowed in M.Cam Mode: DIS, Digital Zoom, Fade, Program AE, Digital Effect, Color Nite.
- While recording on a Memory Card, don't insert or eject the disc as it may record noise.
- While recording on a Memory Card, don't eject the Memory Card or it may break the data on the Memory Card or Memory Card itself.
- Turning the power off while accessing the Memory Card may damage the data stored on the Memory Card.

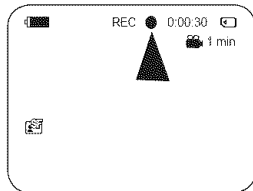
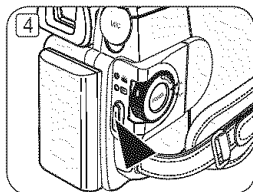

Digital Still Camera Mode

Playing the Moving Images (MPEG) on the Memory Card

- ❖ The Moving images playback function works only in **M.Player Mode**. →page 26
- ❖ You can play the moving images on the Memory Card. Stereo audio is played back at the same time.
- ❖ The Moving images will look better when played back on a PC.

1. Set the **[Mode]** switch to **[CARD]**.
2. Set the **[Power]** switch to **[▶(Player)]**.
 - The thumbnail index of photo image appears. If there are no recorded images on the Memory Card, the **<No file!>** message will appear.
3. Move the **[Joystick]** up to highlight photo image icon (📷), then move it right to highlight moving image icon (🎞️).
4. Use the **[Joystick]** to select moving image that you want to play, then press the **[Joystick(OK)]**.
 - To display the previous six images, press and hold the **[◀◀]** button.
 - To display the next six images, press the **[▶▶]** button.
 - You can control playback using the **[▶||]**, **[◀◀/▶▶]** and **[■(Stop)]** buttons.

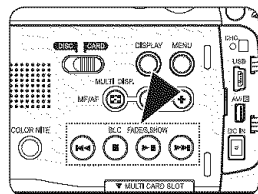
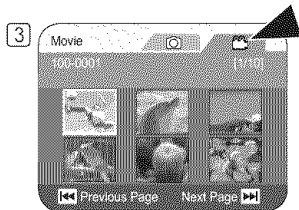

Notes

- **[MENU]** and **[QUICK MENU]** buttons are not available during moving image playback.
- There may be broken or mosaic pictures while playing the moving images, but it is not malfunction.
- The moving images that you recorded on the Memory Card may not play on other manufacturer's.
- The moving images recorded by another DVD Camcorder may not play on by this DVD Camcorder.
- To playback moving images on a PC, the Video Codec (in the CD provided with the DVD Camcorder) should be installed.
 - You need Microsoft Windows Media Player Version 9 or higher version in order to play moving images on the Memory Card on your PC.
 - You can download the Microsoft Windows Media Player applied each languages on Microsoft Website, "<http://www.microsoft.com/windows/windowsmedia/download/default.asp>".

Digital Still Camera Mode

Recording Still images onto a Memory Card during DVD playback **DVD-RW/+RW/R/+R DL**

- ❖ This function works only in **Player Mode**. ↪ page 26
- ❖ If you press the **[PHOTO]** button during DVD disc playback, the disc stops and the image on the DVD is saved on the Memory Card.

1. Set the **[Mode]** switch to **[DISC]**.
2. Set the **[Power]** switch to **[▶(Player)]**.
 - The thumbnail index of the Title List will appear.
3. Use the **[Joystick]** to select a Title List scene to be played, then press the **[Joystick(OK)]** or **[▶||]** button.
 - The selected scene will be playing one scene after another continuously to the last scene.
4. Press the **[PHOTO]** button.
 - The photo image is recorded on the Memory Card.
 - During the time it takes to save an image, the playback screen is paused and the OSD is displayed. (see illustration to the right)

Notes

- Photo images copied from the DVD to the Memory Card are saved in a 640x480 format.
- Number of images you can save varies depending on the image resolution.

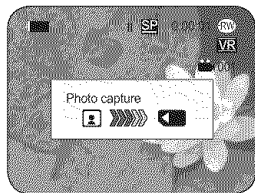
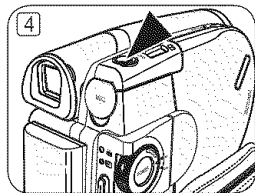

Digital Still Camera Mode

Marking Images for Printing (Print Mark)

- ❖ The **Print Mark** function works only in **M.Player Mode**. ↪ page 26
- ❖ This DVD Camcorder supports the DPOF (Digital Print Order Format) print format.
- ❖ You can automatically print images recorded on a Memory Card with a printer supporting DPOF.
- ❖ Setting the Print Mark is only available when using a memory card.
- ❖ There are 2 ways to make a Print Mark.
 - **<This File>**: You can set a print mark on the photo image displayed on the LCD Screen. It can be set up to 999.
 - **<All Files>**: To print 1 copy each of all of the stored images.

1. Set the **[Mode]** switch to **[CARD]**.
2. Set the **[Power]** switch to **[▶(Player)]**.
 - The thumbnail index of photo image appears. If there are no recorded images on the Memory Card, the **<No file!>** message will appear.
3. Use the **[Joystick]** to search for the photo image that you want to mark.
4. Press the **[MENU]** button.
 - The menu list will appear.
5. Move the **[Joystick]** up or down to select **<Memory>**, then press the **[Joystick(OK)]**.
6. Move the **[Joystick]** up or down to select **<Print Mark>**, then press the **[Joystick(OK)]**.
7. Move the **[Joystick]** up or down to select desired option (**All Off**, **All Files** or **This File**), then press the **[Joystick(OK)]**.
8. If you select **<This File>**, move the **[Joystick]** up or down to select the quantity, then press the **[Joystick(OK)]**.
 - Print Mark icon () and number of prints are displayed.
9. To exit, press the **[MENU]** button.

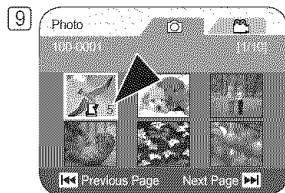
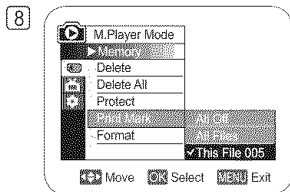
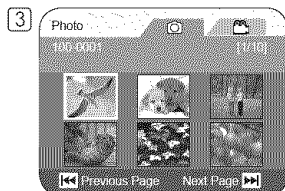

Digital Still Camera Mode

Removing the Print Mark

To remove all Print Marks, select <All Off>.

To remove individual file's Print Mark, select the file and set <This File> to <000>.

Notes

- It operates identically in Single Display.
- You can directly access the **Print Mark** function by using the [QUICK MENU] button. ↪ page 27
- If the Print Mark is set to **This File**, you can set the number of copies from **000** to **999**.
- If the Print Mark is set to **All Files**, you can set the number of copies to **1**.
- The **All Files** option may require extended operation time depending on the number of stored images.
- DPOF supporting printers are commercially available.
- Use the USB cable provided with the DVD Camcorder.

PictBridge™

Printing Your Pictures-Using the PictBridge™

- ❖ **PictBridge** function works only in **M.Player Mode**. → page 26
- ❖ By connecting the DVD Camcorder to printers with PictBridge support (sold separately), you can send images from the Memory Card directly to the printer with a few simple operations.
- ❖ With the PictBridge Support, you can control the printer directly through your DVD Camcorder in order to print out stored pictures. For direct printing of your stored pictures using the PictBridge function, you must connect your DVD Camcorder to a PictBridge printer using a USB cable.

Connecting To a Printer (USB Connect)

1. Turn your printer power off.
 - Turn your DVD Camcorder on by setting the **[Mode]** switch to **[CARD]**.
2. Set the **[Power]** switch to **[▶(Player)]**.
 - Move the **[Joystick]** to select an image to print.
3. Press the **[MENU]** button.
 - The menu list will appear.
4. Move the **[Joystick]** up or down to select **<System>**, then press the **[Joystick(OK)]**.
5. Move the **[Joystick]** up or down to select **<USB Connect>**, then press the **[Joystick(OK)]**.
6. Move the **[Joystick]** up or down to select **<Printer>**, then press the **[Joystick(OK)]**.
 - **<Computer>**: Connect to a computer.
 - **<Printer>**: Connect to a printer. (To use the **<PictBridge>** function, select this.)
7. Connect your DVD Camcorder to the printer using the provided USB cable.
8. Turn your printer power on.
 - The **<PictBridge>** menu screen appears automatically after a short period.
 - The cursor highlights **<Print>**.

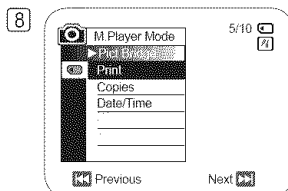
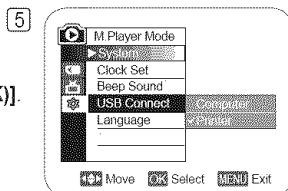
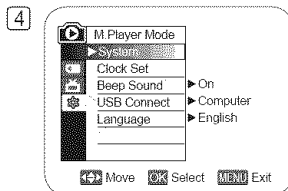

PictBridge™

Setting the Number of Prints

1. Move the [Joystick] up or down to select <Copies>, then press the [Joystick(OK)].
2. Move the [Joystick] up or down to set the number of prints, then press the [Joystick(OK)].

Setting the Date/Time Imprint Option

3. Move the [Joystick] up or down to select <Date/Time>, then press the [Joystick(OK)].
4. Move the [Joystick] up or down to select the Date/Time display type, then press the [Joystick(OK)].
 - Date/Time display type: <Off>, <Date>, <Time>, <Date&Time>

Printing Images

Move the [Joystick] up or down to select <Print>, then press the [Joystick(OK)], and selected image files will be printed.

Canceling the Printing

To cancel the image printing, press [Joystick(OK)] button again. The message <Cancel> appears and the image printing will be canceled.

Notes

- The Date/Time Option may not supported by all printers. Check with your printer manufacturer. The **Date/Time** menu cannot be setup if the printer does not support this option.
- The PictBridge™ is a registered trademark of CIPA(Camera & Imaging Products Association), an image transfer standard developed by Canon, Fuji, HP, Olympus, Seiko Epson, and Sony.
- PictBridge supporting printers are commercially available.
- Use the USB cable provided with the DVD Camcorder.
- Use the AC power adapter for your DVD Camcorder during PictBridge Direct Printing. Turning your DVD Camcorder off during printing might damage data on the Memory Card.
- Printing photo images is supported. Moving images are not available for printing.
- You can set various printing options depending on the printer. Please refer to the user's manual of the printer for details.

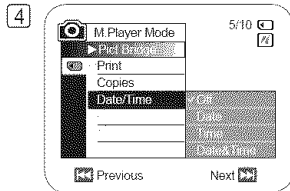
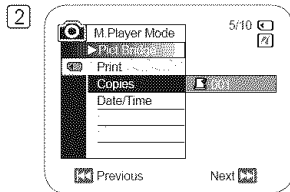

USB Interface

Using USB Interface

Transferring a Digital Image through a USB Connection

- ❖ The DVD Camcorder supports both USB 1.1 and 2.0 standards. (Depends on the PC specification)
- ❖ You can transfer a recorded file in memory Card to a PC via a USB connection.
- ❖ If you transfer data to a PC, you need to install the software (DV Driver, Video Codec, DirectX 9.0) supplied with the DVD Camcorder.

USB Connection Speed depending on the System

High speed USB connection is supported by Microsoft (Windows) device drivers only.

- Windows 98SE/ME - Full Speed USB
- Windows 2000 - High speed USB on a system with Service Pack 4 or later installed.
- Windows XP - High speed USB on a system with Service Pack 1 or later installed.



System Requirements

	Windows System	
	Minimum	Recommended
CPU	Intel® Pentium III™, 600MHz	Intel® Pentium 4™, 2GHz
OS(Operating System)	Windows® 98SE/ME	Windows® 2000/XP
Memory	128MB	512MB
HDD capacity	1GB or more	2GB or more
Resolution	1024 x 768 dots 24bit Color	1024 x 768 dots 24bit Color
USB	USB1.1	USB2.0 High Speed

- USB interface between the DVD Camcorder and a Mac is not possible.
- Operations are not guaranteed for all of the recommended computer environments mentioned above.

USB Interface

Notes

- On a slower PC than recommended, movie playback may not be smooth or video editing may take a long time.
- On a slower PC than recommended, movie playback may skip frames or operate unexpectedly.
- Intel® Pentium III™ or Pentium 4™ is a trademark of the Intel Corporation.
- Windows® is a registered trademark of the Microsoft® Corporation.
- All other brands and names are property of their respective owners.
- In **M.Cam Mode** or **M.Player Mode**, be sure that the Memory Card is inserted into DVD Camcorder before connecting USB cable. If no Memory Card or an unformatted Memory Card is inserted, PC will not recognize your DVD Camcorder as a removable disk.
- USB Streaming requires **Video Codec, DV Driver and DirectX 9.0**.
- If you disconnect the USB cable from the PC or the DVD Camcorder during the data transfer, the data transfer will stop and the data may be damaged.
- If you connect the USB cable to a PC using a USB HUB or with other devices at the same time, it may cause conflict and may not work properly. If this occurs, remove all other USB devices and try the connection again.

USB Interface

Selecting the USB Device (USB Connect)

- ❖ The **USB Connect** function works only in **M.Player Mode**. ↪ page 26
 - ❖ Using the USB cable, you can connect your DVD Camcorder to a computer to copy your moving images and photo images from the Memory Card, or to a printer to print your images.
1. Set the **[Mode]** switch to **[CARD]**.
 2. Set the **[Power]** switch to **[▶(Player)]**.
 3. Press the **[MENU]** button.
 - The menu list will appear.
 4. Move the **[Joystick]** up or down to select **<System>**, then press the **[Joystick(OK)]**.
 5. Move the **[Joystick]** up or down to select **<USB Connect>**, then press the **[Joystick(OK)]**.
 6. Move the **[Joystick]** up or down to select **<Computer>** or **<Printer>**, then press the **[Joystick(OK)]**.
 - You can select **<Computer>** to use the DVD Camcorder as a PC Camera, USB Stream or removable disk.
 - You can select **<Printer>** to use the Pictbridge feature. ↪ page 109
 7. To exit, press the **[MENU]** button.

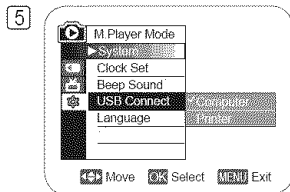
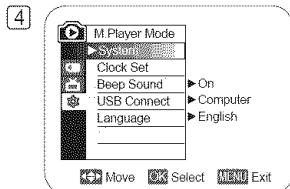

USB Interface

Installing DV Media PRO Program

- ❖ You need to install DV Media PRO Program to play back movie files recorded by the DVD Camcorder on your PC.

Before your start!

- ❖ Turn on your PC. Exit all other applications running.
- ❖ Insert the provided CD into the CD-ROM drive.
The setup screen appears automatically soon after the CD was inserted. If the setup screen does not appear, click on "Start" on the bottom left corner and select "Run" to display a dialog. Type "D:\autorun.exe" and then press ENTER, if your CD-ROM drive is mapped to "D:Drive".

Installing Driver - DV Driver and DirectX 9.0

- ❖ DV Driver is a software driver that is required to support establishing connection to a PC.
(If it is not installed, some functions will not be supported.)
1. **Click on <DV Driver> on the Setup screen.**
 - Driver software is installed automatically. Following drivers will be installed:
 - USB Removable disk driver (Windows 98 SE only)
 - USB PC-CAMERA driver
 2. **Click on <Confirm> to finish driver installation.**
 - Windows 98 SE users need to restart Windows.
 3. **If the <DirectX 9.0> is not installed, it is installed automatically after setting <DV Driver>.**
 - After installing <DirectX 9.0>, PC needs to be restarted.
 - If <DirectX 9.0> is installed already, there is no need to restart the PC.

Application Installation - Video Codec

- **Click on <Video Codec> on the Setup screen.**
<Video Codec> is required to play movie files recorded by this DVD Camcorder on a PC.

USB Interface

Application Installation – Photo Express

1. Click <Photo Express> on the Setup screen.
 - It is a photo editing tool that allows users to edit images.

Application Installation – Quick Time

1. Click <Quick Time> on the Setup screen.
 - QuickTime is Apple's technology for handling movie, sound, animation, graphics, text, music, and even 360-degree virtual reality (VR) scenes.

Ulead Video Studio

Setting up Ulead Video Studio

- After inserting the CD, the setup screen displays automatically. Follow the instruction to start installation. Ulead Video Studio is a video editing tool that allows users to edit movie files.

Notes

- Please install by using the Software CD that came with this DVD Camcorder. We do not guarantee compatibility for different CD versions.
- For photo editing, use **Photo Express**.
- For movie playback on a PC, install software in this order: **DV Driver - DirectX 9.0 - Video Codec**
- For movie editing, please use **Ulead Video Studio** that came with the product.
- For PC Cam use, DV Driver installation is required.
- You have to install **DV Driver**, **Video Codec** and **DirectX 9.0** to run DV Media Pro properly.
- If a message saying "Digital Signature not found" or something similar appears, ignore the message and continue with the installation.

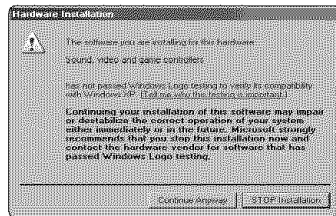

USB Interface

Connecting to a PC

1. Connect a USB cable to the USB jack on the PC.
2. Connect the other end of the USB cable into the USB jack on the DVD Camcorder. (USB jack)
 - If a PC is connected to the DVD Camcorder with a USB cable, only **[Power]** switch, **[Mode]** switch, **[Zoom]** lever can be operated.

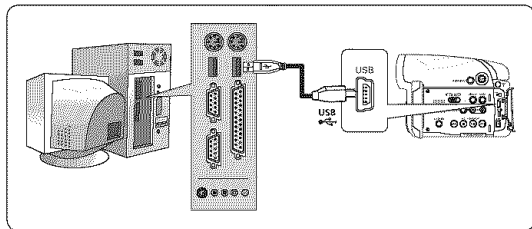

Disconnecting the USB Cable

- ❖ After completing the data transmission, you must disconnect the cable in the following way:
 1. Select the removable disc icon and click the right mouse button to select "Eject".
 2. Select "Confirm" and disconnect the USB cable when the Windows Splash screen appears.

Notes

- If you disconnect the USB cable from the PC or the DVD Camcorder while transferring, the data transmission will stop and the data may be damaged.
- If you connect the USB cable to a PC via a USB HUB or simultaneously connect the USB cable along with other USB devices, the DVD Camcorder may not work properly. If this occurs, remove all USB devices from the PC and reconnect the DVD Camcorder.

USB Interface

Using the PC Camera Function

- ❖ This function works only in **Camera Mode**. ↪ page 26
 - ❖ To use the PC Camera function, the **DV Driver**, **Video Codec** and **DirectX 9.0** programs must be installed in the PC.
 - ❖ You can use this DVD Camcorder as a PC Camera.
 - ❖ When you connect to a Web site that provides video chatting functions, you can use your DVD Camcorder for such functions.
 - ❖ When using this DVD Camcorder for video conferencing (such as NetMeeting), voice communication may not be supported depending on the video conferencing software. In this case, connect an external microphone to the soundcard of the PC to enable voice communication.
 - ❖ Using the DVD Camcorder with PC Net-meeting program installed, you can participate in video conference.
 - ❖ The PC Camera's screen size (Transferred video frame rate for the PC Camera function is max 30 fps.)
 - 640X480(VGA) pixels for USB 2.0 connection.
 - ❖ If PC is connected with the USB to the DVD Camcorder, only the **[Power]** switch, **[Mode]** switch, **[Zoom]** lever can be operated.
1. Set the **[Mode]** switch to **[DISC]**.
 2. Set the **[Power]** switch to **[CAMERA]**.
 3. Connect one end of the USB cable to the USB jack on the DVD Camcorder and the other end to the USB connector on your computer.

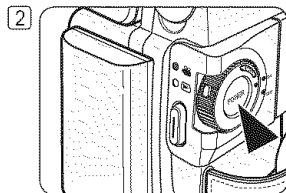
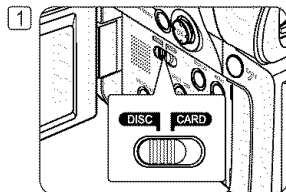

USB Interface

Using the USB Streaming Function

- ❖ This function works in both **Camera** and **Player Modes**. ↪ page 26
 - ❖ To use USB streaming, the **DV Driver**, **Video Codec** and **DirectX 9.0** programs must be installed in the PC.
 - ❖ You can view DVD Camcorder video on your PC using USB streaming.
 - ❖ You can also store it as a moving image in the “avi” file format, or as a photo image in the “jpg” file format on a PC.
1. Connect one end of the USB cable to the USB jack on the DVD Camcorder and the other end to the USB jack on your computer.
 2. Setup and execute Windows Movie Maker or the Ulead VIDEO Studio Software application provided on the CD.
 - For detailed instructions for Ulead VIDEO Studio use, refer to the program's Help function.
 - Windows Movie Maker is used for WINDOWS ME and XP users. (C:\program files\Movie maker\moviemk.exe)

Using the removable Disk Function

- ❖ You can easily transfer data from a Memory Card to a PC without additional cards via a USB connection.
1. Set the **[Mode]** switch to **[CARD]**, set the **[Power]** switch to **[📷 (Camera)]** or **[▶ (Player)]**.
 2. Connect one end of the USB cable to the USB jack on the DVD Camcorder and the other end to the USB jack on your computer.
 3. To verify whether the removable disk has been properly recognized, open Windows Explorer and locate the removable disk.

Maintenance

Using Your DVD Camcorder Abroad

- ❖ Each country or region has its own electric and color systems.
- ❖ Before using your DVD Camcorder abroad, check the following items.

Power sources

- You can use your DVD Camcorder in any country or area with the supplied AC Power adapter within 100V to 240V, 50/60 Hz.
- Use a commercially available AC jack adapter, if necessary, depending on the design of the local wall outlet.

Color system

You can view your recordings using the built-in LCD screen and viewfinder.

However, to view your recordings on a television set or to copy it to a video cassette recorder (VCR), the television set or the VCR must be NTSC-compatible and have the appropriate Audio / Video jacks. Otherwise, you may need to use a separate Video Format Transcoder (NTSC-PAL format Converter).

PAL-compatible Countries/Regions

Australia, Austria, Belgium, Bulgaria, China, CIS, Czech Republic, Denmark, Egypt, Finland, France, Germany, Greece, Great Britain, Holland, Hong Kong, Hungary, India, Iran, Iraq, Kuwait, Libya, Malaysia, Mauritius, Norway, Romania, Saudi Arabia, Singapore, Slovak Republic, Spain, Sweden, Switzerland, Syria, Thailand, Tunisia, etc.

NTSC-compatible Countries/Regions

Bahamas, Canada, Central America, Japan, Korea, Mexico, Philippines, Taiwan, United States of America, etc.

Note





You can make recordings with your DVD Camcorder and view pictures on the LCD Screen from anywhere in the world.

Troubleshooting

Troubleshooting

- ❖ Before contacting a Samsung authorized service center, perform the following simple checks. They may save you the time and expense of an unnecessary call.

Self Diagnosis Display in <Camera/Player> Modes

Display	Blinking	Informs that..	Action
	Slow	The Battery Pack is almost discharged.	Change to a charged one.
 No disc!	Slow	There is no disc in DVD Camcorder.	Insert a disc.
 Disc full!	Slow	There is not enough memory to record.	Change to a new disc. Erase recorded image.
Bad Disc!	Slow	If inserted disc is not recognized by the DVD Camcorder.	Eject and re-insert the disc. Try another disc.
 Finalized disc!	Slow	The disc is finalized.	To record on a DVD-RW disc, unfinalize it.
 Cover is opened	Slow	Cover is opened.	Close the cover.

Caution

When there is dew condensation, put aside for a while before using

- **What is Dew Condensation?**

Dew condensation happens when a DVD Camcorder is moved to a place where there is a significant temperature difference from the previous place. In other words, the water vapor in the air turns into dew because of the temperature difference, and it condensates like dew on the external or internal lenses of the DVD Camcorder and on the reflection lens and the surface of the disc which are related to playback. When this happens, you temporarily may not use the record or play functions of the DVD Camcorder.

Also, it may cause a malfunction or damage to the DVD Camcorder when using the device with the power on while there is dew condensation.

- **What can I do?**

Turn the power off and detach the battery pack, and leave it in a dry area for 1~2 hours before using it.

- **When does the dew condensation occur?**

When the device is relocated to a place with a higher temperature than the previous location, or when using it in a hot area suddenly, it will cause condensation.

- 1) When recording outside in cold weather during the winter and then using it in indoors.
- 2) When recording outside in hot weather after being indoors or inside a car where the AC was running.

Troubleshooting

Self Diagnosis Display in <M.Cam/M.Player> Modes

Display	Blinking	Informs that...	Action
No memory card!	Slow (M.Cam) - (M.Player)	There is no Memory Card in the DVD Camcorder.	Insert a Memory Card.
Memory card full!	Slow	There is not enough memory to record.	Change to a new Memory Card. Erase recorded image.
Read error!	Slow	The DVD Camcorder can not playback.	Format a Memory Card or insert Memory Card recorded on this DVD Camcorder.
Write error!	Slow	The DVD Camcorder can not record.	Format a Memory Card or change to a new Memory Card.
Not formatted!	Slow	The Memory Card needs to format.	Format a Memory Card. ↪ page 103
No file!	-	There are no images recorded on the Memory Card.	Record new images.

Troubleshooting

❖ If these instructions do not solve your problem, contact your nearest Samsung authorized service center.

Symptom	Explanation/Solution
You cannot switch the DVD Camcorder on.	<ul style="list-style-type: none"> Check the Battery Pack or the AC Power adapter.
The DVD Camcorder shuts off automatically.	<ul style="list-style-type: none"> You have left the DVD Camcorder set to STBY for more than 5 minutes without using it. To turn on the DVD Camcorder, press the [Start/Stop] button. The Battery Pack is fully exhausted. Replace it with the fully charged battery pack.
Charge runs out quickly.	<ul style="list-style-type: none"> The atmospheric temperature is too low. The Battery Pack has not been charged fully. The Battery Pack is completely dead, and cannot be recharged, use another Battery Pack.
A vertical strip appears on the screen when recording a dark background.	<ul style="list-style-type: none"> The contrast between the subject and the background is too great for the DVD Camcorder to operate normally. Make the background bright to reduce the contrast or use the BLC function while you are recording in bright Surroundings.
The image in the Viewfinder is blurred.	<ul style="list-style-type: none"> The Viewfinder lens has not been adjusted. Adjust the Viewfinder control lever until the indicators displayed on the Viewfinder come into sharp focus.
Auto focus does not work.	<ul style="list-style-type: none"> Check the Manual Focus menu. Auto focus does not work in the Manual Focus mode.
When the power is turned off and then turned on, a blue screen shows up instead of the screen.	<ul style="list-style-type: none"> If the DC Adapter is connected, remove the cord, turn on the Power switch, and then connect it again. If the battery is connected, disconnect it, turn the Power switch to on, and then connect it again.

Troubleshooting

Symptom	Explanation/Solution
Pressing the [Start/Stop] button does not start recording.	<ul style="list-style-type: none"> ▪ Check the [Power] switch is set to [📷] (Camera). ▪ There is not enough free space in the disc. Replace the disc with a new one or format the disc. ▪ Disc was finalized. Make the disc writable to record additional pictures. ▪ DVD Camcorder is too hot. Turn off the power and cool it down a while.
Disc is not recognized and the disc cover opens.	<ul style="list-style-type: none"> ▪ The disc is a damaged one. Replace with a new disc.
Pressing the [▶] button does not start playing.	<ul style="list-style-type: none"> ▪ Check the [Power] switch is set to [▶] (Player). ▪ Check the disc compatibility. ▪ Check the disc was inserted properly to face its writable side toward the DVD Camcorder. ▪ A disc with data that had been recorded using other devices may not properly work with this DVD Camcorder.

Troubleshooting

Symptom	Explanation/Solution
Playback screen interrupted unexpectedly.	<ul style="list-style-type: none"> Check the Power supply (Battery Pack or AC Power Adapter) is properly connected and stable.
Cannot play back recorded DVD-RW/+RW/-R/+R DL disc on a DVD player.	<ul style="list-style-type: none"> A disc with data that had been recorded using other devices may not properly work with this DVD Camcorder. Only DVD-RW disc A disc recorded in VR mode cannot be played back using a recorder that does not support VR mode. Refer to the user's manual of playback device to check compatibility.
Cannot play back recorded DVD-RW/+RW/-R/+R DL disc on a PC.	<ul style="list-style-type: none"> Clean the disc using a cleaning cloth. Finalize the disc (except DVD+RW).
Pushing the [OPEN] switch does not open the Disc Cover.	<ul style="list-style-type: none"> Check the Power supply (Battery Pack or AC Power Adapter) is properly connected and stable. Detach the Battery Pack from the DVD Camcorder and install it again. Check the Battery Pack was charged. Disc finalization was interrupted by turning the DVD Camcorder off. Turn the DVD Camcorder on, and take out the disc after finalizing the disc.
Cannot close the Disc Cover.	<ul style="list-style-type: none"> Make sure the hand strap is not entangled. Check the disc was inserted properly.

Troubleshooting

Setting menu items

Main Menu	Sub Menu	Functions	Available Mode				Page
			Camera Mode	Player Mode	M.Cam Mode	M.Player Mode	
Camera	Program AE	Selecting the Program AE Function	✓				53
	White Balance	Setting White Balance	✓		✓		55
	Digital Effect	Setting the Digital special effect	✓				57
	16:9 Wide	Setting the 16:9 Wide mode	✓				59
	DIS	Selecting the Digital Image Stabilizing	✓				60
	Digital Zoom	Selecting Digital Zoom	✓				61
Record	Rec Mode	Selecting the recording speed	✓	✓			42
	AV In/Out ■	Selecting the AV input/output		✓			88
	Wind Cut	Minimizing wind noise	✓				50
Memory	Photo Quality	Selecting Image Quality		✓	✓		95
	Delete	Deleting Files				✓	101
	Delete All	Deleting all Files				✓	102
	Protect	Preventing Accidental Erasure in Memory Card				✓	100
	Print Mark	Marking images recorded on a Memory Card for Printing				✓	107
	Format	Formatting the Memory Card				✓	103
	File No.	File Numbering Options			✓		96
Disc Manager	Disc Finalize	Finalizing a Disc	✓				85
	Disc Unfinalize	Unfinalizing a Disc	✓				87
	Disc Format	Formatting Disc	✓				84
	Disc Info	Providing a Disc Information	✓	✓			82
Display	LCD Bright	Setting the Brightness tone of the LCD Screen	✓	✓	✓	✓	36
	LCD Color	Setting the Color tones of the LCD Screen	✓	✓	✓	✓	36
	Date/Time	Setting the Date and Time Display	✓	✓	✓	✓	37

■: SC-DC165 only

Troubleshooting

Main Menu	Sub Menu	Functions	Available Mode				Page
			Camera Mode	Player Mode	M. Cam Mode	M. Player Mode	
System	Clock Set	Setting the time	✓	✓	✓	✓	30
	Remote ●	Using the remote control	✓	✓	✓	✓	31
	Beep Sound	Setting the Beep sound	✓	✓	✓	✓	32
	Shutter Sound	Setting the Shutter sound			✓		33
	USB Connect	Selecting the USB device				✓	113
	Language	Selecting the OSD language	✓	✓	✓	✓	34
	Demonstration	Demonstration	✓				35

- : SC-DC164/DC165 only



MEMORY STICK™

- “Memory Stick” and “” are trademarks of Sony Corporation.
- All other product names mentioned herein may be the trademarks or registered trademarks of their respective companies.
Furthermore, “™” and “®” are not mentioned in each instance in this manual.



- Manufactured under license from Dolby Laboratories.
- “Dolby” and the double-D symbol are trademarks of Dolby Laboratories.

Specifications

Model Name: SC-DC163/DC164/DC165

System	
Video signal	NTSC
Picture Compression format	MPEG-2
Audio Compression format	DOLBY® DIGITAL STEREO CREATOR
Recording Quality	XP (about 9Mbps), SP (about 6Mbps), LP (about 3Mbps)
Image device	CCD (Charge Coupled Device) (680k pixels)
Lens	F1.6 30x (SC-DC163), 33x (SC-DC164/DC165) (Optical), 1200x(Digital) Electronic zoom lens
Filter diameter	Ø30
LCD Screen/Viewfinder	
Size/dot number	SC-DC163: 2.5inches 112k / SC-DC164/DC165: 2.7inch 230k
LCD Screen Method	TFT LCD
Viewfinder	Color LCD
Connectors	
Video output	1Vp-p (75Ω terminated)
S-video output	Y: 1Vp-p, 75Ω, C: 0. 286Vp-p, 75Ω
Audio output	-7.5dBs (600Ω terminated)
USB output	Mini-B type connector
External Mic	Ø3.5 stereo

General	
Power source	DC 8.4V, Lithium Ion Battery Pack 7.4V
Power source type	Lithium Ion Battery Pack, Power supply (100V~240V) 50/60Hz
Power consumption (Recording)	5.2W (SC-DC163, LCD/Viewfinder), 5.4W (SC-DC164/DC165, LCD/Viewfinder)
Operating temperature	0~40°C (32°F~104°F)
Storage temperature	-20°C ~ 60°C (-4°F ~ 140°F)
External dimension	Height 2.02 inches (51.5 mm), Length 3.44 inches (87.5 mm), Width 4.78 inches (121.5 mm)
Weight	0.936 lb (425 g, 15.17 oz) (Except for Lithium Ion Battery Pack)
Internal MIC	Omni-directional stereo microphone
Remote control (SC-DC164/DC165 only)	Indoors: greater than 49 ft (15 m) (straight line), Outdoors: about 16.4 ft (5 m) (straight line)

- These technical specifications and design may be changed without notice.

Index

- A -		Function buttons 15	Playlist 62
Accessories 13		- H -	Power Source 25
Add 77		Hand Strap 19	Print Mark 107
AF/MF 52		- I -	Program AE 53
AV In/Out 88		Information 68,75,82	Protection 69,100
- B -		- J -	- Q -
Beep Sound 32		Joystick 26	Quick Menu 27
BLC 47		- L -	- R -
- C -		LCD 36	Record Mode 42
Clock Set 30		LED Light 49	Remote 31
Color Nite 48		Lithium Ion Battery Pack 21	Remote control 18
Connection 89		- O -	- S -
Copying 91,92		OSD Language 34	Shutter Sound 33
- D -		- M -	Shutter Speed 51
Date/Time 37		Memory Card 93	Photo images 97
Delete 79		Memory Stick 93	- T -
Deleting 70,76,101		Microphone 45	Title List 62
Demonstration 35		Move 78	- U -
Digital Effect 57		Moving Image 104	Unfinalize 87
Digital Zoom 61		- N -	USB Interface 111~118
DIS 60		Name 67,73,83	- V -
Disc Cleaning 7		- O -	Viewfinder 38
Discs 10		Operating Modes 26	- W -
- E -		OSD 28,29	White Balance 55
EASY.Q Mode 44		- P -	Wind Cut 50
Exposure 51		Partial Delete 71,80	- Z -
- F -		PB Zoom 66	Zoom 45
Fade 46		Photo Quality 95	
File No. 96		PictBridge 109	
Finalize 85			
Format 84,103			

Warranty (SEA users only)

SAMSUNG LIMITED WARRANTY

SAMSUNG Electronics America Inc. (SEA), warrants that this product is free from defective material and workmanship. SEA further warrants that if product fails to operate properly within the specified warranty period and the failure is due to improper workmanship or defective material, SEA will repair or replace the product at its option.

All warranty repairs must be performed by a SEA authorized service center. The name and address of the location nearest you can be obtained by calling toll free: 1-800 SAMSUNG (1-800-726-7864).

Labor

90 days carry-in

Parts

1 year

On carry-in models, transportation to and from the service center is the customer's responsibility.

The original dated sales receipt must be retained by the customer and is the only acceptable proof of purchase. It must be presented to the authorized service center.

EXCLUSIONS (WHAT IS NOT COVERED)

This warranty does not cover damage due to accident, fire, flood and/or other acts of God; misuse, incorrect line voltage, improper installation, improper or unauthorized repairs, commercial use, or damage that occurs in shipping.

Exterior and interior finish, lamps, and glass are not covered under this warranty.

Customer adjustments which are explained in the instruction manual are not covered under the terms of this warranty.

This warranty will automatically be voided for any unit found with a missing or altered serial number. This warranty is valid only on products purchased in the United States and Puerto Rico.

Some States do not allow the exclusions or limitations of incidental or consequential damages, or allow limitations on how long an implied warranty lasts, so the above limitations or exclusions may not apply to you.

This warranty gives you specific legal rights, and you may also have other rights which vary from State to State.

Contact SAMSUNG WORLD WIDE

If you have any questions or comments relating to Samsung products, please contact the SAMSUNG customer care center.

Region/Country	Customer	Care Center	Web Site
North America	CANADA	1-800-SAMSUNG (726-7864)	www.samsung.com/ca
	MEXICO	01-800-SAMSUNG (726-7864)	www.samsung.com/mx
	U.S.A.	1-800-SAMSUNG (726-7864)	www.samsung.com
Latin America	ARGENTINE	0800-333-3733	www.samsung.com/ar
	BRAZIL	0800-124-421	www.samsung.com/br
	CHILE	800-726-7864(SAMSUNG)	www.samsung.com/cl
	COSTA RICA	0-800-507-7267	www.samsung.com/cr
	ECUADOR	1-800-10-7267	www.samsung.com/ec
	EL SALVADOR	800-6225	www.samsung.com/sv
	GUATEMALA	1-800-299-0013	www.samsung.com/gt
	JAMAICA	1-800-234-7267	www.samsung.com/jm
	PANAMA	800-7267	www.samsung.com/pa
	PUERTO RICO	1-800-692-3180	www.samsung.com/pr
Europe	REP. DOMINICA	1-800-751-2676	www.samsung.com/dm
	TRINIDAD & TOBAGO	1-800-7267-864	www.samsung.com/td
	VENEZUELA	1-800-100-5303	www.samsung.com/ve
	BELGIUM	02 201 2418	www.samsung.com/be
	CZECH REPUBLIC	844 000 844	www.samsung.com/cz
	DENMARK	38 322 887	www.samsung.com/dk
	FINLAND	09 693 79 554	www.samsung.com/fi
	FRANCE	08 25 08 65 65 (0,15€/Min)	www.samsung.com/fr
	GERMANY	01805 - 121213 (€ 0,12/Min)	www.samsung.de
	HUNGARY	06 40 985 985	www.samsung.com/hu
Asia Pacific	ITALIA	199 153 153	www.samsung.com/it
	LUXEMBURG	02 261 93 710	www.samsung.lu
	NETHERLANDS	0900 20 200 88 (€ 0,10/Min)	www.samsung.com/nl
	NORWAY	231 627 22	www.samsung.com/no
	POLAND	0 801 801 881	www.samsung.com/pl
	PORTUGAL	80 8 200 128	www.samsung.com/pt
	SLOVAKIA	0850 123 989	www.samsung.com/sk
	SPAIN	902 10 11 30	www.samsung.com/es
	SWEDEN	08 585 367 87	www.samsung.com/se
	U.K.	0870 242 0303	www.samsung.com/uk
CIS	RUSSIA	8-800-200-0400	www.samsung.ru
	UKRAINE	8-800-502-0000	www.samsung.com/ua
Middle East & Africa	AUSTRALIA	1300 362 603	www.samsung.com/au
	CHINA	800-810-5868, 010- 6475 1880	www.samsung.com/cn
	HONG KONG	2862 6001	www.samsung.com/hk
	INDIA	3030 8282 1600 1100 11	www.samsung.com/in
	INDONESIA	0800-112-8888	www.samsung.com/id
	JAPAN	0120-327-527	www.samsung.com/jp
	MALAYSIA	1800-88-9999	www.samsung.com/my
Asia Pacific	PHILIPPINES	1800-10-SAMSUNG (7267864)	www.samsung.com/ph
	SINGAPORE	1800-SAMSUNG (7267864)	www.samsung.com/sg
	THAILAND	1800-29-3232 02-689-9232	www.samsung.com/th
	TAIWAN	0800-329-999	www.samsung.com/tw
	VIETNAM	800 588 889	www.samsung.com/vn
	SOUTH AFRICA	0860 7267864 (SAMSUNG)	www.samsung.com/za
	U.A.E.	800SAMSUNG (7267864)	www.samsung.com/ae

ENGLISH

THIS DVD CAMCORDER IS MANUFACTURED BY:



If you have any questions or comments relating to Samsung products, please contact the SAMSUNG customer care center

Samsung Electronics America, inc.

1-800-SAMSUNG (726-7864)

www.samsung.com



RoHS compliant

Our product complies with "The Restriction Of the use of certain Hazardous Substances in electrical and electronic equipment", and we do not use the 6 hazardous materials- Cadmium(Cd), Lead (Pb), Mercury (Hg), Hexavalent Chromium (Cr+6), Poly Brominated Biphenyls (PBBs), Poly Brominated Diphenyl Ethers(PBDEs)- in our products.

AD68-00993B