

SAMSUNG

SP-S4243

PLASMA DISPLAY



**Owner's
Instructions**

This device is a Class B digital apparatus.

Register your product at www.samsung.com/global/register

Important Warranty Information Regarding Television Format Viewing

Wide screen format PDP Displays (16:9, the aspect ratio of the screen width to height) are primarily designed to view wide screen format full-motion video. The images displayed on them should primarily be in the wide screen 16:9 ratio format, or expanded to fill the screen if your model offers this feature and the images are constantly moving. Displaying stationary graphics and images on screen, such as the dark side-bars on nonexpanded standard format television video and programming, should be limited to no more than 5% of the total television viewing per week.

Additionally, viewing other stationary images and text such as stock market reports, video game displays, station logos, web sites or computer graphics and patterns, should be limited as described above for all televisions. ***Displaying stationary images that exceed the above guidelines can cause uneven aging of PDP Displays that leave subtle, but permanent burned-in ghost images in the PDP picture. To avoid this, vary the programming and images, and primarily display full screen moving images, not stationary patterns or dark bars.***

On PDP models that offer picture sizing features, use these controls to view different formats as a full screen picture.

Be careful in the selection and duration of television formats used for viewing. Uneven PDP aging as a result of format selection and use, as well as burned-in images, are not covered by your Samsung limited warranty.

U.S.A Only

The product unit accompanying this user manual is licensed under certain intellectual property rights of certain third parties. In particular, this product is licensed under the following US patents: 5,991,715, 5,740,317, 4,972,484, 5,214,678, 5,323,396, 5,539,829, 5,606,618, 5,530,655, 5,777,992, 6,289,308, 5,610,985, 5,481,643, 5,544,247, 5,960,037, 6,023,490, 5,878,080, and under US Published Patent Application No. 2001-44713-A1.

This license is limited to private non-commercial use by end-user consumers for licensed contents. No rights are granted for commercial use. The license does not cover any product unit other than this product unit and the license does not extend to any unlicensed product unit or process conforming to ISO/IEC 11172-3 or ISO/IEC 13818-3 used or sold in combination with this product unit. The license only covers the use of this product unit to encode and/or decode audio files conforming to the ISO/IEC 11172-3 or ISO/IEC 13818-3. No rights are granted under this license for product features or functions that do not conform to the ISO/IEC 11172-3 or ISO/IEC 13818-3.

Other countries

The product unit accompanying this user manual is licensed under certain intellectual property rights of certain third parties. This license is limited to private non-commercial use by end-user consumers for licensed contents. No rights are granted for commercial use. The license does not cover any product unit other than this product unit and the license does not extend to any unlicensed product unit or process conforming to ISO/IEC 11172-3 or ISO/IEC 13818-3 used or sold in combination with this product unit. The license only covers the use of this product unit to encode and/or decode audio files conforming to the ISO/IEC 11172-3 or ISO/IEC 13818-3. No rights are granted under this license for product features or functions that do not conform to the ISO/IEC 11172-3 or ISO/IEC 13818-3.

User Instructions

● Screen Image retention

Do not display a still image (such as on a video game) on the plasma display panel for more than several minutes as it can cause screen image retention. This image retention is also known as "screen burn". To avoid such image retention, refer to page 26 of this manual to reduce the degree of brightness and contrast of the screen when displaying a still image.

● Altitude

The PDP can only operate normally at heights under 6500ft.

● Heat on the top of the PDP TV

The top side of the product may be hot after long periods of use as heat dissipates from the panel through the vent hole in the upper part of the product.

This is normal and does not indicate any defect or operation failure of the product. However, children should be prevented from touching the upper part of the product.

● The product is making a 'cracking' noise.

A 'cracking' noise may occur when the product contracts or expands due to a change of surrounding environment such as temperature or humidity. This is normal and not a defect of the unit.

● Cell Defects

The PDP uses a panel consisting of 1,230,000(SD-level) to 3,150,000(HD-level) pixels which require sophisticated technology to produce. However, there may be a few bright or dark pixels on the screen. These pixels will have no impact on the performance of the product.

● Avoid operating the TV at temperatures below 5°C (41°F)

● A still image displayed too long may cause permanent damage to the PDP Panel.

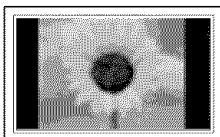

Watching the PDP TV in 4:3 format for a long period of time may leave traces of borders displayed on the left, right and center of the screen caused by the difference of light emission on the screen.

Playing a DVD or a game console may cause similar effect to the screen.

Damages caused by the above effect are not covered by the Warranty.

● Afterimage on the Screen.

Displaying still images from Video games and PC for longer than a certain period of time may produce partial after-images.

To prevent this effect, reduce the 'brightness' and 'contrast' when displaying still images for a long time.

● Warranty

Warranty does not cover any damage caused by image retention.

Burn-in is not covered by the warranty.

Contents

GENERAL INFORMATION

■ List of Features	5
■ Accessories	5
■ Viewing the Control Panel	6
■ Viewing the Connection Panel	7
■ Remote Control	8
■ Installing Batteries in the Remote Control	9

CONNECTIONS

■ Connecting VHF and UHF Antennas	9
■ Connecting Cable TV	10
■ Connecting a VCR	11
■ Connecting an S-VHS VCR	11
■ Connecting a Camcorder	12
■ Connecting a DVD Player/Set-Top Box	12
■ Connecting a DVD Player/Set-Top Box via DVI	12
■ Connecting a DVD Player/Set-Top Box via HDMI	13
■ Connecting a Digital Audio System	13
■ Connecting an Amplifier/DVD Home Theater	14
■ Connecting a PC	14

OPERATION

■ Turning the TV On and Off	15
■ Plug & Play Feature	15
■ Changing Channels	17
■ Adjusting the Volume	18
■ Viewing the Display	18
■ Viewing the Menus	18
■ Memorizing the Channels	19
■ Setting Up Your Remote Control	20
■ To Select the Source	25
■ To Edit the Input Source Name	25

PICTURE CONTROL

■ Using Automatic Picture Settings	26
■ Digital Noise Reduction	27
■ Changing the Screen Size	28
■ DNLe (Digital Natural Image engine)	29
■ Selecting the Film Mode	29
■ Setting the Blue Screen Mode	29
■ Viewing Picture-in-Picture	30
■ Freezing the Current Picture	31

SOUND CONTROL

■ Using Automatic Sound Settings	32
■ Customizing the Sound	32
■ Setting the TruSurround XT	33
■ Choosing a Multi-Channel Sound (MTS) track - Digital	33
■ Choosing a Multi-Channel Sound (MTS) track - Analog	34
■ Automatic Volume Control	34
■ Selecting the Internal Mute	35
■ Setting the On/Off Melody	35
■ Listening to the Sound of the Sub (PIP) Picture	35

CHANNEL CONTROL

■ Selecting the Antenna	36
■ Adding and Erasing Channels	36
■ To set-up Your Favorite Channels	37
■ Viewing the Channel Lists	38
■ Setting the Default Channel List Mode	38
■ Labeling Channels	39
■ Fine Tuning Analog Channels	39
■ Checking the Digital-Signal Strength	40
■ LNA (Low Noise Amplifier)	40

PC DISPLAY

■ Using Your TV as a Computer (PC) Display	41
■ Display Modes	41
■ Setting up the TV with your PC	42

TIME SETTING

■ Setting the Time	44
--------------------------	----

FUNCTION DESCRIPTION

■ Selecting a Menu Language	47
■ Using the Game Mode	47
■ Viewing Closed Captions (On-Screen Text Messages) - Digital ..	48
■ Viewing Closed Captions (On-Screen Text Messages) - Analog ..	49
■ Menu Transparency Level	50
■ Using the Energy Saving Feature	50
■ Preventing Screen Burn-in	51
■ Reducing the Effects of Screen Burn	51
■ Setting the Function Help	52
■ Setting the Blue Eye	52
■ Using the V-Chip	53

APPENDIX

■ Identifying Problems	59
■ Wall Installation Instructions	60
■ How to assemble the Stand-Base	62
■ Specifications	62
■ Dimensions	63



General Information

List of Features

- Adjustable picture settings that can be stored in the TV's memory.
- Automatic timer to turn the TV on and off.
- A special sleep timer.
- V-Chip function.
- Excellent Digital Interface & Networking :
With a built-in HD digital tuner, non-subscription HD broadcasts can be viewed with no Set-Top Box needed.
- Remote Control
The supplied remote can be used to operate the TV as well as most DVD players, Set-top boxes, Cable Boxes and VCRs.
- Excellent Picture Quality
 - DNIe technology provides life-like clear images.
- SRS TruSurround XT
 - SRS TruSurround XT provides a virtual Dolby surround system.

Accessories

Please make sure the following items are included with your TV.
If any items are missing, contact your dealer.

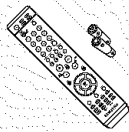

Remote Control
(BN59-00511A) /
AAA Batteries
(4301-000103)



Power Cord
(3903-000144)

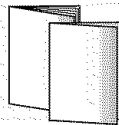

Owner's Instructions
(BN68-00991D) /
Quick Setup Guide
(BN68-00766P)



Warranty Card
(BN68-00872A, 6801-001011) /
Registration Card (AA68-40065B) /
Safety Guide Manual (AA68-03242F)
(Not available in all locations)

The following parts are sold separately and are available at most electronics stores.

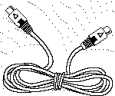

S-VIDEO Cable
(BN39-00149A)

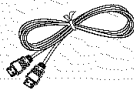

HDMI Cable
(BN39-00641A)

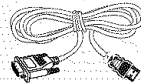

HDMI/DVI cable
(BN39-00643A)



Component Cables (RCA)
(BN39-00279A)

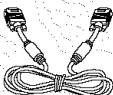

PC Cable
(BN39-00115A)

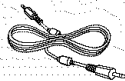

PC Audio Cable
(BN39-00061B)

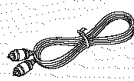

Optical Cable

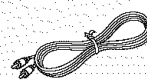

Coaxial Cable
(BN39-00110A)

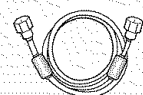

Antenna Cable
(BN39-00333A)

Viewing the Control Panel

Buttons on the Lower-Right Part of the Panel

The buttons on the lower-right panel control your TV's basic features, including the on-screen menu.

To use the more advanced features, you must use the remote control. The product color and shape may vary depending on the model.

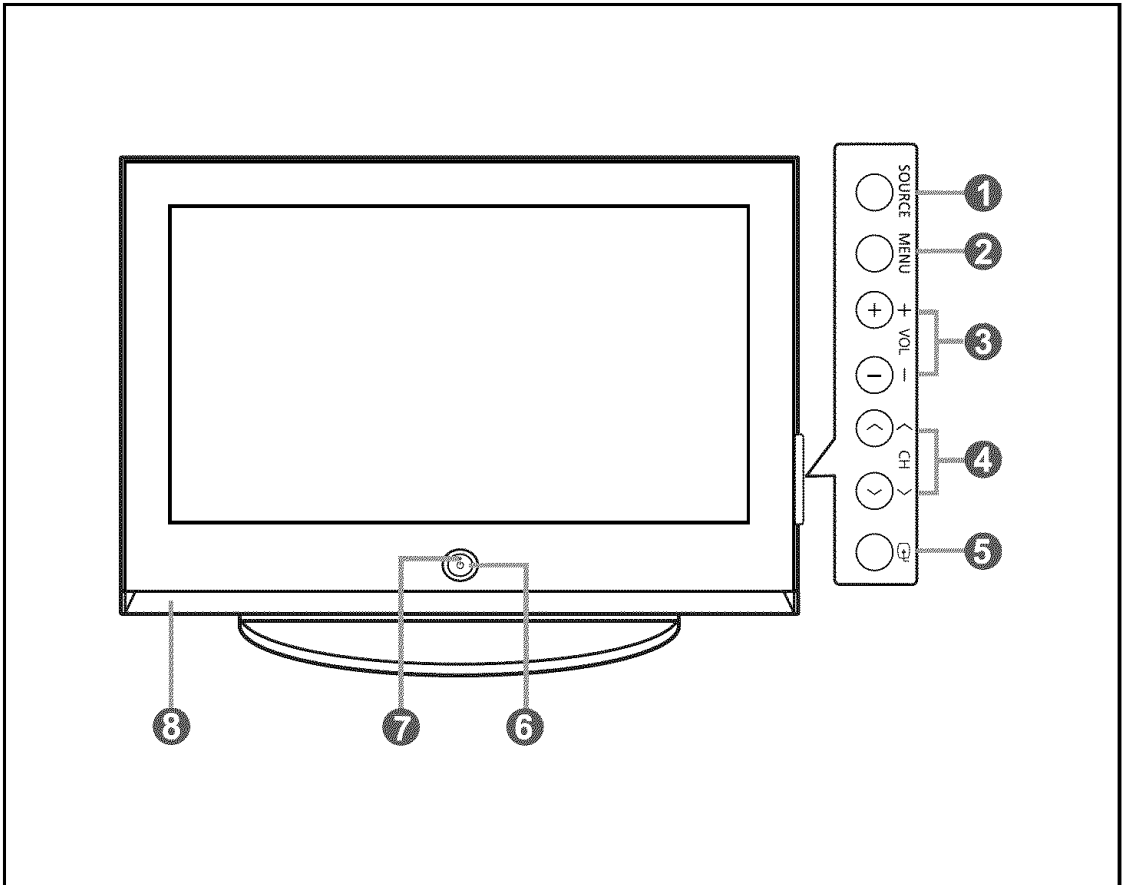

- 1 SOURCE**
Toggles between all the available input sources (TV, AV1, AV2, S-Video1, S-Video2, Component1, Component2, PC, HDMI1, HDMI2).
- 2 MENU**
Press to see an on-screen menu of your TV's features.
- 3 + VOL -**
Press to increase or decrease the volume.
In the on-screen menu, use the + VOL - buttons as you would use the ◀ and ▶ buttons on the remote control.
- 4 ^ CH v**
Press to change channels.
In the on-screen menu, use the ^ CH v buttons as you would use the ▲ and ▼ buttons on the remote control.
- 5 [ENTER] (ENTER)**
Press to confirm a selection.
- 6 POWER**
Press to turn the TV on and off.
Power Indicator
Blinks and turns off when the power is on and lights up in stand-by mode.
- 7 Remote Control Sensor**
Aim the remote control towards this spot on the TV.
- 8 Speakers**

Viewing the Connection Panel

Rear Panel Jacks

Use the rear panel jacks to connect A/V components that will be connected continuously, such as VCR or DVD players. For more information on connecting equipment, see pages 9-14. The product color and shape may vary depending on the model.

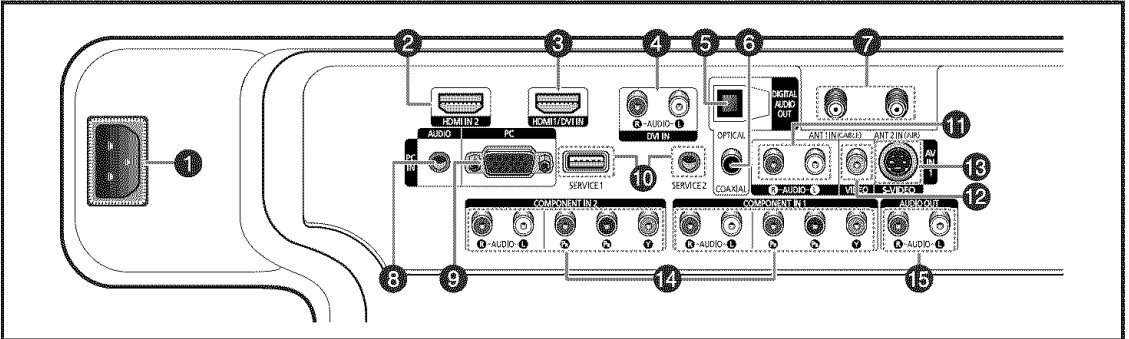

- 1 POWER IN**
Connect the supplied power cord.
- 2 HDMI IN 2**
Connect to the HDMI jack of a device with HDMI output.
- 3 HDMI 1/DVI IN**
Connect to the HDMI jack of a device with HDMI output. This input can also be used as a DVI connection with separate analog audio inputs. An optional HDMI/DVI cable will be necessary to make this connection. When using an optional HDMI/DVI adapter, the DVI analog audio inputs on your TV allow you to receive left and right audio from your DVI device. (Not compatible with PC)
- 4 DVI IN (AUDIO-L/R)**
Connect to the DVI audio output jack of an external device.
- 5 OPTICAL DIGITAL AUDIO OUT**
Connect to a Digital Audio component.
- 6 COAXIAL DIGITAL AUDIO OUT**
Connect to a Digital Audio component.
- 7 ANT 1 IN (CABLE)/ANT 2 IN (AIR)**
75Ω Coaxial connector for Antenna/Cable Network.
- 8 PC AUDIO IN**
Connect to the audio output jack on your PC.
- 9 PC IN**
Connect to the video output jack on your PC.
- 10 SERVICE 1/SERVICE 2**
These jacks are for service purposes only.
- 11 AUDIO-L/R (AV IN 1)**
Audio inputs for external devices, such as a camcorder or VCR.
- 12 VIDEO (AV IN 1)**
Video input for external devices, such as a camcorder or VCR.
- 13 S-VIDEO (AV IN 1)**
Video input for external devices with an S-Video output, such as a camcorder or VCR.
- 14 COMPONENT IN 1, 2**
Video (Y/Pb/Pr) and audio (L-AUDIO-R) component inputs.
- 15 AUDIO OUT**
Audio outputs for external devices.

Side Panel Jacks

Use the left side panel jacks to connect a component that is used only occasionally, such as a camcorder or video game. (See page 12) The product color and shape may vary depending on the model.

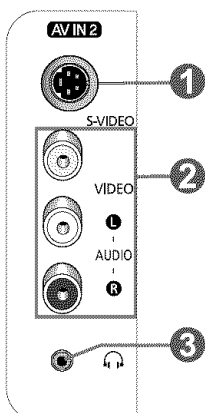

- 1 S-VIDEO IN 2**
S-Video input for external devices with an S-Video output.
- 2 AV IN 2**
Video and audio inputs for external devices.
- 3 HEADPHONE**
You can connect a set of headphones to your television if you wish to watch a television program without disturbing other people in the room.

Remote Control

You can use the remote control up to a distance of about 23 feet from the TV. When using the remote, always point it directly at the TV. You can also use your remote control to operate your VCR, Cable box, DVD player, or Set-Top Box.

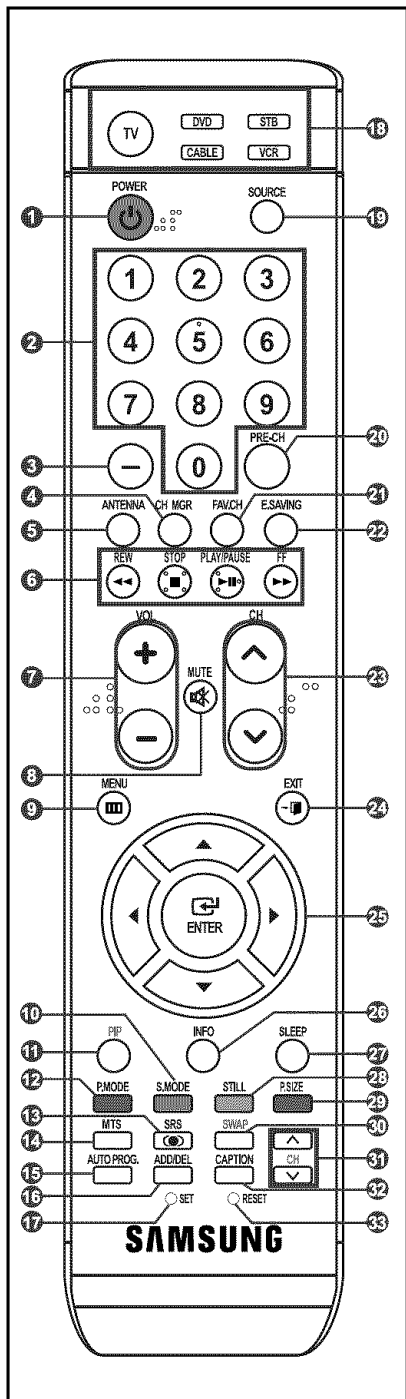

- 1 POWER**
Turns the TV on and off.
- 2 NUMERIC BUTTONS**
Press to change the channel.
- 3 -**
Press to select additional channels (digital and analog) being broadcast by the same station. For example, to select channel "54-3", press "54", then press "-" and "3".
- 4 CH MGR**
Used to display Channel Lists on the screen.
- 5 ANTENNA**
Press to select "AIR" or "CABLE".
- 6 VCR/DVD Functions**
- Rewind
- Stop
- Play/Pause
- Fast/Forward
- 7 + VOL -**
Press to increase or decrease the volume.
- 8 MUTE**
Press to temporarily cut off the sound.
- 9 MENU**
Displays the main on-screen menu.
- 10 S.MODE**
Press to select the sound mode.
- 11 PIP**
Picture-in Picture ON/OFF.
- 12 P.MODE**
Press to select the picture mode.
- 13 SRS**
Selects SRS TruSurround XT mode.
- 14 MTS**
Press to choose stereo, mono or Separate Audio Program (SAP broadcast).
- 15 AUTO PROG.**
Press to automatically store selected TV/Cable channels.
- 16 ADD/DEL**
Use to store and delete channels to/from memory.
- 17 SET**
Sets the remote to control your TV, VCR, Cable, DVD, or Set-Top Box.
- 18 TV, DVD, STB, CABLE, VCR**
Press to operate your TV, DVD, STB, CABLE (box), or VCR.
- 19 SOURCE**
Press to display all of the available video sources.
- 20 PRE-CH**
Tunes to the previous channel.
- 21 FAV.CH**
Press to switch to your favorite channels.
- 22 E.SAVING**
Adjusts screen brightness to save energy.
- 23 ^ CH v**
Press to change channels.
- 24 EXIT**
Press to exit the menu.
- 25 UP ▲ / DOWN ▼ / LEFT ◀ / RIGHT ▶ / ENTER**
Use to select on-screen menu items and change menu values.
- 26 INFO**
Press to display information on the TV screen.
- 27 SLEEP**
Press to select a preset time interval for automatic shut off.
- 28 STILL**
Press to stop the action during a particular scene. Press again to resume normal video.
- 29 P.SIZE**
Press to change the screen size.
- 30 SWAP**
Switches the main and sub (PIP) picture.
- 31 CH**
Displays the available channels in sequence. (These buttons change channels in the PIP window only.)
- 32 CAPTION**
Controls the caption decoder.
- 33 RESET**
When your remote does not work, change the batteries and press the RESET button for 2-3 seconds before use.

➤ This is a special remote control for the visually impaired, and has Braille points on the Power, Channel and Volume buttons.

Installing Batteries in the Remote Control

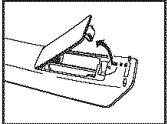

1. Lift the cover at the back of the remote control upward as shown in the figure.
2. Install two AAA size batteries.
 - Make sure to match the "+" and "-" ends of the batteries with the diagram inside the compartment.
3. Replace the cover.
 - Remove the batteries and store them in a cool, dry place if you won't be using the remote control for a long time. The remote control can be used up to about 23 feet from the TV. (Assuming typical TV usage, the batteries last for about one year.)

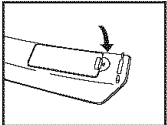
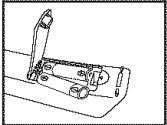

- **If the remote control doesn't work, check the following:**
1. Is the TV power on?
 2. Are the plus and minus ends of the batteries reversed?
 3. Are the batteries drained?
 4. Is there a power outage, or is the power cord unplugged?
 5. Is there a special fluorescent light or neon sign nearby?

Connections

Connecting VHF and UHF Antennas

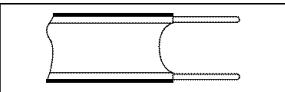

If your antenna has a set of leads that look like this, see "Antennas with 300 Ω Flat Twin Leads" below.

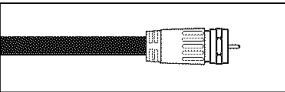

If your antenna has one lead that looks like this, see "Antennas with 75 Ω Round Leads".
If you have two antennas, see "Separate VHF and UHF Antennas".

Antennas with 300 Ω Flat Twin Leads

If you are using an off-air antenna (such as a roof antenna or "rabbit ears") that has 300 Ω twin flat leads, follow the directions below.

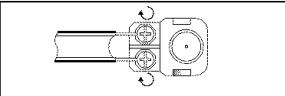

1. Place the wires from the twin leads under the screws on a 300-75 Ω adaptor (not supplied).
Use a screwdriver to tighten the screws.

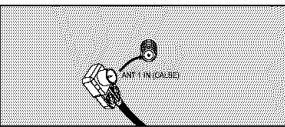

2. Plug the adaptor into the ANT 1 IN (CABLE) terminal on the back of the TV.

Antennas with 75 Ω Round Leads

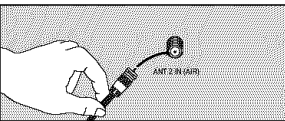

1. Plug the antenna lead into the ANT 2 IN (AIR) terminal on the back of the TV.

Separate VHF and UHF Antennas

If you have two separate antennas for your TV (one VHF and one UHF), you must combine the two antenna signals before connecting the antennas to the TV. This procedure requires an optional combiner-adaptor (available at most electronics shops).

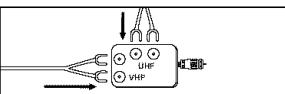

1. Connect both antenna leads to the combiner.

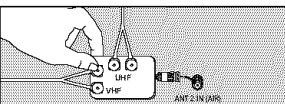

2. Plug the combiner into the ANT 2 IN (AIR) terminal on the bottom of the back panel.

Connecting Cable TV

To connect to a cable TV system, follow the instructions below.

Cable without a Cable Box

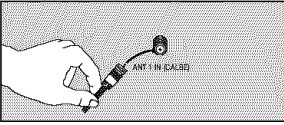

1. Plug the incoming cable into the ANT 1 IN (CABLE) terminal on the back of the TV.
 - Because this TV is cable-ready, you do not need a cable box to view unscrambled cable channels.

Connecting to a Cable Box that Descrambles All Channels

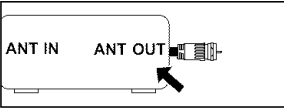

1. Find the cable that is connected to the ANT OUT terminal on your cable box.
 - This terminal might be labeled "ANT OUT", "VHF OUT" or simply, "OUT".

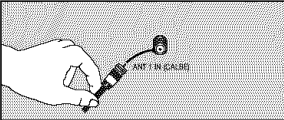

2. Connect the other end of this cable to the ANT 1 IN (CABLE) terminal on the back of the TV.

Connecting to a Cable Box that Descrambles Some Channels

If your cable box descrambles only some channels (such as premium channels), follow the instructions below. You will need a two-way splitter, an RF (A/B) switch, and four lengths of Antenna cable. (These items are available at most electronics stores.)

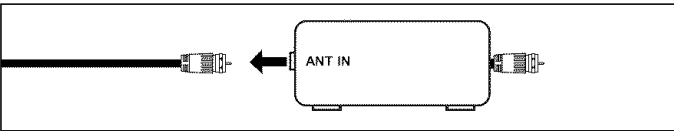

1. Find and disconnect the cable that is connected to the ANT IN terminal on your cable box.
 - This terminal might be labeled "ANT IN", "VHF IN" or simply, "IN".

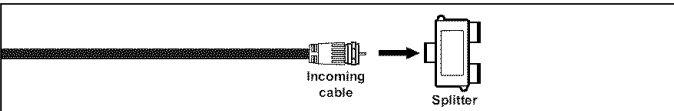

2. Connect this cable to a two-way splitter.

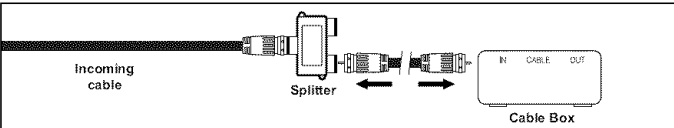

3. Connect an Antenna cable between an OUTPUT terminal on the splitter and the IN terminal on the cable box.

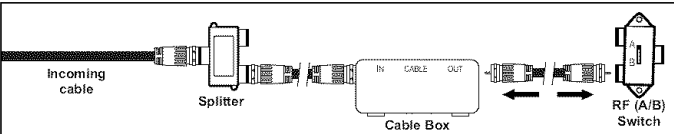

4. Connect an Antenna cable between the ANT OUT terminal on the cable box and the B-IN terminal on the RF (A/B) switch.

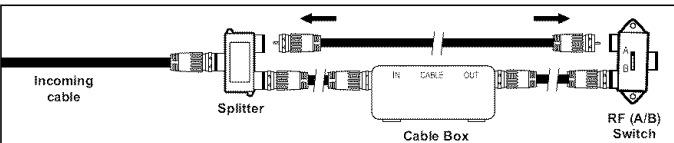

5. Connect another cable between the other OUTPUT terminal on the splitter and the A-IN terminal on the RF (A/B) switch.

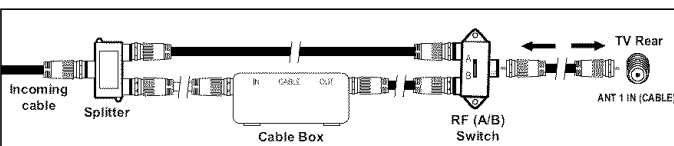

6. Connect the last Antenna cable between the OUT terminal on the RF (A/B) switch and the ANT 1 IN (CABLE) terminal on the rear of the TV.

After you have made this connection, set the A/B switch to the "A" position for normal viewing. Set the A/B switch to the "B" position to view scrambled channels. (When you set the A/B switch to "B", you will need to tune your TV to the cable box's output channel, which is usually channel 3 or 4.)

Connecting a VCR

These instructions assume that you have already connected your TV to an antenna or a cable TV system (according to the instructions on pages 9-10). Skip step 1 if you have not yet connected to an antenna or a cable system.

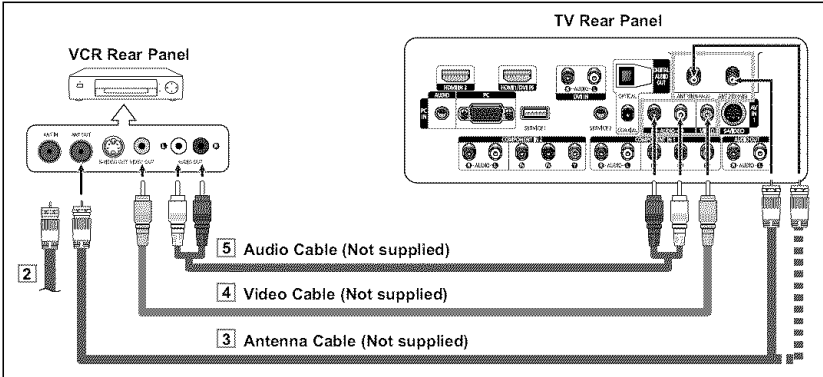
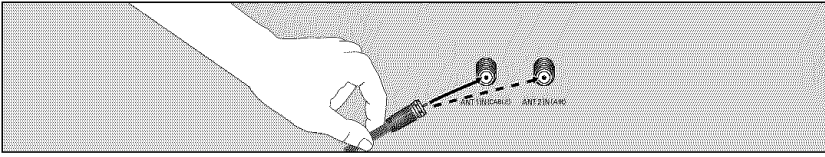

- Each external input source device has a different back panel configuration.
- When connecting an external device, match the color of the connection terminal to the cable.

1. Unplug the cable or antenna from the back of the TV.
2. Connect the cable or antenna to the ANT IN terminal on the back of the VCR.
3. Connect an Antenna Cable between the ANT OUT terminal on the VCR and the ANT 1 IN (CABLE) or ANT 2 IN (AIR) terminal on the TV.
4. Connect a Video Cable between the VIDEO OUT jack on the VCR and the AV IN 1 [VIDEO] jack on the TV.
5. Connect Audio Cables between the AUDIO OUT jacks on the VCR and the AV IN 1 [R-AUDIO-L] jacks on the TV.

➤ If you have a "mono" (non-stereo) VCR, use a Y-connector (not supplied) to hook up to the right and left audio input jacks of the TV. If your VCR is stereo, you must connect two cables.

Connecting an S-VHS VCR

Your Samsung TV can be connected to an S-Video signal from an S-VHS VCR. (This connection delivers a better picture as compared to a standard VHS VCR.)

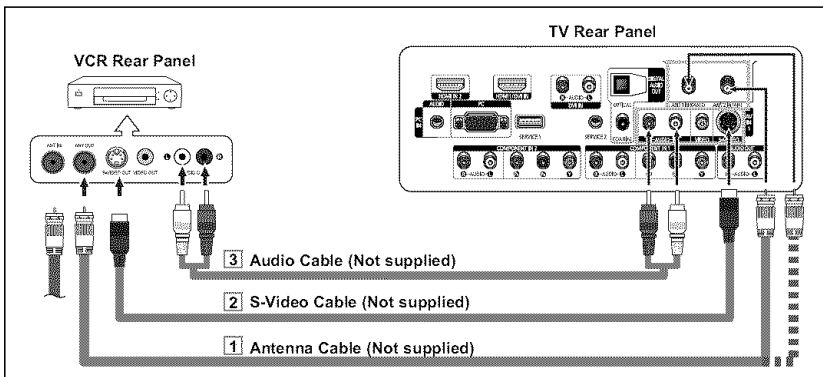

An S-Video cable is usually included with an S-VHS VCR. (If not, check your local electronics store.)

- Each external input source device has a different back panel configuration.
- When connecting an external device, match the color of the connection terminal to the cable.

1. To begin, follow steps 1-3 in the previous section to connect the antenna or cable to your VCR and your TV.
2. Connect an S-Video Cable between the S-VIDEO OUT jack on the VCR and the AV IN 1 [S-VIDEO] jack on the TV.
3. Connect Audio Cables between the AUDIO OUT jacks on the VCR and the AV IN 1 [R-AUDIO-L] jacks on the TV.

Connecting a Camcorder

The side panel jacks on your TV make it easy to connect a camcorder to your TV. They allow you to view the camcorder tapes without using a VCR.

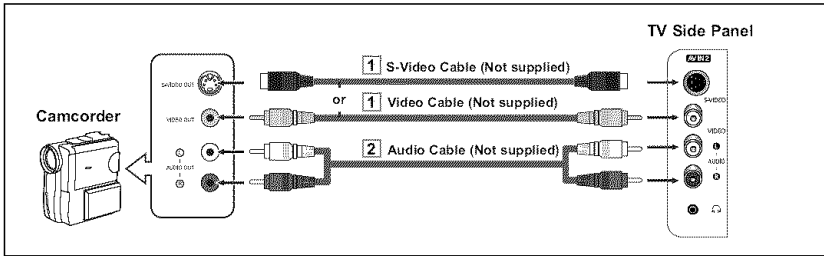

- Each external input source device has a different back panel configuration.
- When connecting an external device, match the color of the connection terminal to the cable.

1. Connect a Video Cable (or S-Video Cable) between the AV IN 2 [VIDEO] (or S-VIDEO) jack on the TV and the VIDEO OUT jack on the camcorder.
2. Connect Audio Cables between the AV IN 2 [R-AUDIO-L] jacks on the TV and the AUDIO OUT jacks on the camcorder.

Connecting a DVD Player/Set-Top Box

The rear panel jacks on your TV make it easy to connect a DVD player/Set-Top Box to your TV.

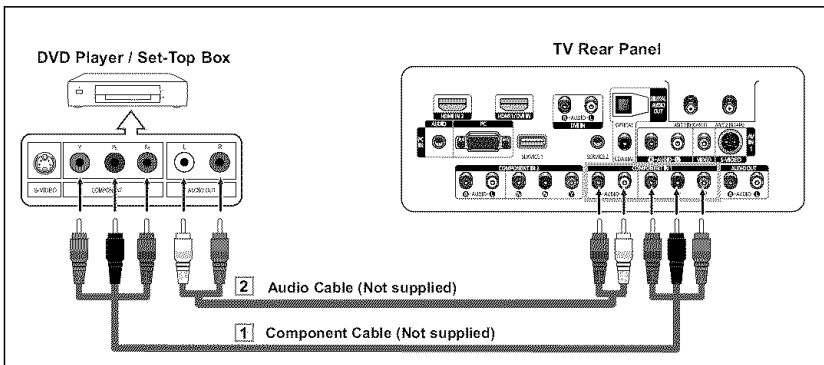

- Component video separates the video into Y (Luminance (brightness)), Pb (Blue) and Pr (Red) for enhanced video quality. Be sure to match the component video and audio connections. For example, if connecting the video cable to COMPONENT IN, connect the audio cable to COMPONENT IN also.
- Each external input source device has a different back panel configuration.
- When connecting an external device, match the color of the connection terminal to the cable.

1. Connect a Component Cable between the COMPONENT IN 1 [P_R, P_B, Y] (or COMPONENT IN 2 [P_R, P_B, Y]) jacks on the TV and the COMPONENT [Y, P_B, P_R] jacks on the DVD player/Set-Top Box.
2. Connect Audio Cables between the COMPONENT IN 1 [R-AUDIO-L] (or COMPONENT IN 2 [R-AUDIO-L]) jacks on the TV and the AUDIO OUT jacks on the DVD player/Set-Top Box.

Connecting a DVD Player/Set-Top Box via DVI

This connection can only be made if there is a DVI Output jack on the external device.

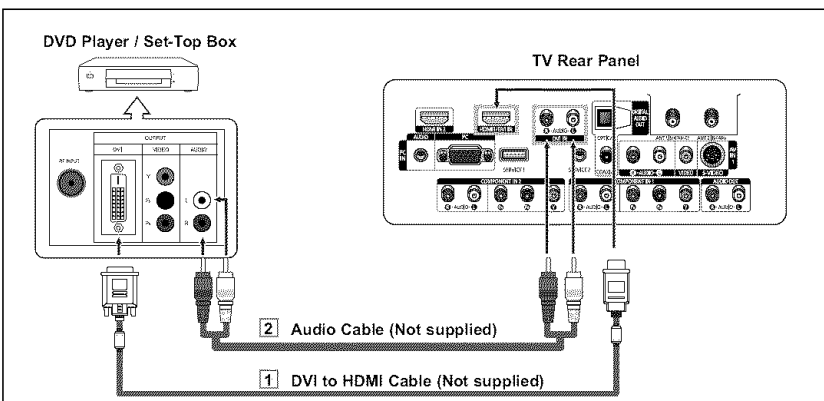

- Each external input source device has a different back panel configuration.
- When connecting an external device, match the color of the connection terminal to the cable.

1. Connect a DVI to HDMI Cable or DVI-HDMI Adapter between the HDMI 1/DVI IN jack on the TV and the DVI jack on the DVD player/Set-Top Box.
2. Connect Audio Cables between the DVI IN [R-AUDIO-L] jack on the TV and the AUDIO OUT jacks on the DVD player/Set-Top Box.

Connecting a DVD Player/Set-Top Box via HDMI

This connection can only be made if there is an HDMI Output jack on the external device.

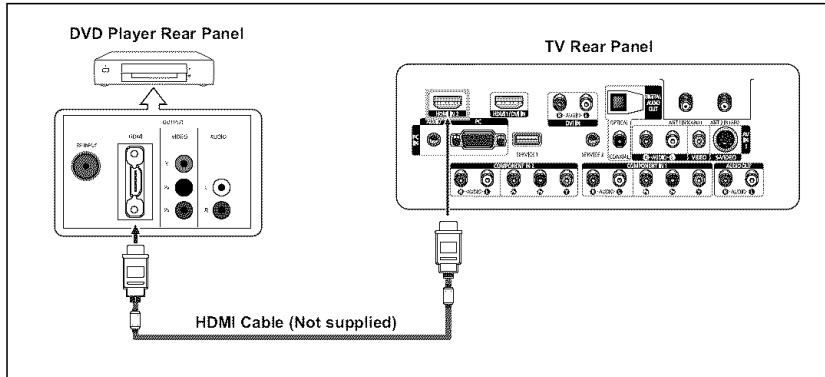

1. Connect an HDMI Cable between the HDMI IN 2 jack on the TV and the HDMI jack on the DVD player/ Set-Top Box.

What is HDMI?

- HDMI, or high-definition multimedia interface, is a next-generation interface that enables the transmission of digital audio and video signals using a single cable without compression.
- HDMI allows multiple channels of digital audio (5.1 channels).

The difference between HDMI and DVI is that the HDMI cable and plug is smaller in size, has the HDCP (High Bandwidth Digital Copy Protection) coding feature installed, and supports multi-channel digital audio.

- Each external input source device has a different back panel configuration.

Connecting a Digital Audio System

The rear panel jacks on your TV make it easy to connect a Digital Audio System to your TV.

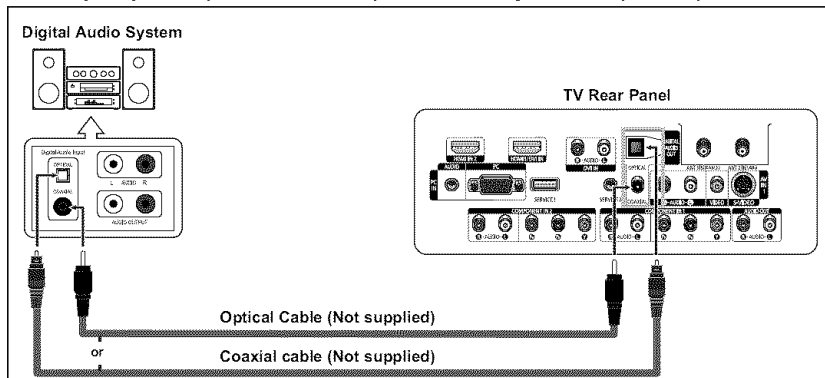

1. Connect an Optical or Coaxial Cable between the DIGITAL AUDIO OUT (OPTICAL or COAXIAL) jacks on the TV and the Digital Audio Input jacks on the Digital Audio System.

When a Digital Audio System is connected to the "DIGITAL AUDIO OUT (OPTICAL or COAXIAL)" terminal:
Decrease the gain (volume) of the TV, and adjust the volume level with the system's volume control.

What is OPTICAL:?

- Converts the electric signal into an optical light signal, and transmits it through glass fibers.

What is COAXIAL:?

- The digital audio signal is received through a coaxial copper cable.

- 5.1CH audio is possible when the TV is connected to an external device supporting 5.1CH.

Connecting an Amplifier/DVD Home Theater

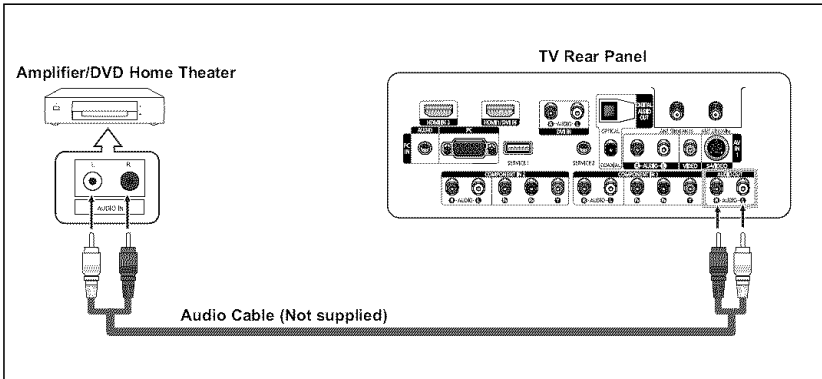

- Each external input source device has a different back panel configuration.
- When connecting an external device, match the color of the connection terminal to the cable.

1. Connect Audio Cables between the AUDIO OUT [R-AUDIO-L] on the TV and AUDIO IN [R-AUDIO-L] on the Amplifier/DVD Home Theater.

When an audio amplifier is connected to the "AUDIO OUT [R-AUDIO-L]" terminals: Decrease the gain (volume) of the TV, and adjust the volume level with the Amplifier's volume control.

Connecting a PC

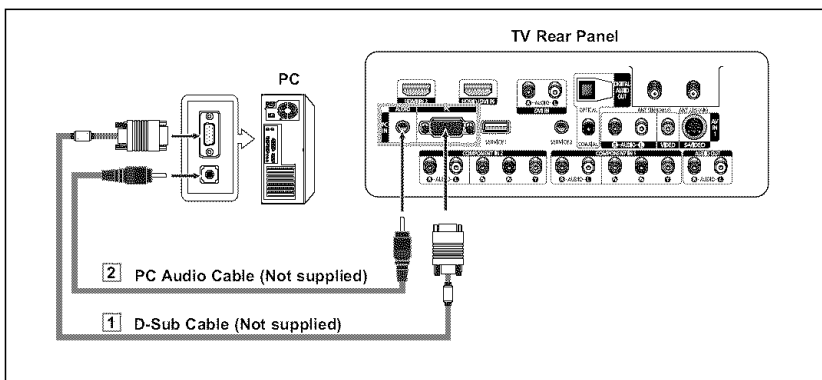

- Each external input source device has a different back panel configuration.
- When connecting an external device, match the color of the connection terminal to the cable.
- The HDMI/DVI jacks do not support PC connection.

1. Connect a D-Sub Cable between PC IN [PC] jack on the TV and the PC output jack on your computer.
2. Connect a PC Audio Cable between PC IN [AUDIO] jack on the TV and the Audio Out jack of the sound card on your computer.

	Internal Speakers			Audio Out (Optical, Coaxial, L/R Out)		
	TV	AV, S-Video	Component, PC, HDMI	TV	AV, S-Video	Component, PC, HDMI
Internal Mute Off	Speaker Output	Speaker Output	Speaker Output	Sound Output	Sound Output	Sound Output
Internal Mute On	Mute	Mute	Mute	Sound Output	Sound Output	Sound Output
Video No Signal	Mute	Mute	Mute	Mute	Mute	Mute

When "Internal Mute" is set to "On", Sound menus except "Multi-Track Options" and "Digital Output" cannot be adjusted.

Operation

Turning the TV On and Off



Press the **POWER** button on the remote control.
You can also use the **POWER** button on the TV.

Plug & Play Feature

When the TV is initially powered On, basic customer settings proceed automatically and subsequently:



1. Press the **POWER** button on the remote control.
The message "Menu language, Channels and Time will be set." is displayed.
Press the **ENTER** button, then "Select the language of the OSD" menu is automatically displayed.



2. Press the **ENTER** button to enter the language.
Press the **▲** or **▼** button to select language, then press the **ENTER** button.
"Select the antennas to memorize." menu is automatically displayed.

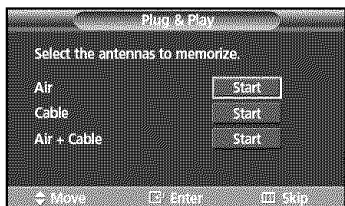

3. Press the **▲** or **▼** button to memorize the channels of the selected connection.
Press the **ENTER** button to select "Start".
 - If the antenna is connected to ANT 2 IN (AIR), select "Air" and if it is connected to ANT 1 IN (CABLE), select "Cable".
 - If both ANT 2 IN (AIR) and ANT 1 IN (CABLE) are connected, select the "Air + Cable".
 - In Cable mode, you can select the correct signal source among STD, HRC, and IRC by pressing the **▲** or **▼** button, then press the **ENTER** button.
Contact your local cable company to identify the type of cable system that exists in your particular area.

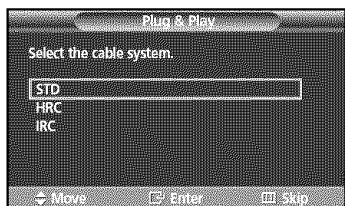

Continued...

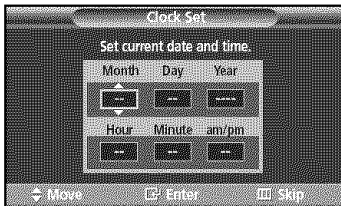
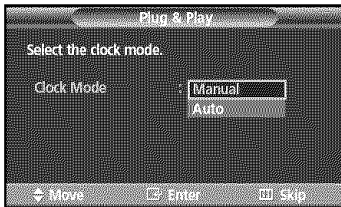
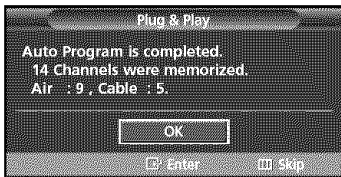
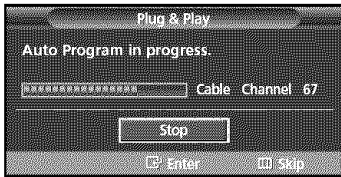

4. The TV will begin memorizing all of the available channels. After all the available channels are stored, the Auto program menu reappears. Press the **ENTER** button when channel memorization is complete. "Clock Mode" menu is automatically displayed.
 - To stop the search before it has finished, press the **ENTER** button with Stop selected.

5. Press the **ENTER** button. Press the **▲** or **▼** button to select "Manual" for setting the current time manually, then press the **ENTER** button. "Set current date and time." is displayed.
 - If you select "Auto", "Set to daylight savings time." is displayed, then go to step 8.

6. Press the **◀** or **▶** button to move to "Month", "Day", "Year", "Hour", "Minute", or "am/pm". Set the date and time you want by pressing the **▲** or **▼** button, then press the **MENU** button.
 - You can set the month, day, year, hour and minute directly by pressing the number buttons on the remote control.

7. The message "Enjoy your watching." is displayed. When you have finished, press the **ENTER** button.
 - Even if the **ENTER** button is not pressed, the message will automatically disappear after several seconds.

Setting the Clock Automatically



8. Press the **ENTER** button. Press the **▲** or **▼** button to select "No" or "Yes", then the **ENTER** button. "Select the time zone in which you live." menu is automatically displayed.
9. Press the **▲** or **▼** button to highlight the time zone for your local area (and to move the highlight to the appropriate time zone on the map of the United States). Press the **ENTER** button. If not, see page 44 to set the clock.
10. The message "Enjoy your watching." is displayed. When you have finished, press the **ENTER** button.
 - Even if the **ENTER** button is not pressed, the message will automatically disappear after several seconds.

If you want to reset this feature...

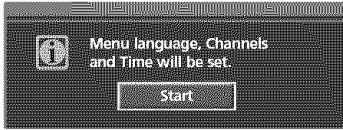

1. Press the **MENU** button to display the menu.
Press the **▲** or **▼** button to select "Setup", then press the **ENTER** button.
 2. Press the **ENTER** button to select "Plug & Play".
For further details on setting up options, refer to the page 15~16.
- Plug & Play can only be accessed in the TV mode.

Changing Channels

Using the Channel Buttons

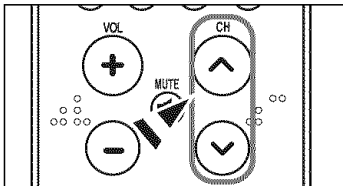

1. Press the **CH ▲** or **CH ▼** button to change channels.
 - When you press the **CH ▲** or **CH ▼** button, the TV changes channels in sequence. You will see all the channels that the TV has memorized. (The TV must have memorized at least three channels). You will not see channels that were either erased or not memorized. See page 19 to memorize channels.

Using the Number Buttons

Use the number buttons to quickly tune to any channel.

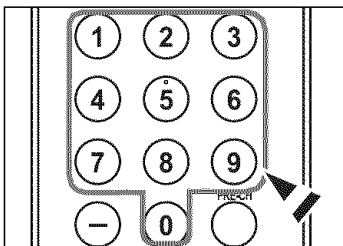

1. Press the number buttons to go directly to a channel.
For example, to select channel 27, press "2," then "7."
The TV will change channels when you press the second number.

Using the "-" Button

The "-" button is used to select stations that broadcast both a digital and analog signal.

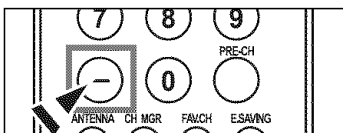

1. For example, for Channel 7-1 (digital), press "7", then "-", then "1".
For channel 7-2 (analog), press "7", then "-", then "2".
 - HD indicates the TV is receiving a Digital High Definition signal.
 - SD indicates the TV is receiving a Standard Definition signal.
 - For quick channel change, press the number buttons, then press the **ENTER** button.

Using the PRE-CH Button to select the Previous Channel

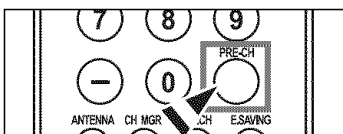

1. Press the **PRE-CH** button.
The TV will switch to the last channel viewed.
 - To quickly switch between two channels that are far apart, tune to one channel, then use the number button to select the second channel. Then use the **PRE-CH** button to quickly alternate between them.

Adjusting the Volume

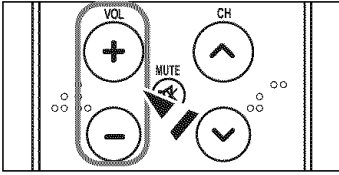

1. Press the **VOL +** or **VOL –** button to increase or decrease the volume.

Using the Mute Button

At any time, you can cut off the sound using the **MUTE** button.

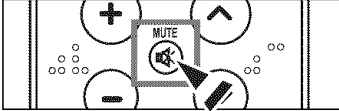

1. Press **MUTE** and the sound cuts off.
The word "**Mute**" will appear in the lower-left corner of the screen.
2. To turn mute off, press the **MUTE** button again, or simply press the **VOL +** or **VOL –** button.

Viewing the Display

The display identifies the current channel and the status of certain audio-video settings.

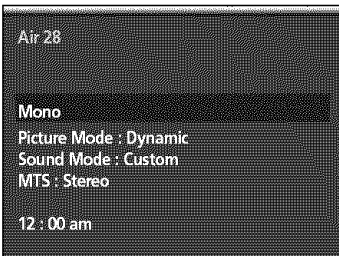

1. Press the **INFO** button on the remote control.

The TV will display the channel, the type of sound, and the status of certain picture and sound settings.

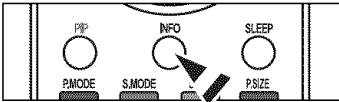

- Press the **INFO** button once more or wait approximately 10 seconds and it disappears automatically.

Viewing the Menus

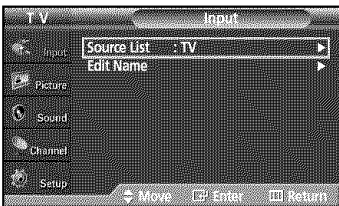

1. With the power on, press the **MENU** button.
The main menu appears on the screen. Its left side has five icons: Input, Picture, Sound, Channel, Setup.
2. Use the **▲** or **▼** button to select one of the five icons.
Then press the **ENTER** button to access the icon's sub-menu.
3. Press the **EXIT** button to exit.



- The on-screen menus disappear from the screen after a few seconds.

Memorizing the Channels

Your TV can memorize and store all of the available channels for both “off-air” (antenna) and cable channels.

After the available channels are memorized, use the **CH ^** or **CH v** button to scan through the channels.

This eliminates the need to change channels by entering the channel digits. There are three steps for memorizing channels: selecting a broadcast source, memorizing the channels (automatic) and adding and deleting channels (manual).

Selecting the Video Signal-source

Before your television can begin memorizing the available channels, you must specify the type of signal source that is connected to the TV (i.e. an antenna or a cable system).



1. Press the **MENU** button to display the menu.
Press the **▲** or **▼** button to select “Channel”, then press the **ENTER** button.

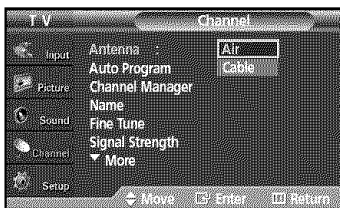

2. Press the **ENTER** button select “Antenna”.
Press the **▲** or **▼** button to select “Air” or “Cable”, then press the **ENTER** button.
Press the **EXIT** button to exit.

Storing Channels in Memory (Automatic Method)



1. Press the **MENU** button to display the menu.
Press the **▲** or **▼** button to select “Channel”, then press the **ENTER** button.
2. Press the **▲** or **▼** button to select “Auto Program”, then press the **ENTER** button.

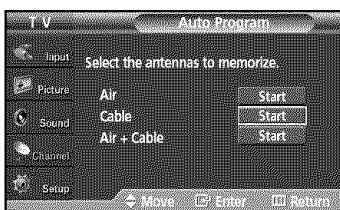

3. Press the **▲** or **▼** button to select the antenna connection, then press the **ENTER** button.
 - Air: “Air” antenna signal.
Cable: “Cable” antenna signal.
Air+Cable: “Air” and “Cable” antenna signals.
 - If the antenna is connected to ANT 1 IN (CABLE), select “Cable” and if it is connected to ANT 2 IN (AIR), select “Air”.
 - If both ANT 1 IN and ANT 2 IN are connected, select the “Air + Cable”.

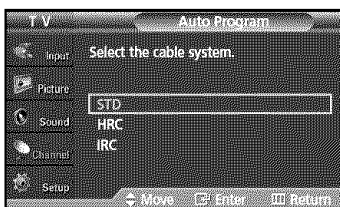

4. Select the correct signal source (STD, HRC, and IRC) by pressing the **▲** or **▼** button, then press the **ENTER** button.
 - STD, HRC, and IRC identify various types of cable TV systems. Contact your local cable company to identify the type of cable system that exists in your particular area.
At this point the signal source has been selected.

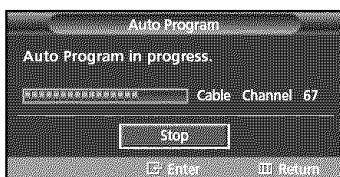

5. The TV begins memorizing all available stations.
Press the **ENTER** button at any time to interrupt the memorization process.
Press the **EXIT** button to exit.

- The TV must be connected to an antenna in order to receive digital TV signals.
Even if a particular channel is deleted from the memory, you can always tune to that channel directly by using the number buttons on the remote control.
- • All available DTV and analog channels are automatically stored in memory.
• It takes approximately 3 to 10 minutes to memorize channels.

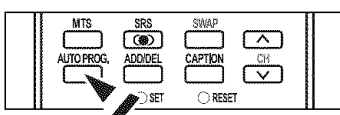

- Press the **AUTO PROG.** button on the remote control to bring up the Auto Program menu.

Setting Up Your Remote Control

After it has been set up properly, your remote control can operate in five different modes: TV, VCR, Cable, DVD, or Set-Top Box. Pressing the corresponding button on the remote control allows you to switch between these modes, and control whichever piece of equipment you choose.

➤ The remote control might not be compatible with all DVD Players, VCRs, Cable boxes, and Set-Top Boxes.

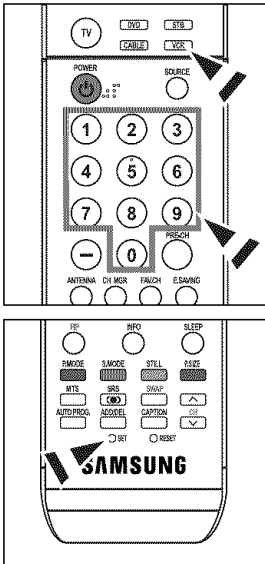

Setting Up the Remote to Operate Your VCR

1. Turn off your VCR.
2. Press the **VCR** button on your TV's remote control.
3. Press the **SET** button on your TV's remote control.
4. Using the number buttons on your remote control, enter three digits of the VCR code listed on page 22 of this manual for your brand of VCR. Make sure you enter three digits of the code, even if the first digit is a "0". (If more than one code is listed, try the first one.)
5. Press the **POWER** button on the remote control. Your VCR should turn on if your remote is set up correctly.

If your VCR does not turn on after set-up, repeat steps 2, 3 and 4, but try one of the other codes listed for your brand of VCR. If no other codes are listed, try each VCR code, 000 through 080.

Note on Using Remote Control Modes: VCR

When your remote control is in "VCR" mode, the volume buttons still control your TV's volume.

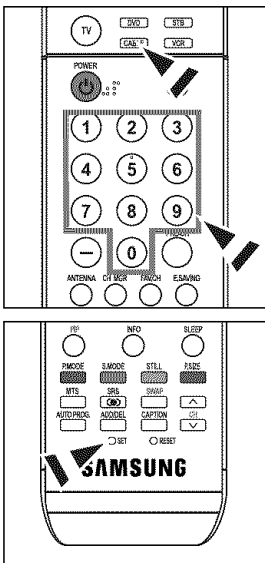

Setting Up the Remote to Operate Your Cable Box

1. Turn off your cable box.
2. Press the **CABLE** button on your TV's remote control.
3. Press the **SET** button on your TV's remote control.
4. Using the number buttons on your remote control, enter three digits of the cable box code listed on page 23 of this manual for your brand of cable box. Make sure you enter three digits of the code, even if the first digit is a "0". (If more than one code is listed, try the first one.)
5. Press the **POWER** button on the remote control.

Your cable box should turn on if your remote is set up correctly.

If your cable box does not turn on after set-up, repeat steps 2, 3 and 4, but try one of the other codes listed for your brand of cable box. If no other codes are listed, try each code, 000 through 046.

Note on Using Remote Control Modes: Cable Box

When your remote control is in "CABLE" mode, the volume buttons still control your TV's volume.

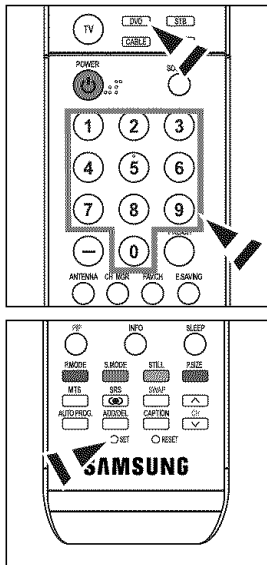

Setting Up the Remote to Operate Your DVD

1. Turn off your DVD.
2. Press the **DVD** button on your TV's remote control.
3. Press the **SET** button on your TV's remote control.
4. Using the number buttons on your remote control, enter three digits of the DVD code listed on page 24 of this manual for your brand of DVD. Make sure you enter three digits of the code, even if the first digit is a "0". (If more than one code is listed, try the first one.)

5. Press the **POWER** button on the remote control.
Your DVD should turn on if your remote is set up correctly.

If your DVD does not turn on after set-up, repeat steps 2, 3 and 4, but try one of the other codes listed for your brand of DVD. If no other codes are listed, try each code, 000 through 141.

Note on Using Remote Control Modes: DVD

When your remote control is in "DVD" mode, the volume buttons still control your TV's volume.

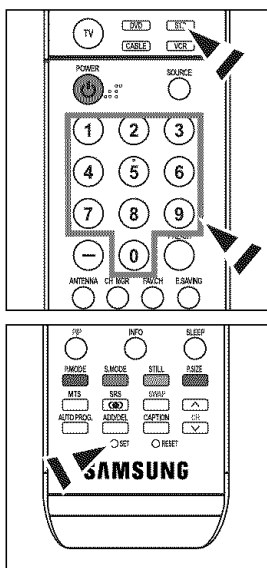

Setting Up the Remote to Operate Your Set Top Box

1. Turn off your STB.
2. Press the **STB** button on your TV's remote control.
3. Press the **SET** button on your TV's remote control.
4. Using the number buttons on your remote control, enter three digits of the STB code listed on page 23 of this manual for your brand of STB. Make sure you enter three digits of the code, even if the first digit is a "0". (If more than one code is listed, try the first one.)

5. Press the **POWER** button on the remote control.
Your STB should turn on if your remote is set up correctly.

If your STB does not turn on after set-up, repeat steps 2, 3 and 4, but try one of the other codes listed for your brand of STB. If no other codes are listed, try each code, 000 through 074.

Note on Using Remote Control Modes: STB

When your remote control is in "STB" mode, the volume buttons still control your TV's volume.

Remote Control Codes

VCR

Brand	Code
SAMSUNG	000 001 002 003 004 005 077 078 079
ADMIRAL	020
AIWA	025
AKAI	004 027 032
AUDIO DYNAMICS	007 026
BELL&HOWELL	018
BROKSONIC	022
CANDLE	002 003 006 008 015 055
CANON	021 056
CITIZEN	002 003 006 008 015 055
COLORTYME	007
CRAIG	002 024
CURTIS MATHES	002 007 008 017 021 025 056 064 066
DAEWOO	003 010 011 012 013 014 015 016
DB	007 026
DIMENSIA	017
DYNATECH	025
ELECTROHOME	034
EMERSON	001 003 006 021 022 025 030 032 034 040 047 050 052 060 063 065 066 067 069 073
FISHER	018 024 028 029 048 051 061
FUNAI	025
GENERAL ELECTRIC	002 005 017 021 056
GO VIDEO	002
LG(Goldstar)	006 007 008 009 010
HARMAN KARDON	007
HITACHI	019 025 041 042 074
INSTANT REPLAY	021
JC PENNEY	002 007 018 019 021 026 037 041 054 056
JCL	007 008 018 021 026 037
KENWOOD	007 008 018 026 037
KLH	070
LLOYD	025
LOGIK	038
LXI	025
JVC	081 082 083
MAGNAVOX	021 056 059
MARANTZ	007 008 018 021 026 037 062
MARTA	006
KONIA	036
ORION	073 074 075 076
MEI	021
MEMOREX	006 021 024 025
MGA	034
MIDLAND	005
MINOLTA	019 041 075

Brand	Code
MITSUBISHI	019 034 041 046
MONTGOMERY WARD	020
MTC	002 025
MULTITECH	002 005 025 038
NEC	007 008 018 026 037 062 064
OPTIMUS	020
PANASONIC	021 056 071 072
PENTAX	019 041 075
PENTEX RESEARCH+	008
PHILCO	021 056 059
PHILIPS	021 080
PIONEER	019 026 039 053
PORTLAND	015 049 055
PROSCAN	017
QUARTZ	018
QUASAR	021 056
RADIO SHACK/REALISTIC	006 018 020 021 024 025 029 034 048 056
RCA	002 017 019 021 035 041 043 057 068 076
SANSUI	026
SANYO	018 024
SCOTT	003 047 052 067
SEARS	006 018 019 024 028 029 041 048 051
SHARP	020 034 045 015
SHIMTOM	027 033 038 058
SIGNATURE	025
SONY	027 033 044
SYLVANIA	021 025 056 059
SYMPHONIC	025
TANDY	018 025
TASHIKA	006
TATUNG	037
TEAC	025 037 068
TECHNICS	021
TEKNIKA	006 021 025 031
TMK	066
TOSHIBA	003 019 029 051 052
TOTEVISION	002 006
UNITECH	002
VECTOR RESEARCH	007 026
VICTOR	026
VIDEO CONCEPTS	007 026
VIDEOSONIC	002
WARDS	002 003 006 019 020 021 024 025 034 038 041
YAMAHA	007 008 018 026 037
ZENITH	023 027 033

CABLE BOX

Brand	Code
SAMSUNG	000 001 002 003 004 005 006 007
GI	041
HAMLIN	003 024 031
HITACHI	025 030
JERROLD	038 039
MACOM	025 030
MAGNAVOX	019 023 028
OAK	026
PANASONIC	003 022 027 037 044
PHILIPS	019 021 023 028
PIONEER	004 018 020 044
RCA	014 022 040
REGAL	003

Brand	Code
REGENCY	015 023
SA	042 043
SCIENTIFIC ATLAN	042 043
SPRUCER	022
STARGATE 2000	036
SYLVANIA	016
TEXSCAN	016
TOCOM	032
UNIVERSAL	033 034
VIEWSTAR	019 021 023 028
WAMER AMEX	046
ZENITH	017 029 035 037 045

SAMSUNG SET-TOP BOX

Product	Code
Ground wave STB	001 002
Satellite STB	003
CABLE STB	004
STB DVD COMBO	008
Satellite STB HDD COMBO Standard	009

Product	Code
Satellite STB HDD COMBO Premium	010
CABLE STB HDD COMBO Standard	011
CABLE STB HDD COMBO Premium	012
Ground wave STB HDD COMBO Standard	013
Ground wave STB HDD COMBO Premium	014

SET-TOP BOX

Brand	Code
ALPHASTAR	023
ANAM	043
CHANNEL MASTER	018 034
CROSSDIGITAL	019
CHAPARRAL	035
DIRECT TV	015 016 017 019 022 045 060 061 062 065 066 067 068
DAEWOO	074
DISH NETWORK SYSTEM	069 070
DISHPRO	069
DRAKE	018 024 032
DX ANTENNA	027
ECHOSTAR	025 069 070 071
EXPRESSVU	069
GOI	069
GE	065
GENERAL INSTRUMENT	046 047 048 063 064
HTS	069
HOME CABLE	056
HITACHI	022
HUGHES NETWORK	015 017
IQ	020
IQ PRISM	020
JANEIL	059
JERROID	063
JVC	069 070

Brand	Code
LG(Goldstar)	044 073
MAGNAVOX	016 021 036 038 039 040 041 042
MEMOREX	016
MOTOROLA	064
MACOM	018
MITSUBISHI	015
NEXT LEVEL	047 048 064
PHILIPS	015 016 017 021 033 036 038 039 040 041 042 067
PRIMESTAR	046 049 050 063
PANASONIC	058 059 061 062
PAYSAT	016
PROSCAN	065 066
RCA	051 052 053 065 066
RADIOSHACK	064
REALISTIC	057
STS	020 027
STAR TRAK	026
SKY	031
SKY LIFE	005 006 007
SHACK	064
STAR CHOICE	064
SONY	054 060
TOSHIBA	015 017 028 029 030 072
ULTIMATE TV	060 066
UNIDEN	016 021 037 055 056 057
ZENITH	024 031 068

SAMSUNG DVD

Product	Code
DVD	000 001 002
DVDR	003 004
BD Record	005 006
VCR COMBO	007 008 009 010 011
VCR Record	012
DHR COMBO	013

Product	Code
Home Theater VCR COMBO	014 015 016
HDD Record COMBO	017
TWIN TRAY COMBO	018
STB DVD COMBO	019
DVD Receiver	020
AV Receiver	021

DVD

Brand	Code
ANAM	030
AUDIOVOX	075
AUDIOLOGIC	085
ANABA	072
APEX DIGITAL	070 071 074 086 083 084 088 111 112
AIWA	114
BROKSONIC	062
BLAUPUNKT	074
B&K	122 123
CURTIS MATHES	027
CYBER HOME	065 077 078 079 082
CLARION	080 125
CIRRUS	081
CINEVISION	095
DAEWOO	066
DENON	146
FARENHEIT	067 068
FISHER	090
GPX	060
GO VIDEO	061 089 133 135
GE	069 074
GREENHILL	074
HITACHI	064 113
HITEKER	071
HOYO	073
HARMAN / KARDON	091 110
IRT	089
INTEGRA	092
JBL	091
JVC	022 033 115 116
JATON	073
KENWOOD	051 108 109
KISS	073
KONKA	059 100 106 107
KLH	074 075
LG(Goldstar)	025 031
LOEWE	057
LASONIC	058
MOBILE AUTHORITY	054
MEMOREX	055
MALATA	056
MAGNAVOX	076 093
MINTEK	074 094
MONYKA	073

Brand	Code
NORCENT	048 049 050
NEXT BASE	052
NEC	053
NANTAU	144
NESA	074
OPTOMEDIA ELECTRONICS	105
OPTIVIEW	072
ONKYO	076 092 119
PHILCO	044 045
PRINCETON	046 047
PROSCAN	023
PANASONIC	024 034 124 134 136 137 138
PHILIPS	036 076
ROTEL	117 118
RIO	120
RCA	023 035 074 075 131 132
RAITE	073
ROWA	038
SAMPO	104
SONY	026 029 126 127 128 129 130 141
SHERWOOD	039 041
SVA	042
SYLVANIA	043 093
SHARP	140
SANSUI	062
SANYO	062
SHINSONIC	094
SANYO	090
THOMSON	145
TOSHIBA	028 062 076
TECHNICS	139
TVIEW	072
TOKAI	073
TEAC	096
TECHWOOD	097
TREDEX	098 099 101
URBAN CONCEPTS	076
VENTURER	075
VOCOPRO	102
YAMAHA	032 063
YAMAKAWA	040 073
XWAVE	103
ZENITH	076 121

To Select the Source

Use to select TV or other external input sources connected to the TV.
Use to select the input source of your choice.



1. Press the **MENU** button to display the menu.
Press the **ENTER** button to select "Input".
2. Press the **ENTER** button to select "Source List".
Press the **▲** or **▼** button to select signal source, then press the **ENTER** button.
 - When you connect equipment to the TV, you can choose between the following sets of jacks: AV1, S-Video1, Component1, Component2, PC, HDMI1, or HDMI2 on the TV's rear panel and AV2 or S-Video2 on the TV's side panel.
 - HDMI1 or HDMI2 input can only be selected when the external device is turned on and connected via HDMI.
 - You can choose only those external devices that are connected to the TV.

 Press the **SOURCE** button on the remote control to view an external signal source.

To Edit the Input Source Name

Name the device connected to the input jacks to make your input source selection easier.



1. Press the **MENU** button to display the menu.
Press the **ENTER** button to select "Input".
Press the **▲** or **▼** button to select "Edit Name", then press the **ENTER** button.
2. Press the **▲** or **▼** button to select "AV1", "AV2", "S-Video1", "S-Video2", "Component1", "Component2", "PC", "HDMI1" or "HDMI2" input jack, then press the **ENTER** button.
3. Press the **▲** or **▼** button to select "VCR", "DVD", "D-VHS", "Cable STB", "HD STB", "Satellite STB", "PVR STB", "AV Receiver", "DVD Receiver", "Game", "Camcorder", "DVD Combo", "PC", "VOD STB", or "TV" input source, then press the **ENTER** button.
Press the **EXIT** button to exit.

Picture Control

Using Automatic Picture Settings

Your TV has four automatic picture settings (“Dynamic”, “Standard”, “Movie”, and “Custom”) that are preset at the factory. You can activate either Dynamic, Standard, Movie, or Custom by making a selection from the menu.

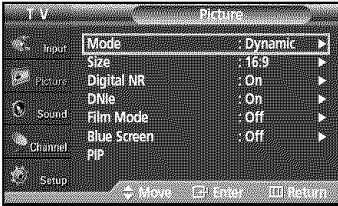

1. Press the **MENU** button to display the menu. Press the **▲** or **▼** button to select “Picture”, then press the **ENTER** button.

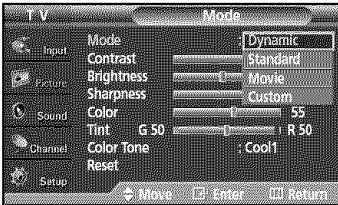

2. Press the **ENTER** button to select “Mode”. Press the **ENTER** button again. Press the **▲** or **▼** button to select the “Dynamic”, “Standard”, “Movie”, or “Custom” picture setting, then press the **ENTER** button.

- Choose **Dynamic** to increase the clarity and sharpness of the picture.
- Choose **Standard** for the standard factory settings.
- Choose **Movie** when watching movies.
- Choose **Custom** if you want to adjust the settings according to personal preference.

➤ Picture mode needs to be adjusted separately for each input.

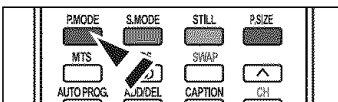

2. Press the **P.MODE** button on the remote control to select one of the standard picture settings.

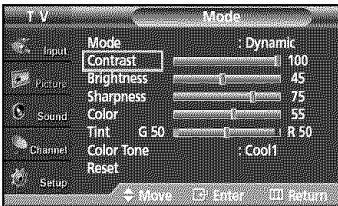

3. Press the **▲** or **▼** button to select “Contrast”, “Brightness”, “Sharpness”, “Color”, or “Tint”, then press the **ENTER** button.

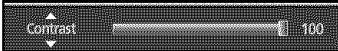

4. Press the **◀** or **▶** button to decrease or increase the value of a particular item. Press the **ENTER** button.

- “Tint” doesn’t operate in PC, HDMI or any Component mode.
- In PC mode, only the Contrast and Brightness can be selected.
- The Tint cannot be adjusted while watching Digital TV.
- Each adjusted setting will be stored separately according to its input mode.
- When you make changes to Contrast, Brightness, Sharpness, Color, or Tint. OSD color will also be adjusted accordingly.

Continued...

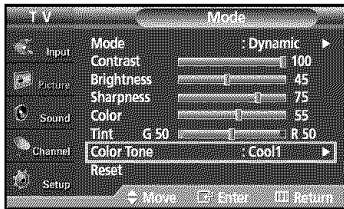

5. Press the **ENTER** button to return to "Mode".
6. Press the **▲** or **▼** button to select "Color Tone", then press the **ENTER** button.
7. Press the **▲** or **▼** button to select "Cool2", "Cool1", "Normal", "Warm1", or "Warm2", then press the **ENTER** button.

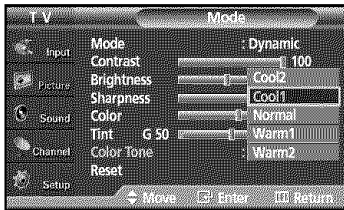

Resetting the Picture Settings to the Factory Defaults

8. Press the **▲** or **▼** button to select "Reset", then press the **ENTER** button. Press the **EXIT** button to exit.
 - Each picture mode can be reset.

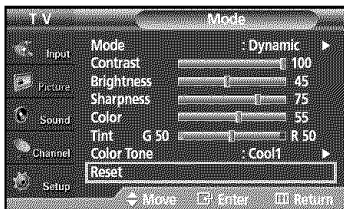

Digital Noise Reduction

If the broadcast signal received by your TV is weak, you can activate the Digital Noise Reduction feature to help reduce any static and ghosting that may appear on the screen.

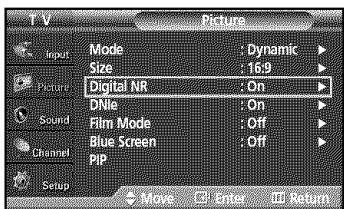

1. Press the **MENU** button to display the menu. Press the **▲** or **▼** button to select "Picture", then press the **ENTER** button.
2. Press the **▲** or **▼** button to select "Digital NR", then press the **ENTER** button.
3. Press the **▲** or **▼** button to select "Off" or "On", then press the **ENTER** button. Press the **EXIT** button to exit.
 - The Digital NR function is available in all modes except PC.

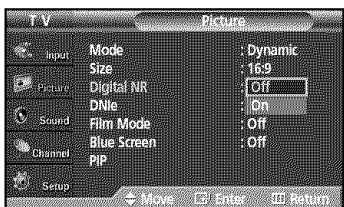

Changing the Screen Size

Screen size selection depends on the type of video input.

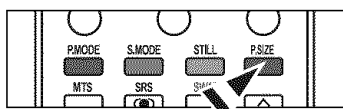
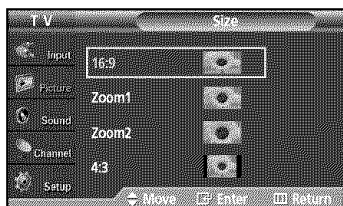
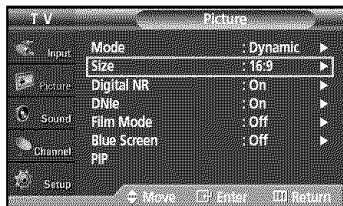

1. Press the **MENU** button to display the menu.
Press the **▲** or **▼** button to select "Picture", then press the **ENTER** button.
2. Press the **▲** or **▼** button to select "Size", then press the **ENTER** button.
3. Press the **▲** or **▼** button to select the screen format you want.
Press the **ENTER** button.

Press the **EXIT** button to exit.

- **16:9** : Sets the picture to 16:9 wide mode.
- **Zoom1** : Magnifies the size of the picture on the screen.
- **Zoom2** : Expands the Zoom1 format picture.
- **4:3** : Sets the picture to 4:3 normal mode.

-  Press the **P.SIZE** button on the remote control to change the picture size.

- If you watch a still image or the 4:3 (Normal) mode for a long time (over 2 hours), an image may be burned onto the screen. View the TV in 16:9 (Wide) mode as much as possible.

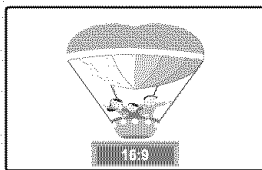

16:9
Sets the picture to 16:9 wide mode.

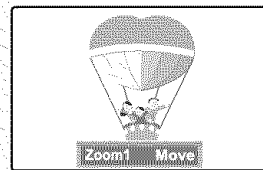

Zoom1
The screen size when Wide screen is vertically enlarged.

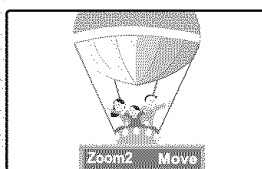

Zoom2
The screen size when the Zoom1 screen is vertically enlarged.

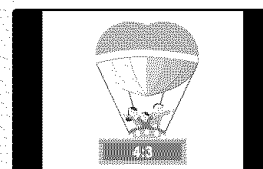

4:3
Sets the picture to 4:3 normal mode.

-
- In TV, VIDEO, S-VIDEO, and COMPONENT(480i, 480p) modes, all screen modes can be selected. (16:9 → Zoom1 → Zoom2 → 4:3)
 - In TV(DTV), COMPONENT(720p, 1080i), PC, HDMI modes, only 16:9 & 4:3 modes can be selected.
 - In Zoom1 and Zoom2 modes, you can move the picture on screen by pressing the **▲** or **▼** button.
 - You can not change the picture size when PIP is set to Double.

DNiE (Digital Natural Image engine)

This TV includes the DNiE function so as to provide a high visual quality. If you set DNiE to On, you can view the applied DNiE and normal pictures on the screen, for demonstration purposes. Using this function, you can view the difference in the visual quality.

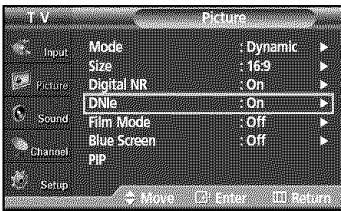

1. Press the **MENU** button to display the menu.
Press the **▲** or **▼** button to select "Picture", then press the **ENTER** button.
2. Press the **▲** or **▼** button to select "DNiE", then press the **ENTER** button.
 - This function doesn't work when the Input Source is PC.
3. Press the **▲** or **▼** button to select "Off", "Demo" or "On", then press the **ENTER** button.

Press the **EXIT** button to exit.

- **Off**: Switches off the DNiE mode.
- **Demo**: The screen before applying DNiE appears on the left and the screen after applying DNiE appears on the right.
- **On**: Switches on the DNiE mode.

➤ The DNiE function is not supported in the Movie mode. (It is inactivated.)

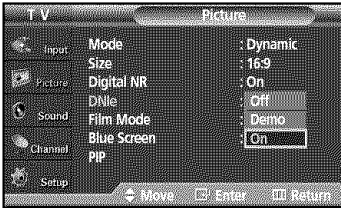

Selecting the Film Mode

Automatically senses and processes film signals from all sources and adjusts the picture for optimum quality.

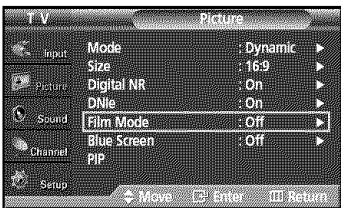

1. Press the **MENU** button to display the menu.
Press the **▲** or **▼** button to select "Picture", then press the **ENTER** button.
2. Press the **▲** or **▼** button to select "Film Mode", then press the **ENTER** button.
3. Press the **▲** or **▼** button to select "Off" or "On", then press the **ENTER** button.
Press the **EXIT** button to exit.

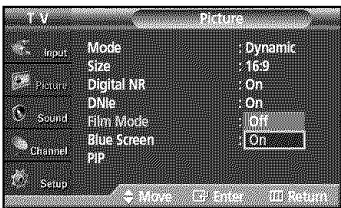

Setting the Blue Screen Mode

If no signal is being received or the signal is very weak, a blue screen automatically replaces the noisy picture background. If you wish to continue viewing the poor picture, you must set the "Blue Screen" mode to "Off".

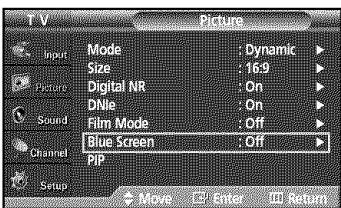

1. Press the **MENU** button to display the menu.
Press the **▲** or **▼** button to select "Picture", then press the **ENTER** button.
2. Press the **▲** or **▼** button to select "Blue Screen", then press the **ENTER** button.
3. Press the **▲** or **▼** button to select "Off" or "On", then press the **ENTER** button.
Press the **EXIT** button to exit.

➤ Blue Screen is displayed when there is no signal from an external device, regardless of the Blue Screen Setting.

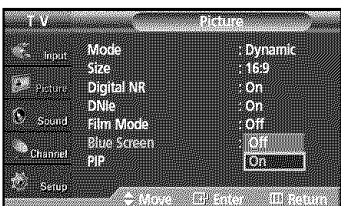

Viewing Picture-in-Picture

This product has one built-in tuner, which does not allow PIP to function in the same mode. For example, you cannot watch one TV channel in the main screen, and a different one in the PIP screen. Please see 'PIP Settings' below for details. You can use the PIP feature to simultaneously watch two video sources. (See page 35 to select the PIP picture sound.)

➤ While V-Chip is in operation, the PIP function cannot be used.

Activating Picture-in-Picture

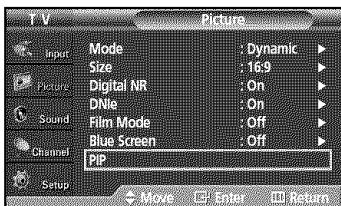

1. Press the **MENU** button to display the menu. Press the **▲** or **▼** button to select "Picture", then press the **ENTER** button. Press the **▲** or **▼** button to select "PIP", then press the **ENTER** button.

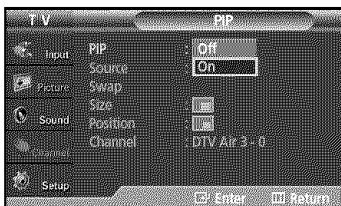

2. Press the **ENTER** button again. Press the **▲** or **▼** button to select "On", then press the **ENTER** button.

➤ If you turn the TV off while watching in PIP mode and turn it on again, the PIP window will disappear.

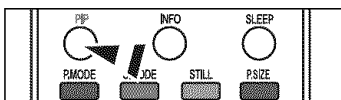

🔑 Press the **PIP** button on the remote control to activate or deactivate the PIP.

A : Analog O : PIP and swap operate
D : Digital X : PIP doesn't operate

		TV		AV1(A)	S-Video(A)	Component(A)	PC	HDMI(D)
		Analog	Digital (ATSC)					
Main screen	Analog	X	O	X	X	X	X	O
	Digital (ATSC)	O	X	O	O	O	X	X
PIP screen	Analog	X	O	X	X	X	X	O
PIP screen	Digital (ATSC)	O	X	O	O	O	X	X
	AV1(A)	X	O	X	X	X	X	O
	S-Video(A)	X	O	X	X	X	X	O
	Component(A)	X	O	X	X	X	X	O
	PC	O	X	O	X	X	X	X
	HDMI(D)	O	X	O	O	O	X	X

-
- This TV has only one tuner and does not allow you to watch one TV channel in the main screen and another channel in the PIP screen.
 - In TV(DTV), COMPONENT(720p, 1080i), PC, HDMI modes, only 16:9 & 4:3 modes can be selected.

Selecting a Signal Source (External A/V) for PIP.

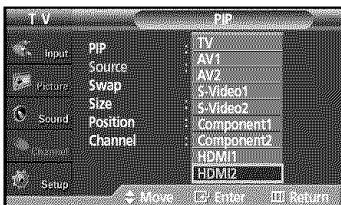

3. Press the **▲** or **▼** button to select "Source", then press the **ENTER** button. Select the source of the sub picture (PIP) by pressing the **▲** or **▼** button, then press the **ENTER** button.

➤ The sub picture can serve different source selections based on what the main picture is set to.
➤ In the PIP Source menu, 'TV' represents both analog and digital tuning.

Continued...

Swapping the Contents of the PIP and Main Picture

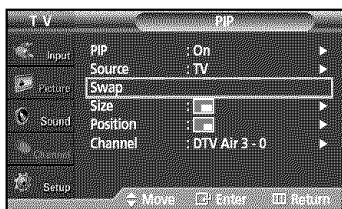

- Press the **▲** or **▼** button to select "Swap", then press the **ENTER** button. The image in the PIP window will appear on the main picture, and vice versa. (Refer to page 30)

➤ If main picture is in PC mode, Swap is not available.

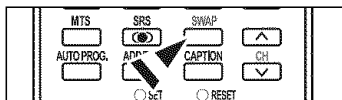

- Press the **SWAP** button on the remote control to interchange the main picture and the sub picture.

Changing the Size of the PIP Window

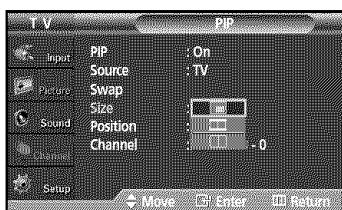

- Press the **▲** or **▼** button to select "Size", then press the **ENTER** button. Press the **▲** or **▼** button to select the desired size of the PIP window, then press the **ENTER** button.

Press the **EXIT** button to exit.

➤ If main picture is in PC mode, Size is not available.

➤ You may notice that the picture in the PIP window becomes slightly unnatural when you use the main picture to view a game or karaoke.

Changing the Position of the PIP Window

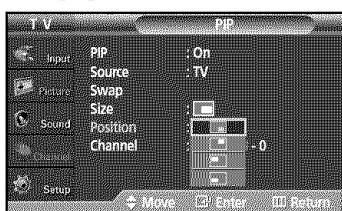

- Press the **▲** or **▼** button to select "Position", then press the **ENTER** button. Press the **▲** or **▼** button to select the desired PIP window position, then press the **ENTER** button.

➤ In Double Window () and Double Wide () modes, Position cannot be selected.

Changing the PIP Channel

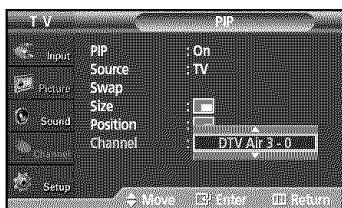

- Press the **▲** or **▼** button to select "Channel", then press the **ENTER** button. Press the **▲** or **▼** button at the bottom of the remote to select the desired channel in the PIP window, then press the **ENTER** button.

➤ The channel can be active when the sub picture is set to TV.

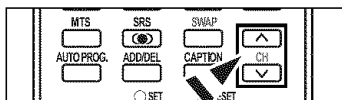

- Press the PIP CH **^** and **v** buttons on the remote control to change the PIP channel.

Freezing the Current Picture

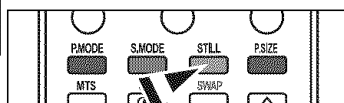

- Press the **STILL** button to freeze a moving picture.
 - Normal sound will still be heard. Press again to cancel.
 - This function will automatically cancel five minutes later.

Sound Control

Using Automatic Sound Settings

Your TV has automatic sound settings ("Standard", "Music", "Movie", "Speech", and "Custom") that are preset at the factory. Or, you can select "Custom", which automatically recalls your personalized sound settings.

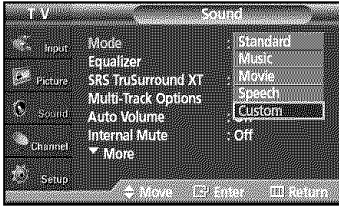

1. Press the **MENU** button to display the menu. Press the **▲** or **▼** button to select "Sound", then press the **ENTER** button.
2. Press the **ENTER** button to select "Mode". Press the **▲** or **▼** button to select "Standard", "Music", "Movie", "Speech", or "Custom" sound setting, then press the **ENTER** button.

Press the **EXIT** button to exit.

- Choose **Standard** for the standard factory settings.
- Choose **Music** when watching music videos or concerts.
- Choose **Movie** when watching movies.
- Choose **Speech** when watching a show that is mostly dialog (i.e., news).
- Choose **Custom** to recall your personalized settings (see "Customizing the Sound").

-  Press the **S.MODE** button on the remote control to select one of the standard sound settings.

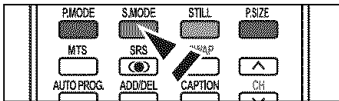

Customizing the Sound

The sound settings can be adjusted to suit your personal preference. (Alternatively, you can use one of the "automatic" settings.)

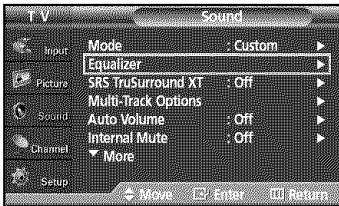

1. Press the **MENU** button to display the menu. Press the **▲** or **▼** button to select "Sound", then press the **ENTER** button.
2. Press the **▲** or **▼** button to select "Equalizer", then press the **ENTER** button.

3. Press the **◀** or **▶** button to select a particular frequency to adjust. Press the **▲** or **▼** button to increase or decrease the level of the particular frequency, then press the **ENTER** button.

Press the **EXIT** button to exit.

- **L/R Sound Balance Adjustment:** To adjust the sound balance of the L/R speakers.
- **Bandwidth Adjustment (100Hz, 300Hz, 1K, 3K, 10K)**
: To adjust the level of different bandwidth frequencies.

- If you make any changes to the equalizer settings, the sound mode is automatically switched to the "Custom" mode.

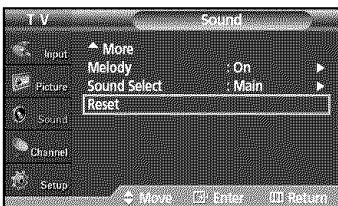
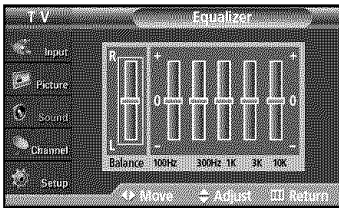

Resetting the Equalizer Settings to the Factory Defaults

To operate the Reset function, the Game mode must be set to On. (Refer to page 47)

1. Press the **MENU** button to display the menu. Press the **▲** or **▼** button to select "Sound", then press the **ENTER** button.
2. Press the **▲** or **▼** button to select "Reset", then press the **ENTER** button.

- The equalizer resets to the factory defaults.

Press the **EXIT** button to exit.

Setting the TruSurround XT

TruSurround XT is a patented SRS technology that solves the problem of playing 5.1 multichannel content over two speakers. TruSurround delivers a compelling, virtual surround sound experience through any two-speaker playback system, including internal television speakers. It is fully compatible with all multichannel formats.

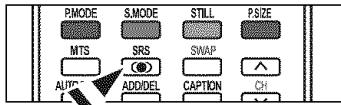
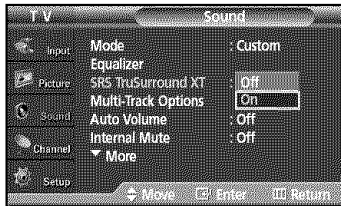

1. Press the **MENU** button to display the menu.
Press the **▲** or **▼** button to select "Sound", then press the **ENTER** button.
 2. Press the **▲** or **▼** button to select "SRS TruSurround XT", then press the **ENTER** button.
 3. Press the **▲** or **▼** button to select "Off" or "On", then press the **ENTER** button.
Press the **EXIT** button to exit.
-  Press the **SRS** button on the remote control to select "On" or "Off".

TRADEMARK & LABEL LICENSE NOTICE



TruSurround XT, SRS and  Symbol are trademarks of SRS Labs, Inc.

TruSurround XT technology is incorporated under license from SRS Labs, Inc.

Choosing a Multi-Channel Sound (MTS) track - Digital

The digital-TV transmission system is capable of simultaneous transmission of many audio tracks (for example, simultaneous translations of the program into foreign languages). The availability of these additional "multitracks" depends upon the program.

Preferred Language

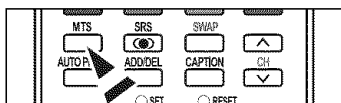
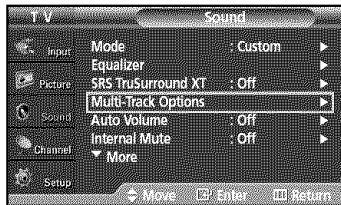

1. Press the **MENU** button to display the menu.
Press the **▲** or **▼** button to select "Sound", then press the **ENTER** button.
2. Press the **▲** or **▼** button to select "Multi-Track Options", then press the **ENTER** button.
3. Press the **ENTER** button to select "Preferred Language".
Press the **▲** or **▼** button to choose the language (English, Spanish or French) you want, then press the **ENTER** button.
Press the **EXIT** button to exit.
➤ You can only select the language from among the actual languages being broadcast.

 Press the **MTS** button on the remote control to listen in a language other than the favorite language.

Choosing a Multi-Channel Sound (MTS) track - Analog

Depending on the particular program being broadcast, you can listen to Mono, Stereo or SAP.

Multi-Track Sound

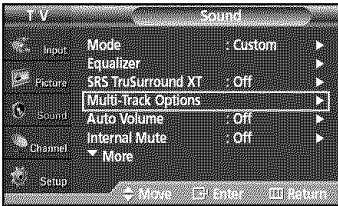

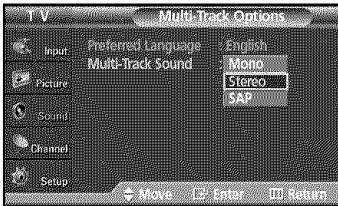

1. Press the **MENU** button to display the menu. Press the **▲** or **▼** button to select "Sound", then press the **ENTER** button.
2. Press the **▲** or **▼** button to select "Multi-Track Options", then press the **ENTER** button.

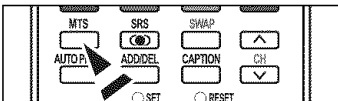

3. Press the **▲** or **▼** button to select "Multi-Track Sound", then press the **ENTER** button. Press the **▲** or **▼** button to select a setting you want, then press the **ENTER** button. Press the **EXIT** button to exit.

- Choose **Mono** for channels that are broadcasting in mono, or if you are having difficulty receiving a stereo signal.
- Choose **Stereo** for channels that are broadcasting in stereo.
- Choose **SAP** to listen to the Separate Audio Program, which is usually a foreign-language translation.



-  Press the **MTS** buttons on the remote control to select "Mono", "Stereo", or "SAP".

Automatic Volume Control

Reduces the difference in volume level among broadcasters.

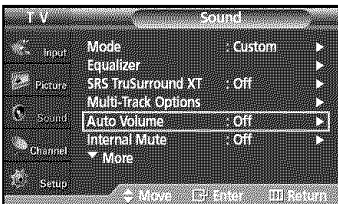

1. Press the **MENU** button to display the menu. Press the **▲** or **▼** button to select "Sound", then press the **ENTER** button.
2. Press the **▲** or **▼** button to select "Auto Volume", then press the **ENTER** button.

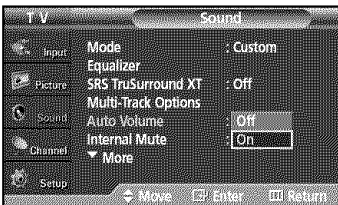

3. Press the **▲** or **▼** button to select "Off" or "On", then press the **ENTER** button. Press the **EXIT** button to exit.

Selecting the Internal Mute

Sound output from the TV speakers is muted. This is useful when you want to listen to audio through your sound system instead of the TV.

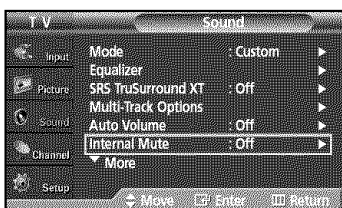

1. Press the **MENU** button to display the menu.
Press the **▲** or **▼** button to select "Sound", then press the **ENTER** button.
2. Press the **▲** or **▼** button to select "Internal Mute", then press the **ENTER** button.
3. Press the **▲** or **▼** button to select "Off" or "On", then press the **ENTER** button.
Press the **EXIT** button to exit.
 - When Internal Mute is set to "On", Sound menus except Multi-track Options cannot be adjusted.
 - The left/right audio outputs and digital audio outputs (Optical, Coaxial) remain enabled.
 - The VOL +, VOL - and MUTE buttons do not operate when the Internal Mute is set to On.
 - When Internal Mute is On, only MTS is selectable for the Sound.

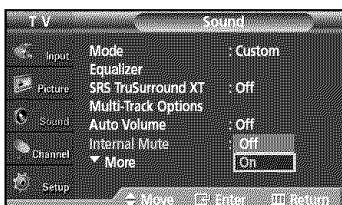

Setting the On/Off Melody

A melody sound can be set to come on when the TV is powered On or Off.

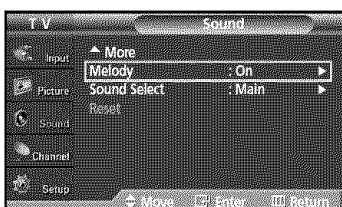

1. Press the **MENU** button to display the menu.
Press the **▲** or **▼** button to select "Sound", then press the **ENTER** button.
2. Press the **▲** or **▼** button to select "Melody", then press the **ENTER** button.



3. Press the **▲** or **▼** button to select "Off" or "On", then press the **ENTER** button.
Press the **EXIT** button to exit.

Listening to the Sound of the Sub (PIP) Picture

When the PIP feature is activated, you can listen to the sound of the sub (PIP) picture.

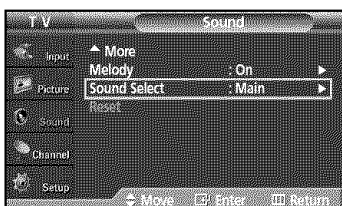

1. Press the **MENU** button to display the menu.
Press the **▲** or **▼** button to select "Sound", then press the **ENTER** button.
2. Press the **▲** or **▼** button to select "Sound Select", then press the **ENTER** button.



3. Press the **▲** or **▼** button to select "Sub", then press the **ENTER** button.
Press the **EXIT** button to exit.
 - **Main:** Used to listen to the sound of the main picture.
 - **Sub:** Used to listen to the sound of the sub picture.

➤ You can select this option when "PIP" is set to "On".

Channel Control

Selecting the Antenna

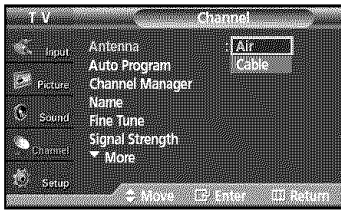

1. Press the **MENU** button to display the menu. Press the **▲** or **▼** button to select "Channel", then press the **ENTER** button.
2. Press the **ENTER** button to select "Antenna". Press the **▲** or **▼** button to select "Air" or "Cable", then press the **ENTER** button. Press the **EXIT** button to exit.

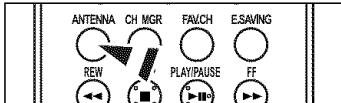

- Press the **ANTENNA** button on the remote control to select Air or Cable.

- If the antenna is connected to ANT 2 IN (AIR), select "Air" and if it is connected to ANT 1 IN (CABLE), select "Cable".
- If both ANT 2 IN (AIR) and ANT 1 IN (CABLE) are connected, select the antenna input you want. If the antenna input is not selected properly, noise may appear on the screen.

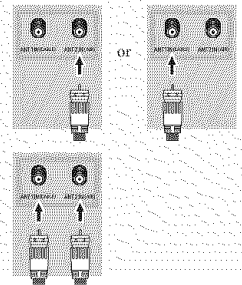

Adding and Erasing Channels

You can add or delete a channel to display the channels you want only. To use the Channel Manager function, first run Auto Program (see page 19).



1. Press the **MENU** button to display the menu. Press the **▲** or **▼** button to select "Channel", then press the **ENTER** button.
2. Press the **▲** or **▼** button to select "Channel Manager", then press the **ENTER** button.

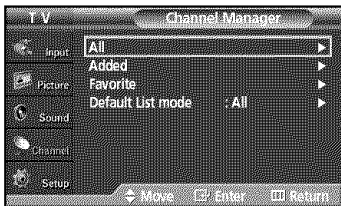

3. Press the **ENTER** button to select "All".

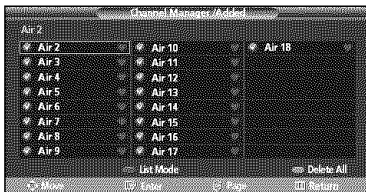

4. Press the **▲** or **▼** button to select a channel to delete, then press the **ENTER** button. Press the **▲** or **▼** button to select "Delete", then press the **ENTER** button to delete the channel.

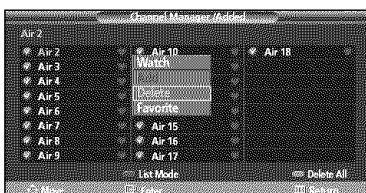



5. Press the **▲** or **▼** button to select a channel to add, then press the **ENTER** button.

Press the **▲** or **▼** button to select "Add", then press the **ENTER** button to add the channel.

Press the **EXIT** button to exit.

➤ All added channels will be shown on "Added" menu.

- **Red (P.MODE) button:** Press repeatedly to select "All", "Added", or "Favorite".
- **Green (S.MODE) button:** Press to add all channels deleted.
- **Yellow (P.SIZE) button:** Press to delete all channels memorized.

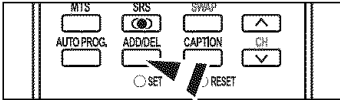

1. Press the **ADD/DEL** button on the remote control.

Press the **CH ▲** and **CH ▼** button to select the channel to be added or deleted, then press the **ENTER** button.

To set-up Your Favorite Channels

You can set channels you watch frequently as favorites.

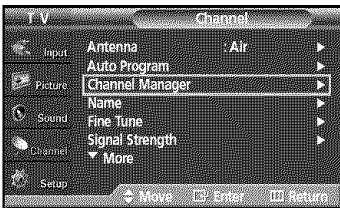

1. Press the **MENU** button to display the menu. Press the **▲** or **▼** button to select "Channel", then press the **ENTER** button.
2. Press the **▲** or **▼** button to select "Channel Manager", then press the **ENTER** button.

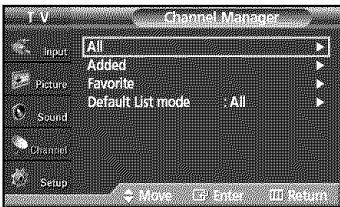

3. Press the **▲** or **▼** button to select "All" or "Added", then press the **ENTER** button.



4. Press the **▲ / ▼ / ◀ / ▶** buttons to select a channel as a favorite channel, then press the **ENTER** button.
5. Press the **▲** or **▼** button to select "Favorite", then press the **ENTER** button. The "♥" symbol will be highlighted and the channel will be set as a Favorite. To cancel your Favorite channel selection, press the **ENTER** button until the "♥" symbol is no longer highlighted.

Press the **EXIT** button to exit.

➤ Only memorized channels can be set as favorite channels.

➤ All favorite channels will be shown on "Favorite" menu.



1. To select the favorite channels you have set up, press the **FAV.CH** button on the remote control.

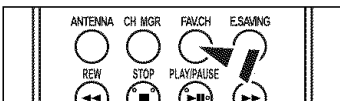

Viewing the Channel Lists

You can display a list of all channels, added channels or your favorite channels.

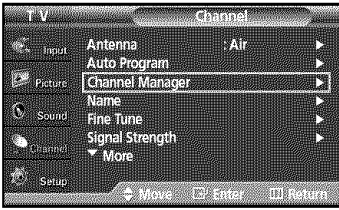

1. Press the **MENU** button to display the menu. Press the **▲** or **▼** button to select "Channel", then press the **ENTER** button.
2. Press the **▲** or **▼** button to select "Channel Manager", then press the **ENTER** button.



3. Press the **▲** or **▼** button to select "All", "Added" or "Favorite", then press the **ENTER** button.

To toggle between your all channels, add channels, or favorite channels, use the red (P.MODE) button on the remote control.

- **Red (P.MODE) button:** Press repeatedly to select "All", "Added", or "Favorite".
- **Yellow (STILL) button:** Press to delete all channels memorized.

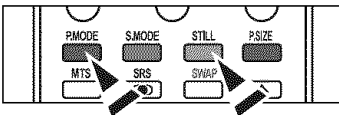

Setting the Default Channel List Mode

Displays the channel list automatically when you press CH MGR button on the remote control. (Choose All, Added, or Favorite)

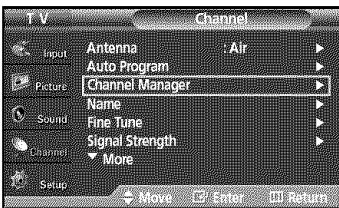

1. Press the **MENU** button to display the menu. Press the **▲** or **▼** button to select "Channel", then press the **ENTER** button.
2. Press the **▲** or **▼** button to select "Channel Manager", then press the **ENTER** button.

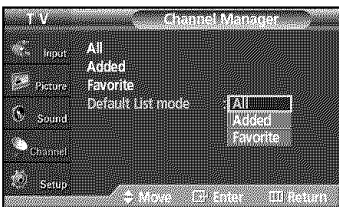

3. Press the **▲** or **▼** button to select "Default List mode", then press the **ENTER** button. Press the **▲** or **▼** button to select "All", "Added", or "Favorite", then press the **ENTER** button.

➤ The Channel list you want to appear when you press the CH MGR button.

- **All:** Shows All the channels when you press the CH.MGR button on the remote control.
- **Added:** Shows Added channels when you press CH.MGR button on the remote control.
- **Favorite:** Shows Favorite channels when you press CH.MGR button on the remote control.

Press the **EXIT** button to exit.

- Press the **CH MGR** button on the remote control to bring up the Channel Lists.

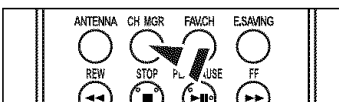

Labeling Channels

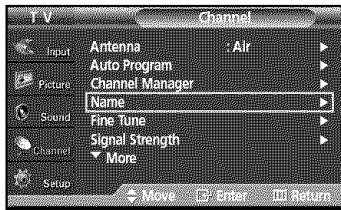

1. Press the **MENU** button to display the menu. Press the **▲** or **▼** button to select "Channel", then press the **ENTER** button. Press the **▲** or **▼** button to select "Name", then press the **ENTER** button.

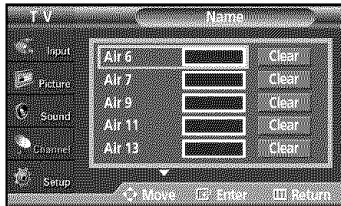

2. Press the **▲** or **▼** button to select the channel to be assigned a new name, then press the **ENTER** button.

3. Press the **▲** or **▼** button to select a letter, a number or a blank (Results in this sequence: A...Z, 0...9, +, -, *, /, blank). Press the **▶** button to switch to the next field, which will be selected. Select a second letter or digit by pressing the **▲** or **▼** button, as above. Repeat the process to select the last three digits. When you have finished, press the **ENTER** button to assign the new name. To erase the assigned new name, select "Clear" by pressing the **◀** or **▶** button, then press the **ENTER** button.

Press the **EXIT** button to exit.

- The names of digital broadcasting channels are automatically assigned and thus cannot be assigned by users.
- When you use a cable card to watch cable broadcasting, it may take some time for a channel name to be displayed due to the time it takes to receive data.

Fine Tuning Analog Channels

Use fine tuning to manually adjust a particular channel for optimal reception.

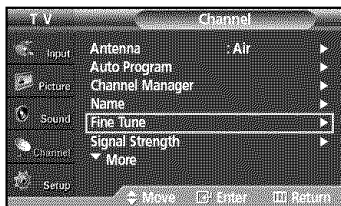

1. Press the **MENU** button to display the menu. Press the **▲** or **▼** button to select "Channel", then press the **ENTER** button.
2. Press the **▲** or **▼** button to select "Fine Tune", then press the **ENTER** button.

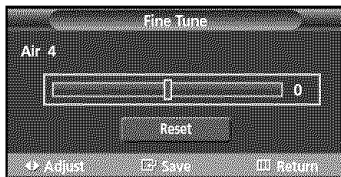

3. Press the **◀** or **▶** button to adjust the fine tuning.
4. To store the fine tuning setting in the TV's memory, press the **ENTER** button. To reset the fine tuning setting, press the **▼** button to select "Reset", then press the **ENTER** button.

Press the **EXIT** button to exit.

- Only analog TV channels can be fine tuned.
- "*" will appear next to the number of fine-tuned channels.

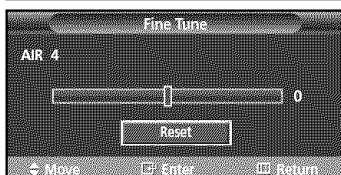
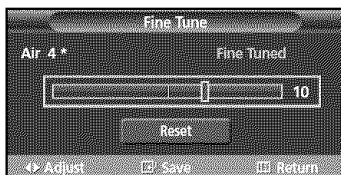

Checking the Digital-Signal Strength

Unlike analog channels, which can vary in reception quality from “snowy” to clear, digital (HDTV) channels have either perfect reception quality or you will not receive them at all. So, unlike analog channels, you cannot fine tune a digital channel. You can, however, adjust your antenna to improve the reception of available digital channels.

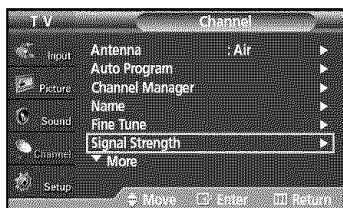

1. Press the **MENU** button to display the menu.
Press the **▲** or **▼** button to select “Channel”, then press the **ENTER** button.
2. Press the **▲** or **▼** button to select “Signal Strength”, then press the **ENTER** button.
If the signal strength meter indicates that the signal is weak, physically adjust your antenna to increase the signal strength.
Continue to adjust the antenna until you find the best position with the strongest signal.
Press the **EXIT** button to exit.

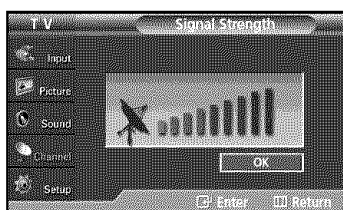

You can also press the **ENTER** button to select OK then press the **EXIT** button to exit the menu.

LNA (Low Noise Amplifier)

If the TV is operating in a weak-signal area, sometimes the LNA function can improve the reception (a low-noise preamplifier boosts the incoming signal).

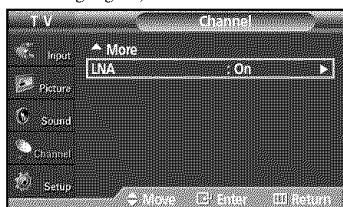

1. Press the **MENU** button to display the menu.
Press the **▲** or **▼** button to select “Channel”, then press the **ENTER** button.
2. Press the **▲** or **▼** button to select “LNA”, then press the **ENTER** button.

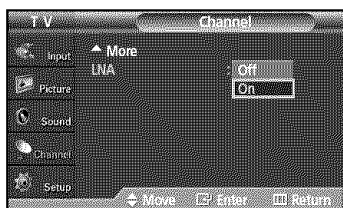

3. Press the **▲** or **▼** button to select “Off” or “On”, then press the **ENTER** button.
Press the **EXIT** button to exit.
 - LNA functions only when antenna is set to AIR or CABLE. (See “Selecting the Antenna” on page 36.)
 - If the picture is noisy with the LNA set to On, select Off.
 - The LNA setting must be made separately for each channel.

Using Your TV as a Computer (PC) Display

Setting Up Your PC Software (Based on Windows XP)

The Windows display-settings for a typical computer are shown below. The actual screens on your PC will probably be different, depending upon your particular version of Windows and your particular video card. However, even if your actual screens look different, the same basic set-up information will apply in almost all cases. (If not, contact your computer manufacturer or Samsung Dealer.)

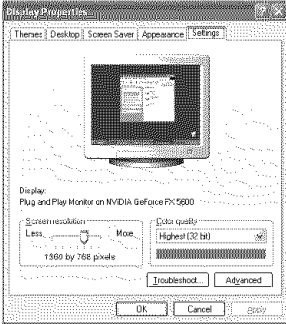

1. First, click on "**Control Panel**" on the Windows start menu.
2. When the control panel window appears, click on "**Appearance and Themes**" and a display dialog-box will appear.
3. When the control panel window appears, click on "**Display**" and a display dialog-box will appear.
4. Navigate to the "**Settings**" tab on the display dialog-box.

The correct size setting (resolution)

Optimum: 1024 x 768 pixels

If a vertical-frequency option exists on your display settings dialog box, the correct value is "60" or "60 Hz". Otherwise, just click "OK" and exit the dialog box.

Display Modes

If the signal from the system equals the standard signal mode, the screen is adjusted automatically. If the signal from the system doesn't equal the standard signal mode, adjust the mode by referring to your videocard user guide; otherwise there may be no video. For the display modes listed below, the screen image has been optimized during manufacture.

Video Signal	Resolution (Dot X Line)	Vertical Frequency (Hz)	Horizontal Frequency (KHz)	Horizontal Polarity	Vertical Polarity
IBM PC / AT Compatible	640 X 350	70.086	31.469	P	N
		720 X 400	70.087	31.469	N
	640 X 480	59.940	31.469	N	N
		70.000	35.000	N/P	N/P
		72.809	37.861	N	N
		75.000	37.500	N	N
		56.250	35.156	N/P	N/P
	800 X 600	60.317	37.879	P	P
		70.000	43.750	N/P	N/P
		72.188	48.077	P	P
		75.000	46.875	P	P
	848 X 480	60.000	31.020	P	P
74.769		37.684	N	P	

- The interlace mode is not supported.
- The TV operates abnormally if a non-standard video format is selected.
- The table above conforms to IBM/VESA regulations and is based on using the Analog Input.

- The PC text quality is optimum in WVGA mode (848 x 480@60Hz).
- When this TV is used as a PC display, 32-bit color is supported.
- Depending on the manufacturer, your PC display screen might appear different. (and depending on your particular version of Windows.)
Check your PC instruction book for information about connecting your PC to a TV.
- If a vertical and horizontal frequency-select mode exists, select 60Hz (vertical) and 48.4KHz (horizontal).
- In some cases, abnormal signals (such as stripes) might appear on the TV screen when the PC power is turned off (or if the PC is disconnected).
If so, press the SOURCE button on the remote control or SOURCE button on the side panel to enter a VIDEO mode. Also, make sure that the PC is connected.

Setting up the TV with your PC

How to Auto Adjust

Use the Auto Adjust function to have the TV set automatically adjust the video signals it receives from the PC. The function also automatically fine-tunes the settings and adjusts the frequency values and positions.

- This function does not work in DVI-Digital mode.
- Change to the PC mode first.

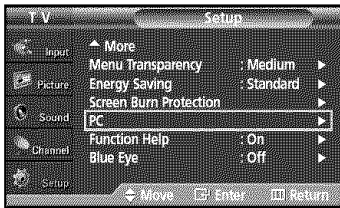

1. Press the **MENU** button to display the menu. Press the **▲** or **▼** button to select "Setup", then press the **ENTER** button. Press the **▲** or **▼** button to select "PC", then press the **ENTER** button.

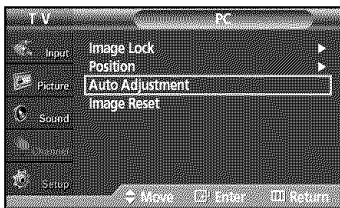

2. Press the **▲** or **▼** button to select "Auto Adjustment", then press the **ENTER** button. The message "Auto Adjustment in progress. Please wait." appears on the screen and the picture adjustments are automatically activated.

Press the **EXIT** button to exit.

Auto Adjustment in progress. Please wait.

Adjusting the Screen Quality

The purpose of the picture quality adjustment is to remove or reduce picture noise. If the noise is not removed by fine tuning alone, then do the frequency adjustments to the utmost and fine tune again. After the noise has been reduced, re-adjust the picture so that it is aligned on the center of the screen.

- Change to the PC mode first.

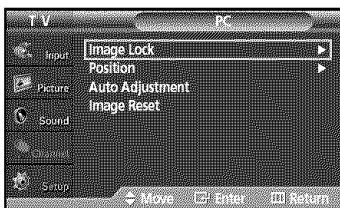

1. Press the **MENU** button to display the menu. Press the **▲** or **▼** button to select "Setup", then press the **ENTER** button. Press the **▲** or **▼** button to select "PC", then press the **ENTER** button.

2. Press the **ENTER** button to select "Image Lock".

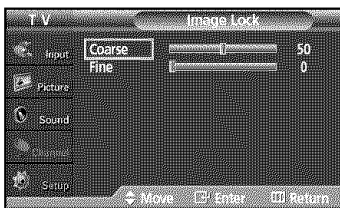

3. Press the **▲** or **▼** button to select "Coarse" or "Fine", then press the **ENTER** button. Press the **◀** or **▶** button to adjust the screen quality, then press the **ENTER** button. Press the **ENTER** button.

Press the **EXIT** button to exit.

- This feature may change the width of the image. If necessary, adjust the position to center.

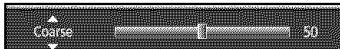

Changing the Screen Position

After connecting the TV to your PC, adjust the position of the screen if it is not well-aligned.

➤ Change to the PC mode first.

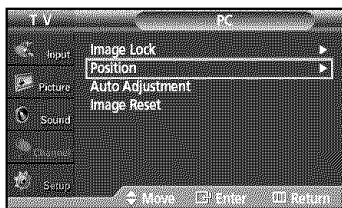

1. Press the **MENU** button to display the menu.
Press the **▲** or **▼** button to select "Setup", then press the **ENTER** button.
Press the **▲** or **▼** button to select "PC", then press the **ENTER** button.
2. Press the **▲** or **▼** button to select "Position", then press the **ENTER** button.

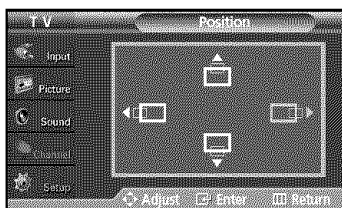

3. Press the **▲** or **▼** button to adjust the V-Position.
Press the **◀** or **▶** button to adjust the H-Position.
Press the **ENTER** button.
Press the **EXIT** button to exit.

Initializing the Screen Position or Color Settings

➤ Change to the PC mode first.

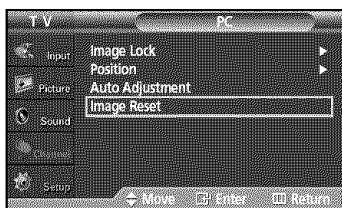

1. Press the **MENU** button to display the menu.
Press the **▲** or **▼** button to select "Setup", then press the **ENTER** button.
Press the **▲** or **▼** button to select "PC", then press the **ENTER** button.
2. Press the **▲** or **▼** button to select "Image Reset", then press the **ENTER** button.
The message "Image Reset is completed." appears on the screen.
Press the **EXIT** button to exit.

➤ The previously adjusted settings will be reset to the factory defaults.



Time Setting

Setting the Time

Setting the clock is necessary in order to use the various timer features of the TV. Also, you can check the time while watching the TV. (Just press the INFO button.)

Option 1: Setting the Clock Manually



1. Press the **MENU** button to display the menu. Press the **▲** or **▼** button to select "Setup", then press the **ENTER** button. Press the **▲** or **▼** button to select "Time", then press the **ENTER** button.

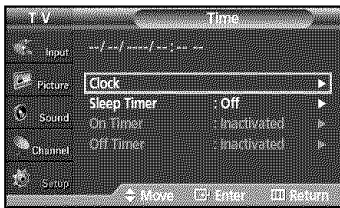

2. Press the **ENTER** button to select "Clock".

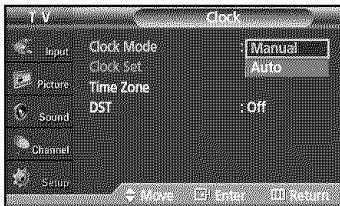

3. Press the **ENTER** button to select "Clock Mode". Press the **▲** or **▼** button to select "Manual", then press the **ENTER** button.

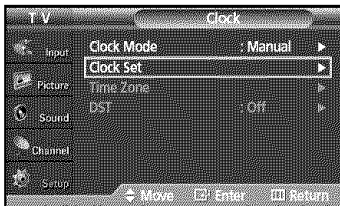

4. Press the **▲** or **▼** button to select "Clock Set", then press the **ENTER** button.

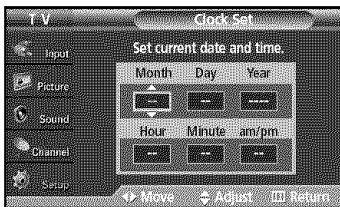

5. Press the **◀** or **▶** button to move to "Month", "Day", "Year", "Hour", "Minute", or "am/pm". Set the date and time you want by pressing the **▲** or **▼** button, then press the **ENTER** button.

Press the **EXIT** button to exit.

- The current time will appear every time you press the **INFO** button.
- You can set the month, day, year, hour, and minute directly by pressing the number buttons on the remote control.

Option 2: Setting the Clock Automatically

The Clock can be set automatically if you are receiving a digital signal.

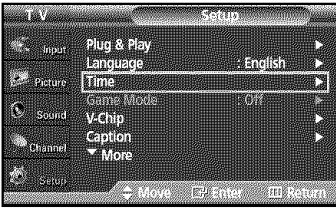

1. Press the **MENU** button to display the menu.
Press the **▲** or **▼** button to select "Setup", then press the **ENTER** button.
Press the **▲** or **▼** button to select "Time", then press the **ENTER** button.

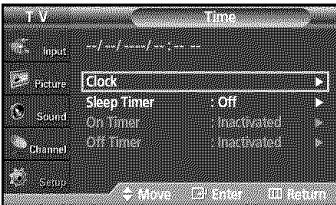

2. Press the **ENTER** button to select "Clock".

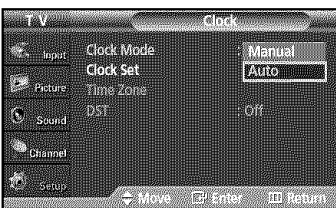

3. Press the **ENTER** button to select "Clock Mode".
Press the **▲** or **▼** button to select "Auto", then press the **ENTER** button.

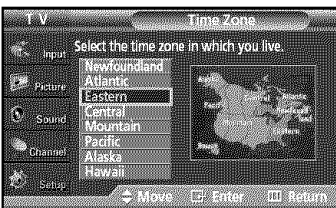

4. Press the **▲** or **▼** button to select "Time Zone", then press the **ENTER** button.
5. Press the **▲** or **▼** button to highlight the time zone for your local area (and to move the highlight to the appropriate time zone on the map of the United States), then press the **ENTER** button.

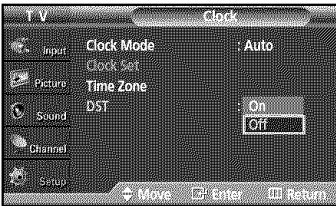

6. Press the **▲** or **▼** button to select "DST" (Daylight Saving Time), then press the **ENTER** button.
Press the **▲** or **▼** button to select "On" or "Off", then press the **ENTER** button.
Press the **EXIT** button to exit.
 - Depending on the broadcast station and signal, the auto time may not be set correctly. If this occurs, set the time manually.
 - Antenna or cable must be connected in order to set the time automatically.

Setting the On/Off Timer

You can preset a time to turn the TV On or Off.

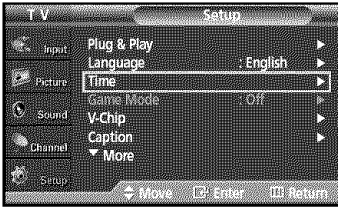

1. Press the **MENU** button to display the menu. Press the **▲** or **▼** button to select "Setup", then press the **ENTER** button. Press the **▲** or **▼** button to select "Time", then press the **ENTER** button.

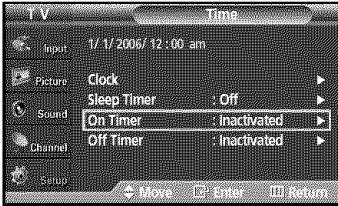

2. Press the **▲** or **▼** button to select "On Timer", then press the **ENTER** button.

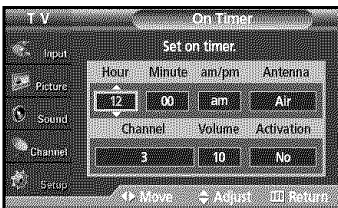

3. Press the **▲** or **▼** button to set the hour, then press the **▶** button to move to the next step. Set other items using the same method as above.
 - When finished, press the **MENU** button to return.
 - You can set the hour, minute, and channel directly by pressing the number buttons on the remote control.



4. Press the **▲** or **▼** button to select "Off Timer", then press the **ENTER** button.
5. Press the **▲** or **▼** button to set the hour, then press the **▶** button to move to the next step. Set other items using the same method as above. Press the **EXIT** button to exit.

➤ Auto Power Off

When you set the timer "On", the television will eventually turn off, if no controls are operated for 3 hours after the TV was turned on by the timer.

This function is only available in timer "On" mode and prevents overheating or leakage, which may occur if a TV is on for too long (when you are on vacation, for example).

Setting the Sleep Timer

The sleep timer automatically shuts off the TV after a preset time (from 30 to 180 minutes).

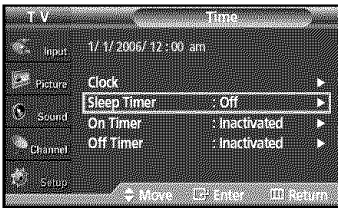

1. Press the **MENU** button to display the menu. Press the **▲** or **▼** button to select "Setup", then press the **ENTER** button. Press the **▲** or **▼** button to select "Time", then press the **ENTER** button.

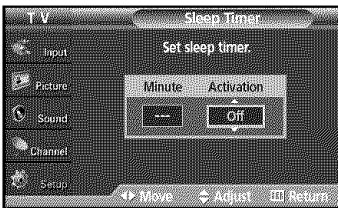

2. Press the **▲** or **▼** button to select "Sleep Timer", then press the **ENTER** button.

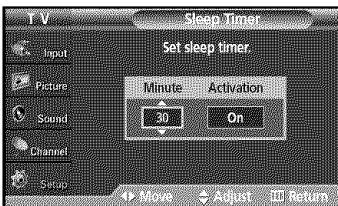

3. Press the **▲** or **▼** button to select the minute. Setting the Timer sets the Activation to "On" automatically.

To cancel the set sleep timer:

Press the **▶** button to select "Activation". Press the **▲** or **▼** button to select "Off", then press the **ENTER** button.

Press the **EXIT** button to exit.

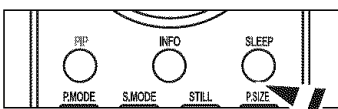

- Press the **SLEEP** button on the remote control until the appropriate time interval appears (any of the preset values from "30 min" to "180 min").

Function Description

Selecting a Menu Language



1. Press the **MENU** button to display the menu.
Press the **▲** or **▼** button to select "Setup", then press the **ENTER** button.
Press the **▲** or **▼** button to select "Language", then press the **ENTER** button.

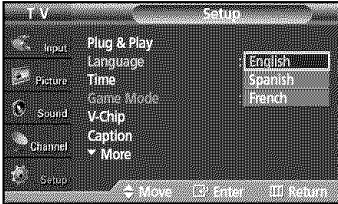

2. Press the **▲** or **▼** button to select the appropriate language: "English", "Spanish" or "French", then press the **ENTER** button.
Press the **EXIT** button to exit.

Using the Game Mode

When connecting to a game console such as PlayStation™ or Xbox™, you can enjoy a more realistic gaming experience by selecting game menu.



1. Press the **MENU** button to display the menu.
Press the **▲** or **▼** button to select "Setup", then press the **ENTER** button.
2. Press the **▲** or **▼** button to select "Game Mode", then press the **ENTER** button.



3. Select "Off" or "On" by pressing the **▲** or **▼** button, then press the **ENTER** button.
4. Press the **EXIT** button to exit.

➤ Restrictions on Game mode (Caution)

- To disconnect the game console and connect another external device, set Game to Off in the setup menu.
- If you display the TV menu in Game mode, the screen shakes slightly.
- The mark () appears on the screen which means that Game Mode is on with the selected source.



➤ If Game Mode is On

- Picture Mode is automatically changed to Custom and users cannot change the mode.
 - Sound Mode in the Sound menu is deactivated. Adjust the sound using the equalizer.
 - The Reset in the Sound menu is activated. Reset function initializes the Equalizer settings to the factory default setting.
- Game Mode is not available in TV mode.
- If the picture is poor when external device is connected to TV, check if Game Mode is On. Set Game Mode to Off and connect external devices.

Viewing Closed Captions (On-Screen Text Messages) - Digital

The Digital Captions function operates on digital channels.

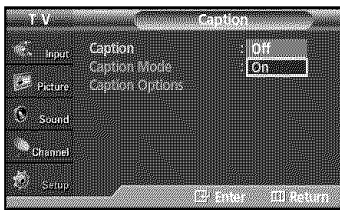

1. Press the **MENU** button to display the menu. Press the **▲** or **▼** button to select "Setup", then press the **ENTER** button.
2. Press the **▲** or **▼** button to select "Caption", then press the **ENTER** button.
3. Press the **ENTER** button to select "Caption". Press the **▲** or **▼** button to select "On", then press the **ENTER** button.

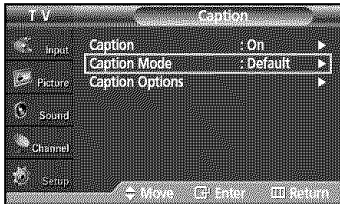

4. Press the **▲** or **▼** button to select "Caption Mode", then press the **ENTER** button. Press the **▲** or **▼** button to select submenu (Default, Service1~Service6, CC1~CC4 or Text1~Text4) you want, then press the **ENTER** button.

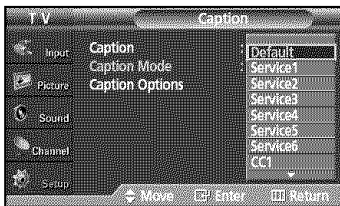

5. Press the **▲** or **▼** button to select "Caption Options", then press the **ENTER** button.
 - "Caption Options" are available only when "Service1~Service6" can be selected in "Caption Mode".
 - Service1~6 in digital caption mode may not be available depending on the broadcast.

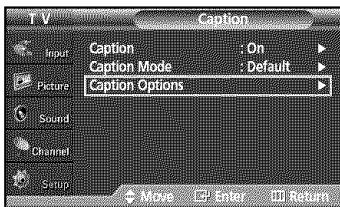

6. Press the **▲** or **▼** button to select "Size", then press the **ENTER** button. Press the **▲** or **▼** button to select the desired caption option, then press the **ENTER** button.

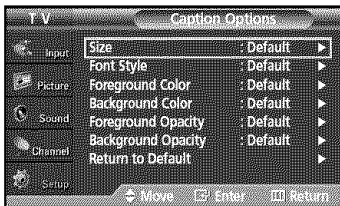

Press the **▲** or **▼** button to select the desired sub-menu options (see options below), then press the **ENTER** button.

Press the **EXIT** button to exit.

- The availability of captions depends on the program being broadcast.
- "Default" means to follow the standard set by the broadcaster.
- Foreground and Background cannot be set to have the same color.
- Foreground Opacity and Background Opacity cannot be both set to "Transparent".

- **Size:** This option consists of "Default", "Small", "Standard", and "Large". The default is "Standard".
- **Font Style:** This option consists of "Default", "Style0 ~ Style 7". You can change the font you want. The default is "Style 0".
- **Foreground Color:** This option consists of "Default", "White", "Black", "Red", "Green", "Blue", "Yellow", "Magenta", and "Cyan". You can change the color of the letter. The default is "White".
- **Background Color:** This option consists of "Default", "White", "Black", "Red", "Green", "Blue", "Yellow", "Magenta", and "Cyan". You can change the background color of the caption. The default is "Black".
- **Foreground Opacity:** This option consists of "Default", "Transparent", "Translucent", "Solid", and "Flashing". You can change the opacity of the letter.
- **Background Opacity:** This option consists of "Default", "Transparent", "Translucent", "Solid", and "Flashing". You can change the background opacity of the caption.
- **Return to Default:** This option sets each of "Size", "Font Style", "Foreground Color", "Background color", "Foreground Opacity", and "Background Opacity" to its default.

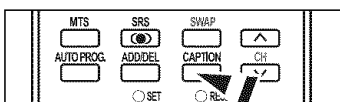

- Press the **CAPTION** button on the remote control to select "On" or "Off".

Viewing Closed Captions (On-Screen Text Messages) - Analog

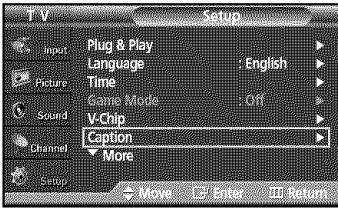

1. Press the **MENU** button to display the menu. Press the **▲** or **▼** button to select "Setup", then press the **ENTER** button.
2. Press the **▲** or **▼** button to select "Caption", then press the **ENTER** button.

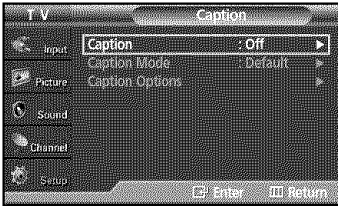

3. Press the **ENTER** button to select "Caption". Press the **▲** or **▼** button to select "On", then press the **ENTER** button.

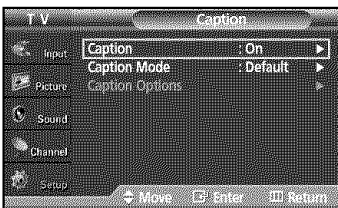

4. Press the **▲** or **▼** button to select "Caption Mode", then press the **ENTER** button. Press the **▲** or **▼** button to select submenu (CC1~CC4 or Text1~Text4) you want, then press the **ENTER** button.

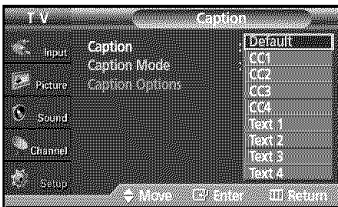

Press the **EXIT** button to exit.

- **The default is "CC1".**
- **CC1:** The Primary Synchronous Caption Service. These are captions in the primary language that must be in sync with the sound, preferably matched to a specific frame.
- **CC2:** The Special Non-Synchronous Use Captions. This channel carries data that is intended to augment information carried in the program.
- **CC3:** Secondary Synchronous Caption Service. Alternate program-related caption data, typically second language captions.
- **CC4:** Special Non-Synchronous Use Captions. Similar to CC2.
- **Text1:** First Text Service. This may be various non-program related data.
- **Text2:** Second Text Service. Additional data, usually not program related.
- **Text3/Text4:** Third and Fourth Text Services. These data channels should be used only if Text1 and Text2 are not sufficient.

- The Caption feature doesn't work in COMPONENT, PC, HDMI(DVI) modes.
- The availability of captions depends on the program being broadcast.

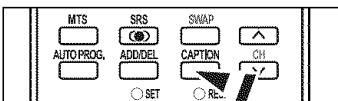

- Press the **CAPTION** button on the remote control to select "On" or "Off".

Menu Transparency Level

Adjusts the transparency of the menu screen.

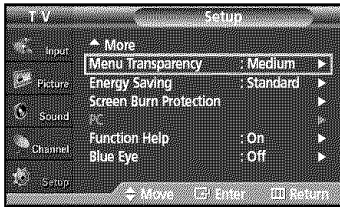

1. Press the **MENU** button to display the menu.
Press the **▲** or **▼** button to select "Setup", then press the **ENTER** button.
2. Press the **▲** or **▼** button to select "Menu Transparency", then press the **ENTER** button.

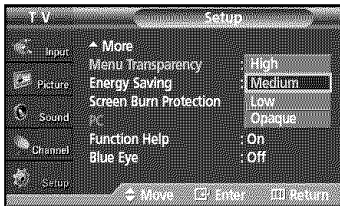

3. Press the **▲** or **▼** button to select level, then press the **ENTER** button.
Press the **EXIT** button to exit.

Using the Energy Saving Feature

This feature adjusts the screen brightness automatically depending on the surrounding lighting conditions.

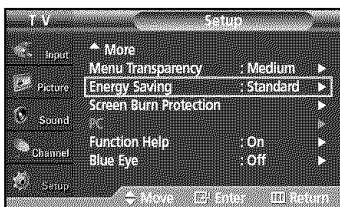

1. Press the **MENU** button to display the menu.
Press the **▲** or **▼** button to select "Setup", then press the **ENTER** button.
2. Press the **▲** or **▼** button to select "Energy Saving", then press the **ENTER** button.
Press the **▲** or **▼** button to select submenu (Standard, Auto Saving, Super Saving) you want, then press the **ENTER** button.

Press the **EXIT** button to exit.

- **Standard:** Operates in standard mode regardless of the surrounding illumination.
- **Auto Saving:** Automatically adjusts to the surrounding illumination.
- **Super Saving:** Enters maximum power saving mode regardless of the surrounding illumination.

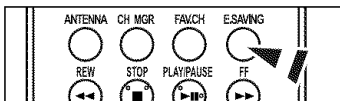
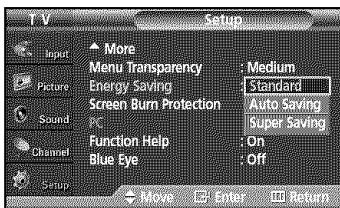

-  Press the **E.SAVING** button to select the energy saving setting.

Preventing Screen Burn-in

To reduce the possibility of screen burn, this unit is equipped with screen burn prevention technology. This technology enables you to set picture movement up/down (Vertical Line) and side to side (Horizontal Dot). The Time setting allows you to program the time between movement of the picture in minutes.

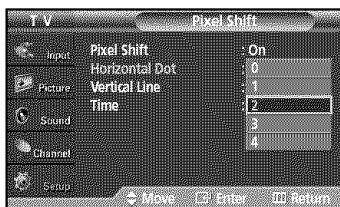
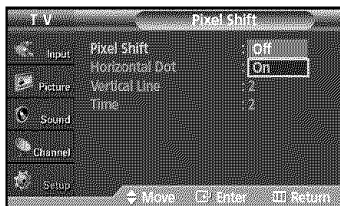
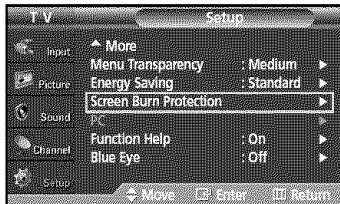

1. Press the **MENU** button to display the menu. Press the **▲** or **▼** button to select "Setup", then press the **ENTER** button.
2. Press the **▲** or **▼** button to select "Screen Burn Protection", then press the **ENTER** button.
3. Press the **ENTER** button to select "Pixel Shift", then press the **ENTER** button. Pressing the **▲** or **▼** button will alternate between "On" and "Off". You will also see the items "Horizontal Dot", "Vertical Line" and "Time".

• **Pixel Shift:** Using this function, you can minutely move pixels on the PDP in horizontal or vertical direction to prevent after-images on the screen.

4. Press the **▲** or **▼** button to select the item you wish to change, then press the **ENTER** button. Press the **▲** or **▼** button to change the value of the item, then press the **ENTER** button.

• Optimum condition for pixel shift;

Horizontal Dot	2
Vertical Line	2
Time(min)	2

Press the **EXIT** button to exit.

Reducing the Effects of Screen Burn

If screen burn has occurred, you can select a white screen or signal pattern (rolling screen) to help remove screen burn artifacts.

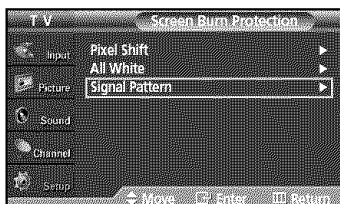
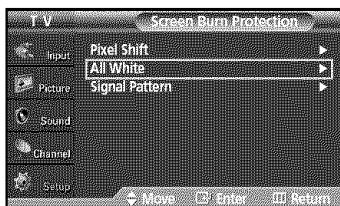
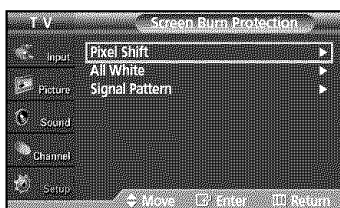

1. Press the **MENU** button to display the menu. Press the **▲** or **▼** button to select "Setup", then press the **ENTER** button.
2. Press the **▲** or **▼** button to select "Screen Burn Protection", then press the **ENTER** button.
3. Press the **▲** or **▼** button to select "All White" or "Signal Pattern", then press the **ENTER** button.

Press the **EXIT** button to exit.

• **All White:** This function removes after-images on the screen by changing the color of pixels to white. Use this function when there are remaining after-images or symbols on the screen especially when you displayed a still image on the screen for a long time.

• **Signal Pattern:** This function removes after-images on the screen by moving all the pixels on the PDP according to a pattern. Use this function when there are remaining after-images or symbols on the screen especially when you displayed a still image on the screen for a long time.

- To remove after-images on the screen, use either the "All White" or "Signal Pattern" function. Although both functions remove after-images on the screen, "Signal Pattern" is more effective.
- The after-image removal function has to be executed for a long time (approximately 1 hour) to effectively remove after-images on the screen. If the after-image is not removed after performing the function, repeat the function again.
- Press any key on the remote control to cancel this feature.

Setting the Function Help

Displays help on the menu functions.

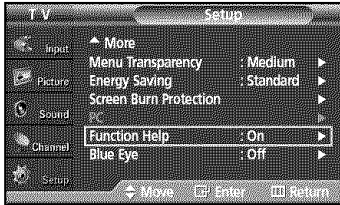

1. Press the **MENU** button to display the menu.
Press the **▲** or **▼** button to select "Setup", then press the **ENTER** button.
2. Press the **▲** or **▼** button to select "Function Help", then press the **ENTER** button.

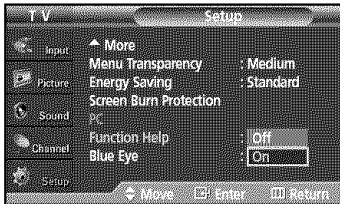

3. Press the **▲** or **▼** button to select "Off" or "On", then press the **ENTER** button.
Press the **EXIT** button to exit
➤ The Function Help default setting is On.



Setting the Blue Eye

You can set the Blue Power LED on or off. If the TV's power is tuned off when Blue Eye is set to off, the Blue LED goes off after 5 seconds. This will save power and reduce eye fatigue.

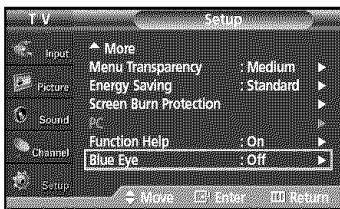

1. Press the **MENU** button to display the menu.
Press the **▲** or **▼** button to select "Setup", then press the **ENTER** button.
2. Press the **▲** or **▼** button to select "Blue Eye", then press the **ENTER** button.

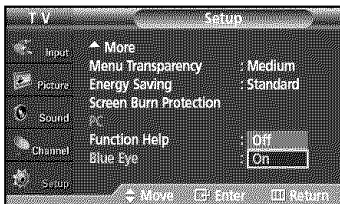

3. Press the **▲** or **▼** button to select "Off" or "On", then press the **ENTER** button.
Press the **EXIT** button to exit

- ♦ **Off:** LED(Blue) will not come on.
- ♦ **On:** LED(Blue) will come on after you turn the TV off.

Using the V-Chip

The V-Chip feature automatically locks out programs that are deemed inappropriate for children. The user must enter a PIN (personal ID number) before any of the V-Chip restrictions are set up or changed.

- When the V-Chip feature is activated, the PIP features do not function.
- The V-Chip does not work if the input is DTV (HD or SD).
- V-Chip function is not available in HDMI or component mode.

Setting Up Your Personal ID Number (PIN)

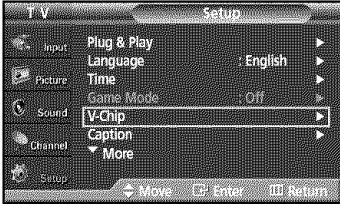

1. Press the **MENU** button to display the menu. Press the **▲** or **▼** button to select "Setup", then press the **ENTER** button.
2. Press the **▲** or **▼** button to select "V-Chip", then press the **ENTER** button. The message "Enter PIN" will appear. Enter your 4 digit PIN number.

- The default PIN number of a new TV set is "0-0-0-0".

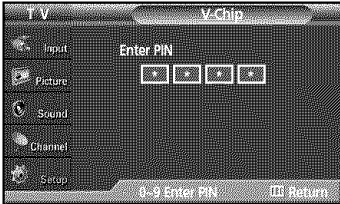

3. The "V-Chip" screen will appear. Press the **▲** or **▼** button to select "Change PIN", then press the **ENTER** button. The Change PIN screen will appear. Choose any 4 digits for your PIN and enter them. As soon as the 4 digits are entered, the "Confirm New PIN" screen appears. Re-enter the same 4 digits. When the Confirm screen disappears, your PIN has been memorized.

Press the **EXIT** button to exit.

- If you forget the PIN, press the remote-control buttons in the following sequence, which resets the pin to 0-0-0-0 : Power Off. → Mute → 8 → 2 → 4 → Power On.

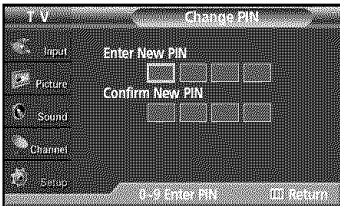

How to Enable/Disable the V-Chip

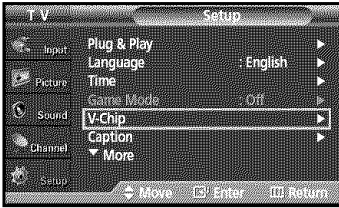

1. Press the **MENU** button to display the menu. Press the **▲** or **▼** button to select “Setup”, then press the **ENTER** button.
2. Press the **▲** or **▼** button to select “V-Chip”, then press the **ENTER** button. The message “Enter PIN” will appear. Enter your 4 digit PIN number.

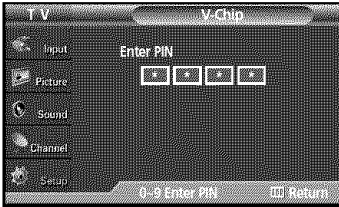

3. The “V-Chip” screen will appear. To enable the V-Chip feature, press the **ENTER** button so that the “V-Chip Lock” field is “On”. (Pressing the **▲** or **▼** button will alternate between “On” and “Off”.) Press the **ENTER** button.

Press the **EXIT** button to exit.

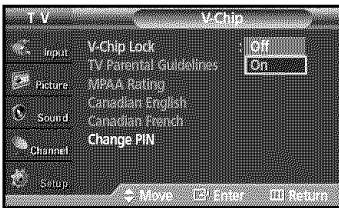

How to Set up Restrictions Using “TV Parental Guidelines”

First, set up a personal identification number (PIN), and enable the V-Chip. (See previous section.)

Parental restrictions can be set up using either of two methods: The TV guidelines or the MPA A rating.

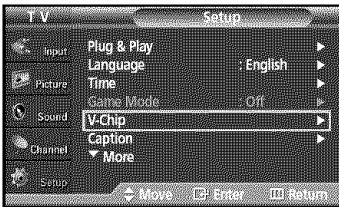

1. Press the **MENU** button to display the menu. Press the **▲** or **▼** button to select “Setup”, then press the **ENTER** button.

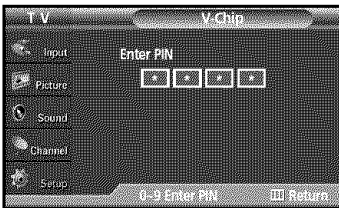

2. Press the **▲** or **▼** button to select “V-Chip”, then press the **ENTER** button. The message “Enter PIN” will appear. Enter your 4 digit PIN number.





3. The “V-Chip” screen will appear. Press the **▲** or **▼** button to select “TV Parental Guidelines”, then press the **ENTER** button.
4. The “TV Parental Guidelines” screen will appear. Press the **▲** or **▼** button to select one of the six aged based categories:

• TV-Y: Young children	• TV-G: General audience
• TV-Y7: Children 7 and over	• TV-PG: Parental guidance
	• TV-14: Viewers 14 and over
	• TV-MA: Mature audience

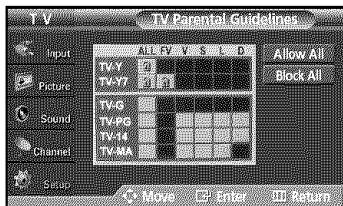
Continued...





- 5.** At this point, one of the TV-Ratings is selected. Press the **ENTER** button. Depending on your existing setup, the “” symbol will be selected. (Blank = Unblocked,  = Blocked)

While “” is selected, press the **ENTER** button to block or unblock the category. To select a different TV-Rating, press the **▲** or **▼** button and then repeat the process.

 - Allow all: Press to unlock all TV ratings. / Block all: Press to lock all TV ratings.
 - The TV-Y, TV-Y7, TV-G, TV-PG, TV-14 and TV-MA have additional options. See the next step to change any of the following sub-ratings:
 - FV: Fantasy violence / D: Sexually Suggestive Dialog / L: Adult Language / S: Sexual situation / V: Violence
 - The V-Chip will automatically block certain categories that are “more restrictive”. For example, if you block “TV-Y” category, then TV-Y7 will automatically be blocked. Similarly, if you block the TV-G category, then all the categories in the “young adult” group will be blocked (TV-G, TV-PG, TV-14, and TV-MA). The sub-ratings (D, L, S, V) work together similarly. (See next section.)

- 6.** How to set the FV, D, L, S and V sub-ratings.

First, select one of these TV-Ratings: TV-Y, TV-Y7, TV-G, TV-PG, TV-14, or TV-MA (See Step 4, on page 54), and press the **ENTER** button. The “” symbol will be displayed for each sub-rating.

While “” is selected, press the **▶** button to go to a sub rating. Press the **ENTER** to block the sub rating. To select a different TV-Rating, press the **▲** or **▼** button and then repeat the process.

 - The V-chip will automatically block certain categories that are “More restrictive”. For example, if you block “L” sub-rating in TV-PG, then the “L” sub-ratings in TV-14 and TV-MA will automatically be blocked.

- 7.** Press the **EXIT** button to clear all the screens. (Or proceed to the next section, and set up additional restrictions based on the MPAA codes.)

 - These categories consist of two separate groups: TV-Y and TV-Y7 (young children through age 7), and TV-G through TV-MA (everybody else). The restrictions for these two groups work independently: If a household includes very young children as well as young adults, the TV guidelines must be set up separately for each age group. (See next step.)

How to Set up Restrictions Using the MPAA Ratings: G, PG, PG-13, R, NC-17, X, NR

The MPAA rating system uses the Motion Picture Association of America (MPAA) system, and its main application is for movies. When the V-Chip lock is on, the TV will automatically block any programs that are coded with objectionable ratings (either MPAA or TV-Ratings).

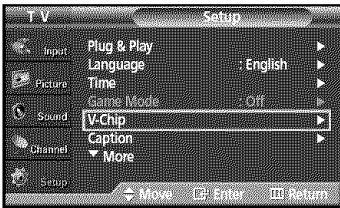

1. Press the **MENU** button to display the menu. Press the **▲** or **▼** button to select "Setup", then press the **ENTER** button.
2. Press the **▲** or **▼** button to select "V-Chip", then press the **ENTER** button. The message "Enter PIN" will appear. Enter your 4 digit PIN number.

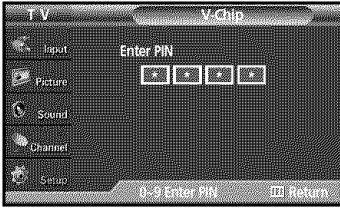

3. The "V-Chip" screen will appear. Press the **▲** or **▼** button to select "MPAA Rating", then press the **ENTER** button.



4. Press the **▲** or **▼** button to select a appropriate restriction. Press the **ENTER** button to activate the restriction selected. The "🔒" symbol is indicated. Press the **EXIT** button to exit.

➤ Allow all: Press to unlock all TV ratings. / Block all: Press to lock all TV ratings.

- **G:** General audience (no restrictions).
- **PG:** Parental guidance suggested.
- **PG-13:** Parents strongly cautioned.
- **R:** Restricted. Children under 17 should be accompanied by an adult.
- **NC-17:** No children under age 17.
- **X:** Adults only.
- **NR:** Not rated.

➤ The V-Chip will automatically block any category that is "more restrictive". For example, if you block the "PG-13" category, then "R", "NC-17" and "X" will automatically be blocked also.

How to Set up Restrictions Using 'Canadian English'

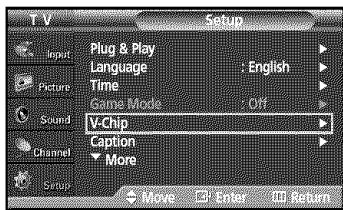

1. Press the **MENU** button to display the menu. Press the **▲** or **▼** button to select "Setup", then press the **ENTER** button.
2. Press the **▲** or **▼** button to select "V-Chip", then press the **ENTER** button. The message "Enter PIN" will appear. Enter your 4 digit PIN number.

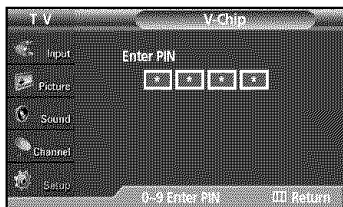

3. The "V-Chip" screen will appear. Press the **▲** or **▼** button to select "Canadian English", then press the **ENTER** button.

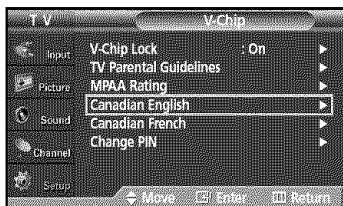

4. Press the **▲** or **▼** button to select a appropriate restriction. Press the **ENTER** button to activate the restriction selected. The "🔒" symbol is indicated.

Press the **EXIT** button to exit.

➤ Allow all: Press to unlock all TV ratings. / Block all: Press to lock all TV ratings.

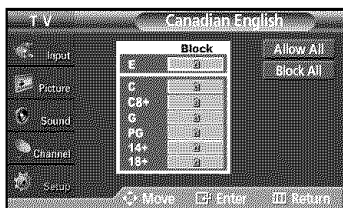

- **E**: Exempt programming includes...news, sports, documentaries and other information programming, talk shows, music videos, and variety programming.
- **C**: Programming intended for children under age 8.
- **C8+**: Programming generally considered acceptable for children 8 years and over to watch on their own.
- **G**: General programming, suitable for all audiences.
- **PG**: Parental Guidance.
- **14+**: Programming contains themes or content which may not be suitable for viewers under the age of 14.
- **18+**: Adult programming.

➤ The V-Chip will automatically block any category that is "more restrictive". For example, if you block "G" category, then "PG", "14+" and "18+" will automatically be blocked also.

How to Set up Restrictions Using 'Canadian French'

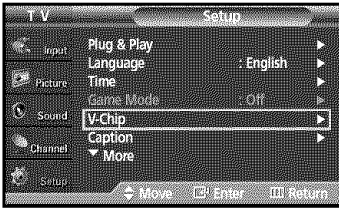

1. Press the **MENU** button to display the menu. Press the **▲** or **▼** button to select "Setup", then press the **ENTER** button.
2. Press the **▲** or **▼** button to select "V-Chip", then press the **ENTER** button. The message "Enter PIN" will appear. Enter your 4 digit PIN number.

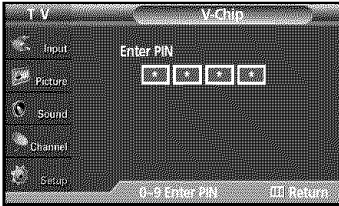

3. The "V-Chip" screen will appear. Press the **▲** or **▼** button to select "Canadian French", then press the **ENTER** button.

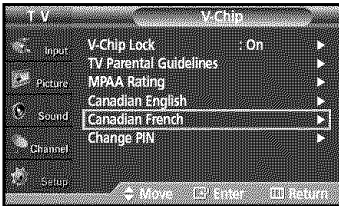

4. Press the **▲** or **▼** button to select a appropriate restriction. Press the **ENTER** button to activate the restriction selected. The "🔒" symbol is indicated.

Press the **EXIT** button to exit.

➤ Allow all: Press to unlock all TV ratings. / Block all: Press to lock all TV ratings.

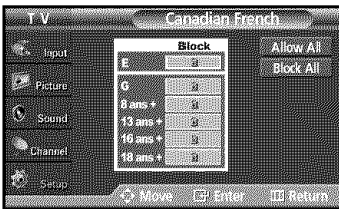

- **E:** Exempt programming includes...news, sports, documentaries and other information programming, talk shows, music videos, and variety programming.
- **G:** General.
- **8 ans+:** Not recommended for young children.
- **13 ans+:** Programming may not be suitable for children under the age of 13.
- **16 ans+:** Programming is not suitable for children under the age of 16.
- **18 ans+:** Programming restricted to adults.

➤ The V-Chip will automatically block any category that is "more restrictive". For example, if you block "8 ans+" category, then "13 ans+", "16 ans+" and "18 ans+" will automatically be blocked also.

How to Reset the TV after the V-Chip Blocks a Channel ("Emergency Escape")

If the TV is tuned to a restricted channel, the V-Chip will block it. The screen will go blank and the following message will appear:

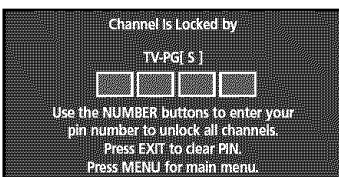

1. Enter your PIN.

To resume normal viewing, tune to a different channel using **CH ▲** or **CH ▼** button. Under certain conditions (depending on the rating of the local TV programs) the V-Chip might lock out all the channels. In this case, use the V-Chip function for an "emergency escape":

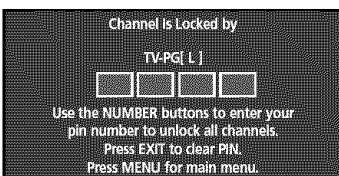

1. Press the **MENU** button. Press the **▲** or **▼** button to select "Setup", then press the **ENTER** button.
2. Press the **▲** or **▼** button to select "V-Chip", then press the **ENTER** button.
3. Enter your PIN, then press the **ENTER** button, and press the **▲** or **▼** button to temporarily disable the V-Chip Lock.

➤ If you forget the PIN, press the remote-control buttons in the following sequence, which resets the pin to 0-0-0-0 : Power Off. → Mute → 8 → 2 → 4 → Power On.

Appendix

Identifying Problems

If the TV seems to have a problem, first try this list of possible problems and solutions.

If none of these troubleshooting tips apply, call your nearest Samsung service center.

Problem	Possible Solution
Poor picture	Try another channel. Adjust the antenna. Check all wire connections.
Poor sound quality.	Try another channel. Adjust the antenna.
No picture or sound.	Try another channel. Press the SOURCE button. Make sure the TV is plugged in. Check the antenna connections. Make sure the MUTE button is off.
No sound or sound is too low at maximum volume.	First, check the volume of units connected to your TV (digital broadcasting receiver, DVD, cable broadcasting receiver, VCR, etc.). Then, adjust the TV volume accordingly.
Picture rolls vertically.	Check all wire connections.
The TV operates erratically.	Unplug the TV for 30 seconds, then try operating it again.
The TV won't turn on.	Make sure the wall outlet is working.
Remote control malfunctions	Replace the remote control batteries. Clean the upper edge of the remote control (transmission window). Check the battery terminals. Press the TV button to put your remote in the "TV" mode. Make sure the remote has batteries. Check that the "+" and "-" ends of the batteries are inserted correctly.
Digital broadcasting screen problem.	Please check the digital signal strength and input antenna.
The image is too light or too dark.	Adjust the Brightness and Contrast. Adjust the Fine tuning.
The image is too large or too small.	Adjust the Size settings.
Screen is black and power indicator light blinks steadily.	On your computer check; Power, Signal Cable. The TV is using its power management system. Move the computer's mouse or press any key on the keyboard. On your computer check; Power, Signal Cable. The TV is using its power management system. Move the computer's mouse or press any key on the keyboard.
The visual qualities of digital channels vary.	The visual qualities of digital channels may vary depending on the original production method (analog or digital). • If the original production method is digital: High visual quality program. • If the original production method is analog: The digital program displayed on the screen is originally an analog program which has been converted to digital. The visual quality is of an SD grade.
Although the TV caption shows HD, the visual quality is not satisfactory.	The HD caption that appears when switching channels or when pressing the Information button on the remote control means the selected channel is a digital channel. If the broadcasting station converts an analog signal into digital and transmits the signal, the visual quality may not be perfect.

Wall Installation Instructions

Refer to the installation guide supplied with your wall bracket.

Installation Notes

1. Contact a professional installation service to install the wall bracket.
2. Samsung Electronics is not responsible for any damages to the product or harm to customers or others when the installation is done by the customer.
3. This product is for installing on cement walls. The product may not stay in place when installed on plaster or wood.
4. Connect all external devices prior to installing the wall bracket.
5. The package contents and parts supplied for the wall mount are subject to change without prior notice.

Parts (Wall attachment panel is sold separately. Check with your dealer.)

Please use only the parts and components provided for wall mount installation.

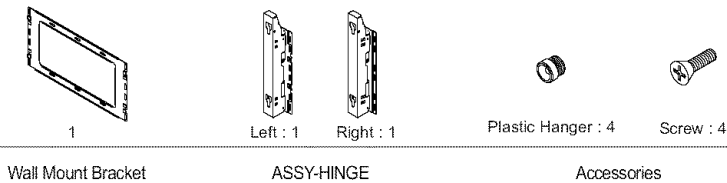

How to assemble the Wall Mount Bracket

1. The wall mount bracket is delivered separately. Please tighten the captive screw in the direction of the arrow after assembling the bracket.
Install the Wall Mount Bracket after the screws are securely inserted into the wall.

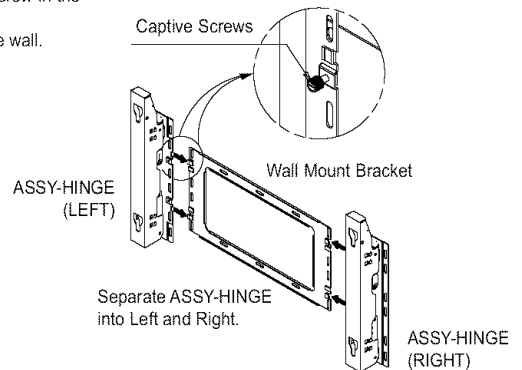

Fixing the TV panel to the wall attachment panel bracket

The shape of the product may vary depending on the model. (The assemblies of the plastic hanger and the screw are the same)

1. Remove the screws from the back of the PDP.

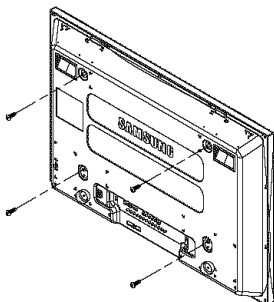

2. Use the screw and assemble the plastic hanger. (Please refer to the following picture.)



- Please ask the installers to install the wall mount bracket.
- Please be sure to check if the plastic hanger is completely secured on both the left and right side after hanging the SET on the wall mount bracket.
- Please avoid catching your fingers while installing and adjusting the angle.
- Please tightly secure the wall mount bracket to the wall to avoid injury from a falling TV.

3. Tighten the screws of the plastic hanger (shown in picture 2) to the back side of the PDP.

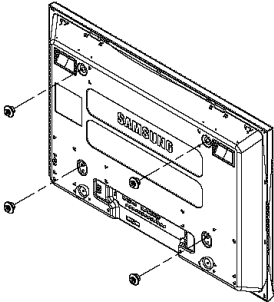

4. Remove the Safety Pins. Fasten the 4 plastic latches assembled at step (3) on the back side of the PDP using the guide holes of the wall mount, push (1) and hook (2) down to secure the PDP on the wall mount as illustrated. Secure the PDP by inserting the Safety Pins, not to fall from the wall mount.

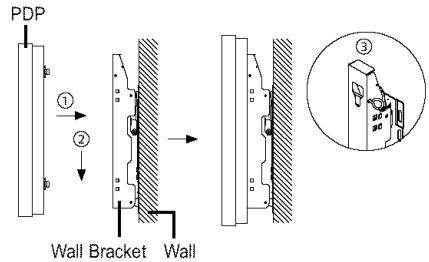

How to Adjust Mounting Angle

Note: Please secure the mounting bracket on the wall surface after setting its angle at 0°

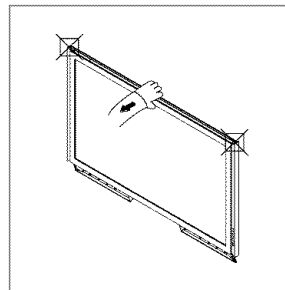
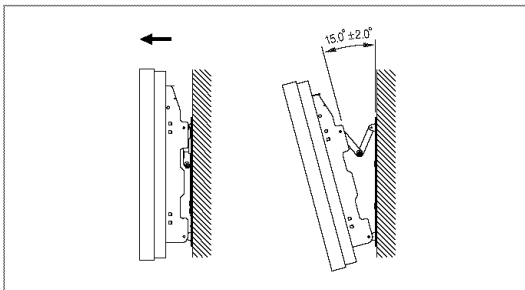

1. Secure the SET to the wall mount bracket.
(Please refer to the following instructions.)
2. Set the angle by pulling the upper end of the SET attached to bracket in the direction of the arrow.
(Refer to the illustration on the right.)
3. The angle can be adjusted from 0° to 15° by ±2°.

Hold onto the middle of the PDP to adjust the angle (not the sides of the PDP).

Connecting External Devices to the PDP

Note: To connect external devices such as a DVD or a Home Theater System to the PDP, please refer to following instructions:

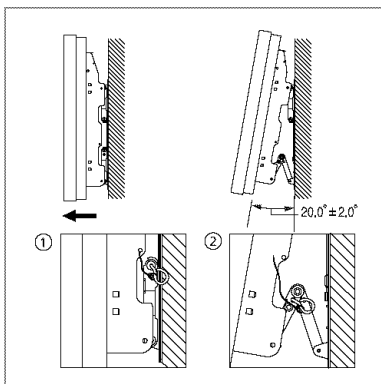

1. Be sure to remove the safety pins underneath the PDP.
Note: If the safety pins are not removed, the angle cannot be adjusted. Any attempt to do so may cause damage to the PDP.
 2. Hold onto the bottom of the PDP and pull forward fully as directed by the arrow as illustrated to adjust the angle. (0°~20° by 2°) Insert the Safety Pins to the front guide holes on both sides as illustrated in figure (2).
Note: Viewing the PDP after connecting the external devices Remove the Safety Pins to adjust the angle to 0°, and then secure the Safety Pins again.
- For safety, be sure to secure the PDP using the safety pins. If the safety pins are not used, the PDP may fall, causing serious injury.

How to assemble the Stand-Base

- Using the 4 screws for securing the stand pegs and the monitor, firmly attach the monitor to the stand pegs. (The exterior of the set may be different than the picture.)

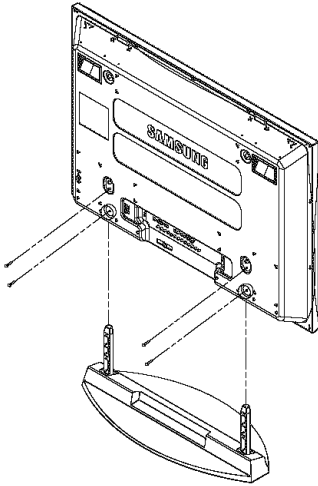

Warning

Firmly secure the stand to the TV before moving it, as the stand may fall and could cause serious injury.

- Two or more people should carry the TV. Never lay the TV on the floor because of possible damage to the screen. Always store the TV upright.

Specifications

Model Name	SP-S4243
Screen Size (Diagonal)	42 inch
Power Supply	AC 110-120V~ 60Hz
Power Consumption	330 W
PC Resolution	848 x 480 @ 60 Hz
Antenna Input	ANT 1 - CABLE IN ANT 2 - AIR IN ※75Ω unbalanced
Video Input	AV1, AV2 S-VIDEO1, S-VIDEO2 COMPONENT1 - 480i/480p/720p/1080i COMPONENT2 - 480i/480p/720p/1080i PC HDMI1 (DVI Compatible) HDMI2
Audio Input	AV1, AV2 S-VIDEO1, S-VIDEO2 COMPONENT1 - 480i/480p/720p/1080i COMPONENT2 - 480i/480p/720p/1080i PC DVI
Sound Output	AUDIO (L/R)
Audio Output	OPTICAL (DIGITAL OUT) COAXIAL (DIGITAL OUT)
Dimensions (WxDxH)	
Body	41.5 X 28 X 3.8 inches (1054.1 X 711.2 X 96.5 mm)
With stand	41.5 X 30.3 X 13.4 inches (1054.1 X 769.6 X 340.4 mm)
Weight	
Body	72.8 lbs (33 kg)
With stand	85.3 lbs (38.7 kg)

- Design and specifications are subject to change without prior notice.

Dimensions

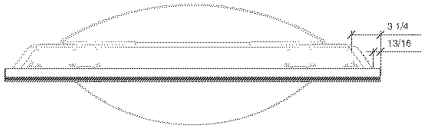

TOP VIEW

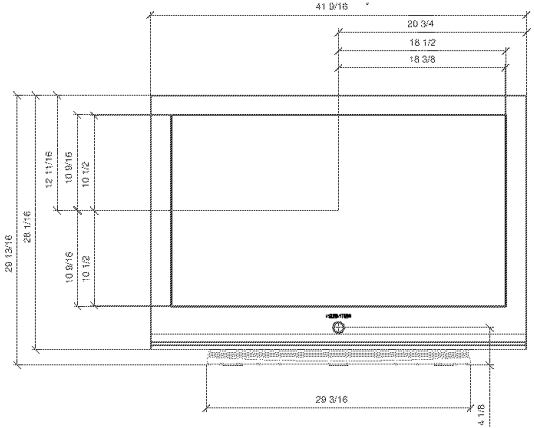

FRONT VIEW

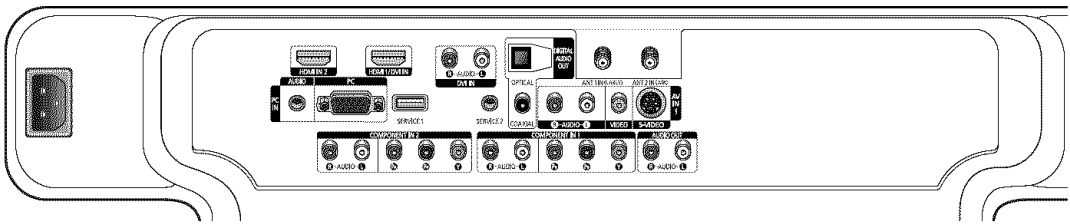

JACK PANEL DETAIL 2 1/4"H x 18 3/4"W @ 5 3/4" UP FROM BOTTOM

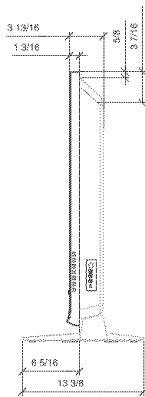

SIDE VIEW

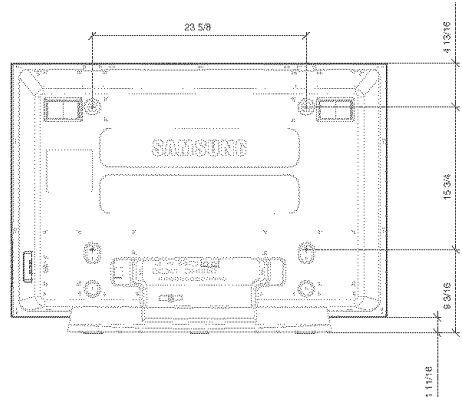

REAR VIEW

NOTE: All drawings not necessarily to scale. Some dimensions are subject to change without prior notice. Refer to dimensions on each unit prior to performing any carpentry. Not responsible for typographical or printed errors.
© 2006 Samsung Electronics America, Inc.



Contact SAMSUNG WORLD-WIDE

If you have any questions or comments relating to Samsung products, please contact the SAMSUNG customer care center.

Country	Customer Care Center ☎	Web Site	Address
CANADA	1-800-SAMSUNG (7267864)	www.samsung.com/ca	Samsung Electronics Canada Inc., Customer Service 55 Standish Court Mississauga, Ontario L5R 4B2 Canada
			Samsung Electronique Canada Inc., Service à la Clientèle 55 Standish Court Mississauga, Ontario L5R 4B2 Canada
U.S.A	1-800-SAMSUNG (7267864)	www.samsung.com	Samsung Electronics America, Inc. 105 Challenger Road Ridgefield Park, NJ 07660-0511