

TOSHIBA



DVD VIDEO RECORDER

D-R5SU D-R5SC

OWNER'S MANUAL



HDMI™

Before connecting, operating or adjusting this product,
please read this instruction booklet carefully and completely.



Installation Procedure

Read carefully “SAFETY PRECAUTIONS”,
“IMPORTANT SAFETY INSTRUCTIONS” and
“Precautions”.
(➡ pages 4 to 9)

Check the supplied accessories.
(See right)

Load the batteries in the remote control.
(➡ page 19)

Connect an antenna to the recorder.
(➡ page 25)
Connect a cable box or satellite system to the recorder.
(➡ pages 27 to 29)

Connect the recorder to a TV.
(➡ pages 26 to 30,32)

Connect optional equipment to the recorder.
(➡ page 33)

Make the initial settings.
(➡ page 45)

Accessories

Remote control
Batteries (AA) x 2



RF cable

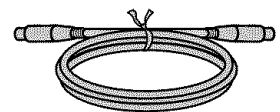

Video/audio cable

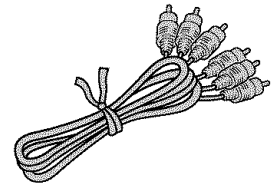

- Owner's manual
- Quick Setup Guide

Your recorder is ready. Read “Recording”
section of this manual.

Table of Contents

Introduction

Installation Procedure	2
Table of Contents	3
SAFETY PRECAUTIONS	4
IMPORTANT SAFETY INTRODUCTIONS	6
Precautions	8
Notes on handling	8
When not in use	8
Notes on placement	8
Notes on cleaning	8
Notes on antennas	8
Notes on recording and editing	8
Power Outage	8
Notes on the unit	8
Notes on moisture condensation	9
About This Product	10
Some differences	10
Playback Restrictions	10
Recording Restrictions and Copyright	10
Compatibility	10
Choosing a disc	11
On DVD-RAM discs	13
On DVD-R discs	14
On DVD-RW discs	14
Marks on DVD video discs	14
Structure of disc contents	15
On handling discs	15
On cleaning discs	15
On storing discs	15
Discs and purposes	16
Index to parts and controls	17
Remote control	17
Preparation of the remote control	19
Display	20
Front panel	21
Rear panel	22
Before operating this recorder	23

Connections

Connecting an antenna and TV	25
Connecting to cable TV signal	27
Connecting to a satellite system	29
Connecting to a TV with the HDMI terminal	30
About HDMI™	30
Setting the output resolution for the HDMI™ output that best matches your TV's capabilities	31
Audio setting for the HDMI™ connection	31
Connecting to a TV equipped with component video inputs	32
Connecting to an audio system	33

Quick Start Guide

Power up	34
Plugging In and Power On	34
Time and Date Settings	34
Channels Setup	34
Auto Scanning Channels	34
Restore Defaults	34
Switching to TV Mode	34

Playback

Disc Playback	35
Inserting a Disc	35
Starting, Stopping and Pausing Playback	35
Fast Forward / Reverse Scanning	35
Skipping to the Next / Previous Chapter or Track	35
Slow Motion Playback	35
Frame-By-Frame Step Playback	35
Advanced Playback Functions	36
ZOOM Playback	36
Instant Replay	36
Instant Skip	36
Multi-Angle Function	36
Changing the Auto Track	36
Subtitles	36
Displaying Playback Session Information	36
Jumping and Repeat Playback	37
Jumping to a Title, Chapter/Track or Time Point	37
Repeat Playback	37

A-B Repeat	37
TIMESLIP (Chase Play)	37
Viewing JPEG/Play Audio CD/MP3/WMA/DivX®	38
JPEG Images, Slide shows and Rotation	38
MP3/WMA file Playback	39
DivX® File Playback	39

Recording

Recording-Rear Input Connections	40
Selecting an Input Source	40
Recording-Front Input Connections	41
Controlling a DV Camcorder	41
Making a Recording	41
Stopping a Recording	41
Pausing and Resume Recording	41
Specifying the Recording Time	41
Finalize	41
Using DISPLAY to View Recording Options	41
Playing and Editing Your Recordings	42
The Title Screen	42
Playing a Title	42
Playing a Chapter	42
Renaming a Title	42
Delete a Title	42
Renaming a Disc	42
On-Screen Keyboard & Scheduled Recordings	43
About On-Screen Keyboard	43
Using the On-Screen Keyboard	43
Deleting Characters	43
Saving Your Changes	43
Scheduled Recordings	43
Scheduled a Recording	43
Scheduled Time Recordings	44
Setting Starting and Ending Times	44
Setting the Source	44
Setting the Recurrence	44
Setting the Quality Mode	44
Saving the Schedule	44
Editing a Saved Schedule	44
Suspending / Activating a Schedule	44
Deleting a Saved Schedule	44

Setup Menu

General	45
About the SETUP MENU	45
Using the SETUP MENU	45
Language	45
Rating	46
Clock	46
Disc	47
Version	48
DivX(R)	48
Restore	48
Other	48
A/V Output	48
Video	48
Picture	48
Audio	49
TV Channel	50
Schedule	50
Recording	51
Other	52
Help	52

Others

Before calling service personnel	53
Power	53
Connection to your TV	53
TV reception	53
Playback	53
Recording	54
Program	54
Remote control	53
Clock	54
Specification	55
Limited Warranty	56

SAFETY PRECAUTIONS

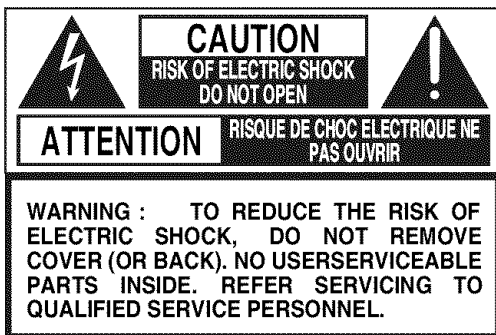

The lightning flash with arrowhead symbol, within an equilateral triangle, is intended to alert the user to the presence of uninsulated "dangerous voltage" within the product's enclosure that may be of sufficient magnitude to constitute a risk of electric shock to persons.



The exclamation point within an equilateral triangle is intended to alert the user to the presence of important operating and maintenance (servicing) instructions in the literature accompanying the appliance.



The symbol for CLASS II (Double Insulation)

WARNING: TO REDUCE THE RISK OF FIRE OR ELECTRIC SHOCK, DO NOT EXPOSE THIS APPLIANCE TO RAIN OR MOISTURE. DANGEROUS HIGH VOLTAGES ARE PRESENT INSIDE THE ENCLOSURE. DO NOT OPEN THE CABINET. REFER SERVICING TO QUALIFIED PERSONNEL ONLY.

CAUTION: TO PREVENT ELECTRIC SHOCK, MATCH WIDE BLADE OF PLUG TO WIDE SLOT, FULLY INSERT.

ATTENTION: POUR EVITER LES CHOCs ELECTRIQUES, INTRODUIRE LA LAME LA PLUS LARGE DE LA FICHE DANS LA BORNE CORRESPONDANTE DE LA PRISE ET POUSSER JUSQU'AU FOND.

CAUTION: This DVD video recorder employs a Laser System. To ensure proper use of this product, please read this owner's manual carefully and retain for future reference. Should the unit require maintenance, contact an authorized service location - see service procedure.

Use of controls or adjustments or performance of procedures other than those specified herein may result in hazardous radiation exposure.

To prevent direct exposure to laser beam, do not try to open the enclosure. Visible and invisible laser radiation when open and interlocks defeated. DO NOT STARE INTO BEAM.

FCC NOTICE: This equipment has been tested and found to comply with the limits for a Class B digital device, pursuant to part 15 of the FCC Rule. These limits are designed to provide reasonable protection against harmful interference in a residential installation.

This equipment generates, uses, and can radiate radio frequency energy and, if not installed and used in accordance with the instructions, may cause harmful interference to radio communications.

However, there is no guarantee that interference will not occur in a particular installation. If this equipment does cause harmful interference to radio or television reception, which can be determined by turning the equipment off and on, the user is encouraged to try to correct the interference by one or more of the following measures:

- Reorient or relocate the receiving antenna.
- Increase the separation between the equipment and receiver.
- Connect the equipment into an outlet on a circuit different from that to which the receiver is connected.
- Consult the dealer or an experienced radio/TV technician for help.

WARNING: Changes or modifications made to this equipment, not expressly approved by Toshiba, or parties authorized by Toshiba, could void the user's authority to operate the equipment.

SAFETY PRECAUTIONS (Continued)

Note to cable system installer:

This reminder is provided to call the cable system installer's attention to Article 820-40 of the NEC that provides guidelines for proper grounding and, in particular, specifies that the cable ground shall be connected to the grounding system of the building, as close to the point of cable entry as practical.

The instructions shall state that an ALL-POLE MAINS SWITCH with a contact separation of at least 3 mm in each pole shall be incorporated in the electrical installation of the building.

CAUTION: These servicing instructions are for use by qualified service personnel only. To reduce the risk of electric shock do not perform any servicing other than that contained in the operating instructions unless you are qualified to do so.

In the spaces provided below, record the Model and Serial No. located on the rear panel of your recorder.

Model No. _____

Serial No. _____

Retain this information for future reference.

Location of the required label

PRODUCT IS CERTIFIED BY THE MANUFACTURER TO COMPLY WITH DHHS RULE 21 CFR SUBCHAPTER J IN EFFECT AT DATE OF MANUFACTURE.

TOSHIBA CORPORATION
1-1, SHIBAURA 1-CHOME, MINATO-KU,
TOKYO 105-8001, JAPAN

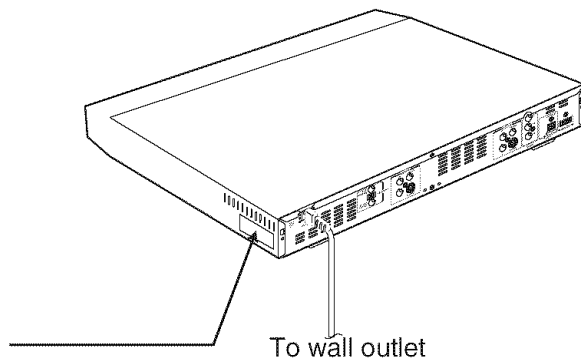

Be aware that this equipment is still powered even after the ON/STANDBY indicator turns off (standby mode) by pressing the ON/STANDBY button. To disconnect this equipment completely from the mains power, pull out the power plug from the wall outlet.

WARNING: HANDLING THE CORD ON THIS PRODUCT OR CORDS ASSOCIATED WITH ACCESSORIES SOLD WITH THIS PRODUCT, WILL EXPOSE YOU TO LEAD, A CHEMICAL KNOWN TO THE STATE OF CALIFORNIA TO CAUSE BIRTH DEFECTS OR OTHER REPRODUCTIVE HARM. WASH HANDS AFTER HANDLING.

IMPORTANT SAFETY INSTRUCTIONS

1. Read these instructions.
2. Keep these instructions.
3. Heed all warnings.
4. Follow all instructions.
5. Do not use this apparatus near water.
6. Clean only with dry cloth.
7. Do not block any ventilation openings. Install in accordance with the manufacturer's instructions.
8. Do not install near any heat sources such as radiators, heat registers, stoves, or other apparatus (including amplifiers) that produce heat.
9. Do not defeat the safety purpose of the polarized or grounding-type plug. A polarized plug has two blades with one wider than the other. A grounding type plug has two blades and a third grounding prong. The wide blade or the third prong are provided for your safety. If the provided plug does not fit into your outlet, consult an electrician for replacement of the obsolete outlet.
10. Protect the power cord from being walked on or pinched particularly at plugs, convenience receptacles, and the point where they exit from the apparatus.
11. Only use attachments/accessories specified by the manufacturer.
12. Use only with the cart, stand, tripod, bracket, or table specified by the manufacturer, or sold with the apparatus. When a cart is used, use caution when moving the cart/apparatus combination to avoid injury from tip-over.
13. Unplug this apparatus during lightning storms or when unused for long periods of time.
14. Refer all servicing to qualified service personnel. Servicing is required when the apparatus has been damaged in any way, such as power-supply cord or plug is damaged, liquid has been spilled or objects have fallen into the apparatus, the apparatus has been exposed to rain or moisture, does not operate normally, or has been dropped.



IMPORTANT SAFETY INSTRUCTIONS (Continued)

ADDITIONAL SAFETY INSTRUCTIONS

- 15. Do not overload wall outlets; extension cords, or integral convenience receptacles as this can result in a risk of fire or electric shock.
- 16. Apparatus should not be exposed to dripping or splashing and objects filled with liquids, such as vases, should not be placed on the apparatus.
- 17. Keep fingers well clear of the disc tray as it is closing. Neglecting to do so may cause serious personal injury.
- 18. Do not place anything on top of this apparatus.
- 19. Do not place the apparatus on amplifiers or equipment that may produce heat.
- 20. Do not cover the ventilating holes.
- 21. Do not use a cracked, deformed, or repaired disc. These discs are easily broken and may cause serious personal injury and apparatus malfunction.
- 22. If the apparatus should smoke or smell, immediately disconnect the power cord from the wall outlet. Wait until the smoke or smell stops, then ask your dealer for a check and repair. Neglecting to do so may cause fire.
- 23. During thunderstorms, do not touch the connecting cables or the apparatus.

Introduction

Connections

Quick Start Guide

Playback

Recording

Setup Menu

Others

Precautions

Notes on handling

- Never disconnect the power cord from a wall outlet while the recorder is turned on. Doing so may cause malfunction.
- When shipping the recorder, the original shipping carton and packing materials come in handy. For maximum protection, repack the unit as it was originally packed at the factory.
- Do not use volatile liquids, such as insect spray, near the recorder. Do not leave rubber or plastic products in contact with the recorder for a long time. They will leave marks on the finish.
- The top and rear panels of the recorder may become warm after a long period of use. This is not a malfunction.

When not in use

- For usual absence
When the recorder is not in use, be sure to remove any disc that may be in the recorder and turn the power off.
- Prolonged absence
When the recorder will not be used for a prolonged period of time, unplug the power cord from the wall outlet.

Notes on placement

- Place the recorder on a level surface. Do not use it on a shaky or unstable surface such as a wobbly table. Doing so may cause a loaded disc to dislodge from its proper position and cause damage to the recorder. Before deciding on a location for the recorder, make sure that the surface of the location can withstand the weight of the recorder. Never place the recorder in an elevated location as it may accidentally fall and cause injury or property damage.
- If you place the recorder near a TV, radio, or VCR, the playback picture of the recorder may degrade and the sound may distort depending on the condition and location of said equipment. In such event, it is recommended that you place the recorder as far away as possible from such other equipment.
- To avoid damage to the recorder, never place or store the recorder in direct sunlight; hot or humid areas; or areas subject to excessive dust, smoke (including cigarette smoke), or vibration.

Notes on cleaning

Use a soft, dry cloth for cleaning.

- Unplug the recorder before cleaning.
- Do not use any type of solvent, such as thinner or benzine, as they may damage the surface of the recorder.

Notes on antennas

- Image and sound quality depend very much on signal reception.
- Reception may be poor in weak signal areas. In this case, consult your dealer or purchase a commercially available antenna booster. Refer to the booster's instruction manual for installation details.

Notes on recording and editing

- When you record/edit important content, make trial operations beforehand to confirm the recorder can function properly.
- When the power cord is disconnected or when a power failure occurs during any operation of this product, all contents recorded on a disc may be erased. A DVD-R disc may become unavailable.
- Depending on the channel or program, an excessive sound input level may cause noise or cut of recorded sound. Adjust the initial setting of the recording level when necessary.
- If a program you have set a timer recording includes copy restriction signals, it may not be recorded. When programming a recording, confirm that a program you want to record is not copy-restricted.

Power Outage

- After a power outage the clock display will flash. Set the clock to the correct time.

Notes on the unit

- Do not give a shock or shake (especially during operation).
- Do not use in a place where the temperature rises or changes rapidly.

Precautions (Continued)

Notes on moisture condensation

Moisture condensation damages the unit. Please read the following carefully.

Moisture condensation occurs, for example, when you pour a cold drink into a glass on a warm day. Drops of water form on the outside of the glass. In the same way, moisture may condense on the optical pick-up lens inside this unit, one of the most crucial internal parts of the unit.

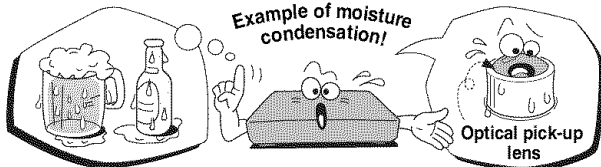

■ Moisture condensation occurs during the following cases.

- When you bring the unit directly from a cold place to a warm place.
- When you use the unit in a room where you just turned on the heater, or a place where the cold wind from the air conditioner directly hits the unit.
- In summer, when you use the unit in a hot and humid place just after you move the unit from an air conditioned room.
- When you use the unit in a humid place.

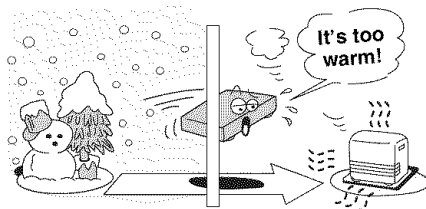

■ Do not use the unit when moisture condensation may occur.

If you use the unit in such a situation, it may damage discs and internal parts. Connect the power cord of the unit to the wall outlet, turn on the unit, remove the disc and leave it for two or three hours. After two or three hours, the unit will have warmed up and evaporated any moisture. Keep the unit connected to the wall outlet and moisture condensation will seldom occur.

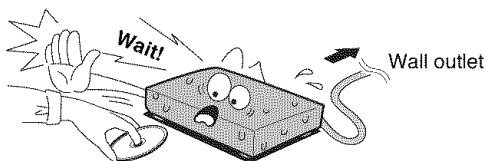

About This Product

Some differences

Because of its recording capacity, this DVD recorder operates more like a computer and differently than a standard DVD player. In addition to containing a microprocessor, it contains an operating system, random access memory (RAM), and a DVD-RAM/R/RW drive. The operating system includes software that is transferred to the RAM when the machine is turned on and at other times during operation. This transfer can take time. Therefore, when you turn the DVD recorder on, it may take a little while before it is ready to use. Likewise, other functions may not be performed as quickly as they would on other AV equipment. Additionally, accessing those programs (or deleting a program from a DVD-RAM or DVD-RW disc) may take more time. Please take these factors into consideration as you use the DVD recorder.

Playback Restrictions

This owner's manual explains the basic instructions for this recorder. Some DVD video discs are produced in a manner that allows specific or limited operation during playback. As such, the recorder may not respond to all operating commands. This is not a defect in the recorder. Please refer to the notes on compatible discs later in this Introduction and to the discussion of DVD playback and features later in this manual.

“Ⓢ” may appear on the TV screen during operation.
 “Ⓢ” means that the operation is not permitted by the recorder or the disc.

Recording Restrictions and Copyright

Copy-protected contents of DVD-Video discs, VIDEO CDs or audio CDs on the market cannot be copied on this recorder. Contents without copy protection should be copied or edited only in accordance with applicable copyright laws, which may restrict copying or editing. Contents that permit single copying (copy once contents) can be recorded onto DVD-RAM/RW discs, with some dubbing and editing restrictions. DVD-R discs cannot record these contents.

The unauthorized recording, use, distribution, or revision of copyrighted materials including, without limitation, television programs, videotapes, and DVDs, is prohibited under the Copyright Laws of the United States and other countries, and may subject you to civil and criminal liability.

Compatibility

In isolated cases, a disc bearing the DVD or CD logo may not fully and properly playback all features or as intended by the creator of the disc. This can be due, among other reasons, to problems and errors that can occur during the creation or recording of DVD and other software and the manufacture of software discs (including blank discs). Moreover, because of variations in the quality of discs, this recorder may not be able to record on all discs that bear a DVD-RAM, DVD-R or DVD-RW logo, but you should not encounter difficulty if you use only high quality recordable DVD discs. Additionally, discs recorded in this device may not operate properly in other DVD players, recorders and/or personal computer drives. If you happen to encounter difficulties playing or recording a DVD disc or playing a CD disc, please feel free to call our Customer Service Hotline at 1-800-319-6684.

Choosing a disc







There are many types and formats of discs. Please use the following information to select an appropriate disc.

DVD is a trademark of DVD Format / logo Licensing Corporation.

Notes

- Handle the disc according to the disc instruction manual.
- Toshiba cannot guarantee that all discs bearing the DVD or CD logos will operate as expected. Additionally, Toshiba cannot guarantee that discs recorded in this device will operate properly in other DVD players.

For recording / playback

Disc	Mark	Specification	Remarks
DVD-RAM		<ul style="list-style-type: none"> • Single sided 4.7GB (12cm (4³/₄ in.)) • Double sided 9.4GB (12cm (4³/₄ in.)) Version 2.0/2.1/2.2	Read carefully the section "On DVD-RAM discs" ( page 13). Select a DVD-RAM disc that shows a statement on its package such as "this disc can be used with video recorders and drives compatible with 4.7GB DVD-RAM discs" or "this disc can copy images that permit single copying."
DVD-R		<ul style="list-style-type: none"> • 4.7GB For General Ver.2.0/2.1 (12cm (4³/₄ in.)) 	Read carefully the section "On DVD-R discs" ( page 14). Depending on the disc status or the recording equipment, playback of the disc may not be possible on this recorder.
DVD-RW		<ul style="list-style-type: none"> • 4.7GB Ver.1.1 (12cm(4³/₄ in.)) 	Read carefully the section "On DVD-RW discs" ( page 14). Depending on the disc status or the recording equipment, playback of the disc may not be possible on this recorder.

Using different disc types for different purposes

DVD-RAM discs for your personal library

DVD-RAM discs comply with the global standard DVD-VR (Video Recording) format, and are optimized for recording of TV programs. You can rewrite repeatedly without deterioration of an image quality, erase unnecessary parts, divide a chapter, or specify playback area by frame. Its cartridge is suitable for a longer-term storage and family use, and its large capacity of 9.4 GB allows more recording space.

DVD-R discs when creating your own original discs for distribution











DVD-R discs are designed to comply with the global standard DVD-Video format, and can be recorded only once. DVD-R discs are convenient when you edit your original content (recorded personal events such as a wedding party) with this recorder, transfer them to the recorder and make copies to send to your friends or relatives. The discs can be played on other compatible DVD players. DVD-RW discs, which are rewriteable, can be used as well.

* DVD-R may not be the best suited format for recording TV programs. Because of the way the discs are formatted, it may not be possible to edit or divide the program as you may prefer, to record secondary languages, or programs that are copy protected in a way that allows only one copy. (NOTE: "Copy once" protected programs generally can be recorded to DVD-RAM/RW discs.)

We cannot guarantee that DVD-RAM/R/RW discs recorded on this recorder will be playable on all DVD recorders/players. Similarly, there is no guarantee that all DVD-RAM/R/RW discs recorded on other recorders will be playable on this recorder.

Choosing a disc (Continued)

For playback only

Disc	Mark	Specification	Remarks
DVD video disc	 	<ul style="list-style-type: none"> • 12cm (4³/₄ in.) • Region number  or  • Color system: NTSC 	The region number of this DVD recorder is 1. The region number marked on the rear panel must correspond to a specific playable area, that is printed on your DVD video disc. If you do not find  or  , or the disc is encoded to permit playback only in regions other than Region 1, disc playback will not be allowed by the recorder.
VIDEO CD		<ul style="list-style-type: none"> • 12cm (4³/₄ in.) • Color system: NTSC • Version 1.1 and 2.0 	
Audio CD		<ul style="list-style-type: none"> • 12cm (4³/₄ in.) 	
CD-R		<ul style="list-style-type: none"> • 12cm (4³/₄ in.) • CD-DA (audio CD) format 	Depending on the disc status, playback may not be possible.
CD-RW			

- You cannot play discs other than those listed above.
- You cannot play non-standardized discs even if they may be labeled as above.
- You cannot play discs with specialized encoding (such as SACD discs) or the DVD audio portions of DVD Audio discs.
- This recorder uses the NTSC color system. Toshiba can not guarantee to play DVD video discs recorded in any other color system (PAL, SECAM, etc.).
- Toshiba cannot guarantee that all discs bearing the DVD or CD logos will operate as expected. Please see the discussion of compatibility on page 11.

- Toshiba is not liable for any damage or loss caused directly or indirectly by the malfunction of this recorder, including, without limitation, any one of the following:
 - Failure to record contents intended to be recorded by the consumer.
 - Failure to edit contents as intended by the consumer.
 - When a DVD-RAM/R/RW disc created on this recorder is used (e.g., insertion, playback, recording or editing) in another DVD player, recorder or personal computer drive.
 - When a DVD-RAM/R/RW disc that is used in the manner described in the immediately preceding bullet point is used again in this recorder.
 - When a DVD-RAM/R/RW disc that was recorded in another DVD recorder, or in a personal computer drive is used in this recorder.
- Discs recorded in this recorder may not operate as expected on other DVD players, recorders or personal computer drives.

Choosing a disc (Continued)

On DVD-RAM discs

■ Use only DVD-RAM discs that comply with DVD-RAM standard Version 2.0, 2.1 or 2.2.

The recorder cannot record on a disc formatted in any other standard. When using such a disc, initialize it by using the disc-format function of this recorder.

- The recorder may not record, dub, or edit some DVD-RAM discs, because they are edited/recorded with another manufacturer's equipment or PC, contain a large number of titles, or have little remaining capacity. Also, a DVD-RAM disc may not be edited or recorded if its title contains still pictures.
- DVD-RAM discs formatted in UDF2.0 on a PC are not compatible with this recorder. Before using these discs, initialize them on this recorder.
- This recorder complies with current copyright protection technology and can copy a disc only when the disc permits copying once. When there is no indication on the disc, copying will not be allowed.

■ DVD-RAM discs with cartridges are recommended for recording.

- Two types of DVD-RAM discs are available: ones with cartridges and ones without cartridges. You can use either of them with this recorder, but the former ones are recommended.

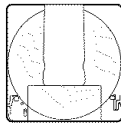

- In order to record highly detailed data, make sure the disc is clean. DVD-RAM discs with cartridges are easier to handle in this regard.
- Do not open the cartridge shutter. The disc may not play, or may not be recorded or edited once it becomes dirty.
- There are two types of DVD-RAM cartridges; removable (TYPE 2/4) and not removable (TYPE 1). It is recommended you not to remove the disc even when you can. Refer to the instruction manual that comes with the disc if it is absolutely necessary to remove the disc.
- Some commercially available cartridge discs cannot be recorded or edited once the inside discs are removed.

- To protect recorded contents Slide the write-protect tab to "PROTECT" with something small enough. The disc can play, but cannot be edited or erased. Refer to the instructions that come with the disc.

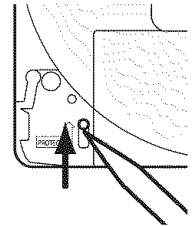

■ When using a disc without a cartridge (commercially available discs)

- Discs without cartridges can easily attract fingerprints and dust, which is the reason they are not recommended. If you cannot avoid using them, handle with proper care.
- When you write in a title column on a disc, use a pen with a soft tip. Do not use a pen with a hard tip, such as a ballpoint pen.

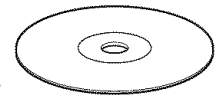

Recommended discs

The following discs have been tested with this recorder:
 9.4 GB double-sided cartridge: Panasonic 2X, 3X, 5X
 4.7 GB single-sided cartridge: Panasonic 2X, 3X, 5X

Choosing a disc (Continued)

On DVD-R discs

■ Standards

- DVD-R for General Ver.2.0 discs can be used for recording and playback.
- Discs compatible with 2X speed recording (labeled Ver.2.1/2X etc.) and discs compatible with 4X speed recording (labeled Ver.2.1/4X etc.) can also be used.
- Select discs labeled “for video”, “for recording”, “120 min.” etc.
- DVD-R for authoring Ver.1.1 cannot be used.

■ Recording conditions

- Images for which copying is prohibited or restricted (copy once or copy prohibited) cannot be recorded. Even if the disc is labeled as CPRM compatible, this recorder can only be used to record copy-free material.
- DVD-VR mode recording is impossible.

■ Recommended disc

That's (Taiyo-Yuden) 4X, 8X
Maxell 4X, 8X

■ Tested discs

Panasonic 4X

On DVD-RW discs

■ Standards

- Discs labeled DVD-RW Ver.1.1 or 1.2 can be used.
- Discs compatible with 2X speed recording (labeled Ver.1.1/2X etc.) can also be used.
- Select discs labeled “for video”, “for recording”, “120 min.” etc.

■ Recording conditions

- Images for which copying is prohibited or restricted (copy prohibited) cannot be recorded.







■ Recommended discs*

JVC 2X, 4X

* Operation has been confirmed with recommended discs and tested disc, but some other discs may not be usable.

Marks on DVD video discs

The following are examples of marks and the meanings.

Mark	Meanings
	Number of audio streams recorded in the disc. (2 streams such as English and Japanese in this example.)
	Number of subtitle languages recorded in the disc. (2 subtitle languages are recorded in this example.)
	Number of camera angles recorded in the disc. (3 camera angles are recorded in this example.)
	Pictures are recorded in the standard picture shape (4:3 aspect ratio).
	Pictures are recorded in the letter box picture shape (4:3 aspect ratio with horizontal black bars in the top and bottom of pictures).
	Pictures are recorded in the 16:9 wide picture shape. TVs with 4:3 aspect ratio will display them in the letter box style.
	Pictures are recorded in the 16:9 wide picture shape. TVs with 4:3 aspect ratio will display them in the pan scan style (one or both sides of pictures are cut).
	Actual picture shape may vary depending on the aspect ratio or mode selection of the TV.

Choosing a disc (Continued)

Structure of disc contents

Normally, DVD video discs are divided into titles, and the titles are subdivided into chapters. VIDEO CDs/audio CDs are divided into tracks.



- Title :** Divided contents of a DVD video disc. Roughly corresponds to a story title in short stories.
- Chapter:** Divided contents of a title. This corresponds to a chapter in a story.
- Track :** Divided contents of a VIDEO CD or an audio CD.

Each title, chapter, or track is assigned a number, which is called "title number", "chapter number", or "track number" respectively. Some discs may not have these numbers.

When you record on a DVD-RAM/R/RW disc, one recording will always equal one title.

On handling discs

- Do not touch the playback side of the disc.

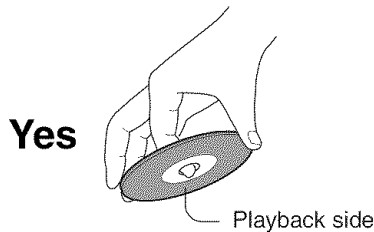

- Do not stick paper or tape to discs.



On cleaning discs

- Fingerprints and dust on the disc cause picture and sound deterioration. Wipe the disc from the center outwards with a soft cloth. Always keep the disc clean.

Yes



No

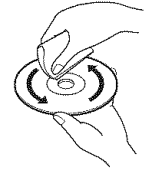

- Do not use any type of solvent such as thinner, benzene, commercially available cleaners or antistatic spray for vinyl LPs. It may damage the disc.

On storing discs

- Do not store discs in a place subject to direct sunlight or near heat sources.
- Do not store discs in places subject to moisture and dust such as a bathroom or near a humidifier.
- Store discs vertically in a case. Stacking or placing objects on discs outside of their case may cause warping.

Program	Recording	Disc Type
 Copy free	Can be recorded	DVD-RAM DVD-RW DVD-R
 Recording once permitted	Can be recorded	DVD-RAM DVD-RW
 Recording once permitted	Cannot be recorded	DVD-R
 Recording prohibited	Cannot be recorded	DVD-RAM DVD-RW DVD-R

Choose a disc (Continued)

Discs and purposes

The table shows main functions which are available on this recorder per disc category. This will help you choose discs.

	DVD-RAM disc	DVD-RW disc	DVD-R disc
Characteristics on this recorder	Suitable for repeat use of the disc, and data storage for video library. Copy once contents can be recorded using a compatible disc.	Suitable for saving data in both DVD-Video and VR format to play on compatible devices. You can erase recorded contents to use the disc repeatedly.	Suitable for saving data in DVD-Video format to play on compatible devices. Once you execute DVD-Video finalizing process on a recorded disc so that it can be played on other players, you cannot make addition, correction and deletion of contents on the disc.
For the first use	No preparatory steps required, however initializing is recommended.	Initialize the disc.	No preparatory steps required.
Recording a TV program	Yes	Yes	Yes
Erasing recorded contents	Yes	Yes If the disc has been executed DVD-Video/ DVD-VR finalizing process, first cancel the process then delete contents.	Yes Deleting contents cannot restore the disc space. <u>After you execute DVD-Video finalizing process on a recorded disc, you cannot delete contents of the disc.</u>
Recording additional content on a recorded disc	Yes	Yes If the disc has been executed DVD-Video/ DVD-VR finalizing process, first cancel the process then delete contents.	No <u>After you execute DVD-Video finalizing process on a recorded disc, you cannot add contents to the disc.</u>
Playing contents recorded on this recorder, on other devices	Contents can be played on any devices compatible with DVD-RAM discs. Follow the instruction of the device to play.	Execute DVD-Video/DVD-VR finalizing process on this recorder. This process makes the disc playable on other compatible devices. (Some models excepted.)	Execute DVD-Video finalizing process on this recorder. This process makes the disc playable on other compatible devices. (Some models excepted.)
When a message appears and the loaded disc cannot be used:	Initialize the disc. If it is still unusable, try to execute DVD-RAM physical Format.	Initialize the disc.	—

Index to parts and controls

Remote control

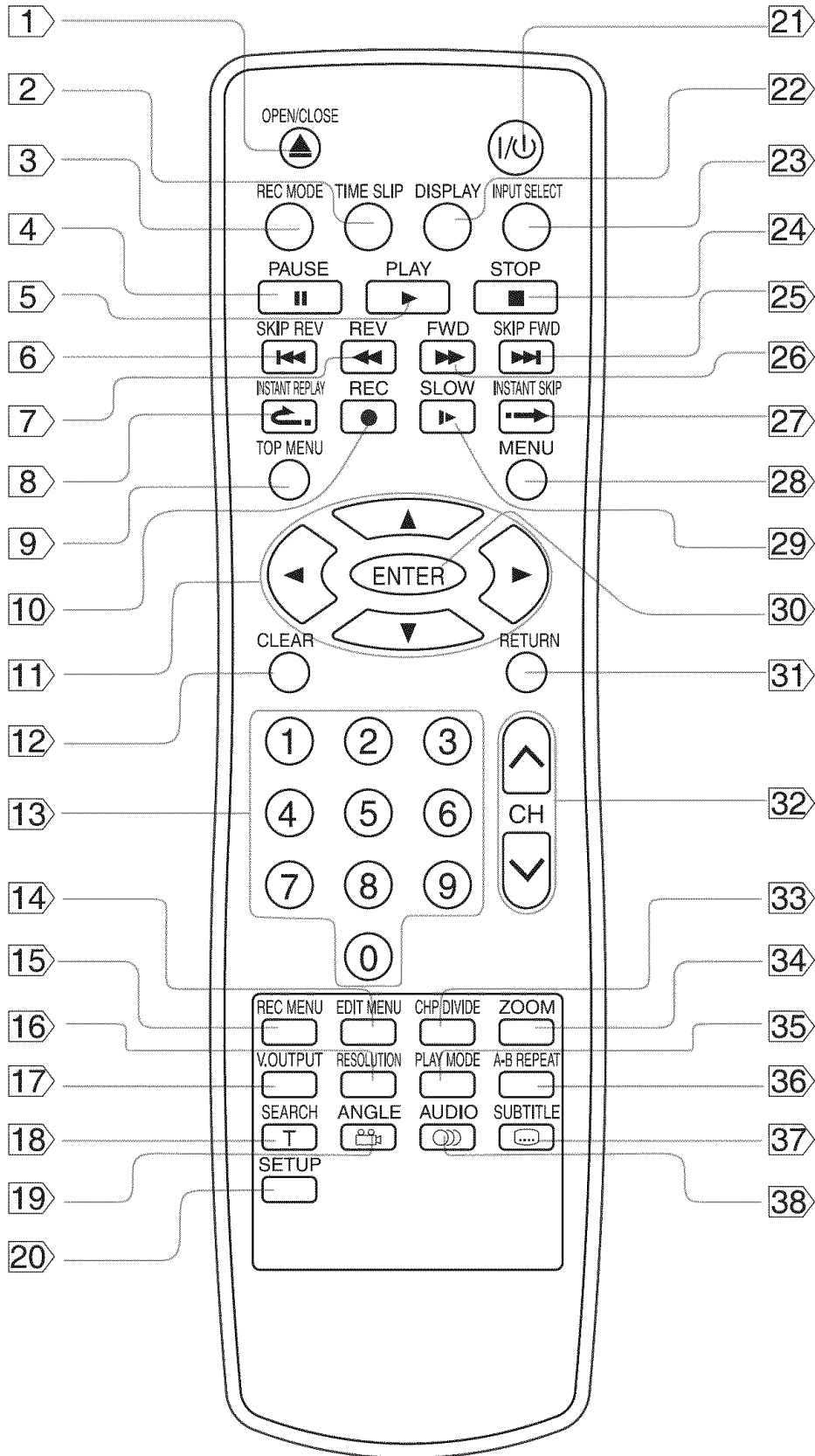

Index to parts and controls (Continued)

- 1 **OPEN/CLOSE button**
Press to OPEN/CLOSE the disc tray.
- 2 **TIMESLIP button**
Press to Start chase playback. During DVD-RAM recording, the TIMESLIP key accepts only after 30 seconds from the start of recording. TIMESLIP function is not available when recording a DVD-RW/R disc and a DVD-RAM in XP mode.
- 3 **REC MODE button**
Use to REC MODE to select the recording quality.
- 4 **PAUSE button**
Press Pause to freeze playback and recording.
- 5 **PLAY button**
Press to Start playback.
- 6 **SKIP REV button**
Play SKIP REV chapter/track on DVD and other disc.
- 7 **REV button**
Scan in fast reverse on DVD and other discs.
- 8 **INSTANT REPLAY button**
The time return to a point 10 seconds before and playback resumes.
- 9 **TOP MENU button**
Display the title menu on DVD Disc.
- 10 **REC button**
Press to begin a recording or resume recording from PAUSE.
- 11 **Direction buttons**
Use UP/DOWN/RIGHT/LEFT to select a function in the setup menu.
- 12 **CLEAR button**
Use CLEAR to delete the scheduled program, Cancels input data in the setting mode.
- 13 **Number buttons**
Use to enter numeric values in setting options.
- 14 **EDIT MENU button**
Press to Display Edit menu.
- 15 **REC MENU button**
Press to Display the Schedule menu.
- 16 **RESOLUTION button**
Press to change the resolution (HDMI).
- 17 **V.OUTPUT button**
Press to Select video output Analog/Digital(HDMI) and Interlace/Progressive.
- 18 **T.SEARCH button**
Press to Select Title search / Chapter or Track search / Time search.
- 19 **ANGLE button**
Select between multiple angles on DVD Disc that support this feature.
- 20 **SETUP button**
Access the on-screen Setup menu for settings adjustment.
- 21 **POWER button**
Turn the unit on or set the unit to Standby mode.
- 22 **DISPLAY button**
Bring up the on-screen display showing information for the playback/recording session.
- 23 **INPUT SELECT button**
For changing input source, DVD/DV/Video In1 /S-Video1/Video In2/S-Video2/Tuner.
- 24 **STOP button**
Press once to stop playback and hold the last position in memory. Playback can be resumed where it was left off by pressing PLAY. Press twice to clear the last playback position.
- 25 **SKIP FWD button**
Advanced to the next chapter/track on DVD and other disc.
- 26 **FWD button**
Scan in fast forward on DVD and other discs.
- 27 **INSTANT SKIP button**
The time jump to a point 30 seconds forward and playback resumes.
- 28 **MENU button**
Display the menu of DVD disc or change the status of PBC functionality for VCD equipped with the PBC (Version 2.0) function, (PBC is the abbreviation of playback control).
- 29 **SLOW button**
Slow motion playback mode. Press PLAY to resume normal playback.
- 30 **ENTER button**
Selects options in menus. Plays a disc, chapter or track with some discs. For other discs, press PLAY.
- 31 **RETURN buttons**
When navigating disc menus, press to return to the previous menu accessed.
- 32 **CHANNEL buttons**
Use to navigate disc menus, on-screen setup menu, etc. In TV tuner mode, use UP/DOWN to select a channel .
- 33 **CHP DIVIDE button**
Insert chapter mark during recording.
- 34 **ZOOM button**
Press to magnify the screen with DVD/Video CD and JPEG discs.
- 35 **PLAY MODE button**
Display the playback mode menu.
- 36 **A-B REPEAT button**
Set the beginning and end points of a section to repeat.
- 37 **SUBTITLE button**
Select available subtitles on DVD discs.
- 38 **AUDIO button**
Select an audio track on DVD or VCD discs.

Index to parts and controls (Continued)

Preparation of the remote control

1 Open the cover.

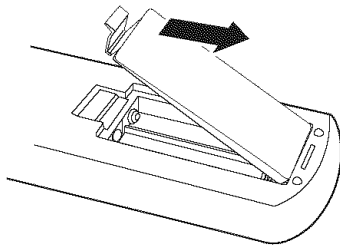

2 Insert batteries (AA size).

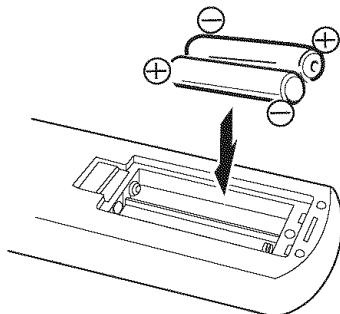

Make sure to match the + and – on the batteries to the marks inside the battery compartment.

3 Close the cover.

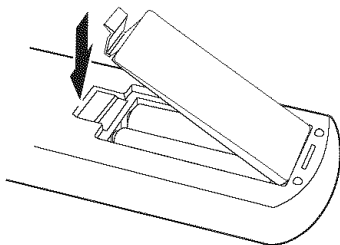

Caution

- Never throw batteries into a fire.

Notes

- Be sure to use AA size batteries.
- Dispose of batteries in a designated disposal area.
- Batteries should always be disposed of with the environment in mind. Always dispose of batteries in accordance with applicable laws and regulations.
- If the remote control does not operate correctly, or if the operating range becomes reduced, replace batteries with new ones.
- When necessary to replace batteries in the remote control, always replace both batteries with new ones. Never mix battery types or use new and used batteries in combination.
- Always remove batteries from remote control if they are dead or if the remote control is not to be used for an extended period of time. This will prevent battery acid from leaking into the battery compartment.

■ Operating with the remote control

Point the remote control at the remote sensor and press the buttons to operate.

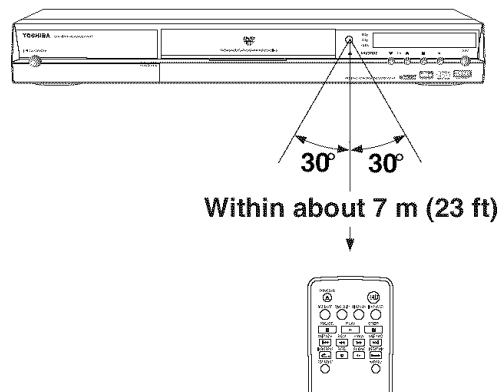

Distance : About 7 m (23 ft) from the front of the remote sensor

Angle : About 30° in each direction of the front of the remote sensor

- * Do not expose the remote sensor of the recorder to a strong light source such as direct sunlight or other illumination. If you do so, you may not be able to operate the recorder via the remote control.

Notes

- Do not drop or give the remote control a shock.
- Do not leave the remote control near an extremely hot or humid place.
- Do not spill water or put anything wet on the remote control.
- Do not disassemble the remote control.

Index to parts and controls (Continued)

Display



1. Multi display

Displays the current channel or other numbers such as, track number, input selection, the current time, elapsed time, etc.

For example,

8:15 P (8:15 PM)
 4:20 (4:20 AM)
 C 125 CH (cable TV 125 ch)

etc.

2. HDMI indicator page 31

The current resolution of the HDMI output lights up. When HDMI indicator lights up, the Video signals from COMPONENT OUTPUT jacks are progressive and from VIDEO OUTPUT jack are nothing.

Index to parts and controls (Continued)

See pages with arrows for details.

Front panel

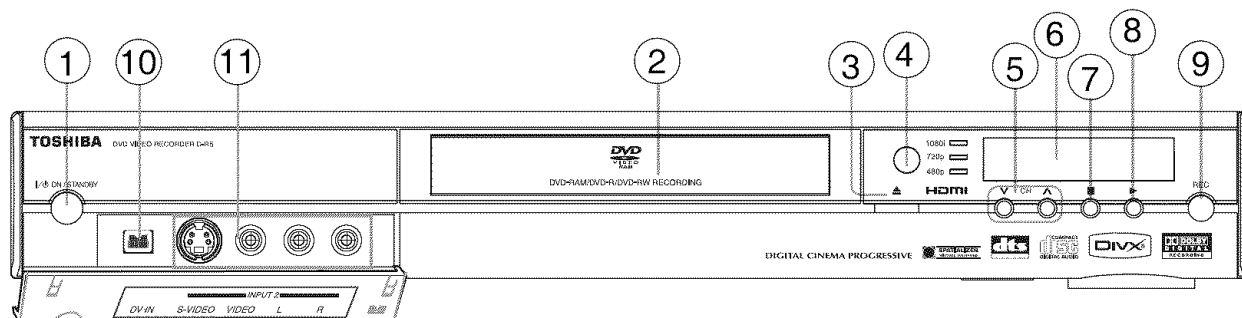

1. **ON/STANDBY button (with green LED)**
Turns the power on/restores the unit in the standby mode.
2. **Disc tray**
Loads a disc onto the disc drive.
3. **▲ (OPEN/CLOSE) button**
Opens and closes the disc tray.
4. **Remote sensor**
Point the remote control at the position.
5. **CH buttons**
Selects the channel.
6. **Front panel display**
The front Vacuum Fluorescent Display shows information about the unit's operation, such as current chapter, elapsed time during playback, etc.
7. **■ (STOP) button**
Stops playback or recording.
8. **▶ (PLAY) button**
Starts playback.
9. **REC button (with red LED)**
Starts recording.
10. **DV IN connector**
DV Input for recording. Use the **INPUT SELECT** key to select DV IN.
11. **INPUT 2 jacks**
Use this when recording from other input source such as a VCR or a camcorder.

■ To open or close the cover on the front panel

Put your finger on the left edge of the cover and pull it down to open.

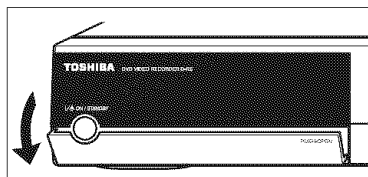

Note

- Do not place a heavy object on the cover while it is open. Doing so may damage the recorder.

Index to parts and controls (Continued)

Rear panel

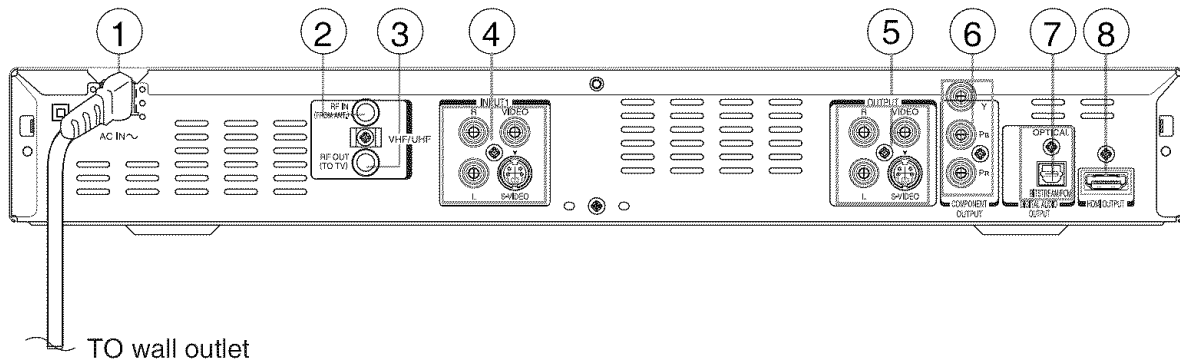

1. **Power cord socket**
Connects the Power cord to a wall outlet.
2. **VHF/UHF RF IN (FROM ANT.) input socket**
Connects to an antenna or cable signal.
3. **VHF/UHF RF OUT (TO TV) output socket**
Connects the supplied coaxial cable to a TV.
4. **INPUT1 jacks**
Use this to connect the recorder to output jacks of external devices such as another player or camcorder.
5. **OUTPUT jacks**
Outputs video and audio signals to a connected TV or amplifier.
6. **COMPONENT OUTPUT jacks**
Outputs video signals to a connected TV or monitor.
Connects to a TV or monitor equipped with component video jacks.
7. **DIGITAL AUDIO OUT BITSTREAM/PCM OPTICAL jack**
Use this to connect the recorder to an audio receiver equipped with an optical digital audio input jack.
8. **HDMI OUTPUT jack**
Use this to connect your TV's input signal.

Index to parts and controls (Continued)

Before operating this recorder

■ Is your recorder ready?

- Refer to "QUICK SETUP GUIDE" and finish the necessary preparations.
- Turn on the connected equipment such as a TV or audio system and select the input source from the recorder.

■ Turning the power on

(This owner's manual instructions are based on the premise that all proper connections have been completed and the TV is turned on.)

Press **ON/STANDBY** on the front panel of the recorder or **POWER** on the remote control.

ON/STANDBY button

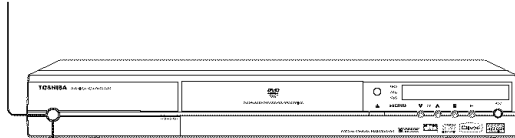

LED

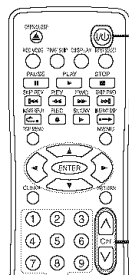

POWER button

CH button

When the power turns on, the LED on the front panel lights up.

After a few seconds, a start-up screen appears.

The following icon appears at the top right corner of the screen.

e.g.



When this icon disappears, the recorder is ready to operate. If the disc tray contains a disc, it takes a longer time to start up.

■ Viewing TV channels through this recorder

After turning the power on, press **INPUT SELECT** and use the **◀/▶** key to select Tuner mode and then press **ENTER** key.

You can select a desired channel by pressing the **CH** button or the number buttons.

■ Loading a disc

Check disc compatibility beforehand (▶ page 11 and 12) and use a proper playable disc.

Caution

- Keep your fingers well clear of the disc tray. Neglecting this may cause serious personal injury. Keep a close watch on children.
- Do not use a cracked, deformed or repaired disc.

1 Open the disc tray.

Press **▲** on the front panel or **OPEN/CLOSE** on the remote control.



▲ button

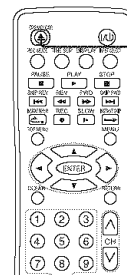

OPEN/CLOSE button

2 Insert a disc.

Disc without a cartridge

Insert with the playback side down.

There are two kinds of disc size. Place a disc to fit the guide. If a disc is out of the guide, it may result in damage to the disc or malfunction.

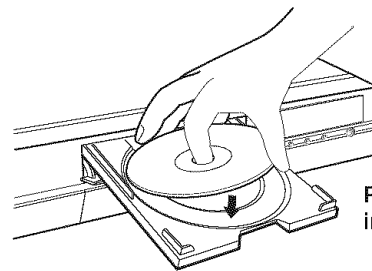

Place a disc in the inside hollow.

Index to parts and controls (Continued)

DVD-RAM disc with cartridge (TYPE1/TYPE2/
TYPE4)

Single sided

Turn the printed side up, and insert the cartridge into the tray frame following the direction of the arrow on the cartridge.

Double sided

Turn the desired recording/playback side up, and insert the cartridge into the tray frame following the direction of the arrow on the cartridge.

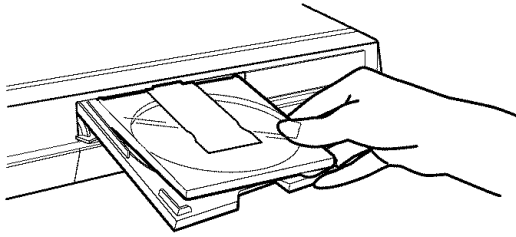

3 Close the disc tray.

Press **▲** on the front panel or **OPEN/CLOSE** on the remote control.

Notes

- Use the button on the front panel or the remote control to open and close the disc tray. Do not push or hold the disc tray while it is moving. Doing so may cause the recorder to malfunction.
- Do not insert a disc which is unplayable or any object other than a playable disc.
- Do not apply downforce to the disc tray. Doing so may cause the recorder to malfunction.
- If the disc tray stops while closing, the mechanical protection system of this recorder will open it. Do not force it to close. Doing so may cause malfunction.
- If the disc tray cannot open, turn the recorder off and press the **▲** button on the front panel or the **OPEN/CLOSE** button on the remote control. This may turn the recorder on and open the disc tray. If it still won't open, contact your nearest TOSHIBA dealer.
- The recorder may take several dozens of seconds to open the disc tray, if a loaded disc contain a large number of titles or chapters.

■ Turning the power off

Press **ON/STANDBY** on the front panel of the recorder or **I/⏻** on the remote control.

The LED turns off if it is lighted and the power turns off (Standby mode.)

Caution

- If the power fails or the power cord is disconnected from a wall outlet while the recorder is in operation (LED lit when the front panel display is not dimmed), the loaded disc may become recording disabled. In such a case, executing an initialization of the disc using the formatting function of the recorder may refresh it. However, all contents stored on the disc will be completely erased by this initialization process.
- This recorder may indicate alert messages with some DVD-RAM discs right after insertion. If such a disc is used for playback or recording on other equipment, all data in the disc may be damaged and the disc will not be played. By executing an initialization of the disc using the formatting function of the recorder, the disc will become operational.
- If the recorder freezes and does not respond at all, leave it alone for about 15 minutes or longer. This may restore the recorder. After the recorder has recovered, turn it off once and turn it on again to use as usual.

Note

- If there are any performance malfunctions of the disc drive, immediately discontinue use of this recorder, and disconnect the power cord from a wall outlet, then contact your dealer. Continuous use of the recorder in such a condition will aggravate the condition and result in increased cost and repair time.

■ Disc tray lock (Child lock)

You can lock the disc tray.

Press and hold **■** (STOP) on the front panel for longer than about 3 seconds.

To unlock, during stop press the button for longer than about 3 seconds.

Note

- Turning the power off also unlocks the disc tray.

Connecting an antenna and TV

Connect your TV and the antenna to this recorder for recording and to view broadcast programs on the TV.

- 1** Disconnect the antenna cable from your TV and connect it to the RF IN (FROM ANT.) terminal on the recorder.
- 2** Using the supplied RF cable of this recorder to connect the RF OUT (TO TV) terminal to the TV.

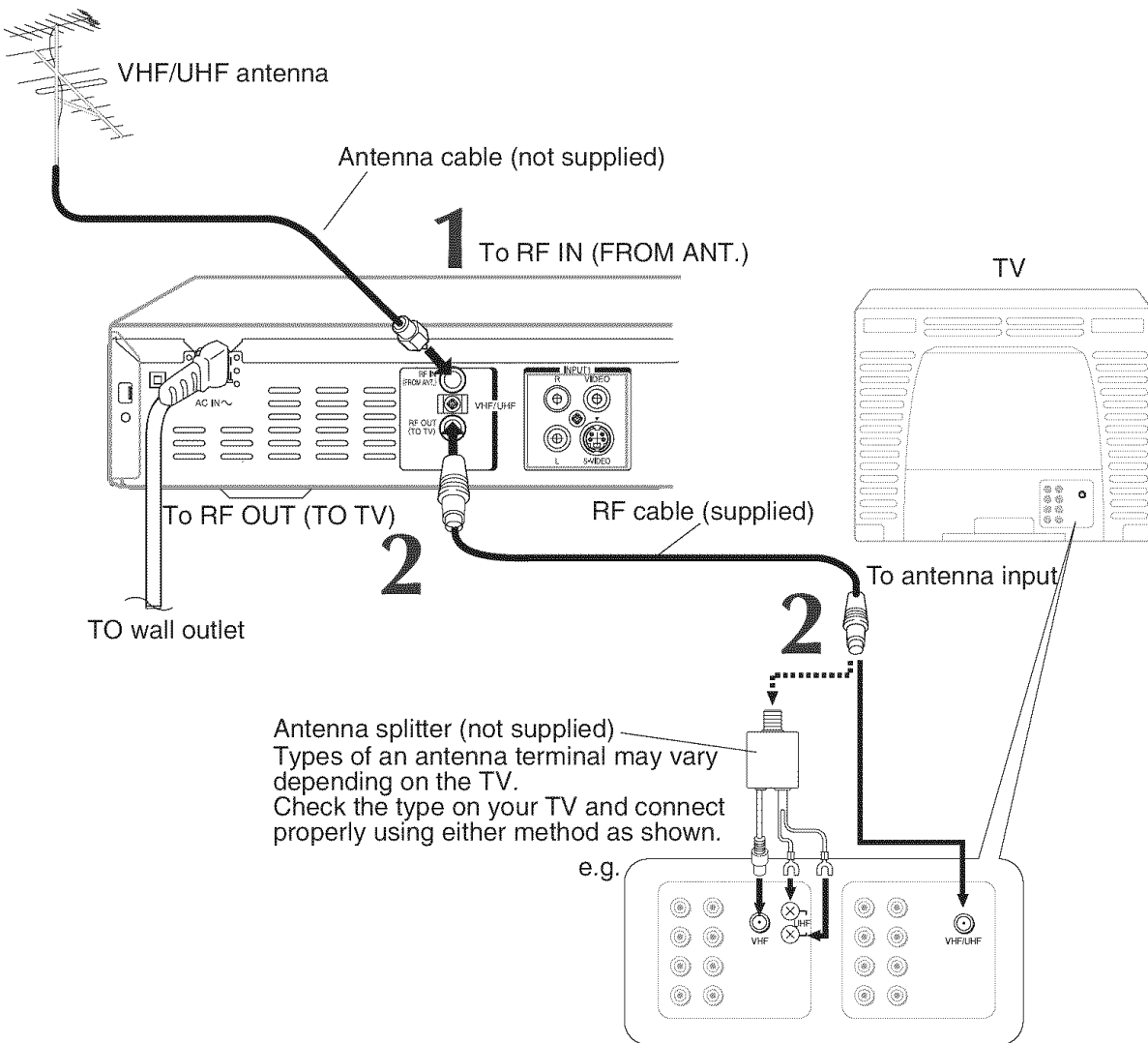

For connecting to a cable box or a satellite system, see pages 27 to 29.

Note

- This connection insures accessibility of broadcast signals to your TV only. Unlike a VCR, you cannot assign channel 3 or 4 for playback of this recorder, because an antenna input only passes through in the recorder. You must connect this recorder to a video input of your TV to enjoy playback picture from this recorder. (See next page.)

Connecting an antenna and TV (Continued)

3 Connect to a TV equipped with audio/video inputs.

Connect as below for watching received channels or recorded contents. Watching via the RF OUT terminal is not available.

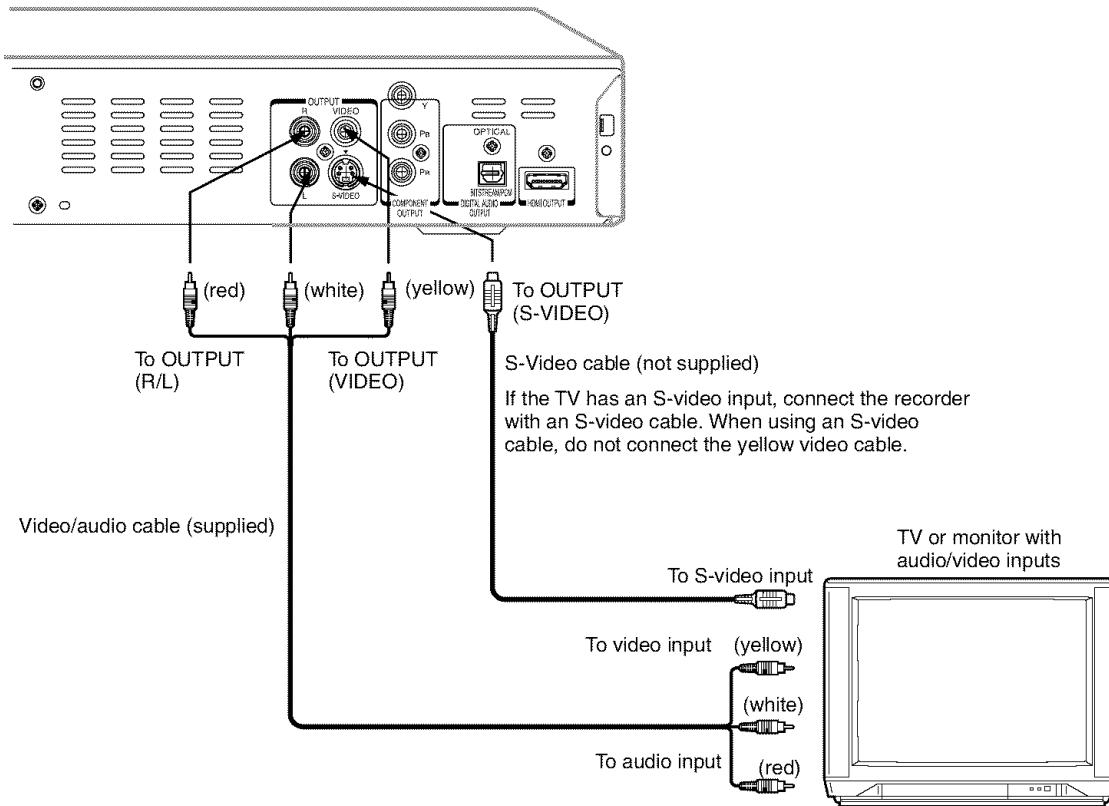

4 Connect the power cord of the recorder to a wall outlet.

Make sure that the powered recorder lights the Multi display on the front panel.

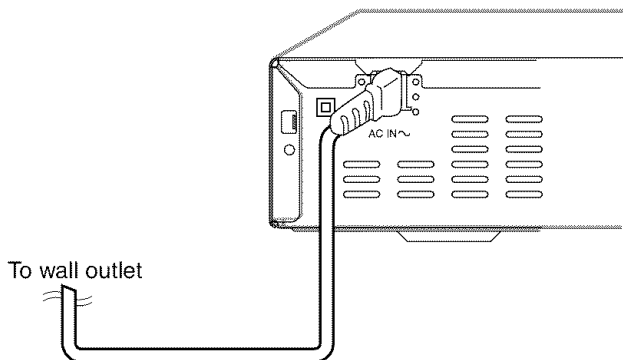

Notes

- Refer to the owner's manual of the connected TV as well.
- When you connect the recorder to your TV, make sure to turn off the power and unplug both units from the wall outlet before any connections.
- If your television set has one audio input, connect the left and right audio outputs of the recorder to a Y cable adapter (not supplied) and then connect to your TV.
- If you connect the recorder to a VCR with TV/VCR combination, video selector or AV amplifier, the playback picture may be distorted due to copy protection.

Connecting to cable TV signal

Choose one of the below according to your usage of the cable box.
For watching received channels, connect to the TV via the audio/video cable.

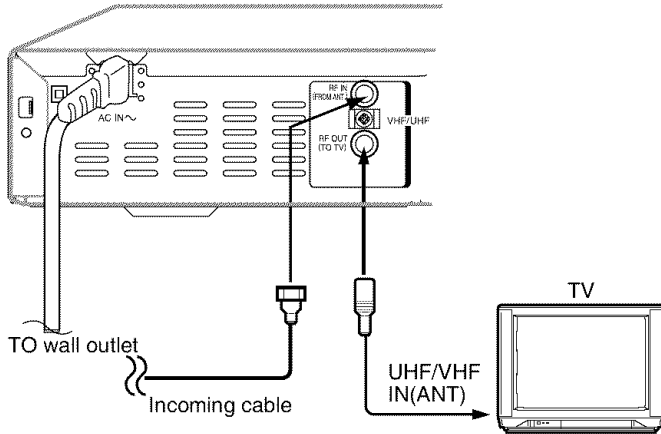

This set-up will allow you to:

- record an unscrambled channel.
- record an unscrambled channel while watching another (only when you connect a cable-compatible TV).

You will need to:

- record a channel while watching another, select a desired channel on the TV (only when you connect a cable-compatible TV).

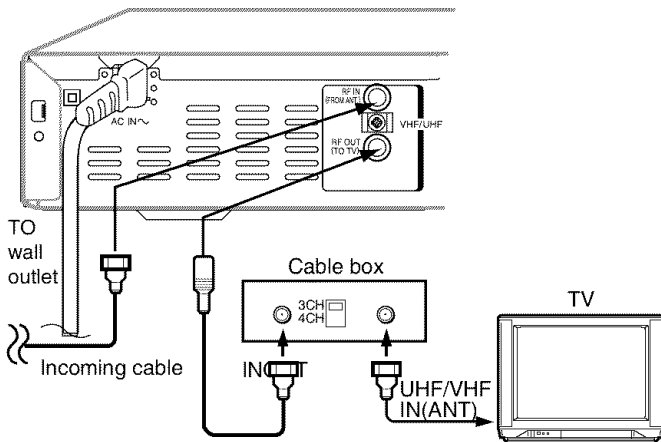

This set-up will allow you to:

- record an unscrambled channel.
- record an unscrambled channel while watching another (scrambled or unscrambled).

You will need to:

- set TV channel to the output channel of the cable box.
- record an unscrambled channel while watching a scrambled channel, select a desired cable channel via the cable box.

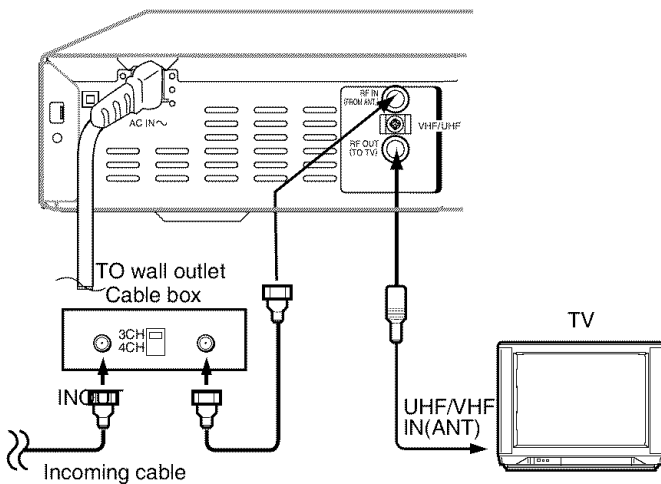

This set-up will allow you to:

- record any channels through the cable box.

You will need to:

- select a desired cable channel via the cable box.
- while the recorder is turned off, set TV channel to the output channel of the cable box.

Connecting to cable TV signal (Continued)

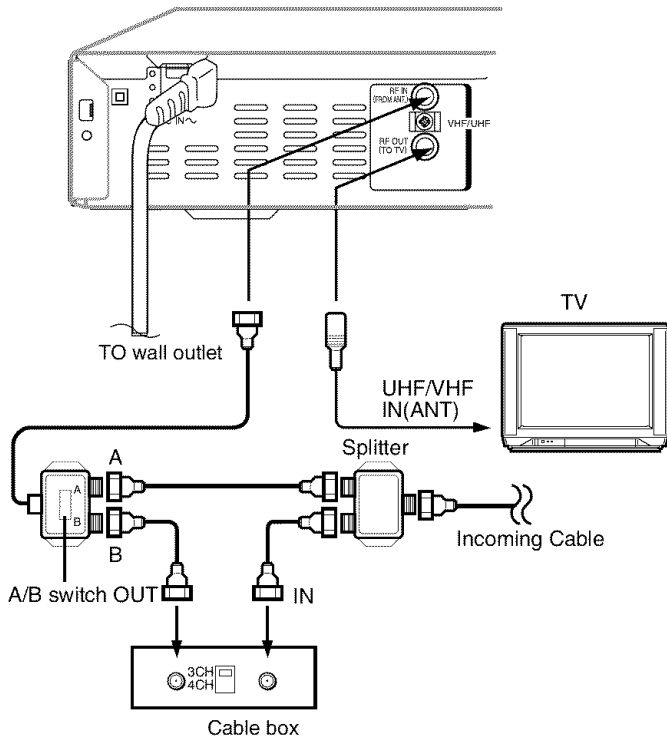

This set-up will allow you to:

- record an unscrambled or scrambled channel.
- record an unscrambled channel while watching another unscrambled channel (only when you connect a cable-compatible TV).

You will need to:

- A/B switch "A" : record an unscrambled channel which bypasses the cable box.
- A/B switch "B" : record a scrambled or unscrambled channel coming through the cable box.

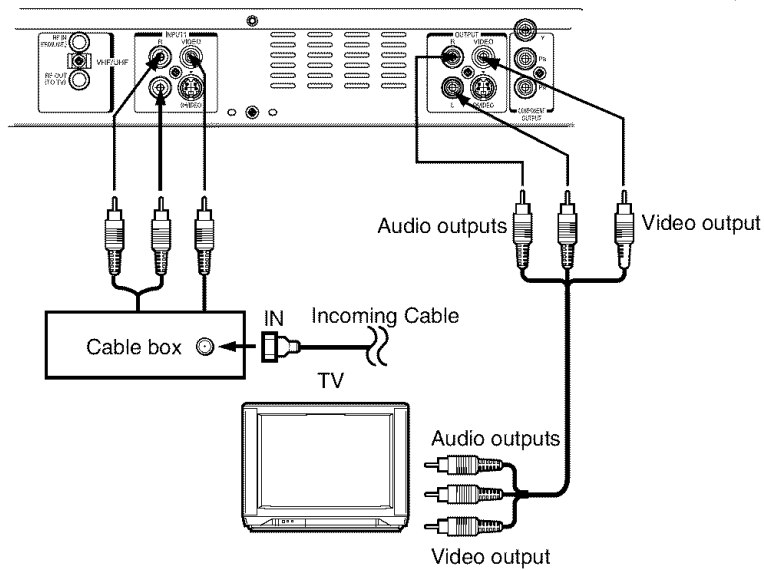

This set-up will allow you to:

- watch or record a channel through the cable box via the INPUT1 (VIDEO/L/R) jacks.

Connecting to a satellite system

Choose one of the following according to your type of satellite receiver.

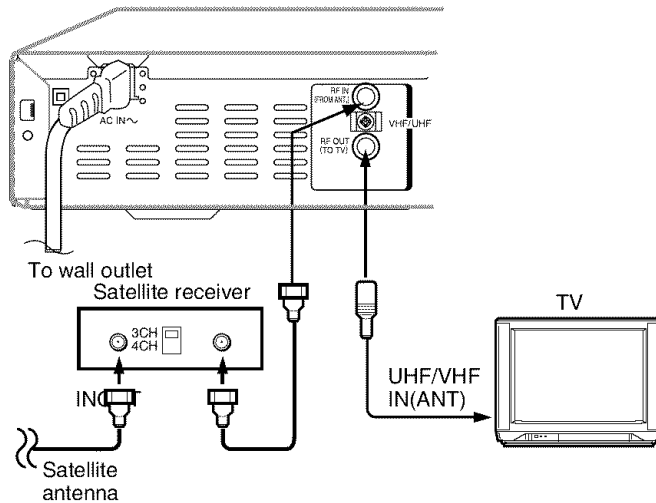

When the satellite receiver does not have audio/video outputs

- 1 Connect a satellite antenna to the satellite receiver.
- 2 Connect the RF IN (FROM ANT.) terminal on the recorder to the RF OUT terminal of the satellite receiver.
- 3 Connect the RF OUT (TO TV) terminal on the recorder to the antenna input connector of the TV.

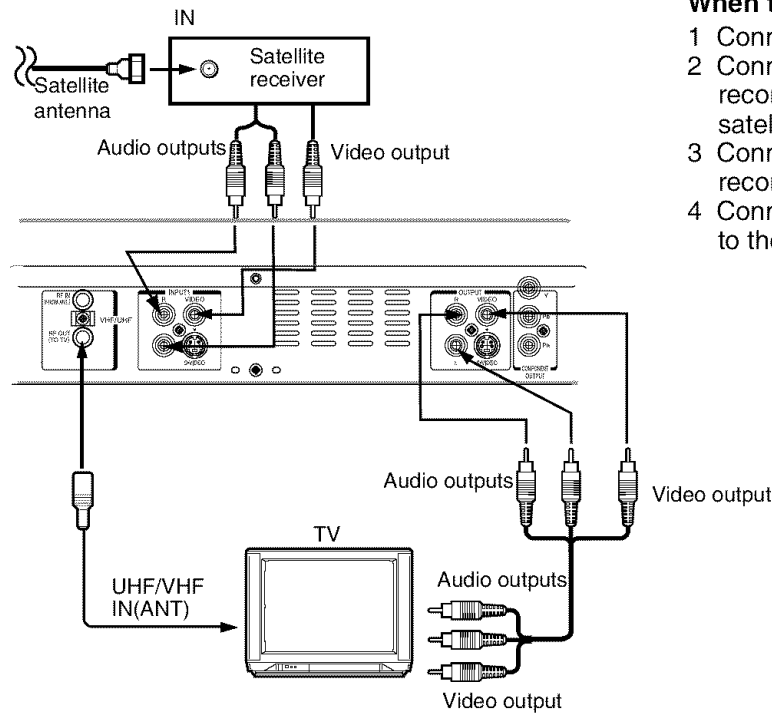

When the satellite system has audio/video outputs

- 1 Connect a satellite antenna to the satellite system.
- 2 Connect the INPUT1 (VIDEO/L/R) jacks on the recorder to the audio/video output jacks of the satellite system.
- 3 Connect the OUTPUT (VIDEO/L/R) jacks on the recorder to the audio/video input jacks of the TV.
- 4 Connect the RF OUT (TO TV) terminal on the recorder to the antenna input connector of the TV.

Connecting to a TV with the HDMI terminal

About HDMI™

HDMI stands for High Definition Multimedia Interface. HDMI transfers digital audio and uncompressed digital video on a single cable. As a result, audio cables and video cables don't need to be connected separately to a device. In addition, HDMI is compatible with HDCP (High Bandwidth Digital Content Protection).

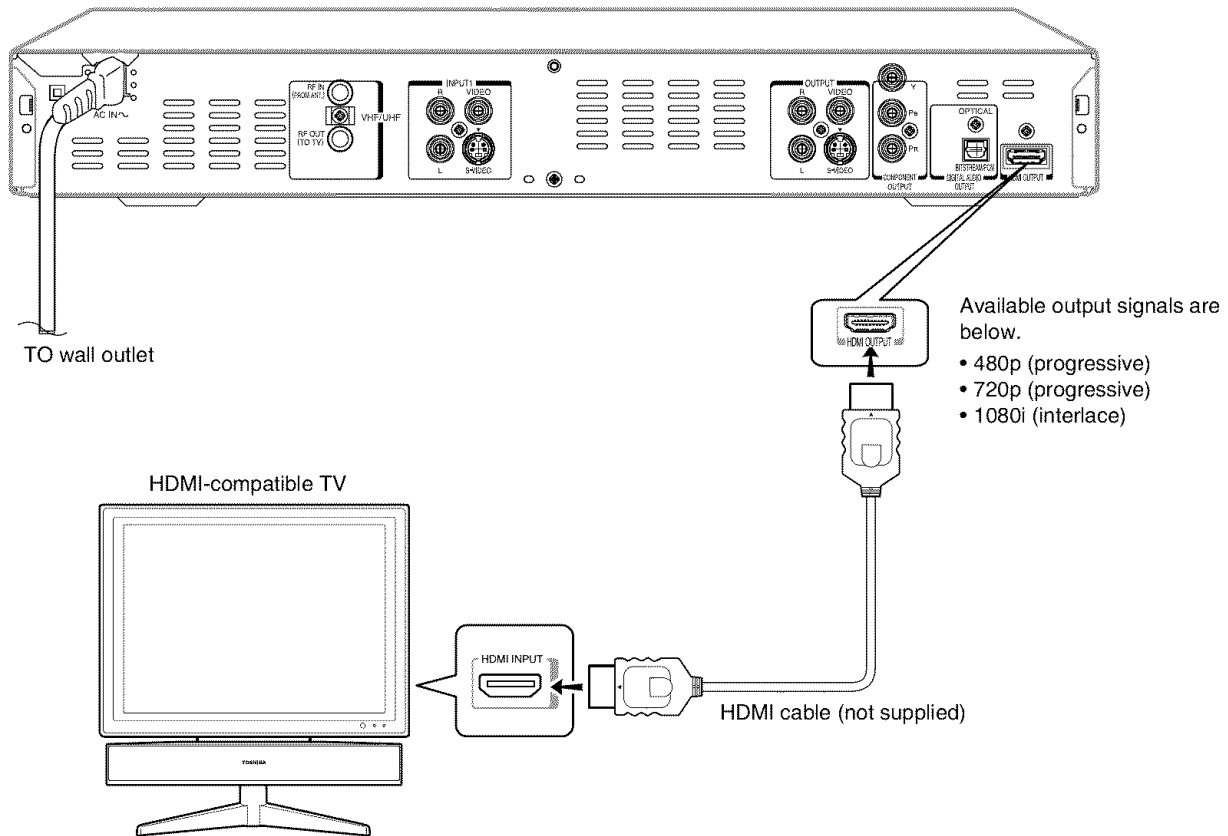

Notes

- Refer to the owner's manual for the TV to be connected to this recorder for more information concerning HDMI connections.
- HDMI connections with this recorder is not available with VGA output.
- HDMI is an evolving technology, so it is possible that some devices may not operate properly with this recorder.
- Be sure to use an HDMI cable with the HDMI logo (**HDMI**) to connect an HDMI device.

Connecting to a TV with the HDMI terminal (Continued)

Setting the output resolution for the HDMI™ output that best matches your TV's capabilities

Set an output signal from the HDMI OUTPUT terminal of the recorder in accordance with your TV's input signal.

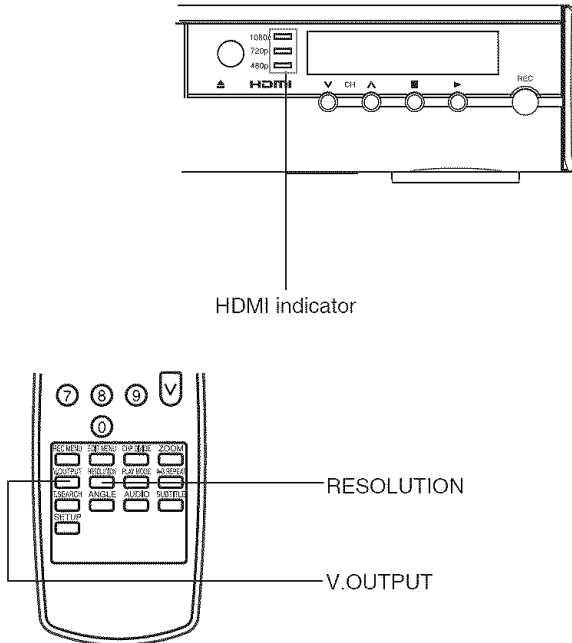

Press **V.OUTPUT** button on the remote control to light up the HDMI indicator.
 Press **RESOLUTION** button on the remote control changes output signals as below. Select the appropriate output signal.

HDMI indicator	Video output signal*
480p	480p (progressive)
Press ↓	
720p	720p (progressive)
Press ↓	
1080i	1080i (interlace)

*Displayed on the TV screen. Do not appear when the HDMI OUTPUT terminal is not connected or the HDMI connection is not verified. But HDMI indicator lights up.

Audio setting for the HDMI™ connection

Set "Digital output mode" of "A/V Output - Audio Settings" to "PCM"(➡ page 49).

Notes

- When the HDMI connection is used, "Brightness Setting" and "E.B.L" of "A/V Output - Picture" are not available.
- Depending on the equipment connected to this recorder, such as a TV or a projector, no sound may be output. In this case, set "Digital output mode" (➡ page 49) to "PCM".

HDMI, the HDMI logo and High-Definition Multimedia Interface are trademarks or registered trademarks of HDMI Licensing LLC.

Connecting to a TV equipped with component video inputs

If your TV has component video inputs, you can obtain pictures in better quality.

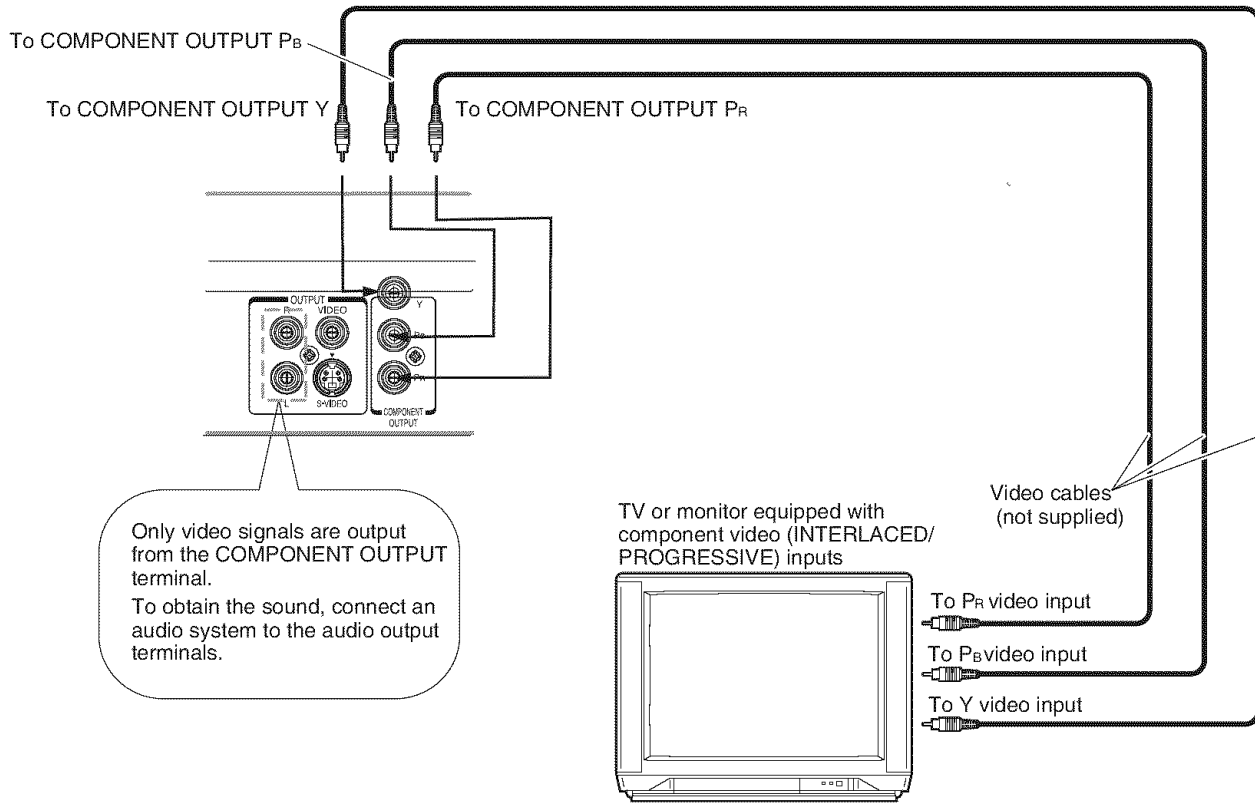

■ Component video outputs/inputs

Some TVs or monitors are equipped with component video inputs. Connecting to these inputs allows you to enjoy higher quality picture playback.

Actual labels for component video inputs may vary depending on the TV manufacturer. (ex. Y, R-Y, R-B or Y, C_B, C_R)

In some TVs or monitors, the color levels of the playback picture may be reduced slightly or the tint may change. In such a case, adjust the TV or monitor for optimum performance.

- Make the following setting.

On-screen display	Select	Page
"Digital Output Mode"	"PCM" or "Bitstream"	➡ page 49

Notes

- Refer to the owner's manual for the TV to be connected to this recorder for more information concerning an audio system.
- If you place the recorder near a tuner or radio, the radio broadcast sound might be distorted. In this case, place the recorder away from the tuner and radio.
- The output sound of the recorder has a wide dynamic range. Be sure to adjust the audio amplifier's volume to a moderate listening level. Otherwise, the speakers and your hearing may be damaged by sudden high volume sound.
- Turn off the amplifier before you connect or disconnect the recorder's power cord. If you leave the amplifier power on, the speakers may be damaged.
- Consumers should note that not all high definition television sets are fully compatible with this product and may cause artifacts to be displayed in the picture. In case of 525 progressive scan picture problems, it is recommended that the user switch the connection to the "Standard Definition" output. If there are questions regarding our TV set compatibility with this model 525p DVD player, please contact our Customer Service Center.

To switch the output signal (Progressive/Interlaced)



Press **V.OUT** button to change the video output signals (progressive and interlace) from COMPONENT OUTPUT jacks. When **V.OUT** button is pressed, the resolution of HDMI OUTPUT is displayed on the TV screen.

Connecting to an audio system

You can enjoy multichannel surround-sound such as 5.1 channel by connecting to an amplifier compatible with Dolby® Digital and DTS® sound.

- For connection to your TV, see ➡ pages 25 , 26 and 32
- For details of output sound, see ➡ page 48 and 49 in “A/V Output”.

Caution

- When you are connecting (via the DIGITAL AUDIO OUTPUT BITSTREAM/PCM jack) an AV decoder that does not have Dolby Digital, Digital Theater Systems (DTS) or MPEG2 decoding function, be sure to set “Digital Output Mode” to “PCM” from the on-screen displays (➡ 49). Otherwise, high volume sound may damage your hearing as well as the speakers.
- When playing DTS-encoded discs (DVD video discs and audio CDs), excessive noise may be output from the analog stereo jacks. To avoid possible damage to the audio system, you should take proper precautions when the analog audio out (L/R) jacks of the recorder are connected to an amplification system. To enjoy DTS Digital Surround® playback, an external 5.1 channel DTS Digital Surround® decoder system must be connected to the DIGITAL AUDIO OUTPUT BITSTREAM/PCM jack of the recorder.

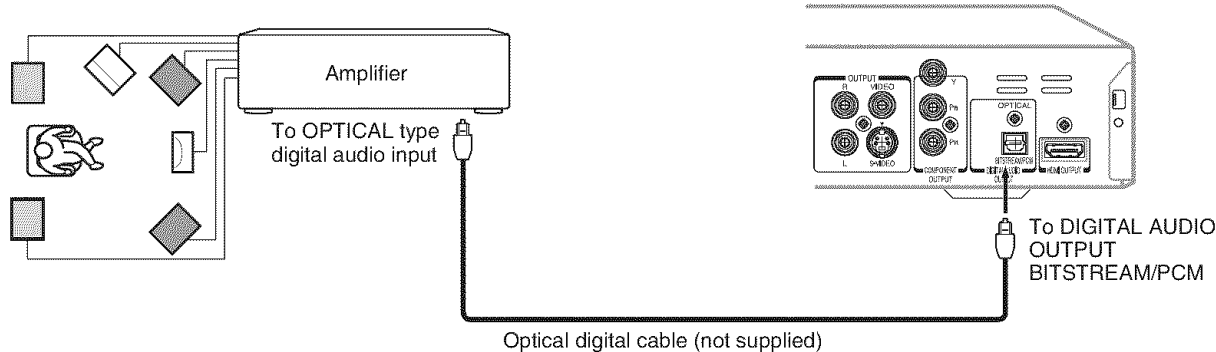

Manufactured under license from Dolby Laboratories. “Dolby” and the double-D symbol are trademarks of Dolby Laboratories.

“DTS” and “DTS Digital Out” are trademarks of Digital Theater Systems, Inc.

- Make the setting on ➡ page 49, “Digital Output Mode”.

Notes

- Do not connect the digital audio output bitstream/PCM jack of the recorder to the AC-3 RF input of a receiver with a Dolby Digital decoder. This input on your A/V Receiver is reserved for Laserdisc use only and is incompatible with the digital audio output bitstream/PCM jack of the recorder.
- Connect the digital audio output bitstream/PCM jack of the recorder to the “OPTICAL” input of a Receiver or Processor.
- Refer to the owner’s manual for the TV to be connected to this recorder for more information concerning connecting an audio system.
- The output sound of the recorder has a wide dynamic range. Be sure to adjust the audio amplifier’s volume to a moderate listening level. Otherwise, the speakers and your hearing may be damaged by a sudden high volume sound.
- Turn off the amplifier before you connect or disconnect the recorder’s power cord. If you leave the amplifier power on, the speakers may be damaged.

Power up

Plugging In and Power On

- 1 Plug the DVD recorder's electrical plug into a wall socket or power strip.
- 2 Press the **ON / STANDBY** button on the front panel, or the **I/O** button on the remote control to turn the DVD recorder on.
- 3 When the DVD player's splash screen appears on your TV, you're ready to go!



Note

- If this screen does not appear, please check the Video connection (▶ 26,28,31 and 32) or HDMI indicator (▶ page 31).

Time and Date Settings

The recorder uses the Time and Date values to determine when to begin and end Scheduled Recordings.

- 1 Press **SETUP** to enter the Setup Menu.
- 2 Use the **▲/▼** keys to select General and press **ENTER**. Use the **▲/▼** keys to select Clock and press **ENTER**.
- 3 Use **▲/▼** keys to select a field and then press **ENTER**.
- 4 Use the **▲/▼/◀/▶** keys to set the value of the field and press **ENTER**.
- 5 Press **RETURN** to exit the Clock Menu.
Select the Clock Menu and press **ENTER**. The Clock screen appears with the following options.
 - **Clock Settings** - Set the time. This setting will show AM or PM.
 - **Date Settings** - Set the date. Use 2-digit year format.

Channel Setup

Once your Antenna or Cable TV input is connected to the connector on the back of the unit, you can setup the recorder's built-in TV Tuner by auto-scanning for available channels and then adding or deleting the channels you choose.

- 1 Press **SETUP** to enter the Setup Menu. Select the TV channel with the **▲/▼** keys and press **ENTER**.
- 2 You can press **RETURN** repeatedly to exit the Setup Menu at any time.

Auto Scanning Channels

This is the easiest way to fill your channel list with those channels available in your area. The unit scans for channels automatically.

- 1 Press **SETUP** to enter the Setup Menu. Select the **TV channel** with the **▲/▼** keys.
- 2 Press **ENTER** to bring up the menu to select your connection type (Antenna or Cable), use the **▲/▼** keys to select and press **ENTER**.
- 3 The unit scans for channels automatically. When it is completed, press **RETURN** to exit the TV Channel menu.

Restore Defaults

Choose this option to clear the channel list of all your previous changes. (▶ page 48)

Switching to TV Mode

Once you have configured your channels, you can begin using the recorder's built-in TV TUNER for Recording or simply watching your favorite programs.

- 1 When the unit is first turned on, the DVD **PLAYBACK** mode is selected by default. Press **INPUT SELECT** and use the **◀/▶** and **ENTER** keys to switch to **TUNER** mode.
- 2 Use the **▲/▼** keys to change channels while watching TV. Alternatively, you can enter a channel number directly with **NUMBER** keys, and press **ENTER**.
To return to DVD Playback mode, press the **INPUT SELECT** key and select **DVD** at any time.

Disc Playback

Inserting a Disc

- 1 Press the **OPEN/CLOSE** button on the remote or front panel to open the disc tray
- 2 Insert the disc and be careful not to touch the playing surface. Hold the disc by the sides and with your fore finger through the hole in the middle and place it gently onto the tray.
- 3 Close the disc tray by pressing **OPEN/CLOSE** on the remote or front panel.

Starting, Stopping and Pausing Playback

- 1 **PLAY** – To begin playback of a disc, press **PLAY** (Remote Control) or **PLAY (▶)** (Front Panel).
- 2 **STOP** – To stop playback of a disc, press **STOP**. When **STOP** is pressed for the first time, the recorder memorises the location where playback is stopped. You can begin playback where you left off by pressing **PLAY**. If **STOP** is pressed twice, the playback location is reset to the beginning of the disc.
- 3 **PAUSE** – To freeze the video on a single frame or pause music, press the **PAUSE** (Remote Control) key during playback. To resume normal playback, press **PLAY (▶)** (Front Panel) or **PLAY** (Remote Control).

Notes

- Some Video CD are recorded with PBC (Playback control), a menu with recorded contents may appear on the TV if you have turned the PBC on. You can make your selection according to its PBC menu. Press the **MENU** button on the remote control to turn PBC on or off anytime during Video CD playback. When switching from PBC off to PBC on mode, playback will start from the beginning of the disc.
- Depending on disc condition, pressing the **PLAY** button may take about 10 seconds or longer to start playback.

Fast Forward/Reverse Scanning

You can scan through DVDs, VCDs and other discs in forward or reverse direction. Fast forward/reverse scanning will only work during disc playback.

- 1 Press the **▶▶** (FWD) or **◀◀** (REV) button on the remote control repeatedly to cycle through all the four speeds in the desired direction.
- 2 Press **PLAY (▶)** (Front Panel) or **PLAY** (Remote Control) to resume playback.

Notes

- During fast forward playback at “▶▶” speed, sound is reproduced if the playing disc is recorded in DVD-Video mode.

Skipping to the Next/Previous Chapter or Track

You can advance or skip back through the chapters or tracks on DVD discs, VCDs, Audio CDs and other discs with the **▶▶** (**SKIP FWD**) and **◀◀** (**SKIP REV**) buttons on the remote control.

- 1 **SKIP NEXT** – Press **▶▶** on the remote control to advance to the next chapter/track.
- 2 **SKIP PREVIOUS** – Press **◀◀** once on the remote control to skip back to the beginning of the current chapter or track. Press **◀◀** twice in quick succession to skip back to the previous chapter /track.

Slow Motion Playback

This unit supports slow motion playback in the forward direction at three speeds.

- 1 During playback, press the **SLOW** key repeatedly to select a slow motion speed.
- 2 Press **PLAY (▶)** (Front Panel) or **PLAY** (Remote Control) to resume playback.

Frame-By-Frame Step Playback

You can freeze playback on a single frame and then step forward one frame at a time.

- 1 Press the **PAUSE** key to freeze playback.
- 2 Press the **PAUSE** key to advance one frame.
- 3 Press **PLAY** to resume normal playback.

Advanced Playback Functions

ZOOM Playback

Use the ZOOM function to magnify or shrink the image on screen during playback or when paused.

- 1 Press the **ZOOM** key repeatedly to choose a magnification level from 2x,3x,4x,1/2x or Off.
- 2 When the **ZOOM** function is first activated, directional arrows will appear on screen. During this time, you can use the **▲/▼** and **◀/▶** keys on the remote control to move around the image in order to view the area that is currently off screen.
- 3 Press the **ZOOM** key repeatedly to choose ZOOM Off to return normal viewing.

Instant Replay

The **INSTANT REPLAY** key lets you return before at 10 second intervals.

- 1 During playback, press the **INSTANT REPLAY** key to return before at 10 second intervals.

Instant Skip

The **INSTANT SKIP** key lets you “jump” forward at 30 second intervals

- 1 During playback, press the **INSTANTSkip** key to “jump” forward at 30 second intervals.

Multi-Angle Function

Some DVD discs are recorded with multiple viewing angles for certain scenes. When you are viewing a disc that supports this feature, you can choose among the available angles on the disc with the **ANGLE** key.

- 1 Press the **ANGLE** key repeatedly to change the scene to the next angle in those recorded.

Changing the Audio Track

Most DVD discs are recorded with multiple audio tracks. These can contain multiple languages and different audio formats, such as 5.1Channel, 2 Channel and other languages. For Video CD, there are three audio tracks (stereo,left or right) which can be selected.

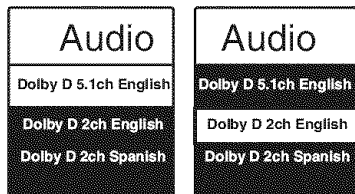

- 1 During playback, press the **AUDIO** button to access the Audio Menu.
- 2 Use the **▲/▼** keys to select an audio track and press **ENTER** to confirm. Press **AUDIO** button to exit the Audio Menu.

Subtitles

Most DVD discs include at least one subtitle track in one language. Subtitles are useful when viewing movies in a foreign language or for hearing-impaired viewers.

- 1 During playback, press the **SUBTITLE** button to access the Subtitle Menu.
- 2 Use the **▲/▼** keys to select an available language and press **ENTER**. In this example, we have chosen Spanish subtitle.
- 3 To turn off Subtitle, press the **SUBTITLE** key to access the Subtitle Menu. Use the **▲/▼** key to select OFF and then press **ENTER**.

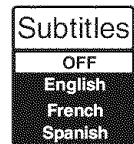
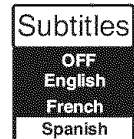

Displaying Playback Session Information

When playing a DVD or Video CD, you can display the current title, chapter/track, elapsed playback time and other useful information with the **DISPLAY** key.

- 1 During playback, press the **DISPLAY** key to view available information.

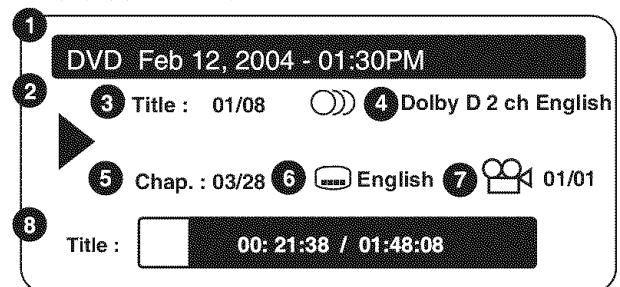

- 1 The type of video or file format displayed. Also displays the Date and Time of the unit.
 - 2 Playback action icon designating current status: Play, Pause, Fast Forward, etc.
 - 3 Title Number/Track Number currently being displayed. Also displays total number of Titles/Tracks on the disc.
 - 4 DVD Audio Track selected.
 - 5 For DVD : Chapter number currently being played. Also displays total number of chapters on the disc. For Video CD: Audio Track selected.
 - 6 Subtitle Language currently selected.
 - 7 Angle selected and available angles on the disc.
 - 8 Progress bar,current elapsed play time and total time of the title/current track.
- 2 Press **DISPLAY** again to exit the menu.

Jumping and Repeat Playback / TIMESLIP (Chase Play)

Jumping to a Title, Chapter/Track or Time Point

The **T.SEARCH** function provides a convenient way to navigate DVD and Video CD by allowing you to select the Title, Chapter/Track or Time to jump to.

- 1 During playback, press the **T.SEARCH** key to bring the T.Search Menu.

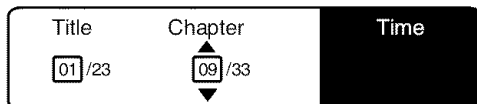

- 2 Use the **◀/▶** keys to choose Title or Chapter/Track. Use the **▲/▼** or the **NUMBER** keys to select a Title or Chapter/Track to jump to. Press the **ENTER** key to confirm.

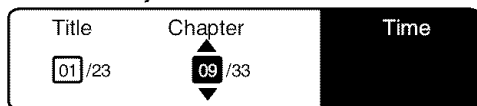

- 3 To jump to a time on the disc, press **▶** to select the Time field. Use the **▲/▼** or **NUMBER** keys to enter the time. Use the **◀/▶** keys to move between to each desired time fields, then press **ENTER** to confirm your selection.

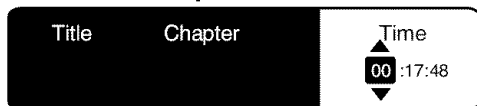

Repeat Playback

To repeat a segment of a disc, use the **PLAY MODE** key. On DVDs, you can repeat an entire Disc (All), Title or Chapter. On VCDs, Track and All repeat is supported.

- 1 Press **PLAY MODE** during disc playback to set the Repeat Mode.
- 2 To return to normal playback, press **PLAY MODE** until the **Repeat OFF** icon appears on-screen signifying that repeat play is cancelled.

Note

- In case of Video CD with PBC, you cannot set Repeat function during playback.

A-B Repeat

The **A-B REPEAT** key lets you to define your own segment to repeat.

- 1 During playback, when you reach the start of the segment you want to repeat, press the **A-B REPEAT** button. An icon, **Repeat A**, is displayed on-screen, letting you know that the segment start point has been saved.
- 2 When you reach the end of the segment you want to repeat, press the **A-B REPEAT** button again. The **Repeat A-B** icon is now displayed on-screen. The segment will now begin to repeat.
- 3 To cancel repeat and resume normal playback, press **A-B REPEAT** again. The repeat icon on-screen changes to **Repeat OFF**.

TIMESLIP (Chase Play)

- 1 While recording a TV program on a DVD-RAM disc, press **TIMESLIP**. The recorder displays a TV program as it is being recorded.
- 2 Go back to the beginning of the TV program, press **SKIP REV**. When you go back to the beginning, playback starts automatically. You can check how far you are from the current broadcast by pressing **DISPLAY** button to view the Display Menu.

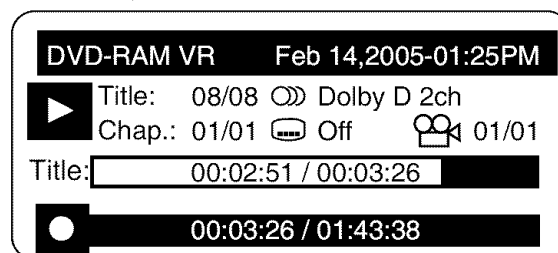

- 3 Locate a scene you want through the following operations if necessary.
 - Fast-forward/fast-reverse:** Press **FWD** or **REV** button.
 - Slow-motion:** Press **SLOW** button.
 - To resume normal playback, press the **PLAY** button.
- 4 Press **TIMESLIP** to exit from Chase Play.

Notes

- TIMESLIP function is not available when recording a DVD-RW/R disc and a DVD-RAM in XP mode.
- TIMESLIP function does not work until 30 seconds of recording have elapsed.



About the Screen Saver

When the recorder is left in DVD stop mode for a period of about 5 minutes, the Screen Saver will load to protect the television from "screen burn", which could occur if an unusual bright image is displayed on-screen for an extended period of time.

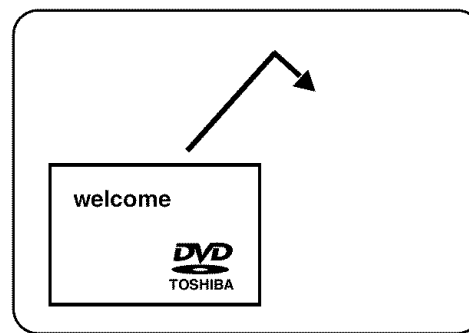

Viewing JPEG / Play Audio CD/MP3/WMA /DivX®

This unit can play an audio CD, JPEG , MP3, WMA and DivX® file on a disc. A handy on-screen player will appear automatically. (For example : play MP3)

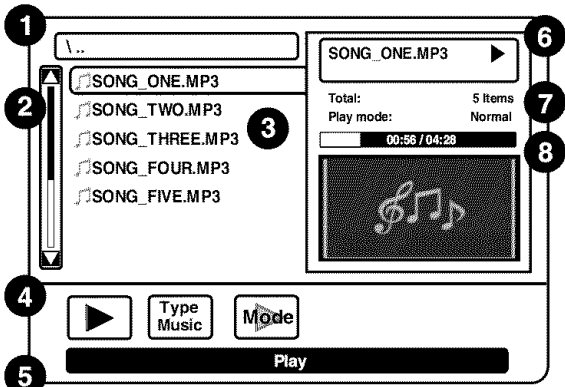

- 1 The music file format.
- 2 The display bar for the file list.
- 3 Displays up to 10 music files at one time. Use the ▲/▼ keys to navigate this list.
- 4 Press the **ENTER** key to enable the Action Menu.
- 5 Displays current Action Menu functions.
- 6 Displays the current file name and Current Playback Action icon.
- 7 Displays the total files of a folder and current selected play mode.
- 8 Progress bar, current elapsed play time and total time of the current file.

Action Menu Icons

Press **ENTER** on any file to start the Action Menu.
Press **RETURN** to exit the Action Menu.



PLAY- Begin playback of a file.



TYPE- Select the desired file type to be listed on-screen. Choose from Music, Picture, Video or All types.



PLAY MODE - Select from available playback modes including Shuffle, Shuffle Repeat, Repeat One, Repeat All, Play Once and Normal.

Shuffle:Playbacks all files on the current folder or all tracks on the disc in random order.

Shuffle Repeat:Playbacks all files on the current folder or all tracks on the disc in random order repeatedly.

Repeat One:Playbacks the current file /track repeatedly.

Play One:Playback stop after the current file/track is being played has ended.

Normal:Resumes normal playback.



FOLDER MODE - Switches the FILE DISPLAY MODE to display the folders on a disc. (This option appears only in SPLIT MODE.)



THUMBNAIL PLAY - Begin JPEG thumbnail display playback mode.

JPEG Images, Slide shows and Rotation

Inserting a JPEG Disc

- 1 Press **▶** key to select the Thumbnail play icon. A thumbnail preview screen will display all files on the disc automatically.
- 2 Press the **▲/▼/◀/▶** keys to select a file and then press **ENTER** to begin playback. All the following images will be displayed on screen in slideshow mode (▶▶ page 52).
- 3 Press the **▲/▼/◀/▶** keys rotate the image.
- 4 Press **RETURN** to exit the slide show and return to the thumbnail preview screen. Press **RETURN** again to exit the thumbnail preview screen.
- 5 Use the **◀/▶** keys to navigate the Action menu items to select other playback features as listed above.

■ As below rotate clockwise:

- ▲ Fixedly angle is 0°. ▶ Fixedly angle is 90°.
- ▼ Fixedly angle is 180°. ◀ Fixedly angle is 270°.

■ Playable files

FUJICOLOR CD Kodak Picture CD

JPEG disc compatibility with this recorder is limited as follows:

- Playable discs: CD-ROM, CD-R (650MB / 74 min. only), DVD-R/DVD-RW, CD-RW is not recommendable.
- CD physical format:

Mode 1, Mode 2 XA Form 1

- File system: ISO9660 Level 1, 2 or Joliet
- File name:

A file name should be in alphabet and numerals only, and must incorporate "JPG" extension. e.g. "*****.JPG", "*****.JPE", "*****.JPEG".

- Display image height and width: 5670 x 3840

Viewing JPEG / Play Audio CD/MP3/WMA /DivX® (Continued)

Introduction

Connections

Quick Start
Guide

Playback

Recording

Setup Menu

Others

MP3/WMA file Playback

Inserting an MP3/WMA Disc

- 1 Press ▲/▼ to select your desired file, and then press **ENTER** to start playback.
- 2 Use the ◀/▶ keys to navigate the Action menu items to select other playback features as listed on page 38.

■ Playable files

MP3/WMA disc compatibility with this recorder is limited as follows:

- Playable discs:
CD-ROM, CD-R, DVD-R/DVD-RW,
CD-RW is not recommendable.

- Sampling Frequency / Bitrate:

WMA: V7, bitrate >=48kbps, sampling rate must be 32kHz, 44.1kHz or 48kHz, but if the bitstream is 48kbps (bitrate) + 32kHz (sampling rate), then we cannot support it.

V8 and V9, bitrate >=48kbps, sampling rate must be 32kHz, 44.1kHz or 48kHz

MP3: No any limitation

- CD physical format:
Mode 1, Mode 2 XA Form 1
- File system:
ISO9660 Level 1, 2 or Joliet
- File name:

A file name should be in alphabet and numerals only, and must incorporate "MP3" or "WMA" extension. e.g. "*****.MP3", "*****.WMA".

Microsoft, Windows Media, and the Windows logo are either registered trademarks or trademarks of Microsoft Corporation in the United States and/or other countries.



Notes

- This recorder requires discs/recordings to meet certain technical standards in order to achieve optimal playback quality. Pre-recorded DVDs are automatically set to these standards. There are many different types of recordable disc formats (including CD-R containing MP3/WMA files). Because this area of technology is still evolving, Toshiba cannot guarantee that all recordable discs will produce optimal playback quality. The technical criteria set forth in this owner's manual are meant only as a guide.
- You must obtain any required permission from copyright owners to download or use copyrighted content. Toshiba cannot and does not grant such permission.

DivX® file Playback

Inserting a DivX® Disc

- 1 Press ▲/▼ to select your desired file, and then press **ENTER** to start playback.
- 2 Use the ◀/▶ keys to navigate the Action menu items to select other playback features as listed on page 38.

■ Playable files

DivX® disc compatibility with this recorder is limited as follows:

- Playable discs:
CD-ROM, CD-R (650MB / 74 min. only), DVD-R/
DVD-RW, CD-RW is not recommendable.
- Audio format:
CBR MP3, VBR MP3, DivX® AC3

- Enhance video:

GMC, Qpel, Progressive B-frames

- Frame rate:

8 to 25 fps

- CD physical format:

Mode 1, Mode 2 XA Form 1

- File system:

ISO9660 Level 1, 2 or Joliet

- File name:

A file name should be in alphabet and numerals only, and must incorporate "AVI" extension.

e.g. "*****.AVI", "*****.DIVX", "*****.DIV"

"*****.XVID".

Notes on DivX® VOD (Video On Demand) files

DivX® VOD files are under DRM copy protection and can be played only on registered device.

Some DivX® files may require the registration code of this recorder when played. For the code, (see page 48). DivX® VOD files which this recorder is not registered for their player cannot be played on this recorder (an error message appears).

Some DivX® VOD files have limitation of playback times. Each time such a file is played, the remaining playback time appears. When it reaches 0, no more play of the file is permitted.

DivX, DivX Certified, and associated logos are trademarks of DivX, Inc. and used under license.

Notes

- This recorder requires discs/recordings to meet certain technical standards in order to achieve optimal playback quality. Pre-recorded DVDs are automatically set to these standards. There are many different types of recordable disc formats (including those containing DivX® files). Given the fact that technology in this area is still maturing, Toshiba cannot guarantee that all genre of recordable discs will produce optimal playback quality. The technical criteria set out in this owner's manual are meant as a guide only.
- You must obtain any required permission from copyright owners to download or use copyrighted content. Toshiba cannot and does not grant such permission.

Recording-Rear Input Connections

Recording to DVD Discs

With DVD-R/RAM/RW recording, you can create your own DVDs from your home movies, favorite TV shows or from other video sources.

Recording- Rear Input Connections

REAR RECORDING INPUTS - There are (two) recording source inputs on the back panel, (1) S-VIDEO (referred to as "S-Video 1") and (2) VIDEO (referred to as "Video 1"). Note that both of these video inputs share the same stereo audio input.

Selecting an Input Source

You can easily select the AV input on this unit.

- 1** Connect the desired AV input source.
- 2** Press **INPUT SELECT** key and use the **◀/▶** keys to select your desired input source. Press **ENTER**.
- 3** You can now view the content from the AV source that you have connected to the unit.
- 4** Insert a recordable DVD-R/DVD - RAM /DVD-RW disc and press **REC** to begin recording.

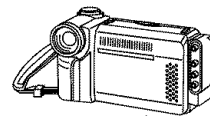
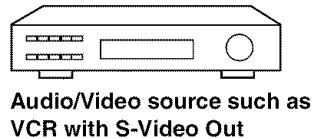

You may choose from the following input sources:

- **DVD** - The DVD recorder's played and recorded disc format.
- **DV** - The DV Input on the Front Panel.
- **Video In1** - The Composite Video Input located at the back of the unit. Used for any video device with Composite Video Out.
- **S-Video1** - Located on the back panel, S-Video provides a better picture than standard Composite Video. Use this input for camcorders or other video devices when possible.
- **Video In2** - The Composite Video and S-Video to the Input on the Front Panel.
- **S-Video2** - The Composite S-Video Input on the Front Panel.
- **Tuner** - The DVD Recorder's built-in TV Tuner allows you to record your favorite TV programs.

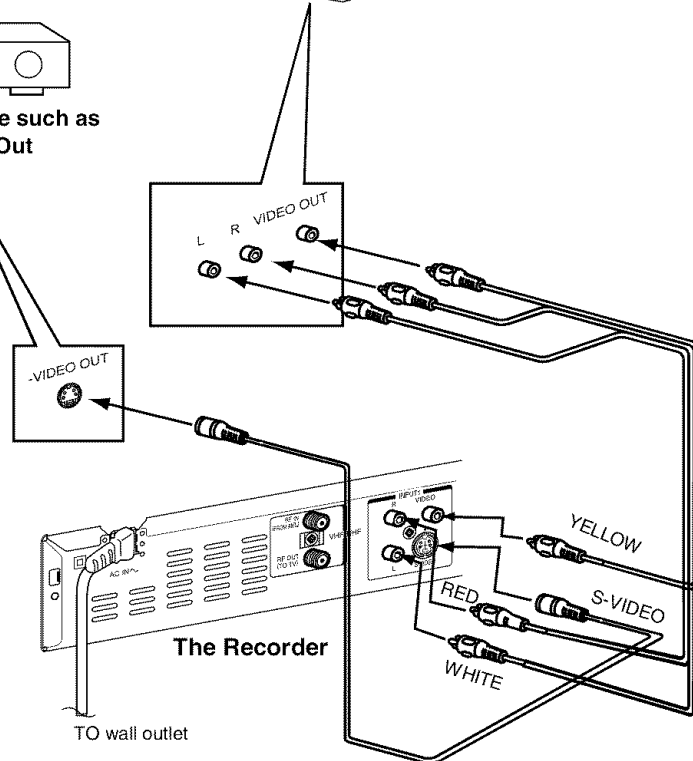

Note

- The unauthorized recording, use, distribution, or revision of television programs, videotapes, DVDs and other materials, is prohibited under the Copyright Laws of the United States and other countries, and may subject you to civil and/or criminal liability.

Recording-Front Input Connections

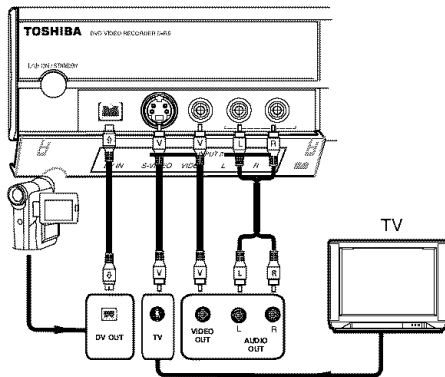

Controlling a DV Camcorder

You can use this unit's remote control most camcorders that support the DV interface.

- 1 Connect the camcorder to the **DV IN** using a Digital Video (also called 1394 or Firewire) Cable.
- 2 Press the **INPUT SELECT** key and use the **◀▶** keys to select DV. Press **ENTER**.
- 3 Press the **REC** key on the front panel or on the remote control to record starting.
- 4 You can now control the DV camcorder with this unit's remote. Available functions are: **PLAY**, **STOP**, **FF/FR** and **PAUSE**.

Making a Recording

Recording TV programs

You can easily record from your TV.

- 1 Press the **POWER** key on the remote control to turn on the unit.
- 2 Insert a recordable DVD-R/DVD-RW/DVD-RAM disc.
- 3 Press the **INPUT SELECT** key on the remote control and select the **Tuner** input.
- 4 Press the **▲** or **▼** keys to select the channel you wish to record.
- 5 Press the **REC** key to start recording. Recording continues until you press **STOP** or when the disc is full. The **RECORDING** icon appears on-screen to indicate the recording has begun.

Stopping a Recording

When you stop a recording, a new Title is created.

- 1 Press **STOP** to end a recording. The **STOP RECORDING** icon appears on screen.
- 2 After a few seconds, the new Title you have just recorded is closed. The **RECORD SUCCESS** icon appears on screen.

Pausing and Resume Recording

You can pause the recorder during a Recording.

- 1 Press **PAUSE** key to temporarily halt recording. The **PAUSE RECORDING** icon appears on screen.
- 2 Press **REC** key to resume recording session.

Specifying the Recording Time

At this point, recording has started with no specific end time, so you'll have to press the **STOP** key to manually end the recording. Alternatively, you can specify the length of the recording in 30 minute intervals by pressing the **REC** key repeatedly.

- 1 Press **REC** key repeatedly to set the length of the recording in 30-minute intervals. Choose **Timed Rec OFF** if you don't want to specify a recording length.

Finalize

To play a DVD disc recorded on this unit, you must finalize the disc to ensure compatibility with other DVD player. (▶ Page 47)

Using DISPLAY to View Recording Options

View useful information using **DISPLAY**.

- 1 Press **DISPLAY** while recording. The Display Menu appears as shown. When the DVD-RW disc is recorded, see below information.

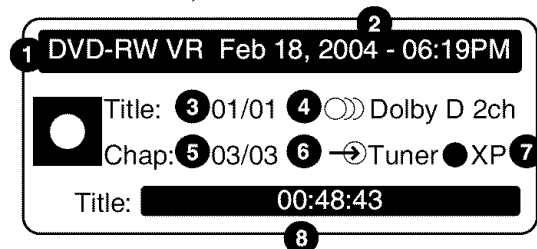

- 1 **Disc Type** - Disc format: DVD-R (Video), DVD-RAM (VR), DVD-RW (VR or Video).
- 2 **Date and Time** - The system date and time.
- 3 **Title** - Displays Current Title and Total Titles.
- 4 **Audio Mode** - Type of audio track being recorded.
- 5 **Chapter** - Displays the Current and Total Chapters.
- 6 **Input source** - Displays selected input source.
- 7 **Record Mode** - Displays recording quality setting.
- 8 **Title** - Displays the length of the Title currently being recorded on the disc.

Note

- The unauthorized recording, use, distribution, or revision of television programs, videotapes, DVDs and other materials, is prohibited under the Copyright Laws of the United States and other countries, and may subject you to civil and/or criminal liability.
- Depending on disc condition, pressing the **REC** button may take several seconds to start recording.
- The recorder may take several dozens of seconds to finish recording, if a loaded disc contain a large number of titles or chapters.

Playing and Editing Your Recordings

The Title Screen

When you insert a DVD-R/DVD-RAM/DVD-RW disc which have finished record, press **EDIT MENU** button on the remote control, the Title Screen will appear. The Title Screen displays thumbnail previews and information for each Title (recording) on the disc, as well as the amount of free space available for recordings. In the Title Screen, you can perform the following functions with your Recordings:

- **Play Titles or Chapters.**
- **Delete Titles.**
- **Rename Titles or Disc.**

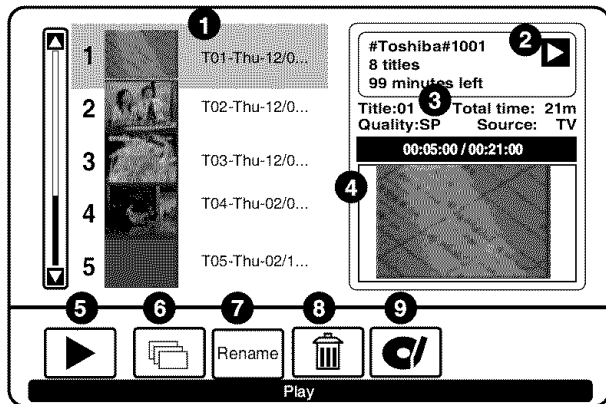

- 1 Thumbnail Images** - Displays the first frame of the corresponding title.
- 2 Disc Information** - Shows the Disc Name, total number of titles on the disc and recording time remaining.
- 3 Progress Bar** - Shows the current playback point and total length of the current title.
- 4 Title Preview** - The current title is played in this window.
- 5 Play Title** - Begins playback of selected title.
- 6 Chapter Viewer** - See Chapter Previews and Play Chapters.
- 7 Rename Title** - Rename the Title with the On-Screen Keyboard.
- 8 Delete Title** - Delete the current title.
- 9 Change Disc Name** - Rename the Disc with the On-Screen keyboard.

Playing a Title

- 1** Press **EDIT MENU** to show the Title screen.
- 2** Use the **▲/▼** keys to select the title you wish to play and press **PLAY**.
- 3** The Action Menu also can be used to playback a title. Use the **◀/▶** keys to select the **PLAY** icon and then press **ENTER**.

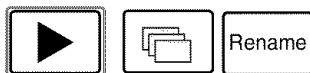

- 4** To return to the Title Screen, press **EDIT MENU**.

Note

- Using these editing functions to modify copyrighted content for any purpose other than your private viewing may be prohibited under the Copyright Laws of the United States and other countries, and may subject you to civil and criminal liability.

Playing a Chapter

- 1** Press **EDIT MENU** to show the Title screen.
- 2** Use the **▲/▼** keys to select the title that contains the chapter you wish to play.
- 3** Use the **◀/▶** keys to select the Chapter Viewer icon and then press **ENTER**.
- 4** Use the **▲/▼** keys to select the chapter you wish to play and press **PLAY**.
- 5** Or use the **◀/▶** keys to select the **PLAY** icon and then press **ENTER**.
- 6** To return to the Title Screen, press **EDIT MENU**.

Renaming a Title

- 1** Press **EDIT MENU** to show the Title screen.
- 2** Use the **▲/▼** keys to select the Title you wish to rename.
- 3** Use the **◀/▶** keys to select the Rename Title icon and then press **ENTER**. Use the on-screen keyboard (page 43) to rename the title.

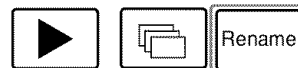

Delete a Title

- 1** Press **EDIT MENU** to show the Title screen.
- 2** Use the **▲/▼** keys to select the title you wish to erase.
- 3** Use the **◀/▶** keys to select the Delete Title icon and then press **ENTER**.
- 4** A message "Do you really want to delete the selected item?" is displayed. Use the **◀/▶** keys to select "Yes" and then press **ENTER**.

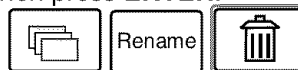

Change Disc Name

- 1** Press **EDIT MENU** to show the Title screen.
- 2** Use the **◀/▶** keys to select the Change Disc Name icon and then press **ENTER**.
- 3** A Set Disc Name Screen is displayed. Use the **◀/▶** keys to select the "Edit name" and then press **ENTER**. Use the on-screen keyboard (page 43) to rename the disc.
- 4** The Set Disc Name screen is displayed again. Use the **◀/▶** keys to select "OK" and then press **ENTER**.



On-Screen Keyboard & Scheduled Recordings

About On-Screen Keyboard

The On-Screen Keyboard makes it easy to enter Text, Numbers and Various Symbols with your remote control.

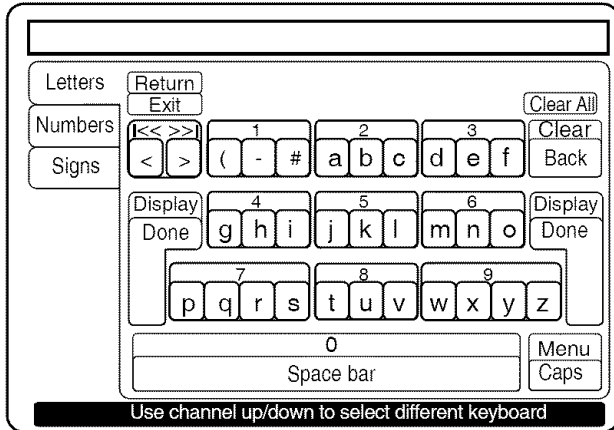

- 1 Use the \wedge/\vee keys to select Letters, Numbers or Signs keyboard.

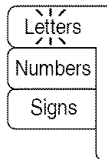

- 2 Press the \blacktriangleright key to move to the virtual keyboard on the right.

Using the On-Screen Keyboard

There are two methods you can use to enter characters with the virtual keyboard:

- 1 **Use the HOT KEYS** - Each character in the Letters and Signs keyboards shows a hot key above it that corresponds to one on the remote control. Press this key repeatedly until the character you wish to enter is highlighted and then press **ENTER**. For example, to enter the letter "s", press the 7 key four times. Notice that the first letter is automatically capitalized.

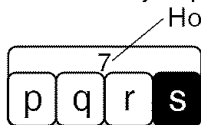

- 2 **Use the $\blacktriangle/\blacktriangledown$ and $\blacktriangleleft/\blacktriangleright$ keys** - Simply use the directional arrow keys to move to the character you wish to insert and then press **ENTER**.

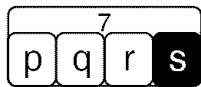

Note

- You can select "<" and ">" symbols only in the Signs Keyboard.

Deleting Characters

- 1 Press the **CLEAR** key or use the $\blacktriangle/\blacktriangledown$ and $\blacktriangleleft/\blacktriangleright$ keys to move to Back and press **ENTER**.

Saving Your Changes

- 1 To save your changes, select Done by pressing **DISPLAY** or using the $\blacktriangle/\blacktriangledown$ and $\blacktriangleleft/\blacktriangleright$ keys to select Done and then pressing **ENTER**.

Scheduled Recordings

Timer Recordings are designed for unattended operation and will work when the recorder is in Standby Mode.

Scheduled a Recording

- 1 To Begin programming a scheduled recording, press the **REC MENU** button on the remote control. This will access the recorder's Schedule Screen.

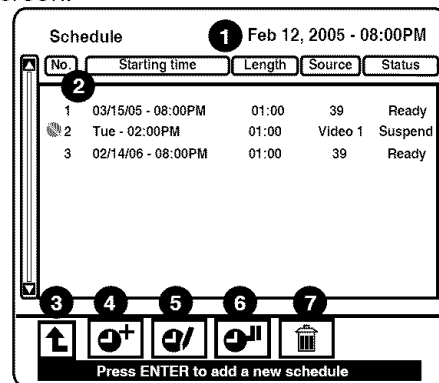

- 1 **Current Time** - Current time of the clock.
 - 2 **Events** - Total scheduled recording event(s).
 - 3 **Close Screen** - To close the Schedule Screen.
 - 4 **Add New Schedule Recording** - Choose to add a new event to the Schedule.
 - 5 **Change Current Schedule Setting** - Choose to Edit the Schedule.
 - 6 **Toggle Current Items** - Change the status of the schedule - Ready or Suspended.
 - 7 **Remove Current Schedule from Schedule List** - Delete the current schedule.
- 2 Before any schedules have been entered, the New Schedule Recording screen will appear by default.

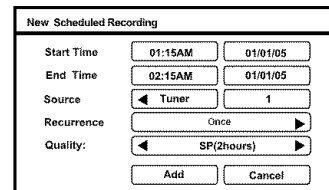

Notes

- The unauthorized recording use, distribution, or revision of television programs, videotapes, DVDs and other materials, is prohibited under the Copyright Laws of the United States and other countries, and may subject you to civil and/or criminal liability.
- A timer recording may start several seconds up to about a quarter of 1 minute behind the programmed start time.

Scheduled Time Recordings

Setting Starting and Ending Times

- By default, the Start and End times are set to the current time and one hour later, respectively. The Start and End dates are set to the current date.
- To change a time or date field, use the \uparrow/\downarrow and \leftarrow/\rightarrow keys to navigate the screen. To select a field to change, press **ENTER**.

08:00 PM

- With Time fields, select the 9's or 0's digit to change, with increments of 10 minutes or 1 minute, respectively.

08:05 PM

- Press **ENTER** to save your changes and exit edit mode for the current field.

Setting the Source

- To select an input source or TV channel to record, use the \uparrow/\downarrow keys. For TV channels, use the number keys to specify your selection.

◀ Video 2 ▶

Setting the Recurrence

- Select a Recurrence option with the \leftarrow/\rightarrow keys.

◀ Daily ▶

The Recurrence setting indicates when the scheduled recording will take place or repeat.

Once (No Repeat) - One time recording, specify a Time, Date, etc. This event is deleted after the recording.

Daily - The recording is repeated every day and the date setting is ignored.

Weekly - The recording is repeated once each week on the day specified in the Start and End times.

Setting the Quality Mode

- Specify the Recording Quality mode you wish to use for the recording with the \leftarrow/\rightarrow keys. (➡ page 51)

◀ SP(2hours) ▶

Saving the Schedule

- Select **Add** and press **ENTER** to add the entry to the schedule list when all parameters are set. To Cancel adding a new schedule, use \rightarrow to move to the Cancel field and press **ENTER**.
- To exit the Schedule Screen, press **REC MENU**.

Editing a Saved Schedule

- To change a recording schedule, press the **REC MENU** key to access the Schedule Screen.

Schedule		Feb 12, 2005 - 08:00PM		
No.	Starting time	Length	Source	Status
1	03/15/05 - 08:00PM	01:00	39	Ready
2	Tue - 02:00PM	01:00	Video 1	Suspend

- Use the \uparrow/\downarrow keys to select the entry you wish to edit.
- Use the \leftarrow/\rightarrow keys to select the Edit Recording icon and press **ENTER**.



- Edit the schedule's settings with the same procedure outlined earlier for new recordings.
- Exit the Schedule Screen at any time by pressing **REC MENU**.

Suspending / Activating a Schedule

Temporarily suspend a recording schedule and then enable it again with the Schedule Screen's Action Menu.

- Press **REC MENU** to access the Schedule Menu.
- Use the \uparrow/\downarrow keys to select the entry you wish to suspend or activate.
- Use the \leftarrow/\rightarrow keys to select the Suspend/Ready icon. If the schedule you selected is currently enabled, press **ENTER** to disable the schedule.



Notice the icon to the left of the schedule number. The **Status** will also change to **Suspend**.

2	Tue - 02:00PM	01:00	Video 1	Suspend
---	---------------	-------	---------	---------

To activate a suspended event, select this icon with the \leftarrow/\rightarrow keys and press **ENTER**.



The icon to the left of the schedule disappears and the **Status** displays **Ready**.

Deleting a Saved Schedule

- Press **REC MENU** to access the Schedule Menu.
- Use the \uparrow/\downarrow keys to select the entry you wish to delete.
- Use the \leftarrow/\rightarrow keys to select the **Delete** icon and press **ENTER**.
- Press **REC MENU** to exit the Schedule Screen.



General

About the SETUP MENU

The DVD Recorder's SETUP MENU is where various settings are configured, including setting the Clock, Recording Options, Playback Options, Languages, Parental Control Settings and more.

Using the SETUP MENU

It's easy to change the recorder's settings with the Setup Menu.

- 1 Press **SETUP** to enter the SETUP MENU.

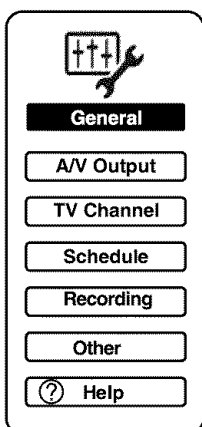

- 2 Use the \blacktriangle / \blacktriangledown keys and press **ENTER** on the desired feature. A sub-menu appears.

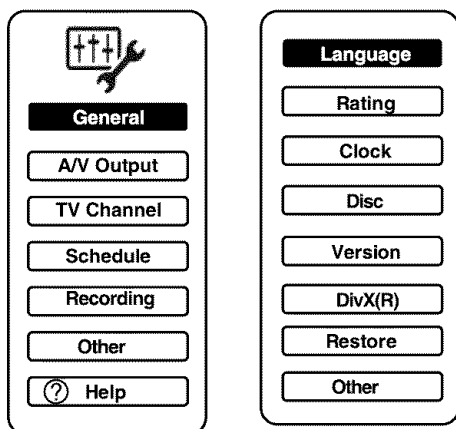

- 3 Select the desired sub features with the \blacktriangle / \blacktriangledown keys and use the \blacktriangleright to navigate.
- 4 To change or select features, use the \blacktriangle / \blacktriangledown and \blacktriangleleft / \blacktriangleright keys to select an option. Press the **RETURN** key to return to a previous level and the **SETUP** key to exit Setup Menu.

Note

- Depending upon the disc, some Setup Menu selections are not available.

General - Language

The DVD Recorder's language setup options include OSD, menu, audio and subtitles.

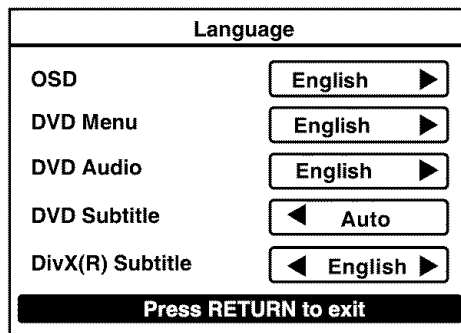

OSD

Default setting: **English**

Set the language to use \blacktriangleleft / \blacktriangleright button. **English** (Default), **Español** and **Français** are supported.

DVD Menu

Default setting: **English**

Sets the default language used by DVD Menus. As an example, if a DVD disc contains multiple menu languages, such as Spanish and English, and this setting is set to Spanish, then the Spanish menu will be used. The DVD must support multiple menu languages for this setting to work. Choices are: **English, Spanish and French.**

- 1 Use \blacktriangle / \blacktriangledown button to select "DVD Menu".
- 2 Press \blacktriangleleft / \blacktriangleright button to change language setting.

DVD Audio

Default setting: **English**

Sets the default audio track used by DVDs. For example, if a DVD disc contains multiple audio tracks, such as Spanish and English, and this setting is set to Spanish, then the Spanish audio track will play as the default. The DVD must support multiple menu languages for this setting to work. Choices are: **English, Spanish and French.**

- 1 Use \blacktriangle / \blacktriangledown button to select "DVD Audio".
- 2 Press \blacktriangleleft / \blacktriangleright button to change language setting.

DVD Subtitle

Default setting: **Auto**

Sets the default subtitle language used by DVDs. For example, if a DVD disc supports multiple subtitle languages, such as Spanish and English, and this setting is set to **Spanish**, then Spanish subtitles will be displayed by default. The DVD must support the language selected for this setting to work. Choices are: **Off, English, Spanish, French and Auto.**

- 1 Use \blacktriangle / \blacktriangledown button to select "DVD Subtitle".
- 2 Press \blacktriangleleft / \blacktriangleright button to change language setting.

General (Continued)

DivX(R) Subtitle

Default setting: **English**

Sets the default subtitle language used by DivX(R) disc. For example, if a DivX(R) disc include multiple subtitle languages, such as Spanish and English, and this setting is set to **Spanish**, then Spanish subtitles will be displayed by default. The DivX(R) disc must support the language selected for this setting to work. Choices are: **Czech, Dutch, English, French, German, Hungarian, Italian, Polish, Spanish, and Swedish.**

- 1 Use ▲/▼ button to select "DivX(R) Subtitle".
- 2 Press ◀/▶ button to change language setting.

General - Rating

Parental Rating	
Password :	<input type="text"/>
Level :	◀ 8. Adult
Change Password :	<input type="text"/>
Press RETURN to exit	

Parental Options

Default setting: **8. Adult**

Your DVD recorder features a Parental Control option. By default, this option is set to the Adult level, which will allow play of all discs. Available options include:

Rating	Description
1. Kid Safe	Suitable for all audiences.
2. G	Suitable for general audiences.
3. PG	Parental guidance suggested.
4. PG 13	Parental guidance suggested, unsuitable for children under 13.
5. PG R	Parental Guidance Recommended - implications or very brief discreet language or situations.
6. R	Restricted, violence, adult language and situation unsuitable for young viewers.
7. NC 17 R	Adult theme or content, not suitable for children under 17.
8. Adult	Adult themes, language and nudity.

Changing the Parental Setting

Parental Rating	
Password :	<input type="text"/>
Level :	◀ 8. Adult
Change Password :	<input type="text"/>
Press RETURN to exit	

- 1 First, you must enter a 4-digit valid password using number buttons. If you have defined your own user password, enter that value. Otherwise, use the factory password: **3351**.
If you input a wrong number, press ◀ key.
- 2 Press **ENTER** and then use the ▼/▲ keys to select a Rating Level
- 3 Press **ENTER**.

Defining and Changing the Password

You can define your own User Password. This is useful to give another party temporary access to the parental control settings.

Change Password	
Old Password:	<input type="text" value="****"/>
New Password:	<input type="text"/>
Confirm Password:	<input type="text"/>
<input type="button" value="Ok"/> <input type="button" value="Cancel"/>	

- 1 Enter the factory password, 3351 in the Old Password field if it is your first attempt to define a user password. After you have defined a user password, you have to enter that value in this field. If you forget your user password, always use the factory password to change the value.
- 2 Enter your new user password in the New Password field.
- 3 Enter your new user password again in the Confirm Password field.
- 4 Press **ENTER**.
- 5 "The Password was changed successfully." message appears. Press **ENTER**.

i Security Note

Remember to keep in mind that since the Master Password is listed above, your player may not be secure if this manual is accessible by your children.

General - Clock

Clock	
Clock Settings	12:01 PM
Date Settings	01/02/05
Press RETURN to exit	

The Time and Date values to determine when to begin and end Scheduled Recordings.

General (Continued)

Clock Settings

- 1 Use the ▲/▼ keys to select a time field.
- 2 Press **ENTER** to edit the time field.
- 3 Use the ▲/▼/ ◀/▶ keys to set the value of the time field.
- 4 Press **ENTER**.
- 5 Press **RETURN** to exit the Clock Settings Menu.

Date Settings

- 1 Use the ▲/▼ keys to select a date field.
- 2 Press **ENTER** to edit the date field.
- 3 Use the ▲/▼/ ◀/▶ keys to set the Month, Day and Year of the date field.
- 4 Press **ENTER**.
- 5 Press **RETURN** to exit the Clock Settings Menu.

General - Disc

DVD-Video Format
DVD-VR Format
New Disc Format
Finalize
Protect Disc
Unfinalize
Physical Format

DVD-Video Format

- Inserting a DVD-RW/R disc.
- 1 Use the ▲/▼ keys to select "DVD-Video Format".
 - 2 Press **ENTER** and below information appear.

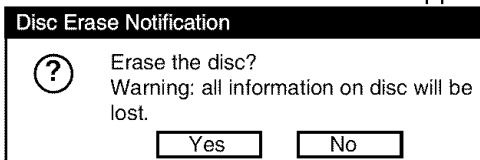

- 3 Use ◀/▶ button to select "Yes". Press **ENTER** and format a DVD-RW/R disc begin.

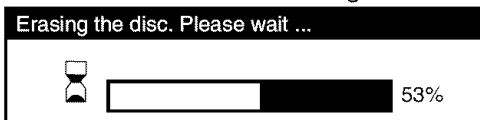

- 4 When finish format, it will appear below information.

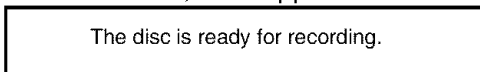

DVD-VR Format

- Inserting a DVD-RW/RAM disc.
- 1 Use the ▲/▼ keys to select "DVD-VR Format".
 - 2 Press **ENTER** and below information appear.

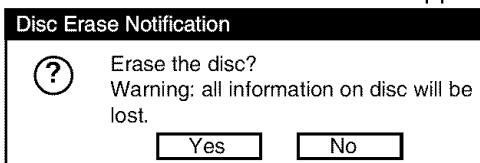

- 3 Use ◀/▶ button to select "Yes", Press **ENTER** and format a DVD-RW/RAM disc begin.

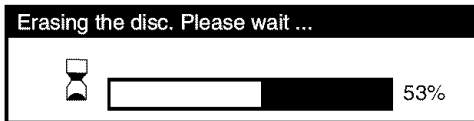

- 4 When finish format, it will appear below information.

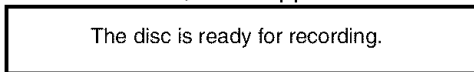

New Disc Format

- 1 Use the ▲/▼ keys to select "New Disc Format".
- 2 Press **ENTER** and then press ◀/▶ to select "VR" or "Video" for DVD-RW.
- 3 Press **RETURN** to exit.

Finalize

To play a DVD-RW/R disc recorded on this unit, you must finalize it to insure compatibility with other DVD players. When you have finished recording,

- 1 Use the ▲/▼ keys to select "Finalize".
- 2 Press **ENTER** to start "Finalize" operation.

Protect Disc

"Protect Disc" function is to protect a disc to prevent the content recorded for VR-Formatted disc.

ON: The disc which have recorded can't be formatted.
 OFF: The disc which have recorded can be still formatted.

- 1 Use the ▲/▼ keys to select "Protect Disc".
- 2 Press **ENTER** to select ON or OFF.

Unfinalize

- 1 Use the ▲/▼ keys to select "Unfinalize".
- 2 Press **ENTER** to start "Unfinalize" operation for DVD-RW disc.

Physical Format

Physical formatting is a simple execution for DVD-RAM which cannot be used or read (or which is becoming hard to read). It may refresh such a disc for recording and playback. (There is no guarantee that all such discs will be recovered.) "DVD-VR format" process only rewrites certain data on file system and management information. However, "physical format" rewrites all data on a disc, therefore it takes a much longer time to complete. For a 4.7GB single sided DVD-RAM, about an hour will be necessary. While processing, all recorder operations and functions including program recording will not work until the process is finished. Also this process erases all data stored on the DVD-RAM disc.

- 1 Use the ▲/▼ keys to select "Physical Format".
- 2 Press **ENTER** and appear below picture.

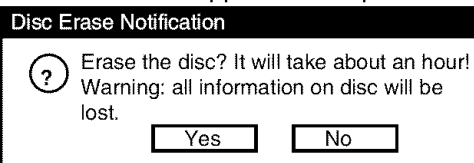

- 3 Use ◀/▶ button to select "Yes" and start "Physical Format".

General (Continued)

General - Version

Displays various versions of the unit.

Version	
Main:	31.3.10.00
Loader:	2000

General - DivX(R)

DivX(R) Video On Demand	
Your registration code is: *****	
To learn more visit: www.divx.com/vod	

Some DivX® Video-On-Demand files required registration code, please get the code of your DVD recorder as follow:

- 1 Press **ENTER** button. Your registration code will be shown.
- 2 Press **SETUP** to exit .

Note

- This registration code is for DivX® Video-On-Demand only, do not apply this code for other applications or websites.

General - Restore

Restore	
This action will restore the factory defaults. Are you sure you want to continue?	
Yes	No
Press RETURN to exit	

Select "Yes" will restore factory defaults to your unit.

General - Other

Other	
Display/Call	On
Press RETURN to exit	

Turn off the screen display.

On: The screen display appears.

Off: Nothing but SETUP MENU and error messages appear.

- 1 Use the ◀ / ▶ keys to select an option.
- 2 Press RETURN to exit.

Note

- Even if "Off" is selected in this menu, the on screen informations appears when **DISPLAY** button is pressed.

A/V Output-Video

Video	
TV Shape	4:3 Letter Box
Still Mode	Automatic
Press RETURN to exit	

TV Shape

Default setting: **4:3 Letter Box**

By default, this option is set for normal TVs with 4:3 aspect ratio. Do not change this setting unless you are using a wide screen TV. The 4:3 Letter Box setting is meant to enable the "Letter box" view on DVDs that contain both Letterbox and Pan/Scan versions. If you are using a wide screen TV, set this option to 16:9 to match the aspect ratio of your TV.

- 1 Use the ◀ / ▶ keys to select an option.
- 2 Press RETURN to exit.

Still Mode

Default setting: **Automatic**

You can set the type of image displayed on the TV screen when the playback of the DVD is stilled. Select the image to be displayed from the below.

Automatic

The field still or frame still is automatically selected. (For normal use.)

Still By Frame

The frame still is set.

- 1 Use the ◀ / ▶ keys to select an option, "Automatic" or "Still By Frame".
- 2 Press RETURN to exit the Video Menu.

A/V Output - Picture

Picture	
Brightness	STD
E.B.L.	On
Press RETURN to exit	

Brightness

Default setting: **STD (STANDARD)**

The brightness can adjust light and dark degree of picture the quality. You can choose MIN, STD or MAX.

- 1 Use the ▲ / ▼ keys to select Brightness.
- 2 Use the ◀ / ▶ keys to select an option.
- 3 Press RETURN to exit the Picture Menu.

AV Output

E.B.L.

Default setting: **On**

You can adjust the black level of the output signal.

Off: Normal black level.

On: To display deeper, richer black than in “Standard” setting.

- 1 Use the ▲/▼ keys to select E.B.L..
- 2 Use the ◀/▶ keys to select an option.
- 3 Press **RETURN** to exit the Picture Menu.

Note:

- The E.B.L Function only works when playback DVD-Video, DVD-RAM, DVD-RW, DVD-R or Video-CDs.

A/V Output - Audio

Audio	
DRC	◀ STD ▶
Digital Output Mode	◀ PCM
Virtual Surround	◀ Off
SAP	◀ Off
Press RETURN to exit	

DRC

Default setting: **STD (STANDARD)**

DRC(Dynamic Range Control) is also called “Midnight Mode” which reduces the variations between loud and soft sounds in DVD movies. This lets you turn the volume down to hear softer sounds and dialog.

- 1 Use the ◀/▶ keys to select TV, STD or MAX.
- 2 Press **RETURN** to exit the Audio Menu.

TV: Dynamic range is reduced.

STD: Full dynamic range is reduced.

MAX: Full dynamic range is maintained.

Digital Output Mode

Default setting: **PCM**

Determines the audio format output by the HDMI and Optical Digital Audio Output. When playing a Dolby Digital 5.1 Soundtrack, set the setting to **Bitstream** to output the coded digital signal to a Digital Receiver with a Dolby Digital 5.1-channel decoder. If your receiver is not capable of decoding a Dolby signal, use the **PCM** setting. When playing CDs, set the setting to **PCM** to output a stereo signal on the Digital Output.

- 1 Use the ◀/▶ keys to select **Bitstream** or **PCM**.
- 2 Press **RETURN** to exit the Audio Menu.

Virtual Surround

This lets you playback discs with acoustic effects having greater depth and presence even when using only two speakers.

Off:Virtual surround effect not activated.

On:Virtual surround effect activated.

Notes

- This function is only activated when playing back a disc recorded with Dolby Digital.
- This function is only activated when “Digital output mode” is set to “PCM” if the Optical output of this DVD recorder is connected to an amplifier or similar device.
- When the virtual surround effect is activated, Dolby Progressive Sound may be deactivated or sound differently than usual.
- When the virtual surround effect is activated, the volume may sound differently than usual.
- Set “Virtual Surround” to “Off” if the audio sounds distorted.

Spatializer® 3-Dimensional Sound Processing provided by Desper Products, Inc.

Certain audio features of this product manufactured under a license from Desper Products, Inc., Spatializer® and the circle-in-square device are trademarks owned by Desper Products, Inc.

- 1 Use the ◀/▶ keys to select “Off” or “On”.
- 2 Press **RETURN** to exit the Audio Menu.

SAP

SAP(Second Audio Program broadcast) is separate audio program, usually broadcast in a second language with the main language.

Off:The main sound is received.

On:SAP sound (second language)is received.

- 1 Use the ◀/▶ keys to select “Off” or “On”.
- 2 Press **RETURN** to exit the Audio Menu.

TV Channel

AUTO SCAN automatically scans for available channels. The unit saves those channels received at sufficient signal strength. This subject was discussed earlier on (▶ page 34). Further topics include skipping/showing channels.

Set Channels

Here is where you can customize your channel list by Skipping or Showing any channel you choose.

- 1 Select the TV channels option from the Setup Menu and press **ENTER**. You will see a list of all possible channels. The Skipped icon to the right of a channel means it was not detected during the AUTOSCAN.

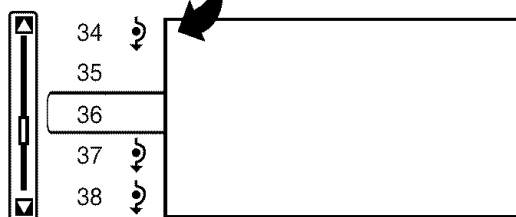

- 2 Use the ▲/▼ keys to select a channel you wish to skip. Press the ▶ key to select the "Skip Item" icon and press **ENTER**. The Skipped icon appears to the right of the channel letting you know that it will no longer be accessible when you scan through the channels with the ▲/▼ keys while watching TV. However, you can select any channel directly with the number keys.

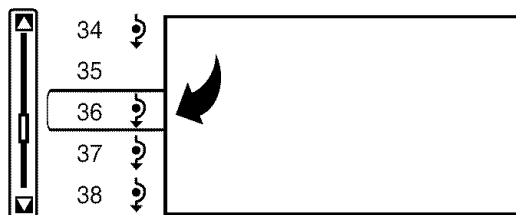

- 3 To show any channel again after it has been skipped, simply select the channel and press the ▶ key to select the "Show Item" icon and press **ENTER**. The Skipped icon is removed.

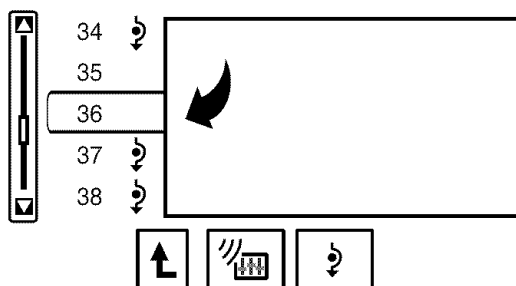

- 4 Press **RETURN** to exit the TV channel Menu.

Schedule

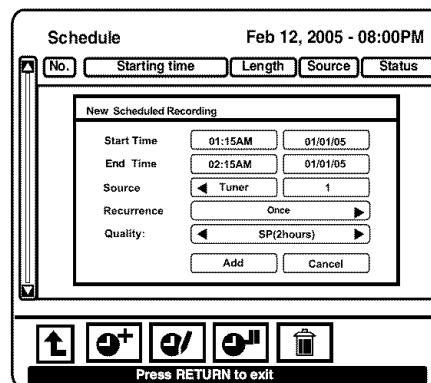

Schedule recording allows automatically record selected program according predefined schedule. The scheduling is done in the Schedule setup menu. (▶ Page 43 and 44)

Recording

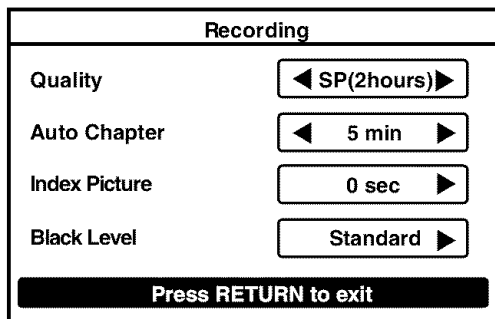

Quality

Default setting: **SP**

The Quality setting determines the quality of your recordings as well as the maximum amount of video you can record on a disc. The hour number next to the quality setting indicates how much content can be recorded to a blank regular 12cm DVD media.

Mode	Quality	Max
XP	High	Approx 1 hour
SP	↑ ↓	Approx 2 hours
MP		Approx 3 hours
LP		Approx 4 hours
SLP	Low	Approx 6 hours

The recording durations listed above are for reference purposes only and are not guaranteed. Recording durations may vary.

- 1 Use the ◀/▶ keys to select the Quality setting you wish to use.
- 2 Press **RETURN** to exit the Recording Menu.

Auto Chapter

Default setting: **5 min**

You can automatically make chapter marks during DVD recordings. You can select the interval from **5 min.**, **10 min.**, or **15 min.**, or turn this feature to **Off**.

- 1 Use the ◀/▶ keys to select an option.
- 2 Press **RETURN** to exit the Recording Menu.

Index Picture

Default setting: **0 sec**

You can set the time that the thumbnail image is registered. You can select the interval from **0 sec.**, **1 min.**, or **3 min.**.

- 1 Use the ◀/▶ keys to select an option.
- 2 Press **RETURN** to exit the Recording Menu.

Black Level

Default setting: **Standard**

Changing DVD recorder's black level during your recording. You can select **Standard (7.5IRE)** or **Enhanced (0IRE)**.

- 1 Use the ◀/▶ keys to select an option.
- 2 Press **RETURN** to exit the Recording Menu.

Other

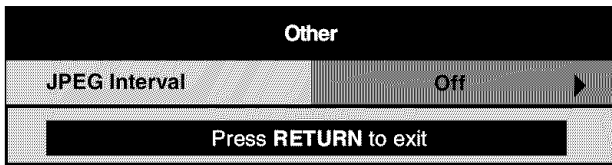

You can select the interval time for JPEG slide show.

- 1 Press ◀ / ▶ keys to select an option. You can set the interval time for JPEG slide show.
 - Off** : Plays back one file at a time.
 - 5 sec.** : Plays back images in the form of a slide show at 5 second intervals.
 - 10 sec.:** Plays back images in the form of a slide show at 10 second intervals.
 - 15 sec.:** Plays back images in the form of a slide show at 15 second intervals.
- 2 Press **RETURN** button to exit the Other Menu.

Help

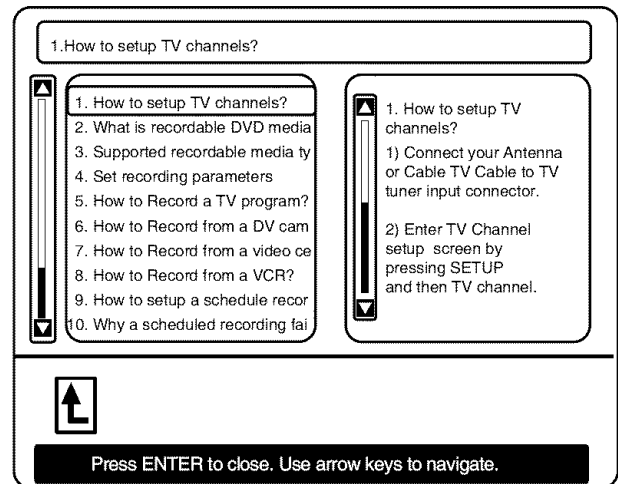

You can use this friendly feature to easily access step-by -step instructions and other helpful information on various subjects related to your unit.

- 1 Use the ▲/▼ keys to select **Help**. Use the ◀/▶ keys to navigate between the windows and the ▲/▼ keys to scroll through content.
- 2 Press **ENTER** to exit the Help Menu .

Before calling service personnel

If you experience any of the following difficulties while using this unit, check the list below before consulting your nearest Toshiba dealer.

Power

■ The power is not turned on.

- The power cord is not connected securely.
→ Connect the power cord securely.

Connection to your TV

■ There is no TV picture.

- The video cable to this recorder and your TV is not connected securely.
→ Connect the video cable to this recorder and your TV securely.
- The input select on your TV is not set properly.
→ Select the input to which this recorder is connected.
- HDMI indicator is not set properly.
→ Press V.OUT button to turn on/off the HDMI indicator. (▶ Page 20)

TV reception

■ There is no picture.

- The antenna cable is not connected securely.
→ Reconnect the antenna cable securely.

■ There is poor reception.

- Channel settings are not completed.
→ Set the channels.
- The antenna cable is not connected securely.
→ Reconnect the antenna cable securely.
- Antenna signal is poor.
→ Consult your dealer for adjustment.

Playback

■ A DVD or CD does not play.

- The format of the recorded data does not correspond to this recorder, or the region number is neither "1" nor "ALL".
→ Check the disc.
- A defective or dirty disc is inside.
→ Change or clean up the disc.

■ During playback, picture noise appears.

- Picture noise may appear in the following cases. It is not a malfunction.
 - There is picture noise in the original recording.
 - Weather and reception conditions may cause noise.
 - The AV recording mode with the low data rate such as "LP" or "SLP" is selected.
 - The image data processing of this recorder cannot follow dynamic movement on the screen. (High video data rate)
 - A physical error has occurred on the DVD disc.

If an error occurs while reading data of a disc, block noises may be produced there. Repeated reading of this location where the error occurred (retry) can decrease the generation of block noise. However, it can also raise the possibility of unintended delays or stops of playback. In order to prevent them, the recorder limits the number of times of retry.

Before calling service personnel (Continued)

Recording

- **Data cannot be recorded on a DVD-RAM disc.**
 - The disc is protected from deleting data.
 - Set the write-protect tab to the opposite of "PROTECT" (➤ page 13).
 - The disc is protected by a PC or the recorder.
 - Disable the protection on the device which protected the disc.
 - The disc space is not sufficient.
 - Delete unwanted data (➤ page 42) or prepare a new disc.
 - The disc is not initialized.
 - Initialize the disc.
 - The disc may contain errors.
 - Complete the physical format on the disc.
 - The physical format on the disc is not completed.
 - Complete the physical format on the disc.

Program

- **Timer programming cannot be completed.**
 - Clock setting has not been completed.
 - Complete the clock setting (➤ page 34, "Time and Date Settings").
 - The programs list is full.
 - Delete some of the timer programs (➤ page 44).
 - When the power goes off, timer programs will be deleted.
 - Check the timer programs and set them again.

Remote control

- **The remote control does not work.**
 - The batteries in the remote control are exhausted.
 - Replace all the batteries in the remote control (➤ page 19, "Preparation of the remote control").
 - The light emitter of the remote control is not pointed at the sensor of this recorder.
 - Point the emitter of the remote control at the sensor of this recorder.
 - The sensor of this recorder is located too far away from the remote control.
 - Operate the remote control within 7 meters (23 ft) from the sensor of this recorder.
 - There are obstacles between the remote control and this recorder.
 - Remove any obstacles.
 - The sensor is disturbed by sunlight or fluorescent light.
 - Change the place of this recorder or shield the light.
 - The remote mode is not appropriate.
 - Adjust the remote mode of the remote control and this recorder.
 - The setting of the TV/DVD selector is not correct.
 - Set the TV/DVD selector to the equipment to operate.

Clock

- **The clock blinks.**
 - Complete the initial setting again (➤ page 34, "Time and Date Settings").
- **The clock does not keep time.**
 - Set the time and date manually (➤ page 34, "Time and Date Settings").

Specification

■ Power requirement during operation

22W

■ Power requirement at standby

1.3W

■ Power supply

120V AC, 60 Hz

■ Mass

3.5kg

■ External dimension

Width 430 x Height 62 x Depth 302mm

■ Incoming channels

TV: 2-69CH, Cable:1-125CH

■ Antenna input/output terminal

VHF/UHF: 75Ω, RF Connector

■ Signal system

Standard NTSC Color TV system

■ Laser

Semiconductor laser, Wavelength: 650nm/780nm

■ Format

DVD-VR format
DVD-Video format

■ Image recording system

MPEG2

■ Sound recording system

AC 3

■ VIDEO input

1.0Vp-p (75Ω), Sync signal negative,
Pin jack x 2 systems, 1 at rear, 1 in front

■ VIDEO output

1.0Vp-p (75Ω), Sync signal negative,
Pin jack x 1 system, 1 at rear

■ S-VIDEO input

(Y) 1.0Vp-p (75Ω), Sync signal negative,
(C) 0.286Vp-p (75Ω), 1 at rear, 1 in front
Mini DIN4 Pin x 2 systems

■ S-VIDEO output

(Y) 1.0Vp-p (75Ω), Sync signal negative,
(C) 0.286Vp-p (75Ω), 1 at rear
Mini DIN4 Pin x 1 system

■ COMPONENT output (Y, P_B, P_R)

Y output (green), 1.0Vp-p (75Ω),
Sync signal negative, Pin jack x 1 system
P_B, P_R output (blue, red), 0.7Vp-p (75Ω)
Pin jack x 1 system each

■ AUDIO input

2.0V (rms), 22kΩ or above, pin jack
(L, R) x 2 systems
1 at rear, 1 in front

■ AUDIO output

2.0V (rms), 2.2kΩ or below, pin jack
(L, R) x 1 systems
2 at rear

■ DIGITAL AUDIO OUTPUT

BITSTREAM/PCM (OPTICAL terminal)
Optical connector x 1 system

■ HDMI output

This is for connection of an HDMI cable

■ DV input

4-pin X 1 in front

■ Remote control

Wireless remote control (SE-R0218)

■ Operating conditions

Temperature: 41°F ~ 95°F (5°C ~ 35°C),
Position: Horizontal

■ Clock display

12 hour digital display

■ Clock accuracy

Quartz (monthly deviation: approximately ± 30 seconds)

- This model complies with the above specifications.
- Designs and specifications are subject to change without notice.
- This model may not be compatible with features and/or specifications that may be added in the future.
- The screen illustrations used in this Owner's Manual are for reference purposes only. Because the screen illustrations used in this Owner's Manual are simplified for easy recognition, they may vary slightly from the unit's actual screen displays.

Limited Warranty

Limited United States Warranty

Digital Audio Video ("DAV") Product-Depot Repair Warranty

Toshiba America Consumer Products, L.L.C., ("TACP") makes the following limited warranties to original consumers in the United States. THESE LIMITED WARRANTIES EXTEND TO THE ORIGINAL CONSUMER PURCHASER OR ANY PERSON RECEIVING THIS DAV PRODUCT AS A GIFT FROM THE ORIGINAL CONSUMER PURCHASER AND TO NO OTHER PURCHASER OR TRANSFEREE.

DAV PRODUCTS PURCHASED IN THE U.S.A. AND USED ANYWHERE OUTSIDE OF THE U.S.A., INCLUDING, WITHOUT LIMITATION, CANADA AND MEXICO, ARE NOT COVERED BY THESE WARRANTIES.

DAV PRODUCTS PURCHASED ANYWHERE OUTSIDE OF THE U.S.A., INCLUDING, WITHOUT LIMITATION, CANADA AND MEXICO, AND USED IN THE U.S.A., ARE NOT COVERED BY THESE WARRANTIES.

Limited Ninety (90) Day Warranty on Labor*

TACP warrants this DAV Product and its parts against defects in materials or workmanship for a period of ninety (90) days after the date of original retail purchase. DURING THIS PERIOD, TACP WILL, AT TACP'S OPTION, REPAIR OR REPLACE A DEFECTIVE PART WITH A NEW OR REFURBISHED PART WITHOUT CHARGE TO YOU FOR PARTS OR LABOR.

Limited One (1) Year Warranty on Parts*

TACP further warrants the parts in this DAV Product against defects in materials or workmanship for a period of one (1) year after the date of original retail purchase. DURING THIS PERIOD, TACP WILL, AT TACP'S OPTION, REPAIR OR REPLACE A DEFECTIVE PART WITH A NEW OR REFURBISHED PART WITHOUT CHARGE TO YOU FOR THE PART, PROVIDED THAT IF A DEFECTIVE PART IS REPAIRED OR REPLACED AFTER NINETY (90) DAYS FROM THE DATE OF ORIGINAL RETAIL PURCHASE, THE CONSUMER SHALL PAY ALL LABOR CHARGES INVOLVED IN THE REPAIR OR REPLACEMENT THEREOF.

*Rental Units

The warranty for DAV Product rental units begins on the date of the first rental or thirty (30) days after the date of shipment to the rental firm, whichever comes first.

*Commercial Units

DAV Products sold and used for commercial purposes have a limited warranty for all parts and labor, which warranty begins on the date of original retail purchase and ends on the date that is ninety (90) days thereafter.

Owner's Manual and Product Registration Card

Read this owner's manual thoroughly before operating this DAV Product.

Complete and mail the enclosed product registration card or register your DAV Product on-line at www.tacp.toshiba.com/service as soon as possible. By registering your DAV Product you will enable TACP to bring you new products specifically designed to meet your needs and help us to contact you in the unlikely event a safety notification is required under the Consumer Product Safety Act. Failure to complete and return the product registration card does not diminish your warranty rights.

Your Responsibility

THE ABOVE WARRANTIES ARE SUBJECT TO THE FOLLOWING CONDITIONS:

- (1) You must retain your bill of sale or provide other proof of purchase.
- (2) All warranty servicing of this DAV Product must be made by the Depot Warranty Repair Center specified by the TACP Consumer Solutions Center.
- (3) The warranties from TACP are effective only if the DAV Product is purchased and operated in the Continental U.S.A. or Puerto Rico.
- (4) Labor service charges for set installation, setup, adjustment of customer controls and installation or repair of antenna systems are not covered by this warranty. Reception problems caused by inadequate antenna systems are your responsibility.
- (5) Warranties extend only to defects in materials or workmanship as limited above and do not extend to any DAV Product or parts that have been lost or discarded by you or to damage to DAV Product or parts caused by fires, misuse, accident, Acts of God, such as lightning or fluctuations in electric power, improper installation, improper maintenance or use in violation of instructions furnished by TACP; use or malfunction through simultaneous use of this DAV Product and connected equipment; or to units that have been modified or had the serial number removed, altered, defaced, or rendered illegible.

Limited Warranty (Continued)

How to Obtain Warranty Services

If, after following all of the operating instructions in this manual and checking the section “Before calling service personnel”, you find that service is needed:

- (1) For instructions on how to obtain warranty service for your DAV Product, contact TACP’s Consumer Solution Center toll-free at 1-800-631-3811.
- (2) You must include a copy of original bill of sale or other proof of purchase along with the entire DAV Product to the Depot Warranty Repair Center specified by the TACP Consumer Solutions Center. You are responsible for all inbound transportation and insurance charges for the DAV Product to the Depot Warranty Repair Center specified by the TACP Consumer Solutions Center.

For additional information, visit TACP’s web site:
www.tacp.toshiba.com.

ALL WARRANTIES IMPLIED BY THE LAW OF ANY STATE OF THE U.S.A., INCLUDING THE IMPLIED WARRANTIES OF MERCHANTABILITY AND FITNESS FOR A PARTICULAR PURPOSE, ARE EXPRESSLY LIMITED TO THE DURATION OF THE LIMITED WARRANTIES SET FORTH ABOVE. WITH THE EXCEPTION OF ANY WARRANTIES IMPLIED BY THE LAW OF ANY STATE OF THE U.S.A. AS HEREBY LIMITED, THE FOREGOING WARRANTY IS EXCLUSIVE AND IN LIEU OF ALL OTHER WARRANTIES, GUARANTEES, AGREEMENTS, AND SIMILAR OBLIGATIONS OF TACP WITH RESPECT TO THE REPAIR OR REPLACEMENT OF ANY PARTS. IN NO EVENT SHALL TACP BE LIABLE FOR CONSEQUENTIAL OR INCIDENTAL DAMAGES (INCLUDING, BUT NOT LIMITED TO, LOST PROFITS, BUSINESS INTERRUPTION, OR MODIFICATION OR ERASURE OF RECORDED DATA CAUSED BY USE, MISUSE OR INABILITY TO USE THIS DAV PRODUCT).

No person, agent, distributor, dealer or company is authorized to change, modify or extend the terms of these warranties in any manner whatsoever. The time within which an action must be commenced to enforce any obligation of TACP arising under the warranty or under any statute, or law of the United States or of any state thereof, is hereby limited to ninety (90) days from the date you discovered or should have discovered, the defect. This limitation does not apply to implied warranties arising under state law.

THIS WARRANTY GIVES YOU SPECIFIC LEGAL RIGHTS AND YOU MAY ALSO HAVE OTHER RIGHTS WHICH MAY VARY FROM STATE TO STATE IN THE U.S.A. SOME STATES OF THE U.S.A. DO NOT ALLOW LIMITATIONS ON HOW LONG AN IMPLIED WARRANTY LASTS, WHEN AN ACTION MAY BE BROUGHT, OR THE EXCLUSION OR LIMITATION OF INCIDENTAL OR CONSEQUENTIAL DAMAGES, SO THE ABOVE PROVISIONS MAY NOT APPLY TO YOU UNDER SUCH CIRCUMSTANCES.

Introduction

Connections

Quick Start
Guide

Playback

Recording

Setup Menu

Others

Limited Warranty (Continued)

TOSHIBA



- IMPORTANT - CANADIAN WARRANTY INFORMATION GARANTIE CANADIENNE

STANDARD WARRANTY
TYPE OF SET

DVD Player
DVD/VCR Combination
Home Theatre in a Box
DVD Recorder
Portable DVD

GARANTIE NORMALE
TYPE D'APPAREIL

Lecteur DVD
DVD/magnétoscope combo
Cinéma maison dans une boîte
Enregistreur DVD
DVD Portatif

WARRANTY PERIOD

12 MONTHS

DURÉE DE LA GARANTIE:

12 MOIS

CANADIAN WARRANTY

Toshiba of Canada Limited (TCL) makes the following limited warranties to original consumers in Canada. Please retain your "Bill of Sale" as proof of purchase. **To obtain a "Canadian Warranty" please register online at www.toshiba.ca**

GARANTIE CANADIENNE

1) Toshiba du Canada Limitée (TCL) offre au Canada les garanties limitées suivantes aux consommateurs originiaux. Veuillez conserver votre « facture » comme preuve d'achat. **Pour obtenir une garantie canadienne, veuillez vous inscrire en ligne à www.toshiba.ca**

Canadian Warranty Information

Should service be required on this unit during the one year warranty period, TCL's option will be to repair or exchange the defective unit. It will be necessary to follow this procedure:

Contact: Toshiba of Canada Limited at the Consumer Electronics Group, customer support line.

Phone: 1-800-268-3404

Email: ceg_customer_support@toshiba.ca

All in-warranty repairs must be made by an authorized TCL service centre.

For service exchange TCL will arrange to have the unit picked up by courier and a replacement unit will be returned via same courier. (Note: A major credit card number will be required as a charge of \$25.00 will apply if no fault is found with the unit.)

During the first 3 months of ownership, a new unit will be supplied as a replacement. During the remainder of the warranty period a service-renewed unit will be supplied.

The original "Bill of Sale" must be provided as proof of purchase (it will be returned with the replacement unit.)

This 12-month warranty will be strictly adhered to

Out of warranty units should be repaired by a TCL authorized service centre.

Note: It is the responsibility of the owner to ensure proper packaging. Should damage in shipping occur, due to poor packaging, a charge back for the repair will result. This warranty applies to the original purchaser only and is not transferable.

This warranty does not apply to sets that have been subjected to misuse, neglect, accident, physical damage or acts of nature.

Sets with the serial number removed, altered, replaced or defaced will not be covered by this warranty.

The warranties from TCL are effective only if the product is purchased in Canada from an authorized TCL dealer and operated in Canada.

Products utilized for rental or commercial purposes are not covered by this warranty.

This warranty is in lieu of all other warranties, guaranties or agreements, whether expressed or implied, and no person, agent distributor, dealer, service centre or company is authorized to change, modify or extend its terms in any manner whatsoever.

Information sur la garantie Canadienne

Si vous avez besoin de service sur cet appareil au cours de l'année de garantie, Toshiba du Canada Limitée aura l'option de réparer ou échanger l'appareil défectueux. Vous devrez suivre la procédure suivante:

Contact: Toshiba du Canada Limitée au Groupe Électronique aux consommateurs, service à la clientèle.

Tél: 1-800-268-3404

Courriel: ceg_customer_support@toshiba.ca

Toutes les réparations au cours de la garantie doivent être faites par un centre de service autorisé Toshiba.

Pour un échange TCL s'assurera qu'un service de courrier ramassera l'unité et qu'un appareil de remplacement soit expédié par le même service de courrier.

(Note: Un numéro de carte de crédit sera requis car une charge de 25,00\$ sera appliquée si toutefois l'appareil n'avait aucun problème de fonctionnement.)

Une nouvelle unité sera fournie comme remplacement durant les premiers 3 mois de propriété. Par contre durant la balance de la garantie une unité remise à neuf sera fournie.

La «facture» originale doit être fournie comme preuve d'achat (elle vous sera retournée avec l'unité de remplacement.)

Cette garantie de 12 mois sera strictement adhérente

Les unités hors de garantie devraient être réparées par un centre de service autorisé Toshiba.

Note: C'est la responsabilité du propriétaire de s'assurer que l'emballage est adéquat. Vous serez facturé pour toutes réparations causées par des dommages encourus à cause d'un emballage non adéquat.

Cette garantie est octroyée à l'acheteur initial et n'est pas transférable. Cette garantie ne s'applique pas aux appareils qui ont été sujets aux abus, négligences, accidents, dommages physiques ou actes naturels.

Les appareils dont le numéro de série a été enlevé, altéré, remplacé ou barbouillé ne sont pas couverts par cette garantie.

Les garanties de TCL sont valides seulement sur les unités sont achetées et utilisées au Canada d'un marchand autorisé TCL.

Cette garantie ne couvre pas les produits de location ou à usage commercial. Cette garantie remplace toutes autres garanties ou ententes exprimées ou sous-entendues. Aucune personne, agent, distributeur, concessionnaire ou compagnie n'est autorisé à changer, modifier ou prolonger les termes de cette garantie de quelque façon que ce soit.