

HITACHI Instruction Manual

Hi8

Hi8 Video Camcorder

**VM-H765LA
VM-H665LA****8**

8mm Video Camcorder

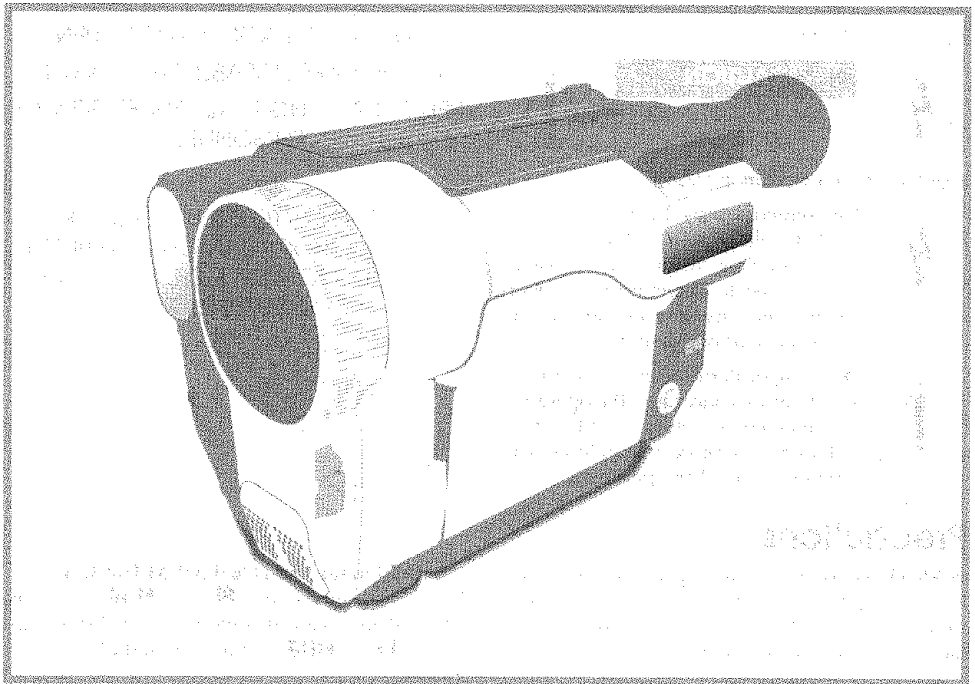
**VM-E565LA
VM-E563LA
VM-E465LA****HITACHI AMERICA, LTD.
HOME ELECTRONICS DIVISION**

1855 Dornoch Court
San Diego, CA 92173
Tel. 1-800-HITACHI
(1-800-448-2244)

**HITACHI CANADA LTD.
DIGITAL MEDIA DIVISION**

6740 Campobello Road
Mississauga, Ontario L5N 2L8
CANADA
Tel. 1-800-HITACHI
(1-800-448-2244)

Thank you for buying a Hitachi product. Please take time to become familiar with the manual and how it is set up. Keep it handy for future reference.

Important Information

For Your Safety

The CAM/OFF/VIDEO switch turns the camcorder on and off, leaving the date/time feature unaffected. If the unit is to be left unattended for a long period of time, turn the camcorder off and close the lens door.

WARNING : TO PREVENT FIRE OR SHOCK HAZARD, DO NOT EXPOSE THIS UNIT TO RAIN OR MOISTURE.

WARNING : TO PREVENT FIRE OR SHOCK HAZARD, USE THE RECOMMENDED ACCESSORIES ONLY.

The camcorder and AC adaptor have the following caution marks.



Identifications of caution marks



This symbol warns the user that un-insulated voltage within the unit may have sufficient magnitude to cause electrical shock. Therefore, it is dangerous to make any kind of contact with any inside part of this unit.



This symbol alerts the user that important literature concerning the operation and maintenance of this unit has been included. Therefore, it should be read carefully to avoid any problems.

CAUTION; TO REDUCE THE RISK OF ELECTRIC SHOCK, DO NOT OPEN. NO USER-SERVICEABLE PARTS INSIDE. REFER SERVICING TO QUALIFIED SERVICE PERSONNEL.





WARNING: TO PREVENT FIRE OR ELECTRIC SHOCK, MATCH WIDE BLADE OF PLUG TO WIDE SLOT, AND FULLY INSERT PLUG.

Precautions

WARNING: Many television programs and films are copyrighted. In certain circumstances, copyright law may apply to private in-home videotaping of copyrighted materials.

This Class B digital apparatus complies with Canadian ICES-003.

The liquid crystal display (LCD) panel is made by highly precise technology. More than 99.99% of its picture elements (pixels) are effective, but some (less than 0.01%) may appear as colored bright dots. This does not indicate a fault as the LCD panel stretches the limits of current technology.

Information for VM-H765LA/VM-H665LA
This camcorder can use  and  video cassettes. It automatically determines the loaded cassette is  or  and records and plays it back correctly.

Warning: This device complies with Part 15 of the FCC Rules. Operation is subject to the following two conditions: (1) This device may not cause harmful interference, and (2) this device must accept any interference received, including interference that may cause undesired operation.

Note: This equipment has been tested and found to comply with the limits for a Class B digital device, pursuant to Part 15 of the FCC Rules. These limits are designed to provide reasonable protection against harmful interference in a residential installation. This equipment generates, uses, and can radiate radio frequency energy and, if not installed and used in accordance with the instructions, may cause harmful interference to radio communications. However, there is no guarantee that interference will not occur in a particular installation. If this equipment does cause harmful interference to radio or television reception, which can be determined by turning the equipment off and on, the user is encouraged to try to correct by one or more of the following measures:

- Reorient or relocate the receiving antenna.
- Increase the separation between the equipment and receiver.
- Connect the equipment into an outlet on a circuit different from that to which the receiver is connected.
- Consult the dealer or an experienced radio/TV technician for help.

Caution to the user: Changes or modifications not expressly approved by the manufacture could void the user's authority to operate the equipment.

Notes

- This unit uses 8mm video format cassettes.
- It records and plays back in the SP mode (14.3 mm/sec).
- It cannot record and play back in the LP mode (7.2 mm/sec).
- VM-H765LA uses a Hi-Fi stereo sound system. When a tape recorded by this camcorder is played by a conventional 8mm camcorder, monaural sound is output. When a tape recorded by a conventional 8mm camcorder is played this machine, monaural sound is output.

MOISTURE

Avoid operating your camcorder immediately after moving it from a cold place to a warm, humid place. Give the camcorder 2 to 3 hours to stabilize in the ambient conditions of the surroundings before inserting a cassette. When moved from a cold place to a warm, humid place, moisture may condense on the head drum inside the machine. This moisture could cause the tape to stick to the headwheel and damage the headwheel or tape.

When a small amount of moisture is sensed, "TAPE" flashes in the viewfinder or on the LCD monitor. Remove the cassette and set the CAM/OFF/VIDEO switch to OFF, then wait for about one hour.

IMPORTANT SAFEGUARDS

In addition to the careful attention devoted to quality standards in the manufacture of your video product, safety is a major factor in the design of every instrument. But, safety is your responsibility too.

This page lists important information that will help to assure your enjoyment and proper use of a Video camcorder and accessory equipment. Please read it carefully before operating your video product and keep it in a handy place for future reference.

INSTALLATION

1 Read and Follow Instructions — All the safety and operating instructions should be read before the video product is operated. Follow all operating and use instructions.

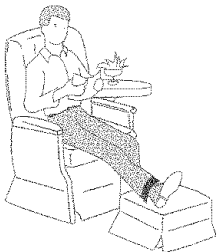

2 Retain Instructions — The safety and operating instructions should be retained for future reference.

3 Heed Warnings — Comply with all warnings on the video product and in the operating instructions.

4 Polarized Plug — This video product is equipped with a polarized alternating-current line plug (a plug having one blade wider than the other). This plug will fit into the power outlet only one way. This is safety feature. If you are unable to insert the plug fully into the outlet, try reversing the plug. If the plug should still fail to fit, contact your electrician to replace your obsolete outlet. To prevent electric shock do not use this polarized plug with an extension cord, receptacle or other outlet unless the blades can be fully inserted without blade exposure. If you need an extension, use a polarized cord.



5 Power Sources — This video product should be operated only from the type of power source indicated on the marking label. If you are not sure of the type of power supply to your home, consult your video dealer or local power company. For video products intended to operate from battery power, or other sources, refer to the operating instructions.

6 Overloading — Do not overload wall outlets and extension cords as this can result in a risk of fire or electric shock. Overloaded AC outlets and extension cords are dangerous, and so are frayed power cords, damaged or cracked wire insulation and broken plugs. They may result in a shock or fire hazard. Periodically examine the cord and have it replaced by your service technician if appearance indicates damage or deteriorated insulation.

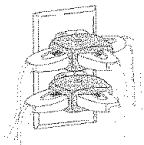

7 Power-Cord Protection — Power-supply cords should be routed so that they are not likely to be walked on or pinched by items placed upon or against them, paying particular attention to cords at plugs, convenience receptacles, and the point where they exit from the appliance.

8 Ventilation — Slots and openings in the cabinet are provided for ventilation to ensure reliable operation of the video product and to protect it from overheating. These openings must not be blocked or covered. The openings should never be blocked by placing the video product on a bed, sofa, rug, or other similar surface. This video product should never be placed near or over a radiator or heat register. This video product should not be placed in a built-in installation such as a bookcase or rack unless proper ventilation is provided or the video product manufacturer's instructions have been followed.

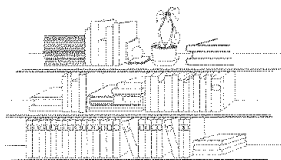

9 Attachments — Do not use attachments unless recommended by the video product manufacturer as they may cause hazards.

Caution: Maintain electrical safety. Powerline operated equipment or accessories connected to this unit should bear the UL listing mark or CSA certification mark on the accessory itself and should not have been modified so as to defeat the safety features. This will help avoid any potential hazard from electric shock or fire. If in doubt, contact qualified service personnel.

10 Water and Moisture — Do not use this video product near water — for example, near a bath tub, wash bowl, kitchen sink, or laundry tub, in a wet basement, or near a swimming pool, and the like.

11 Accessories — Do not place this video product on an unstable cart, stand, tripod, bracket, or table. The video product may fall, causing serious injury to a child or adult, and serious damage to the appliance. Use only with a cart, stand, tripod, bracket, or table recommended by the manufacturer, or sold with the video product. Any mounting of the product should follow the manufacturer's instructions, and should use a mounting accessory recommended by the manufacturer.

11A An appliance and cart combination should be moved with care. Quick stops, excessive force, and uneven surfaces may cause the appliance and cart combination to overturn.



12 Power Lines -- An outside antenna system should not be located in the vicinity of overhead power lines or other electric light or power circuits, or where it can fall into such power lines or circuits. When installing an outside antenna system, extreme care should be taken to keep from touching or approaching such power lines or circuits as contact with them might be fatal. Installing an outdoor antenna can be hazardous and should be left to a professional antenna installer.

USE

13 Cleaning -- Unplug this video product from the wall outlet before cleaning. Do not use liquid cleaners or aerosol cleaners. Use a damp cloth for cleaning.

14 Object and Liquid Entry -- Never push objects of any kind into this video product through openings as they may touch dangerous voltage points or short-out parts that could result in a fire or electric shock. Never spill liquid of any kind on the video product.

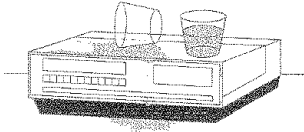

15 Lightning -- For added protection for this video product during a lightning storm, or when it is left unattended and unused for long periods of time, unplug it from the wall outlet and disconnect the antenna or cable system. This will prevent damage to the video product due to lightning and power-line surges.

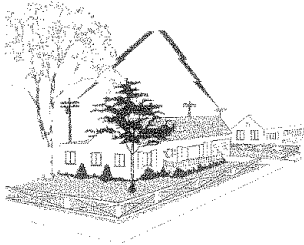

SERVICE

16 Servicing -- Do not attempt to service this video product yourself as opening or removing covers may expose you to dangerous voltage or other hazards. Refer all servicing to qualified service personnel.

17 Conditions Requiring Service -- Unplug this video product from the wall outlet and refer servicing to qualified service personnel under the following conditions.

- When the power-supply cord or plug is damaged.
- If liquid has been spilled, or objects have fallen into the video product.
- If the video product has been exposed to rain or water.
- If the video product does not operate normally by following the operating instructions. Adjust only those controls that are covered by the operating instructions. Improper adjustment of other controls may result in damage and will often require extensive work by a qualified technician to restore the video product to its normal operation.
- If the video product has been dropped or the cabinet has been damaged.
- When the video product exhibits a distinct change in performance -- this indicates a need for service.

18 Replacement Parts -- When replacement parts are required, have the service technician verify that the replacements he uses have the same safety characteristics as the original parts. Use of replacements specified by the video product manufacturer can prevent fire, electric shock or other hazards.

19 Safety Check -- Upon completion of any service or repairs to this video product, ask the service technician to perform safety checks recommended by the manufacturer to determine that the video product is in safe operating condition.

20 Heat -- The product should be situated away from heat sources such as radiators, heat registers, stoves, or other products (including amplifiers) that produce heat.

Before You Begin

Any problems that occur as a result of any of the following conditions will not be covered by our warranty.

- Do not shoot the sun directly. Otherwise, the lens will be faulty.
- Be careful that no water, dust or sand enters the camcorder and all accessories.
- When you shoot at a scene which contains an extremely bright object such as a light source, a bright vertical bar may appear in the picture. Your camcorder is functioning properly, but the solid-state pickup device (C.C.D) usually causes this as an inherent characteristic. Try to avoid shooting an excessive bright object directly.

- Be sure not to leave the camcorder in a place where the temperature exceeds 140°F (60°C), or the pickup device may be damaged. Dangerous includes:

- Inside a car with the windows closed and in direct sunshine.
- Near heating appliances.
- Do not leave the viewfinder lens and the liquid crystal display (LCD) screen facing sunlight for a prolonged period, or the phosphorescent surface of the cathode ray tube and the LCD panel may be damaged.

Read This First

To guide you, we've included:

- An "Important Information" section containing important cautions for your family's safety as well as instruction for getting your video camcorder ready to use. Please read and understand this section thoroughly before moving on.
- A "Getting Started" section to familiarize yourself with the controls and prepare you for recording.
- A "Basic Techniques" section to allow you to use your video camcorder quickly and confidently before advancing to the more sophisticated features of the Hitachi VM-H765LA/VM-H665LA/VM-E565LA/VM-E563LA/VM-E465LA.
- "Advanced Techniques" to help you with some of the exciting, sophisticated features of the Hitachi VM-H765LA/VM-H665LA/VM-E565LA/VM-E563LA/VM-E465LA. We hope you will take the time to learn about these functions since they have been designed for you. You can use the video camcorder without reading this section.
- A "General Maintenance" section to help keep your purchase in good repair.

We want this manual to be as helpful as possible, so it includes two easy ways to find the information you need:

- A quick index for the information you use most often (this page).
- A detailed table of contents directing you to specific information quickly (page 8).

Get to know your video camcorder by using this manual, and get to know Hitachi. We appreciate your business.

Quick Index

Charging the Battery.....	17
Setting the Date and Time.....	26
Making a Basic Recording.....	28
Zooming.....	31
Playback.....	32
Dubbing from Camcorder to VCR.....	52

Features

- Easy to use
- Color liquid crystal display (LCD) monitor with speaker
- Tape analyzer ATRS (for VM-H765LA/VM-H665LA)
- TAPE+ function (for VM-H765LA/VM-H665LA)
- Active screen
- Perfect power (Lithium-ion battery)
- Built-in DC light (for VM-H765LA/VM-E565LA)
- X22 optical zoom ratio
- X100 digital zoom ratio (switchable to X500)
- Digital effects
- Stable pix (Electronic Image Stabilization (EIS)) (VM-H765LA / VM-H665LA / VM-E565LA / VM-E563LA)
- Fade in/fade out
- Recorded date search
- Video effects
- Multi playback (PAL60 conversion)

■ Types of differences

	VM-H765LA	VM-H665LA	VM-E565LA	VM-E563LA	VM-E465LA
System	Hi8	Hi8	8	8	8
Audio	stereo	monaural	monaural	monaural	monaural
Built-in DC light	Yes	No	Yes	No	No
EIS function	Yes	Yes	Yes	Yes	No
Program AE	Auto/Mode select	Auto/Mode select	Auto/Mode select	Auto	Auto

- This instruction manual contains illustrations of VM-H765LA camcorder and displays. Some displays do not appear, depending on the model.

With this camcorder you can view the picture being recorded or the playback picture whether on the LCD monitor or in the viewfinder. Opening or closing the LCD monitor switches the picture to appear on the LCD monitor or in the viewfinder. The following text describes the operation assuming that the viewfinder is used as a major monitor device.

Table of Contents

Important Information	2	Using Auto Focus	30
For Your Safety	2	Using the Power Zoom	31
Important Safeguards	4	Using the Digital Zoom	31
Before You Begin.....	6	Using Macro.....	31
Read This First	6	Playback	32
Features.....	7	Using Still	33
		Using Forward and Reverse Search.....	33
Getting Started			
Components and Accessories.....	9	Advanced Techniques	
Identifying Controls.....	10	Date Recording	35
Loading Clock Battery	13	Using Manual Focus	36
Clock Battery	13	Using x500 Digital Zoom	36
Using the Infrared Remote Control	13	Digital Effects Functions	37
LCD Monitor.....	14	Digital Effects Recording	37
Opening the LCD Monitor	14	Activating Digital Effects Recording.....	38
Adjusting the Brightness of the		Video Effects in Playback Mode.....	39
LCD Screen.....	14	Activating Video Effects Playback	39
Range in which the LCD Monitor can be		Using Digital Fade	40
moved.....	14	Using the PROGRAM AE Button (for VM-	
Active Screen	15	H765LA/VM-H665LA/VM-E565LA)	42
Adjusting the Electronic Viewfinder	15	Using the Backlight Compensation	43
Eyepiece Adjustment	16	Locking the White Balance	43
Adjustment the Hand Strap	16	Using the Electronic Image Stabilizer	
Attaching the Shoulder Strap.....	16	(for VM-H765LA/VM-H665LA/	
Charging the Battery	17	VM-E565LA/VM-E563LA).....	44
Removing the Battery Pack.....	18	Using Quick Edit	44
Reference of Charged Level.....	18	Date Search	45
Charging Time	18	Using Memory	45
Operating Time.....	18	Creating and Recording a Title	46
Checking the Battery's Charge	19	Selecting Stored Title (Prememo)	46
Camcorder Power Sources.....	20	Creating a Title	48
Using Battery Pack	20	Recording Title on a Tape in the	
Using the AC Adaptor.....	20	Camcorder.....	49
Using a Car Battery	21	Recording a Title while Transferring a	
Inserting and Removing Cassettes	22	Tape	49
Inserting a Cassette.....	22	Playing Back Your Recording	
Removing a Cassette	22	on Your TV.....	50
Protecting Recorded Material	22	Connecting to Television (or VCR) with	
Items Selectable with Menu Displays.....	23	Audio/Video Input Jacks	50
Menu selectable in the CAM mode	23	Playing Back Your Recording on the TV	
Menu selectable in the VIDEO mode.....	23	Screen.....	51
How to select items and set them	23	Dubbing from the Camcorder to a VCR.....	52
Remaining Tape	24	Using Audio/Video Dubbing.....	53
Using the Linear Time Counter	24	Multi Playback.....	54
Switching On-Screen Display On/Off	24	TBC (Time Base Corrector) ON or OFF	55
Demonstration Mode	24	Attaching a Wide or Tele Converter Lens..	55
Recording Hi8 Quality Image on Normal		Using the Built-in DC Light	
Tape (for VM-H765LA/VM-H665LA).....	25	(for VM-H765LA/VM-E565LA)	56
Tape Analyzer ATRS (auto tape recording		General Maintenance	
system) (for VM-H765LA/VM-H665LA)....	25	Cleaning the Camcorder Heads	57
Setting the Date and Time	26	Cleaning the Lens and Picture Tube	
		of the Electronic Viewfinder	57
Basic Techniques			
Making a Basic Recording	28	Periodic Maintenance	58
Changing the Angle of the LCD Monitor		Troubleshooting	58
when Recording	29	Specifications	60
Using Instant Review	29	Available Accessories	62

Getting Started







This section guides you through the initial preparation of the camcorder. None of these processes are complex. Set aside some time, relax, and familiarize yourself with this quality instrument.

Enjoy getting to know all about your Hitachi 8mm camcorder. The more comfortable and familiar you are with the machine and its features, the more you can make it do for you. Let's get started!

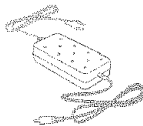
It is crucial that you read and understand all the safety instructions before you begin. If you haven't read the safety instructions yet, please take the time to do so now.

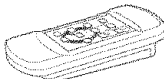
Components and Accessories

Check that you have all the following components and accessories before proceeding.

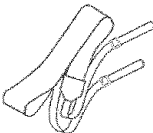
<p>(a) AC adaptor VM-ACE5A</p> 	<p>(b) Battery pack VM-BPL13</p> 	<p>(c) Remote control VM-RME611A Part No. HL11231</p> 	<p>(d) Remote control batteries</p>  <p>AA size</p>
<p>(e) Backup battery CR2025</p>  <p>WARNING: Keep this battery away from children. If swallowed, consult a physician immediately for emergency treatment.</p>	<p>(f) Audio/Video cable Part No. EW12143</p> 	<p>(g) Audio/Video cable Part No. EW10943</p> 	<p>(h) Shoulder strap Part No. TS14621</p> 

	VM-H765LA	VM-H665LA	VM-E565LA	VM-E563LA	VM-E465LA
(a) AC adaptor	●	●	●	●	●
(b) Battery pack	●	●	●	●	●
(c) Remote control	●	●	●	●	●
(d) Remote control batteries	●	●	●	●	●
(e) Backup battery	●	●	●	●	●
(f) Audio/Video cable (Stereo)	●	—	—	—	—
(g) Audio/Video cable (Mono)	—	●	●	●	●
(h) Shoulder strap	●	●	●	●	●

Identifying Controls

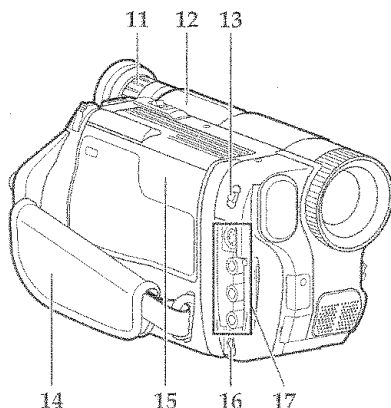
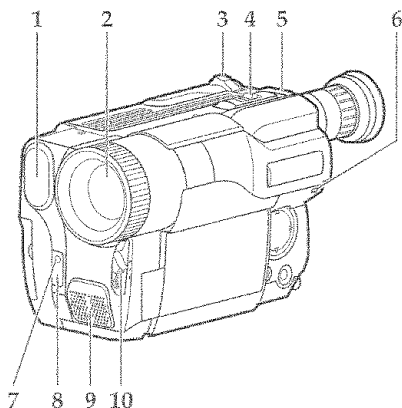

1. Built-in DC Light (p56) (for VM-H765LA/VM-E565LA)

2. Lens Door (p28)

The lens door will open automatically when the camcorder is set to the camera (CAM) mode.

3. Power Zoom Control (p31)

4. Cassette Eject Switch (p22)

5. Shoulder Strap Slot (p16)

6. Charge Indicator (p17)

7. Record Indicator (p28)

8. Infrared Receiver (p14)

9. Microphone

10. CAM/OFF/VIDEO Power Switch (p28)

CAM: Set to this position to record.

VIDEO: Set to this position to play back a tape.

11. Diopter Control (p16)

To adjust the viewfinder eyepiece to suit your eyesight.

12. Electronic Viewfinder (p16)

13. DC Light Switch (p56)
(for VM-H765LA/VM-E565LA)

To switch the DC light between ON, OFF and AUTO.

14. Hand Strap (p16)

15. Cassette Holder (p22)

Insert cassette here.

16. Microphone Jack
(for VM-H765LA/VM-H665LA/
VM-E565LA)

Connect external microphone (not supplied) here.

17. Audio/Video Output Jacks
(Behind the jack cover) (p50)

Connect the provided AV cable from this jack to the AV input jack of your TV or VCR. The jacks on camcorder differ for each model as follows:
VM-H765LA has S-VIDEO jack and stereo audio output jacks.

VM-H665LA has S-VIDEO jack and monaural audio output jack.

VM-E565LA/VM-E563LA/VM-E465LA has monaural audio output jack.

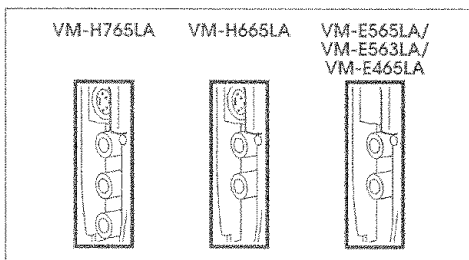

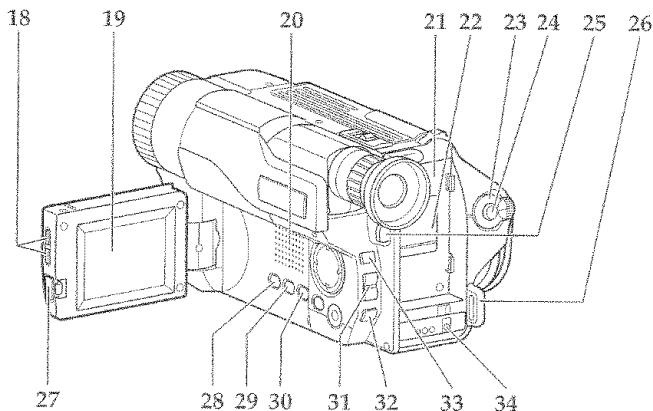

18. LCD Brightness Controls (p14)

19. 2.5-inch LCD Monitor (p14)

20. Speaker (p32)

21. Power Supply Attachment Section (p17)

22. Clock Battery Compartment (p13)

23. Sub Power Switch

STANDBY: Pressing the Start/Stop button will start recording.

LOCK: The camcorder will not enter the record mode even if the Start/Stop button is pressed.

24. Start/Stop Button (p28, 33)

This works as a recording start/stop button in the CAM mode and as a playback pause button in the VIDEO mode.

25. BATT. EJECT Lever (p18)

Sliding, and then holding, this switch, remove the battery from the camcorder.

26. Shoulder Strap Slot (p16)

27. LCD Monitor OPEN Button (p14)

To open the LCD monitor.

28. DATE Button (p26)

To set the date or display it.

29. TITLE Button (p46)

To select or create a title, or display one.

30. EFFECT Button (p37)

To record digitally processed image or play back picture with digital effect added.

31. FOCUS/VOL Control Buttons (p32, 36)

CAM mode: To switch between auto focus and manual focus, or to control focus while in manual focus mode.

VIDEO mode: To control playback volume.

32. BLC (Backlight Compensation) Button (p43)

When recording a subject in bright light, hold this button down to compensate for lighting on tape.

33. MENU Button (p23)

To display the menu.

34. DC IN Jack (p21)

Use this jack to power the camcorder from the AC adapter or from battery in your vehicle.

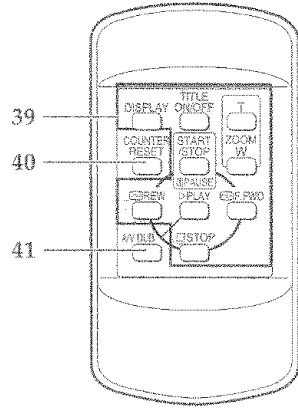
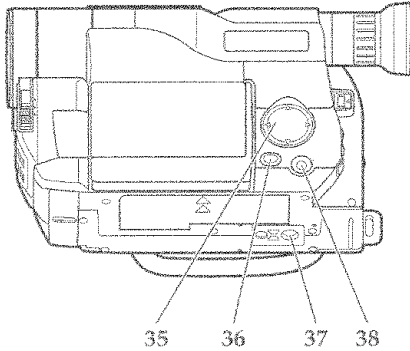

35. Tape Transport and Menu Setting Buttons (p23, 32)

Tape Transport Buttons:

- ▶ PLAY: To play back tape.
- ◀◀ REW: To rewind tape.
- STOP: To stop tape.
- ▶▶ FWD: To fast forward tape.

Menu Setting Buttons:

To select menu items and set details.

36. FADE Button (p40)

To select the desired fade mode.

37. Tripod Mounting Threaded Socket

38. PROGRAM AE Button (p42)

(for VM-H765LA/VM-H665LA/VM-E565LA)
To change the exposure.

REMOTE CONTROL

39. Recorder Remote Control

Same functions as the corresponding buttons on the camcorder.

40. COUNTER RESET Button (only on the remote control) (p45)

To reset the time counter to 0:00:00.

41. A/V DUB Button (only on the remote control) (p53)

To dub audio and video.

Loading Clock Battery

The clock battery backs up any information set in the camcorder: It allows the camcorder to retain the date, time and any other settings when the power source is removed. It has a life span of about a year.

● Clock Battery

Install the battery to prevent misplacing it.

1 Open the clock battery cover.

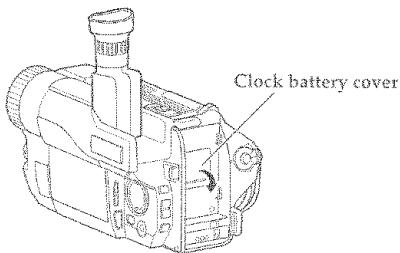

2 Install the battery with "+" terminal facing outwards.

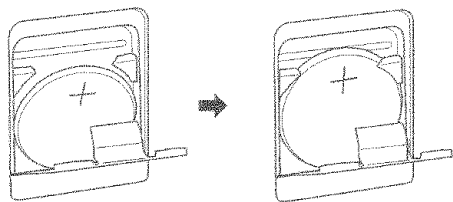

3 Close the cover.

WARNING: KEEP THE BATTERY AWAY FROM CHILDREN AND PETS.

**IF SWALLOWED
CONSULT A PHYSICIAN IMMEDIATELY
FOR EMERGENCY TREATMENT.**

**WARNING: BATTERY MAY EXPLODE IF
NOT HANDLED PROPERLY. DO NOT
RECHARGE, DISASSEMBLE OR DISPOSE
OF IN FIRE.**

Note: Replace the battery with a Hitachi Maxell, Sony, Panasonic, Sanyo or Toshiba battery, part no. CR2025 only. Use of another battery could lead to risk of fire or explosion.

Note: Dispose of battery safely in accordance with local laws. Do not dispose of in fire.

Note: Do not short circuit the battery.

Note: Do not hold the battery with the metallic tweezers.

Note: Keep the battery in a dark, cool, dry place.

Using the Infrared Remote Control

Installing the Remote Control Batteries

The remote control requires two "AA" batteries.

1 Slide the cover in the direction of the arrow to remove it, and then insert the batteries. Be careful to install with correct polarity.

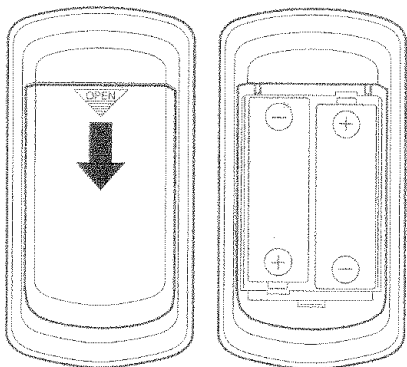

2 Re-attach the cover to the remote control.

Cautions on the batteries

- Do not use the old and new batteries at the same time.
- Do not mix batteries of different types.
- Do not short, take apart or dispose of batteries by throwing them into a fire.
- When liquid leaks, wipe it off completely and then insert new batteries.

Operating Your Camcorder

Use the wireless remote control to operate the camcorder from a distance. The PLAY, F.F, REW, STOP, PAUSE (START/STOP) and ZOOM buttons on the wireless remote control operate the functions of the corresponding buttons on the camcorder. Aim the wireless remote control at the infrared receiver of the camcorder.

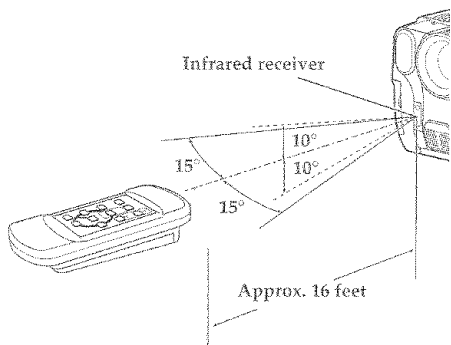

Note: Use the wireless remote control within the range of the infrared receiver of the camcorder shown above.

Note: The wireless remote control may not function in strong light such as direct sunlight or very bright artificial lighting.

Note: Clear a direct path from the wireless remote control to the infrared receiver. The wireless remote control won't work if an obstacle blocks the infrared rays.

Note: The remote control code of this camcorder is Hitachi code VCR2. If you have a VCR with the same code your Hitachi VCR may malfunction when you use the camcorder's wireless remote control.

LCD Monitor

When using the LCD monitor during recording and playback, you can adjust the brightness of its screen and the angle of the monitor.

● Opening the LCD Monitor

- 1 Press the OPEN button to open the LCD monitor.

Note: Opening or closing the LCD monitor switches the picture to appear on the LCD monitor or in the viewfinder.

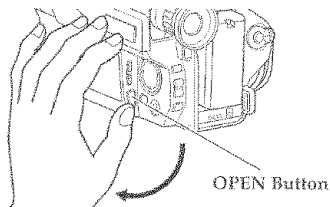

● Adjusting the Brightness of the LCD Screen

Note: Even when the picture on the LCD monitor is adjusted, the recorded video will not change.

- 1 Load the battery. ("Camcorder Power Sources", p20.)
- 2 Press the small button on the CAM/OFF/VIDEO switch as you slide it to CAM or VIDEO.

CAM/OFF/VIDEO Switch

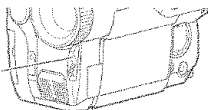

- 3 Use the brightness control buttons to adjust the brightness of the LCD screen. When either button is pressed, the brightness control display will appear on the LCD monitor for about 5 seconds. Press ▲ to increase brightness, or ▼ to

decrease it. After 5 seconds, the adjustment display will automatically disappear.

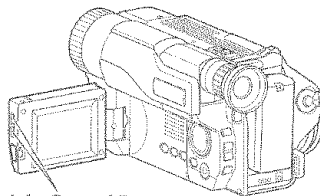

Bright Control Buttons



● Range in which the LCD Monitor can be moved

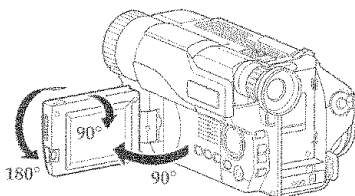

Viewed from Side

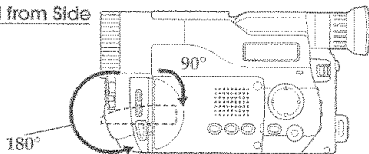

Viewed from Side

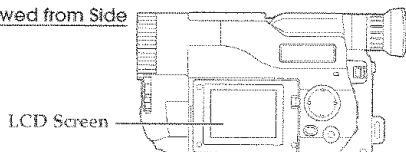

- If the LCD monitor is turned 90° so that it faces the same direction as the lens when the camera signal is being recorded during recording, recording pause, instant review, editing, A/V dubbing or A/V dubbing pause, the image on the monitor screen will become a mirror image, and the viewfinder will turn on. The on-screen display on the LCD monitor will disappear.

Cautions on LCD Monitor Screen

- Do not touch the LCD screen with your fingers as the screen could get dirty and the picture will not be seen clearly. If the LCD screen becomes dirty, use a soft cloth to wipe off the dirt.
- If the camcorder is used in a cold place and becomes too cold, the LCD screen will be dim for a while after the power is turned on. When the temperature inside the camcorder rises, the brightness of the picture will become normal.
- Do not hold by the LCD monitor as this could cause a malfunction.
- Open the LCD monitor by 90° before changing its direction. If you were to attempt to invert its direction before opening it completely, it could cause a malfunction.
- The LCD monitor cannot be closed if it is tilted.
- Close the LCD monitor after making sure it is parallel with the camcorder. If you were to close the monitor while it faces the same direction as the lens or it is diagonal, it could damage the LCD monitor.
- Do not disassemble the LCD monitor as this might cause a malfunction.
- When opening the LCD monitor, be careful that no water droplets adhere the monitor screen and that no water or dust enters the camcorder through the gap as it could cause a malfunction.

Active Screen

The camcorder automatically brightens the backlight of the LCD monitor when you are recording a bright subject outdoors, so that the LCD screen is easy to see.

Note: When you record a bright subject outdoors, the camcorder operating time will be less than when recording indoors.

Note: Even if you record outdoors, the LCD monitor backlight may not brighten, if you are aiming at a dark subject.

Note: While the battery charge indicator "  " is flashing, the Active Screen function will not operate.

Adjusting the Electronic Viewfinder

Adjust the electronic viewfinder to the position of optimum visibility. Place the viewfinder back in its original position before storing the camcorder in its case or carrying the camcorder around to avoid damaging the viewfinder or camcorder.

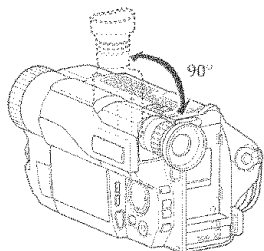

CAUTION:

Do not hold the unit by the electronic viewfinder when carrying as this could cause a malfunction.

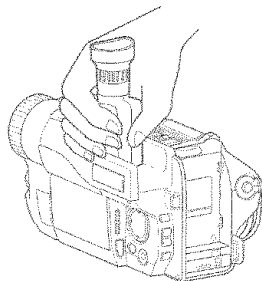

Eyepiece Adjustment

To use the electronic viewfinder, turn the diopter control for your optimum focus adjustment.

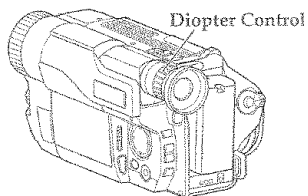

Adjustment the Hand Strap

Adjust the hand strap to best fit your hand.

Note: After adjustment, close the hand strap's pad securely.

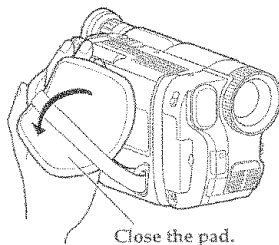

Attaching the Shoulder Strap

Thread the ends of the provided shoulder strap through the slots at the back of the camcorder and thread through the shoulder strap's buckles.

Note: Make sure that the straps are securely fastened before using the shoulder strap to carry the camcorder.

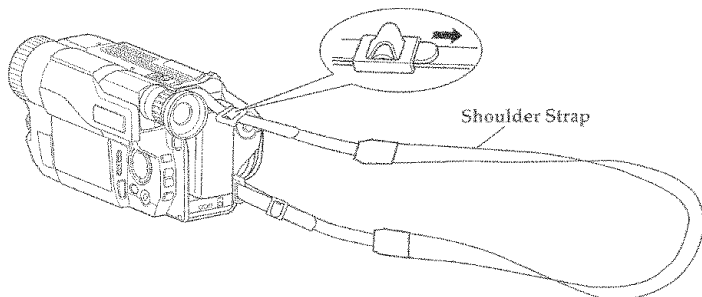

Charging the Battery

The first step is to set the battery for charging. To charge the battery, attach it to the camcorder, and connect the VM-ACE5A AC adaptor. Charge the battery at a temperature range of 50°F (10°C) - 86°F (30°C) to prevent damage to the battery.

Note: This camcorder operates with a lithium ion battery such as VM-BPL13/VM-BPL30/VM-BPL60.

Note: We cannot be responsible for any malfunctions of the camcorder which occur when you use battery packs other than those specified.

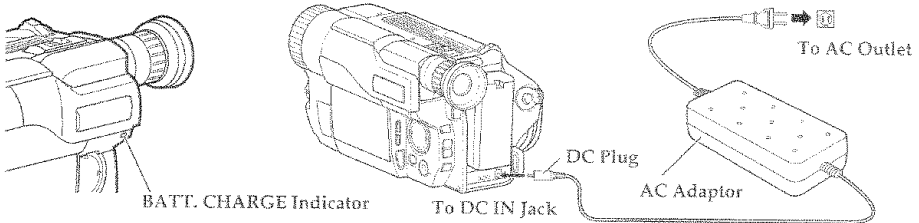

Charge the battery on a flat surface this is free of vibration.

- 1 Make sure the CAM/OFF/VIDEO switch is set to OFF position.

CAM/OFF/VIDEO Switch

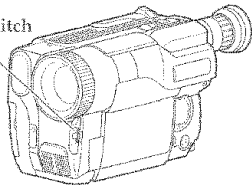

- 2 Attach the battery pack to the camcorder.

- Place the battery on the guide platform and slide it down so that it fits into the camcorder.

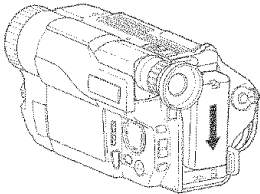

Note: Always attach a battery only by the procedure described here. Attaching a battery forcibly could damage it.

- 3 Plug the AC adaptor power cord into an AC outlet.

Make sure that the wide blade fits into the wide slot. If it doesn't fit, try reversing it. If the blades still do not fit fully into the outlet, either contact an electrician to replace your obsolete outlet, or use a polarized cord or outlet accessory.

- 4 Connect the AC adaptor DC plug to the DC IN jack of the camcorder.

Charging will start within five seconds. During charging, the BATT. CHARGE indicator of the camcorder will flash or light to give you a refer-

ence of the charged level.

Note: If the BATT. CHARGE indicator flashes once every two seconds, the battery could be defective.

Note: The BATT. CHARGE indicator will not light at all when the AC adaptor is defective.

Note: You can use the battery before it is completely charged.

Note: When charging is complete, the BATT. CHARGE indicator on the camcorder will light. If the fully charged battery is removed and then reattached, the camcorder will again enter the charge mode, and the BATT. CHARGE indicator will flash. It will take a few minutes for the camcorder to enter the charge complete status.

Note: Charging at low temperatures will decrease charge capacity.

- 5 After charging is complete, disconnect the AC adaptor DC plug from the camcorder.

- 6 Disconnect the AC plug from the AC outlet.

- 7 Detach the battery from the camcorder.

Note: Always remove the battery from the camcorder after use.

Note: Charging will not be performed when the CAM/OFF/VIDEO switch of the camcorder is set to CAM or VIDEO. However, if recording pause continues for more than 5 minutes in the CAM mode, the camcorder will automatically turn off, after which charging will start. If the sub-power switch is set to LOCK, charging will be performed even when the CAM/OFF/VIDEO switch is set to CAM.

Note: If the DC plug is disconnected when the battery is attached and the CAM/OFF/VIDEO switch is set to CAM or VIDEO, the camcorder will turn off once, but then automatically turn on again. Note that the battery will discharge if the camcorder is left as is.

● Removing the Battery Pack

Slide the BATT. EJECT lever in the direction of the arrow and hold it; then slide the battery to the upper side and remove.

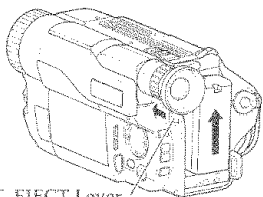

BATT. EJECT Lever

● Reference of Charged Level

You can know the approximate charge level of battery by observing how the BATT. CHARGE indicator of camcorder flashes or lights:

Charge level	BATT. CHARGE indicator
0-50% charge	Flashes once at approx. one-second intervals.
50-75% charge	Flashes twice at approx. one-second intervals.
More than 75% charge	Flashes three times at approx. one-second intervals.
Full charge	Steady light

● Charging Time

Battery	VM-BPL13	VM-BPL30	VM-BPL60
Charging			
Full charge	3h	5h 30 min	9h 50 min
75% charge	1h 50 min	3h 40 min	7h

● Operating Time

The camcorder operating time depends on how often you turn power on/off and use start/stop and zoom.

Continuous Recording

EVF: when using the viewfinder

LCD: when using the LCD monitor

Battery	VM-BPL13	VM-BPL30	VM-BPL60
VM-H765LA			
EVF	2h 40 min	5h 55 min	12h
LCD	2h 15 min	5h	10h 20 min
VM-H665LA			
EVF	2h 45 min	6h 5 min	12h 20 min
LCD	2h 20 min	5h 15 min	10h 40 min
VM-E565LA			
EVF	2h 50 min	6h 15 min	12h 40 min
LCD	2h 25 min	5h 30 min	11h 10 min
VM-E563LA			
EVF	2h 50 min	6h 15 min	12h 40 min
LCD	2h 25 min	5h 30 min	11h 10 min

Battery	VM-BPL13	VM-BPL30	VM-BPL60
VM-E465LA			
EVF	2h 50 min	6h 15 min	12h 40 min
LCD	2h 25 min	5h 30 min	11h 10 min

Typical Recording

EVF: when using the viewfinder

LCD: when using the LCD monitor

Battery	VM-BPL13	VM-BPL30	VM-BPL60
VM-H765LA			
EVF	1h 35 min	3h 30 min	7h 10 min
LCD	1h 20 min	3h	6h 10 min
VM-H665LA			
EVF	1h 40 min	3h 35 min	7h 20 min
LCD	1h 25 min	3h 5 min	6h 20 min
VM-E565LA			
EVF	1h 45 min	3h 45 min	7h 35 min
LCD	1h 30 min	3h 15 min	6h 40 min
VM-E563LA			
EVF	1h 45 min	3h 45 min	7h 35 min
LCD	1h 30 min	3h 15 min	6h 40 min
VM-E465LA			
EVF	1h 45 min	3h 45 min	7h 35 min
LCD	1h 30 min	3h 15 min	6h 40 min

Notes on the Battery

- It is recommended that the battery always be left in the discharged state when not in use, and charged before you use it.
- Avoid storing a fully charged battery, and do not store it in a place where the temperature is high; this will damage the battery.
- Do not operate the battery at temperature below 14°F (-10°C) or above 113°F (45°C). At extremely low temperatures operation time decreases, while at high temperature the battery may be damaged.
- Do not attach a hot battery to the camcorder. Allow it to cool.

THERE ARE NO USER-SERVICEABLE PARTS
INSIDE THE BATTERY
OR AC ADAPTOR.

THROWING THE BATTERY INTO FIRE
OR EXPOSING IT TO EXCESSIVE HEAT
(ABOVE 140°F (60°C))
MAY CAUSE INJURY.

SHORTING THE BATTERY'S TERMINAL
INCREASES RISK OF FIRE OR
ELECTRICAL SHOCK.

Checking the Battery's Charge

A battery charge indicator is located on the upper right corner of the viewfinder or LCD monitor. One of six symbols displays when the battery is used.

Note: The battery charge indicator does not appear when the camcorder is powered by the AC adaptor.

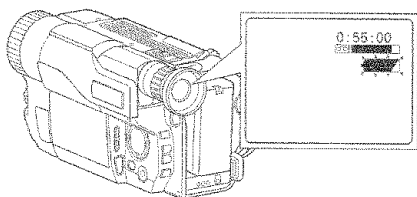

This flashing symbol indicates a battery nearly out of power. Use an alternative power source or charge the battery before continuing to use the camcorder.

Knowing Remaining Battery Power Time

If you use the VM-BPL30 lithium-ion battery (optional) to power the camcorder, you can find out how much camcorder operating time remains, with the battery.

The VM-BPL30 measures the battery consumption, calculates the remaining battery time, and displays it (in minutes) in the viewfinder or on the LCD monitor. Since the camcorder power consumption varies according to how frequently autofocusing or zooming is used, the displayed time may decrease or increase several minutes at a time, or may not change for some time.

Note: The remaining battery time will appear 10-15 seconds after the CAM/OFF/VIDEO switch is set to CAM; it will not appear in the VIDEO position.

Note: When the remaining time decreases to 5 minutes or less, the time display will disappear. We recommend that you replace the battery earlier.

Note: If you connect the VM-BPL30 battery with the remaining battery time of 5 minutes or less, the time will not be displayed.

Note: If the correct remaining time does not appear, use up the battery attached to the camcorder, and then fully charge it.

Note: If you repeat charging and discharging the battery before using it up, the correct remaining time may not be displayed.

Note: If the battery is used at low temperatures, the actual operating time with battery will be substantially different from the displayed time, and the correct time may not appear.

Note: If the battery which has been used at low temperature is subsequently used at normal temperature, display of remaining battery time will be incorrect. For display of correct remaining time, fully charge the battery.

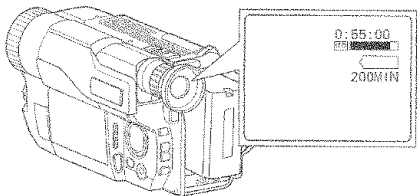

Note: The remaining battery time will not appear when you are recording an image of yourself, or the LCD monitor is put back to camcorder with its screen facing to the side.

Note: If you eject and reinsert cassette after the battery is discharged, power will shut off midway and the camcorder will stop. When the battery is discharged, immediately remove it from the camcorder and charge it again.

Note: When the VM-BPL30 battery is used, the battery charge indicator "□" may not match the remaining battery time display (in minutes). In this case, refer to the remaining time display when using the camcorder.

To display the correct remaining battery time on camcorder

- Fully charge the battery before use.
- Turn the camcorder on and leave it pointing at a still subject for about 30 seconds. Do not move the camcorder during this time.
- If display does not change some time, open and close the LCD monitor while you are using the camcorder.

Camcorder Power Sources

You can use the charged battery pack, AC adaptor (provided) or car battery cord (optional) to power the camcorder. After use, be sure to remove the power supply.

Using Battery Pack

- 1 Attach the charged battery pack to the camcorder. (See pages 17~18 for attachment and charging of battery pack.)

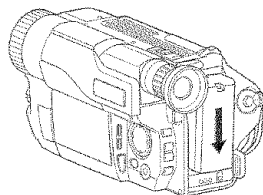

Using the AC Adaptor

Please ensure that the CAM/OFF/VIDEO switch is in the OFF position whenever attaching or detaching any power supply (ie. battery, AC adaptor, etc.).

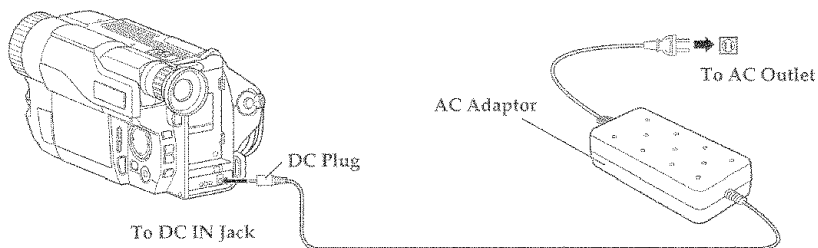

- 1 Plug the AC adaptor power cord into an AC outlet. Make sure that the wide blade fits into the wide slot. If it doesn't fit try reversing it. If you still cannot make fit the blades fully into the outlet either contact an electrician to replace your obsolete outlet, or use a polarized cord or outlet accessory.
- 2 Connect the DC plug of the AC adaptor to the DC IN jack of the camcorder.

Note: The AC adaptor can be used around the world. An AC plug adaptor is required in some foreign countries. If you need one purchase it at your Hitachi distributor.

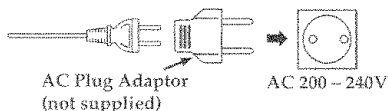

Using a Car Battery

The camcorder can be powered with a car battery by using an optional car battery cord (Hitachi VM-CC80A KIT) to plug the camcorder into the car's cigarette lighter socket. Please ensure that the CAM/OFF/VIDEO switch is in the OFF position whenever attaching or detaching any power supply (ie. battery, AC adaptor, etc.).

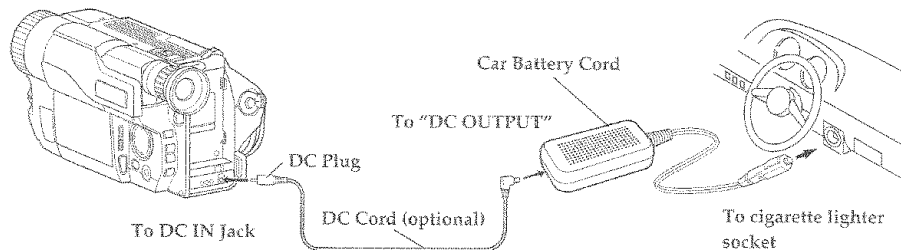

- 1 Plug the car battery cord into the car's cigarette lighter socket.
- 2 Connect one end of the DC cord (optional) to the DC IN jack of the camcorder. Connect the other end of the DC cord to the DC OUTPUT of the car battery cord.

Note: Only use the car battery cord with cars having 12/24 volts negative ground system.

Note: You cannot use the car battery cord to charge a battery.

Note: You need the optional VM-CC80A KIT.

Inserting and Removing Cassettes

A power source must be connected before inserting or removing cassettes. Once connected, cassettes can be inserted or removed whether the CAM/OFF/VIDEO switch is on or off.

● Inserting a Cassette

- 1 Slide the EJECT Switch: The cassette door will open automatically.

Caution: Do not touch the cassette door when a cassette is being loaded or unloaded. If your finger is caught by the metal section of holder, it could be cut.

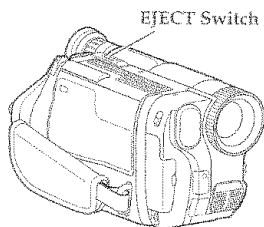

- 2 Place the cassette in the cassette holder so that the transparent window faces away from the body of the camcorder and the sprockets toward the body of the camcorder.

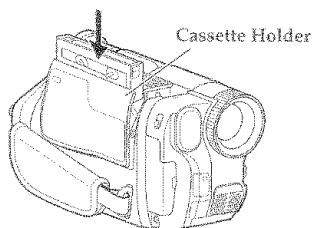

- 3 Push the cassette door, which is embossed PUSH, until it "clicks" into place. The camcorder automatically closes.

Note: The camcorder will automatically close the top of the cassette compartment. Do not press the door down, or you may damage your camcorder.

Note: Take care not to subject the slide-up stage to any impact during tape loading or unloading, or when the cassette holder is open; impact to slide-up stage could result in malfunction.

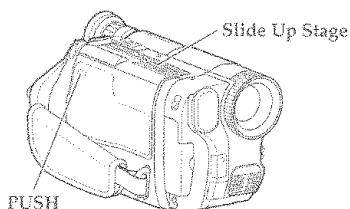

Note: If "TAPE" flashes in the viewfinder or on the LCD monitor, remove the cassette and check that the tape is not damaged, is not slack or no dust adheres to it, etc. After making sure that there is no abnormality, reinsert the cassette. If "TAPE" reappears, see "Troubleshooting" on page 59.

Note: If the tape is near the winding end, it may take longer to load it.

● Removing a Cassette

Slide the EJECT switch and the cassette door will open automatically. Remove the cassette.

● Protecting Recorded Material

Protect 8mm cassettes from accidental erasure by sliding the tab on the side of the cassette toward the opposite side until the tab is completely visible. Slide the tab in the opposite direction, until the tab disappears, to record on the cassette again.

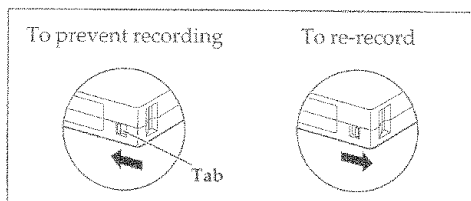

Items Selectable with Menu Displays

The items that can be selected depend on the position of power switch.

Note: The VM-H765LA menu displays are used for the following explanation. Some items do not appear, depending on the model.

● Menu selectable in the CAM mode

When the MENU button is pressed, the following menu display will appear:

To correct camera shake (p44)
(only for VM-H765LA/
VM-H665LA/VM-E565LA/
VM-E563LA).

To lock the white balance
(p43).

To select the digital zoom
mode (p36).

To upgrade normal tape
(p25) (only for VM-H765LA/
VM-H665LA).

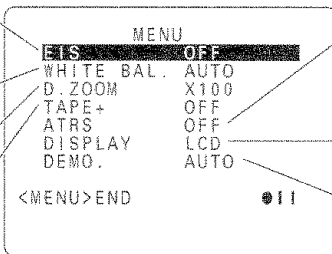

To record in optimum status
to match tape being used
(p25) (only for VM-H765LA/
VM-H665LA).

To turn the on-screen display
on or off (p24).

To select the demonstration
mode (p24)

● Menu selectable in the VIDEO mode

Pressing the MENU button will display the following:

To ensure playback of
stable pictures (p55).

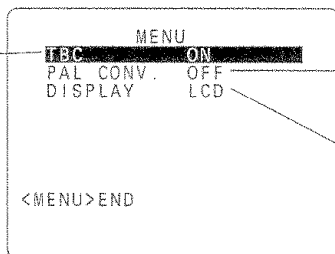

To view tape playback by
connecting the camcorder
to a PAL TV (p54).

To turn the on-screen display
on or off (p24).

● How to select items and set them

- 1 Press the MENU button.
- 2 Press the PLAY or STOP button to select the desired item.
- 3 Use the FF or REW button to select the desired mode.
- 4 Press the MENU button again to determine the mode.

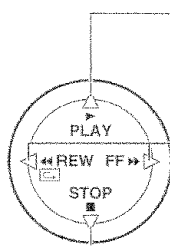

To select an item whose
mode you wish to change.
Press PLAY to move the
cursor up.

To select the mode of the
item you have chosen.

To select an item whose
mode you wish to change.
Press STOP to move the
cursor down.

Remaining Tape

The tape remaining display shows the remaining tape that can be used for recording and playback, using seven dashes. This feature is handy when recording since it lets you know how long you can record on the loaded tape.

Insert a cassette into the camcorder and start recording or playback; 10 seconds later, the remaining tape will be displayed. When the cassette is ejected, the display will disappear. "00-----" is displayed for 10 seconds after the tape starts to run.

Note: The tape remaining display appears 10 seconds after the tape starts to run.

Note: When the remaining tape time becomes

less than about three minutes, "TAPE END" flashes in the viewfinder or on the LCD monitor.

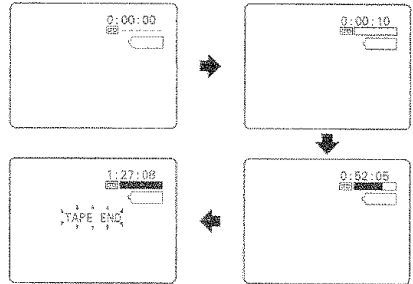

Using the Linear Time Counter

The linear time counter displays the tape run in hours, minutes, and seconds, helping you to keep track of how long you've been filming or time you have left to film before running out of tape.

Turn the camcorder on to display the linear time counter. The linear time counter keeps track from when you load a cassette into the camcorder and clears to "0:00:00" when the cassette is ejected.

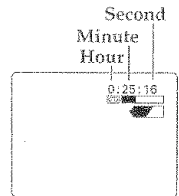

Switching On-Screen Display On/Off

Using menu selection, you can turn off the camcorder status display during recording and playback, and turn it on again afterwards.

1 Set the CAM/OFF/VIDEO switch to CAM.

2 Press the MENU button.

3 Press the PLAY or STOP button to select "DISPLAY".

4 Press the REW or FF button to select the desired mode:

LCD: Information on the tape remaining, time counter, etc. is displayed on the LCD monitor.

LCD/LINE: M is displayed beside the time



counter ("Memory Feature", p45). When LCD/LINE is specified, you can view the information in the memory displayed on the LCD monitor, which will be superimposed on the playback picture seen on the connected TV.

OFF: Information on tape remaining, time counter, etc. is not displayed.

Note: The battery remaining power level will be displayed when you use a battery pack as a power supply.

Note: The date and recording status are displayed on the LCD monitor.

5 Press the MENU button.

Demonstration Mode

Using the menu, you can switch the demonstration mode that is set in this camcorder.

1 Set the CAM/OFF/VIDEO switch to CAM.

2 Press the MENU button.

3 Press the PLAY or STOP button to select "DEMO".

4 Press the REW or FF button to select the desired mode:

AUTO: If you leave the camcorder for 10 minutes without inserting a cassette when no date



has been set, or the clock battery is dead, the demonstration mode will automatically engage.

START: The demonstration mode will start after the MENU button is pressed and START is specified.

OFF: The demonstration mode is off.

5 Press the MENU button.

Note: The demonstration mode will continue until power is turned off, or the MENU button is pressed and "AUTO" or "OFF" is specified.

Recording Hi8 Quality Image on Normal Tape

(for VM-H765LA/VM-H665LA)

Using the menu, you can record on normal 8 mm tape and get picture quality equivalent to **Hi8**.

1 Insert a normal 8 mm tape.

Note: We recommend that you use an HG grade tape.

2 Set the CAM/OFF/VIDEO switch to CAM.

3 Press the MENU button.

4 Press the PLAY or STOP button to select "TAPE+".

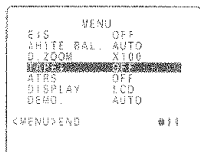

5 Press the Start/Stop button.

Camcorder will automatically judge whether or not upgrade recording is possible with the inserted tape.

Note: It is recommended that you use this camcorder or a Hitachi **Hi8** camcorder to play back the tapes recorded with this function: Other camcorders may not be able to play back those tapes.

Note: "ON" is not specified for the "TAPE+" menu item, with tapes other than normal 8 mm tapes.

Note: The "ON" specification of "TAPE+" will switch to "OFF" automatically when the tape is ejected, or when the power supply is removed without the backup battery for clock being inserted.

Note: When this function is switched to during recording pause, noise may appear in the joint of recordings.

● Tapes used

TAPE+	Tape used	Recording format	Display
ON	Normal 8 mm tape	Upgrade recording	TAPE+
OFF	Normal 8 mm tape	8 mm recording	None
	Hi8 tape	Hi8 recording	Hi8

Tape Analyzer ATRS (auto tape recording system)

(for VM-H765LA/VM-H665LA)

This camcorder automatically evaluates the tape characteristics during recording, in order to ensure recording in optimum status.

1 Set the CAM/OFF/VIDEO switch to CAM.

2 Press the MENU button.

3 Press the PLAY or STOP button to select "ATRS".

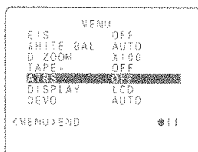

4 Press the FF button to specify "ON": "ATRS PRESS REC START" will flash.

5 Press the Start/Stop button.

"ATRS" will appear on the screen for approx. 5 seconds.

Note: When tape is ejected after "ON" is specified, the ATRS menu item will return to "OFF".

Note: When tape is ejected, or power supply is removed without the backup battery for clock being inserted, after "ON" is specified, the ATRS menu item will return to "OFF".

Note: When this function is switched to during recording pause, noise may appear in the joint of recordings.

Setting the Date and Time

Take the time to set the date and time now. The date and time can be recorded on your tapes to act as a handy reference when viewing them later. Use the following procedure to set up the display for the current date and time.

Note: Be sure to insert the clock battery before setting the date and time. Although the date and time can be set without the clock battery inserted, they will disappear when the battery providing power to the camcorder is removed.

Make sure that the current time is displayed correctly before you start filming.

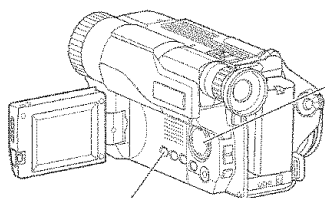

DATE Button

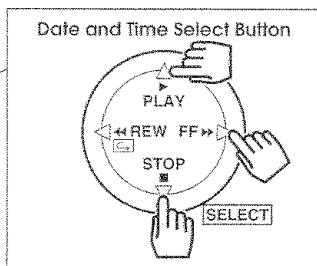

- 1 Load the battery. ("Camcorder Power Sources", p20.)
- 2 Press the small button on the CAM/OFF/VIDEO switch as you slide it to CAM.
- 3 Open the LCD monitor, and then press the DATE button. The date and time should appear in the lower right with the "1" flashing.

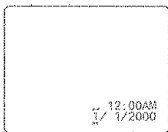

- 4 Pressing the PLAY button gives you higher numbers while the STOP button gives you lower numbers. Select the right month and press FF button. Use the PLAY, STOP and FF buttons to select the proper day, year, hour, minute, and AM or PM.
- 5 After setting the AM/PM, press the DATE button. The display changes and the internal clock starts.



Note: After the date and time are set, the camcorder enters the date recording mode. See "Date Recording" on page 35.

Correcting the Date and Time

- 1 Hold down the DATE button for at least 3 seconds: The flashing cursor will appear at the month.
- 2 Move to where you need to make the correction with the FF button and use the PLAY and STOP to correct.
- 3 Press the DATE button to set the corrected date and time.

Basic Techniques

The batteries are in place and charged, the date and time are set, and you are familiar with the controls its time to make a recording. Basic recording is easy and simple.

This section guides you through basic recording and playback. Practice the basic techniques of recording and playback on something unimportant such as traffic or a short tour of your backyard. Once familiar with how the machine works you can move to the more sophisticated features with less stress.

Let's get started!

Making a Basic Recording

The Hitachi VM-H765LA/VM-H665LA/VM-E565LA/VM-E563LA/VM-E465LA uses PROGRAM AE auto exposure that automatically selects the optimum shutter speed (either 1/60, 1/120, 1/180, 1/250, 1/350, 1/500, 1/750, 1/1000, 1/1500, 1/2000, or 1/4000 of a second). The iris adjusts automatically in response to the shutter speed.

Information for VM-H765LA/VM-H665LA/VM-E565LA: Use the PROGRAM AE button to select the exposure that suits the subject condition. For details, see "Using the PROGRAM AE Button" on page 42.

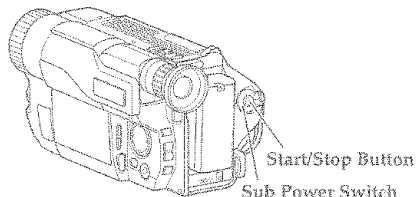

- 1 Connect the camcorder to a power source (See pages p20 ~ p21).
- 2 Insert a cassette ("Inserting and Removing Cassettes", p22).
If you want to view the picture being recorded on the LCD monitor, open the LCD monitor; if you want to view the picture in the viewfinder, leave the LCD monitor closed.
- 3 Make sure that the sub power switch is in the STANDBY position.

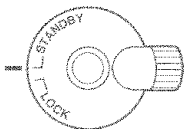

- 4 Press the small button on the CAM/OFF/VIDEO switch as you slide it to CAM. The lens door will open automatically. "●II" appears in the viewfinder or on the LCD monitor and the camcorder is now ready to record.



- 5 When you are ready to record press the Start/Stop button. "REC" appears and the camcorder records the picture you see in the viewfinder or on the LCD monitor.

The record indicator lights when the camcorder starts recording.



- 6 To stop recording press the Start/Stop button and "REC" disappears from the viewfinder or LCD monitor replaced by "●II". This places the camcorder in standby.
- 7 After recording, slide the CAM/OFF/VIDEO switch to OFF position to turn off the camcorder.

Note: If the LCD monitor is opened or closed during recording, several white stripes may appear in the picture, but this does not indicate a fault. However, these stripes are recorded with the picture, so it is recommended that you do not close or open the LCD monitor during recording.

Note: "TAPE" flashes in the viewfinder or on the LCD monitor when the tab on the side of the cassette is completely visible.

Note: "TAPE END" flashes in the viewfinder or on the LCD monitor when about 3 minutes or less remain of the tape cassette.

Note: If the camcorder is left in record/pause mode for more than 5 minutes, the camcorder turns off automatically. To restart it press the Start/Stop button and the camcorder returns to record/pause mode.

Changing the Angle of the LCD Monitor when Recording

You can change the angle of the LCD monitor so that the picture on the LCD screen can be monitored from different positions.

See "LCD Monitor" (p14) for the range in which you can change the angle of the LCD monitor.

Note: You need the remote control to operate the camcorder.

Recording an Image of Yourself while Monitoring the LCD Screen

- 1 Open the LCD monitor ("Opening the LCD Monitor", p14).
- 2 Turn the LCD monitor so the monitor screen faces the same direction as the lens.

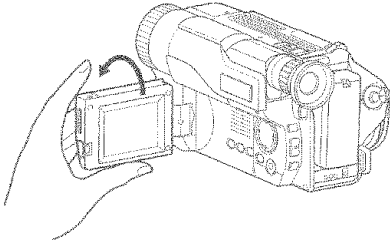

Press the START/STOP button on the remote control, and the camcorder will begin recording.

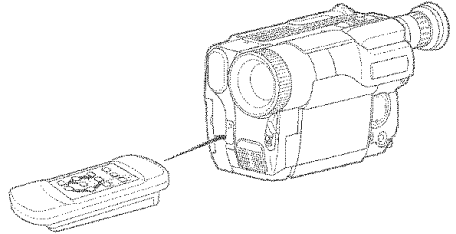

Note: When you record an image of yourself, the image displayed on the LCD monitor will become a mirror image. The on-screen display on the LCD monitor will also be as if reflected on a mirror.

Note: Tilt the LCD monitor in the direction of the camera lens so that it faces up slightly, and the screen may be viewed easily.

Note: When you record an image of yourself, the on-screen display will disappear, and the recording status indicator "REC" will change to red "●".

Using Instant Review

Use this feature to view the last few seconds of the tape you shot.

- 1 Set the camcorder to record/pause mode and tap the REW button. The last few seconds of the tape play back in reverse and then in normal playback mode.

Note: Sound is heard from the speaker during normal playback.

- 2 The camcorder plays back to the spot where you paused and returns to record/pause mode (standby). Press the Start/Stop button to resume recording.

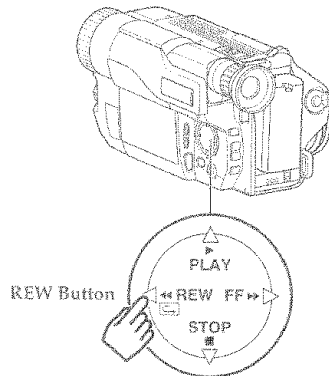

Using Auto Focus

The camcorder focuses the subject in the center of the viewfinder or LCD monitor automatically unless the manual focus is engaged. If "FOCUS" appears in the viewfinder or on the LCD monitor, manual focus is engaged. Press the FOCUS/VOL. control buttons simultaneously to return to auto focus. See "Using Manual Focus" on page 36.

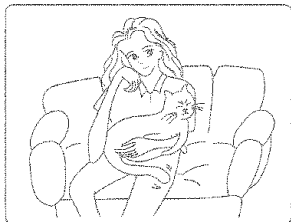

Good

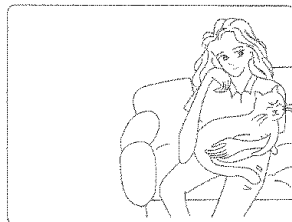

Not good

The auto focus will not work under the following conditions and you must focus manually:



Objects outside the center of the viewfinder or LCD monitor

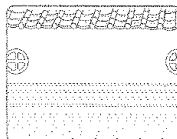

Objects with little difference in light reflection such as a white wall



Objects at different distances in the center of the viewfinder or LCD monitor



Rapidly moving objects



Brightly lit objects such as a neon light, objects lit by spot-light, etc.



Dark objects



Objects behind water dappled or dusty glass

Note: With the T zoom control you can use the auto focus with subjects that are 3.3 feet (100 cm) away from the lens and further away to infinity. With the W zoom control you can use the auto focus with subjects 3/8 inches (1 cm) away from the lens and further away to infinity.

Using the Power Zoom

The power zoom W control widens the picture, moving the subject farther away, while the power zoom T control brings the subject closer, narrowing the picture. If "ZOOM" appears at the left of the viewfinder or LCD monitor, the digital zoom function shown below has been engaged.

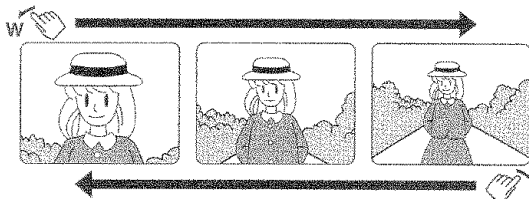

The zoom speed varies depending on how the power zoom control lever is moved: the more the lever is moved, the higher the zoom speed will be.

When the power zoom control is operated, the zoom position is displayed in the viewfinder or on the LCD monitor for about 5 seconds and then disappears. The zoom position is displayed in 10 steps.

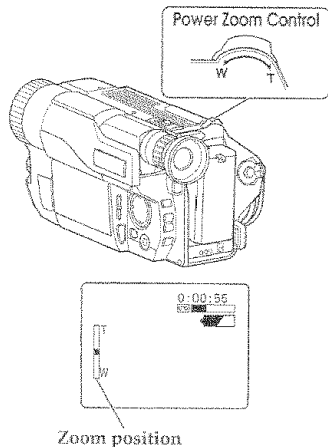

Using the Digital Zoom

The digital zoom increases the magnification of the power zoom by 4.5 times. You must place the subject you wish to magnify at the center of the viewfinder or LCD monitor.

Slide and hold the power zoom control to the "T" side until you find the picture you want. You control the zoom with the power zoom T and W controls. When "ZOOM" is not displayed in the viewfinder or on the LCD monitor, normal zoom functions resume.

Note: This digital zoom has certain limitations and may degrade at extreme magnification and amplify camcorder's movement.

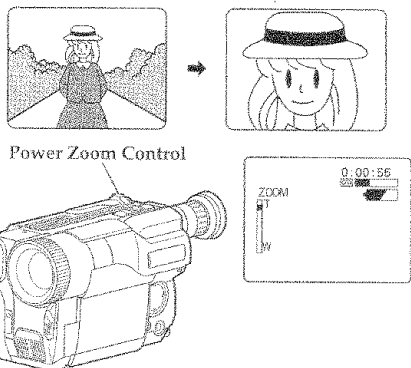

Using Macro

This function allows you to shoot subjects as close as 3/8 inches (1cm). Press and hold the power zoom control W. The camera focuses on the subject automatically. Check your lighting as it tends to be insufficient when filming close up.

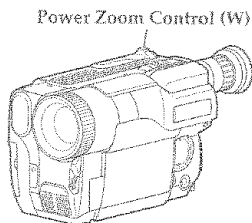

Playback

You can view recorded pictures on the LCD monitor immediately after recording.

Note: Make sure that "PAL60" does not appear in the viewfinder or on the LCD monitor. If it is displayed, no color will appear in the played back picture ("Multi Playback", p54).

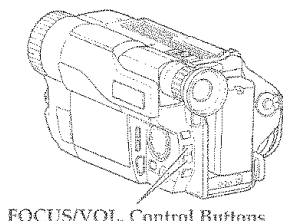
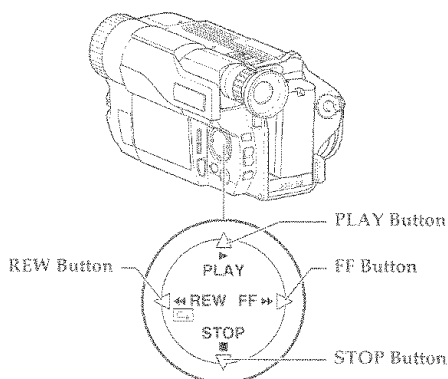

- 1 Open the LCD monitor, and then adjust the angle of the monitor ("Opening the LCD Monitor", p14).
- 2 Hold down the small button on the CAM/OFF/VIDEO switch while sliding the switch to VIDEO.
- 3 Press the REW button to rewind the tape. For fast forwarding the tape, press FF.
- 4 Press the PLAY button and play back the tape. To adjust the volume, press the FOCUS/VOL. control buttons. When either button is pressed, the volume adjustment display will appear on the LCD monitor for about 5 seconds. Press ▲ to increase the volume, or press ▼ to decrease it. After 5 seconds, the adjustment display will automatically disappear.



- 5 Press the STOP button when you have finished.

Note: Decrease the sound volume of the camcorder when you play back a recording by connecting the camcorder to your TV. If the volume of the camcorder is set to maximum, the played back picture may be distorted. Make sure that the volume is not set to maximum during recording as it could distort the played back picture.

Note: When the LCD monitor is turned on and left as it is, the monitor becomes warm, but this does not indicate a fault.

Note: When the CAM/OFF/VIDEO switch is set to CAM or VIDEO, the LCD monitor is turned on and off automatically when the LCD monitor is opened and closed.

Note: It is recommended that you close the LCD monitor to save the battery power when playing back a picture on a TV without viewing it.

Note: Only the playback sound is heard. The sound being recorded is not heard.

Note: No sound is heard when the LCD monitor is closed.

● To Play Back a Tape with the Viewfinder

Close the LCD monitor, then press the PLAY button to play back the tape. The picture appears in the viewfinder.

Note: You cannot hear the playback sound when playing back your video with the viewfinder.

Using Still

To view a still picture during playback press the Start/Stop. Press the Start/Stop button again to resume playback. If you leave the camcorder in play/pause mode for more than 5 minutes the camcorder automatically stops the cassette to prevent damage to the tape. You can view a still picture with less noise on the LCD monitor (Clear Still).

Note: The still picture will have several noise bars in the viewfinder and on the TV, but this does not indicate a fault.



Note: If you are freezing a picture with the LCD monitor closed, then you will not be able to view a still picture with less noise when you open the monitor.

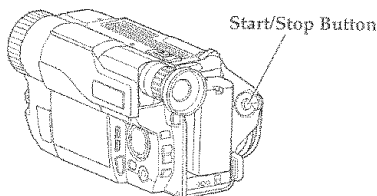

Using Forward and Reverse Search

When looking for a particular point in your videotape use the FF button and REW button to find the spot quickly.

When the LCD monitor is closed:

- Press the FF button during playback to play the tape forward at approximately 9 times normal speed. Press the PLAY button to return to normal playback.
- Press and hold the FF button during fast forward to visually scan the tape at 19 times the normal playback speed. Releasing FF returns the camcorder to fast forward.
- Press the REW button during playback to play the tape backwards at approximately 7 times normal speed. Press the PLAY button to return to normal playback.
- Press and hold the REW button during fast rewind to visually scan the tape backwards at 17 times the normal playback speed. Releasing REW returns the camcorder to fast rewind.

Note: When you engage FF button or REW button the picture will have some interference or noise in the viewfinder. This is normal during search mode.

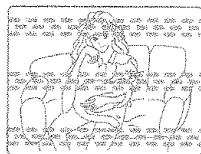

When the LCD monitor is open (Clear Search):

You can view pictures with less noise on the LCD monitor during forward or reverse search.

- Press the FF button during playback to play the tape forward at 6 times normal play speed. Press the PLAY button to resume normal playback.
- Press and hold the FF button during fast forward to visually scan the tape at 17 times the normal playback speed. Releasing FF returns the camcorder to fast forward.
- Press the REW button during playback to play the tape in reverse at 4 times normal speed. Press the PLAY button to resume normal playback.
- Press and hold the REW button during fast rewind to visually scan the tape backwards at 15 times the normal playback speed. Releasing REW returns the camcorder to fast rewind.

Note: If you are using forward or reverse search with the LCD monitor closed, then you will not be able to view pictures with less noise when you open the monitor.

Note: Several noise bars will appear on the TV screen during forward or reverse search.

Note: A noiseless picture will not appear during high-speed search even if the LCD monitor is open.

Note: Noise may flow during high-speed search in low temperature conditions.

Advanced Techniques

The Hitachi VM-H765LA/VM-H665LA/VM-E565LA/VM-E563LA/VM-E465LA offers a diverse group of features that add interest and excitement to your video. Adding fades to smooth transitions creates video with a professional look.

As you learn and practice with these features think of situations that they might fit in and add a special touch.

Date Recording

When the date has been set, the camcorder will enter the automatic date recording mode automatically.

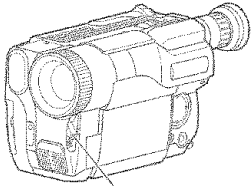

CAM/OFF/VIDEO Switch

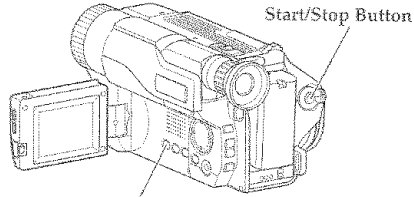

DATE Button

- 1 Press the small button on the CAM/OFF/VIDEO switch as you slide it to CAM.
- 2 Press the DATE button to specify the date display you want to record.

"⊙ AUTO" and Date — Automatic Date Recording

This option records the date automatically once a day at the beginning of recording for 10 seconds.



Note: The camcorder records the same date when;

- the cassette is replaced.
- you select "⊙ AUTO" and date display again.
- the recording is less than 10 seconds long.

Note: If the date changes while recording continues over 10 seconds, the new date is recorded for about 10 seconds the next time you make a recording.

Date — Date Recording

The camcorder records the date with the picture all the time.



No Display — No Date Recording

The camcorder does not record the date.



Date and Time — Date and Time Recording

The camcorder records the date and time with the picture all the time.



- 3 Press the Start/Stop button.

Recording will start.

Note: When "⊙ AUTO" and date display is selected, the date disappears about 10 seconds after recording is started.

Using Manual Focus

- 1 Press the FOCUS/VOL. control buttons simultaneously. "FOCUS" displays in the viewfinder or on the LCD monitor. You can adjust the focus manually.
- 2 Use the power zoom T control to zoom up completely to your subject. If you don't use the T control to zoom to the picture you want, the picture may fall out of focus when actual recording starts.
- 3 Press the FOCUS/VOL. control ▲ (far) or ▼ (near) button until the subject is in focus.
- 4 Use the power zoom W control to zoom back to the picture you desire.

Note: To return to auto focus press the FOCUS/VOL. control buttons and the "FOCUS" disappears from the viewfinder or LCD monitor.

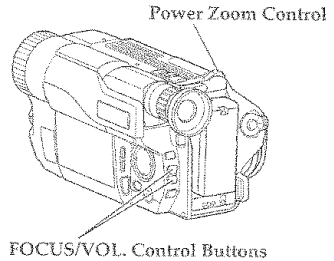

Using X500 Digital Zoom

You can use the X500 digital zoom function to magnify the subject on tape up to approx. 23 times the X22 optical zoom. This function also enables you to further magnify a distant subject.

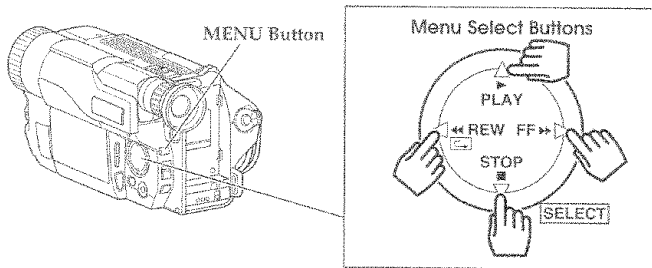

- 1 Press the small button on the CAM/OFF/VIDEO switch as you slide it to CAM.
- 2 Press the MENU button: The menu display will appear.
- 3 Press the STOP or PLAY button to select "D.ZOOM".

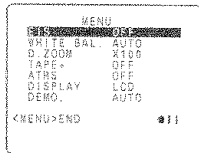

- 4 Press the FF or REW button to display "X500".

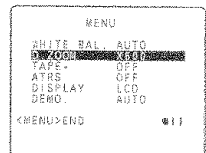

- 5 Press the MENU button: The menu display will disappear from the LCD monitor or viewfinder.

Note: This digital zoom has certain limitations: it may degrade if used for extreme magnification, and thereby amplify camcorder movement.

Digital Effects Functions

Use the digital effect feature to attach special video effects to your recording and playback: Select from five effect modes during recording or 4 effect modes during playback.

Digital Effects Recording

The digital processor in this camcorder allows you to record picture and add special effects: 16X9 recording mode, a negative image (negative/positive mode), a symmetric image (obtained by placing a mirror at the center of the screen (half-mirror mode)), an image in mosaic (mosaic mode), and an oil painting look (art mode).

- Each time the EFFECT button is pressed, the recording mode is switched.

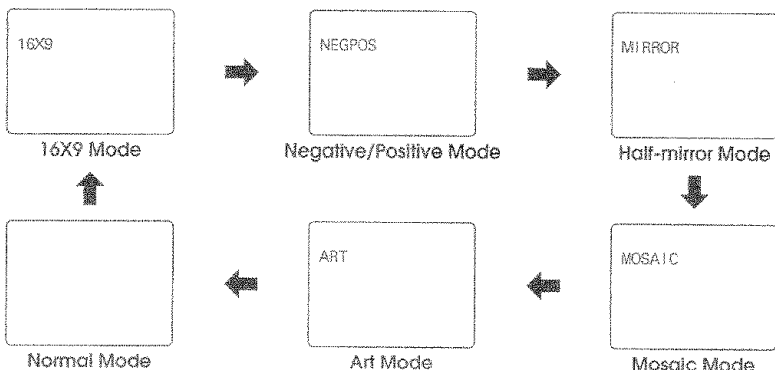
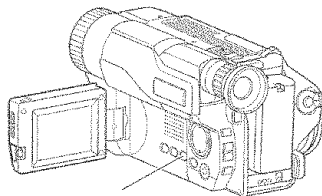

Activating Digital Effects Recording

- 1 Place the camcorder in the record pause mode.
- 2 Press the EFFECT button to select the digital effects record mode you want.

"16X9": 16X9 Mode

The picture format can be switched from 4:3 (the picture format of an ordinary TV set) to 16x9. The top and bottom of the picture in the viewfinder or on the LCD monitor become black bars.

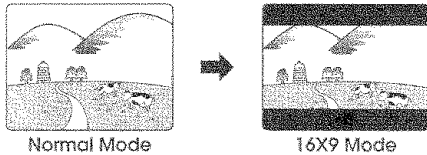

"NEGPOS": Negative/Positive Mode

The image in the viewfinder or on the LCD monitor will become negative.

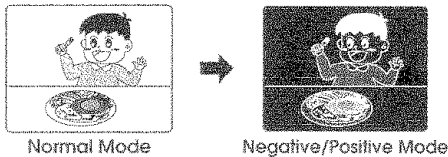

"MIRROR": Half-mirror Mode

The image in the viewfinder or on the LCD monitor will change to a symmetric image on the left and right, obtained by placing a mirror at the center of the screen.

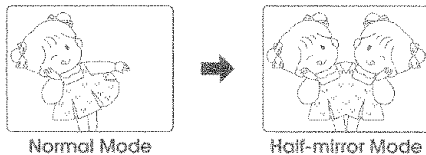

"MOSAIC": Mosaic Mode

The image in the viewfinder or on the LCD monitor will be in mosaic.

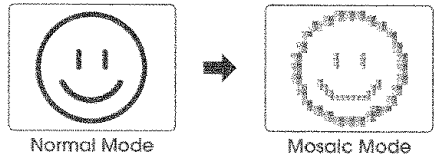

"ART": Art Mode

The image in the viewfinder or on the LCD monitor will take on the look of an oil painting.

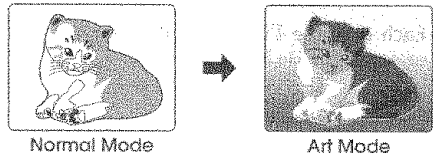

- 3 Press the Start/Stop button to start recording.

- To release digital effects recording, repeatedly press the EFFECT button in the record pause mode until the normal mode is restored.

Video Effects in Playback Mode

The digital signal processor (DSP) in this camcorder allows you to add special effects to playback pictures. Use this feature during tape dubbing, etc. to create a tape with a more artistic impression. The video effect modes during playback are: 16X9, Art, Sepia and Black-and-white.

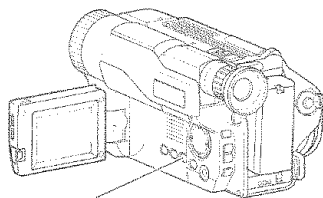

EFFECT Button

- Each time the EFFECT button is pressed in the playback or play/pause mode, the playback mode will switch as follows:

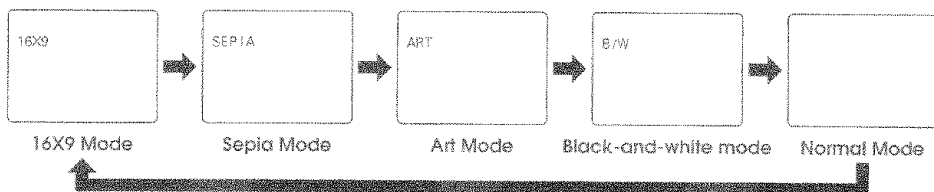

Activating Video Effects Playback

- 1 Press the small button on the CAM/OFF/VIDEO switch as you slide it to VIDEO.
- 2 Play the tape or set the camcorder to the play/pause mode.
- 3 Press the EFFECT button to select the video effect playback mode.

"16X9": 16X9 Mode

The top and bottom of the picture will be black bars.

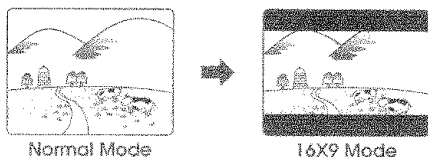

"SEPIA": Sepia Mode

The entire picture will be sepia.

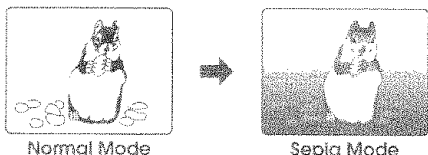

"ART": Art Mode

The entire picture will take on the look of an oil painting.

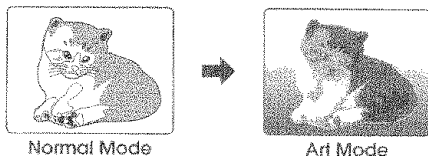

"B/W": Black-and-White Mode

The entire picture will be black-and-white.

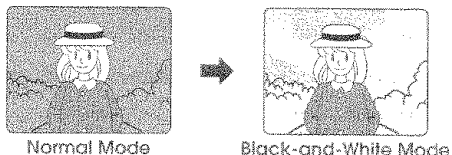

Note: To switch the mode or return to the normal picture during tape dubbing, temporarily stop the dubbing and press the EFFECT button.

Note: When tape stops, the normal picture will be restored.

Using Digital Fade

Use the fade feature to add a professional touch to your recordings. Use the FADE button to select one of the six fade options.

Note: If you press the EFFECT button after setting the fade function, the fade function will be released. After setting the digital effect mode, reset the fade function.

- **White fade:** Fades in from a white screen or fades out to a white screen. "F.F." appears in the upper left corner of the viewfinder or LCD monitor.

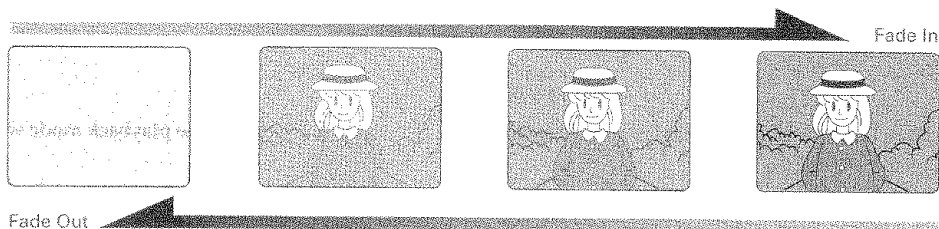

- **Wipe fade:** The picture opens gradually from the center of a black screen or closes into the center to a black screen. "W.F." appears in the upper left corner of the viewfinder or LCD monitor.

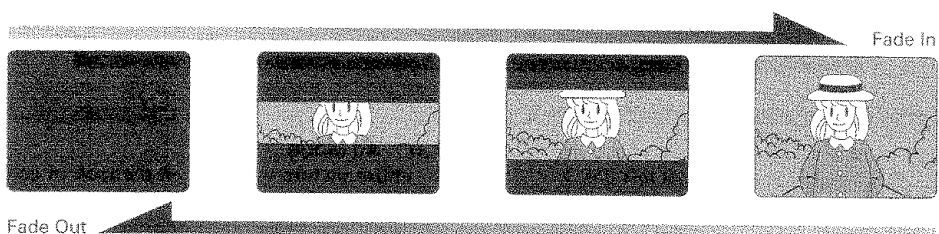

- **Mosaic fade:** Fades in from a picture in mosaic or fades out to a picture in mosaic. "MOS.F" appears in the upper left corner of the viewfinder or LCD monitor.

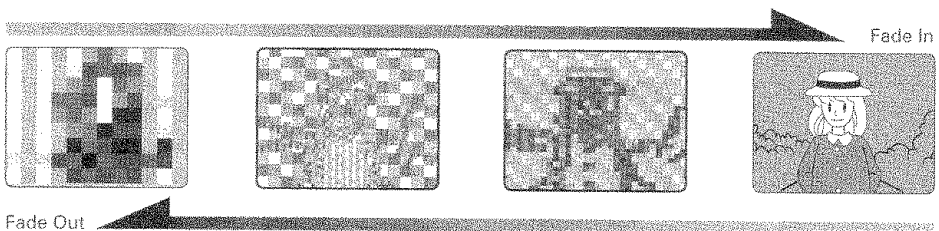

- **Art fade:** Fades in from, or fades out to a picture with the feel of an oil painting. "ART.F" appears in the upper left corner of the viewfinder or LCD monitor.

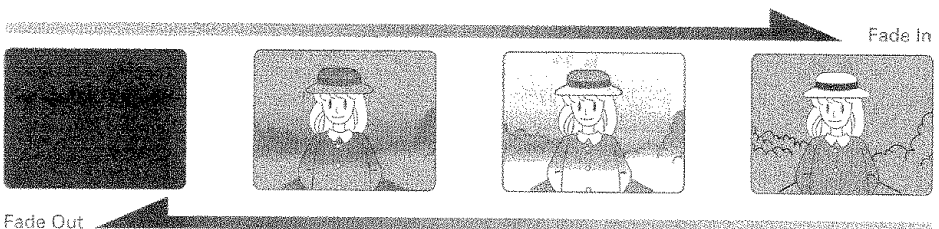

- **Zoom fade:** Fades in while zooming from a white screen or fades out while zooming to a white screen. "Z" appears in the upper left corner of the viewfinder or LCD monitor.

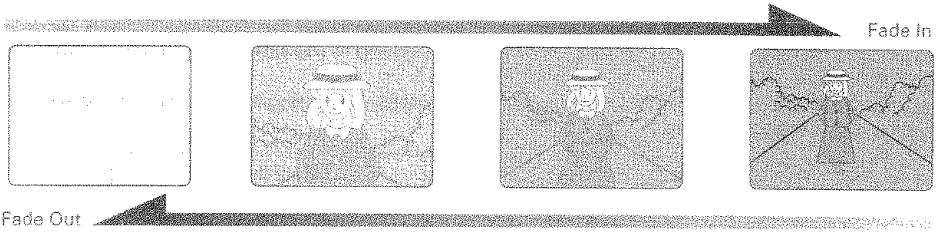

- **Black-and-white fade:** Fades in from a black-and-white screen or fades out to a black-and-white screen. "B/W" appears in the upper left corner of the viewfinder or LCD monitor.

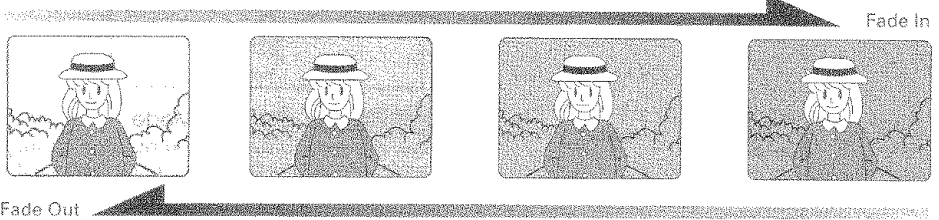

Fading In

- 1 Use the FADE button to select a fade option before recording.
- 2 Press the Start/Stop button to start recording; fade begins automatically.

Fading Out

- 1 While recording with the camcorder use the FADE button to select a fade option.
- 2 Press the Start/Stop button to stop recording; the fade begins automatically and "REC" flashes until the fade ends.

Note: When fading out be sure to wait until the pause indicator (●II) is visible in the viewfinder or on the LCD monitor before attempting to put the camcorder into the record mode again.

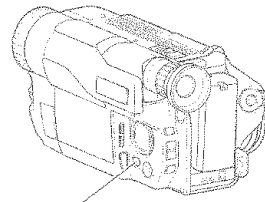

FADE Button

Using the PROGRAM AE Button (for VM-H765LA/ VM-H665LA/VM-E565LA)

This camcorder can easily set the shutter speed and aperture to suit the subject condition, recording situation or purpose, as well as adjusting all of these according to the subject brightness (conventional program AE).

Press the PROGRAM AE button to select the recording mode according to the subject to be recorded and the recording conditions.

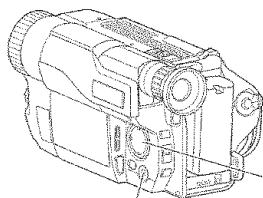

PROGRAM AE Button

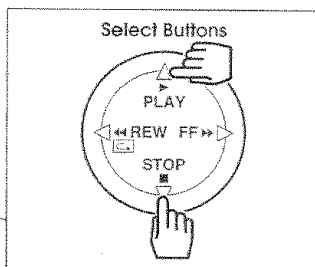

- 1 Press the PROGRAM AE button: **SPORTS** will appear in the viewfinder or LCD monitor.



SPOTLIGHT: Spotlight Mode

Select this mode when the contrast ratio of subject is high and the highlighted section area is relatively small.

GAIN UP: Gain-up mode

Select this mode when recording a poorly lit subject, such as in a dim room, etc.: The entire image will be recorded brighter.

- 2 Press the PLAY or STOP button to select the desired recording mode.

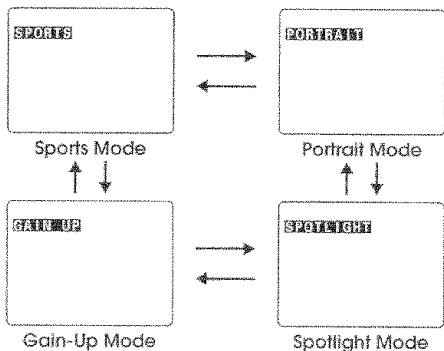

- 3 Press the Start/Stop button to start recording. To return to the full auto mode, press the PROGRAM AE button.

No Display: Full Auto Mode

In this mode, the camcorder automatically adjusts the shutter speed and aperture according to the subject brightness. Therefore, use this mode for standard recording.

SPORTS: Sports Mode

Select this mode when recording rapidly moving subjects, such as golf or tennis swings, etc.: The subject will be clearly recorded, without blurring.

PORTRAIT: Portrait Mode

Select this mode when recording a subject portrait standing out from a blurred background.

Using the Backlight Compensation

The camcorder contains an auto iris that adjusts the lens aperture depending on the available light, widening it under low light conditions and narrowing it when bright light is available. When the camcorder is turned off the iris fully closes.

When you are filming a subject in front of a brightly lit background, press and hold the BLC button: It will correct the lighting on the tape.

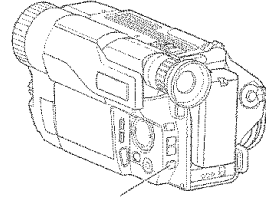

BLC Button

Locking the White Balance

This camcorder adjusts the white balance automatically (auto white balance): Using the menu, you can lock the optimum white balance set in the auto white balance status.

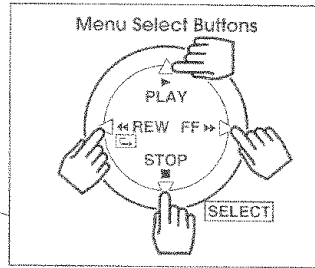
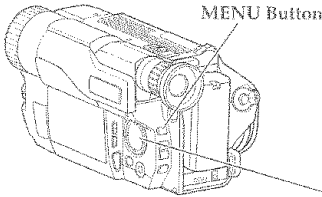

- 1 Set the CAM/OFF/VIDEO switch to CAM.
- 2 Press the MENU button: The menu display will appear.



- 3 Press the STOP or PLAY button to select "WHITE BAL."

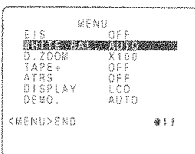

- 4 Press the FF or REW button to display "LOCK".



- 5 Press the MENU button: The menu display will disappear from the LCD monitor or viewfinder.

Note: If the CAM/OFF/VIDEO switch is set to VIDEO, locking will be released and "AUTO" will be specified again.

Note: If unnatural colors appear on the LCD monitor with "WHITE BAL. LOCK" specified, reset the white balance or specify "WHITE BAL. AUTO".

Using the Electronic Image Stabilizer (for VM-H765LA/VM-H665LA/VM-E565LA/VM-E563LA)

The electronic image stabilizer (EIS) corrects slight shaking of the image being recorded and is effective in the following situations.

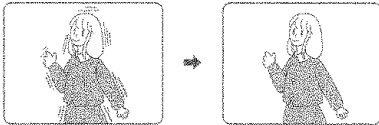

- While you zoom to a distant subject.
- While you approach a small subject.
- While you walk around.
- While you record from inside a moving vehicle.

4 Press the FF or REW button to display "ON".

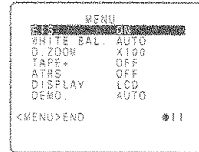

5 Press the MENU button. The EIS icon (EIS) appears in the upper left corner of the viewfinder or LCD monitor.

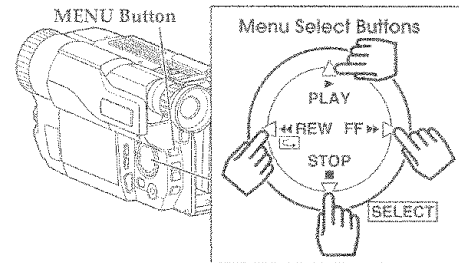

6 Press the Start/Stop button to start recording. When EIS is engaged the viewfinder or LCD monitor image shakes with a slight delay.

Note: EIS may not function if you use a wide or tele converter lens.

Note: It is recommended that you do not use the EIS function when using a tripod. The sensor would detect vibrations from the tripod in which case the picture would be blurred.

Notes for VM-H665LA/VM-E565LA/VM-E563LA

- When the EIS function is engaged in the vicinity of the zoom range with "ZOOM" displayed in the viewfinder or on the LCD monitor, when moved from the wide-angle end, the image size will change, but this is normal.
- When the EIS function is engaged, the picture becomes rough.
- When the EIS function is engaged, the angle of view at the wide-angle end becomes narrower.

1 Set the CAM/OFF/VIDEO switch to CAM.

2 Press the MENU button: The menu display will appear.



3 Press the STOP or PLAY button to select "EIS".



Using Quick Edit

Use quick edit to search for the end of previously recorded material, find a particular spot on your tape, begin editing, or record new material. While the camcorder is in record/pause mode hold down the FF, REW, or PLAY button and visually search the tape. Release the button and the camcorder stops the tape at the exact position you selected.

Note: If the FF or REW button is pressed for quick edit, noise will appear in the viewfinder, on the LCD monitor, or on the connected TV.

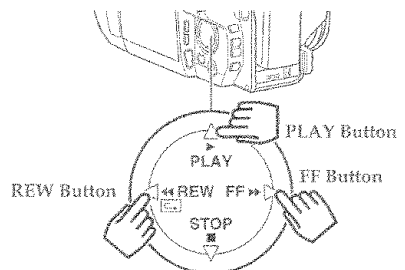

Date Search

The date search function memorizes the start and end positions of recordings you made on a specific day so you can easily locate those positions later as long as the cassette is left in the camcorder.

Note: Be sure that the date and time are set.

- 1 Attach a power source and slide the CAM/OFF/VIDEO switch to VIDEO.
- 2 Press the DATE button (the DISPLAY button on the remote control) to display "SEARCH" in the viewfinder or on the LCD monitor.



- 3 Press the REW button to search for the start position from which you last made a recording or the FF button to recording end position. "SEARCH" will appear while the start position is being searched for; "SEARCH >>>", while the end position is being searched for.
- 4 When the required position is located, the camcorder enters the stop mode and "SEARCH" disappears from the viewfinder or LCD monitor.



Note: If you have ejected the cassette, this function will not operate with that cassette. (When a cassette is inserted and the recording is started, the position is identified as the recording start position on that day.)

Note: If the clock battery is not inserted, the date search function does not operate when the battery providing the power to the camcorder is removed.

Note: When the cassette was recorded by another camcorder, the date search function does not operate.

Note: The date search function is released when you press the STOP button during date search mode.

Note: If the recorded time is less than 30 seconds, the date search function may not operate normally.

Using Memory

The linear time counter memory stops a rewinding tape at approximately "0:00:00M". This feature helps in locating a specific point in the tape to which you wish to return. An example might be that you have recorded some tape that you have already watched, you continue recording but do not care to watch the tape you recorded earlier. The memory feature returns you to the beginning of the most recent recording.

- 1 Start recording or playback of a cassette. Press the COUNTER RESET button on the remote control at the point to which you wish to return. The linear time counter clears to "0:00:00".
- 2 Press the STOP button to stop playback, or press the Start/Stop button recording and set the CAM/OFF/VIDEO switch to VIDEO.
- 3 Press the DISPLAY button on the remote control so the linear time counter with memory is displayed as shown in the figure.

Note: You can also use the memory function by specifying "LCD/LINE" for the DISPLAY item on the menu screen.

- 4 Press the REW button and the tape stops at approximately where you reset the linear time counter. This feature works in FF as well.

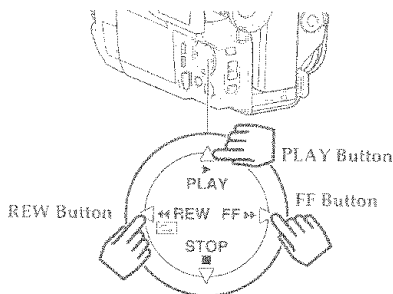

Linear time counter with memory



Creating and Recording a Title

The titling function allows you to select one of nine titles stored in camcorder memory, or create a new title, and record it. You can choose from six languages to display stored titles: English, French, Spanish, German, Italian and Chinese. Select or create a title and personalize your recordings, while at the same time keeping a permanent visual record of what is contained on a tape.

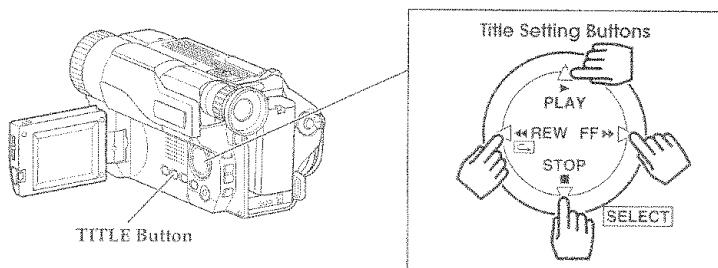

Selecting Stored Title (Prememo)

Note: Be sure to insert the clock battery before selecting a title. Although a title can be chosen without the clock battery inserted, it will disappear when the battery providing power to the camcorder is removed.

- 1 Connect the camcorder to a power source.
- 2 Hold down the small button on the CAM/OFF/VIDEO switch and slide it to either CAM or VIDEO.
- 3 Press the TITLE button.
A flashing cursor will appear in the viewfinder or on the LCD monitor, and the camcorder will enter the title creating mode ("Creating a Title" on page 48).



- 4 Press the REW button.

"HAPPY BIRTHDAY" will appear.



You can choose the desired language of the displayed title by pressing the REW button, as in the following order:

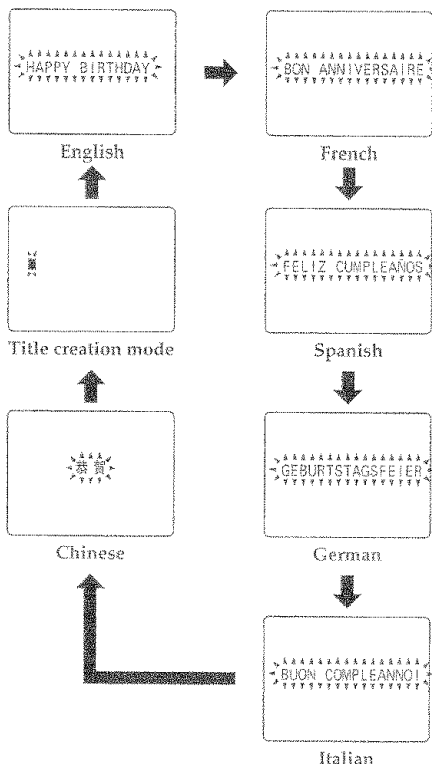

5 Use the PLAY or STOP button to select a desired title.



Stored titles (Prememo) available

<English>

HAPPY BIRTHDAY
MERRY CHRISTMAS
CONGRATULATIONS
THE SUPERSTAR
VACATION FUN
THANKSGIVING
HAPPY EASTER
ANNIVERSARY
HAPPY NEW YEAR

<French>

BON ANNIVERSAIRE
JOYEUX NOEL
FELICITATIONS
"SUPERSTAR"
VACANCES
"THANKSGIVING"
JOYEUSES PAQUES
ANNIVERSAIRE
BONNE ANNEE

<Spanish>

FELIZ CUMPLEAÑOS
FELICIDADES
EL PROTAGONISTA
FELIZ NAVIDAD
VACACIONES
ANIVERSARIO
FELIZ AÑO NUEVO
SEMANA SANTA
FIESTA

<German>

GEBURTSTAGSFEIER
FROHE WEIHNACHT
HOCHZEIT
PROST NEUJAHR
FROHE OSTERN
GLÜCKWUNSCH
JUBILÄUM
SCHÖNE FERJEN
ERNTE-DANKFEST

<Italian>

BUON COMPLEANNO!
E'VACANZA!
VIVA GLI SPOSI!
IN FAMIGLIA
E'QUI LA FESTA?
FELICITAZIONI!
BUONE FESTE
DOLCI RICORDI
CHE SBALLO!

<Chinese>

恭賀
生日快樂
聖誕快樂
新年快樂
婚禮
快樂回憶
假日
宴會
終了

6 Press the TITLE button. The selected title will appear, and the color select mode will be engaged.

Press the PLAY or STOP button to select the desired color. You can choose from seven colors: white, yellow, cyan, magenta, red, green and blue.

Note: If the CAM/OFF/VIDEO switch is set to VIDEO, you cannot select color: the title will appear in white.

7 After you have selected the color, press the TITLE button.

Note: If you display the date along with the title, after selecting the color, the date will be displayed in the same color.

Creating a Title

A title contains two lines of up to 16 characters per line. The camcorder contains 81 different characters for creating a title.

Note: Be sure to insert the clock battery before creating a title. Although a title can be created without the clock battery inserted, it will disappear when the battery providing power to the camcorder is removed.

- 1 Connect the camcorder to a power source.
- 2 Hold down the small button on the CAM/OFF/VIDEO switch and slide it to either CAM or VIDEO.
- 3 Press the TITLE button and a flashing cursor appears in the viewfinder or on the LCD monitor.

Note: If a stored title appears, press the PLAY button to display the screen for creating a title.



- 4 Use the FF button to place the cursor where you wish to begin your title.
- 5 Use the PLAY and STOP buttons to select the first character of your title.



- 6 Once you've selected a character press the FF button to set it.



- 7 Complete the title by repeating steps 5 and 6.



- 8 Press the TITLE button. The color select mode will be engaged, and you can now color the created title.

Press the PLAY or STOP button to select the desired title. You can choose from seven colors: white, yellow, cyan, magenta, red, green and blue.

Note: If the CAM/OFF/VIDEO switch is set to VIDEO, you cannot select color: the title will appear in white.

- 9 When you complete your title, press the TITLE button to store the title in memory and remove the title graphics from the viewfinder or LCD monitor.

Note: As long as the correct current time can be displayed, the title is held in memory.

Note: If you display the date along with the title, after selecting the color, the date will be displayed in the same color.

Characters available for your title

A	B	C	D	E	F	G	H	I	J	K	L	M	N	O	P	Q
R	S	T	U	V	W	X	Y	Z	0	1	2	3	4	5	6	7
8	9	?	'	.	/	-	+	:	<	>		À	É	Í	Ó	
Ü	Ä	Ê	Ë	Ï	Ö	Á	É	Í	Ó	Ú	Ä	Ê	Ë	Ï	Ö	Ñ
Ç	Æ	£	Ø	¿	¡	À	£	¤	¥	€	¥	"	'			

Space

Correcting Errors

- 1 Hold down the TITLE button for at least 3 seconds: The first character will flash.
- 2 Use the FF button to select the character to be corrected.
- 3 Use the PLAY and STOP buttons to correct the character.
- 4 Press the TITLE button, and use the PLAY and STOP button to select the desired color.

Note: If the CAM/OFF/VIDEO switch is set to VIDEO, you cannot select color: the title will appear in white.

- 5 Press the TITLE button to store the corrected title in memory.

Recording Title on a Tape in the Camcorder

- 1 Hold down the small button on the CAM/OFF/VIDEO switch while sliding the switch to CAM.
- 2 Locate the point of the tape where you wish to record the title ("Using Quick Edit," p44).
- 3 Press the TITLE button.
- 4 Use the REW button to select the title (the title you have created or the existing title in camcorder you have memorized on page 47) you wish to record.
- 5 Press the Start/Stop button to start recording the title.
- 6 Press the TITLE button to stop recording the title. The title graphics disappear from the viewfinder or LCD monitor and the camcorder can record normally.

Note: Create and store your title before an event you plan to record. Just press the TITLE button to superimpose the title over the scene as you record it. This method avoids erasing previously recorded material which will happen when you record a title on a previously recorded tape.

Recording a Title while Transferring a Tape

- 1 Connect the camcorder to the VCR (p50).
- 2 Hold down the TITLE button for at least 3 seconds: The title setting mode will be entered.
- 3 Use the REW, PLAY and STOP buttons to select the title from memory, and then press the TITLE button to set the title.
- 4 Press the TITLE button to turn title off.
- 5 Turn on the VCR and set it to record. Hold down the small button on the CAM/OFF/VIDEO switch while sliding the switch to VIDEO. Press PLAY on the camcorder.

- 6 Press the TITLE button at the point on the tape where you wish to record the title.
- 7 Press the TITLE button again to stop recording the title.

Note: Recording the title during tape transfer will erase a portion of your recorded material.

Note: If the CAM/OFF/VIDEO switch is set to VIDEO, the title will appear only in white.

Playing Back Your Recording on Your TV

Connecting to a Television (or VCR) with Audio/Video Input Jacks

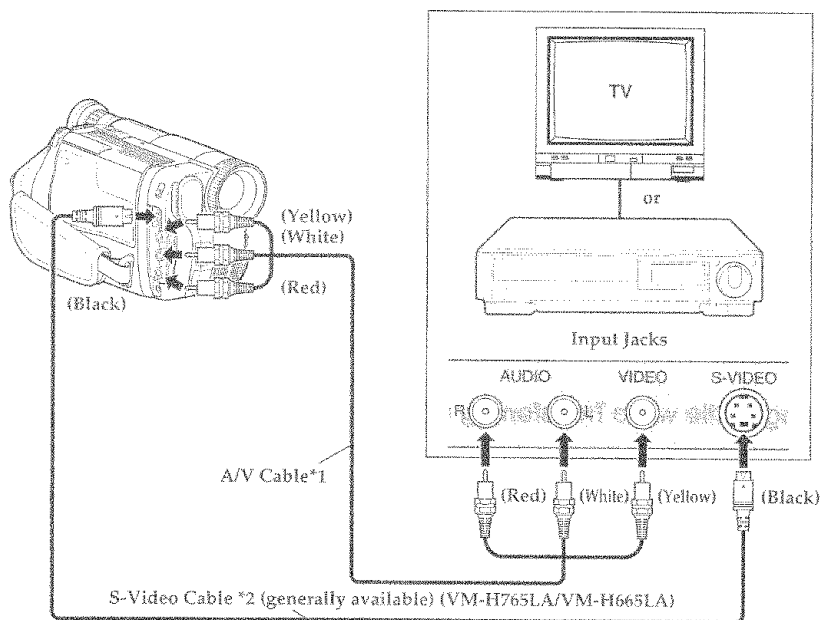

*1: The VM-H765LA is provided with a stereo A/V cable; the VM-E465LA/VM-E565LA/VM-H665LA, with a monaural A/V cable. Connect the cable plugs to the jacks on TV or VCR, making sure to match the colors. VM-H665LA/VM-E565LA/VM-E563LA/VM-E465LA: If your TV or VCR is stereo, connect the audio plug to the L jack (white).

*2: The VM-H765LA/VM-H665LA can use a generally available S-video cable. If your TV or VCR has an S-VIDEO jack, connect the S-video cable instead of the yellow VIDEO plug.

VM-H765LA:

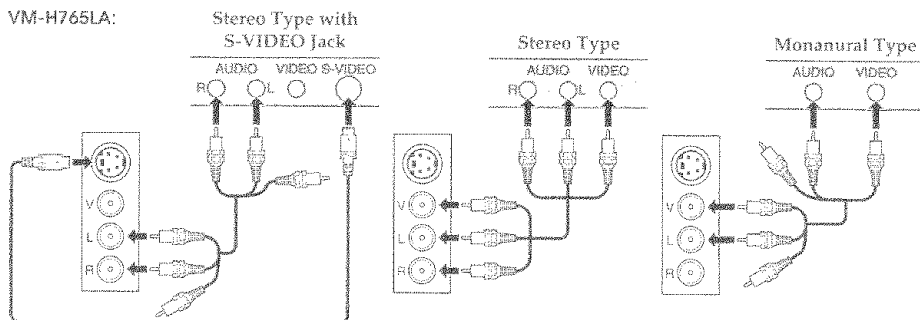

VM-H665LA:

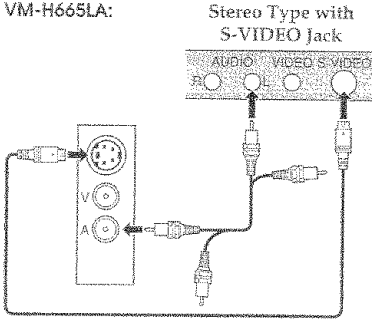

Stereo Type

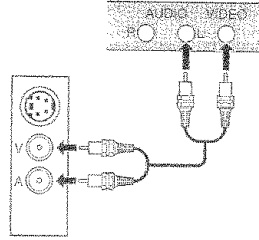

Monaural Type

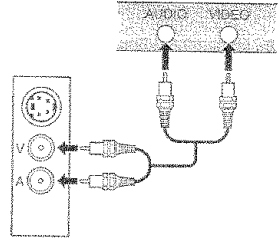

VM-E565LA/
VM-E563LA/
VM-E465LA:

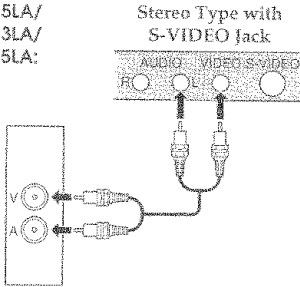

Stereo Type

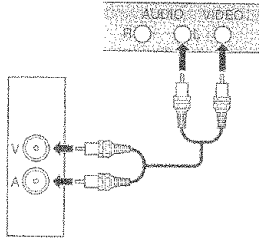

Monaural Type

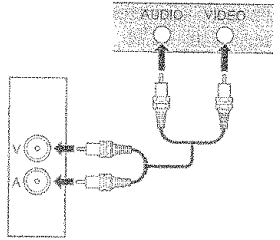

● Playing Back Your Recording on the TV Screen

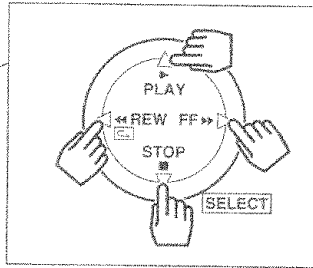
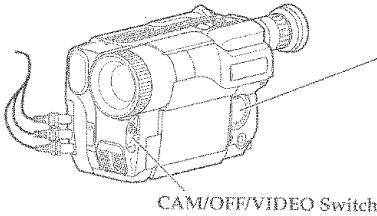

- 1 Connect your camcorder and TV or VCR using the provided A/V cable, as illustrated on pages 50~51.
- 2 Insert a previously recorded cassette into the camcorder.
- 3 Turn on your TV and/or VCR and place it in the camcorder input mode (consult your TV or VCR manual for details).
- 4 Hold down the small button on the CAM/OFF/VIDEO switch while sliding the switch to VIDEO.
- 5 Press the PLAY button to begin playback.
- 6 Press the STOP button when finished.

Note: Reduce the volume of the camcorder as low as possible when the LCD monitor is open; if you fail to do so, the played back pictures may be distorted.

Note: It is recommended that you close the LCD monitor to save power whenever you play back a picture on a TV.

Dubbing from the Camcorder to a VCR

Connect the camcorder to a VCR to copy your or a friend's home 8mm recordings to VHS.

- 1** Connect your camcorder to the VCR, following "Playing Back Your Recording on Your TV" on pages 50~51.
- 2** Turn on your VCR and place it in the camcorder input mode (consult your VCR manual for details). Operate the television as you normally do to see the signal coming from the VCR.
- 3** Hold down the small button of the CAM/OFF/VIDEO switch while you slide the switch to VIDEO.
- 4** Insert the recorded tape in the camcorder and a blank tape into the VCR. Set the VCR to record.
- 5** Play the tape from the camcorder while recording on the VCR.

Note: If the VCR is connected to a television and the VCR/TV selector is set to VCR, you can monitor the tape being dubbed.

Note: Reduce the volume of the camcorder as low as possible during dubbing. Otherwise the played back pictures could be distorted.

Note: During multi playback (PAL60 output/M-PAL output), dubbing may not be possible with some VCRs.

Using Audio/Video Dubbing

Use audio/video dubbing to record audio and video from the camcorder's built-in microphone and camcorder onto a previously recorded tape in the camcorder.

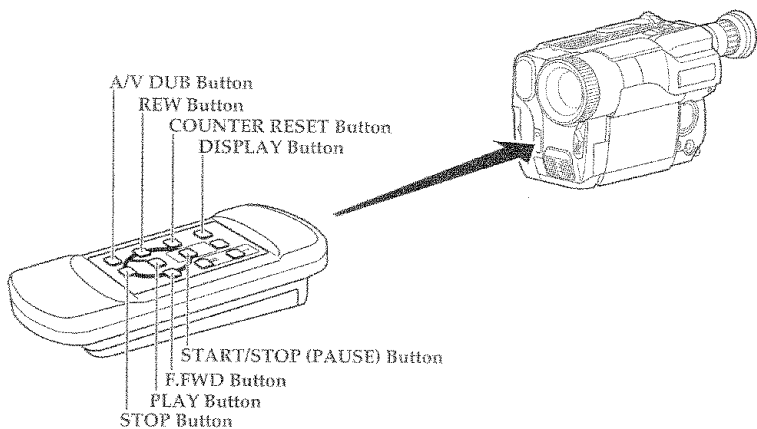

- 1 Hold down the small button on the CAM/OFF/VIDEO switch while sliding the switch to VIDEO.
- 2 Insert a previously recorded tape in the camcorder.
- 3 Use the wireless remote control and press the PLAY button. Use the PLAY, F.FWD, and REW buttons to find the place where you want to stop dubbing.
- 4 Display the linear time counter with memory ("Using Memory," p45). Press the COUNTER RESET button to set the linear time counter to "0:00:00M".
- 5 Use the REW and PLAY buttons to find where you wish to start dubbing.
- 6 Place the CAM/OFF/VIDEO switch to CAM position. The record pause indicator "●II" appears and the camcorder is ready to record.
- 7 Press and hold the A/V DUB button, then press PLAY. This places the camcorder A/V DUB pause mode. "●II" disappears replaced by "A/V DUB II".
- 8 Press the Start/Stop button on the camcorder or START/STOP (PAUSE) on the remote control. The audio/video dubbing starts. When the linear time counter reaches "0:00:00M" the camcorder stops automatically, recording only the portion of the tape that you selected.
Note: If the camcorder is in AV DUB pause or STILL mode for more than 5 minutes, the camcorder stops automatically to protect the tape.
Note: When the audio/video dubbed portion is played back, noise may appear at the end of the dubbed portion.

Multi Playback

This camcorder can convert an NTSC recorded tape into "PAL60" format signal. "PAL60" is a special output signal format with which a PAL TV can be used to view a tape recorded on an NTSC recorder.

- 1 Connect the camcorder to PAL TV as shown in the figure on pages 50 and 51.
- 2 Turn the TV on and select the TV "video input". Set the TV to the PAL60 mode.
- 3 Set the CAM/OFF/VIDEO switch of the camcorder to VIDEO.
- 4 Press the MENU button:
The menu display will appear.

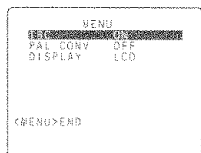

- 5 Press the STOP or PLAY button to select "PAL CONV.". The menu display will change.

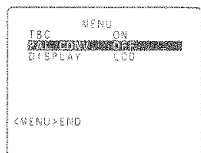

- 6 Press the FF or REW button to display "PAL60" or "M PAL".

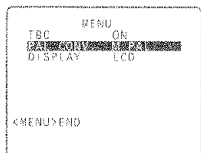

- 7 Press the MENU button.

- 8 Press the PLAY button of the camcorder. "PAL60" or "M PAL" will appear in the viewfinder or on the LCD monitor.



- 9 When playback is finished, set the CAM/OFF/VIDEO switch to OFF position.

Note: Connect the camcorder to a TV monitor which has a vertical sync adjustment circuitry (volume) for 60 Hz and which can also be locked into the PAL60 mode. Refer to the TV instruction manual for details on how to set the TV.

Note: This camcorder cannot record using the PAL60 system.

Note: Depending on the state of the tape recorded, this function may not operate normally.

Note: This function will be released when the camcorder is turned off.

TBC (Time Base Corrector) ON or OFF

With TBC specified ON, you can suppress fluctuations or distortion in picture that may occur when tapes recorded by other camcorders are played back, or any distortion caused by tape stretch or inconsistent tape running that occur when dubbing is repeated.

- 1 Set the CAM/OFF/VIDEO switch to VIDEO.
- 2 Press the MENU button.
- 3 Press the STOP or PLAY button to select "TBC".
- 4 Press the FF button to display "ON".
- 5 Press the MENU button.

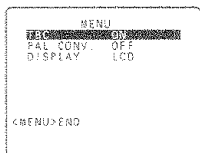

Note: In some cases, fluctuations or distortion in picture cannot be suppressed even when "TBC ON" has been specified.

Note: Depending on the tape used, playback pictures may fluctuate up and down with "TBC ON" specified. In this case, specify "TBC OFF".

Attaching a Wide or Tele Converter Lens

Screw the lens into the threads on the camcorder lens assembly.

Note: If the tele-conversion lens is attached over the lens, the four corners of the image will be missing in the wide-angle position. Use zoom in the telephoto position.

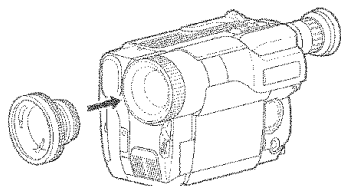

Using the Built-in DC Light (for VM-H765LA/VM-E565LA)

Use the built-in DC light if you wish to shoot objects in dark places.

When the LIGHT switch is set to "AUTO", the light turns on automatically when the camcorder is pointed at objects in a dark place and turns off when it is pointed at objects in a bright place.

CAUTION: Since the power consumption of the light is high, the camcorder operating time will decrease even with a fully charged battery.

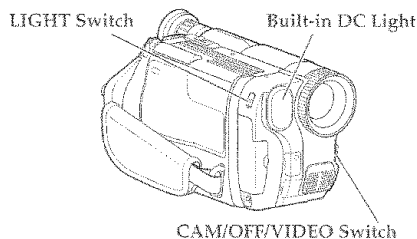

1 Make sure that a fully charged battery pack is attached.

2 Set the CAM/OFF/VIDEO switch to CAM and then set the LIGHT switch to AUTO when required.

Note: When the LIGHT switch is set to ON, the light will turn on whenever you make a recording.

Note: If the LIGHT switch is set to AUTO, the light may not turn on immediately.

Note: If the light turns on for more than 5 minutes with the LIGHT switch set to "AUTO" or "ON", when the camcorder is in the record pause mode, the camcorder and light will automatically turn off. In such a case, turn the camcorder on again.

Note: If the LIGHT switch is set to AUTO and the camcorder is pointed at a white subject with high reflectivity in a dark place from a short distance, the light may turn on or off. In this case, set the LIGHT switch to ON.

Note: The light will turn off during quick edit or review, even if you have manually turned on the light.

Note: The light will not turn on when the CAM/OFF/VIDEO switch is set to VIDEO.

Note: If there is no cassette in the camcorder, or if a recording prevented cassette is inserted with the LIGHT switch set to AUTO, the light will automatically go out after 5 minutes.

CAUTION: Turn the light on only when you need it, otherwise the operating time of the battery pack is shortened due to the power consumption of the light.

3 After use, set the LIGHT switch to OFF or set the CAM/OFF/VIDEO switch of the camcorder to OFF position.

CAUTIONS:

- During operation and/or after use of the light, the front surface and lamp of the light will be very hot. To avoid burns or hair damage, do not touch them with your hand.
- When the light is on, do not allow water to drop on the light.
- When the light is on, avoid subjecting the light to impacts or sharp vibrations.
- Do not cover the light with paper or other objects, since the air flow will be interrupted, resulting in possible overheating hazard.
- Never use the light in the vicinity of explosive or highly inflammable materials.
- After using the light, cool the light section sufficiently before storing the camcorder in the case.
- The lamp can only be replaced by a service engineer. If the lamp has blown, consult your nearest service center.

CAUTION: Do not hold the unit by the light when carrying as this could cause a malfunction.

General Maintenance

Cleaning the Camcorder Heads

Dirt can accumulate on the video heads on the camcorder causing the playback picture to become blurred or appear as if video information is lost. This often means that the video heads are dirty. Use a video head cleaner such as a dry type head cleaning tape to clean the heads.

If after cleaning the heads the picture does not clear up consult your nearest dealer or VCR service center for professional head cleaning.

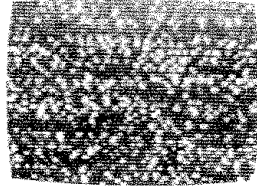

Cleaning the Lens and Picture Tube of the Electronic Viewfinder

The lens of the electronic viewfinder can be user-cleaned if dust, dirt, or other foreign matter adheres to it.

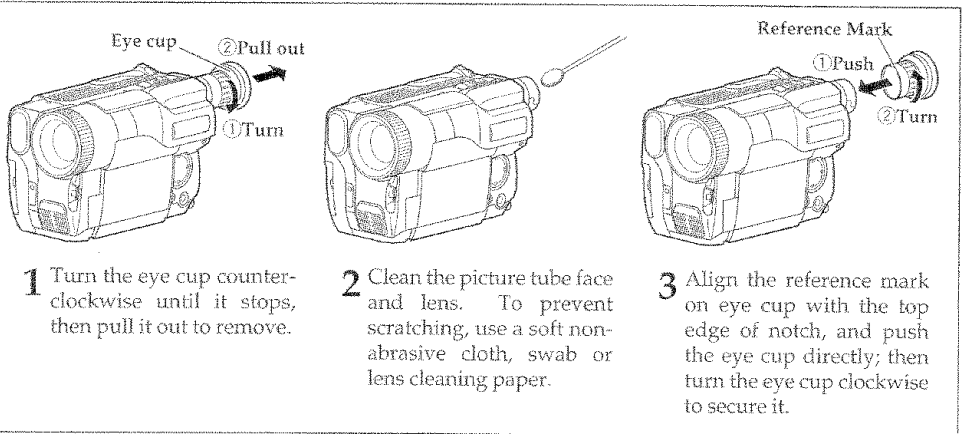

Periodic Maintenance

A precision electromechanical device, the Hitachi VM-H765LA/VM-H665LA/VM-E565LA/VM-E563LA/VM-E465LA requires maintenance after a period of normal use. We expect that no maintenance other than head cleaning will be required during the period of warranty unless the camcorder is used either heavily or seldom. Defective parts are covered by the warranty. Normal maintenance is the responsibility of the owner. Consult your dealer or local VCR service center for recommendations regarding normal maintenance based on your use patterns, location, and the age of the camcorder.

Troubleshooting

Quality is very important at Hitachi. We inspect and check every camcorder carefully at the factory under the most rigid quality control and inspection systems. If problems develop please check the following possible solutions before inquiring about professional service.

INSERTING OR REMOVING THE CASSETTE

Symptom	Check Point & Correction
Cassette holder cannot be opened when you slide the EJECT switch.	• Connect the power source.
Cassette cannot be inserted into cassette compartment.	• Load cassette in direction indicated by arrow on cassette. • Cassette window must be toward outside.

CAMERA RECORDING

Symptom	Check Point & Correction
Picture does not appear in the viewfinder or on the LCD monitor.	• Slide the CAM/OFF/VIDEO switch to CAM.
The camcorder cannot go into the recording mode, even when the Start/Stop button is pressed.	• Check the record-protect tab on the cassette. See page 22 for details. • Slide the CAM/OFF/VIDEO switch to CAM.
Picture is out of focus. Auto-focus does not operate.	• Make sure that "FOCUS" does not appear in the viewfinder or on the LCD monitor. If it is displayed, press FOCUS/VOL. control buttons to erase it. • Auto-Focus does not operate if a special-effects filter is attached or the objects shown on page 30 are being recorded.
The created title does not appear.	• Insert the clock battery, then create a title. • Do not remove the clock battery after creating a title. • When the stored title (prememo) is displayed in the viewfinder or on the LCD monitor, press the REW button.



NO OPERATION IS ACCEPTED

Symptom	Check Point & Correction
Power is turned on, but no button operations are accepted.	• Remove the power source and the clock battery. And after about one minute, the display in the viewfinder or on the LCD monitor will be reset. Then set the information again.

PLAYBACK OF PRERECORDED CASSETTE

Symptom	Check Point & Correction
The PLAY button cannot be engaged.	<ul style="list-style-type: none"> • Set the CAM/OFF/VIDEO switch to VIDEO.
Picture bends at the top of TV screen.	<ul style="list-style-type: none"> • TV receiver is of older type. It needs to be modified to work properly with camcorder. • Tape is damaged. Try another cassette.
Color of your TV screen is too bright, too faint or change.	<ul style="list-style-type: none"> • TV set has VIR circuit. Turn it off during playback.
Date search function does not operate.	<ul style="list-style-type: none"> • Slide the CAM/OFF/VIDEO switch to VIDEO. • Insert the clock battery, set the date and time, then start recording. • Do not remove the clock battery after recording. • Do not eject the recorded cassette. Leave it in the camcorder.

BATTERY CONDITION

Symptom	Check Point & Correction
The () indication in the electronic viewfinder or on the LCD monitor flashes to indicate battery is discharged.	<ul style="list-style-type: none"> • Try another battery or charge the battery.
The battery level indicator () appears differently on the LCD monitor and in the viewfinder.	<ul style="list-style-type: none"> • This does not indicate a fault; it is because the power consumed by the LCD monitor and viewfinder is different.

TAPE DISPLAY

Symptom	Check Point & Correction
"TAPE" appears in the viewfinder or on the LCD monitor.	<ul style="list-style-type: none"> • Have you moved the camcorder or cassette from a cold place to a warm place so that its temperature changed abruptly? If the temperature has changed, remove the cassette and set the CAM/OFF/VIDEO switch to OFF, then wait for about one hour. • Remove the cassette and then try to reinsert; remove it several times. If the indication is still shown in the viewfinder or on the LCD monitor, use a cleaning tape to clean the heads and replace the cassette.

CAMCORDER MALFUNCTIONS

Symptom	Check Point & Correction
Random letters appear in the viewfinder or on the LCD monitor, or normal operation is interrupted.	<ul style="list-style-type: none"> • External interference may have caused the camcorder's microprocessor to malfunction temporarily. If random letters appear in the viewfinder or on the LCD monitor, or if normal operation is interrupted, remove the power source and clock battery, and then reattach them; the camcorder functions will return to their default settings.

Specifications

General Specifications

Power requirements	7.2V DC
Power consumption	VM-H765LA: 3.6W (when recording/LCD monitor OFF) 4.1W (when recording/LCD monitor ON) VM-H665LA: 3.5W (when recording/LCD monitor OFF) 4.0W (when recording/LCD monitor ON) VM-E565LA: 3.4W (when recording/LCD monitor OFF) 3.8W (when recording/LCD monitor ON) VM-E563LA: 3.4W (when recording/LCD monitor OFF) 3.8W (when recording/LCD monitor ON) VM-E465LA: 3.4W (when recording/LCD monitor OFF) 3.8W (when recording/LCD monitor ON)
Dimensions	4-3/8" W x 4-3/8" H x 7-15/16" D (111.5 mm x 111.5 mm x 202 mm)
Weight	1.84 lbs (approx. 836g) without battery pack and cassette
Operating temperature	32°F ~ 104°F (0°C ~ 40°C)
Storage temperature	-4°F ~ 140°F (-20°C ~ 60°C)

Video Recorder Specifications

Format	8 mm
Record/playback	Two video record/playback heads
Video signal	EIA standard NTSC color
Tape speed	14.3 mm/sec
Video output	1.0 Vp-p, 75 ohm
Audio output	-7.8 dBs (316mVrms)
Fast forward/rewind time	Less than 8 minutes with P6-120 cassette

Camera Specifications

Scanning	525 lines/60 fields/30 frames
Required minimum illumination	VM-H765LA: 0.5 lx VM-H665LA: 0.5 lx VM-E565LA: 0.3 lx VM-E563LA: 0.3 lx VM-E465LA: 0.3 lx
Pickup device	1/4" C.C.D.
Lens	F1.6 - 3.8 (4 ~ 88 mm) 22:1 power zoom lens with auto focus and auto iris functions
Lens diameter	46 mm

For U.S.A. only

HITACHI

*service
hotline*

To locate an authorized
HITACHI service facility in
the continental U.S.A.

DIAL TOLL FREE

7 days a week, 24 hours a day

800 HITACHI

1-800-448-2244

Hitachi America, Ltd. Home Electronics Division





Hitachi has made every effort to assure you hours of trouble free operation from your unit. However, should you require service, a network of Hitachi Authorized Service Facilities has been established in all 50 states and Puerto Rico. Each facility will provide you with convenient and expedient assistance. Our service "Hotline" operator will direct you to the Hitachi Authorized Service Facility nearest you. Just present proof of purchase and/or delivery receipts to the Hitachi Authorized Service Facility and service will be rendered in accordance with the terms of the limited warranty as stated on your warranty card or operating guide.

Should you have any questions regarding in-warranty service, operation or technical assistance, please contact:

Hitachi America, Ltd. Home Electronics Division

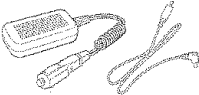
1855 Dornoch Court
San Diego, CA 92173
Tel. 1-800-HITACHI
(1-800-448-2244)

Available Accessories

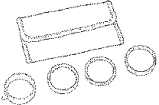
PARTS NO.	APPEARANCE	PURPOSE	PARTS NO.	APPEARANCE	PURPOSE
P6-120SRG	CASSETTE TAPE 		VM-CC80A KIT	CAR BATTERY CORD DC CORD 	Dc power source for camcorder using cigarette lighter socket
SVA50	TRIPOD 	Stationary shooting unit for mounting camcorder	VM-BPL13		Rechargeable Li-ion battery (1350mAh Type)
VM-BPL30		Rechargeable Li-ion battery (3000mAh Type)	VM-BPL60		Rechargeable Li-ion battery (6000mAh Type)
VM-FL60K	FILTER KIT 	Filters for special effects			

To place an order for any of these items call our toll free number.

1-800-HITACHI
(1-800-448-2244)

To Order in the United States

By Phone

1-800-HITACHI
(1-800-448-2244)

In Canada - Please use Canadian order form in French version of this manual - Page 63.

FOR AUTHORIZED HITACHI SERVICE FACILITY IN CANADA

Please consult the following telephone number:

1-800-HITACHI
(1-800-448-2244)

