

<http://us.lgservice.com>



MICROWAVE OVEN

OWNER'S MANUAL

PLEASE READ THIS OWNER'S MANUAL
THOROUGHLY BEFORE OPERATING.

LMV2053SB
LMV2053ST
LMV2053SW

Thank you for purchasing a LG microwave oven.

Please record the model number and serial number of this unit for future reference. We also suggest you record the details of your contact with LG (LG Electronics U.S.A., Inc.) concerning this unit.

Model No: _____

Serial No: _____

Dealer: _____

Dealer Phone No: _____

Staple your receipt here for proof of purchase.

Customer Relations
LG Electronics U.S.A., Inc.
Service Division Bldg. #3
201 James Record Rd.
Huntsville, AL 35824-0126

PRECAUTIONS TO AVOID POSSIBLE EXPOSURE TO EXCESSIVE MICROWAVE ENERGY...

- (a) Do not attempt to operate this oven with the door open since open-door operation can result in harmful exposure to microwave energy. It is important not to defeat or tamper with the safety interlocks.
- (b) Do not place any object between the oven front face and the door or allow soil or cleaner residue to accumulate on sealing surfaces.
- (c) Do not operate the oven if it is damaged. It is particularly important that the oven door closes properly and that there is no damage to the:
 - (1) Door (bent),
 - (2) Hinges and latches (broken or loosened),
 - (3) Door seals and sealing surfaces.
- (d) The oven should not be adjusted or repaired by anyone except properly qualified service personnel.

TABLE OF CONTENTS

| | |
|------------------------------------------------------------------------------------|-------|
| PRECAUTIONS TO AVOID POSSIBLE EXPOSURE TO EXCESSIVE MICROWAVE ENERGY. | 2 |
| TABLE OF CONTENTS. | 3 |
| SAFETY | 4 |
| INFORMATION | 6 |
| Location of Model Number | 6 |
| Oven Specifications | 6 |
| Electrical Requirements | 6 |
| Grounding Instructions | 6 |
| Microwave Oven Features | 7 |
| Control Panel Features | 8 |
| OPERATION | 10 |
| Learn About Your Microwave Oven | 10 |
| Clock | 10 |
| Timer | 10 |
| Vent Fan | 10 |
| Vent Auto Time Set..... | 10 |
| Custom Cook | 10~11 |
| Light Hi/Low/Off | 11 |
| Child Lock | 11 |
| EZ-ON | 11 |
| TURNTABLE ON/OFF | 11 |
| Hold Warm | 11 |
| Custom Set | 12 |
| More/Less | 12 |
| Cooking at High Power Levels | 12 |
| Cooking at Lower Power Levels | 12 |
| Cooking With More Than One Cook Cycle | 12 |
| Cooking Guide for Lower Power Levels | 13 |
| Sensor Operating Instructions | 14 |
| Sensor Cooking Guide | 14 |
| Sensor Popcorn | 14 |
| Sensor Cook | 15 |
| Sensor Reheat | 15 |
| Chicken Choices | 15 |
| Soften | 16 |
| Melt | 16 |
| Sensor Cook Table | 17 |
| Sensor Reheat Table | 17 |
| Chicken Choices Table | 18 |
| Soften Table | 19 |
| Melt Table | 19 |
| Auto Defrost | 20 |
| Quick Defrost | 20 |
| Time Defrost | 21 |
| Defrost Tips | 21 |
| Metal Rack | 21 |
| COOKING | 22 |
| Getting the Best Cooking Results | 22 |
| Fish and Shellfish | 22 |
| Fish and Shellfish Cooking Table | 22 |
| Appetizers /Sauces /Soups | 23 |
| Meat | 23 |
| Meat Cooking Table | 24 |
| Chicken | 25 |
| Chicken Cooking Table | 25 |
| Pasta and Rice | 26 |
| Pasta Cooking Table | 26 |
| Rice Cooking Table | 26 |
| MAINTENANCE | 27 |
| Care and Cleaning | 27 |
| Metal Rack | 27 |
| Cleaning the Grease Filters | 27 |
| Charcoal Filter Replacement | 28 |
| Cooktop/Night Light Replacement | 28 |
| Oven Light Replacement | 28 |
| COOKING UTENSILS | 29 |
| Microwave Utensil Guide | 29 |
| TROUBLESHOOTING | 30 |
| Before Calling for Service | 30 |
| Questions and Answers | 31 |
| LIMITED WARRANTY | 32 |

SAFETY

IMPORTANT SAFETY INSTRUCTIONS

The safety instructions below will tell you how to use your oven and avoid harm to yourself or damage to your oven.

 **WARNING** - To reduce the risk of burns, electric shock, fire, injury to persons, or exposure to excessive microwave energy.

- **Read all the instructions before using your oven.**
- **Do not allow children to use this oven without close supervision.**
- Read and follow the specific **PRECAUTIONS TO AVOID POSSIBLE EXPOSURE TO EXCESSIVE MICROWAVE ENERGY** found on page 2.
- **Do not use** corrosive chemicals or vapors, such as sulfide and chloride, in this appliance. This type of oven is specifically designed to heat, cook, or dry food. It is not designed for industrial or laboratory use.
- **Do not use or store** this appliance outdoors. Do not use this product near water - for example, near a kitchen sink, in a wet basement, or near a swimming pool, and the like.
- **Do not use** the cavity for storage purposes. Do not leave paper products, cooking utensils, or food in the cavity when not in use.
- **Clean the ventilating hood frequently.** Do not allow grease to accumulate on the hood or the filters.
- Use care when cleaning the vent hood filters. Corrosive cleaning agents such as lye-based oven cleaners may damage the filters.
- **Do not tamper with the built-in safety switches on the oven door.** The oven has several built-in safety switches to make sure the power is off when the door is open.
- If food flames under the hood, turn the fan on.
- Suitable for use above both gas and electric cooking equipment 36 inches wide or less.
- **Do not use this oven for commercial purposes.** It is made for household use only.
- **When cleaning the door and the surfaces that touch the door, use only mild, non-abrasive soaps or detergents and a sponge or soft cloth.**
- **If your oven is dropped or damaged,** have it thoroughly checked by a qualified service technician before using it again.
- **To avoid a fire hazard:**
 - **Do not severely overcook food.** Severely overcooked foods can start a fire in the oven. Watch the oven carefully, especially if you have paper, plastic, or other combustibles in the oven.
 - **Do not store combustible items (bread, cookies, etc.) in the oven,** because if lightning strikes the power lines it may cause the oven to turn on.
 - **Do not use wire twist-ties in the oven.** Be sure to inspect purchased items for wire twist-ties and remove them before placing the item in the oven.
- **If a fire should start:**
 - **Keep the oven door closed.**
 - **Turn the oven off.**
 - **Disconnect the power cord or shut off the power at the fuse or circuit breaker panel.**
- **To avoid electric shock:**
 - **This appliance must be grounded.** Connect it only to a properly grounded outlet. See the electrical **GROUNDING INSTRUCTIONS** on page 6.
 - **Do not operate this appliance if it has a damaged cord or plug,** if it is not working properly or if it has been damaged or dropped.
 - **Do not immerse the electrical cord or plug in water.**
 - **Keep the cord away from heated surfaces.**

SAFETY

- **To avoid improperly cooking some foods.**
 - **Do not heat any types of baby bottles or baby food.** Uneven heating may occur and possibly cause personal injury.
 - **Do not heat small-necked containers,** such as syrup bottles.
 - **Do not deep-fat fry in your microwave oven.**
 - **Do not attempt home canning in your microwave oven.**
 - **Do not heat the following items in the microwave oven:** whole eggs in the shell, water with oil or fat, sealed containers, or closed glass jars. These items may explode.
- Do not cover or block any openings in the oven.
- Use your oven only for the operations described in this manual.
- Do not run the oven empty, without food in it.
- Secure the cord in the cabinet above the oven.
- **Preserve the oven floor:**
 - **Do not heat the oven floor excessively.**
 - **Do not** allow the gray film on special microwave-cooking packages to touch the oven floor. Put the package on a microwavable dish.
 - **Do not** cook anything directly on the oven floor or turntable. Use a microwavable dish.
- Keep a browning dish at least 3/16 inch above floor. Carefully read and follow the instructions for the browning dish. If you use a browning dish incorrectly, you could damage the oven floor.
- Install or locate this appliance only in accordance with the provided installation instructions.
- This appliance should be serviced only by qualified service personnel. Contact the nearest authorized service facility for examination, repair, or adjustment.
- Liquids, such as water, coffee, or tea can be overheated beyond the boiling point without appearing to be boiling. Visible bubbling or boiling when the container is removed from the microwave oven is not always present.
THIS COULD RESULT IN VERY HOT LIQUIDS SUDDENLY BOILING OVER WHEN THE CONTAINER IS DISTURBED OR A SPOON OR OTHER UTENSIL IS INSERTED INTO THE LIQUID. To reduce the risk of injury to persons;
 - Do not overheat the liquid.
 - Stir the liquid both before and halfway through heating it.
 - Do not use straight-sided containers with narrow necks.
 - After heating, allow the container to stand in the microwave oven for a short time before removing the container.
 - Use extreme care when inserting a spoon or other utensil into the container.

SAVE THESE INSTRUCTIONS

FEDERAL COMMUNICATIONS COMMISSION RADIO FREQUENCY INTERFERENCE STATEMENT (U.S.A. ONLY)

WARNING:

This equipment generates and uses ISM frequency energy and if not installed and used properly, that is in strict accordance with the manufacturer's instructions, may cause interference to radio and television reception. It has been type tested and found to comply with limits for ISM Equipment pursuant to part 18 of FCC Rules, which are designed to provide reasonable protection against such interference in a residential installation. However, there is no guarantee that interference will not occur in a particular installation. If this equipment does cause interference to radio or television reception, which can be determined by turning the equipment off and on, the user is encouraged to try to correct the interference by one or more of the following:

- Reorient the receiving antenna of the radio or television.
- Relocate the Microwave Oven with respect to the receiver.
- Move the microwave oven away from the receiver.
- Plug the microwave oven into a different outlet so that the microwave oven and the receiver are on different branch circuits.

The manufacturer is not responsible for any radio or TV interference caused by **unauthorized modification** to this microwave oven. It is the responsibility of the user to correct such interference.

INFORMATION

Please read this owner's manual. It will tell you how to use all the fine features of this microwave oven.

LOCATION OF MODEL NUMBER

To request service information or replacement parts, the service center will require the complete model number of your microwave oven. The number is on the oven front as shown in the illustration below.

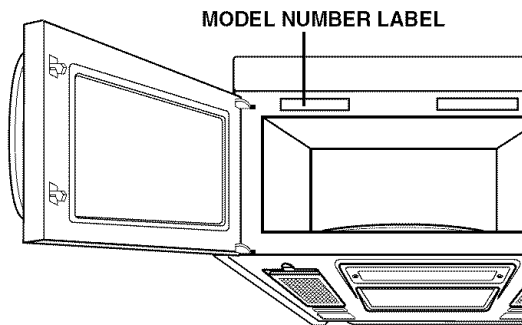

OVEN SPECIFICATIONS

| | |
|------------------|-----------------------------------------------------------------------------------------------------------|
| Output Power | 1,100W (IEC60705) |
| Outer Dimensions | 29 ¹⁵ / ₁₆ " x 16 ⁷ / ₁₆ " x 15 ⁵ / ₈ " |
| Cavity Volume | 2.0 Cu.ft |
| Net Weight | 60 lbs. |

ELECTRICAL REQUIREMENTS

The oven is designed to operate on a Standard 120V/60Hz household outlet. Be sure the circuit is at least 15A or 20A and the microwave oven is the **only appliance on the circuit**. It is not designed for 50Hz or any circuit other than a 120V/60Hz circuit.

GROUNDING INSTRUCTIONS

This appliance must be grounded. If an electrical short circuit occurs, grounding reduces the risk of electric shock by providing an escape wire for the electric current. The cord for this appliance has a grounding wire with a grounding plug. Put the plug into an outlet that is properly installed and grounded.

⚠ WARNING - If you use the grounding plug improperly, you risk electric shock.

Ask a qualified electrician if you do not understand the grounding instructions or if you wonder whether the appliance is properly grounded.

Because this appliance fits under the cabinet, it has a short power-supply cord. See the separate Installation Instructions for directions on placing the cord properly. Keep the electrical power cord dry and do not pinch or crush it in any way.

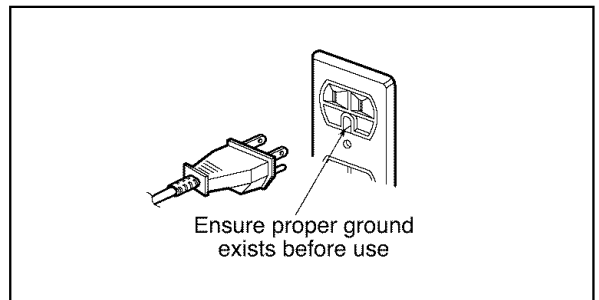

INFORMATION

MICROWAVE OVEN FEATURES

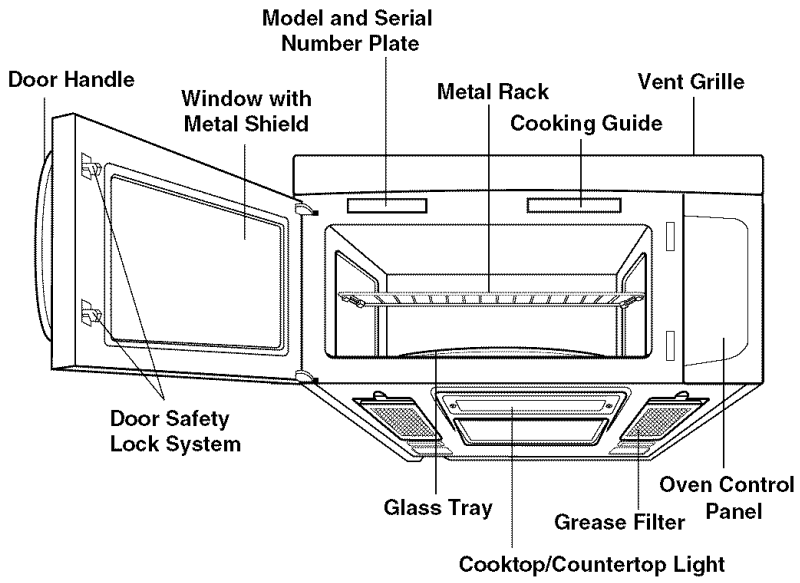

INFORMATION

CONTROL PANEL FEATURES

Your microwave oven control panel lets you select the desired cooking function quickly and easily. All you have to do is touch the necessary Command pad. The following is a list of all the Command and Number pads located on the control panel. **For more information on these features, see the OPERATION section.**

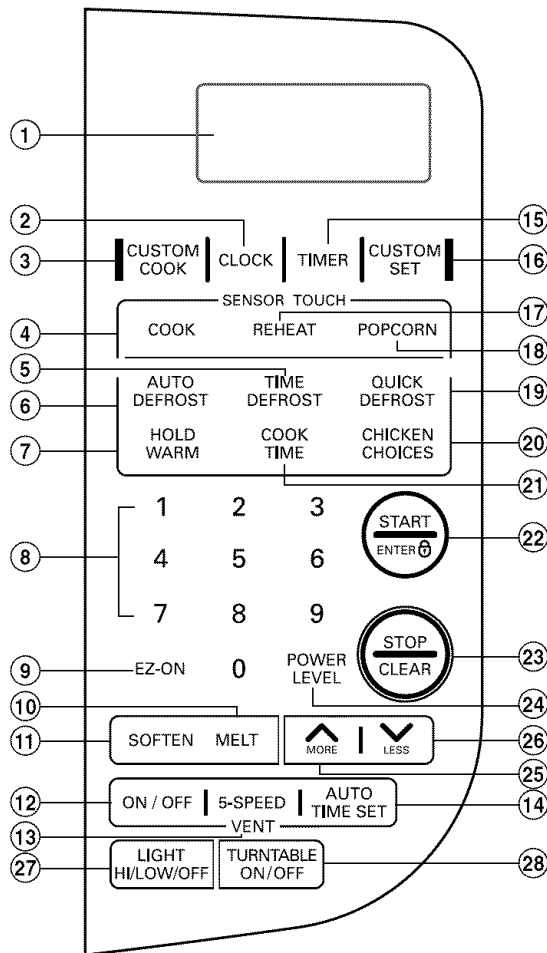

INFORMATION

NOTE: Styling and features vary by model.

1. **DISPLAY:** The Display includes a clock and indicators to tell you time of day, cooking time setting, and cooking functions selected.
2. **CLOCK:** Touch this pad to enter the time of day.
3. **CUSTOM COOK:** Touch this pad to recall one cooking instruction previously programmed into memory.
4. **COOK:** Touch this pad to cook Baked Potato, Vegetable Casserole, Rice, and Frozen Entrée. The oven's sensor will tell the oven how long to cook depending on the amount of humidity coming from the food.
5. **TIME DEFROST:** Touch this pad to defrost most other frozen foods.
6. **AUTO DEFROST:** Meat, poultry, fish, and bread. Touch this pad to select food type and defrost food by weight.
7. **HOLD WARM:** Touch this pad to keep hot, cooked foods warm in your microwave oven for up to 90 minutes.
8. **NUMBER:** Touch number pads to enter cooking time, power level, quantities, or weights.
9. **EZ-ON:** Touch this pad to set and start quickly at 100% power level.
10. **MELT:** Touch this pad to melt Butter Margarine, Chocolate, Cheese and Marshmallows.
11. **SOFTEN:** Touch this pad to soften Butter, Ice Cream, Cream Cheese and Frozen Juice.
12. **VENT ON/OFF:** Touch this pad to turn the fan on/off.
13. **VENT 5-SPEED:** Touch this pad to choose one of 5 fan speeds.
14. **VENT AUTO TIME SET:** Touch this pad when setting ventilation time. (1, 3, 5, 10, and 30 minutes.)
15. **TIMER:** Touch this pad to set the timer.
16. **CUSTOM SET:** Touch this pad to change the oven's default setting for sound, clock, disply speed, and defrost weight.
17. **REHEAT:** Touch this pad to reheat Pizza, Dinner Plate, Soup/Sauce, and Casserole. The oven's sensor will tell the oven how long to cook depending on the amount of humidity coming from the food.
18. **POPCORN:** Touch this pad when popping popcorn in your microwave oven. The oven's sensor will tell the oven how long to cook depending on the amount of humidity it detects from the popcorn.
19. **QUICK DEFROST:** This pad provides quick defrost for 1.0 pound of frozen food.
20. **CHICKEN CHOICES:** Touch this pad to cook chicken wings, chicken nuggets, spicy chicken, and Mexican chicken.
21. **COOK TIME:** Touch this pad to to set a cooking time.
22. **START/ENTER:** Touch this pad to start a function. If you open the door after oven begins to cook, touch START/ENTER again.
23. **STOP/CLEAR:** Touch this pad to stop the oven or to clear all entries.
24. **POWER LEVEL:** Touch this pad to select a cooking power level.
25. **MORE:** Touch this pad to add ten seconds of cooking time each time you press it.
26. **LESS:** Touch this pad to subtract ten seconds of cooking time each time you press it.
27. **LIGHT HI/LOW/OFF:** Touch this pad to turn on the the light on high, low, or off.
28. **TURNTABLE ON/OFF:** Touch this pad to turn on/off the turntable. This option is not available in sensor cook and defrost modes.

OPERATION

LEARN ABOUT YOUR MICROWAVE OVEN

This section discusses the concepts behind microwave cooking and introduces you to the basics you need to know to operate your microwave oven. Please read this information before using your oven.

CAUTION

To avoid risk of personal injury or property damage, do not run the oven empty.

To avoid risk of personal injury or property damage, do not use stoneware, aluminum foil, metal utensils, or metal trimmed utensils in the oven. Keep aluminum foil at least 1 inch from the oven wall metal rack and other pieces of foil.

CLOCK

This oven includes a 12-hour clock.

Example: To set 8:00 AM.

| CLOCK |

1. Touch **CLOCK**.

8 0 0

2. Enter the time by using the number keys.

START
ENTER 

3. Touch **START/ENTER**.
(Press 1 for AM, 2 for PM.)

START
ENTER 

4. Touch **START/ENTER**.

TIMER

You can use your microwave oven as a timer. Use the Timer for timing up to 99 minutes, and 99 seconds.

Example: To set for 3 minutes.

| TIMER |

1. Touch **TIMER**.

3 0 0

2. Enter the time by using the number keys.

START
ENTER 

3. Touch **START/ENTER**.
When the time is over, you will hear beeps and **END** will display.

VENT FAN

The fan moves steam and other vapors from the cooking surface. There are five speeds.

Example for Level 4:

ON / OFF |

1. Touch **ON/OFF**. This shows the last level until you select the fan speed level.

| 5-SPEED |
— VENT —

2. Touch until **LEVEL 4** appears in the display.

Touch **ON/OFF** to turn off fan when desired.

NOTE: If the temperature from the range or cooktop below the oven gets too hot, the exhaust fan in the vent hood will automatically turn on at the LEVEL 4 setting to protect the oven.

It may stay on up to an hour to cool the oven. When this occurs, the **ON/OFF** will not turn the fan off.

VENT AUTO TIME SET

Example: To set 30 minutes for Level 4.

ON / OFF |

1. Touch **ON/OFF**.

| 5-SPEED |
— VENT —

2. Touch until **LEVEL 4** appears in the display.

AUTO
TIME SET

3. Touch **Auto Time Set** 5 times.

CUSTOM COOK

CUSTOM COOK lets you to recall one cooking instruction previously placed in memory and begin cooking quickly.

Example: To memorize for 2 minutes.

STOP
CLEAR

1. Touch **STOP/CLEAR**.

CUSTOM
COOK

2. Touch **CUSTOM COOK**.

2 0 0

3. Enter the cook time.

STOP
CLEAR

4. Touch **START/ENTER**.

OPERATION

Example: To recall the memory.



1. Touch **STOP/CLEAR**.



2. Touch **CUSTOM COOK**.



3. Touch **START/ENTER**.
When the cook time is over, you will hear four beeps and **END** will display.

LIGHT HI/LOW/OFF

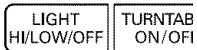

Touch **LIGHT HI/LOW/OFF** once for bright light, twice for night light, or three times to turn the light off.

CHILD LOCK

You may lock the control panel to prevent the microwave from being accidentally started or used by children.

The **Child Lock** feature is also useful when cleaning the control panel. **Child Lock** prevents accidental programming when wiping the control panel.

Example: To set the child lock.



1. Touch **STOP/CLEAR**.



2. Touch and hold **START/ENTER** more than 4 seconds. **LOCKED** will appear in the display window with two beeps.

Example: To cancel the child lock.



1. Touch and hold **START/ENTER** more than 4 seconds. **LOCKED** will disappear and two beeps will sound.

EZ-ON

A time-saving pad, this simplified control lets you quickly set and start microwave cooking without the need to touch the **START/ENTER**.

Example: To set **EZ-ON** for 2 minutes.

EZ-ON

1. Touch **EZ-ON** 4 times. The oven begins cooking and display shows time counting down.

NOTES:

Each time you touch **EZ-ON**, it will add 30 seconds, up to 99 minutes and 59 seconds.

TURNTABLE ON/OFF

For best cooking results, leave the turntable on. It can be turned off for large dishes. Touch **TURNTABLE ON/OFF** pad to turn the turntable on or off.

NOTES:

- This option is not available in sensor cook and defrost modes.
- Sometimes the turntable can become hot to touch. Be careful touching the turntable during and after cooking.
- Do not run the oven empty.

HOLD WARM

You can keep cooked food warm in your microwave oven for up to 90 minutes. You can use **HOLD WARM** by itself or to follow a cooking cycle automatically.

Example: To use **HOLD WARM**.

HOLD WARM

1. Touch **HOLD WARM**.



2. Touch **START/ENTER**.

NOTES:

- **HOLD WARM** operates for up to 90 minutes.
- **Food cooked covered** should be covered during **HOLD WARM**.
- **Pastry items** (pies, turnovers, etc.) should be uncovered during **HOLD WARM**.
- **Complete meals** kept warm on a dinner plate can be covered during **HOLD WARM**.

| Food Type | Recommended Quantity |
|-----------|----------------------|
| Liquid | 1-2 cups |
| Dry | 5-10 oz. |

To make **HOLD WARM** automatically follow another cycle:

- While you are programming the cooking instructions, touch **HOLD WARM** before touching **START/ENTER**.
- When the last cooking cycle is over, you will hear two beeps and **HOLD WARM** will appear in the oven display.
- You can set **HOLD WARM** to follow **AUTO DEFROST**, or multi-cycle cooking.

OPERATION

CUSTOM SET

You can change the default values for beep sound, clock, display speed, and defrost weight.

See following chart for more information.

| No. | Function | No. | Result |
|-----|---------------------------------|-------------|------------------------------------------|
| 1 | Beep ON/ OFF control | 1 2 | Sound ON Sound OFF |
| 2 | Clock display control | 1 2 | Clock ON Clock OFF |
| 3 | Display | 1 2 3 | Slow speed Normal speed Fast speed |
| 4 | Defrost weight mode selected | 1 2 | Lbs. Kg. |

Example: To change defrost weight mode
(from Lbs. to Kg).

**CUSTOM
SET**

1. Touch **CUSTOM SET**.

4

2. Touch **4**.

2

3. Touch **2**.

MORE/LESS

By using the **MORE** or **LESS** keys, all of the pre-programmed cook and time cook features can be adjusted to cook food for a longer or shorter time.

Pressing **MORE** will add 10 seconds of cooking time each time you press it. Pressing **LESS** will subtract 10 seconds of cooking time each time you press it.

COOKING AT HIGH POWER LEVELS

Example: To cook food for 8 minutes 30 seconds at
100% power.

8 3 0

1. Enter the cook time.



2. Touch **START/ENTER**.

When the cook time is over, four beeps will sound and **COOK END** will display.

COOKING AT LOWER POWER LEVELS

HIGH power cooking does not always give you the best results with foods that need slower cooking, such as roasts, baked goods, or custards.

Your oven has 10 power settings in addition to HIGH.

Example: To cook food for 7 minutes 30 seconds at
70% power.

7 3 0

POWER
LEVEL

7



1. Enter the cook time.

2. Touch **POWER LEVEL**.

3. Enter the power level.

4. Touch **START/ENTER**.

When the cook time is over, four beeps will sound and **COOK END** will display.

See cooking guide for Lower Power Levels, page 13.

COOKING WITH MORE THAN ONE COOK CYCLE

For best results, some recipes call for one Power Level for a certain length of time, and another Power Level for another length of time. Your oven can be set to change from one to another automatically, for up to two cycles if the first heating cycle is defrost.

Example: To cook food for 3 minutes at 100% power and
then 70% power for 7 minutes 30 seconds.

3 0 0

COOK
TIME

1. Enter the first cook time.

2. Touch **COOK TIME**.

7 3 0

POWER
LEVEL

3. Enter the second cook time.

4. Touch **POWER LEVEL**.

7

5. Enter the power level.



6. Touch **START/ENTER**.

When the cook time is over, four beeps will sound and **COOK END** will display.

OPERATION

COOKING GUIDE FOR LOWER POWER LEVELS

The 10 power levels in addition to HIGH allow you to choose the best power level for the food you are cooking. Below are listed all the power levels, examples of foods best cooked at each level, and the amount of microwave power you are using.

| POWER LEVEL | MICROWAVE OUTPUT | USE |
|-------------|------------------|--------------------------------------------------------------------------------------------------------------------------------------------------------------------------------------------------------------------------------------------------------------------------------------------|
| 10 High | 100% | <ul style="list-style-type: none"> • Boil water. • Cook ground beef. • Make candy. • Cook fresh fruits and vegetables. • Cook fish and poultry. • Preheat browning dish. • Reheat beverages. • Bacon slices. |
| 9 | 90% | <ul style="list-style-type: none"> • Reheat meat slices quickly. • Saute onions, celery, and green pepper. |
| 8 | 80% | <ul style="list-style-type: none"> • All reheating. • Cook scrambled eggs. |
| 7 | 70% | <ul style="list-style-type: none"> • Cook breads and cereal products. • Cook cheese dishes, veal. • Cook cakes, muffins, brownies, cupcakes. |
| 6 | 60% | <ul style="list-style-type: none"> • Cook pasta. |
| 5 | 50% | <ul style="list-style-type: none"> • Cook meats, whole poultry. • Cook custard. • Cook whole chicken, turkey, spare ribs, rib roast, sirloin roast. |
| 4 | 40% | <ul style="list-style-type: none"> • Cook less tender cuts of meat. • Reheat frozen convenience foods. |
| 3 | 30% | <ul style="list-style-type: none"> • Thaw meat, poultry, and seafood. • Cook small quantities of food. • Finish cooking casserole, stew, and some sauces. |
| 2 | 20% | <ul style="list-style-type: none"> • Soften butter and cream cheese. • Heat small amounts of food. |
| 1 | 10% | <ul style="list-style-type: none"> • Soften ice cream. • Raise yeast dough. |
| 0 | 0% | <ul style="list-style-type: none"> • Standing time. |

OPERATION

SENSOR OPERATING INSTRUCTIONS

Sensor Cook allows you to cook most of your favorite foods without selecting cooking times and power levels. The display will indicate sensor category during the initial sensing period. The oven automatically determines required cooking time for each food item. When the internal sensor detects a certain amount of humidity coming from the food, it will tell the oven how much longer to heat. The display will show the remaining heating time. For best results for cooking by Sensor, follow these recommendations:

1. Food cooked with the sensor system should be at normal storage temperature.
2. The glass tray and the outside of the container should be dry to assure best cooking results.
3. Foods should always be covered loosely with microwavable plastic wrap, waxed paper, or a lid.
4. Do not open the door or touch STOP/CLEAR during the sensing time. When sensing time is over, the oven beeps twice and the remaining cooking time will appear in the display window. At this time you can open the door to stir, turn, or rearrange the food.

SENSOR COOKING GUIDE

Appropriate containers and coverings help assure good Sensor cooking results.

1. Always use microwavable containers and cover them with lids or vented plastic wrap.
2. Never use tight-sealing plastic covers. They can prevent steam from escaping and cause food to overcook.
3. Match the amount to the size of the container. Fill containers at least half full for best results.
4. Be sure the outside of the cooking container and the inside of the microwave oven are dry before placing food in the oven. Beads of moisture turning into steam can mislead the sensor.

SENSOR POPCORN

SENSOR POPCORN lets you pop 3.0 and 3.5 ounce bags of commercially packaged microwave popcorn. Pop only one package at a time. If you are using a microwave popcorn popper, follow manufacturer's instructions.

Example: To pop popcorn.

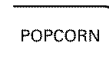

1. Touch **POPCORN**.
When the cook time is over, four beeps will sound and **COOK END** will display.

- Recommended amounts: 3.0-3.5 oz.
- To cook a snack size bag (1.75 oz.) place the bag in the oven. Set the oven to cook for 2 minutes at full power. Listen for the popping to slow down. When the popping slows to one pop per second, stop the oven. Make a note of how much time it took and use that setting in the future.

CAUTION

DO NOT leave microwave oven unattended while popping corn.

When popping commercially packaged popcorn, remove the rack from the oven. Do not place the bag of microwave popcorn on the rack or under the rack.

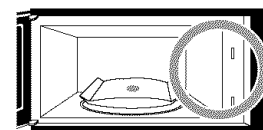
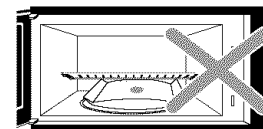
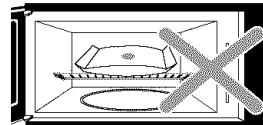

OPERATION

SENSOR COOK

Using SENSOR COOK lets you heat common microwave-prepared foods without needing to program times and Cook Powers. SENSOR COOK has preset Cook Power for 7 food categories.

Example: To cook rice.

| | |
|----------------------------------------------------------------------------------------------------|--------------------------|
| <div style="border: 1px solid black; padding: 2px; width: fit-content; margin: 0 auto;">COOK</div> | 1. Touch COOK . |
| 6 | 2. Choose food category. |

SENSOR COOK TABLE

| Category | Touch Pad Number | Amount |
|------------------|------------------|--------------|
| Baked Potato | 1 | 1 - 4 EA |
| Fresh Vegetable | 2 | 1 - 4 cups |
| Frozen Vegetable | 3 | 1 - 4 cups |
| Canned Vegetable | 4 | 1 - 4 cups |
| Casserole | 5 | 1 - 4 cups |
| Rice | 6 | 1/2 - 2 cups |
| Frozen Entree | 7 | 10 - 21 oz. |

When the cook time is over, four beeps will sound and **COOK END** will display.

SENSOR REHEAT

Using SENSOR REHEAT lets you heat common microwave-prepared foods without needing to program times and Power levels.

Example: To reheat 2 slices of pizza.

| | |
|------------------------------------------------------------------------------------------------------|--------------------------|
| <div style="border: 1px solid black; padding: 2px; width: fit-content; margin: 0 auto;">REHEAT</div> | 1. Touch REHEAT . |
| 1 | 2. Choose food category. |

SENSOR REHEAT TABLE

| Category | Touch Pad Number | Amount |
|--------------|------------------|----------------|
| Pizza slice | 1 | 1 - 3 slices |
| Dinner plate | 2 | 1 - 2 servings |
| Soup/Sauce | 3 | 1 - 4 cups |
| Casserole | 4 | 1 - 4 cups |

CHICKEN CHOICES

The oven uses low power to cook poultry (chicken wings, chicken nugget, Spicy chicken, and Mexican chicken) See the following table.

Example: To cook 6 oz. chicken wings.

| | |
|---------------------------------------------------------------------------------------------------------------|---------------------------------------------------------------|
| <div style="border: 1px solid black; padding: 2px; width: fit-content; margin: 0 auto;">CHICKEN CHOICES</div> | 1. Touch CHICKEN CHOICES . |
| 1 | 2. Choose food category. Touch 1 for chicken wings. |
| 1 | 3. Choose amount by touching 1 for 6 oz. |
|  | 4. Touch START/ENTER . |

CHICKEN CHOICES TABLE

| Category | Touch Pad Number | Amount |
|-----------------|------------------|---------------|
| Chicken Wings | 1 | 6, 12 oz. |
| Chicken Nugget | 2 | 4, 8 oz. |
| Spicy Chicken | 3 | 2, 4 servings |
| Mexican Chicken | 4 | 2, 4 servings |

*See recipes page 18.

OPERATION

SOFTEN

The oven uses low power to soften foods. (butter, ice cream, cream cheese, and frozen juice) See the following table.

Example: To soften quart of ice cream.

| | |
|-----------------------------------------------------------------------------------|-----------------------------------------------------------|
| SOFTEN | 1. Touch SOFTEN . |
| 2 | 2. Choose food category. Touch 2 for ice cream. |
| 2 | 3. Choose food amount. Touch 2 for quart. |
|  | 4. Touch START/ENTER . |

MELT

The oven uses low power to melt foods. (butter or margarine, chocolate, marshmallows, or processed cheese food) See the following table.

Example: To melt 8 oz. chocolate.

| | |
|-----------------------------------------------------------------------------------|-----------------------------------------------------------|
| MELT | 1. Touch MELT . |
| 2 | 2. Choose food category. Touch 2 for chocolate. |
| 2 | 3. Choose food amount. Touch 2 for 8 oz. |
|  | 4. Touch START/ENTER . |

SOFTEN TABLE

| Category | Touch Pad Number | Amount |
|--------------|------------------|------------------------|
| Butter | 1 | 1,2,3 sticks |
| Ice cream | 2 | Pint,Quart,Half gallon |
| Cream cheese | 3 | 3, 8 oz. |
| Frozen juice | 4 | 6,12,16 oz. |

MELT TABLE

| Category | Touch Pad Number | Amount |
|--------------------|------------------|----------------|
| Butter / Margarine | 1 | 1, 2, 3 sticks |
| Chocolate | 2 | 4, 8 oz. |
| Cheese | 3 | 8, 16 oz. |
| Marshmallows | 4 | 5, 10 oz. |

OPERATION

SENSOR COOK TABLE

| CATEGORY | | DIRECTION | AMOUNT |
|---------------|------------------|---------------------------------------------------------------------------------------------------------------------------------------------------------------------------------|----------------------------------------|
| Baked Potato | | Pierce each potato with a fork and place on the oven tray around the edge, at least one inch apart. | 1 - 4 medium approx. 8 -10 oz. each |
| VEGETABLE | Fresh Vegetable | Prepare as desired, wash, and leave residual water on the vegetables. Place in an appropriately-sized microwave container, cover with plastic wrap and vent. | 1 - 4 cups |
| | Frozen Vegetable | Remove from package, rinse off frost under running water. Place in an appropriately-sized microwave container, cover with plastic wrap and vent. | 1 - 4 cups |
| | Canned Vegetable | Remove from the outer display can. Place in an appropriately sized microwave container, cover with plastic wrap and vent. After cooking, stir and allow to stand for 3 minutes. | 1 - 4 cups |
| Casserole | | Assemble the ingredients per the recipe in a 1-2 quart casserole. Cooking with plastic wrap and vent. After cooking, stir and allow to stand for 3 minutes | 1 - 4 cups |
| Rice | | Add twice the amount of water to the rice. Use a microwave container large enough to prevent water from boiling over dish. Cover with plastic wrap or lid. | 1/2 - 2 cups |
| Frozen Entree | | Remove from outer display package. Slit cover. If not in microwave-safe container, place on plate, cover with plastic wrap and vent. | 10 - 21 oz. |

SENSOR REHEAT TABLE

| CATEGORY | DIRECTION | AMOUNT |
|--------------|-----------------------------------------------------------------------------------------------------------------------|----------------------------------|
| Pizza Slice | This is a reheat function for leftover pizza. Place on paper towel on a microwave safe plate. | 1 - 3 slices (3 - 5 oz. each) |
| Dinner Plate | Place on a low plate. Cover with vented plastic wrap. Let stand 3 minutes. | 1 - 2 servings |
| Soup/Sauce | Place in shallow microwavable casserole. Cover with vented plastic wrap. After cooking, stir and let stand 3 minutes. | 1 - 4 cups |
| Casserole | Cover dish containing the casserole with plastic wrap and vent. After cooking, stir and allow to stand for 3 minutes. | 1 - 4 cups |

OPERATION

CHICKEN CHOICES TABLE

| CATEGORY | DIRECTION | AMOUNT |
|--------------------------------------|-------------------------------------------------------------------------------------------------------------------------------------------------------------------------------------------------------------------------------------------------------------------------------------------------------------------------------------------------------------------------------------------------------------------------------------------------------------------------------------------------------------------------------------------------------------------------------------------------------------------------------------------------------------------------------------------------------------------------------------------------------------------------------------------------------------------------------------------------------------------------------------------------------------|-----------------|
| Chicken wings Frozen, Precooked | Place in a single layer around the edge of a dinner plate or serving platter. | 6 or 12 oz. |
| Chicken nuggets Frozen, Precooked | Place in a single layer around the edge of a dinner plate. | 4 or 8 oz. |
| Spicy chicken | <p>- 2 servings (double the ingredients for 4 servings)</p> <ul style="list-style-type: none"> • 1 1/2 pounds skinless chicken pieces • 1 teaspoon cayenne pepper • 1 1/2 tablespoon paprika • 1/2 teaspoon pepper • 1/2 cup hot sauce or 1 tablespoon Tabasco sauce • 1/2 cup barbecue sauce of choice <p>Mix everything in an 8 X 8-inch glass dish or similar dish and cover with plastic wrap.</p> <p>Cook on Spicy chicken. Stir and serve as is or place under a broiler for a few minutes for additional browning.</p> | 2 or 4 servings |
| Mexican chicken | <p>- 2 servings (double the ingredients for 4 servings)</p> <ul style="list-style-type: none"> • 1/2 medium onion, chopped • 1/2 green bell pepper, diced • 1/2 cup frozen peas • 1/2 cup long grain rice • 1 cup water • 1/2 cup salsa • 1 1/2 pounds skinless chicken pieces, legs, thighs, breasts, wings, or combination of all • 1 teaspoon cumin • Salt and pepper to taste • 1/2 cup green olives w/pimentos <p>Place onions and peppers in an 8 X 8-inch glass dish or similar container and microwave for 3 minutes.</p> <p>Add peas, rice, water, salsa, chicken, and cumin.</p> <p>Season with salt and pepper.</p> <p>Cover with plastic wrap and cook on Mexican chicken. Stir in the olives and serve as is or place under a broiler for a few minutes to add additional browning.</p> | 2 or 4 servings |

OPERATION

SOFTEN TABLE

| CATEGORY | DIRECTION | AMOUNT |
|--------------|----------------------------------------------------------------------------------------------------------------------|--------------------------|
| Butter | Unwrap and place in microwavable container. Butter will be at room temperature and ready for use in recipe. | 1, 2, or 3 sticks |
| Ice Cream | Place container in oven. Ice cream will be soft enough to make scooping easier. | Pint, Quart, Half gallon |
| Cream cheese | Unwrap and place in microwavable container. Cream cheese will be at room temperature and ready for use in recipe. | 3 or 8 oz. |
| Frozen juice | Remove top. Place in oven. Frozen juice will be soft enough to mix easily with water. | 6, 12, or 16 oz. |

MELT TABLE

| CATEGORY | DIRECTION | AMOUNT |
|---------------------|------------------------------------------------------------------------------------------------------------------------------------------------------------------|-------------------|
| Butter or Margarine | Unwrap and place in microwavable container. No need to cover butter. Stir at the end of cooking to complete melting. | 1, 2, or 3 sticks |
| Chocolate | Chocolate chips or squares of baking chocolate may be used. Unwrap squares and place in microwavable container. Stir at the end of cycle to complete melting. | 4 or 8 oz. |
| Cheese | Use processed cheese food only. Cut into cubes. Place in a single layer in microwavable container. Stir at the end of cooking to complete melting. | 8 or 16 oz. |
| Marshmallows | Large or miniature marshmallows may be used. Place in microwavable container. Stir at the end of cycle to complete melting. | 5 or 10 oz. |

OPERATION



AUTO DEFROST

Four defrost choices are preset in the oven. The defrost feature provides you with the best defrosting method for frozen foods, because the oven automatically sets the defrosting times for each food item according to the weight you enter. For added convenience, the **AUTO DEFROST** includes a built-in tone mechanism that reminds you to check, turn over, separate, or rearrange the food during the defrost cycle. Four different defrosting options are provided.

1. **MEAT**
2. **POULTRY**
3. **FISH**
4. **BREAD**

After touching **AUTO DEFROST** once, select the food category. Available weight ranges for Meat, Poultry and Fish are 0.1 to 6.0 lbs. The available weight range for Bread is 0.1 to 1.0 lb.

Example : To defrost 1.2 lbs of meat.

| | |
|-------------------------------------------------------------------------------------|--------------------------------|
|  | 1. Touch AUTO DEFROST . |
| 1 | 2. Choose food category. |
| 1 2 | 3. Enter the weight. |
|  | 4. Touch START/ENTER . |

NOTE: After you touch **START/ENTER**, the display counts down the defrost time. The oven will beep once during the Defrost cycle. At this time, open the door and turn, separate, or rearrange the food as needed. Remove any portions that have thawed, then return frozen portions to the oven and touch **START/ENTER** to resume the defrost cycle. **The oven will not stop during the BEEP unless the door is opened.**

For best results:

- Remove fish, shellfish, meat, and poultry from its original closed paper or plastic package (wrapper). Otherwise, the wrap will hold steam and juice close to the foods, which can cause the outer surface of the foods to cook.
- Form the meat into the shape of a doughnut before freezing. When defrosting, scrape off thawed meat when the beep sounds and continue defrosting.
- Place foods in a shallow glass baking dish or a on a microwave roasting rack to catch drippings.
- Foods should still be somewhat icy in the center when removed from the oven.



AUTO DEFROST TABLE

| Category | Food |
|----------------------------------|-----------------------------------------------------------------------------------------------------------------------------------------------------------------------------------------------------------------------------------------------------------------------------------------------------------|
| MEAT 0.1 to 6.0 lbs | BEEF Ground beef, Round steak, Cubes for stew, Tenderloin steak, Pot roast, Rib roast, Rump roast, Chuck roast, Hamburger patty. LAMB Chops (1-inch thick), Rolled roast PORK Chops (1/2-inch thick), Hot dogs, Spareribs, Country-style ribs. Rolled roast, Sausage. |
| POULTRY 0.1 to 6.0 lbs | POULTRY Whole (under 4 lbs), Cut up, Breasts (boneless) CORNISH HENS Whole TURKEY Breast (under 6 lbs) |
| FISH 0.1 to 6.0 lbs | FISH Fillets, Whole Steaks SHELLFISH Crab meat, Lobster tails, Shrimp, Scallops |
| BREAD 0.1 to 1.0 lb | MUFFINS ROLL CAKE |

QUICK DEFROST

The **QUICK DEFROST** feature provides a rapid defrost for 1.0 pound frozen food. The oven automatically sets the defrosting time for ground beef.

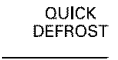
Example: To defrost 1lb. ground beef.

| | |
|-------------------------------------------------------------------------------------|---------------------------------|
|  | 1. Touch QUICK DEFROST . |
|  | 2. Touch START/ENTER . |

OPERATION

TIME DEFROST

This feature allows you to choose the time you want to defrost.

Example: To defrost for 2 minutes.

| | |
|-----------------------------------------------------------------------------------|---------------------------------------------------|
| TIME DEFROST | 1. Touch TIME DEFROST . |
| 2 0 0 | 2. Enter the defrosting time you want. |
|  | 3. Touch START/ENTER . (Defrost starts) |

When the defrost time is over, four beeps will sound and **COOK END** will display.

DEFROST TIPS

- When using **AUTO DEFROST**, the weight to be entered is the net weight in pounds and tenths of pounds (the weight of the food minus the container).
- Use **AUTO DEFROST** only for raw food. **AUTO DEFROST** gives best results when food to be thawed is a minimum of 0°F (taken directly from a true freezer). If food has been stored in a refrigerator-freezer that does not maintain a temperature of 5°F or below, always program a lower food weight (for a shorter defrosting time) to prevent cooking the food.
- If the food is stored outside the freezer for up to 20 minutes, enter a lower food weight.
- The shape of the package alters the defrosting time. Shallow rectangular packets defrost more quickly than a deep block.
- Separate pieces as they begin to defrost. Separated pieces defrost more easily.
- You can use small pieces of aluminum foil to shield foods like chicken wings, leg tips, and fish tails, but the foil must not touch the side of the oven. Foil causes arcing, which can damage the oven lining.
- Shield areas of food with small pieces of foil if they start to become warm.
- For better results, a preset standing time is included in the defrosting time.
- For best results, elevate food to be defrosted on a microwave safe roasting rack. This prevents the possibility of warm meat juices cooking food during defrost.

METAL RACK

CAUTION

To avoid risk of property damage:

Do not use rack to pop popcorn.

Rack must be on the four plastic supports when used.

Use the rack only when cooking food on rack position.

Do not cook with rack on floor of the oven.

The metal rack gives you extra space when cooking in more than one container at the same time.

To use rack:

1. Place rack securely in the four plastic supports.
- Rack **MUST NOT** touch metal walls or back of microwave oven.
2. Place equal amounts of food both **ABOVE AND BELOW** rack.
- Amount of food must be approximately the same to balance out cooking energy.

COOKING

GETTING THE BEST COOKING RESULTS

To get the best results from your microwave oven, read and follow the guidelines below.

- **Storage Temperature:** Foods taken from the freezer or refrigerator take longer to cook than the same foods at room temperature.
The time for recipes in this book is based on the normal storage temperature of the food.
- **Size:** Small pieces of food cook faster than large ones, pieces similar in size and shape cook more evenly. For even cooking, reduce the power when cooking large pieces of food.
- **Natural Moisture:** Very moist foods cook more evenly because microwave energy is attracted to water molecules.
- **Stir** foods such as casseroles and vegetables from the outside to the center to distribute the heat evenly and speed cooking. Constant stirring is not necessary.
- **Turn over** foods like pork chops, baking potatoes, roasts, or whole cauliflower halfway through the cooking time to expose all sides equally to microwave energy.
- **Place** delicate areas of foods, such as asparagus tips, toward the center of the dish.
- **Arrange** unevenly shaped foods, such as chicken pieces or salmon steaks, with the thicker, meatier parts toward the outside of the dish.
- **Shield**, with **small** pieces of aluminum foil, parts of food that may cook quickly, such as wing tips and leg ends of poultry.

- **Let It Stand:** After you remove the food from the microwave, cover food with foil or casserole lid and let it stand to finish cooking in the center and avoid overcooking the outer edges. The length of standing time depends on the density and surface area of the food.
- **Wrapping in waxed paper or paper towel:** Sandwiches and many other foods containing prebaked bread should be wrapped prior to microwaving to prevent drying out.

FISH AND SHELLFISH

Cooking Fish and Shellfish:

General Directions

- Prepare the fish for cooking.
 - Completely defrost the fish or shellfish.
 - Arrange unevenly shaped pieces with thicker parts toward the outside of the dish. Arrange shellfish in a single layer for even cooking.
 - The type of cover you use depends on how you cook. Poached fish needs a microwavable lid or vented plastic wrap.
 - Baked fish, coated fish, or fish in sauce needs to be covered lightly with waxed paper to keep the coating crisp and sauce from getting watery.
 - Always set the shortest cooking time. Fish is done when it turns opaque and the thickest part begins to flake. Shellfish is done when the shell turns from pink to red and the flesh is opaque and firm.

FISH AND SHELLFISH COOKING TABLE

| FISH | POWER LEVEL | COOKING TIME | DIRECTIONS |
|-----------------|-------------|----------------------------------------------------------------------|---------------------------------------------------------------------------------------------------------------------------------------------------------------------------------------------------------------------------------------------------------------------------------------------------------------------------------------------------|
| Fish fillets | HI | 3 ¹ / ₂ -4 ¹ / ₂ minutes | Arrange fish in a single layer with thickest portion toward outside edge of 1 ¹ / ₂ quart microwavable baking dish. Brush with melted butter and season, if desired. Cook covered with vented plastic wrap. Let stand covered 2 minutes. If you are cooking more than 1 lb. of fish, turn the fish halfway through cooking. |
| Fish steaks | HI | 4 ¹ / ₂ -5 ¹ / ₂ minutes | |
| Whole fish | 7 | 4 ¹ / ₂ -6 minutes | |
| Scallops | HI | 3 ¹ / ₂ -5 minutes | Arrange in a single layer. Prepare as directed above, except stir instead of turning the shellfish. |
| Shrimp, shelled | HI | 3 ¹ / ₂ -5 minutes | |

COOKING

APPETIZERS/SAUCES/SOUPS

Cooking Appetizers: Tips and Techniques

Recommended

- Crisp crackers, such as melba toast, shredded wheat, and crisp rye crackers are best for microwave use. Wait until party time to add the spreads. Place a paper towel under the crackers while they cook in the microwave oven to absorb extra moisture.
- Arrange individual appetizers in a circle for even cooking.
- Stir dips to distribute heat and shorten cooking time.

Cooking Sauces: Tips and Techniques

- Use a microwavable casserole or glass measuring cup that is at least 2 or 3 times the volume of the sauce.
- Sauces made with cornstarch thicken more rapidly than those made with flour.
- Cook sauces made with cornstarch or flour uncovered so you may stir them 2 or 3 times during cooking for a smooth consistency.
- To adapt a conventional sauce or gravy recipe, reduce the amount of liquid slightly.

Cooking Soups: Tips and Techniques

- Cook soups in a microwavable dish which holds double the volume of the recipe ingredients to prevent boil-over, especially if you use cream or milk in the soup.
- Generally, cover microwaved soups with VENTED plastic wrap or a microwavable lid.
- Cover foods to retain moisture. Uncover foods to retain crispness.
- Avoid overcooking by using the minimum suggested time. Add more time, if necessary, only after checking the food.
- Stirring occasionally will help blend flavors, distribute heat evenly, and may even shorten the cooking time.
- When converting a conventional soup recipe to cook in the microwave, reduce the liquid, salt, and strong seasonings.

Not Recommended

- Appetizers with a crisp coating or puff pastry are best done in a conventional oven with dry heat.
- Breaded products can be warmed in the microwave oven but will not come out crisp.

MEAT

Cooking Meat: General Directions

- Prepare the meat for cooking.
 - Defrost completely.
 - Trim off excess fat to avoid spattering.
 - Place the meat, fat side down, on a microwavable rack in a microwavable dish.
 - Use oven cooking bag for less tender cuts of meat.
 - Arrange the meat so that thicker portions are toward the outside of the dish.
 - Cover the meat with waxed paper to prevent spattering.
- Tend the meat as it cooks.
 - Drain juices as they accumulate to reduce spattering and keep from overcooking the bottom of the meat.
 - Shield thin or bony portions with strips of foil to prevent overcooking.

NOTE: Keep the foil **at least 1 inch** from the oven walls, and do not cover more than one-third of the meat with foil at any one time.

- Let the meat stand covered with foil 10-15 minutes after you remove it from the oven. The internal temperature of the meat may rise from 5-10° F during standing time.

The Meat Cooking Table on the next page provides detailed directions, Power Level, and Cooking Time settings for most cuts of meat.

COOKING

MEAT COOKING TABLE

| MEAT | POWER LEVEL | COOKING TIME | DIRECTIONS |
|----------------------------------------------------------------------------------------------------------------|-------------|------------------------------------------------------------------------------------------------------------------------------------------|-----------------------------------------------------------------------------------------------------------------------------------------------------------------------------------------------------------------------------------------------------------------------------------------------------------------------------------------------------------------------------------------------------------|
| BEEF Hamburgers, Fresh or defrosted (4 oz. each) 1 patty 2 patties 4 patties | HI | 1-1½ minutes 1½-2 minutes 2½-3½ minutes | Form patties with depression in center of each. Place on microwavable roasting rack. Brush with browning agent, if desired. Cover with waxed paper. Turn over halfway through cooking. Let stand covered 1 minute. |
| Sirloin tip roast (3-4 lbs.) | 5 | 8-10 minutes per pound RARE (135°F) 11-13 minutes per pound MEDIUM (155°F) | Place roast fat side down on microwavable roasting rack. Add desired seasonings and cover with waxed paper. Turn meat over halfway through cooking and shield if necessary. Remove roast from microwave oven when desired temperature is reached. Let stand covered with foil 15 minutes. (Temperature may rise about 10°F). |
| LAMB Lamb roast, rolled boneless (3-4 lbs.) | 5 | 11-12 minutes per pound RARE (135°F) 12-13 minutes per pound MEDIUM (145°F) 13-14 minutes per pound WELL (155°F) | Place roast fat side down on microwavable roasting rack. Brush lamb with marinade or desired seasonings such as rosemary, thyme or marjoram. Cover with waxed paper. Turn roast over after 15 minutes, and again after 30 minutes. Shield if necessary. Remove roast from microwave when desired temperature is reached. Let stand covered with foil 15 minutes. (Temperature may rise about 10°F). |
| PORK Bacon slices 2 slices 4 slices 6 slices 10 slices | HI | 1½-2 minutes 2-3 minutes 4-5 minutes 7-8 minutes | Place bacon slices on microwavable roasting rack. Cover with paper towels. After cooking, let stand 1 minute. |
| Chops (5-7 oz. each) 2 chops 4 chops | 3 | 18-20 minutes per pound 15-17 minutes per pound | Place chops in microwavable baking dish. Add desired seasonings and cover with vented plastic wrap. Cook until no longer pink or until internal temperature reaches 170°F. Turn chops over halfway through cooking. Let stand covered 5 minutes. (Temperature may rise about 10°F). |
| Loin Roast, rolled, boneless (3½- 4½ lbs.) | 3 | 25-27 minutes per pound (165°F) | Place roast in cooking bag in microwavable dish. Add seasonings and browning agent if desired. Close bag loosely with microwavable closure or string. After cooking, let stand in bag 15 minutes. (Temperature may rise about 10°F.) Internal temperature of pork should reach 170°F before serving. |
| Sausage links, Fresh or Frozen, defrosted (1-2 oz. each) 2 links 4 links 6 links 10 links | HI | 45-60 seconds 1-1½ minutes 1½-2 minutes 1¾-2 minutes | Pierce links and place on microwavable roasting rack. Cover with waxed paper or paper towel. Turn over halfway through cooking. After cooking, let stand covered 1 minute. |

COOKING

CHICKEN

Cooking Poultry: General Directions

- Prepare the poultry for cooking.
- Defrost completely.
- Arrange poultry pieces with thicker pieces at the outside edge of the baking dish. When cooking legs, arrange them like the spokes of a wheel.
- Cover the baking dish with waxed paper to reduce spattering.
- Use a browning agent or cook with a sauce to give a browned appearance.

- Watch the poultry as it cooks.
- Drain and discard juices as they accumulate.
- Shield thin or bony pieces with small strips of aluminum foil to prevent overcooking. Keep foil **at least 1 inch** from the oven walls and other pieces of foil.
- Poultry is done when it is no longer pink and the juices run clear. When done, the temperature in the thigh meat should be 180-185°F.
- Let the poultry stand after cooking covered with foil for 10 minutes.

The Poultry Cooking Table below provides detailed directions, Power Level, and Cooking Time settings for most cuts and types of poultry.

CHICKEN COOKING TABLE

| CHICKEN | POWER LEVEL | COOKING TIME | DIRECTIONS |
|-------------------------------------------|-------------|----------------------------|------------------------------------------------------------------------------------------------------------------------------------------------------------------------------------------------------------------------------------------------------------------------------------------------------------------------------------------------------------------------------------------------------------------------------------------------------------------------------------------------------------------------------------------------------------------------------------------------------------|
| Chicken pieces (2½-3 lbs.) | HI | 4½-5½ minutes per pound | Before cooking, wash pieces and shake the water off. Place pieces in a single layer in a microwavable baking dish with thicker pieces to the outside. Brush with butter or browning agent and seasonings if desired. Cover with waxed paper. Cook until no longer pink and juices run clear. Let stand covered 5 minutes. |
| Chicken whole (3-3½ lbs.) | HI | 12-13 minutes per pound | Before cooking, wash and shake off water. Place breast side down on a microwavable roasting rack. Brush with butter, or browning agent and seasoning if desired. Cover with waxed paper. Cook ⅓ of estimated time. Turn breast side up, brush with butter, or browning agent. Replace waxed paper. Cook ⅓ of estimated time again. Shield if necessary. Cook remaining ⅓ of estimated time or until no longer pink and juices run clear. Let stand covered with foil 10 minutes. (The temperature may rise about 10°F.) The temperature in the thigh should be 180°F-185°F when the poultry is done. |
| Cornish Hens whole (1-1½ lbs. each) | HI | 6-7 minutes per pound | Before cooking, wash and shake the water off. Tie wings to body of hen and the legs to tail. Place hens breast side down on microwavable rack. Cover with waxed paper. Turn breast side up halfway through cooking. Shield bone ends of drumsticks with foil. Remove and discard drippings. Brush with butter or browning agent and seasonings if desired. Cook until no longer pink and juices run clear. Remove hens from microwave when they reach desired temperature. Let stand covered with foil 5 minutes. (Temperature may rise about 10°F). Temperature in breast should be 170°F before serving. |

COOKING

PASTA AND RICE

Microwave cooking and conventional cooking of pasta, rice, and cereal require about the same amount of time, but the microwave is a more convenient method because you can cook and serve in the same dish. There is no stirring needed and leftover pasta tastes just like fresh cooked when reheated in the microwave oven.

Cooking Pasta and Rice: Tips and Techniques

- If you are planning to use rice or pasta in a casserole, undercook it so it is still firm.
- Allow for standing time with rice, but not for pasta.
- The Pasta and Rice Cooking Tables below provide specific directions, with Power Level and cooking time settings for most common types of pasta and rice.

PASTA COOKING TABLE

| PASTA | POWER LEVEL | COOKING TIME | DIRECTIONS |
|---------------------------------------------------------------------|-------------|-------------------------------|---------------------------------------------------------------------------------------------------------------------------------------------------------------------------------------------------------------------------------------------------------------------------------------------------------------------------------------------------------------------------|
| Spaghetti 4 cups water Add 8 oz. spaghetti | HI 5 | 9-10 minutes 7½-8½ minutes | Combine hot tap water and salt, if desired. Use a 2-quart microwavable baking dish and cover with vented plastic wrap for spaghetti and lasagna noodles. Use microwavable lid or vented plastic wrap for macaroni and egg noodles. Cook as directed in chart or until water boils. Stir in pasta; cook covered as directed in chart or until tender. Drain in a colander. |
| Macaroni 3 cups water Add 2 cups macaroni | HI 5 | 6-7 minutes 5½-6½ minutes | |
| Lasagna noodles 4 cups water Add 8 oz. lasagna noodles | HI 5 | 7-8 minutes 11-12½ minutes | |
| Egg noodles 6 cups water Add 4 cups noodles | HI 5 | 8-10 minutes 5½-6½ minutes | |

RICE COOKING TABLE

| RICE | POWER LEVEL | COOKING TIME | DIRECTIONS |
|---------------------------------------------------------------------------|-------------|-----------------------------|----------------------------------------------------------------------------------------------------------------------------------------------------------------------------------------------------------------------------------------------------------------------------------------------------------------------------------------------------------|
| Long grain 2¼ cups water Add 1 cup rice | HI 5 | 4½-5½ minutes 14 minutes | Combine hot tap water and salt, if desired, in 2 quart microwavable casserole. Cover with microwavable lid or vented plastic wrap. Cook as directed in chart or until water boils. Stir in rice and any seasonings. Cook covered as directed in chart or until water is absorbed and rice is tender. Let stand covered 5 to 10 minutes. Fluff with fork. |
| Brown 2½ cups water Add 1 cup rice | HI 5 | 4½-5½ minutes 28 minutes | |
| Long grain and wild rice mix 2½ cups water Add 6 oz. package | HI 5 | 4-5 minutes 24 minutes | |
| Quick cooking 1 cup water Add 1 cup rice | HI | 2-3 minutes | |

MAINTENANCE

CARE AND CLEANING

For best performance and safety, keep the oven clean inside and out-side. Take special care to keep the inner door panel and the oven front frame free of food or grease build-up. **Never use rough powder or pads.** Wipe the microwave oven inside and out, including the hood bottom cover, with a soft cloth and a warm (not hot) mild detergent solution. Then rinse and wipe dry. Use a chrome cleaner and polish on chrome, metal and aluminum surfaces. Wipe spatters immediately with a wet paper towel, especially after cooking chicken or bacon. Clean your oven weekly or more often, if needed.

METAL RACK

Wash the metal rack with a mild soap and a soft or nylon scrub brush. Dry completely. Do not use abrasive scrubbers or cleaners to clean rack.

CLEANING THE GREASE FILTERS

The grease filter should be removed and cleaned often, at least once a month.

1. Disconnect power or unplug microwave oven.
2. To remove grease filter, slide filter to the back. Pull filter downward. The filter will drop out.

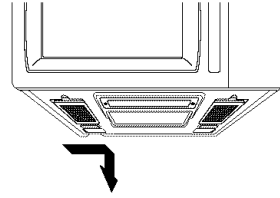

3. Soak grease filter in hot water and a mild detergent. Scrub and swish to remove embedded dirt and grease. Rinse well and shake to dry. Do not clean filter with ammonia, corrosive cleaning agents such as lye-based oven cleaners, or place them in a dishwasher. The filter will turn black or could be damaged.

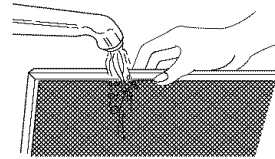

4. To reinstall the filter, slide it into the back slot, then push up to lock.

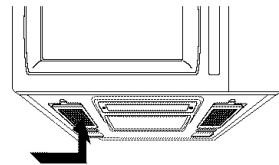

5. Reconnect power or plug in microwave oven.
NOTE: Do not operate the hood without the filter in place.

MAINTENANCE

CHARCOAL FILTER REPLACEMENT

CAUTION

To avoid risk of personal injury or property damage, do not operate oven hood without filters in place.

If your oven is vented inside, the charcoal filter (5230W1A003A) should be replaced every 6 to 12 months, and more often if necessary. The charcoal filter cannot be cleaned. To order a new charcoal filter, contact the Parts Department at your nearest Authorized Service Center.

1. Unplug the oven or turn off power at the main power supply.
2. Remove the two vent grille mounting screws. (2 middle screws)

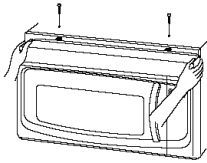

3. Tip the grille forward, then lift out to remove.

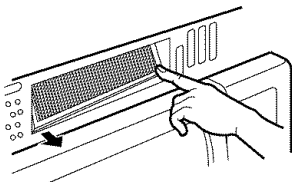

4. Remove old filter.

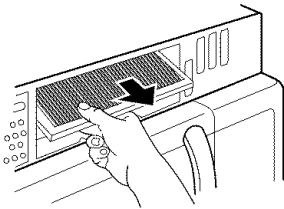

5. Slide a new charcoal filter into place. The filter should rest at the angle shown.

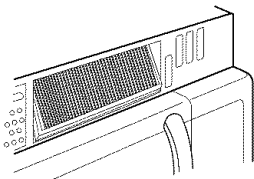

6. Slide the bottom of the grille into place. Push the top until it snaps into place. Replace the mounting screws. Turn the power back on at the main power supply and set the clock.

COOKTOP/NIGHT LIGHT REPLACEMENT

CAUTION

To avoid personal injury or property damage, wear gloves when replacing light bulb.

1. Unplug the oven or turn off power at the main power supply.

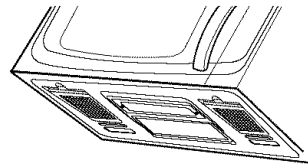

2. Remove the bulb cover mounting screws.
3. Replace bulb(s) with 35 watt appliance bulb(s).
4. Replace bulb cover, and mounting screws.
5. Turn the power back on at the main power supply.

OVEN LIGHT REPLACEMENT

1. Unplug oven or turn off power at the main power supply.
2. Remove the vent cover mounting screws. (2 middle screws)
3. Tip the cover forward, then lift out to remove.

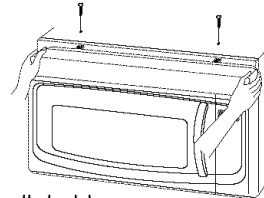

4. Lift up the bulb holder.

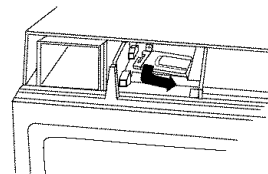
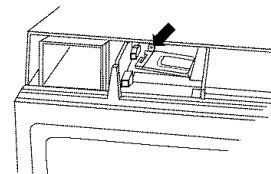

5. Replace bulb with a 30 or 40 watt appliance bulb.
6. Replace the bulb holder, if damaged.
7. Slide the bottom of the vent cover into place. Push the top until it snaps into place. Replace the mounting screws. Turn the power back on at the main power supply.

COOKING UTENSILS

MICROWAVE UTENSIL GUIDE

| USE | DO NOT USE |
|----------------------------------------------------------------------------------------------------------------------------------------------------------------------------------------------------------------------------------------------------------------------------------------------------------------------------------------------------------------------------------------------------------------------------------------------------------------------------------------------------------------------------------------------------------------------------------------------------------------------------------------------------------------------------------------------------------------------------------------------------------------------------------------------------------------------------------------------------------------------------------------------------------------------------------------------------------------------------------------------------------------------------------------------------------------------|--------------------------------------------------------------------------------------------------------------------------------------------------------------------------------------------------------------------------------------------------------------------------------------------------------------------------------------------------------------------------------------------------------------------------------------------------------------------------------------------------------------------------------------------------------------------------------------------------------------------------------------------------------------------------------------------------------------------------------------------------------------------------------------------------------------------------------------------------------------------------------------------------------------------------------------------------------------------------------------------------------------------------------------------------------------------------------------------------------------------------------------------------------------------------------------------------------------------------------------------------------------------------------------------------------------------------------------------------------------------------------------------------------------------------------------------------------------------------|
| <p>OVENPROOF GLASS (treated for high intensity heat): Utility dishes, loaf dishes, pie plates, cake plates, liquid measuring cups, casseroles, and bowls without metallic trim.</p> <p>CHINA: Bowls, cups, serving plates, and platters without metallic trim.</p> <p>PLASTIC: Plastic wrap (as a cover)-- lay the plastic wrap loosely over the dish and press it to the sides. Vent plastic wrap by turning back one edge slightly to allow excess steam to escape. The dish should be deep enough so that the plastic wrap will not touch the food. As the food heats it may melt the plastic wrap wherever the wrap touches the food. Use plastic dishes, cups, semirigid freezer containers, and plastic bags only for short cooking times. Use these with care because the plastic may soften from the heat of the food.</p> <p>PAPER: Paper towels, waxed paper, paper napkins, and paper plates with no metallic trim or design. Look for the manufacturer's label for use in the microwave oven.</p> | <p>METAL UTENSILS: Metal shields the food from microwave energy and produces uneven cooking. Also avoid metal skewers, thermometers, or foil trays. Metal utensils can cause arcing, which can damage your microwave oven.</p> <p>METAL DECORATION: Metal-trimmed or metal-banded dinnerware, casserole dishes, etc. The metal trim interferes with normal cooking and may damage the oven.</p> <p>ALUMINUM FOIL: Avoid large sheets of aluminum foil because they hinder cooking and may cause harmful arcing. Use small pieces of foil to shield poultry legs and wings. Keep ALL aluminum foil at least 1 inch from the side walls and door of the oven.</p> <p>WOOD: Wooden bowls and boards will dry out and may split or crack when you use them in the microwave oven. Baskets react in the same way.</p> <p>TIGHTLY COVERED UTENSILS: Be sure to leave openings for steam to escape from covered utensils. Pierce plastic pouches of vegetables or other food items before cooking. Tightly closed pouches could explode.</p> <p>BROWN PAPER: Avoid using brown paper bags. They absorb too much heat and could burn.</p> <p>FLAWED OR CHIPPED UTENSILS: Any utensil that is cracked, flawed, or chipped may break in the oven.</p> <p>METAL TWIST TIES: Remove metal twist ties from plastic or paper bags. They become hot and could cause a fire.</p> |

Do not use recycled paper products in the microwave oven. They sometimes contain impurities that cause sparks to occur.

TROUBLESHOOTING

Before Calling for Service

Check the following list to be sure a service call is necessary. Reviewing additional information on items to check may prevent an unneeded service call.

| PROBLEM | POSSIBLE CAUSES |
|-----------------------------------------------------------------------|----------------------------------------------------------------------------------------------------------------------------------------------------------------------------------------------------------------------------------------------------------------------------------|
| If nothing on the oven operates | <ul style="list-style-type: none"> • check for a blown circuit fuse or a tripped main circuit breaker. • check if oven is properly connected to the electric circuit in house. • check that controls are set properly. |
| If the oven interior light does not work | <ul style="list-style-type: none"> • the light bulb is loose or defective. |
| If oven will not cook | <ul style="list-style-type: none"> • check that control panel was programmed correctly. • check that door is firmly closed. • check that Start/Enter Pad was touched. • check that timer wasn't started instead of a cook function. |
| If oven takes longer than normal to cook or cooks too rapidly | <ul style="list-style-type: none"> • be sure the Power Level is programmed properly. |
| If the time of day clock does not always keep correct time | <ul style="list-style-type: none"> • check that the power cord is fully inserted into the outlet receptacle. • be sure the oven is the only appliance on the electrical circuit. |
| If food cooks unevenly | <ul style="list-style-type: none"> • be sure food is evenly shaped. • be sure food is completely defrosted before cooking. • check placement of aluminum foil strips used to prevent overcooking. |
| If food is undercooked | <ul style="list-style-type: none"> • check recipe to be sure all directions (amount, time, and power levels) were correctly followed. • be sure microwave oven is on a separate circuit. • be sure food is completely defrosted before cooking. |
| If food is overcooked | <ul style="list-style-type: none"> • check recipe to be sure all directions (amount, power level, time, size of dish) were followed. |
| If arcing (sparks) occur | <ul style="list-style-type: none"> • be sure microwavable dishes were used. • be sure wire twist ties were not used. • be sure oven was not operated when empty. • make sure metal rack (if used) is properly installed on 4 supports. |
| If the display shows a time counting down but the oven is not cooking | <ul style="list-style-type: none"> • check that door is firmly closed. • check that timer was not started instead of a cooking function. |
| Vent fan starts automatically | <ul style="list-style-type: none"> • If the temperature gets too hot around the microwave oven, the fan in the vent hood will automatically turn on at the LEVEL 4 setting to cool the oven. It may stay on up to an hour to cool the oven. |

TROUBLESHOOTING

WARNING

To avoid electrical shock which can cause severe personal injury or death, do not remove outer case at any time, only an authorized servicer should remove outer case.

QUESTIONS AND ANSWERS

| QUESTION | ANSWER |
|-----------------------------------------------------------------------------------------------------|----------------------------------------------------------------------------------------------------------------------------------------------------------------------------------------------------------------------------------------------------------------------------------------------------------------------------------------------------------------------------------------------------------------------------------------------------|
| Can I use a rack in my microwave oven so that I may reheat or cook in two rack positions at a time? | Only use the rack that is supplied with your microwave oven. Use of any other rack can result in poor cooking performance and/or arcing and may damage your oven. |
| Can I use either metal or aluminum pans in my microwave oven? | Usable metal includes aluminum foil for shielding (use small, flat pieces). Never allow metal to touch walls or door. |
| Sometimes the door of my microwave oven appears wavy. Is this normal? | This appearance is normal and does not affect the operation of your oven. |
| What are the humming noises I hear when my microwave oven is operating? | This is the sound of the transformer when the magnetron tube cycles on and off. |
| Why does the dish become hot when I microwave food in it? | As the food becomes hot it will conduct the heat to the dish. Use hot pads to remove food after cooking. Dish may not be microwave safe. |
| What does standing time mean? | Standing time means that food should be taken out of the oven and covered for additional time after cooking. This process allows the cooking to finish, saves energy, and frees the oven for other purposes. |
| Can I pop popcorn in my microwave oven? How do I get the best results? | Yes. Pop packaged microwave popcorn following manufacturer's guidelines or use the preprogrammed Popcorn pad. Do not use regular paper bags. Use the listening test by stopping the oven as soon as the popping slows to a pop every one or two seconds. Do not try to repop unpopped kernels. You can also use special microwave poppers. When using a popper, be sure to follow manufacturer's directions. Do not pop popcorn in glass utensils. |
| Why does steam come out of the air exhaust vent? | Steam is normally produced during cooking. The microwave oven has been designed to vent this steam out the top vent. |



LG MICROWAVE OVEN LIMITED WARRANTY — USA

Model: LMV2053SB / LMV2053ST / LMV2053SW

LG Electronics Inc. will repair or replace your product, at LG's option, if it proves to be defective in material or workmanship under normal use, during the warranty period set forth below, effective from the date of original consumer purchase of the product. This warranty is good only to the original purchaser of the product and effective only when used in the United States, including U.S. Territories.

| | |
|-------------------------------------------------------------------------------------------------------------------------------------------------------------------------------------------------------------------------------------------------------------------------------------------------------------------------------------------------------------------------------------------------------------------------------------------------------------------------------------------------------------------------------------------------------------|---------------------------------------------------------------------------------------------------------------------------------------------------------------------------------------------------------------------------------------------------------------------------------------------------------------------------------------------------|
| <p><u>WARRANTY PERIOD:</u></p> <p>LABOR: One Year from the Date of Purchase*.</p> <p>PARTS (except as listed below): One Year from the Date of Purchase*.</p> <p>MAGNETRON: Ten Years from the Date of Purchase*.</p> <p>Replacement Units and Repair Parts are warranted for the remaining portion of the original unit's warranty period.</p> <p>* Retain your Sales Receipt to prove the date of purchase. A copy of your Sales Receipt must be submitted at the time warranty service is provided.</p> | <p><u>HOW SERVICE IS HANDLED:</u></p> <p>Please call 1-800-243-0000 and choose the appropriate option. (Phones are answered 24 hours a day, 365 days per year.) Please have the product type (Microwave) and your ZIP code ready.</p> <p>Or visit our website at: http://us.lgservice.com</p> |
|-------------------------------------------------------------------------------------------------------------------------------------------------------------------------------------------------------------------------------------------------------------------------------------------------------------------------------------------------------------------------------------------------------------------------------------------------------------------------------------------------------------------------------------------------------------|---------------------------------------------------------------------------------------------------------------------------------------------------------------------------------------------------------------------------------------------------------------------------------------------------------------------------------------------------|

THIS WARRANTY IS IN LIEU OF ANY OTHER WARRANTY, EXPRESS OR IMPLIED, INCLUDING WITHOUT LIMITATION, ANY WARRANTY OF MERCHANTABILITY OR FITNESS FOR A PARTICULAR PURPOSE. TO THE EXTENT ANY IMPLIED WARRANTY IS REQUIRED BY LAW, IT IS LIMITED IN DURATION TO THE EXPRESS WARRANTY PERIOD ABOVE. LG WILL NOT BE LIABLE FOR ANY INCIDENTAL, CONSEQUENTIAL, INDIRECT, SPECIAL, OR PUNITIVE DAMAGES OF ANY NATURE, INCLUDING WITHOUT LIMITATION, LOST REVENUES OR PROFITS, OR ANY OTHER DAMAGE WHETHER BASED IN CONTRACT, TORT, OR OTHERWISE. Some states do not allow the exclusion or limitation of incidental or consequential damages or limitations on how long an implied warranty lasts, so the above exclusion or limitation may not apply to you. This warranty gives you specific legal rights and you may also have other rights that vary from state to state.

THIS LIMITED WARRANTY DOES NOT APPLY TO:

- Service trips to your home to deliver, pick up, and/or install the product, instruct, or replace house fuses or correct wiring, or correction of unauthorized repairs.
- Damages or operating problems that result from misuse, abuse, operation outside environmental specifications or contrary to the requirements of precautions in the Operating Guide, accident, vermin, fire, flood, improper installation, acts of God, unauthorized modification or alteration, incorrect electrical current or voltage, or commercial use, or use for other than intended purpose.

The cost of repair or replacement under these excluded circumstances shall be borne by the consumer.

CUSTOMER INTERACTIVE CENTER NUMBERS

| | |
|--------------------------------------------------------------------------------------------------------------------|-----------------------------------------------------------------------------------------------------------------------------------------------------------------------------------------------------------------------------|
| <p>To obtain Customer Assistance, Product Information, or Dealer or Authorized Service Center location:</p> | <p>Call 1-800-243-0000 (24 hours a day, 365 days per year) and select the appropriate option from the menu.</p> <p>Or visit our website at: http://us.lgservice.com</p> |
|--------------------------------------------------------------------------------------------------------------------|-----------------------------------------------------------------------------------------------------------------------------------------------------------------------------------------------------------------------------|

TO CONTACT LG ELECTRONICS BY MAIL:

LG Customer Interactive Center
 P. O. Box 240007
 201 James Record Road
 Huntsville, Alabama 35824
 ATTN: CIC

Memo

Memo



LG Electronics Inc.