



Electric Range

Slide-in models

Use & Care Guide

Estufa eléctrica

Modelos deslizables

Manual de uso y cuidado

Models, Modelos

790.4661*

* = Color number, número de color

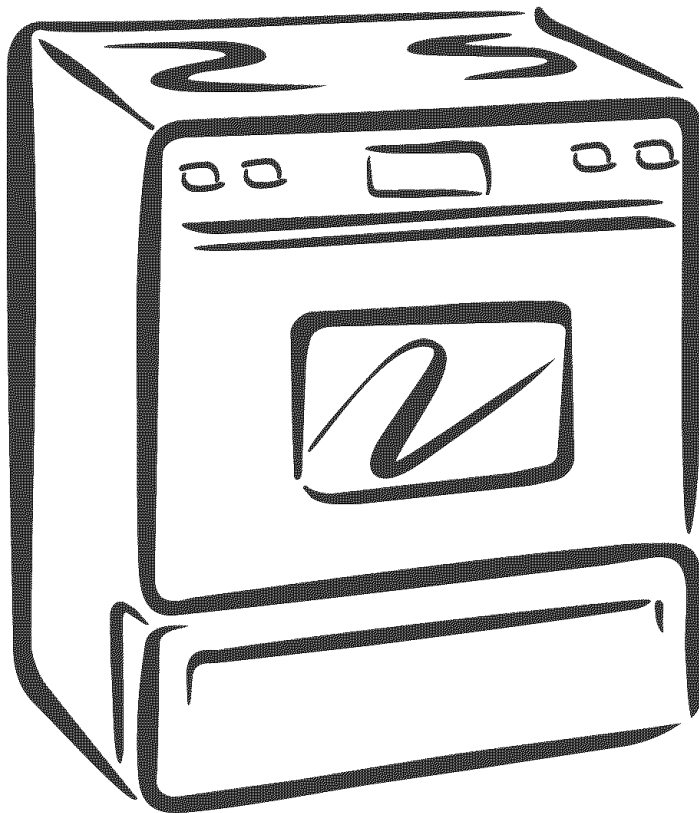

ENGLISH

ESPAÑOL

Table of Contents

Slide-in Range Warranty	2	Minimum and Maximum Control Pad Settings	16
IMPORTANT SAFETY INSTRUCTIONS	3-5	Setting Oven Controls	17-34
Product Record	5	Setting Warmer Drawer Controls	35-36
Protection Agreements	6	Self Cleaning	37-39
Range Features	7	Adjusting the Oven Temperature	39
Setting Surface Controls	8-13	General Care & Cleaning	40-43
Surface Cooking	14	Before you call	44-45
Before Setting the Oven Controls	14-15	Sears Service	46
Control Pad Features	16		

Kenmore Elite Appliance Warranty

One Year Limited Warranty

When installed, operated and maintained according to all instructions supplied with the product, if this appliance fails due to a defect in material or workmanship within one year from the date of purchase, call **1-800-4-MY-HOME**® to arrange for free repair. If this appliance is used for other than private family purposes, this warranty applies for only 90 days from the date of purchase.

This warranty covers only defects in material and workmanship. Sears will NOT pay for:

1. Expendable items that can wear out from normal use, including but not limited to filters, belts, light bulbs, and bags.
2. A service technician to instruct the user in correct product installation, operation or maintenance.
3. A service technician to clean or maintain this product.
4. Damage to or failure of this product if it is not installed, operated or maintained according to all instructions supplied with the product.
5. Damage to or failure of this product resulting from accident, abuse, misuse or use for other than its intended purpose.
6. Damage to or failure of this product caused by the use of detergents, cleaners, chemicals or utensils other than those recommended in all instructions supplied with the product.
7. Damage to or failure of parts or systems resulting from unauthorized modifications made to this product.

FIVE-YEAR LIMITED WARRANTY

For the second through the fifth year from the date of purchase, when installed and operated according to the Installation Instructions and Use & Care Guide, **Sears will supply the following range parts free of charge** if they fail for the reasons listed below. Customer must pay labor cost of installation.

- Cooktop glass if it fails due to thermal shock.
- Cooktop elements if they are defective.

What Sears will not cover:

- Failure of the product if it is abused, misused, or used for other than the intended purpose.
- Damage to the cooktop glass caused by the use of cleaners or utensils other than the recommended cleaning cream and tools.
- Damage to the cooktop glass caused by hardened spills of sugary materials (including starches from vegetables or pastas) or melted plastic that are not cleaned according to the directions in the Use & Care Guide.
- Repairs to parts or systems resulting from unauthorized modifications made to the appliance.

Disclaimer of implied warranties; limitation of remedies

Customer's sole and exclusive remedy under this limited warranty shall be product repair as provided herein. Implied warranties, including warranties of merchantability or fitness for a particular purpose, are limited to one year or the shortest period allowed by law. Sears shall not be liable for incidental or consequential damages. Some states and provinces do not allow the exclusion or limitation of incidental or consequential damages, or limitations on the duration of implied warranties of merchantability or fitness, so these exclusions or limitation may not apply to you.

This warranty applies only while this appliance is used in the United States and Canada.

This warranty gives you specific legal rights, and you may also have other rights which vary from state to state.

Sears, Roebuck and Co., Dept. 817WA, Hoffman Estates, IL 60179

Sears Canada Inc., Toronto, Ontario, Canada M5B 2B8

Important Safety Instructions

Read all instructions before using this appliance.

Save these instructions for future reference.

This manual contains many important safety messages. Always read and obey all safety messages.

The safety symbol  calls your attention to safety messages that inform you of hazards that can kill or hurt you or others, or cause damage to the product.

⚠ WARNING Indicates an imminently hazardous situation which, if not avoided may result in death or serious injury.

⚠ CAUTION Indicates an imminently hazardous situation which, if not avoided may result in minor or moderate injury, or product damage.

All safety messages will identify the hazard, tell you how to reduce the chance of injury, and tell you what can happen if the instructions are not followed.

- **Remove all tape and packaging before using the range.** Destroy the carton and plastic bags after unpacking the range. Never allow children to play with packaging material.
- **Proper Installation—Be sure your appliance is properly installed and grounded by a qualified technician in accordance with the National Electrical Code ANSI/NFPA No. 70 latest edition, and local code requirements.** Install only per installation instructions provided in the literature package for this range.

Sears Parts & Repair is the recommended repair service for this appliance. Know how to disconnect the electrical power to the appliance at the circuit breaker or fuse box in case of an emergency.

- **User servicing—Do not repair or replace any part of the appliance unless specifically recommended in the manuals.** All other servicing should be done only by a qualified technician. This may reduce the risk of personal injury and damage to the range.
- **Never modify or alter the construction of a range by removing leveling legs, panels, wire covers, anti-tip brackets/screws, or any other part of the product.**

⚠ WARNING Stepping, leaning or sitting on the door or drawer of this range can result in serious injuries and also cause damage to the range. Do not allow children to climb or play around the range. The weight of a

child on an open door may cause the range to tip, resulting in serious burns or other injury. An open drawer, when hot, may cause burns.

⚠ WARNING Do not use the oven or warmer drawer (if equipped) for storage.

⚠ CAUTION Do not store items of interest to children in the cabinets above a range. Children climbing on the range to reach items could be seriously injured.

⚠ WARNING Never use your appliance for warming up or heating up the room.

- **Storage in or on appliance—Flammable materials should not be stored in an oven, near surface units or in the drawer (if equipped).** This includes paper, plastic and cloth items, such as cookbooks, plasticware and towels, as well as flammable liquids. Do not store explosives, such as aerosol cans, on or near the appliance. Flammable materials may explode and result in fire or property damage.
- **Do not leave children alone—Children should not be left alone or unattended in the area where appliance is in use.** They should never be allowed to sit or stand on any part of the appliance.
- **DO NOT TOUCH SURFACE UNITS, AREAS NEAR THESE UNITS, OVEN HEATING ELEMENTS OR INTERIOR SURFACES OF THE OVEN OR WARMER DRAWER (if equipped).** Both surface and oven heating elements may be hot even though they are dark in color. Areas near surface units may become hot enough to cause burns. During and after use, do not touch, or let clothing or other flammable materials touch these areas until they have had sufficient time to cool. Among these areas are the cooktop, surfaces facing the cooktop, the oven vent openings and surfaces near these openings, oven door and window.
- **Wear proper apparel—Loose-fitting or hanging garments should never be worn while using the appliance.** Do not let clothing or other flammable materials contact hot surfaces.
- **Do not use water or flour on grease fires—Smother the fire with a pan lid, or use baking soda, a dry chemical or foam-type extinguisher.**



⚠ WARNING

- All ranges can tip.
- Injury to persons could result.
- Install anti-tip device packed with range.
- See Installation Instructions.



To reduce the risk of tipping, the range oven must be secured by properly installed anti-tip bracket(s) provided with the range. To check if the bracket(s) is installed properly, remove the lower panel or storage drawer and verify that the anti-tip bracket(s) is engaged. Refer to the Installation Instructions for proper anti-tip bracket(s) installation.

Important Safety Instructions

- **When heating fat or grease, watch it closely.** Fat or grease may catch fire if allowed to become too hot.
- **Use only dry potholders—Moist or damp potholders on hot surfaces may result in burns from steam.** Do not let potholders touch hot heating elements. Do not use a towel or other bulky cloth instead of a potholder.
- **Do not heat unopened food containers—Buildup of pressure may cause container to burst and result in injury.**
- **Remove the oven door from any unused range if it is to be stored or discarded.**

IMPORTANT—Do not attempt to operate the oven during a power failure. If the power fails, always turn the oven off. If the oven is not turned off and the power resumes, the oven may begin to operate again. (Food left unattended could catch fire or spoil.)

⚠ CAUTION Electronic controllers can be damaged by cold temperatures. When you use your appliance for the first time, or if it has not been used for a long period of time, make sure that it has been exposed to a temperature above 0°C/32°F for at least 3 hours before connecting it to the power supply.

IMPORTANT INSTRUCTIONS FOR USING YOUR COOKTOP

- **Know which knob controls each surface heating unit.**
- **Use proper pan size.** This appliance is equipped with one or more surface units of different sizes. Select utensils having flat bottoms large enough to cover the surface unit. The use of undersized utensils will expose a portion of the surface heating unit to direct contact and may result in ignition of clothing. Proper relationship of utensil to the surface unit will also improve efficiency.
- **Utensil handles should be turned inward and not extend over adjacent surface units.** To reduce the risk of burns, ignition of flammable materials, and spillage due to unintentional contact with the utensil.
- **Never leave surface burners unattended at high heat settings—**Boilovers cause smoking and greasy accumulations that may ignite, or a pan that has boiled dry may melt.
- **Protective liners—**Do not use aluminum foil to line oven bottom or any other part of the appliance. Only use aluminum foil as recommended for baking if used as a cover placed on the food. Any other use of protective liners or aluminum foil may result in a risk of electric shock or fire or short circuit.
- **Glazed cooking utensils—**Only certain types of glass, glass/ceramic, ceramic, earthenware, or other glazed utensils are suitable for rangetop service without breaking due to the sudden change in temperature. Check the manufacturer's recommendations for cooktop use.

- **Do not use decorative surface element covers.** If an element is accidentally turned on, the decorative cover will become hot and possibly melt. Burns will occur if the hot covers are touched. Damage may also be done to the cooktop.

FOR COOKTOPS WITH COIL ELEMENTS ONLY

- **Do Not Immerse or Soak Removable Surface Heating Elements.** Surface heating elements should never be immerse in water. Heating elements clean themselves during normal operation.
- **Make Sure Drip Pans or Drip Bowls Are in Place.** Absence of these pans or bowls during cooking may subject wiring or components underneath to damage.

FOR GLASS COOKTOPS ONLY

- **Do not clean or operate a broken cooktop—**If cooktop should break, cleaning solutions and spills may penetrate the broken cooktop and create a risk of electric shock. Contact a qualified technician immediately.
- **Clean cooktop glass with caution—**If a wet sponge or cloth is used to wipe spills on a hot cooking area, be careful to avoid a steam burn. Some cleaners can produce harmful fumes if applied to a hot surface.
- **Avoid scratching the cooktop glass with sharp objects.**

IMPORTANT INSTRUCTIONS FOR USING YOUR OVEN

- **Use care when opening oven door or warmer drawer (if equipped)—**Stand to the side of the range when opening the door of a hot oven. Let hot air or steam escape before you remove or replace food in the oven / warmer drawer.
- **Keep oven vent ducts unobstructed.** The oven vent is located **at right side of the front panel** and visible when the oven door is open. Touching the surfaces in this area when the oven is operating may cause severe burns. Also, do not place plastic or heat-sensitive items on or near the oven vent. These items could melt or ignite.
- **Placement of oven/warmer drawer (if equipped) Racks.** Always place oven racks in desired location while oven/warmer drawer (if equipped) is cool. If rack must be moved while oven is hot use extreme caution. Use potholders and grasp the rack with both hands to reposition. Do not let potholders contact the hot heating elements in the oven/warmer drawer (if equipped). Remove all utensils from the rack before moving.
- **Do not use the broiler pan without its insert.** The broiler pan and its insert allow dripping fat to drain and be kept away from the high heat of the broiler.

Important Safety Instructions

- **Do not cover the broiler insert with aluminum foil.** Exposed fat and grease could ignite.
- **Do not touch a hot light bulb with a damp cloth.** Doing so could cause the bulb to break. Disconnect the appliance or turn off the power to the appliance before removing and replacing light bulb.
- **Do not use oven cleaners**—No commercial oven cleaner or oven liner protective coating of any kind should be used in or around any part of the oven.
- **Do not clean door gasket**—The door gasket is essential for a good seal. Care should be taken not to rub, damage or move the gasket.
- **Remove oven racks.** Oven racks color will change if left in the oven during a self-cleaning cycle.

IMPORTANT INSTRUCTIONS FOR CLEANING YOUR RANGE

- **Clean the range regularly to keep all parts free of grease that could catch fire.** Exhaust fan ventilation hoods and grease filters should be kept clean. Do not allow grease to accumulate on hood or filter. Greasy deposits in the fan could catch fire. When you are flaming food under the hood, turn the fan on. Refer to the hood manufacturer's instructions for cleaning.

SELF-CLEANING OVENS

- **In the self-cleaning cycle, only clean the parts listed in this Use and Care Guide.** Before self-cleaning the oven, remove the broiler pan and any utensils or foods from the oven.

CAUTION The health of some birds is extremely sensitive to the fumes given off during the self-cleaning cycle of any range. Move birds to another well ventilated room.

IMPORTANT SAFETY NOTICE

The California Safe Drinking Water and Toxic Enforcement Act requires the Governor of California to publish a list of substances known to the state to cause cancer, birth defects or other reproductive harm, and requires businesses to warn customers of potential exposure to such substances.

ENGLISH

SAVE THESE SAFETY INSTRUCTIONS

Product Record

In this space below, record the date of purchase, model and serial number of your product. You will find the model and serial number printed on the serial plate.

Model No. **790.** _____

Serial No. _____

Date of purchase _____

Save these instructions and your sales receipt for future reference.

Please carefully read and save these instructions

This Use & Care Manual contains general operating instructions for your appliance and feature information for several models. Your product **may not** have all the described features. The graphics shown are representative. The graphics on your appliance may not look exactly like those shown. Common sense and caution must be practiced when installing, operating and maintaining any appliance.

Serial Plate Location

You will find the model and serial number printed on the serial plate. The serial plate is located as shown below.

Remember to record the serial number for future reference.

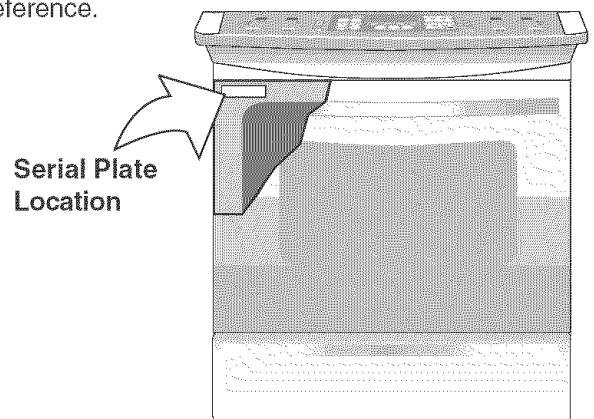

PROTECTION AGREEMENTS

In the U.S.A.

Master Protection Agreements

Congratulations on making a smart purchase. Your new Kenmore® product is designed and manufactured for years of dependable operation. But like all products, it may require preventive maintenance or repair from time to time. That's when having a Master Protection Agreement can save you money and aggravation.

Purchase a Master Protection Agreement now and protect yourself from unexpected hassle and expense.

The Master Protection Agreement also helps extend the life of your new product. Here's what's included in the Agreement:

- ✓ **Expert service** by our 12,000 professional repair specialists
- ✓ **Unlimited service and no charge** for parts and labor on all covered repairs
- ✓ **"No-lemon" guarantee** – replacement of your covered product if four or more product failures occur within twelve months
- ✓ **Product replacement** if your covered product can't be fixed
- ✓ **Annual Preventive Maintenance Check** at your request – no extra charge
- ✓ **Fast help by phone** – phone support from a Sears technician on products requiring in-home repair, plus convenient repair scheduling
- ✓ **Power surge protection** against electrical damage due to power fluctuations
- ✓ **Rental reimbursement** if repair of your covered product takes longer than promised

Once you purchase the Agreement, a simple phone call is all that it takes for you to schedule service. You can call anytime day or night, or schedule a service appointment on-line.

Sears has over 12,000 professional repair specialists, who have access to over 4.5 million quality parts and accessories. That's the kind of professionalism you can count on to help prolong the life of your new purchase for years to come. Purchase your Master Protection Agreement today!

Some limitations and exclusions apply.
For prices and additional information call
1-800-827-6655.

Sears Installation Service

For Sears professional installation of home appliances, garage door openers, water heaters, and other major home items, in the U.S.A. call **1-800-4-MY-HOME®**

In Canada

Maintenance Agreements

Your purchase has added value because you can depend on Sears HomeCentral® for service. With over 2400 Service Technicians and more than a million parts and accessories, we have the tools, parts, knowledge and skills to ensure our pledge: We Service What We Sell.

Your Kenmore® product is designed, manufactured and tested to provide years of dependable operation. But like all products, it may require service from time to time. The Sears Maintenance Agreement offers you an outstanding service program, affordably priced.

The Sears Maintenance Agreement:

- Is your way to buy tomorrow's service at today's price
- Eliminates repair bills resulting from normal wear and tear
- Provides phone support from a Sears technician on products requiring in-home repair
- Even if you don't need repairs, provides an annual Preventive Maintenance Check, at your request, to ensure that your product is in proper running condition.

Some limitations apply. For more information about Sears Canada Maintenance Agreements, call 1-800-361-6665

Range features

Your Electric Range Features At a Glance

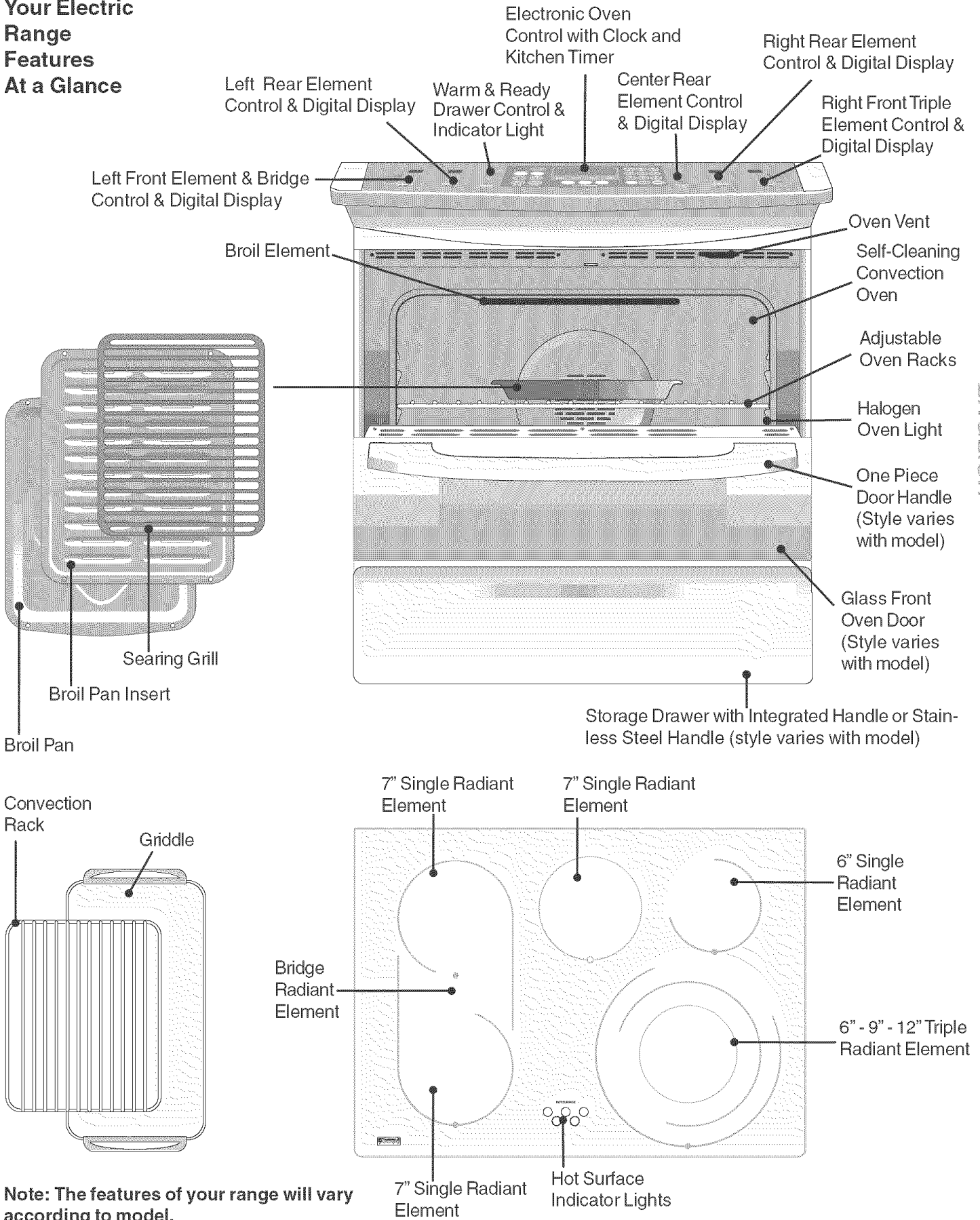

Note: The features of your range will vary according to model.

Setting Surface Controls

About the Ceramic Glass Cooktop

The ceramic cooktop has radiant surface elements located below the surface of the glass. The design of the ceramic cooktop outlines the area of the surface element underneath. **Make sure** the diameter of the pan matches the diameter of the element outline on the cooktop (See Figure 1).

Heat is transferred up through the surface of the cooktop to the cookware. Only flat-bottom cookware should be used. The type and size of cookware, the number of surface elements in use and their settings, are all factors that will affect the amount of heat that will spread to areas beyond the surface elements. The areas surrounding the elements may become **hot enough to cause burns**.

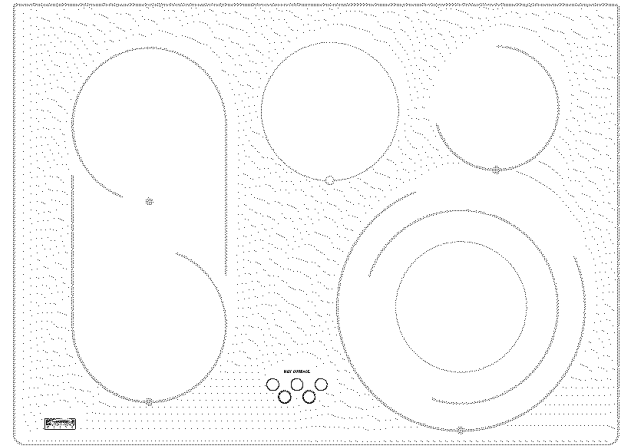

Figure 1

About the Radiant Surface Elements

The element temperature rises gradually and evenly. As the temperature rises, the element will glow red. To maintain the selected setting, the element will cycle on and off. The heating element retains enough heat to provide a uniform and consistent heat during the off cycle. **For efficient cooking, turn off the element several minutes before cooking is complete.** This will allow residual heat to complete the cooking process.

Locations of the Radiant Surface Elements and Controls

Your range is equipped with radiant surface burners with different wattage ratings. The ability to heat food quicker and in larger volumes increases as the element wattage increases. The radiant surface elements are located on the cooktop as follows:

- a 6 inch radiant element located at the right rear position;
- a 6 / 9 / 12 inch Triple element located at the right front position;
- a 7 inch radiant element located at the center rear position;
- Two 7 inch radiant elements located at both the left front and rear positions. Located between the left front and rear elements is a Bridge radiant element.

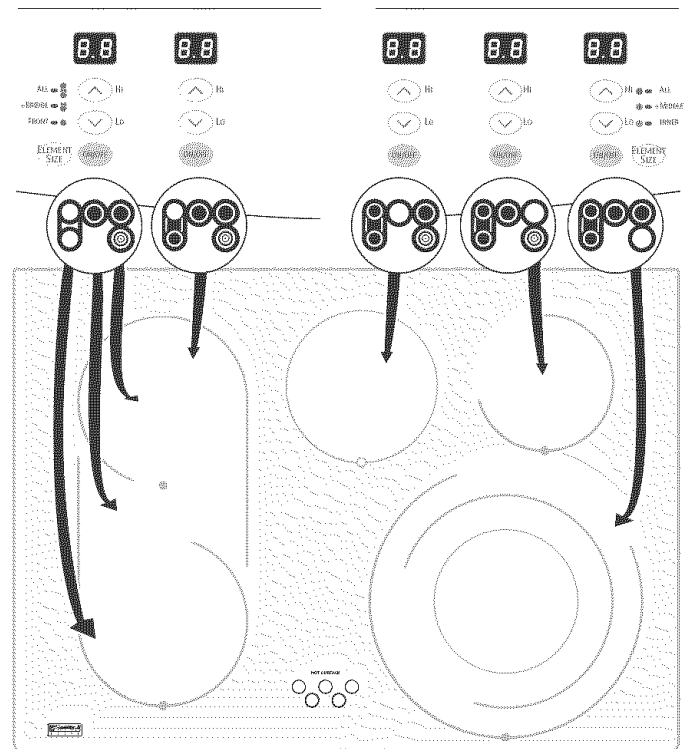

Figure 2

Note: Please read detailed instructions for ceramic glass cooktop cleaning in the **General Care & Cleaning** section and **Before You Call** checklist section of this Use and Care Guide.

Note: Radiant elements have a limiter that allows the element to cycle on and off, even at the HI setting. This helps to prevent damage to the ceramic glass cooktop. Cycling at the HI setting is normal and can also occur if the cookware is too small for the radiant element or if the cookware bottom is not flat (Refer to page 14 for using correct cookware instructions with the cooktop).

Note: (White glass cooktops only) Due to the high intensity of heat generated by the surface elements, the glass surface will turn green when the element is first turned off. This phenomenon is normal and the glass will come back to its original white color after it has completely cooled down.

CAUTION Radiant surface elements may appear to have cooled after they have been turned off. **The glass surface may still be hot** and burns may occur if the glass surface is touched before it has cooled sufficiently.

CAUTION Do not place plastic items such as salt and pepper shakers, spoon holders or plastic wrappings on top of the range when it is in use. These items could melt or ignite. Potholders, towels or wooden spoons could catch fire if placed too close to the surface elements.

Setting Surface Controls (cont'd)

The Electronic Surface Element Control (ESEC)

The Electronic Surface Element Control (ESEC) feature provides a digital display of the radiant surface elements on the cooktop. The ESEC display in combination with the touch pads are designed to replace conventional control knobs.

The available ESEC Window Display Settings

The ESEC control will display heat levels ranging from **Hi** (Figure 1) to **Lo** (Figure 6) and **OFF** (Figure 7). The settings between **9.0** (Figure 2) and **3.0** (Figure 3) decrease or increase in increments of .5 (1/2). The settings between **3.0** (Figures 3 & 4) and **1.0** (Figure 5) are Simmer settings which decrease or increase in increments of .2 (1/5) to **Lo** (Figure 6; lowest Simmer setting) for more precise settings at lower heat levels. Use the Recommended Surface Setting Chart (See Figure 12) to determine the correct setting for the kind of food you are preparing.

Hot Surface Indicator Lights

After using any of the radiant element positions the cooktop will become very hot. After turning any of these elements OFF, the cooktop will remain HOT for some time. The "Hot Surface" indicator light located on the glass cooktop will glow whenever any of the element positions become HOT. The **Hot Surface** indicator light will remain ON while hot and turn OFF once the cooktop has cooled sufficiently.

ESEC Lockout Feature (- -)

The ESEC feature will not operate during a Self-Clean cycle or when the Cooktop Lockout feature is active. Whenever the Cooktop Lockout feature is active, " - - " will appear in any display window (See Figure 8).

ESEC PF message

The ESEC will display the PF message (Figure 9) whenever there has been a power interruption to the appliance. To clear the PF message touch any ON/OFF ESEC control pad to reset and be sure to reset the clock with the correct time of day if necessary. If the PF displays again repeat these steps.

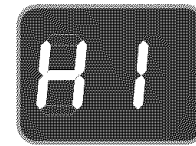

Figure 1

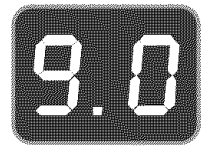

Figure 2



Figure 3

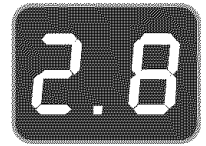

Figure 4

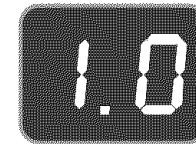

Figure 5

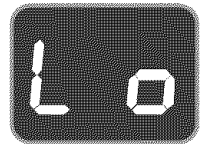

Figure 6

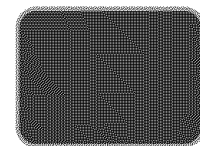

Figure 7

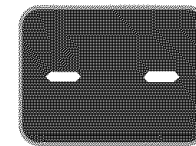

Figure 8

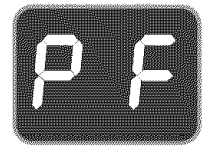

Figure 9

ENGLISH

Recommended Surface Cooking Settings

Recommended Settings for Single, Bridge & Triple Surface Elements	
Setting	Type of Cooking
HIGH (8.0 - Hi)	Start most foods, bring water to a boil or pan broiling
MEDIUM HIGH (5.0 - 8.0)	Continue a rapid boil, fry, deep fat fry
MEDIUM (3.0 - 5.0)	Maintain a slow boil, thicken sauces and gravies, steam vegetables
MEDIUM LOW (2.0 - 4.0)	Keep foods cooking, poach, stew (2.8 or lower is a simmer setting).
LOW/SIMMER (Lo - 2.0)	Keep warm, melt, simmer (2.8 or lower is a simmer setting).





Note: The size and type of cookware used will influence the setting needed for best cooking results. The Simmer settings are used to simmer and keep larger quantities of foods warm such as stews and soups. The lower Simmer settings are ideal for delicate foods and melting chocolate or butter.

Setting Surface Controls (cont'd)

Operating Single Radiant Surface Elements

The cooktop has 4 SINGLE radiant surface elements: the **RIGHT REAR** position (Figure 1), the **CENTER REAR** position (Figure 2), the **LEFT REAR** position (Figure 3) and the **LEFT FRONT** position (Figure 4). The left elements may be combined with the bridge element. Refer to Page 10 for recommended surface cooking settings.

To Operate the Single Radiant Surface Elements:

1. Place correctly sized cookware on the radiant surface element.
2. Touch and hold the **ON/OFF** pad for the desired element position until a beep is heard. The display will show " -- ".
Note: If no further pads are touched within 10 seconds the request to power the element ON will clear.
3. Touch **HI**  pad once to turn ON the power level to **HI**.
Touch **Lo**  pad once for **Lo** (See Figure 5). The **Hot Surface** indicator light will turn ON when the element becomes hot.
4. Each touch of the **HI**  or **Lo**  pad will decrease or increase the power level from **9.0** through **3.0** by .5 increments. Simmer power levels between **3.0** and **1.0** will decrease or increase by .2 increments. **Lo** is the lowest power level available.
Note: The power level may be adjusted at any time while the element is ON.
5. When cooking has been completed touch the **ON/OFF** pad once to turn the element OFF.
Each surface element provides a constant amount of heat at each setting. A glowing red surface heating area extending beyond the bottom edge of the cookware indicates the cookware is **too small** for the surface heating area.
Note: The **Hot Surface** indicator light will remain ON if the cooktop is still hot and will remain ON until the heating surface area has cooled sufficiently.

CAUTION Radiant surface elements may appear to have cooled after they have been turned off. **The glass surface may still be hot** and burns may occur if the glass surface is touched before it has cooled sufficiently.

CAUTION Do not place plastic items such as salt and pepper shakers, spoon holders or plastic wrappings on top of the range when it is in use. These items could melt or ignite. Potholders, towels or wooden spoons could catch fire if placed too close to the surface elements.

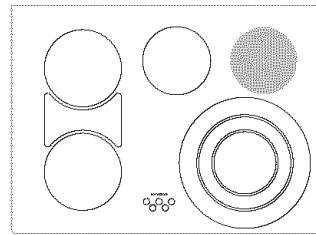

Figure 1
Right Rear Element

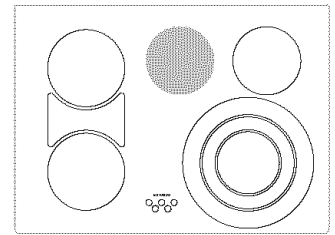

Figure 2
Center Rear Element

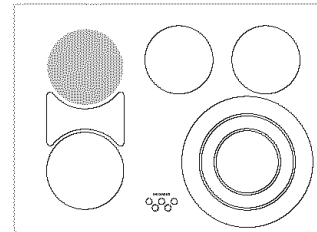

Figure 3
Left Rear Element

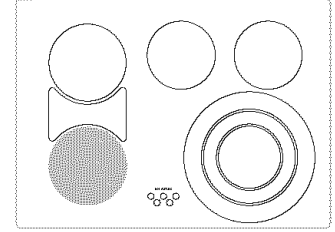

Figure 4
Left Front Element

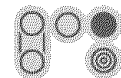
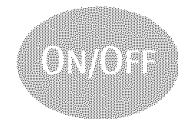
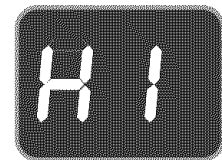

Figure 5

Setting Surface Controls (cont'd)

Operating the TRIPLE Surface Element

The cooktop is equipped with a TRIPLE radiant surface element located at the right front cooktop position (Figure 1). Indicator lights on the control panel at that position are used to indicate what portions of the Triple radiant element will heat. The **INNER** light indicates that only the inner element will heat. The **+MIDDLE** light indicates that both inner and middle elements will heat together. The **ALL** light indicates that all 3 portions of the element will heat. You may switch between all of these different settings at any time during cooking.

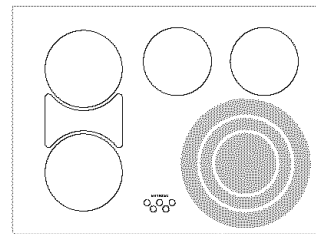

Figure 1

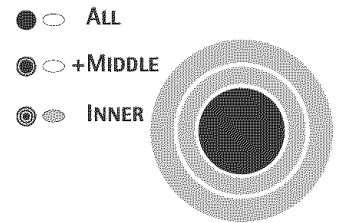

Figure 2

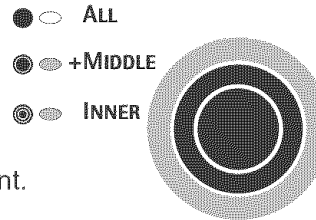

Figure 3

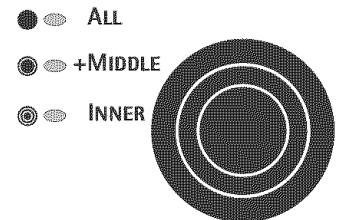

Figure 4

To Operate the Triple Surface Element:

1. Place correctly sized cookware on the radiant surface element.
2. Touch and hold the **ON/OFF** pad for the Triple element position until a beep is heard. The display will show " - - ".

Note: If no further pads are touched within 10 seconds the request to power the element ON will clear.

3. Select the **INNER** (See Figure 2), **+MIDDLE** (See Figure 3) or **ALL** 3 elements (See Figure 4) to heat by pressing the **ELEMENT SIZE** pad once, twice or three times (Figures 4 & 5 show indicator lights with **ALL** 3 elements selected).
4. Touch **HI** (^) pad once to turn ON the power level to **HI**. Touch **Lo** (v) pad once for **Lo** (See Figure 5). The **Hot Surface** indicator light will turn ON when the element becomes hot.
5. Each touch of the **HI** (^) or **Lo** (v) pad will decrease or increase the power level from **9.0** through **3.0** by .5 increments. Simmer power levels between **3.0** and **1.0** will decrease or increase by .2 increments. **Lo** is the lowest power level available.
Note: The power level may be adjusted at any time while the element is ON.
6. When cooking has been completed touch the **ON/OFF** pad once to turn the element OFF.
Each surface element provides a constant amount of heat at each setting. A glowing red surface heating area extending beyond the bottom edge of the cookware indicates the cookware is **too small** for the surface heating area.
Note: The **Hot Surface** indicator light will remain ON if the cooktop is still hot and will remain ON until the heating surface area has cooled sufficiently.

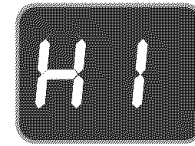

HI ● ● ● **ALL**
● ● ● **+MIDDLE**



LO ● ● ● **INNER**



Figure 5

ENGLISH

Note: If no element size is chosen when the Triple element is turned ON, the control will default to the inner coil only. See page 10 for recommended surface cooking settings.

CAUTION Radiant surface elements may appear to have cooled after they have been turned off. **The glass surface may still be hot** and burns may occur if the glass surface is touched before it has cooled sufficiently.

CAUTION Do not place aluminum foil or plastic items such as salt and pepper shakers, spoon holders or plastic wrappings on top of the range when it is in use. These items could melt or ignite. Potholders, towels or wooden spoons could catch fire if placed too close to the surface elements.

Setting Surface Controls (cont'd)

Operating the Bridge Surface Element

The cooktop is equipped with a "BRIDGE" surface element located at the left cooktop position (See Figure 1). Indicator lights on the control panel are used to indicate what portions of the Bridge element will heat. The Bridge element begins with the left **FRONT** position only (Figure 2) and when selected with the **+BRIDGE** element (Figure 3) it will provide a combination of 2 heating surfaces. When set for **ALL 3** element positions the left rear element is added for a total combination of 3 even heating surfaces (See Figure 4).

The Bridge element is designed for rectangular or oval shaped cookware. The **griddle** that is supplied with this appliance **should be used with the Bridge element ONLY**. For round shaped cookware, the left front element may be used as a single element.

To Operate the Bridge Surface Element:

1. Place correctly sized cookware on the radiant surface element.
2. Touch and hold the **ON/OFF** pad for the Bridge element position until a beep is heard. The display will show "--". **Note:** If no further pads are touched within 10 seconds the request to power the element ON will clear.
3. Select the **FRONT** (See Figure 2), **+BRIDGE** (See Figure 3) or **ALL 3** elements (See Figure 4) to heat by pressing the **ELEMENT SIZE** pad once, twice or three times (Figures 4 & 5 shows indicator lights with **ALL 3** elements selected).
4. Touch **HI** (^) pad once to turn ON the power level to **HI**. Touch **Lo** (v) pad once for **Lo** (See Figure 5). The **Hot Surface** indicator light will turn ON when the element becomes hot.
6. Each touch of the **HI** (^) or **Lo** (v) pad will decrease or increase the power level from **9.0** through **3.0** by .5 increments. Simmer power levels between **3.0** and **1.0** will decrease or increase by .2 increments. **Lo** is the lowest power level available. **Note:** The power level may be adjusted at any time while the element is ON.
6. When cooking has been completed touch the **ON/OFF** pad once to turn the element OFF.

Each surface element provides a constant amount of heat at each setting. A glowing red surface heating area extending beyond the bottom edge of the cookware indicates the cookware is **too small** for the surface heating area. **Note:** The **Hot Surface** indicator light will remain ON if the cooktop is still hot and will remain ON until the heating surface area has cooled sufficiently. If no element size is chosen when the Bridge element is turned ON, the control will default to the left front element only. See page 10 for recommended surface cooking settings.

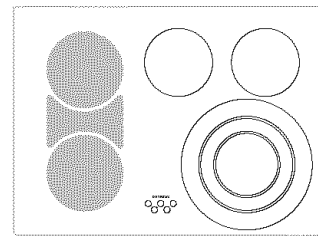

Figure 1

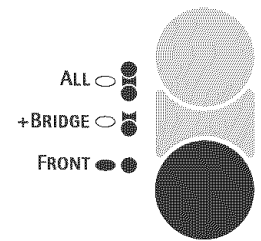

Figure 2

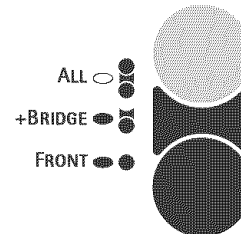

Figure 3

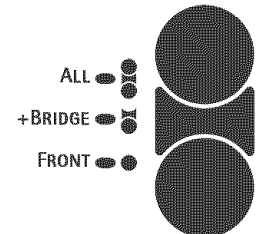

Figure 4

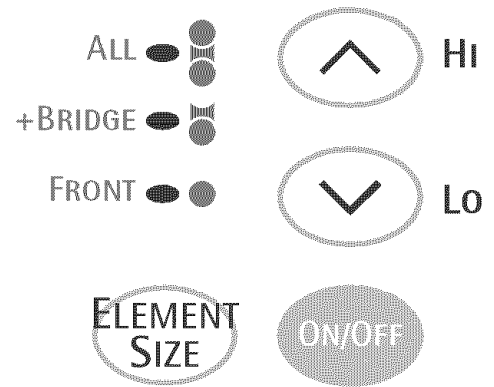
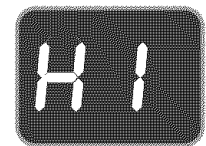
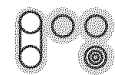

Figure 5



Note: If you bridge all three elements, any previous power level setting for the **LEFT REAR** element will be changed to the power level setting for the Bridge.

CAUTION Radiant surface elements may appear to have cooled after they have been turned off. **The glass surface may still be hot** and burns may occur if the glass surface is touched before it has cooled sufficiently.

CAUTION Do not place aluminum foil or plastic items such as salt and pepper shakers, spoon holders or plastic wrappings on top of the range when it is in use. These items could melt or ignite. Potholders, towels or wooden spoons could catch fire if placed too close to the surface elements.



Setting Surface Controls (cont'd)

To Set the Cooktop Lockout Feature COOKTOP



The  pad is used to activate the Cooktop Lockout feature which will lock all surface elements from being accidentally turned ON. This feature will only lock the cooktop.

INSTRUCTIONS

To turn the Cooktop Lockout Feature ON:

1. BE SURE ALL surface element controls are set to the OFF position.
2. Press and hold  until "CLO" appears. Continue holding until a second beep sounds (after 3 seconds). If a triple beep sounds instead, check all surface elements and turn them to the OFF position and repeat this step.  will appear in the display indicating the cooktop controls and functions are locked out until the cooktop is unlocked (See Figure 1).
3. To remove "CLO" from the display, press  or wait 30 seconds (See Figure 2).

To turn the Cooktop Lockout Feature OFF:

1. BE SURE ALL surface element controls are set to the OFF position.
2. Press and hold  until "CLO" appears. Continue holding until a second beep sounds (after 3 seconds). If a triple beep sounds instead, check all surface elements and turn them to the OFF position and repeat this step.  will disappear from the display indicating the cooktop may be used normally (See Figure 3).
3. To remove "CLO" from the display, press  or wait 30 seconds (See Figure 4).

Note: Starting a Self-Clean cycle will automatically turn ON the Cooktop Lockout feature. The cooktop will remain locked until the Self-Clean cycle has completed and the oven door has unlocked. If a power failure occurs after the Cooktop Lockout has been activated, you must turn OFF the Cooktop Lockout feature before being able to use the cooktop features again.

How the Electronic Surface Element Controls work when the Sabbath feature is ON.

When your Oven Sabbath feature is ON, the Electronic Surface Elements are also in Sabbath mode. This means that all electronic surface element control displays show "Sb". The surface elements can be used even if the Sabbath Feature is on.

To turn ON a Surface Element when the Oven Sabbath Feature is active:

If you turn on a surface element when the oven Sabbath feature is on, the electronic surface element control will record that request and execute it with a 15-30 seconds delay. So the element will start heating 15-30 seconds after the surface element control was turned on. As the oven control, the surface element display will not show the setting because "Sb" is on in the displays. When necessary, it is possible to adjust the power of the surface element but you have to remember that the surface element control will adjust the temperature with the same delay.

To turn OFF the Surface Element when the Oven Sabbath Mode is active:

To shut off the surface element while the Sabbath feature is ON, proceed as usual but take note that the element will immediately turn off without any delay.

Note: Refer to page 33-34 to activate the Sabbath Feature.

PRESS



DISPLAY



Figure 1



Figure 2



Figure 3



Figure 4

ENGLISH

Surface Cooking

Selecting Surface Cooking Cookware

Cookware should have flat bottoms that make good contact with the entire surface heating element. Check for flatness by rotating a ruler across the bottom of the cookware (See Figure 1).

Be sure to follow the recommendations for using cookware as shown in Figure 2.

Note: The size and type of cookware used will influence the setting needed for best cooking results.

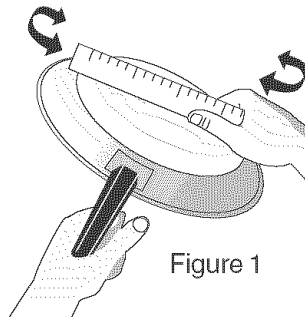

Figure 1

Cookware Material types

The cookware material determines how evenly and quickly heat is transferred from the surface element to the pan bottom. The most popular materials available are:

ALUMINUM - Excellent heat conductor. Some types of food will cause it to darken (Anodized aluminum cookware resists staining & pitting). If aluminum pans slide across the ceramic glass cooktop, they may leave metal marks which will resemble scratches. Remove these marks immediately.

COPPER - Excellent heat conductor but discolors easily. May leave metal marks on ceramic glass (see Aluminum above).

STAINLESS STEEL - Slow heat conductor with uneven cooking results. Is durable, easy to clean and resists staining.

CAST IRON - A poor heat conductor however will retain heat very well. Cooks evenly once cooking temperature is reached. Not recommended for use on ceramic cooktops.

PORCELAIN-ENAMEL on METAL - Heating characteristics will vary depending on base material. Porcelain-enamel coating must be smooth to avoid scratching ceramic cooktops.

GLASS - Slow heat conductor. Not recommended for ceramic cooktop surfaces because it may scratch the glass.

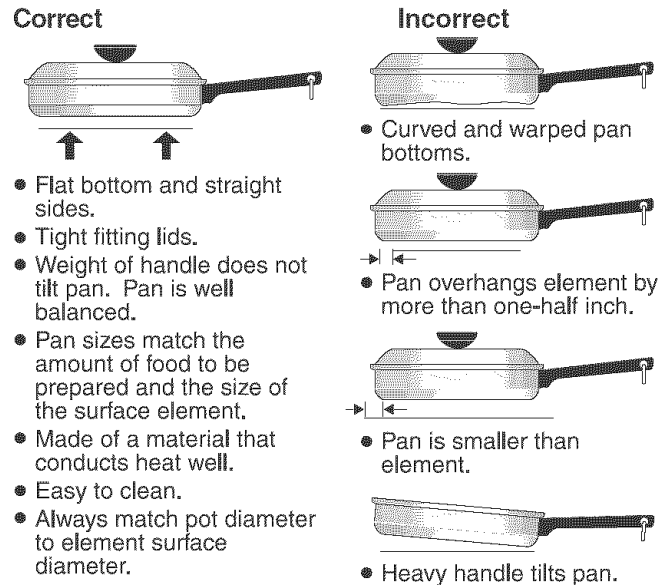

Figure 2

Before Setting Oven Controls

CAUTION This range has a fan that will turn "ON" and "OFF" by itself to keep the electronics cool. It may continue to run after the range has been turned "OFF", but may also stop immediately and then turn "ON" after a while.

Oven Vent Location

The oven vent is located at right side of the front panel and visible when the oven door is open. When the oven is on, hot air is released through the vents. This venting is necessary for proper air circulation in the oven and good baking results.

OVEN VENT

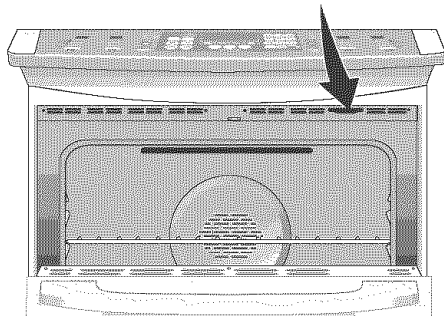

Removing and Replacing Oven Racks

To remove, pull the rack forward until it stops. Lift up front of rack and slide out. **To replace**, fit the rack onto the guides on the oven walls. Tilt the front of the rack upward and slide the rack back into place.

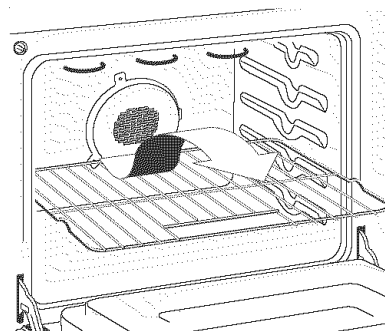

Before Setting Oven Controls (cont'd)

Arranging Oven Racks

ALWAYS ARRANGE OVEN RACKS WHEN THE OVEN IS COOL (PRIOR TO OPERATING THE OVEN). Always use oven mitts when the oven is hot.

RECOMMENDED RACK POSITIONS FOR BROILING, BAKING & ROASTING

Food	Rack position
Broiling meats, chicken or fish	3 or 4
Cookies, cakes, pies, biscuits & muffins	2 or 3
Using 1 rack	2 and 4
Using multiple racks	2 and 4
Frozen pies, angel food cake, yeast, bread, casseroles, small cuts of meat or poultry	1 or 2
Turkey, roast or ham	1

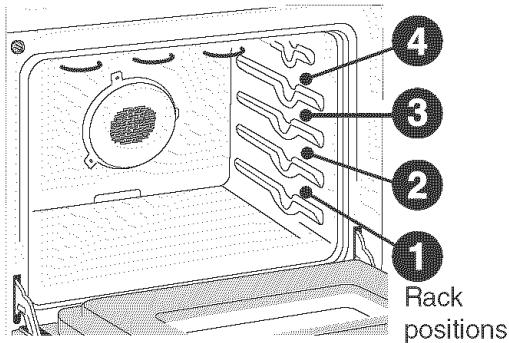
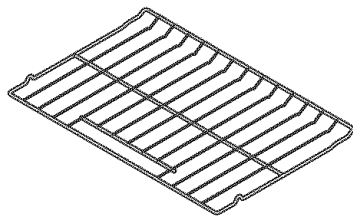

Figure 1

Note: Always use caution when removing food.

Types of Oven Racks



Flat Handle Oven Rack

Figure 2

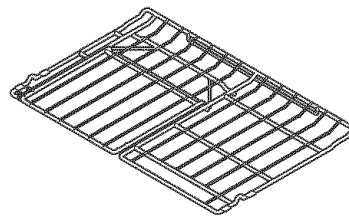

Flat Half Oven Rack

Figure 3

CAUTION Always use pot holders or oven mitts when adjusting the oven racks. Wait until the oven has completely cooled if possible. Oven racks may be HOT and may cause burns.

Your appliance may be equipped with one or more of the oven rack types shown; **Flat Handle Oven Rack** (Figure 2) and **Flat Oven Half Rack** (Figure 3).

The **Flat Half Rack** has a removable insert that can provide extra space for larger food items. The right half rack portion may still be used for other food items like a casserole dish (See Figure 3). To remove the insert, squeeze on the left front insert side (See Figure 4) of the rack and tilt out clockwise. To reinstall insert rear hooks at back of insert (See figure 5) and lay insert down. Make sure both insert front hooks snap into rack (See figure 5).

Do not use cookware that extends beyond the edge of the Flat Half Rack. For best results, allow 2 inches between the pan placed on the rack and oven side or rear walls.

Air Circulation in the Oven

For best air circulation and baking results allow 2-4" (5-10 cm) around the cookware for proper air circulation and be sure pans and cookware do not touch each other, the oven door, sides or back of the oven cavity. The hot air must circulate around the pans and cookware in the oven for even heat to reach around the food.



Figure 4

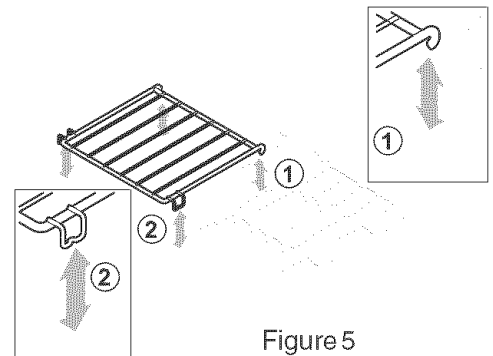
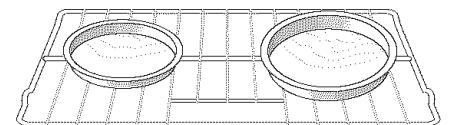
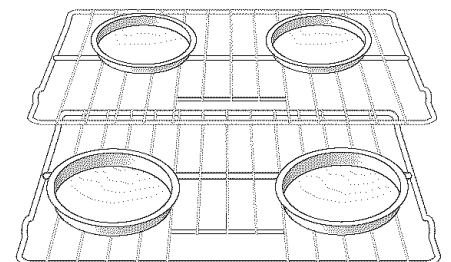

Figure 5



1 Oven Rack



Multiple Oven Racks

ENGLISH

Control Pad Features

READ THE INSTRUCTIONS CAREFULLY BEFORE USING THE OVEN. For satisfactory use of your oven, become familiar with the various features and functions of the oven as described below. **Detailed instructions for each feature and function follow later in this Use & Care Guide.**

DELAY START— Use with **BAKE, CONV BAKE, PREHEAT, SLOW COOK COOK TIME** and **CLEAN** to program a Delayed Timed Bake or Delay Self-Cleaning cycle start time.

FLEX CLEAN PAD— Use to select the Self-Cleaning feature.

START—Use to start all oven features (not used with Oven Light).

BAKE PAD— Use to enter the normal Bake feature.

BROIL PAD— Use to select variable broil function.

PREHEAT— Use to raise oven to cooking temperature.

0 THRU 9 NUMBER PADS— Use to enter temperature and times.

OVEN COOK TIME— Use to enter the length of the baking time.

ADD 1 MINUTE—Use to select Add 1 Minute feature.

SLOW COOK— Use to select the Slow Cook feature.

CONV CONVERT—Use to select the Convection Convert feature.

OVEN LIGHT—Use to turn the oven light ON and OFF.

WARM & HOLD INDICATOR LIGHT—Indicates if the warm & hold feature is active.

WARM & HOLD PAD—Use to select the Warm & Hold feature.

KITCHEN TIMER ON/OFF Use to set or cancel the Kitchen Timer. The Kitchen Timer does not start or stop cooking.

CONVECTION BAKE— Use to select the Convection Bake feature.

CLOCK SET— Use to set the time of day; also controls the Cooktop Lockout feature.

STOP CLEAR—Use to cancel any oven mode previously entered except the time of day and minute timer. Press **STOP/CLEAR** to stop cooking. **STOP/CLEAR** also controls the Oven Lockout feature.

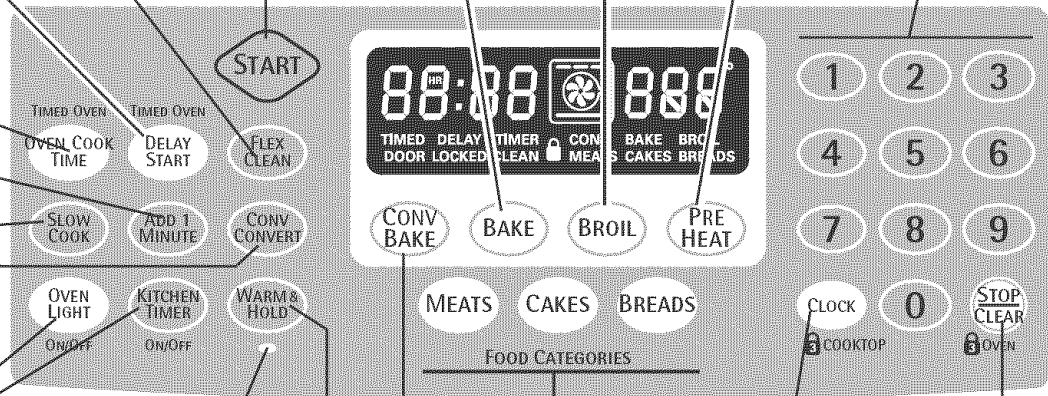

Minimum and Maximum Control Pad Settings

All of the features listed below have minimum and maximum time or temperature settings that may be entered into the control. An ENTRY acceptance beep will sound each time a control pad is touched (the Oven Lockout pad is delayed 3 seconds).

An ENTRY ERROR tone (3 short beeps) will sound if the entry of the temperature or time is below the minimum or above the maximum settings for the feature.

FEATURE	MINIMUM TEMP. /TIME	MAXIMUM TEMP. /TIME
PREHEAT TEMP.	170°F/77°C	550°F/288°C
BAKE, CAKES, BREADS TEMP.	170°F/77°C	550°F/288°C
BROIL TEMP.	400°F/205°C	550°F/288°C
KITCHEN TIMER	12 Hr. 0:01 Min.	11:59 Hr./Min.
	24 Hr. 0:01 Min.	11:59 Hr./Min.
CLOCK TIME	12 Hr. 1:00 Hr./Min.	12:59 Hr./Min.
	24 Hr. 0:00 Hr./Min.	23:59 Hr./Min.
COOK TIME	12 Hr. 0:01 Min.	11:59 Hr./Min.
	24 Hr. 0:01 Min.	11:59 Hr./Min.
DELAY START	12 Hr. 1:00 Hr./Min.	12:59 Hr./Min.
	24 Hr. 0:00 Hr./Min.	23:59 Hr./Min.
CLEAN TIME	2 hours	4 hours
CONVECTION BAKE, MEATS TEMP.	325°F/163°C	550°F/288°C

Setting Oven Controls





Setting the Clock

The **CLOCK**  pad is used to set the clock. The clock may be set for 12 or 24 hour time of day operation. The clock has been preset at the factory for the 12 hour operation. When the range is first plugged in, or when the power supply to the range has been interrupted, the display will flash with "PF" (power failure, See Figure 1).







When **PF** appears in the display, press . No sound will be heard, but after 10 seconds a beep will sound and PF will disappear.

INSTRUCTIONS

To set the clock (example below for 1:30)

1. Press . "CLO" will appear in the display (Figure 2).
2. Press    pads to set the time of day to 1:30 (Figure 3). "CLO" will stay in the display. Press . "CLO" will disappear and the clock will start (Figure 8).

Changing between 12 or 24 hour time of day display

1. Press and hold . "CLO" will appear in the display (Figure 3). After 3 seconds  will appear in the display indicating that the cooktop lockout is active (Figure 4). CONTINUE holding the pad until "12Hr" (Figure 5) or "24Hr" (Figure 6) appears in the display.
2. Press  to switch between the 12 and 24 hour time of day display. The display will show either "12Hr" (Figure 5) or "24Hr" (Figure 6).
3. Press  to accept the desired change or press  to reject the change (Figure 7).
4. Press and hold  until  disappears to cancel the cooktop lockout feature if desired (Figure 8).
5. Reset the correct time as described in **To set the Clock** above. Please note that if the 24 hour time of day mode was chosen, the clock will now display time from 0:00 through 23:59 hours.

PRESS

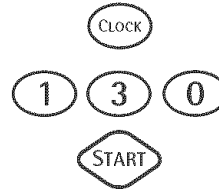

DISPLAY



Figure 1



Figure 2



Figure 3



Figure 4



Figure 5



Figure 6



Figure 7





Figure 8

ENGLISH





Setting Oven Controls (con't)

Setting Continuous Bake or 12 Hour Energy Saving

The **KITCHEN TIMER**  and **FLEX CLEAN**  pads control the Continuous Bake or 12 Hour Energy Saving features. The oven control has a factory preset built-in 12 Hour Energy Saving feature that will shut off the oven if the oven control is left on for more than 11 hours and 59 minutes. The oven can be programmed to override this feature for Continuous Baking.

INSTRUCTIONS

To set the control for Continuous Bake or 12 Hour Energy Saving features

1. Press and hold  for 7 seconds (Figure 1). "12Hr" or "-:Hr" will appear in the display and the control will beep once.
2. Press  to switch between the 12 Hour Energy Saving and continuous bake features. **Note:** "12Hr" (Figure 2) in the display indicates the control is set for the 12 Hour Energy Saving feature and "-:Hr" indicates the control is set for the Continuous Bake feature (Figure 3).
3. Press  to accept the change (Figure 4; display will return to time of day) or press  to reject the change.

PRESS

DISPLAY

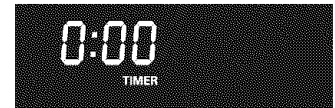

Figure 1

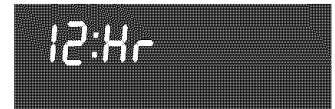

Figure 2



Figure 3







Figure 4

Setting Kitchen Timer

The **KITCHEN TIMER**  pad controls the Kitchen Timer feature. The Kitchen Timer serves as an extra timer in the kitchen that will beep when the set time has run out. It does not start or stop cooking. The Kitchen Timer feature can be used during any of the other oven control functions. Refer to "Minimum and Maximum Control Pad Settings" for time amount settings.

INSTRUCTIONS

To set the Kitchen Timer (example for 5 minutes)

1. Press . "0:00" will appear and "TIMER" will flash in the display (Figure 5).
2. Press the number pads to set the desired time in the display (example ). Press . The time will count down with "5:00" and "TIMER" will show in the display (Figure 6).
Note: If  is not pressed the timer will return to the time of day.
3. When the set time has run out, "End" and "TIMER" will show in the display (Figure 7). The clock will sound with 3 beeps every 5 seconds until  is pressed.

PRESS

DISPLAY



Figure 5



Figure 6

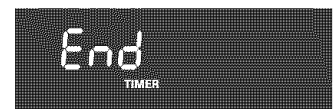





Figure 7

To cancel the Kitchen Timer before the set time has run out

Press . The display will return to the time of day.



To Set Add 1 Minute Feature

The **ADD 1 MINUTE**  pad is used to set additional minutes to the Kitchen Timer. Each time the  pad is pressed, another minute is added to the Kitchen Timer if the Kitchen Timer is already active. If the Kitchen Timer feature is not active and the  pad is pressed, the Kitchen Timer feature will become active and will begin counting down from 1 minute. For further information on how to set the Kitchen Timer feature see To Set the Kitchen Timer instructions above.

Setting Oven Controls (con't)

Setting Oven Lockout Feature

The  pad controls the Oven Lockout feature. The Oven Lockout feature automatically locks the oven door and prevents the Oven from being turned ON. It does not disable the clock, Kitchen Timer or the interior oven lights.

INSTRUCTIONS

To activate the Oven Lockout feature

1. Press and hold  for 3 seconds (Figure 1).
2. After 3 seconds "LOC" will appear, a beep will sound and "DOOR LOCKED" will flash in the display. Once the oven door is locked the "DOOR LOCKED" indicator will stop flashing and remain on along with the "LOC".

To reactivate normal oven operation:

1. Press and hold  for 3 seconds. A beep will sound. The "DOOR LOCKED" will flash in the display until the oven door has completely unlocked and "LOC" has cleared (figure 2).
2. The appliance is again fully operational.

PRESS



for 3 seconds

DISPLAY



Figure 1





for 3 seconds







Figure 2

Setting Silent Control Operation

The **DELAY START**  and **FLEX CLEAN**  pads control the Silent Control operation feature. The Silent Control operation feature allows the oven control to be operated without sounds or beeps whenever necessary. If desired the control can be programmed for silent operation and later returned to operating with all the normal sounds and beeps.

INSTRUCTIONS

To change control from normal sound operation to silent control operation

1. To tell if your range is set for normal or silent operation press and hold  for 7 seconds. "0:00" will appear and "DELAY" will flash in the display (Figure 3). After 7 seconds ":SP" will appear in the display (Figure 4).
2. Press  to switch between normal sound operation and silent operation mode. The display will show either ":SP" (Figure 4) or ":-" (Figure 5).
If ":SP" appears (Figure 4), the control will operate with normal sounds and beeps. If ":-" appears (Figure 5), the control is in the silent operation mode.
3. Press  to accept the change or press  to reject the change.

PRESS



for 7 seconds



DISPLAY



Figure 3



Figure 4

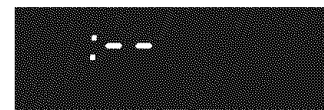



Figure 5





Setting Oven Controls (con't)

Setting Temperature Display — Fahrenheit or Celsius:

The **BROIL**  and **FLEX CLEAN**  pads control the Fahrenheit or Celsius temperature display modes. The oven control can be programmed to display temperatures in Fahrenheit or Celsius. The oven has been preset at the factory to display in Fahrenheit.

INSTRUCTIONS

To change display from Fahrenheit to Celsius or Celsius to Fahrenheit

1. To tell if the display is set for Fahrenheit or Celsius press  (Figure 1) and hold for 7 seconds; "550°" will appear and "BROIL" will flash in the display and a beep will sound. If "F" appears, the display is set to show temperatures in Fahrenheit (Figure 2). If "C" appears, the display is set to show temperatures in Celsius (Figure 3).
2. Press  to switch between Fahrenheit or Celsius display modes. The display will show either "F" (Figure 2) or "C" (Figure 3).
3. Press  to accept the change or press  to reject the change.

PRESS

for 7 seconds



 or 

DISPLAY



Figure 1



Figure 2



Figure 3





Setting Oven Controls (con't)

Setting Preheat

The **PREHEAT**  pad controls the Preheat feature. The Preheat feature will bring the oven up to temperature and then indicate when to place the food in the oven. Use this feature when recipes call for preheating. Preheating is not necessary when roasting or cooking casseroles. The oven can be programmed to preheat at any temperature between 170°F to 550°F.

INSTRUCTIONS

To set the Preheat temperature for 350°F







1. Arrange the interior oven racks.
2. Press . "--- °" and "BAKE" will appear in the display (Figure 1).
3. Press   . "350°" will appear in the display (Figure 2).
4. Press . "PRE" and "BAKE" will appear in the display as the oven heats and reaches 350°F (Figure 3).

Note: After the oven has reached the desired temperature (this example, 350°F) the control will beep and the "PRE" light will turn off and oven temperature will be displayed (Figure 4). If you missed hearing the beep, you can tell that the oven has reached preheat temperature if you see the oven temperature showing in the oven display. Once the oven has preheated, **place food in the oven**. The "BAKE" light will stay on.

Press  when baking is complete or to cancel the preheat feature.

To change Preheat temperature while oven is preheating (example: changing from 350°F to 425°F)

If it is necessary to change the preheat temperature while the oven is preheating to the original temperature:

1. While preheating, press . "--- °" and "BAKE" will appear in the display (Figure 5)
2. Enter the new preheat temperature. Press   . "425°" and "BAKE" will appear in the display (Figure 6).
3. Press . "PRE" and "BAKE" will appear in the display as the oven heats to 425°F (Figure 7). A beep will sound once the oven temperature reaches 425°F and the display will show "425°" and "BAKE" (Figure 8).
4. When baking is complete press .

PRESS



DISPLAY



Figure 1



Figure 2



Figure 3



Figure 4



Figure 5

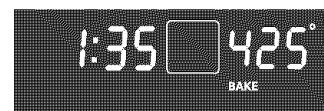

Figure 6



Figure 7

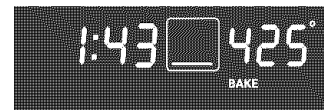



Figure 8

ENGLISH





Setting Oven Controls (con't)

Setting Bake

The **BAKE**  pad controls normal baking. If preheating is necessary, refer to the **PREHEAT**  Feature for instructions. The oven can be programmed to bake at any temperature from 170° F to 550° F (The sample shown below is for 350°F).





INSTRUCTIONS

To set the Bake Temperature to 350°F

1. Arrange interior oven racks and place food in oven.
2. Press , "- - - °" will appear and "BAKE" will flash in the display (Figure 1).
3. Press    (Figure 2). "BAKE" will continue to flash and "350°" will appear in the display.
4. Press . A beep will sound once the oven temperature reaches 350° F and the display will show "350°" and "BAKE" (Figure 3).

Pressing  will cancel the Bake feature at any time.

To change the Bake Temperature (example: changing from 350°F to 425°F)

1. After the oven has already been set to bake at 350°F and the oven temperature needs to be changed to 425°F, press  (Figure 4) and "- - - °" will appear and "BAKE" will flash in the display.
2. Press    (Figure 5). "BAKE" will continue to flash and "425°" will appear in the display.
3. Press . "BAKE" and "425°" will stay in the display (See Figure 6).

Note: If the oven was recently heated from prior cooking and has remaining heat, the bake element symbol may not show in the display immediately.

PRESS



DISPLAY



Figure 1



Figure 2



Figure 3



Figure 4



Figure 5

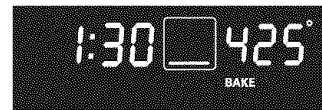



Figure 6

Setting Oven Controls (cont'd)

Oven Baking Information

For best results, preheat the oven before baking cookies, breads, cakes, pies or pastries, etc. There is no need to preheat the oven for roasting meat or baking casseroles.

The cooking times and temperatures needed to bake a product may vary slightly from your previously owned appliance. Refer to “Adjusting the Oven Temperature” section.

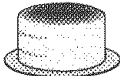
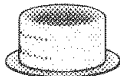
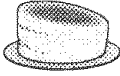
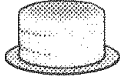
Baking problems and solutions		
Baking Problems	Causes	Corrections
<p>Cookies and biscuits burn on the bottom.</p> 	<ul style="list-style-type: none"> • Cookies and biscuits put into the oven before the preheating time is completed. • Oven rack overcrowded. • Dark pan absorbs heat too fast. 	<ul style="list-style-type: none"> • Allow oven to preheat to the selected temperature before placing food in oven. • Choose pan sizes that will permit 2" to 4" (5.1 cm to 10.2 cm) of air space on all sides when placed in the oven. • Use a medium-weight aluminum baking sheet.
<p>Cakes too dark on top or bottom.</p> 	<ul style="list-style-type: none"> • Cakes put into the oven before preheating time is completed. • Oven rack position too high or low. • Oven too hot. 	<ul style="list-style-type: none"> • Allow oven to preheat to the selected temperature before placing food in the oven. • Use proper rack position for baking needs. • Set oven temperature 25°F/12°C lower than recommended.
<p>Cakes not done in the center.</p> 	<ul style="list-style-type: none"> • Oven too hot. • Incorrect pan size. • Pan not centered in the oven. 	<ul style="list-style-type: none"> • Set oven temperature 25°F/12°C lower than recommended. • Use pan size suggested in recipe. • Use proper rack position and place pan so there is 2" to 4" (5.1 cm to 10.2 cm) of space on all sides of pan.
<p>Cakes not level.</p> 	<ul style="list-style-type: none"> • Range not level. • Pan too close to oven wall or rack overcrowded. • Pan warped. 	<ul style="list-style-type: none"> • Place marked glass measuring cup filled with water on the center of the oven rack. If water level is uneven, refer to the installation instructions for leveling the appliance. • Be sure to allow 2" to 4" (5.1 cm to 10.2 cm) of clearance on all sides of each pan in the oven. • Do not use pans that are dented or warped.
<p>Foods not done when cooking time is up.</p> 	<ul style="list-style-type: none"> • Oven too cool. • Oven overcrowded. • Oven door opened too frequently. 	<ul style="list-style-type: none"> • Set oven temperature 25°F/12°C higher than suggested and bake for the recommended time. • Be sure to remove all pans from the oven except the ones to be used for baking. • Open oven door only after shortest recommended baking time.

Setting Oven Controls (cont'd)

Setting Convection Bake

The **CONVECTION BAKE**  pad controls the Convection Bake feature.

Use the Convection Bake feature when cooking speed is desired. The oven can be programmed for Convection baking at any temperature between 300° F (149° C) to 550° F (288° C).

Convection baking uses a fan to circulate the oven's heat evenly and continuously within the oven (See Figure 1). This improved heat distribution allows for fast, even cooking and browning results. It also gives better baking results when using 2 or 3 racks at the same time. Breads and pastries brown more evenly. Convection bake cooks most foods faster, more evenly and at lower temperatures than conventional bake.

General Convection Bake Instructions

1. Time reduction will vary depending on the amount and type of food to be cooked. Cookies and biscuits should be baked on pans with no sides or very low sides to allow heated air to circulate around the food. Food baked on pans with dark finish will cook faster.
2. Preheating is not necessary when cooking casseroles with Convection Bake.
3. When using Convection Bake with a single rack, place oven rack in position 2 or 3. If cooking on multiple racks, place the oven racks in positions 2 and 4 or 2, 3 and 4.
4. Cakes have better results when baked using the Food Categories **CAKES** pad.

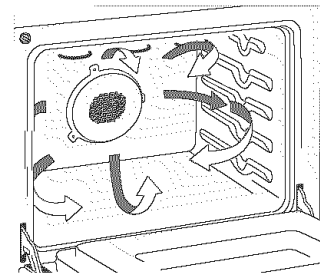

Air circulation during Convection Bake

Figure 1

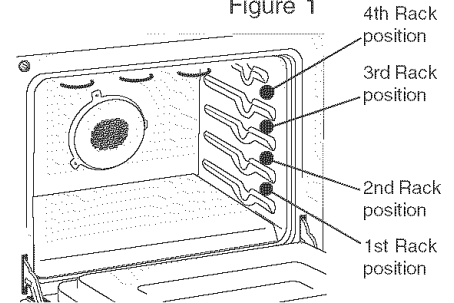







Figure 2

Benefits of Convection Bake:

- Some foods cook up to 30% faster, saving time and energy.
- Multiple rack baking.
- No special pans or bakeware needed.

INSTRUCTIONS

To set the oven for Convection Bake and temperature to 350°F

1. Arrange interior oven racks and place food in oven.
2. Press . "**CONV BAKE**" will flash and "---°" will appear in the display (Figure 3).
3. Press   . "**CONV BAKE**" will keep flashing and "**350°**" will appear in the display (Figure 4).
4. Press . "**CONV BAKE**" and the oven temperature adjustment will appear in the display (for this example it is 325°F). A beep will sound once the adjusted oven temperature is reached. The display will show "**325°**", "**CONV BAKE**" and the fan icon (Figure 5).

PRESS

DISPLAY



Figure 3



Figure 4



Figure 5



Note: The oven icon will show a rotating fan within the square. This rotating fan icon indicates when the Convection Fan is operating (See rotating fan in Figure 5).

Press  to stop Convection Bake or cancel Convection Bake at any time.



Note: As soon as the  pad is pressed the set temperature will be decreased by 25°F (13°C).

Setting Oven Controls (cont'd)





Setting Convection Convert Feature

The  pad is used to automatically convert a standard baking recipe for convection baking. When set properly, this feature is designed to display the actual converted (reduced) temperature in the display.

Convection Convert may ONLY be used with a Bake, Timed Bake, Delayed Start or Delayed Timed Bake setting. When used with a Timed Bake, a Delayed Timed Bake setting, the Convection Convert feature will display a "CF" for check food when the bake time is 75% complete (see Figure 4). At this time the oven control sound 3 beeps at regular intervals until baking has finished. When the bake time has completely finished the control will display "End" and will sound 3 beeps every 30 seconds until the  is pressed (see Figure 5).

INSTRUCTIONS

Using Convection Convert (Bake) feature to automatically adjust oven temperature (example: below when setting oven for 350°F (°C))

1. Arrange interior oven racks and place food in oven.
2. Press , "--- °" will appear in the display (Figure 1).
3. Press   . "BAKE" will flash and "350°" will appear in the display (Figure 2). If a Timed Bake or a Delayed Timed Bake is desired, enter times now.
4. Press . "CONV", "BAKE" and the oven temperature adjustment will appear in the display (for this example 325°F). A beep will sound once the adjusted oven temperature is reached. The display will show "325°", "CONV", "BAKE" and the fan icon (Figure 3).

Note: The oven icon will show a rotating fan within the square. This rotating fan icon indicates when the Convection Fan is operating (See rotating fan in Figure 3).

Press  to cancel Convection feature at any time.

Note: The minimum amount of cook time using the Convection Convert feature with a **Timed Bake** or a **Delay Timed Bake** is 20 minutes.

PRESS

DISPLAY



Figure 1

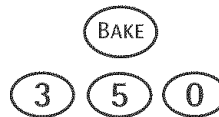

Figure 2

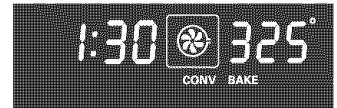

Figure 3



Figure 4



Figure 5

ENGLISH

Setting Oven Controls (cont'd)

Setting the Slow Cook Feature

The **SLOW COOK**  pad is used to activate this feature. The Slow Cook feature may be used to cook foods more slowly, at lower oven temperatures and provides cooking results much the same way as a Slow Cooker or Crock-Pot. The Slow Cook feature is ideal for roasting beef, pork & poultry. Slow Cooking meats may result in the exterior of meats becoming dark but not burnt. This is normal.





There are 2 settings available, high (**HI**) or low (**LO**). The high setting is best for cooking foods from a 4 to 5 hour time period. The low setting is best for cooking foods from a 8 to 9 hour time period. The maximum cook time for the Slow Cook feature is 12 hours unless the oven control has been changed to the Continuous Bake mode. This feature may be used with the additional settings of a **Timed Bake** or a **Delayed Start** (Delayed Timed Bake).

Some tips you should review for best possible results using Slow Cook feature:

- Completely thaw all frozen foods before cooking with the Slow Cook.
- When using a single rack, place in position 2 or 3.
- Position multiple racks to accommodate size of cooking utensils when cooking multiple food items.
- Do not open the oven door often or leave the door open when checking foods. If the oven heat escapes often, the Slow Cook time may need to be extended.
- Cover the foods to keep them moist or use a loose or vented type cover to allow foods to turn crisp or brown.
- Roasts may be left uncovered so browning can occur. Cook times will vary; depending on the weight, fat content, bone & the shape of the roast.
- Use the recipe's recommended food temperature and a food thermometer to determine when the food is done.
- Preheating the oven will not be necessary when using the Slow Cook feature.
- Add any cream or cheese sauces during the last hour of cooking.

INSTRUCTIONS

To Program the Oven to begin baking with the Slow Cook feature

1. Place the food in the oven.
2. Press . "SLO" and "HI" will appear in the display (Figure 1) (if no further keypads are touched within 25 seconds the request for Slow Cook will clear). The Slow Cook feature will be set to the high setting. This setting is best for cooking foods from a 4 to 5 hour time period.
3. If a low setting is desired, press  a 2nd time to set the Slow Cook feature with a low setting. "SLO" and "LO" will appear in the display (Figure 2). This setting is best for cooking foods from a 8 to 9 hour time period.
4. Press . The Slow Cook feature will activate (Figure 3).
5. If desired, add any **Timed Bake** or **Delayed Start** settings at this time.
6. To cancel the Slow Cook feature press  at anytime.

PRESS



DISPLAY



Figure 1

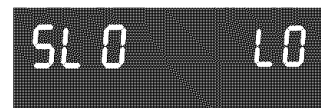

Figure 2



Figure 3

Setting Oven Controls (cont'd)

Setting Timed Bake, Timed Convection Bake or Timed Convection Roast

The **BAKE** (BAKE) or **CONVECTION BAKE** (CONV BAKE) and **OVEN COOK TIME** (OVEN COOK TIME) pads control the Timed Bake feature. The automatic timer of the Timed Bake feature will turn the oven OFF after cooking for the desired amount of time you select.

INSTRUCTIONS

PRESS

DISPLAY

To program the oven to begin baking immediately and to shut off automatically (example: **BAKE** at 350°F for 30 minutes)

1. Be sure the clock is set for the correct time of day.
2. Arrange interior oven rack(s) and place the food in the oven.
3. Press (BAKE), "-- °" will appear and "BAKE" will flash in the display (Figure 1).
4. Press (3) (5) (0) (Figure 2). "BAKE" will continue to flash and "350°" will appear in the display.
5. Press (START). "BAKE" and "350°" will appear in the display (See Figure 3).
6. Press (OVEN COOK TIME). "TIMED" will flash; "BAKE", "0:00" and "350°" will appear in the display (Figure 4).
7. Enter the desired baking time by pressing (3) (0). "TIMED" will continue to flash and "BAKE", "30:00" and "350°" will stay in the display (Figure 5). **Note:** Baking time can be set for any amount of time between 1 minute to 11 hours and 59 minutes.
8. Press (START). Both the "TIMED" and "BAKE" icons will remain on in the display (Figure 6). Once the Timed Bake feature has started, the current time of day will appear in the display.



Figure 1



Figure 2

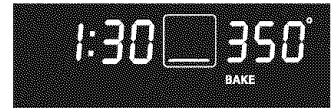

Figure 3

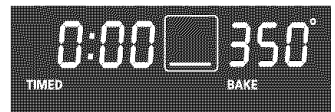

Figure 4

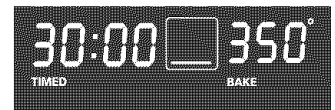

Figure 5



Figure 6

Note: After the Timed Bake feature has activated, press (OVEN COOK TIME) to display the bake time remaining in the Timed Bake mode. Once Timed Bake has started baking, a beep will sound when the oven temperature reaches the set temperature.

Press (STOP CLEAR) when baking has finished or at any time to cancel the Timed Bake feature.



When the timed bake finishes:

1. "End", "TIMED", "BAKE" and the time of day will show in display. The oven will shut off automatically (Figure 7).
2. The control will beep 3 times. The control will continue to beep 3 times every 30 seconds until (STOP CLEAR) is pressed.



Figure 7



Note: Remember that the lowest **BAKE** temperature is 170°F and that the lowest **CONVECTION BAKE** temperature you can set is 325°F (300°F will be the oven temperature adjusted).

CAUTION Use caution with the **TIMED BAKE** or **DELAY START** (Delayed Timed Bake) features. Use the automatic timer when cooking cured or frozen meats and most fruits and vegetables. Foods that can easily spoil such as milk, eggs, fish, meat or poultry, should be chilled in the refrigerator first. Even when chilled, they should not stand in the oven for more than 1 hour before cooking begins, and should be removed promptly when cooking is completed. Eating spoiled food can result in sickness from food poisoning.

ENGLISH

Setting Oven Controls (cont'd)

Setting Delayed Start Bake or Delayed Start Convection Bake











The **BAKE**  or **CONVECTION BAKE** , and **DELAY START**  pads control the Delayed Start feature. The automatic timer of the Delayed Start will turn the oven **on** at the time you select in advance. **Note:** If your clock is set for normal 12 hour display mode the Delayed Timed Bake or Delayed Timed Convection Bake cycle can never be set to start more than 12 hours in advance. To set for Delayed Timed Bake or Delayed Timed Convection Bake 12-24 hours in advance set the control for the 24 hour time of day display mode.

INSTRUCTIONS

PRESS

DISPLAY

To program the oven for a delayed **BAKE** start time and to shut off manually (example: baking at 350°F, starting at 5:30)

1. Be sure that the clock is set with the correct time of day.
2. Arrange interior oven rack(s) and place the food in the oven.
3. Press . "---°" will appear and "**BAKE**" will flash in the display (Figure 1).
4. Press    (Figure 2). "**BAKE**" will continue to flash and "**350°**" will appear in the display.
5. Press . "**BAKE**" and "**350°**" will stay in the display. (See Figure 3).
6. Press . "**DELAY**" will flash in the display. Enter the desired start time using the number pads    (Figure 4).
7. Press . When Delayed Time Bake starts, the set oven temperature will disappear, "**DELAY**", "**BAKE**" and the current time of day will appear in the display (Figure 5).
8. When the desired start time is reached, "**350°**" appears in display and "**DELAY**" disappears. Oven starts to bake at the previously selected temperature (Figure 6).

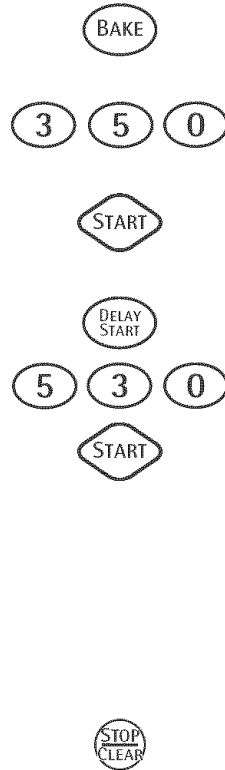

Figure 1



Figure 2

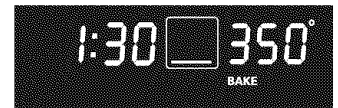

Figure 3

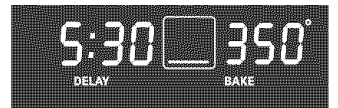

Figure 4



Figure 5

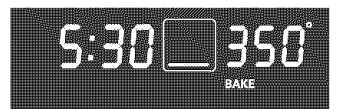



Figure 6

Note: Once the Delayed Bake has started baking, a beep will sound when the oven temperature reaches the set temperature.

Press  when baking has completed or at any time to cancel the Delayed Bake feature.

Setting Oven Controls (cont'd)

Setting Delayed Timed Bake or Delayed Timed Convection Bake

The **BAKE** (BAKE) or **CONVECTION BAKE** (CONV BAKE), **OVEN COOK TIME** (OVEN COOK TIME) and **DELAY START** (DELAY START) pads control the Delayed Time Bake feature. The automatic timer of the Delayed Time Bake will turn the oven **on and off** at the time you select in advance. **Note:** If your clock is set for normal 12 hour display mode the Delayed Timed Bake or Delayed Timed Convection Bake cycle can never be set to start more than 12 hours in advance. To set for Delayed Timed Bake or Delayed Timed Convection Bake 12-24 hours in advance set the control for the 24 hour time of day display mode.

INSTRUCTIONS

PRESS

DISPLAY

To program the oven for a delayed **BAKE** start time and to shut off automatically (example: baking at 350°F, starting at 5:30 and baking for 30 minutes)

1. Be sure that the clock is set with the correct time of day.
2. Arrange interior oven rack(s) and place the food in the oven.
3. Press (BAKE). "---°" will appear and "BAKE" will flash in the display (Figure 1).
4. Press (3) (5) (0) (Figure 2). "BAKE" will continue to flash and "350°" will appear in the display.
5. Press (START). "BAKE" and "350°" will stay in the display. (See Figure 3).
6. Press (OVEN COOK TIME). "TIMED" will flash, "0:00" will appear and "BAKE" and "350°" will remain in the display (Figure 4).
7. Enter the desired baking time using the number pads by pressing (3) (0). "TIMED" will flash; "BAKE", "30:00" and "350°" will appear in the display (Figure 5). **Note:** Baking time can be set for any amount of time from 1 minute to 11 hours and 59 minutes.
8. Press (START). "TIMED", "BAKE" and "350°" will remain in the display (Figure 6).
9. Press (DELAY START). "DELAY" will flash in the display. Enter the desired start time using the number pads (5) (3) (0) (Figure 7).
10. Press (START). When Delayed Time Bake starts, the set oven temperature will disappear, "DELAY", "BAKE" and the current time of day will appear in the display (Figure 8).
11. When the desired start time is reached, "350°" appears in display and "DELAY" disappears. Oven starts to bake at the previously selected temperature (Figure 9).

Note: Once Delayed Time Bake has started, press (OVEN COOK TIME) to display the bake time remaining. Once the Delayed Timed Bake has started baking, a beep will sound when the oven temperature reaches the set temperature.

Press (STOP CLEAR) when baking has completed or at any time to cancel the Delayed Time Bake feature.

When the set bake time runs out:

1. "End" will appear in the display and the oven will shut off automatically (Figure 10).
2. The control will beep 3 times. The control will continue to beep 3 times every 30 seconds until (STOP CLEAR) is pressed.



Figure 1



Figure 2

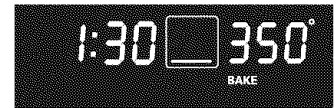

Figure 3

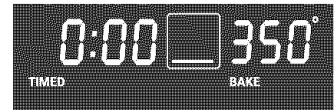

Figure 4

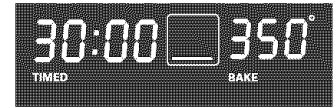

Figure 5

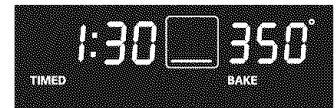

Figure 6



Figure 7



Figure 8

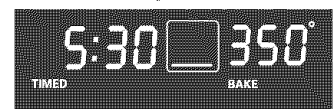

Figure 9



Figure 10

ENGLISH

Setting Oven Controls (cont'd)

Setting the Food Categories Feature:

The **MEATS** (MEATS), **CAKES** (CAKES) and **BREADS** (BREADS) pads in the Food Categories feature are used when cooking certain food items. These pads have been designed to give optimum cook performance for the foods selected in each category.

The **MEATS** pad combines a cook cycle with the convection fan and element to roast meats and poultry. Preheating is not necessary for meats and poultry. Heated air circulates around the food from all sides, sealing in juices and flavors. Foods are crispy brown on the outside while staying moist on the inside.

The **CAKES** pad provides a preheat with a gentle cycling of heat giving cakes more volume and allowing delicate foods to cook more evenly.

The **BREADS** pad adds a preheat feature to the bake cycle to thoroughly heat the oven from top to bottom to give more evenly browned foods. Refer to (Figure 4) for foods to cook in each category.

INSTRUCTIONS

To set the Food Categories feature (example for Meats to cook at 350°F):

1. Arrange interior oven racks and place food in oven.
2. Press (MEATS). "MEATS" will flash and "---°" will be displayed (See Figure 1).
3. Press (3) (5) (0). "MEATS" will flash and "350°" will appear in the display (See Figure 2).
4. Press (START). "MEATS" and "350°" will appear in the display (See Figure 3). The convection fan icon will come on.

Press (STOP CLEAR) to stop cooking Meats, Cakes or Breads, or to cancel cooking Meats, Cakes or Breads at any time.

PRESS

(MEATS)

(3) (5) (0)

(START)

(STOP CLEAR)

DISPLAY



Figure 1



Figure 2



Figure 3

Recommended foods to be cooked in each category

Figure 4

Meats	Cakes	Breads
Meat Poultry	Cakes Brownies Pies (fresh & frozen) Baked Custards Cheesecake	Breads Rolls Biscuits Muffins Combread

Roasting Instructions for Meat Pad:

When using the Meat pad for roasting, use the broiler pan and insert along with the roasting rack. The broiler pan will catch grease spills and the insert will help prevent grease spatters. The roasting rack will allow the heat to circulate around the meat.

CAUTION To prevent food from contacting the broil element and to prevent grease spattering, **DO NOT** use the roasting rack when broiling.

1. Place oven rack on bottom or next to the bottom rack position. See **Arranging Oven Racks** in this Use & Care Guide.
2. Place the insert in the broiler pan. The roasting rack fits on the insert allowing the heated air to circulate under the food for even cooking and helps to increase browning on the underside. Make sure the roasting rack is securely seated on the insert in the broiler pan. **DO NOT** use the broiler pan without the insert. **DO NOT** cover the insert with aluminum foil.
3. Position food (fat side up) on the roasting rack (See Figure 5).
4. Place the broiler pan on the oven rack.

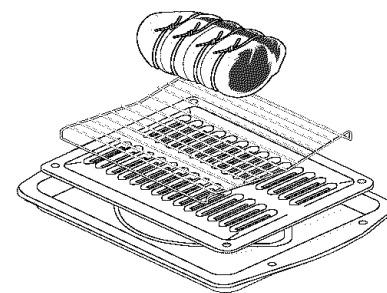

Figure 5

Setting Oven Controls (cont'd)

Setting the Warm & Hold™ Feature

The **Warm & Hold**  pad turns ON the Warm & Hold feature and will maintain an oven temperature of 170°F (77°C).

The Warm & Hold feature will keep oven baked foods warm for serving up to 3 hours after cooking has finished. After 3 hours the Warm & Hold feature will shut the oven OFF. The Warm & Hold feature may be used without any other cooking operations or can be used after cooking has finished using BAKE, CONVECTION BAKE .

The Warm & Hold feature may be used with TIMED BAKE if you wish to have the Warm & Hold feature turned ON automatically when cooking has finished. The Timed Bake features require you to set start time and the amount of cooking time. With this information the control can calculate the time when cooking will complete and can then start the Warm & Hold feature automatically.

INSTRUCTIONS

PRESS

DISPLAY

To set Warm & Hold





1. Arrange interior oven racks and place food in oven.
2. Press . "HLd" will appear in the display (Figure 1).
Note: If no pad is touched within 25 seconds the request to turn ON Warm & Hold feature will be cancelled.
3. Press . The oven icon will appear in the display (Figure 2).
4. To turn the Warm & Hold OFF at any time press  or .
Note: The Warm & Hold feature will automatically turn OFF after 3 hours.



Figure 1



Figure 2

To set Warm & Hold to turn ON automatically



1. Arrange interior oven racks and place food in oven. Set the oven properly for **Timed Bake or Delayed Timed Bake**.
2. Press . (Figure 3)
Note: If no pad is touched within 25 seconds the request to turn ON Warm & Hold feature all functions previously programmed will be cleared.
3. Press . "HLd" will disappear and the temperature will be displayed (Figure 4). The Warm & Hold mode is set to turn ON automatically after Timed Bake has finished (See Figure 1).
4. To turn the Warm & Hold feature OFF at any time press  again.
Note: The Warm & Hold feature will automatically turn OFF after 3 hours.



Figure 3



Figure 4

Pressing  at any time will stop all oven baking operations.



Setting Oven Controls (cont'd)

Setting Broil

The **BROIL** pad controls the Broil feature. When broiling, heat radiates downward from the oven broiler for even coverage.

The Broil feature is preset to start broiling at 550°F; however, the Broil feature temperature may be set between 400°F and 550°F. For optimum browning results when broiling, preheat the broil element for 3 to 4 minutes. This appliance includes a Searing Grill for searing meats (Figure 6). The broil pan and broil pan insert used together allow dripping grease to drain and be kept away from the high heat of the oven broiler. **DO NOT** use the broil pan without the insert. Always place insert on the broiler pan with ribs and slots down to allow grease to drip into pan (See Figure 5). **DO NOT cover the broil pan insert with foil.** The exposed grease could catch fire.

⚠ WARNING Should an oven fire occur, leave the oven door closed and turn off the oven. If the fire continues, throw baking soda on the fire or use a fire extinguisher. **DO NOT** put water or flour on the fire. Flour may be explosive and water can cause a grease fire to spread and cause personal injury.

INSTRUCTIONS

To set the oven to broil at the default setting (550°F)

1. Place the broiler pan insert on the broiler pan. Then place the food on the broiler pan insert. **DO NOT** use the broiler pan without the insert. **DO NOT** cover the broiler insert with foil. The exposed grease could ignite.
2. Arrange the interior oven rack and place the broiler pan on the rack. Be sure to center the broiler pan directly under the broiler element. **Make sure the oven door is in the broil stop position (See Figure 4).**
3. Press **BROIL**. "BROIL" will flash and "550°" will appear (Figure 1).
4. If a lower broil temperature is desired (minimum broil temperature setting is 400°F), press the desired temperature before continuing to step 5.
5. Press **START**. The oven will begin to broil. "BROIL" and "550°" will appear in the display (Figure 2).
6. Broil on one side until food is browned; turn and cook on the second side. Season and serve. **Note:** Always pull the rack out to the stop position before turning or removing food.
7. To cancel broiling or if finished broiling press **STOP CLEAR** (Figure 3).

PRESS



DISPLAY



Figure 1

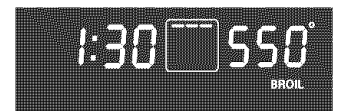
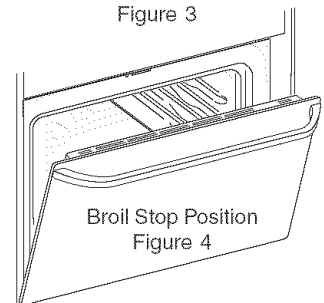

Figure 2



Figure 3



Broil Stop Position
Figure 4

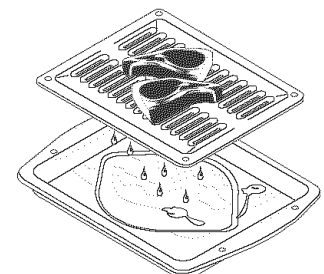

Figure 5

Broiling Times and Searing Grill

Use the following table for approximate broiling times. Increase or decrease broiling times, or move the broiling pan to a different rack position to suit for doneness. If the food you are broiling is not listed in the table, follow the instructions provided in your cookbook and watch the item closely. Use the Searing Grill for meats and steaks if desired. Before placing the meat, be sure to heat the Searing Grill using Broil for 10 minutes. Cook times should be reduced 1-2 minutes per side when cooking with the Searing Grill. Place Searing Grill on top of Broiler Pan and insert for meats and steaks (See Figure 6).

Electric Range Broiling Table Recommendations

Food Item	Rack Position	Temp Setting	Cook Time		Doneness
			1st side	2nd side	
Steak 1" thick	3rd	550° F	6:00	4:00	Rare
	3rd	550° F	7:00	5:00	Medium
Pork Chops 3/4" thick	3rd	550° F	8:00	6:00	Well
Chicken - Bone In	2nd	450° F	20:00	10:00	Well
Chicken - Boneless	3rd	450° F	8:00	6:00	Well
Fish	3rd	500° F	13:00	n/a	Well
Shrimp	2nd	550° F	5:00	n/a	Well
Hamburger 1" thick	3rd	550° F	9:00	7:00	Medium
	2nd	550° F	10:00	8:00	Well

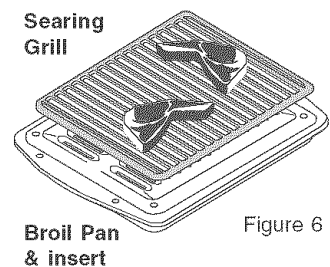







Figure 6



Setting Oven Controls (cont'd)

To Set the Sabbath Feature (for use on the Jewish Sabbath & Holidays)

The  **COOK TIME** and  **DELAY START** pads are used to set the Sabbath feature. The Sabbath feature may only be used with the  pad. The oven temperature may be set higher or lower after setting the Sabbath feature (the oven temperature adjustment feature should be used only during Jewish Holidays), however the display will not visibly show or provide any audible tones indicating whether the change occurred correctly. Once the oven is properly set using Bake with the Sabbath feature active, the oven will remain continuously ON until cancelled. This will override the factory preset 12-Hour Energy Saving feature.

If the oven light will be needed during the Sabbath, press  before activating the Sabbath feature. Once the oven light is turned ON and the Sabbath feature is active, the oven light will remain ON until the Sabbath feature is turned OFF. If the oven light needs to be OFF, be sure to turn the oven light OFF before activating the Sabbath feature.

IMPORTANT NOTES: It is not advised to attempt to activate any other program feature other than **BAKE** while the Sabbath feature is active. ONLY the following key pads will function after setting the Sabbath feature;  to ,







,  & . ALL OTHER KEYPADS will not function once the Sabbath feature is properly activated.

INSTRUCTIONS

PRESS

DISPLAY

To Program the Oven to Begin Baking Immediately & Activate the Sabbath Feature (example: baking at 350°F)

1. Be sure that the clock is set with the correct time of day.
2. Place the food in the oven.
3. Press . " — — — ° " appears in the display.
4. Within 5 seconds, press , , . The display will show "350°F (177°C)."
5. Press  (Figure 1).
6. If you desire to set the oven control for a **Timed Bake** or **Delayed Start Bake** do so at this time. If not, skip this step and continue to step 7. Refer to the **Timed Bake** (complete steps 6-8) / **Delayed Start Bake** (complete steps 6-10) section for complete instructions. Remember the oven will shut down after using **Timed Bake** or **Delay Start Bake** and therefore may only be used once during the Sabbath/Jewish Holidays. The maximum **Delayed Start Bake** time is 11 hours & 59 minutes.
7. The oven will turn ON and begin heating.
8. Press and hold both the  and  pads for at least 3 seconds. **SAb** will appear in the display (figure 2). Once **SAb** appears in the display the oven control will no longer beep or display any further changes and the oven is properly set for the Sabbath feature.

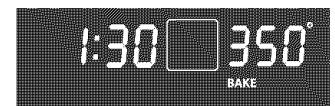
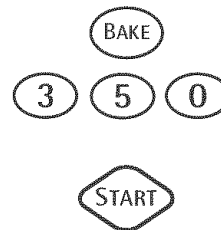

Figure 1

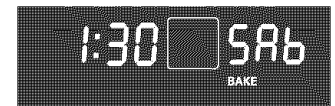







Figure 2

Note: You may change the oven temperature once baking has started by pressing , the numeric key pads for the temperature you want (example for 425°C press , , ) and then pressing  TWICE (for Jewish Holidays only). Remember that **the oven control will no longer beep or display any further changes** once the oven is set for the Sabbath feature.





9. The oven may be turned OFF at any time by first pressing  pad (this will turn the oven OFF only). To turn OFF the Sabbath feature press and hold both the  and  pads for at least 3 seconds. **SAb** will disappear from the display (Figure 3).



Figure 3

Setting Oven Controls (cont'd)

To Set the Sabbath Feature (for use on the Jewish Sabbath & Holidays) (continued)

Should you experience a power failure or interruption, the oven will shut off. When power is returned the oven will not turn back on automatically. The oven will remember that it is set for the Sabbath and the food may be safely removed from the oven while still in the Sabbath feature, however the oven cannot be turned back on until after the Sabbath. After the Sabbath observance turn OFF the Sabbath feature. Press and hold both the  and  pads for at least 3 seconds. **SAb** will disappear from the display and the oven may be used with all normal functions. For further assistance, guidelines for proper usage, and a complete list of models with the Sabbath feature, please visit the web at <http://www.star-k.org>.

To Set the Recipe Recall Feature

This feature will ONLY recall a recipe for **Bake, Convection Bake, Convection Roast, Meats, Cakes, Breads, Slow Cook or Timed Bake**. This feature will not work with any other function including a **Delayed Timed Bake, a Clean Cycle or a Broil** setting. You can only set one recipe for recall. For a different recipe you have to reprogram the oven.

INSTRUCTIONS

PRESS

DISPLAY

To Program the Oven to Begin Baking Immediately and record a Recipe (example: recording Bake at 350°F for 30 minutes)









- Place the food in the oven.
- Press . " — — — ° " appears and "BAKE" will flash in the display (Figure 1).
- Within 5 seconds, press , , . The display will show "350°F (177°C)" (Figure 2).
- Press . The oven icon will appear in the display (See Figure 3).
- Press . "TIMED" will flash; "0:00" will appear in the display (Figure 4).
- Enter the time by pressing , . "TIMED" will continue to flash and "BAKE", "30:00" and "350°" will stay in the display (Figure 5).
- Press and hold  pad for at least 3 seconds or until a beep sounds. The beep indicates that this recipe has been recorded for future recall. Now each time you press the Bake pad, this recipe will be recalled. **Note:** It is not possible to erase the recipe, but you can overwrite it with another temperature and time.





Figure 1

, , 



Figure 2



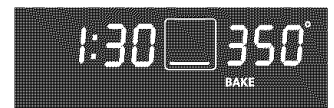

Figure 3



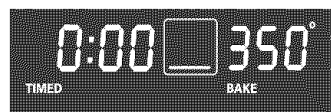

Figure 4

, 





Figure 5





Figure 6

To begin Baking with the stored Recipe

- Place the food in the oven.
- Press . "TIMED", "350°" will appear and "BAKE" will flash in the display (Figure 6).
- Press . "BAKE" will stop flashing and remain on, and the oven icon will appear in the display (Figure 7). The oven will immediately begin to cook with the stored recipe (in this example 350°F for 30 minutes).



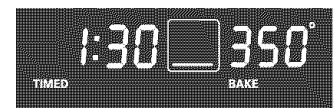

Figure 7



Setting Warmer Drawer Controls

Arranging Warmer (Warm & Ready™) Drawer Rack Positions

The rack can be used in 2 ways:

- In the **upright position** to allow low profile food items to be placed both under and on top of the rack (for example, rolls or biscuits on top of the rack and a casserole dish underneath).
- In the **downward position** to allow you to place light weight food items and empty dishware (for example, rolls or pastries and dinner plates) on the rack.

Set the Warmer Drawer Rack in either position as shown below (Figure 1).

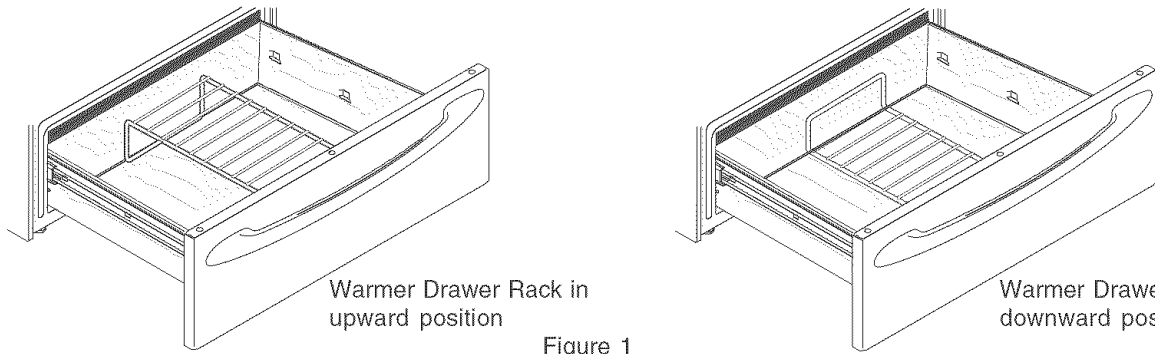

CAUTION Always use potholders or oven mitts when removing food from the Warmer Drawer as cookware and plates will be hot and you can be burned.

Operating the Warmer Drawer

The purpose of the Warmer Drawer is to keep hot cooked foods at serving temperature. Always start with hot food. It is not recommended to heat cold food in the Warmer Drawer. All food placed in the Warmer Drawer should be covered with a lid or aluminum foil to maintain quality.

Do not use plastic wrap to cover food. Plastic may melt onto the drawer and be very difficult to clean. Use only utensils and cookware recommended for oven use in the Warmer Drawer.

Warmer Drawer Food Temperature Settings

Use the recommended settings in the Warmer Drawer settings table. If a particular food is not listed, start with the **MED** setting. If more crispness is desired, remove the lid or aluminum foil from the food. Most foods can be kept at serving temperatures on the **MED** setting. When a combination of foods are to be kept warm (for instance, meat with 2 vegetables and rolls), use the **HI** setting. To avoid heat loss, do not open the Warmer Drawer repeatedly while in use.

Warmer (Warm & Ready™) Drawer & Bread Proofing Indicator Lights

The control and indicator lights for the Warmer Drawer and Bread Proofing features are located on the control panel. The indicator lights will turn ON when the control is set, and remain ON until the controls are turned OFF.







Note: The Warmer Drawer will **NOT** operate while in Self-Clean and “Oven Lockout” modes.

Warmer Drawer Settings Table	
Food Item	Setting
Bacon	HI
Hamburger Patties	HI
Poultry	HI
Pork Chops	HI
Fried Foods	HI
Pizza	HI
Gravies	MED
Casseroles	MED
Eggs	MED
Roasts (Beef, Pork, Lamb)	MED
Vegetables	MED
Biscuits	MED
Rolls, hard	MED
Pastries	MED
Rolls (soft)	LO
Empty Dinner Plates	LO

Figure 2

Setting Warmer Drawer Controls (cont'd)

To Set the Warmer Drawer & Bread Proofing Controls:

1. Touch the **ON/OFF** pad at the Warmer Drawer control position. The Warmer Drawer indicator light will flash. **Note:** If no further pads are touched within 25 seconds the request to power the Warmer Drawer ON will clear.
2. Set the desired power level. Touch  once to turn ON the power level for HI (see Figure 2) or  to turn ON the power level for LO (see Figure 4). The Warmer Drawer indicator light located above the ON/OFF pad will turn ON steady.
3. Each touch of the  or  pads will decrease or increase through 6 power levels from **HI** (see Figure 2) to **MED** (see Figure 3) to **LO** (see Figure 4) and to the **Proof bread** feature (see Figure 5). If the Warmer Drawer is set at the **LO** setting and the  pad is touch again the **Proof bread** feature and indicator light will be set (see Figure 5 and bread dough preparation instructions on this page). To return to standard Warmer Drawer setting touch  pad at least once.
4. When the food is ready for removal, touch the **ON/OFF** pad once to turn the Warmer Drawer or Proof bread feature OFF. The Warmer Drawer indicator light will turn OFF.

Note: For best results, preheat the Warmer Drawer before adding the food or bread dough. An empty drawer will preheat in approximately 15 minutes.

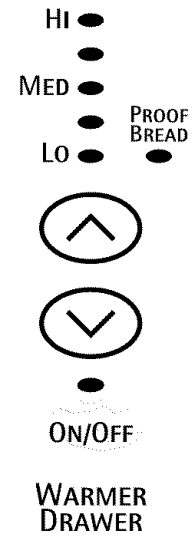

Figure 1

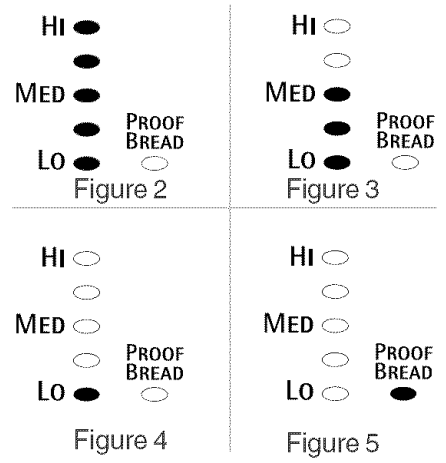

Figure 2

Figure 3

Figure 4

Figure 5

Preparing Bread Dough for the Warmer Drawer

The Warmer Drawer has a “Proof Bread” feature that can be used to help prepare bread dough. The recommended length of time to keep bread dough in the Warmer Drawer is about 45-60 minutes. Be sure however to follow the recipe’s recommended times.

The prepared bread dough should be placed in a large bowl since the dough will nearly double in volume. Arrange the Warmer Drawer Rack in the downward position (see Figure 6). Place the bowl on the rack in the Warmer Drawer and follow the Warmer Drawer and Proof bread Control setting instructions at the top of this page.

Note: For best results, do not operate the main oven while using the Proof Bread feature.

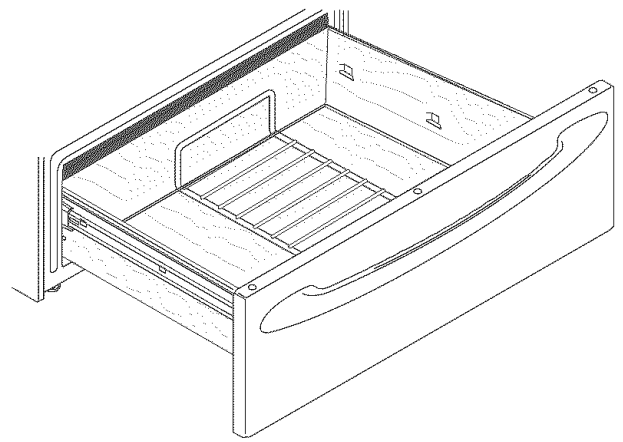

Figure 6

Self-Cleaning

CAUTION During the Self-Cleaning cycle, the outside of the range can become very hot to the touch. **DO NOT** leave small children unattended near the appliance.

CAUTION The health of some birds is extremely sensitive to the fumes given off during the Self-Cleaning cycle of any range. Move birds to another well-ventilated room.

CAUTION DO NOT line the oven walls, racks, bottom or any other part of the range with **aluminum foil**. Doing so will destroy heat distribution, produce poor baking results and cause permanent damage to the oven interior (aluminum foil will melt to the interior surface of the oven).

CAUTION DO NOT force the oven door open. This can damage the automatic door locking system. Use caution when opening the door after the Self-Cleaning cycle is completed. The oven may still be **VERY HOT**.

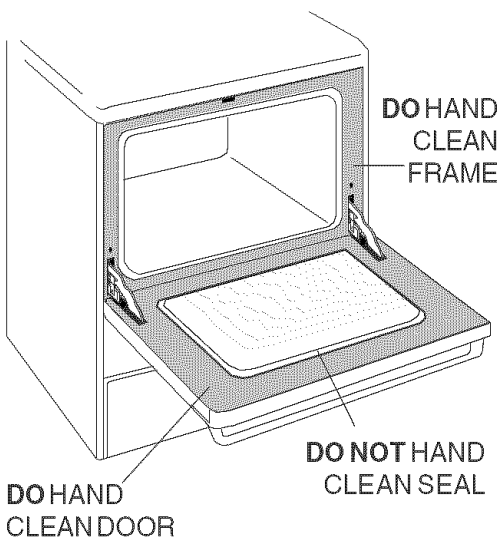

Note: See additional cleaning information for the oven door in the **General Care & Cleaning** section.

Note: A smoke eliminator in the oven vent converts most of the smoke into a colorless vapor.

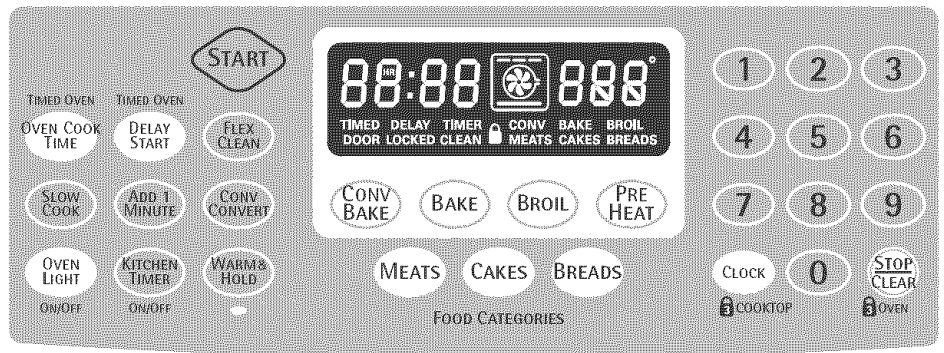

Self-Cleaning Oven

A Self-Cleaning oven cleans itself with high temperatures (well above cooking temperatures) which eliminate soils completely or reduces them to a fine powdered ash you can wipe away with a damp cloth.

Adhere to the following cleaning precautions:

- **DO NOT** use oven cleaners or oven protective coatings in or around any part of the Self-Cleaning oven.
- **DO NOT** clean the oven door gasket. The woven material of the oven door gasket is essential for a good seal. Care should be taken not to rub, damage or remove the gasket.
- **DO NOT** use any cleaning materials on the oven door gasket. Doing so could cause damage.
- **Remove the broiler pan and insert, all utensils and any aluminum foil. These items cannot withstand high cleaning temperatures.**
- Porcelain oven racks do not have to be removed. After the cycle is complete and the oven has cooled, rub the sides of the oven racks with wax paper or a cloth containing a small amount of salad oil (this will make the racks glide easier into the rack position).
- **Remove any excessive spillovers** in the oven cavity **before** starting the Self-Cleaning cycle. To clean, use hot, soapy water and a cloth. Large spillovers can cause heavy smoke or fire when subjected to high temperatures. **DO NOT** allow food spills with a high sugar or acid content (such as milk, tomatoes, sauerkraut, fruit juices or pie filling) to remain on the surface as they may leave a dull spot even after cleaning.
- Clean any soil from the oven frame, the door liner outside the oven door gasket and the small area at the front center of the oven bottom. These areas heat sufficiently to burn soil on. Clean with soap and water.

NOTE: Prior to setting the Self-Clean cycle, any spills remaining on the oven bottom should be removed.

What to Expect during Cleaning





While the oven is in operation, the oven heats to temperatures much higher than those used in normal cooking. Sounds of metal expansion and contraction are normal. Odor is also normal as the food soil is being removed. Smoke may appear through the oven vent.

If heavy spillovers are not wiped up before cleaning, they may flame and cause more smoke and odor than usual. This is normal and safe and should not cause alarm. If available, use an exhaust fan during the self-cleaning cycle.

CAUTION To avoid possible burns use care when opening the oven door after the Self-Cleaning cycle. Stand to the side of the oven when opening the door to allow hot air or steam to escape.

Self-Cleaning (cont'd)

Self-Clean Cycle Time Length

The **FLEX CLEAN**  pad is used to start a Self-Cleaning cycle. When used with the **DELAY START**  pad, a delayed Self-Cleaning cycle may also be programmed. The **FLEX CLEAN** feature allows for any Self-Cleaning cycle time from 2 (2:00) to 4 hours (4:00) to be selected. You may also choose the clean time in 1 minute increments (for example 2 hours and 50 minutes) by pressing the number keypads   .

CAUTION During the Self-Cleaning cycle, the outside of the range can become very hot to the touch. **DO NOT** leave small children unattended near the appliance.

CAUTION **DO NOT** force the oven door open. This can damage the automatic door locking system. Use care when opening the oven door after the Self-Cleaning cycle. Stand to the side of the oven when opening the door to allow hot air or steam to escape. The oven may still be **VERY HOT**.

INSTRUCTIONS

PRESS

DISPLAY

To set an immediate Self-Cleaning Cycle or to set a delay start time of 9:00 o'clock (example: default 3 hour Self-Clean cycle):









1. Be sure the clock is set with the correct time of day, the oven is empty and the oven door is closed.
2. Press . "**CLEAN**" will flash and "**3:00 HR**" will show in the display (Figure 1). 2-4 hours of Self-Cleaning time may be chosen by pressing any amount of time from    (2 hours) through    (4 hours) in one minute increments. You may also skip the time entry and accept the default cleaning time of 3 hours by pressing the Start key pad (See Step 3).
3. Press . "**DOOR**", "**LOCKED**" will flash; "**CLEAN**" and the letters "**CLn**" will remain on in the display (Figure 2).
4. As soon as the control is set, the motor driven oven door lock will begin to close automatically. Once the door has been locked the "**DOOR**", "**LOCKED**" indicator light will quit flashing and remain on.



Figure 1







Figure 2



Note: Allow about 15 seconds for the oven door lock to close.

Note: If the optional delay Self-Clean feature is needed, finish steps 5-7. If Self-Clean is started immediately skip the remaining steps and continue with "When the self-clean cycle is completed" on the following page.

5. Press  (see Figure 3). Enter the desired Self-Clean starting time using the number pads    (See figure 4).
6. Press . "**DELAY**", "**DOOR**", "**LOCKED**", "**CLEAN**" will remain on and the display returns to the time of day.
7. Based on the time amount you selected in step 2, the control will calculate forward from the set start time to determine when the Self-Cleaning cycle should end. The Self-Cleaning cycle will turn on automatically at the set time. At that time the icon "**DELAY**" will go out; the oven icon will come on, "**CLEAN**" and "**CLn**" will remain in the display (see Figure 5).

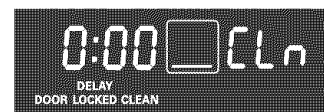
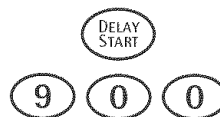

Figure 3



Figure 4

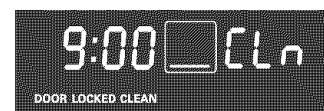

Figure 5

When the Self-Clean Cycle is Completed

1. The time of day, the "**DOOR**", "**LOCKED**" and "**CLEAN**" icon will remain in the display.
2. Once the oven has cooled down for approximately 1 HOUR, and the "**DOOR**", "**LOCKED**" icon is no longer displayed, the oven door can then be opened.

Self-Cleaning (cont'd)

INSTRUCTIONS

Stopping or Interrupting a Self-Cleaning Cycle

If it becomes necessary to stop or interrupt a self-cleaning cycle due to excessive smoke or fire in the oven:

1. Press .
2. Once the oven has cooled down for approximately 1 HOUR and the "DOOR", "LOCKED" icon is no longer displayed, the oven door can be opened (Figure 1).

PRESS



DISPLAY



Figure 1

IMPORTANT NOTES when using the Self-Clean feature:

1. The Self-Clean feature will not operate whenever a radiant element remains ON.
2. A Self-Clean cycle may be started if the appliance has the **Cooktop Lockout** active. A Self-Clean cycle cannot be started if **Oven Lockout** feature is active.
3. If a Self-Clean cycle has started but not finished and a power failure occurs, the appliance may not have thoroughly cleaned. Once power is restored, set for another Self-Clean cycle to finish.
4. If your clock is set for normal 12 hour display mode the Delay Self-Clean cycle can never be set to start more than 12 hours in advance. To set for Delay Self-Clean 12-24 hours in advance see instructions to set the control for the **24 hour time of day** display mode.





Adjusting Oven Temperature

The temperature in the oven has been preset at the factory. When first using the oven, be sure to follow recipe times and temperatures. If you think the oven is cooking too hot or too cool for the temperature you select, you can adjust the actual oven temperature to be more or less than what is displayed. Before adjusting, test a recipe by using a temperature setting that is higher or lower than the recommended temperature. The baking results should help you to decide how much of an adjustment is needed.

Note: The oven temperature adjustments made with this feature will not change the Self-Clean cycle temperature.

INSTRUCTIONS

To adjust the oven temperature higher

1. Press  for 6 seconds (Figure 2).
2. To increase the temperature use the number pads to enter the desired change. (Example 30°F)   (Figure 3). The temperature may be increased as much as 35°F (19°C).
3. Press  to accept the temperature change and the display will return to the time of day (Figure 4). Press  to reject the change if necessary.

PRESS



DISPLAY



Figure 2



Figure 3



Figure 4

To adjust the oven temperature lower







1. Press  for 6 seconds. 0° will appear in the display (Figure 2).
2. To decrease the temperature use the number pads to enter the desired change. (Example -30°F)   and then press  (Figure 5). The temperature may be decreased as much as 35°F (19°C).
3. Press  to accept the temperature change and the display will return to the time of day (Figure 4). Press  to reject the change if necessary.

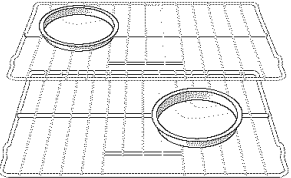
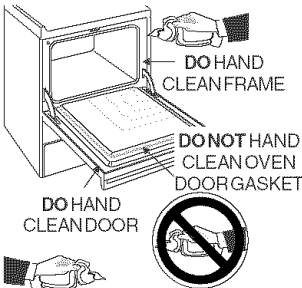

Figure 5

General Care & Cleaning

Cleaning Various Parts of Your Range

Before cleaning any part of the range, be sure all controls are turned OFF and the range is cool. Remove spillovers and heavy soiling as soon as possible. Regular cleanings now will reduce the extent and difficulty of major cleaning later.

Surfaces	How to Clean
Aluminum & Vinyl Control Panel and Trim Pieces	<p>Use hot, soapy water and a cloth. Dry with a clean cloth.</p> <p>Before cleaning the control panel, turn all controls to OFF and remove the control knobs. To remove, pull each knob straight off the shaft. Clean using hot, soapy water and a dishcloth. Rinse with a clean water and a dishcloth. Be sure to squeeze excess water from the cloth before wiping the panel; especially when wiping around the controls. Excess water in or around the controls may cause damage to the appliance. Be sure to rinse the cleaners as bluish stains may occur during heating and cannot be removed. To replace knobs after cleaning, line up the flat sides of both the knob and the shaft; then push the knob into place.</p>
Glass, Painted and Plastic Body Parts, Control Knobs and Decorative Trim Pieces	<p>Using a soft cloth, clean with mild dish detergent and water or a 50/50 solution of vinegar and water. Follow by rinsing the area with clean water; dry and polish with a soft cloth. Glass cleaners may be used if sprayed on a soft cloth first. DO NOT spray liquids directly on the control pad and display area. Do not use large amounts of water on the control panel - excess water on the control area may cause damage to the appliance. Do not use other liquid cleaners, abrasive cleaners, scouring pads, or paper towels - they will damage the finish. To remove control knobs, turn to the OFF position; grasp firmly and pull straight off the shaft. To replace knobs after cleaning, line up the flat sides of both the knob and the shaft; then push the knob into place.</p>
Stainless Steel (some models) Oven door & drawer front panel	<p>Clean with hot, soapy water and dishcloth. Rinse with clean water and cloth. Do not use cleaners with high concentrations of chlorides or chlorines. Do not use harsh scrubbing cleaners. Only use kitchen cleaners that are especially made for cleaning stainless steel. Always be sure to rinse the cleaners off from the surface as bluish stains may occur during heating that cannot be removed.</p>
Oven Racks 	<p>This oven comes with lubricated porcelain oven racks, which can remain in the oven during the self-clean cycle. Do not clean this vegetable oil lubrication off the racks. It is important that the sides of the oven racks always have a light coating of vegetable oil. To maintain optimal rack performance, re-apply a thin layer of vegetable oil to the sides of the rack after every self-clean cycle or when the rack becomes difficult to slide.</p>
Porcelain Enamel Broiler Pan and Insert, Door Liner, Body Parts and Warmer Drawer and Drawer Cavity.	<p>Gentle scouring with a soapy scouring pad will remove most spots. Rinse with a 1:1 solution of clear water and ammonia. If necessary, cover difficult spots with an ammonia-soaked paper towel for 30 to 40 minutes. Rinse with clean water and a damp cloth, and then scrub with a soap-filled scouring pad. Rinse and wipe dry with a clean cloth. Remove all cleaners or the porcelain may become damaged during future heating. DO NOT use spray oven cleaners on the cooktop.</p>
Oven Door 	<p>Use soap & water to thoroughly clean the top, sides and front of the oven door. Rinse well. You may use a glass cleaner on the outside glass of the oven door. DO NOT immerse the door in water. DO NOT spray or allow water or the glass cleaner to enter the door vents. DO NOT use oven cleaners, cleaning powders or any harsh abrasive cleaning materials on the outside of the oven door.</p> <p>DO NOT clean the oven door gasket. The oven door gasket is made of a woven material, on Self-Cleaning models, which is essential for a good seal. Care should be taken not to rub, damage or remove this gasket.</p>

General Care & Cleaning (cont'd)

Ceramic Glass Cooktop Cleaning & Maintenance

Consistent and proper cleaning is essential to maintaining your Ceramic glass cooktop

Prior to using your cooktop for the first time, apply the recommended CookTop® Cleaning Creme to the ceramic surface (on the web visit www.sears.com for replacement cooktop cleaner, item number 40079). Buff with a **non-abrasive** cloth or **no-scratch** cleaning pad. This will make cleaning easier when soiled from cooking. The special cooktop cleaning cream leaves a protective finish on the glass to help prevent scratches and abrasions.

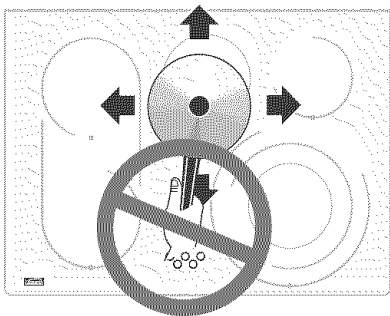

Sliding aluminum or copper clad bottom pans on the cooktop can cause metal markings on the cooktop surface. These marks should be removed **immediately** after the cooktop has cooled using the cooktop cleaning cream. Metal marks can become permanent if not removed prior to future use.

Cookware (cast iron, metal, ceramic or glass) with rough bottoms can mark or scratch the cooktop surface. **Do not slide anything metal or glass** across the cooktop. **Do not** use your cooktop as a cutting board or work surface in the kitchen. **Do not** cook foods directly on the cooktop surface without a pan. **Do not** drop heavy or hard objects on the glass cooktop, because they may cause it to crack.

Cleaning Recommendations for the Ceramic Glass Cooktop

CAUTION Before cleaning the cooktop, be sure the controls are turned to **OFF** and the cooktop is **COOL**.

WARNING **DO NOT** use a cooktop cleaner on a hot cooktop. The fumes can be hazardous to your health, and can chemically damage the ceramic glass surface.

For light to moderate soil:

Apply a few drops of CookTop® Cleaning Creme directly to the cooktop. Use a paper towel or use a **non-abrasive** plastic type **no-scratch** cleaning pad to clean the entire cooktop surface. Make sure the cooktop is cleaned thoroughly, leaving no residue.

For heavy, burned on soil:

Apply a few drops of CookTop® Cleaning Creme directly to the soiled area. Rub the soiled area using a **non-abrasive** plastic type **no-scratch** cleaning pad, applying pressure as needed. Do not use the pad you use to clean the cooktop for any other purpose.

If soils remain, carefully scrape soils with a metal razor blade scraper, holding scraper at a 30 degree angle to the surface. Remove loosened soils with cooktop cleaning cream and buff surface clean.

IMPORTANT NOTE: Damage to the ceramic glass cooktop may occur if you use an abrasive type scratch pad. Only use cleaning products that have been specifically designed for ceramic glass cooktop.

Plastic or foods with a high sugar content:

These types of soils need to be removed immediately if spilled or melted onto the ceramic cooktop surface. Permanent damage (such as pitting of the cooktop surface) may occur if not removed **immediately**. After turning the surface elements **OFF**, use a razor blade scraper or a metal spatula with a mitt and scrape the soil from the hot surface (as illustrated). Allow the cooktop to cool, and use the same method for heavy or burned on soils.

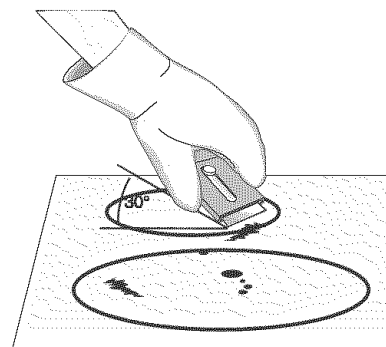

General Care & Cleaning (cont'd)

Do not use the following on the ceramic glass cooktop:

- Do not use abrasive cleaners and scouring pads, such as metal and some nylon pads. They may scratch the cooktop, making it more difficult to clean.
- Do not use harsh cleaners, such as chlorine bleach, ammonia or oven cleaners, as they may etch or discolor the cooktop.
- Do not use dirty sponges, cloths or paper towels, as they can leave soil or lint on the cooktop which can burn and cause discoloration.



Special Caution for Aluminum Foil and Aluminum Cooking Utensils

- **Aluminum foil**
Use of aluminum foil will damage the cooktop. Do not use under any circumstances.
- **Aluminum utensils**
Since the melting point of aluminum is much lower than that of other metals, care must be taken when aluminum pots or pans are used. Pans that boil dry may permanently damage cooktop by breaking, fusing to, or marking it.

Care and Cleaning of Stainless Steel (Stainless Steel models only)

Some models are equipped with stainless steel exterior parts. Special care and cleaning are **required** for maintaining the appearance of stainless parts. Please refer to the table provided at the beginning of the **General Care & Cleaning** section in this Use & Care Guide.

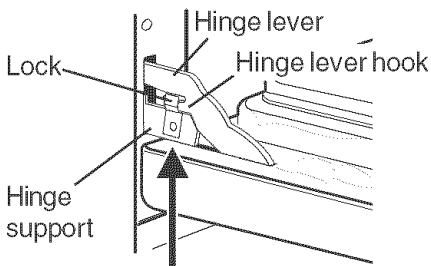

Lock engaged for door removal
Figure 1



Figure 2

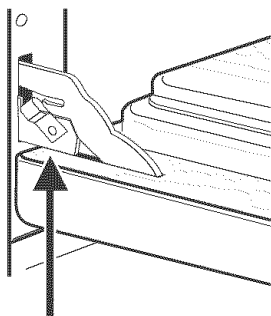

Lock in normal position
Figure 3

Removing and Replacing the Oven Door

CAUTION The door is heavy. For safe, temporary storage, lay the door flat with the inside of the door facing down.

To Remove Oven Door:

1. Open the door to the fully opened position.
2. Pull up the lock located on each hinge support and engage it onto the hinge lever hook (Figure 1). You may have to apply a little downward pressure on the door to pull the lock fully over the hinge lever hook.
3. Grab the door by the sides and pull the bottom of the door up and toward you to disengage the hinge supports. Keep pulling the bottom of the door toward you while rotating the top of the door toward the range to completely disengage the hinge levers (Figure 2).
4. To clean oven door, follow the instructions provided in the **General Care & Cleaning** table.

To Replace Oven Door:

1. Grab the door by the sides; place the hinge supports and levers into the hinge slots. Open the door to the fully opened position.
2. Disengage the lock from the hinge lever hooks on both sides (Figure 3).
Note: Make sure the hinge supports are fully engaged before unlocking the hinge levers.
3. Close the oven door.

Special Door Care Instructions - Most oven doors contain glass that can break.

Read the following recommendations:

1. Do not close the oven door until all the oven racks are fully in place.
2. Do not hit the glass with pots, pans, or any other object.
3. Scratching, hitting, jarring or stressing the glass may weaken its structure causing an increased risk of breakage at a later time.

General Care & Cleaning (cont'd)

Removing and Replacing Warmer (Warm & Ready™) Drawer



⚠ WARNING Electrical Shock Hazard can occur and result in serious injury or death. Disconnect appliance from electric power before cleaning and servicing the warmer drawer.

To Remove Warmer Drawer:

1. **⚠ CAUTION** Turn power off before removing the warmer drawer.
2. Open the drawer to the fully opened position.
3. Locate glide lever on each side of drawer, pull up on the left glide lever and push down on the right glide lever (See Figure 1).
4. Pull the drawer away from the range.

To Replace Warmer (Warm & Ready™) Drawer:

1. **Pull the bearing glides to the front** of the chassis glide (See Figure 2).
2. Align the glide on each side of the drawer with the glide slots on the range.
3. Push the drawer into the range until levers “click” (approximately 2”). Pull the drawer open again to seat bearing glides into position. **If you do not hear the levers “click” or the bearing glides do not feel seated remove the drawer and repeat steps 1 thru 3.** This will minimize possible damage to the bearing glides.

Note: The Warmer Drawer will **NOT** operate while in the “Self-Clean” and “Oven Lockout” modes

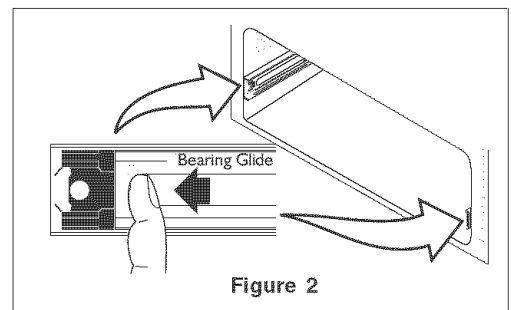
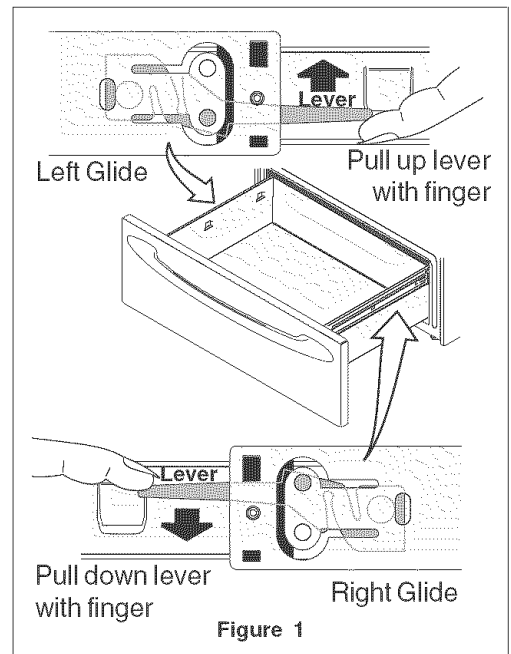

ENGLISH

Changing the Oven Light

The oven lights will automatically turn ON when the oven door is opened. The

oven lights may also be manually operated by pressing the



The lamp is covered with a glass shield. The glass shield can be removed to be cleaned manually or to change oven light. **THIS GLASS SHIELD MUST BE IN PLACE WHENEVER THE OVEN IS IN USE.**

To replace the light bulb:

CAUTION: BE SURE THE OVEN IS COOL.

1. Turn the power off at the main source.
2. Wear a leather-faced glove for protection against possible broken glass.
3. To remove the glass shield, pull the back side of the shield toward the inside of the oven in a manner to lift it up from the oven side.
4. The glass shield should come out easily by pushing a little toward front of the range.
5. Replace halogen light appliance bulb taking care not to touch the bulb with your bare fingers. Touching bulb with your skin can leave a film on the bulb that causes it to burn out quickly.
6. Replace glass shield in opposite order and manner of removal.

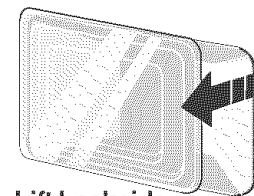

Lift backside of glass shield and remove it.

Halogen Light Bulb

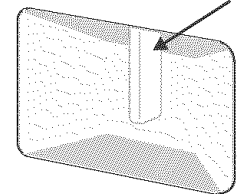

Before you call

Solutions to Common Problems

Before you call for service, review this list. It may save you time and expense. The list includes common occurrences that are not the result of defective workmanship or materials in this appliance.

OCCURRENCE	POSSIBLE CAUSE/SOLUTION
Range is not level.	<p>Poor installation. Place oven rack in center of oven. Place a level on the oven rack. Adjust leveling legs at base of range until the rack is level. When range is level, cooktop may appear out of alignment if countertop is not level.</p> <p>Weak, unstable floor. Be sure floor is level and can adequately support range. Contact a carpenter to correct sagging or sloping floor.</p> <p>Kitchen cabinet misalignment may make range appear to be unlevel. Be sure cabinets are square and have sufficient room for range clearance.</p>
Cannot move appliance easily. Appliance must be accessible for service.	<p>Cabinets not square or are built in too tight. Contact a cabinet maker to correct the problem.</p> <p>Contact builder or installer to make appliance accessible.</p> <p>Carpeting interferes with range. Provide sufficient space so range can be lifted over carpet.</p>
Entire range or oven does not operate.	<p>Make sure cord/plug is tightly into outlet.</p> <p>Service wiring is not complete. Contact your Sears Service Center, installing agent or qualified servicer.</p> <p>Power outage. Check house lights to be sure. Call your local electric company for service.</p>
Surface element does not heat.	<p>No power to the appliance. Check steps under "Entire range or oven does not operate" in this Before You Call checklist.</p> <p>Too low heat setting. Turn control to a slightly higher setting until element comes on.</p> <p>Incorrect control is on. Be sure to use correct control for the element to be used.</p>
Surface element too hot or not hot enough.	<p>Incorrect control setting. Raise or lower setting until proper amount of heat is obtained. Dial markings are an indicator of relative heat settings and will vary slightly.</p> <p>Voltage is incorrect. Be sure appliance is properly connected to the power source specified in the installation instructions. If you are not sure about this requirement call 1-800-4-MY-HOME® for service (See back cover).</p> <p>Lightweight or warped pans were used. Be sure to use proper cookware. Use only flat bottom, evenly balanced medium or heavyweight cookware. Heavy and medium weight pans heat evenly. Because lightweight pans heat unevenly, foods may burn easily.</p>
Food not heating evenly.	<p>Lightweight or warped pans were used. Be sure to use proper cookware. Use only flat bottom, evenly balanced medium or heavyweight cookware. Heavy and medium weight pans heat evenly. Because lightweight pans heat unevenly, foods may burn easily.</p> <p>Incorrect control setting. Raise or lower setting until proper amount of heat is obtained.</p>
Scratches or abrasions on cooktop surface.	<p>Coarse particles such as salt or sand between cooktop and utensils can cause scratches. Be sure cooktop surface and bottoms of utensils are clean before usage. Small scratches do not affect cooking and will become less visible with time.</p> <p>Cleaning materials not recommended for ceramic-glass cooktop have been used. See "Ceramic Glass Cooktop Cleaning & Maintenance" section under General Care & Cleaning.</p> <p>Cookware with rough bottom has been used. Use smooth, flat-bottomed cookware.</p>
Metalmarks.	<p>Sliding or scraping of metal utensils on cooktop surface. Do not slide metal utensils on cooktop surface. Use a ceramic-glass cooktop cleaning cream to remove the marks. See "Ceramic Glass Cooktop Cleaning & Maintenance" section under General Care & Cleaning.</p>

Brown streaks or specks.	Boilovers are cooked onto surface. Use razor blade scraper to remove soil. See “ Ceramic Glass Cooktop Cleaning & Maintenance ” section under General Care & Cleaning.
Areas of discoloration with metallic sheen.	Mineral deposits from water and food. Remove using a ceramic glass cooktop cleaning cream. Use cookware with clean, dry bottoms.
Oven control beeps and displays F1, F3 or F9	Electronic control has detected a fault condition. Press CLEAR to clear the display and stop beeping. Program oven again. If fault recurs, record fault number. Press CLEAR and contact Sears or other qualified service agency.
Oven light does not work.	Replace or tighten bulb. See “ Changing Oven Light ” in this Use and Care Guide for instructions.
Poor baking results.	Many factors affect baking results. Make sure the proper rack position is used. Center food in the oven and space pans to allow air to circulate. If conventional baking, allow the oven to preheat to the set temperature before placing food in the oven. Try adjusting the recipe’s recommended temperature or baking time. If you feel the oven is too hot or cool, see “ Adjusting Oven Temperature ” section in this Use and Care Guide.
Fan noise during cooking operation.	A cooling fan may automatically turn on and off to cool internal parts. It is normal, and the fan may continue to run after the range has been turned “OFF”, but may also stop immediately and then turn “ON” after a while.
Flames inside oven or smoking from vent.	Excessive spillovers in oven. Set self-clean cycle for a longer cleaning time. Excessive spillovers in oven. This is normal, especially for pie spillovers or large amounts of grease on the oven bottom. Wipe up excessive spillovers before starting the self-clean cycle. If flames or excessive smoke are present, stop the self-clean cycle and follow the steps under “ Stopping or Interrupting a Self-Cleaning Cycle ” in this Use and Care Guide.
Oven smokes excessively during broiling.	Control(s) not set properly. Follow instructions under “ Setting Broil ” in this Use and Care Guide. Make sure oven is opened to Broil Stop Position . Meat too close to the element. Reposition the rack to provide proper clearance between the meat and the element. Preheat broil element. The insert on broiler pan wrong side up and grease not draining. Always place insert on the broiler pan with ribs up and slots down to allow grease to drip into pan. Grease has built up on oven surfaces. Regular cleaning is necessary when broiling frequently. Old grease or food spatters cause excessive smoking.
Self-cleaning cycle does not work.	Control(s) not set properly. Follow instructions under “ Self-Cleaning ” in this Use and Care Guide. Self-cleaning cycle was interrupted. Cleaning time must be 3 to 4 hours past the start time. Follow steps under “ Stopping or Interrupting a Self-Cleaning Cycle ” in this Use and Care Guide.
Soil not completely removed after self-cleaning cycle.	Hand clean bottom, front top of oven, frame or door area outside oven seal before the self-cleaning is started. These areas are not in the self-cleaning area, but get hot enough to burn on residue. Burned-on residue can be cleaned with a stiff nylon brush and water or nylon scrubber. Be careful not to damage the oven seal by attempting to clean it.

Get it fixed, at your home or ours!

Your Home

For repair – **in your home** – of all major brand appliances, lawn and garden equipment, or heating and cooling systems, **no matter who made it, no matter who sold it!**

For the replacement parts, accessories and owner's manuals that you need to do-it-yourself.

For Sears professional installation of home appliances and items like garage door openers and water heaters.

1-800-4-MY-HOME[®] (1-800-469-4663)

Call anytime, day or night (U.S.A. and Canada)

www.sears.com www.sears.ca

Our Home

For repair of carry-in items like vacuums, lawn equipment, and electronics, call or go on-line for the location of your nearest

Sears Parts & Repair Center.

1-800-488-1222

Call anytime, day or night (U.S.A. only)

www.sears.com

To purchase a protection agreement (U.S.A.) or maintenance agreement (Canada) on a product serviced by Sears:

1-800-827-6655 (U.S.A.)

1-800-361-6665 (Canada)

Para pedir servicio de reparación a domicilio, y para ordenar piezas:

1-888-SU-HOGAR[®]

(1-888-784-6427)

Au Canada pour service en français:

1-800-LE-FOYER^{MC}

(1-800-533-6937)

www.sears.ca

