

30" ELECTRIC RANGE INSTALLATION INSTRUCTIONS

(For 3 or 4 Wire, 60 Hz. Systems)

INSTALLATION AND SERVICE MUST BE PERFORMED BY A QUALIFIED INSTALLER. IMPORTANT: SAVE FOR LOCAL ELECTRICAL INSPECTOR'S USE. READ AND SAVE THESE INSTRUCTIONS FOR FUTURE REFERENCE.

Clearances and Dimensions

1. **Provide adequate clearances** between the range and adjacent combustible surfaces.
2. **Location—Check location where the range will be installed.** Check for proper electrical supply, and the stability of the floor.
3. **Dimensions that are shown must be used.** Given dimensions provide minimum clearance. Contact surface must be solid and level.

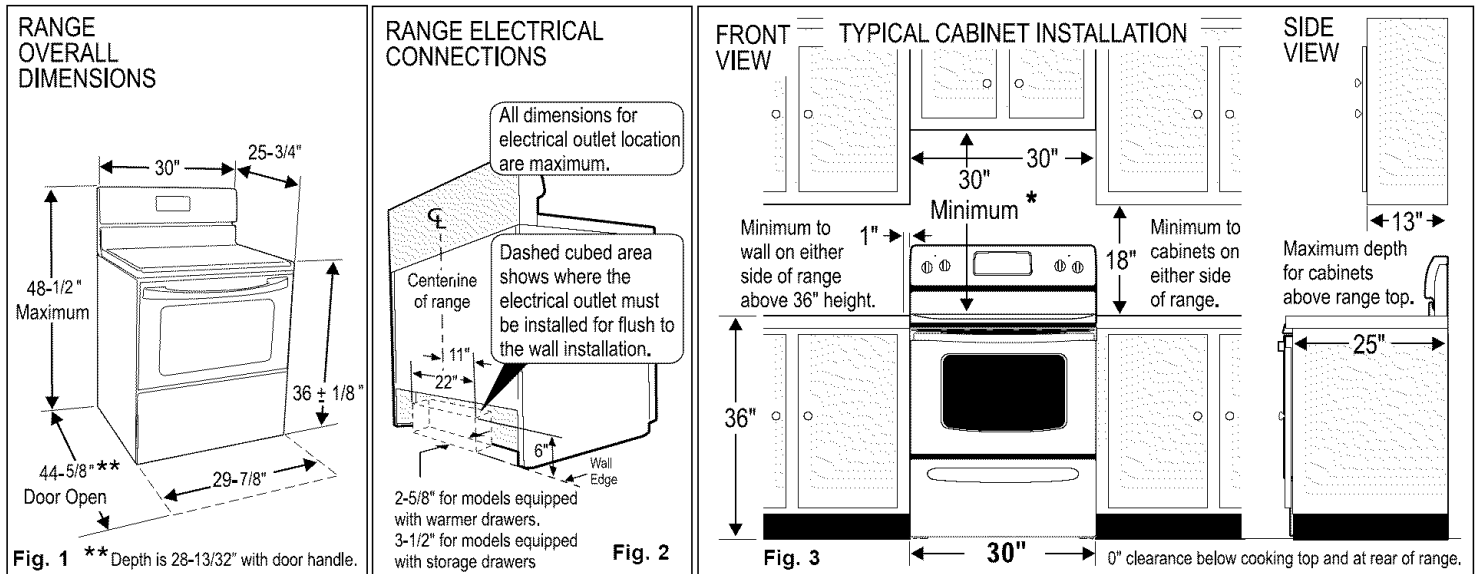

*30" MINIMUM CLEARANCE BETWEEN THE TOP OF THE COOKING SURFACE AND THE BOTTOM OF AN UNPROTECTED WOOD OR METAL CABINET; OR 24" MINIMUM WHEN BOTTOM OF WOOD OR METAL CABINET IS PROTECTED BY NOT LESS THAN 1/4" FLAME RETARDANT MILLBOARD COVERED WITH NOT LESS THAN NO. 28 MSG SHEET STEEL, 0.015" STAINLESS STEEL, 0.024" ALUMINUM OR 0.020" COPPER. 0" CLEARANCE IS THE MINIMUM FOR THE REAR OF THE RANGE. FOLLOW ALL DIMENSION REQUIREMENTS PROVIDED ABOVE TO PREVENT PROPERTY DAMAGE, POTENTIAL FIRE HAZARD, AND INCORRECT COUNTERTOP AND CABINET CUTS.

TO ELIMINATE THE RISK OF BURNS OR FIRE BY REACHING OVER HEATED SURFACE UNITS, CABINET STORAGE SPACE LOCATED ABOVE THE SURFACE UNITS SHOULD BE AVOIDED. IF CABINET STORAGE IS TO BE PROVIDED, THE RISK CAN BE REDUCED BY INSTALLING A RANGE HOOD THAT PROJECTS HORIZONTALLY A MINIMUM OF 5" BEYOND THE BOTTOM OF THE CABINETS.

IMPORTANT SAFETY INSTRUCTIONS

⚠ WARNING If the information in this manual is not followed exactly, a fire or electrical shock may result causing property damage, personal injury or death.

Important Notes to the Installer

- Read all instructions contained in these installation instructions before installing range.
- Remove all packing material from the oven compartments before connecting the gas & electrical supply to the range.
- Observe all governing codes and ordinances.
- Be sure to leave these instructions with the consumer.

Important Note to the Consumer

Keep these instructions with your owner's guide for future reference.

- As when using any appliance generating heat, there are certain safety precautions you should follow. These are listed in the Use & Care Manual, read it carefully.
- Be sure your range is installed and grounded properly by a qualified installer or service technician.
- Make sure the wall coverings around the range can withstand the heat generated by the range.
- To eliminate the need to reach over the surface elements, cabinet storage space above the elements should be avoided.



30" ELECTRIC RANGE INSTALLATION INSTRUCTIONS

(For 3 or 4 Wire, 60 Hz. Systems)

BEFORE STARTING

Tools You Will Need

For leveling legs and Anti-Tip Bracket:

- Adjustable wrench or channel lock pliers
- 5/16" Nutdriver or Flat Head Screwdriver
- Electric Drill & 1/8" Diameter Drill Bit (Masonry Drill Bit if installing in concrete)

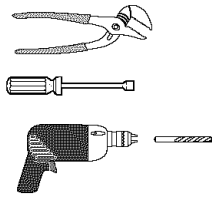

For electrical supply connection:

- 1/4" & 3/8" Socket driver or Nutdriver



Additional Materials You Will Need:

- Power Supply Cord or
- Copper Electrical Wiring & Metal Conduit (for hard wiring)

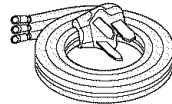

NORMAL INSTALLATION STEPS

1. ANTI-TIP BRACKET INSTALLATION INSTRUCTIONS - IMPORTANT SAFETY WARNING

To reduce the risk of tipping of the range, the range must be secured to the floor by properly installed Anti-Tip Bracket and screws packed with the range. Failure to install the anti-tip bracket will allow the range to tip over if excessive weight is placed on an open door or if a child climbs upon it. Serious injury might result from spilled hot liquids or from the range itself.

If range is ever moved to a different location, the Anti-Tip Bracket must also be moved and installed with the range.

Instructions are provided for installation in wood or cement fastened to either the floor or wall. When installed to the wall, make sure that screws completely penetrate dry wall and are secured in wood or metal. When fastening to the floor or wall, be sure that screws do not penetrate electrical wiring or plumbing.

1a. Locate the Bracket using the Template - (Bracket may be located on either the left or right side of the range. Use

the information below to locate the bracket if template is not available).

Mark the floor or wall where left or right side of the range will be located. If rear of range is against the wall or no further than 1-1/4" from wall

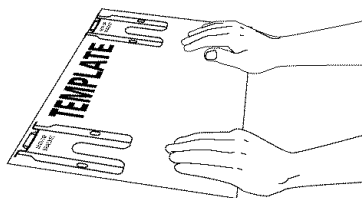

Fig. 4

when installed, you may use the wall or floor mount method. If molding is installed and does not allow the bracket to fit flush against the wall, remove molding or mount bracket to the floor. For wall mount, locate the bracket by placing the back edge of the template against the rear wall and the side edge of template on the mark made referencing the side of the range (See Fig. 4). Place bracket on top of template and mark location of the screw holes in wall. If rear of range is further than 1-1/4" from the wall when installed, attach bracket to the floor. For floor mount, locate the bracket by placing back edge of the template where the rear of the range will be located. Mark the location of the screw holes, shown in template.

1b. Drill Pilot Holes & Fasten Bracket - Drill a 1/8" pilot hole where screws are to be located. If bracket is to be mounted

to the wall, drill pilot hole at an approximate 20° downward angle (See Fig. 5).

If bracket is to be mounted to masonry or ceramic floors, drill a 5/32" pilot hole 1-3/4" deep. The screws provided may be used in wood or concrete material. Use a 5/16" nut-driver or flat head screwdriver to secure the bracket in place (See Fig. 6).

1c. Level and Position Range - Level range by adjusting the (4) leveling legs with a wrench. NOTE: A minimum clearance of 1/8" is required between the bottom of the range and the leveling leg to allow room for the bracket. Use a spirit level to check your adjustments. Slide range back into position (See Fig. 7). Visually check that rear leveling leg is inserted into and fully secured by the Anti-Tip Bracket by removing lower panel or storage drawer. For models with a Warmer Drawer or broiler compartment, grasp the top rear edge of the range and carefully attempt to tilt it forward.

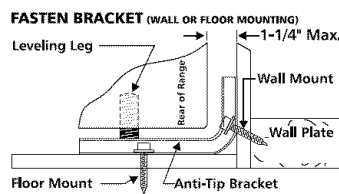

Fig. 5

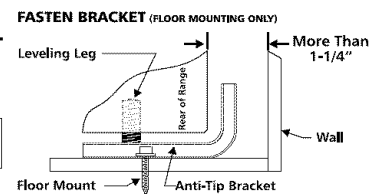

Fig. 6

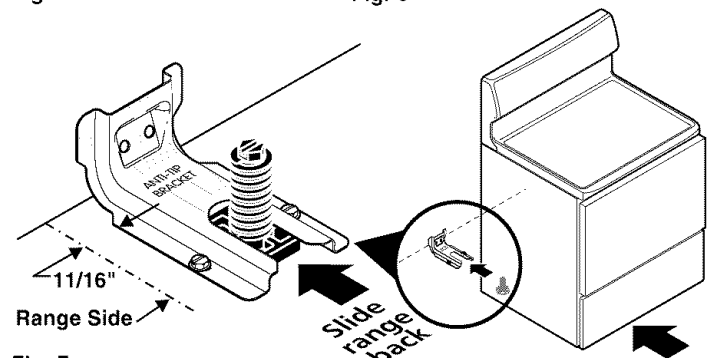

Fig. 7

2. ELECTRICAL CONNECTION REQUIREMENTS - This appliance must be properly installed and grounded by a qualified technician in accordance with the National Electrical Code ANSI/NFPA No. 70 -- latest edition -- and Local Electrical Code requirements.

This appliance may be connected by means of "Permanent Wiring" or "Power Supply Cord Kit."

When installing Permanent Wiring, do not leave excess wire in range compartment. Excess wire in the range compartment may not allow the Rear Access Cover to be replaced properly and could create a potential electrical hazard if wires become pinched. Connect only as instructed under "Permanent Wire Connections" in Step 4c. When using flexible conduit or range cable use flex connector or range cable strain relief (Fig. 11).

2a. Models with Factory Connected Power Supply Cord. NOTE: Some models may have a factory installed three (3) conductor Power Supply Cord.

Mobile home installations, new branch circuit installations (1996NEC) or areas where Local Codes do not permit grounding through neutral require a four (4) conductor power supply cord rated at 125/250 volts minimum and marked for use with ranges.

30" ELECTRIC RANGE INSTALLATION INSTRUCTIONS

(For 3 or 4 Wire, 60 Hz. Systems)

See Range Connection Opening Size Chart (Figs. 9 & 10) for cord kit ampere rating information. Terminals on end of wires must be either closed loop or open-end spade lugs with upturned ends.

2b. MODELS REQUIRING POWER SUPPLY CORD KIT. RISK OF FIRE OR ELECTRICAL SHOCK MAY OCCUR IF AN INCORRECT SIZE RANGE CORD KIT IS USED, THE INSTALLATION INSTRUCTIONS ARE NOT FOLLOWED OR STRAIN RELIEF BRACKET IS DISCARDED.

This appliance may be connected by means of a power supply cord. Only a power supply cord kit rated at 125/250 volts minimum, and marked for use with ranges shall be used. See Fig. 10 for cord kit ampere rating information. Cord must have either three (3) or four (4) conductors (See Fig. 8). Terminals on end of wires must be either closed loop or open-end spade lugs with upturned ends. Cord must have strain relief properly installed. See Steps 4a. for 4-Wire or 4b. for 3-Wire connections.

3. ELECTRICAL CONNECTION TO RANGE.

The Rear Access Cover must be removed (Fig 9). To remove, loosen center screw (one screw) and remove cover. The terminal block will then be accessible.

3 & 4 - Wire electrical wall Receptacle types &

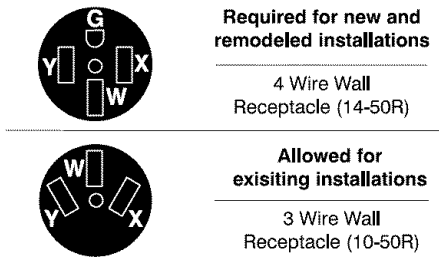

Fig. 8

NOTE: Range is shipped from factory with 1-3/8" dia. hole as shown. To use either 7/8" dia. hole or 1-1/8" dia. knockouts refer to Fig. 9.

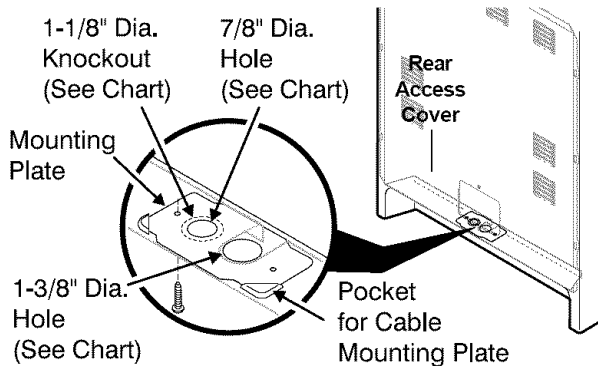

Fig. 9

Range Connection Opening Size Chart				
Supply Cord Kit ampere rating information. See serial plate on range for kilowatt rating data.				
See Serial Plate on Range for KW Rating	Cord Kit Ampere Rating	Diameter (inches) of Range connection Opening		
		Cord Kit	Permanent Wiring	
120/240 Volts 120/208 Volts				
8.8-16.5 KW 16.6-22.5 KW	7.9-12.5 KW 12.6-18.5 KW	40/50 Amp 50 Amp	1-3/8 in. 1-3/8 in.	1-1/8 in. 1-3/8 in.

Fig. 10

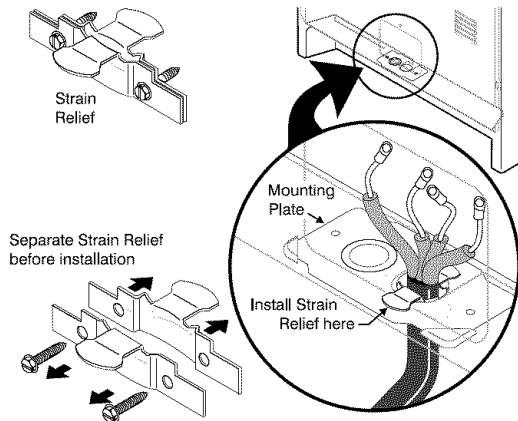

Fig. 11

4A. POWER CORD CONNECTIONS

(4-Wire Connection Instructions - Refer to Fig.12)

Before wiring the range review the suggested power source location drawing in Fig. 3. If connecting to a 4-Wire electrical system (new branch-circuit or mobile home requires 4-Wire connection):

1. Follow the manufacturer's installation instructions supplied with the strain relief and install (Also see Figs. 9, 10 & 11).
2. Insert the end connectors for Line 1, Line 2 and Neutral and tighten securely to the terminal block. **IMPORTANT NOTE:** DO NOT LOOSEN the factory installed nut connections which secure the range wiring to the terminal block. Electrical failure or loss of electrical connection may occur if these 3 nuts are loosened or removed.
3. **You must disconnect the ground strap.** Remove the factory installed ground screw & plate to release the copper ground strap from the frame of the appliance. Cut and discard the copper ground strap & plate. KEEP the ground screw.
4. Connect the ground wire (Green) lead with the eyelet to the frame of the appliance with the ground screw using the same hole in the frame where the ground screw was originally installed (See Fig. 12).
5. Make sure all screws are tightened securely and replace the rear access cover (See Fig. 9).

4-Wire Connection

Factory installed connections (DO NOT LOOSEN)

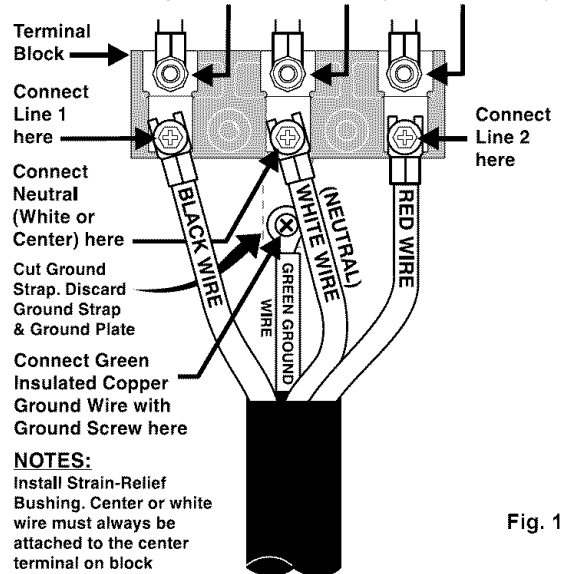

Fig. 12

30" ELECTRIC RANGE INSTALLATION INSTRUCTIONS

(For 3 or 4 Wire, 60 Hz. Systems)

or 4B. POWER CORD CONNECTIONS

(3-Wire Connection Instructions . For existing installations ONLY - Refer to Fig. 13).

1. Follow the manufacturer's installation instructions supplied with the strain relief and install (Also see Figs. 9, 10 & 11).
2. Insert the end connectors for Line 1, Line 2 and Neutral and tighten securely to the terminal block (See Fig. 13).
IMPORTANT NOTE: DO NOT LOOSEN the factory installed nut connections which secure the range wiring to the terminal block. Electrical failure or loss of electrical connection may occur if these 3 nuts are loosened or removed.
3. Make sure all connections are tightened securely and replace the rear access cover (See Fig. 9).

Grounding Instructions (3-Wire Connections only): A ground strap is installed on this range which connects the center terminal of the terminal block (Neutral) to the range chassis. The ground strap is connected to the range by the center, lowest screw (See Fig. 13). The ground strap must not be removed unless National, State or Local Codes do not permit use of a ground strap.

NOTE: If the ground strap is removed for any reason, a separate ground wire must be connected to the separate ground screw attached to the range chassis and to an adequate ground source.

4c. 3 & 4-WIRE PERMANENT WIRE CONNECTIONS.

3 - Wire Permanent Connection - follow Steps 1,2 & 5 below.

4 - Wire Permanent Connection - follow Steps 1 thru 5 below.

Before wiring the range, review the suggested power source location drawings in Fig. 3. If connecting to a 4-Wire electrical system (new branch-circuit or mobile home requires 4-Wire connection):

1. **(3 & 4 - Wire Permanent Connections)** Follow the manufacturer's installation instructions supplied with the strain relief and install.
2. **(3 & 4 - Wire Permanent Connections)** Strip insulation away from the ends of the permanent wiring for Line 1, Line 2, Neutral (also strip ground wire on 4-Wire Connections). Tighten all 3 wire leads to the terminal block (Follow wire locations shown in Fig. 14).
IMPORTANT NOTE: DO NOT LOOSEN the factory installed nut connections which secure the range wiring to the terminal block. Electrical failure or loss of electrical connection may occur if these 3 nuts are loosened or removed. **NOTE: For 3-Wire Permanent Connections skip Steps 3 & 4 and continue with Step 5.**
3. **(4-Wire Permanent Connection ONLY)** Disconnect the ground strap. Remove the factory installed ground screw & plate to release the factory installed copper ground strap from frame of the appliance. Cut and discard the copper strap from the terminal block. KEEP the ground screw, ground plate and go to Step 4.
4. **(4-Wire Permanent Connection ONLY)** Connect the ground wire lead (Green) to the frame of the appliance using the ground screw & plate as shown in Fig. 15. Be sure to install using the same hole in the frame where the ground screw was originally installed.
5. **(3 & 4 - Wire Permanent Connections)** Make sure all connections are tightened securely and replace the rear access cover (See Fig. 9).

NOTE: Non-terminated field wire compression connections must be set at approximately 35 in./lbs.

5. CAREFULLY SLIDE RANGE INTO FINAL LOCATION.

Be sure to provide all the adequate clearances and dimensions shown in Figs. 1, 2 & 3 before moving range into final location.

Carefully slide range into final position while inserting rear leveling leg into and FULLY ENGAGING THE ANTI-TIP BRACKET (See Fig. 7). Make sure the power cord folds into the remaining open floor area behind the range Warmer or storage drawer. Be sure to check the level of the range.

3-Wire Connection

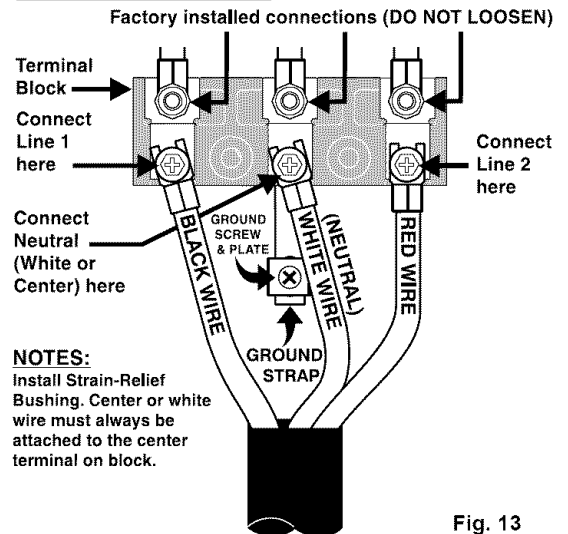

Fig. 13

FOR 3 & 4-Wire Permanent Connections

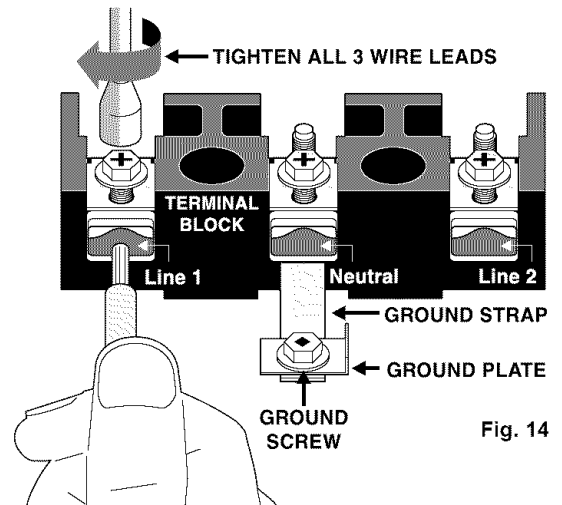

Fig. 14

4-Wire Permanent Connection ONLY

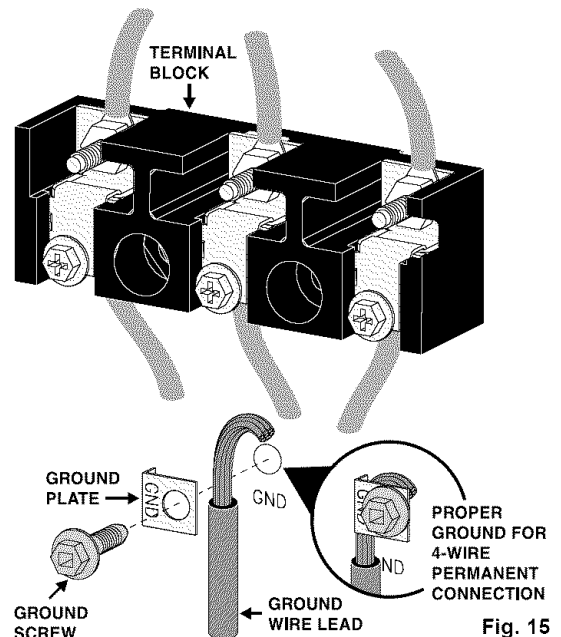

Fig. 15