

LCD HDTV Monitor

Operating Instructions

BRAVIA

KLV-32U100M

KLV-40U100M

Owner's Record

The model and serial numbers are located at the rear of the unit. Record these numbers in the spaces provided below. Refer to them whenever you call upon your Sony dealer regarding this product.

Model No. _____

Serial No. _____

Contacting Sony

If, after reading the following instructions, you have additional questions related to the use of your Sony® unit, please call one of the following numbers.

Customers in the continental United States contact the Direct Response Center at:

1-800-222-SONY (7669)

or visit <http://www.sony.com/TVsupport>

Customers in Canada contact the Customer Relations Center at:

1-877-899-SONY (7669)

or visit <http://www.sony.com/TVsupport>

WARNING

To reduce the risk of fire or electric shock, do not expose this apparatus to rain or moisture.



This symbol is intended to alert the user to the presence of uninsulated “dangerous voltage” within the product’s enclosure that may be of sufficient magnitude to constitute a risk of electric shock to persons.



This symbol is intended to alert the user to the presence of important operating and maintenance (servicing) instructions in the literature accompanying the appliance.

The apparatus shall not be exposed to dripping or splashing and no objects filled with liquids, such as vases, shall be placed on the apparatus.

CAUTION

To prevent electric shock, do not use this polarized AC plug with an extension cord, receptacle or other outlet unless the blades can be fully inserted to prevent blade exposure.

For Customers in the United States

If you have any questions about this product, you may call: Sony Customer Information Services Center 1-800-222-7669 or <http://www.sony.com/>

Declaration of Conformity

Trade Name: SONY
Model: KLV-32U100M/KLV-40U100M
Responsible Party: Sony Electronics Inc.
Address: 16450 W. Bernardo Dr,
San Diego, CA 92127 U.S.A.
Telephone Number: 858-942-2230

This device complies with part 15 of the FCC rules. Operation is subject to the following two conditions: (1) This device may not cause harmful interference, and (2) this device must accept any interference received, including interference that may cause undesired operation.

NOTIFICATION

This equipment has been tested and found to comply with the limits for a Class B digital device, pursuant to Part 15 of the FCC Rules. These limits are designed to provide reasonable protection against harmful interference in a residential installation. This equipment generates, uses and can radiate radio frequency energy and, if not installed and used in accordance with the instructions, may cause harmful interference to radio communications. However, there is no guarantee that interference will not occur in a particular installation. If this equipment does cause harmful interference to radio or television reception, which can be determined by turning the equipment off and on, the user is encouraged to try to correct the interference by one or more of the following measures:

- Reorient or relocate the receiving antenna.
- Increase the separation between the equipment and receiver.
- Connect the equipment into an outlet on a circuit different from that to which the receiver is connected.
- Consult the dealer or an experienced radio/TV technician for help.

Pursuant to FCC regulations, you are cautioned that any changes or modifications not expressly approved in this manual could void your authority to operate this equipment.

For Customers in Canada

This Class B digital apparatus complies with Canadian ICES-003.

Safety

- Operate the unit only on 120 V AC.
- Use the AC power cord specified by Sony and suitable for the voltage where you use it.
- The plug is designed, for safety purposes, to fit into the wall outlet only one way. If you are unable to insert the plug fully into the outlet, contact your dealer.
- If any liquid or solid object should fall inside the cabinet, unplug the unit immediately and have it checked by qualified service personnel before operating it further.
- If you will not be using the unit for several days, disconnect the power by pulling the plug itself. Never pull on the cord.
- For details concerning safety precautions, see “Important Safety Instructions” on page 4 and “Important Safeguards” on page 5.

Installing

- The unit should be installed near an easily accessible power outlet.
- To prevent internal heat buildup, do not block the ventilation openings.

- Do not install the unit in a hot or humid place, or in a place subject to excessive dust or mechanical vibration.
- Avoid operating the unit at temperatures below 5°C (41°F).
- If the unit is transported directly from a cold to a warm location, or if the room temperature changes suddenly, the picture may be blurred or show poor color due to moisture condensation. In this case, please wait a few hours to let the moisture evaporate before turning on the unit.
- To obtain the best picture, do not expose the screen to direct illumination or direct sunlight. It is recommended to use spot lighting directed down from the ceiling or to cover the windows that face the screen with opaque drapery. It is desirable to install the unit in a room where the floor and walls are not of a reflective material.

CAUTION

Use the following Sony appliance(s) only with the following WALL-MOUNT BRACKET.

Use with other WALL-MOUNT BRACKET may cause instability and possibly result in injury.

SONY APPLIANCE MODEL NO.

KLV-32U100M

KLV-40U100M

SONY WALL-MOUNT BRACKET MODEL NO.

SU-WL31 (KLV-32U100M)

SU-WL51 (KLV-40U100M)

To Customers

Sufficient expertise is required for installing the specified product. Be sure to subcontract the installation to Sony dealers or licensed contractors and pay adequate attention to safety during the installation.

(Continued)

For Customers in the United States

This product contains mercury. Disposal of this product may be regulated if sold in the United States. For disposal or recycling information, please contact your local authorities or the Electronics Industries Alliance (<http://www.eiae.org>).

To Sony Dealers

For installation of SONY WALL-MOUNT BRACKET, be sure to read and follow the instructions supplied with those optional products.

Trademark Information

WOW, SRS and the (●)* symbol are trademarks of SRS Labs, Inc. WOW technology is incorporated under license from SRS Labs, Inc.

Licensed by BBE Sound, Inc. under USP4638258, 4482866. "BBE" and BBE symbol are trademarks of BBE Sound, Inc. BBE High Definition Sound is fully activated maximizing the sound effect in the WOW mode.

Macintosh is a trademark licensed to Apple Computer, Inc., registered in the U.S.A and other countries.

CineMotion is a registered trademark of Sony Corporation.





As an ENERGY STAR® Partner, Sony Corporation has determined that this product meets the ENERGY STAR® guidelines for energy efficiency.

ENERGY STAR® is a U.S. registered mark.

HDMI This unit incorporates High-Definition Multimedia Interface (HDMI™) technology. HDMI, the HDMI logo and High-Definition Multimedia Interface are trademarks or registered trademarks of HDMI Licensing LLC.

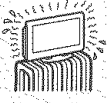
Important Safety Instructions

- 1) Read these instructions.
 - 2) Keep these instructions.
 - 3) Heed all warnings.
 - 4) Follow all instructions.
 - 5) Do not use this apparatus near water.
 - 6) Clean only with dry cloth.
 - 7) Do not block any ventilation openings. Install in accordance with the manufacturer's instructions.
 - 8) Do not install near any heat sources such as radiators, heat registers, stoves, or other apparatus (including amplifiers) that produce heat.
- 
- A diagram of a polarized two-prong electrical plug. One prong is wider than the other. The diagram is labeled with "GROUNDING PRONG" pointing to the wider prong and "NEUTRAL" pointing to the narrower prong.
- 9) Do not defeat the safety purpose of the polarized or grounding-type plug. A polarized plug has two blades with one wider than the other. A grounding type plug has two blades and a third grounding prong. The wide blade or the third prong are provided for your safety. If the provided plug does not fit into your outlet, consult an electrician for replacement of the obsolete outlet.
 - 10) Protect the power cord from being walked on or pinched particularly at plugs, convenience receptacles, and the point where they exit from the apparatus.
 - 11) Only use attachments/accessories specified by the manufacturer.
 - 12) Use only with the cart, stand, tripod, bracket, or table specified by the manufacturer, or sold with the apparatus. When a cart is used, use caution when moving the cart/apparatus combination to avoid injury from tip-over.
- 
- A circular warning icon showing a person tripping over a power cord. The person is falling backwards, and the cord is on the ground in front of them.
- 13) Unplug this apparatus during lightning storms or when unused for long periods of time.
 - 14) Refer all servicing to qualified service personnel. Servicing is required when the apparatus has been damaged in any way, such as power-supply cord or plug is damaged, liquid has been spilled or objects have fallen into the apparatus, the apparatus has been exposed to rain or moisture, does not operate normally, or has been dropped.

Important Safeguards

Before using your unit, please read these instructions completely, and keep this manual for future reference.

Carefully observe and comply with all warnings, cautions and instructions placed on the unit or described in the operating instructions or service manual.

WARNING

To guard against injury, the following basic safety precautions should be observed in the installation, use and servicing of the unit.

Use

Power Sources

This unit should be operated only from the type of power source indicated on the information label. If you are not sure of the type of electrical power supplied to your home, consult your dealer or local power company.

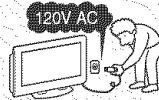

Grounding or Polarization

This unit is equipped with a polarized AC power cord plug (a plug having one blade wider than the other), or with a three-wire grounding type plug (a plug having a third pin for grounding). Follow the instructions below:

For the unit with a three-wire grounding type AC power cord plug (Class 1 unit)

This unit must be connected to an AC power socket outlet with a protective earthing connection.



For the unit with a polarized AC power cord plug

This plug will fit into the power outlet only one way. This is a safety feature. If you are unable to insert the plug fully into the outlet, try reversing the plug.



If the plug still fails to fit, contact your electrician to have a suitable outlet installed. Do not defeat the safety purpose of the polarized plug by forcing it in.

Wall outlet

Do not use a poor fitting outlet.

Insert the plug fully into the outlet. If it is loose, it may cause arcing and result in fire.

Contact your electrician to have the outlet changed.

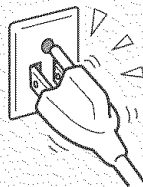

Wiring

For your safety, unplug the AC power cord when wiring cables.

Electric shock

Do not touch the AC power cord or the unit with a wet hand. If you plug/unplug the AC power cord from the unit with a wet hand, it may cause electric shock.



Cleaning

- Clean the AC power plug regularly. If the plug is covered with dust and it picks up moisture, its insulation may deteriorate and result in fire. Unplug the AC power plug and clean it regularly.

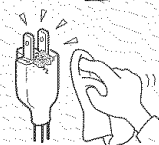

- Unplug the AC power cord when cleaning this unit. If not, it may result in electric shock.

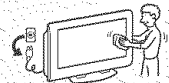

- Clean the cabinet of the unit with a dry soft cloth. To remove dust from the screen, wipe it gently with a soft cloth. Stubborn stains may be removed with a cloth slightly dampened with a solution of mild soap and warm water. Never use strong solvents such as thinner or benzine for cleaning.
- If using a chemically pretreated cloth, please follow the instruction provided on the package.
- If the picture becomes dark after using the unit for a long period of time, it may be necessary to clean the inside of the unit. Consult qualified service personnel.

Overloading

Do not overload wall outlets, extension cords or convenience receptacles beyond their capacity, since this can result in fire or electric shock.



Power

Always turn the unit off when it is not being used. When the unit is left unattended and unused for long periods of time, unplug it from the wall outlet as a precaution against the possibility of an internal malfunction that could create a fire hazard.

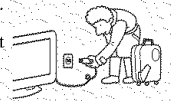

Sound

If a snapping or popping sound from the unit is continuous or frequent while the unit is operating, unplug the unit and consult your dealer or service technician. It is normal for unit's to make occasional snapping or popping sounds, particularly when being turned on or off.

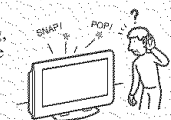

AC Power Cord

If you damage the AC power cord, it may result in fire or electric shock.

- Do not pinch, bend, or twist the cord excessively. The core lines may be bared and cut, and cause short-circuit, resulting in fire or electric shock.
 - Do not convert or damage the AC power cord.
 - Do not put anything heavy on the AC power cord. Do not pull the AC power cord.
 - Keep the AC power cord away from heat sources.
 - Be sure to grasp the plug when disconnecting the AC power cord.
- If the AC power cord is damaged, stop using it and ask your dealer or Sony service center to exchange it.

Batteries

Do not dispose of batteries in a fire.

Do not short circuit, disassemble or overheat the batteries.

Disposal of used batteries

To preserve our environment, dispose of used batteries according to your local laws or regulations.

Ventilation holes

Never push objects of any kind into the unit through the cabinet slots as they may touch dangerous voltage points or short out parts that could result in a fire or electric shock. Never spill liquid of any kind on the unit.

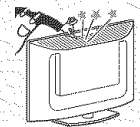

Objects and Liquid Entry

Do not place any objects on the unit.

The apparatus shall not be exposed to dripping or splashing and no objects filled with liquids, such as vases, shall be placed on the apparatus.

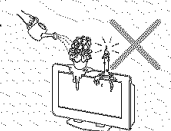

(Continued)

Attachments

Do not use attachments not recommended by the manufacturer, as they may cause hazards.

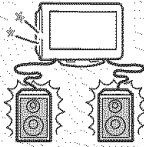

Medical institution

Do not place this unit in a place where medical equipment is in use.

It may cause malfunction of medical instruments.

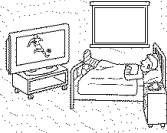

Moisture and flammable objects

- Do not use plugged sets near water — for example, near a bathtub, washbowl, kitchen sink, or laundry tub, in a wet basement, or near a swimming pool, etc. It may result in fire or electric shock.
- Do not let this unit get wet. Never spill liquid of any kind on the unit. If any liquid or solid object does fall through, do not operate the unit. It may result in electric shock or damage to the unit. Have it checked immediately by qualified personnel.
- To prevent fire, keep flammable objects or open flame (e.g. candles) away from the unit.

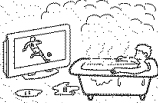

Accessories

Do not place the unit on an unstable cart, stand, table or shelf. The unit may fall, causing serious injury to a child or an adult and serious damage to the unit. No part of the unit should overhang any edge of the unit cart or stand; any overhanging edge is a safety hazard. An appliance and cart combination should be moved with care. Quick stops, excessive force, and uneven surfaces may cause the appliance and cart combination to overturn.



Broken pieces

Do not throw anything at the unit.

The screen glass may break by the impact and cause serious injury.

Cable wiring

Take care not to catch your feet on the cables. It may damage the unit.

Heat

Do not touch the surface of the unit.

It remains hot, even for some time after the unit is turned off.

Volume adjustment

- Adjust the volume so as not to trouble your neighbors. Sound carries very easily at night time. Therefore, closing the windows or using headphones is suggested.
- When using headphones, adjust the volume so as to avoid excessive levels, as hearing damage may result.

Disposal of the unit

- Do not dispose the unit with general household waste.
- The LCD contains a small amount of liquid crystal. The fluorescent tube used in this display contains mercury. Follow your local ordinances and regulations for disposal.

Handling of broken glass and liquid crystal leakage

If the LCD panel gets damaged, crystalline liquid leakage may occur, or scattered broken glass may result. Do not touch broken glass or crystalline liquid (which is toxic), with bare hands as cuts or poisoning/skin irritation may occur. Also, do not let glass fragments or leaked crystalline liquid get into your eyes or mouth. Should either contact your eyes or mouth, rinse the contacted area thoroughly with water and consult your doctor.

LCD screen

- Although the LCD screen is made with high-precision technology and has effective pixels of 99.99% or more, black dots may appear or bright points of light (red, blue, or green) may appear constantly on the LCD screen. This is a structural property of the LCD panel and is not a malfunction.
- Do not expose the LCD screen surface to the direct sun light. Doing so may damage the screen surface.
- Do not push or scratch the LCD screen, or place objects on top of the unit. The image may be uneven or the LCD panel may be damaged.
- If the unit is used in a cold place, a smear may occur in the picture or the picture may become dark. This does not indicate a failure. These phenomena improve as the temperature rises.
- Ghosting may occur when still pictures are displayed continuously. It may disappear after a few moments.
- The screen and cabinet get warm when the unit is in use. This is not a malfunction.
- Avoid spraying insect repellent with volatile material to the screen.
- Avoid prolonged contact with rubber or plastic made material.

Fluorescent lamp

This unit uses a special fluorescent lamp as its light source. If the screen image becomes dark, flickers, or does not appear, the fluorescent lamp has run down and should be replaced. For replacement, consult qualified service personnel.

Installation

Installation

- When installing or removing the unit on the wall, be sure to use qualified contractors. Wall mount installation requires the use of a wall-mount bracket. If the unit is installed or removed from the wall by a person other than a qualified contractor, the unit may fall and cause serious injury if the unit is not installed securely.
- To prevent injury, this apparatus must be securely attached to the stand/wall in accordance with the installation instructions.
- Carrying the unit requires two or more people.

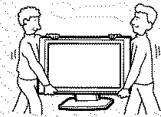
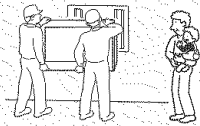

Placement for viewing

It is recommended to watch the unit at a distance of 3 to 7 times that of the screen height, and in moderate brightness. Watching the unit for too long or in a dark room will cause eye fatigue.

Optional accessories

Observe the following when installing the unit using a wall-mount bracket. If the unit is not secured properly, it may fall and cause injury.

- Be sure to follow the operating instructions supplied with the wall-mount bracket when installing the unit.
- Be sure to attach the brackets supplied with the wall-mount bracket.

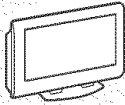

Protruding location

Do not install the unit in protruding locations. If you install the unit in the following locations, injury may result.

- Do not install the unit in a location where the unit protrudes, such as pillars.
- Do not install the unit in a location that may cause injury.

Oils

Do not install this unit in restaurants where oily vapors occur. Dust absorbing oil may enter into the unit and damage the unit.

Corrosion

Use of this unit near the seashore may subject the set to excessive salt, corrosion and internal damage and result in deterioration of the unit's performance. If the set will be subjected to these conditions, steps should be taken to reduce the humidity and temperature of the area where the unit is located.

Ventilation

The slots and openings in the unit are provided for necessary ventilation. To ensure reliable operation of the unit, and to protect it from overheating, these slots and openings must never be blocked or covered.

Unless proper ventilation is provided, the unit may gather dust and get dirty. For proper ventilation, observe the following:

- Do not install the unit turned backward or sideways.
- Do not install the unit turned over or upside down.
- Never cover the slots and openings with a cloth or other materials.

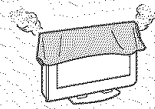
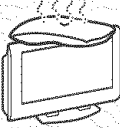

- Never block the slots and openings by placing the unit on a bed, sofa, rug or other similar surface.

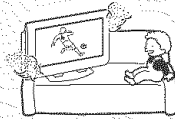

- Never place the unit in a confined space, such as a bookcase or built-in cabinet, unless proper ventilation is provided.

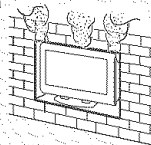

- Leave some space around the unit. Otherwise, adequate air-circulation may be blocked causing overheating and cause fire or damage the unit.

When installing the unit on the wall, allow this much space.

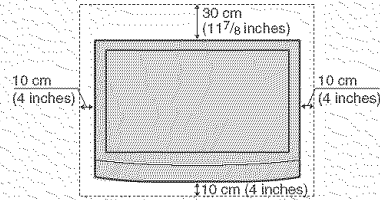

When installing the unit using a stand, allow this much space.

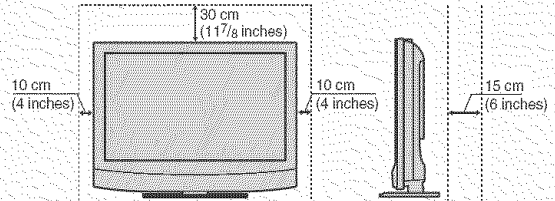

Never install the unit as follows:

Air circulation is blocked.

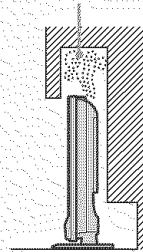

Air circulation is blocked.

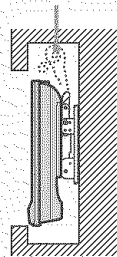

Outdoor use

Do not install this unit outdoors. If the unit is exposed to rain, it may result in fire or electric shock. If the unit is exposed to direct sunlight, the unit may heat up and cause damage to the unit.

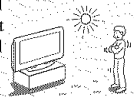

Vehicle and ceiling

Do not install this unit in a vehicle or hang from the ceiling.

Bumping of the vehicle may cause the unit to fall down and cause injury.



Ship and vessel

Do not install this unit in a ship or vessel. If the unit is exposed to seawater, it may cause fire or damage the unit.

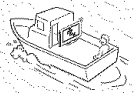

Preventing the unit from toppling over

Take measures to prevent the unit from toppling over and causing injury. To prevent the unit from toppling over, secure the unit to the wall or pillar.

(Continued)

Installing on a level surface

If you install the unit on a non-level surface, the unit may fall or drop and cause injury or damage.



Placing on a stable surface

If you place the unit on an unstable surface, the unit may fall and cause injury or damage.

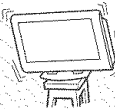

Fall

Do not hang anything on the unit.

The unit may fall from the stand or wall-mount bracket, causing damage or serious injury.

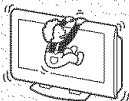

AC power cord

Unplug the AC power cord when moving the unit.

Do not move the unit with the AC power cord plugged in. It may damage the AC power cord and result in fire or electric shock.

Do not allow anything to rest on or roll over the power cord, and do not place the unit where the power cord is subject to wear or abuse.



Lightning

For added protection for this unit during a lightning storm, or when it is left unattended and unused for long periods of time, unplug it from the wall outlet. This will prevent damage to the unit due to lightning and power-line surges.

Service

Damage requiring service

Unplug the unit from the wall outlet and refer servicing to qualified service personnel under the following conditions:

- When the power cord or plug is damaged or frayed.

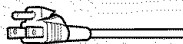
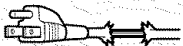

- If liquid has been spilled into the unit.
- If the surface of the unit cracks, do not touch it, unplug the AC power cord.
- If the unit has been exposed to rain or water.

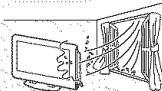

- If the unit has been subjected to excessive shock by being dropped, or the cabinet has been damaged.



- If the unit does not operate normally when following the operating instructions. Adjust only those controls that are specified in the operating instructions. Improper adjustment of other controls may result in damage and will often require extensive work by a qualified technician to restore the unit to normal operation.

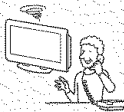

- When the unit exhibits a distinct change in performance, it indicates need for service.

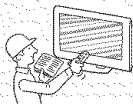

Servicing

Do not attempt to service the unit yourself since opening the cabinet may expose you to dangerous voltages or other hazards. Refer all servicing to qualified service personnel.

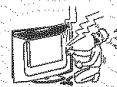

Replacement parts

When replacement parts are required, be sure the service technician certifies in writing that he/she has used replacement parts specified by the manufacturer that have the same characteristics as the original parts.



Unauthorized substitutions may result in fire, electric shock or other hazards.

Safety check

Upon completion of any service or repairs to the unit, ask the service technician to perform routine safety checks (as specified by the manufacturer) to determine that the unit is in safe operating condition, and to so certify. Ask a qualified service technician to dispose of the unit.



Contents

Introducing the Unit

Welcome	10
Package Contents	10
Features	10
Installing the Unit	11
Preventing the Unit from Toppling Over	11
Bundling the Connecting Cables.....	12
Unit Controls and Connectors	13
Front, Top and Side Panel	13
Rear Panel	15
Bottom Panel	16

Connecting the Unit

Making Video and Audio Connections	17
Satellite Receiver	18
VCR and Cable	19
HD Equipment	20
DVD Player	22
HDMI-Equipped Device	24
DVI-HDTV-Equipped Device	25
Personal Computer	26
Camcorder or Video Game Equipment	27

Using the Unit

Button Descriptions	28
Special Buttons on the Remote Control	29
Using the Wide Screen Mode	29
Using the Freeze Function	30
Using the Power Saving Function	30
Using the Sleep Function	31

Using the Settings

Overview of the Settings	32
Using the Picture Settings	33
Selecting Picture Options.....	33
Selecting PC Picture Options.....	34
Using the Sound Settings	35
Selecting Sound Options	35
Using the Screen Settings	36
Selecting Screen Options	36
Selecting PC Screen Options	38

Using the Setup Settings	40
Selecting Setup Options.....	40

Other Information

Troubleshooting	42
Contacting Sony	43
Specifications	44
Index	45

Introducing the Unit

Welcome

Thank you for purchasing this Sony HDTV Ready LCD unit. This manual is for models KLV-32U100M and KLV-40U100M.

Package Contents

Along with your new unit, the packaging box contains a remote control, size AA batteries.

See page 44 for the complete list of supplied accessories.

Features

Some of the features that you will enjoy with your new unit include:

- Wide Screen Mode:** Watch conventional 4:3 aspect ratio broadcasts in wide screen (16:9) mode.
- CineMotion[®]:** Using the reverse 3-2 pull down technology, the CineMotion feature provides smoother picture movement when playing back movies or other video sources on film.
- Component Video Input:** Offers the best video quality for DVD (480p and 480i), and digital set-top box (1080i, 720p, 480p and 480i) connections.
- HDMI (High-Definition Multimedia Interface):** Provides an uncompressed, all-digital audio/video interface between this unit and any HDMI-equipped audio/video component, such as a set-top box, DVD player, and A/V receiver. HDMI supports enhanced, or high-definition video, plus two-channel digital audio.
- PC Input:** PC Input allows you to connect your PC and display the PC screen on your unit.

Installing the Unit

Preventing the Unit from Toppling Over

Attaching the Support Belt

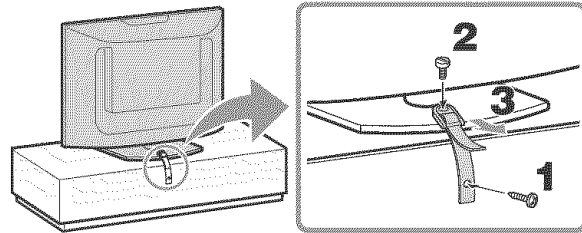

- 1** Screw the support belt (supplied) to the unit stand with a wood screw (supplied).
- 2** Attach the support belt to the stand, and screw the belt with a securing screw (supplied) using a coin, etc.
- 3** Adjust the length by pulling the support belt towards you while holding the unit stand.

- ⚠ Be sure to take measures to prevent the unit from toppling over and causing injury.
- ⚠ Depending on the material used for the stand you chose for this unit, the supplied wood screw may not be suitable. Consult your dealer about the type of screw you can use for this unit and your stand. You will need screws that are 3 to 4 mm ($1/8$ to $3/16$ inches) in diameter.

When Mounting on a Wall

See the Instruction Guide supplied with the wall-mount bracket on how to mount the unit on the wall.

***Bundling the
Connecting Cables***

You can bundle the connecting cables as illustrated below.

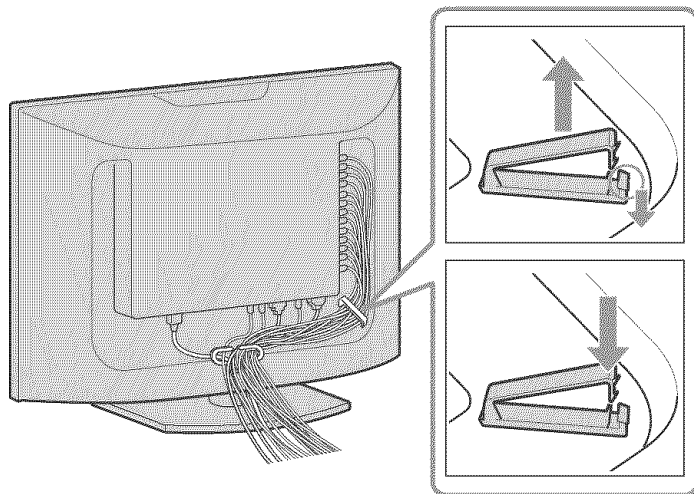

Unit Controls and Connectors

Front, Top and Side Panel

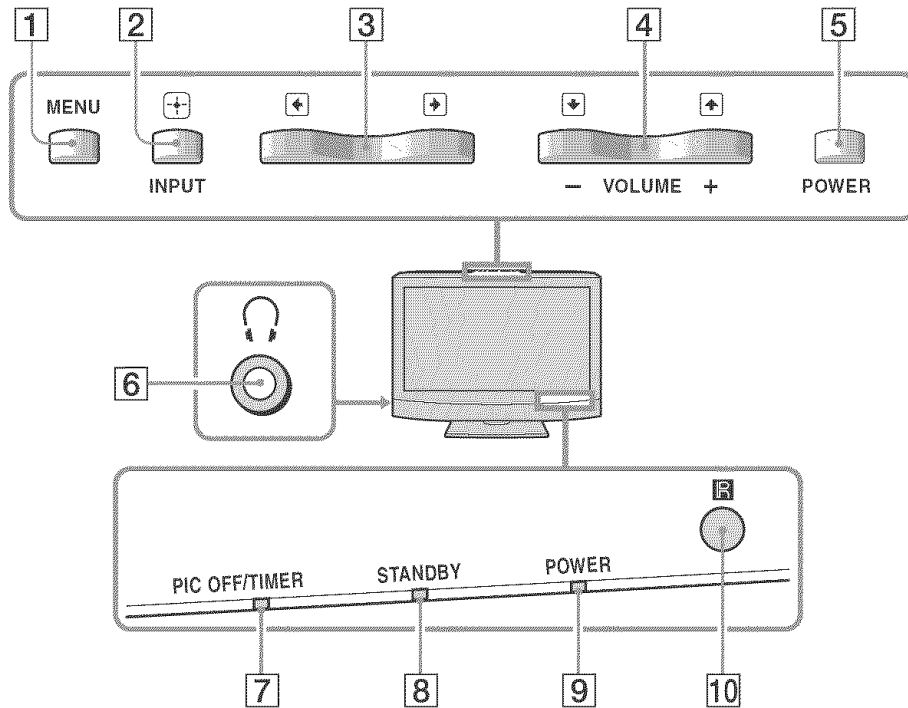

Item	Description
1 MENU	Press to display MENU. Press again to exit MENU.
2 INPUT/ (+)	Press repeatedly to cycle through the external equipment connected to the unit's inputs. Press to select the menu options in the MENU screen.
3 ← →	In the MENU screen, these buttons serve as left/right buttons.
4 ↓ ↑ - VOLUME +	Press to adjust the volume. In the MENU screen, these buttons serve as up/down buttons.
5 POWER	Press to turn on and off the unit.
6 Headphones jack	Connects to your headphones. If your headphones do not match the jack, use a suitable plug adaptor (not supplied).
7 PIC OFF/TIMER LED	When lit in green, indicates that the Picture Off feature is activated. For details, see page 41. When lit in orange, indicates Sleep Timer is set.

 The VOLUME + button has a tactile dot. Use it as a reference when operating the unit.

(Continued)

Introducing the Unit

<i>Item</i>	<i>Description</i>
8	STANDBY LED Lights up in red when in the standby mode for PC inputs.
9	POWER LED Lights up in green when the unit is turned on.
10	(IR) Infrared Receiver Receives IR signals from the remote control.

Rear Panel

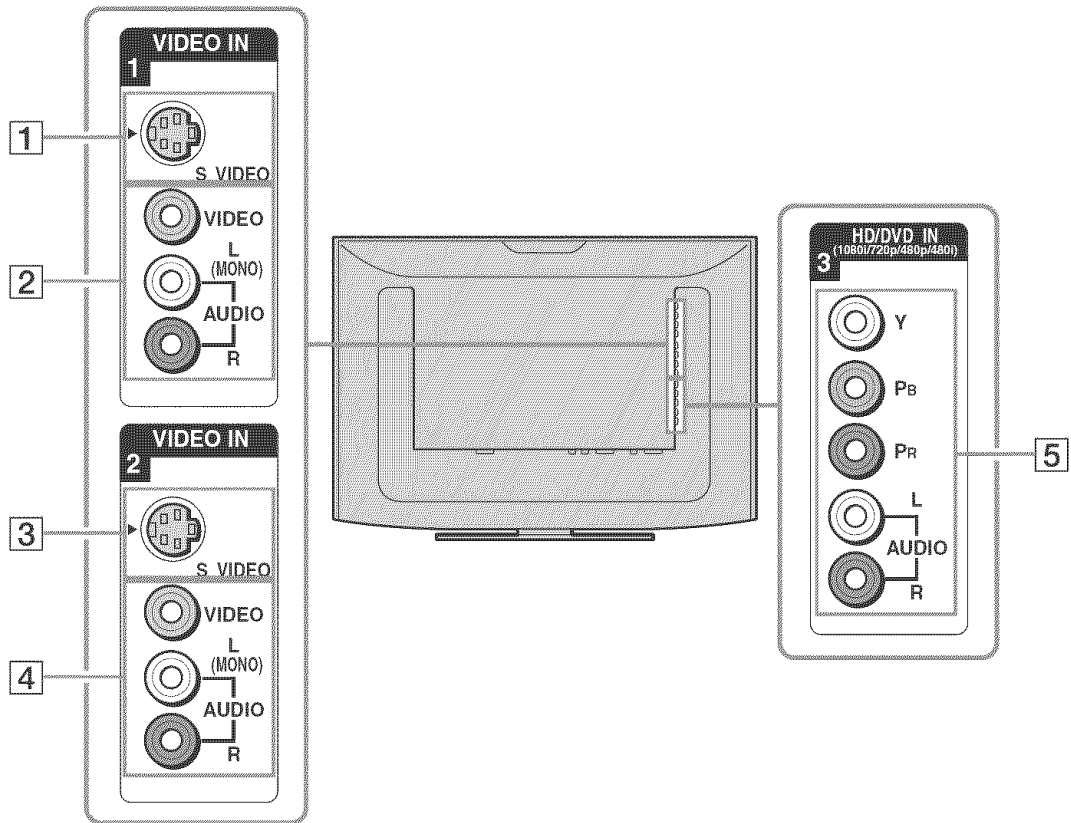

Jack	Description
1 VIDEO IN 1 S VIDEO	Connects to the S VIDEO output jack of your VCR or other video equipment that has S VIDEO. S VIDEO provides better picture quality than the composite video (2).
2 VIDEO IN 1 VIDEO/ L (MONO) - AUDIO-R	Connect to the composite video and audio output jacks on your VCR or other video component.
3 VIDEO IN 2 S VIDEO	Connects to the S VIDEO output jack of your VCR or other video equipment that has S VIDEO. S VIDEO provides better picture quality than the composite video (4).
4 VIDEO IN 2 VIDEO/ L (MONO) - AUDIO-R	Connect to the composite video and audio output jacks on your VCR or other video component.
5 HD/DVD IN 3 (1080i/720p/ 480p/480i)/ L-AUDIO-R	Connect to your DVD player's or digital set-top box's component video (YPbPr) and audio (L/R) jacks. Component video provides better picture quality than the S VIDEO (1 , 3) or the composite video (2 , 4) connections.

Bottom Panel

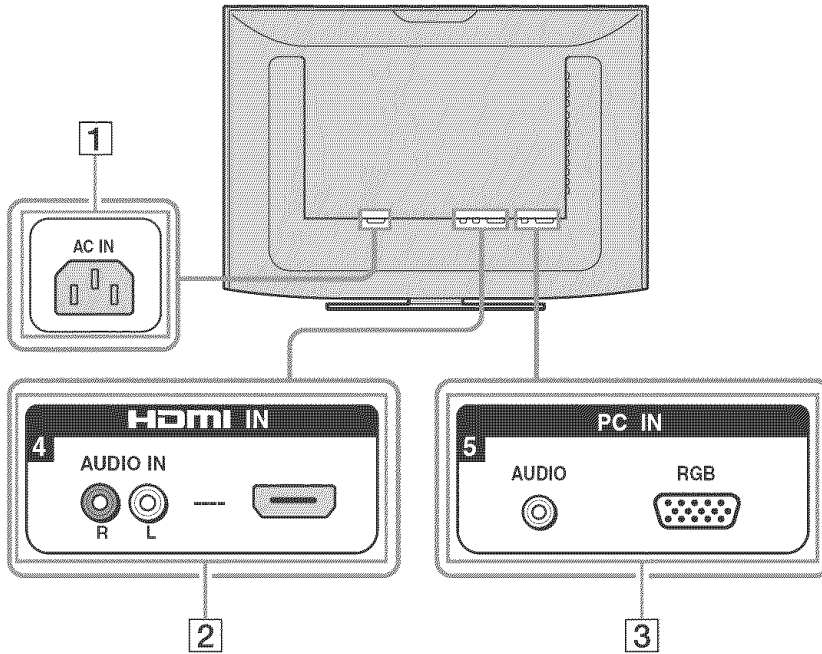

Jack	Description
1 AC IN	Connects the supplied AC power cord.
2 HDMI IN 4 HDMI/ R-AUDIO IN-L	HDMI (High-Definition Multimedia Interface) provides an uncompressed, all-digital audio/video interface between this unit and any HDMI-equipped audio/video component, such as a set-top box, DVD player, and A/V receiver. HDMI supports enhanced, or high-definition video, plus two-channel digital audio. The AUDIO IN (R/L) of HDMI IN is for DVI connection. See page 25 for details.
3 PC IN 5 RGB/AUDIO	Connect to a personal computer's video and audio output jacks. Can be connected to other Analog RGB devices such as Video Conferencing or Set-top Boxes. See "PC Input Signal Compatibility Chart" on page 39 for the signal to be displayed.

Connecting the Unit





To display clear crisp pictures, first you must connect your unit correctly and also need to choose the correct display format (see “Changing the wide screen mode” on page 29).

Making Video and Audio Connections

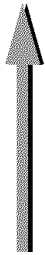
Your unit includes several types of video inputs. When connecting your unit, use the inputs that are available on your devices that provide the best video performance, as described below.

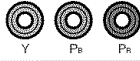
Best Video Performance



	Connector type	Separate audio connection required
	HDMI (High-Definition Multimedia Interface)	No
	Component video (1080i/720p/480p/480i)	Yes 
	S VIDEO	
	Composite video	

 When both S VIDEO and VIDEO inputs are connected, the S VIDEO input is automatically selected. To view the VIDEO input, disconnect the S VIDEO cable.

Satellite Receiver

This scenario shows a SAT Box connected through the video inputs. Satellite signals are selected by the SAT Box through the video inputs.

To connect a satellite receiver

- 1** Connect the satellite antenna cable to the satellite receiver's satellite input jack.
- 2** Use an A/V and S VIDEO cables to connect the satellite receiver's AUDIO and S VIDEO output jacks to the unit's AUDIO and S VIDEO input jacks (VIDEO 1 or 2).

 If you connect the Digital Satellite Receiver with component video cables, see page 20.

 If your satellite receiver is not equipped with S VIDEO, use a VIDEO cable (yellow) instead of the S VIDEO cable.

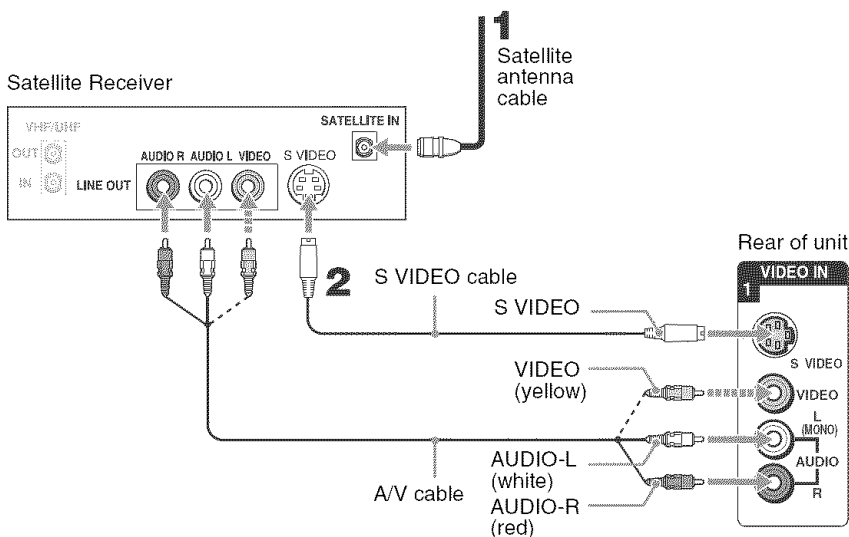

Notes on Using This Connection

To Do This ...	Do This ...
Watch the satellite receiver	Press V1 or V2 on the remote control. or Press INPUT on the top panel repeatedly to select the satellite receiver input (Video 1 or 2).
Label video inputs to easily identify equipment connected to the unit	See the instructions for setting up Label Video Inputs on page 40.

VCR and Cable

This scenario shows a VCR with Cable signals connected through the video inputs. The Cable or VCR signals are selected by the VCR through the video inputs.

To connect the VCR and cable

- 1 Connect the CATV cable to the VCR's VHF/UHF input jack.
- 2 Use an A/V and S VIDEO cables to connect the VCR's AUDIO and S VIDEO output jacks to the unit's AUDIO and S VIDEO input jacks (VIDEO 1 or 2).

 If your VCR is not equipped with S VIDEO, use a VIDEO cable (yellow) instead of the S VIDEO cable.

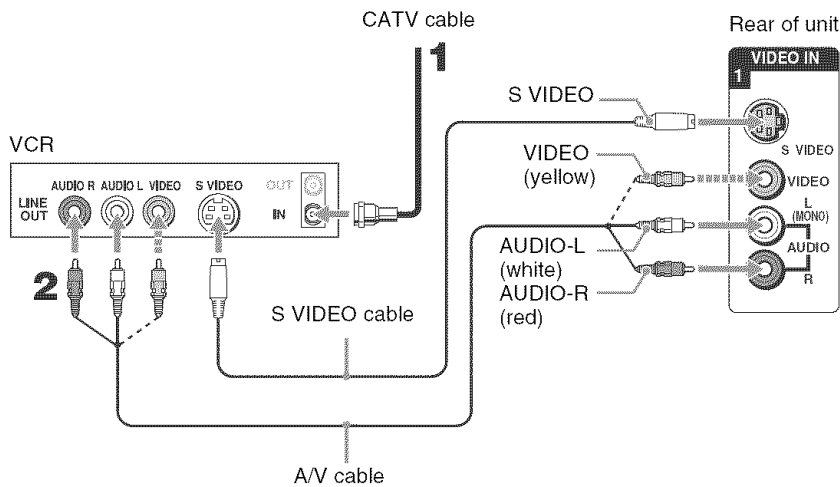

Notes on Using This Connection

To Do This ...

Watch the VCR or cable channels

Do This ...

Press **V1** or **V2** on the remote control.
or
Press **INPUT** on the top panel repeatedly to select the VCR input (VIDEO 1 or 2).

Label video inputs to easily identify equipment connected to the unit

See the instructions for setting up Label Video Inputs on page 40.

HD Equipment

💡 If your equipment has an HDMI or DVI connector, see page 24.

Disconnect all power sources before making any connections.

1 Using a component video cable, connect your equipment's YPBPR output jacks to the unit's YPBPR input jacks. Use the HD/DVD IN 3 connections.

🔗 Component video (YPBPR) connection is necessary to view 480p, 720p, and 1080i formats. Note that this unit displays all format types of picture in a resolution 1,366 dots × 768 lines.

2 Using an audio cable, connect your equipment's AUDIO output jacks to the unit's AUDIO input jacks.

🔗 The YPBPR jacks do not provide audio, so audio cables must be connected to provide sound.

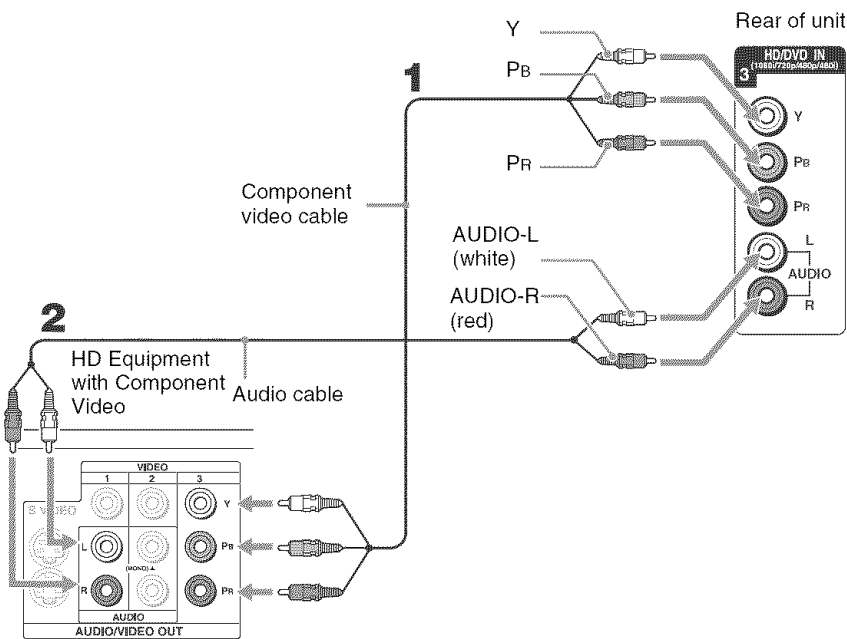

🔗 Some of the HD equipment you can connect to receive the broadcasting signals are digital cable box, digital satellite receiver and digital TV receiver.



Notes on Using This Connection

<i>To Do This ...</i>	<i>Do This ...</i>
Watch the HD equipment	Press V3 on the remote control. or Press INPUT on the top panel repeatedly to select the HD equipment input (Video 3).
Label video inputs to easily identify equipment connected to the unit	See the instructions for setting up Label Video Inputs on page 40.

DVD Player

For best results, use this connection if your DVD player has component video (YPbPr) jacks.

To connect a DVD player with component video connectors

- 1 Use a component video cable to connect the DVD player's YPbPr output jacks to the unit's YPbPr input jacks (HD/DVD IN 3).
 - 2 Use an audio cable to connect the DVD player's AUDIO output jacks to the unit's AUDIO input jacks (HD/DVD IN 3).
-  The YPbPr jacks on your DVD player are sometimes labeled Y, CB and CR, or Y, B-Y and R-Y. If so, connect the cables to their matching color jacks.
-  The YPbPr jacks do not provide audio, so audio cables must be connected to provide sound.

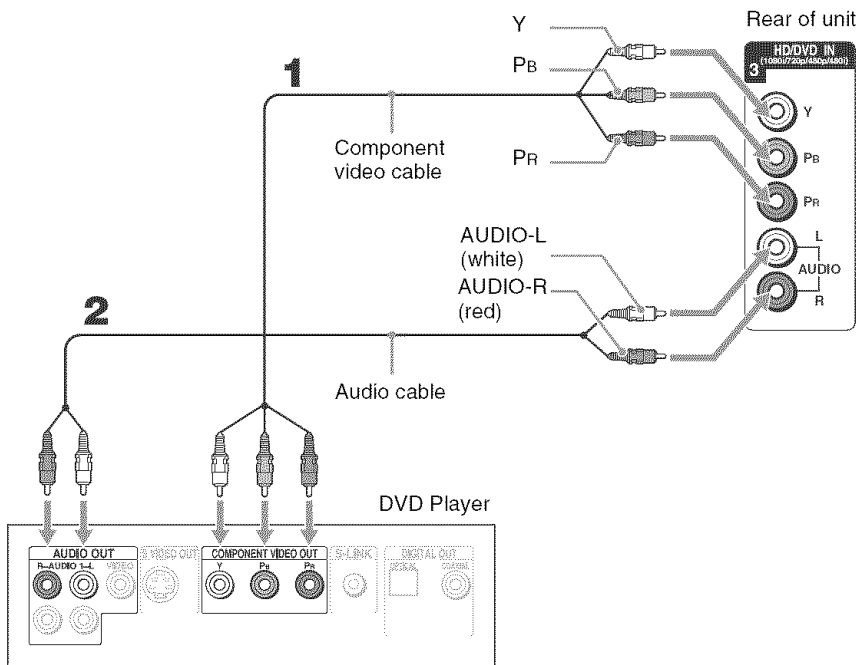

Notes on Using This Connection

To Do This ...	Do This ...
Watch the DVD player	Press V3 on the remote control. or Press INPUT on the top panel repeatedly to select the DVD player input (Video 3).
Label video inputs to easily identify equipment connected to the unit	See the instructions for setting up Label Video Inputs on page 40.

To connect a DVD player with S VIDEO and audio connectors

If your DVD player does not have component video (YPbPr) jacks, or the component video inputs are already connected to another device, use this connection.

- 1** Use an S VIDEO cable to connect the DVD player's S VIDEO output jack to the unit's S VIDEO input jack (VIDEO 1 or 2).
- 2** Use an audio cable to connect the DVD player's AUDIO output jacks to the unit's AUDIO input jacks (VIDEO 1 or 2).

 If your DVD player is not equipped with S VIDEO, use a VIDEO cable (yellow) instead of the S VIDEO cable.

HDMI-Equipped Device

To connect a device with HDMI connector

Use an HDMI cable to connect the device's HDMI output connector to the unit's HDMI IN connector on the rear panel.

- ⚡ HDMI cables transmit both audio and video signals. (Separate audio cables are not necessary.) You can purchase HDMI cables at your local electronics store.
- ⚡ Do not connect a PC to the unit's HDMI input. Use the PC IN (RGB) connector instead when connecting a PC.

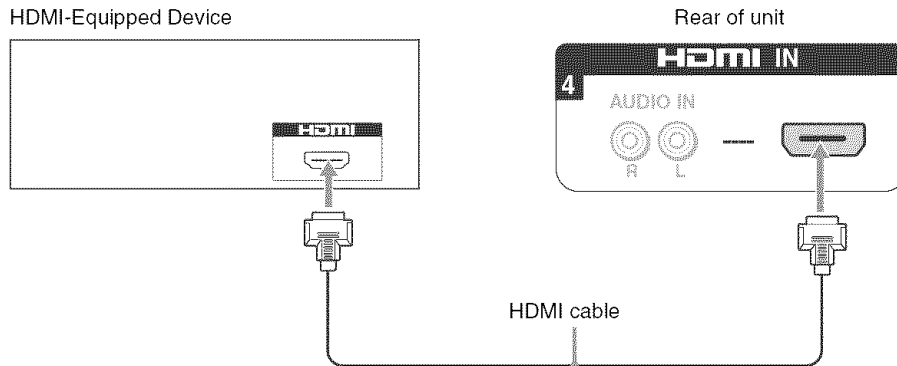

Notes on Using This Connection

To Do This ...	Do This ...
Watch the device	Press V4 on the remote control. or Press INPUT on the top panel repeatedly to select the HDMI-equipped device input (Video 4).
Label video inputs to easily identify equipment connected to the unit	See the instructions for setting up Label Video Inputs on page 40.

DVI-HDTV-Equipped Device

To connect a device with DVI-HDTV connector

If the device does not have an HDMI connector, you can connect the unit's HDMI IN connector to the device's DVI-HDTV output connector using a DVI to HDMI adapter or cable.

- 1 Use a DVI to HDMI adapter or cable to connect the device's DVI-HDTV output connector to the unit's HDMI IN connector on the rear panel.
 - ⚠ The DVI-HDTV VIDEO connector does not provide audio, so audio cables must be connected to provide sound when a DVI to HDMI adapter or cable is used.
 - ⚠ Do not connect a PC to the unit's HDMI input. Use the PC IN (RGB) connector instead when connecting a PC.
- 2 Use an Audio cable to connect the device's AUDIO output jacks to the unit's AUDIO input jacks on the rear panel.

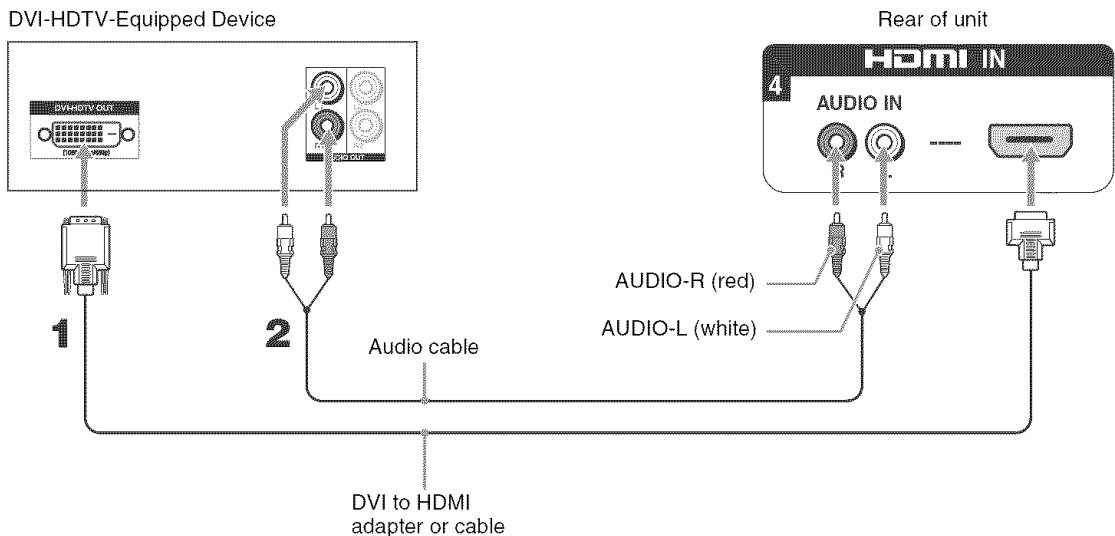

Notes on Using This Connection

To Do This ...

Watch the device

Do This ...

Press **V4** on the remote control.

or

Press **INPUT** on the top panel repeatedly to select the DVI-HDTV-equipped device input (Video 4).

Label video inputs to easily identify equipment connected to the unit

See the instructions for setting up Label Video Inputs on page 40.

Personal Computer

To connect a PC (personal computer)

If you connect your PC to the unit, you can watch your personal computer's display on the unit.

When your PC is connected to the unit with the supplied HD15-HD15 cable and optional audio cable, you can view and listen to the PC's video and audio output on the unit.

💡 When connecting to an Apple Macintosh computer, use the supplied HD15-HD15 cable to connect PC IN of the unit to video output connector of the computer. For some Apple Macintosh computers, it may be necessary to use an adapter (not supplied). If this is the case, connect the adapter to the computer before connecting the supplied HD15-HD15 cable.

💡 If the picture is noisy, flickering or not clear, adjust the Phase and Pitch in the PC Screen settings on page 39.

💡 When no signal is input to VIDEO 5, the PC enters standby mode and the STANDBY LED lights in red. The PC will exit standby mode when signal is input. The power turns off when you press the power button in standby mode. To turn it on, press the power button again. It is recommended to select Skip in Video 5 of Label Video Inputs in the Setup settings when no PC is connected.

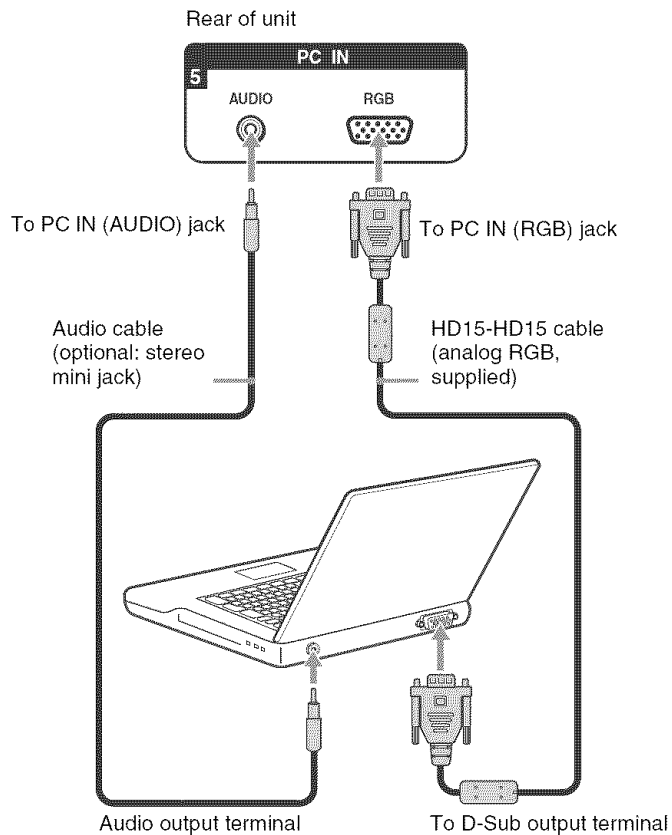

Notes on Using This Connection

To Do This ...	Do This ...
Watch the PC	Press V5 on the remote control.
	or
	Press INPUT on the top panel repeatedly to select the PC input (Video 5).
Label video inputs to easily identify equipment connected to the unit	See the instructions for setting up Label Video Inputs on page 40.

Camcorder or Video Game Equipment

You can connect a camcorder or video game equipment to your unit's rear A/V input jacks.

To connect a camcorder or video game equipment

Use an A/V and S VIDEO cables to connect the camcorder or video game equipment AUDIO and S VIDEO output jacks to the unit's AUDIO and S VIDEO input jacks (VIDEO 1 or 2) on the rear of panel.

- ⚡ If your camcorder is not equipped with S VIDEO, use a VIDEO cable (yellow) instead of the S VIDEO cable.
- ⚡ If you have a mono camcorder, connect its audio output jack to the unit's L MONO audio input jack.

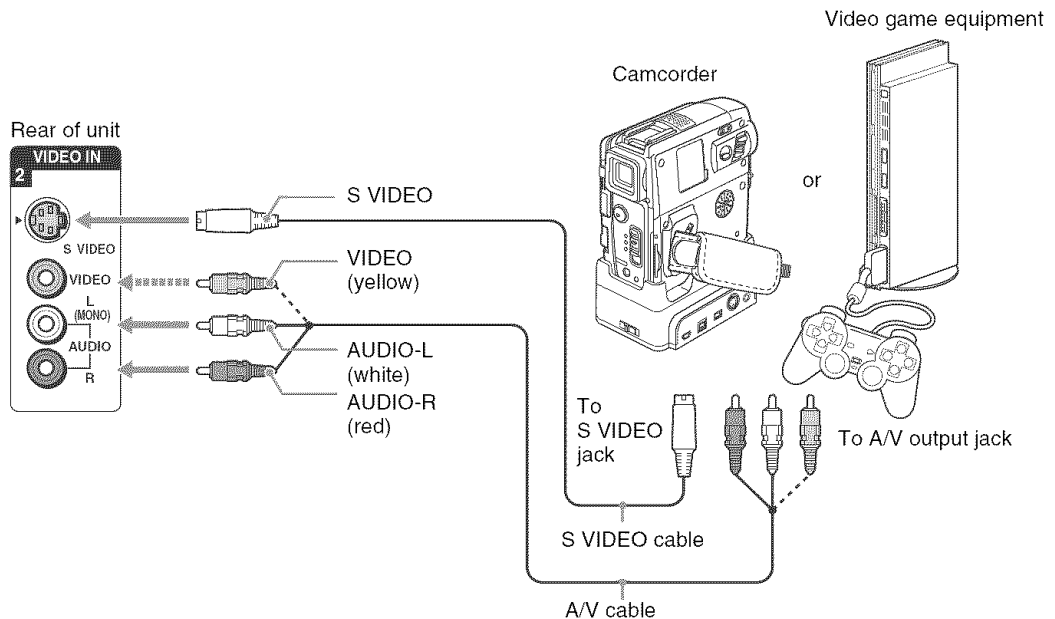

Notes on Using This Connection

To Do This ...	Do This ...
Watch the camcorder or video game equipment	Press V1 or V2 on the remote control. or Press INPUT on the top panel repeatedly to select the camcorder or game input (Video 1 or 2).
Label video inputs to easily identify equipment connected to the unit	See the instructions for setting up Label Video Inputs on page 40.

Using the Unit

Button Descriptions

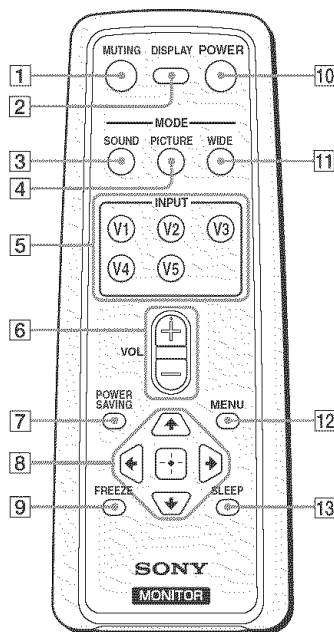

The VOL +/- button has a tactile dot. Use it as a reference when operating the unit.

Insert two size AA batteries (supplied) by matching the and on the batteries to the diagram inside the remote control's battery compartment.

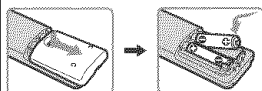

“Be sure to insert the first.”

Button	Description
1 MUTING	Press to mute the sound. Press again or press VOL + to restore the sound.
2 DISPLAY	Press once to display the current Video Input number and Wide Mode settings. The OSD (on screen display) will be canceled after a few seconds or press again to immediately cancel the display. If Sleep Timer is set, the remaining time for Sleep Timer can be displayed by pressing DISPLAY.
3 SOUND	Press repeatedly to cycle through the sound modes: Dynamic, Standard, SRS, Effect Off. The sound modes can be also accessed in the Sound settings. See “Selecting Sound Options” on page 35.
4 PICTURE	Press repeatedly to cycle through the available picture modes: Vivid, Standard, Custom. The picture modes can be also accessed in the Picture settings. See “Selecting Picture Options” on page 33.
5 INPUT V1 to V5	Press to select the external equipment connected to the unit's inputs. See page 40 on setting up the video input labels, including skip function.
6 VOL +/-	Press to adjust the volume.
7 POWER SAVING	Press repeatedly to cycle through the power saving modes: Off, Low, High, Picture Off. The power saving modes can be also accessed in the Setup settings. See Power Saving on page 41.
8	Press /// to move the on-screen cursor. To select an item, press .
9 FREEZE	Press to freeze the picture. The current program appears in the sub screen when freeze is selected. Press repeatedly to restore the picture. You can use this feature to write down information such as phone numbers, recipes, etc. Some functions will not be available in freeze.
10 POWER	Press to turn on and off the unit.
11 WIDE	Press repeatedly to cycle through the wide screen mode settings: Wide Zoom, Normal, Full, Zoom. The wide screen mode settings can be also accessed in the Screen settings. See “Selecting Screen Options” on page 36.
12 MENU	Press to navigate to unit functions. See “Using the Settings” on page 32.
13 SLEEP	Press repeatedly until the unit displays the time in minutes (15, 30, 45, 60, 90 or 120) that you want the unit to remain on before shutting off. To cancel Sleep Timer, press SLEEP repeatedly until Sleep Timer : Off appears.

Special Buttons on the Remote Control

Using the Wide Screen Mode

You can change the wide screen mode settings.

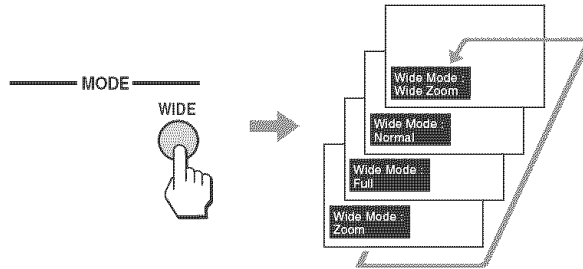

Changing the wide screen mode

💡 You can also access the Wide Mode settings in the Screen settings. For details, see page 36.

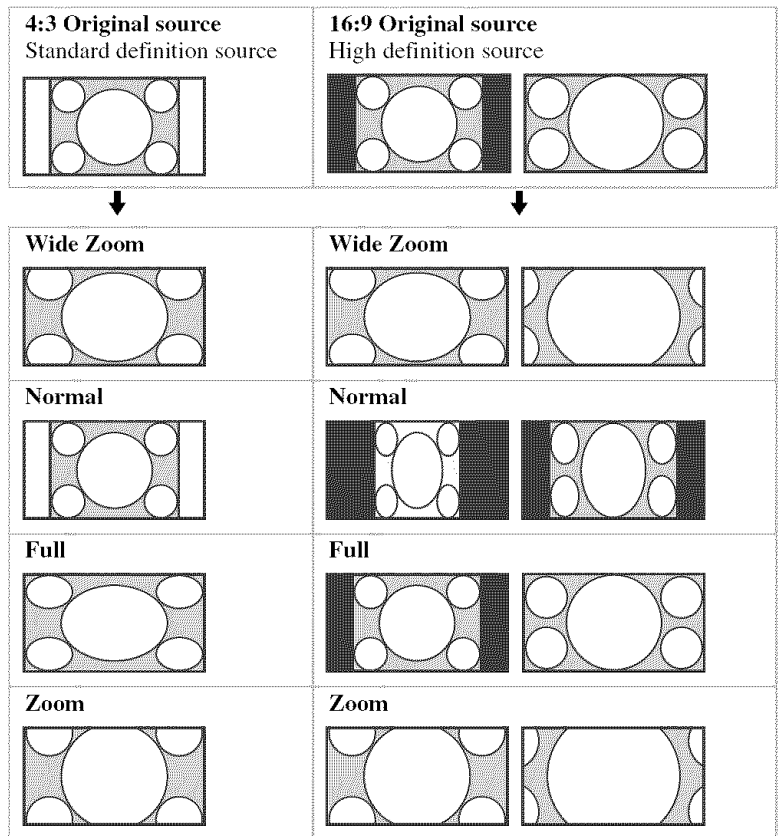

Using the Freeze Function

- While the picture is frozen, the sound continues to be output normally.
- The wide format signal will be squeezed in the sub screen.

You can use this feature to write down information such as phone numbers, recipes, etc. When you press the button once, the current screen is frozen and the sub screen appears. When you press the button again, only the frozen screen is displayed; when you press it a third time, the normal screen returns.

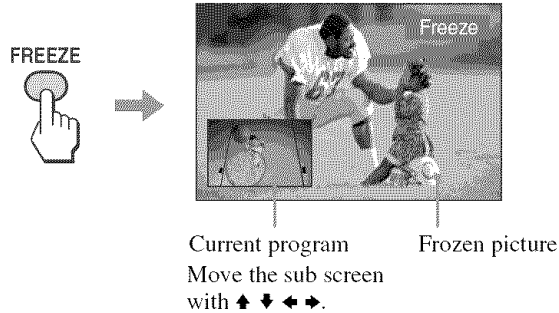

To cancel the Freeze function mode

Press FREEZE until the normal screen appears.

With Freeze function active, some functions are unavailable, such as MENU.

Using the Power Saving Function

- If you turn off the unit when the Power Saving mode is on, the mode stays on next time you turn on the unit except Picture Off.
- You can set the Power Saving mode to on using the settings screen. Select Power Saving in the Setup settings, then set it to Off, Low or High.
- When Picture Off is selected, the PIC OFF/TIMER LED lights in green.

You can reduce the power consumption of the unit.

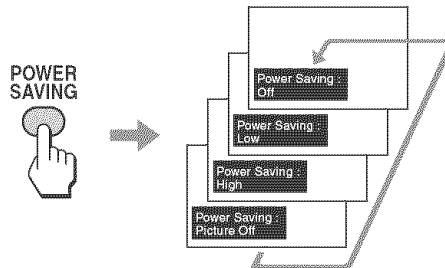

To cancel the Power Saving mode

Press POWER SAVING repeatedly until “Power Saving: Off” appears.

Using the Sleep Function

- 💡 If you turn the unit off, and then turn it on again, Sleep Timer returns to "Sleep Timer : Off."
- 💡 "Sleep Timer: Power will be turned off" appears one minute before the unit shuts off. This message may not appear if you are performing other operations in the settings.
- 💡 You can set Sleep Timer to on using the Setup settings. Select Sleep Timer in the Setup settings, then set it to 15 min, 30 min, 45 min, 60 min, 90 min, 120 min or Off.

You can set the unit to turn off automatically after a predetermined period of time (15, 30, 45, 60, 90 or 120 minutes).

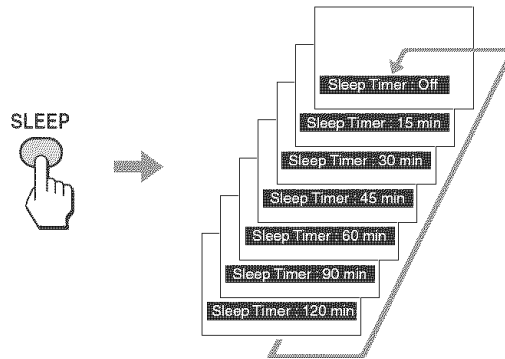

While Sleep Timer is activated, the PIC OFF/TIMER LED on the unit lights up in orange.

To cancel Sleep Timer

Press SLEEP repeatedly until "Sleep Timer : Off" appears or turn the unit power to off then turn on the unit again.

Using the Settings

Overview of the Settings

The Settings provides you access to the following features:

Settings

Allows you to set/change

Picture

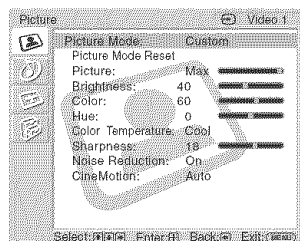

- Picture Mode (page 33)
- Picture Mode Reset (page 33)
- Picture (page 33)
- Brightness (page 33)
- Color (page 33)
- Hue (page 33)
- Color Temperature (page 33)
- Sharpness (page 33)
- Noise Reduction (page 33)
- CineMotion (page 33)

Sound

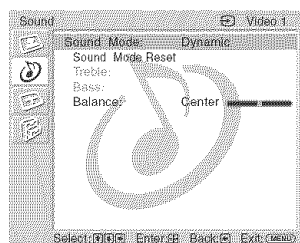

- Sound Mode (page 35)
- Sound Mode Reset (page 35)
- Treble (page 35)
- Bass (page 35)
- Balance (page 35)

Screen

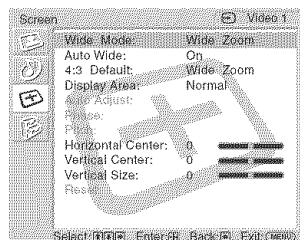

- Wide Mode (page 36)
- Auto Wide (page 36)
- 4:3 Default (page 36)
- Display Area (page 37)
- Auto Adjust (page 38)
- Phase (page 38)
- Pitch (page 38)
- Horizontal Center (page 37)
- Vertical Center (page 37)
- Vertical Size (page 37)
- Reset (page 38)

Setup

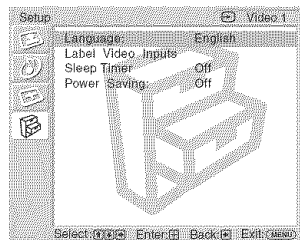

- Language (page 40)
- Label Video Inputs (page 40)
- Sleep Timer (page 40)
- Power Saving (page 41)

* Buttons displayed at the bottom of the screen may not work, depending on settings.

Using the Picture Settings



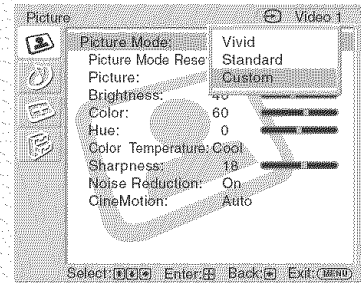

To select the Picture settings

1. Press MENU
2. Press \uparrow \downarrow to highlight Picture
3. Press \leftarrow or \rightarrow to select



To exit the Picture settings, press MENU.

Selecting Picture Options

-  To change from one Picture Mode to another, use PICTURE on the remote control.
-  You can alter the Picture Mode options (Vivid, Standard, Custom) for each video input.
-  You can alter the Picture settings (Picture, Brightness, Color, etc.) for each Mode.
-  Color, Hue, Sharpness, Noise Reduction and CineMotion are not available for PC input.

The Picture settings includes the following options:

To highlight an option and to change settings, press \uparrow \downarrow \leftarrow \rightarrow .

Press \leftarrow to confirm the selection.

Option	Description
Picture Mode <i>Customized picture viewing</i>	<p>Vivid Select for enhanced picture contrast and sharpness.</p> <p>Standard Select for standard picture settings. Recommended for home entertainment.</p> <p>Custom Select for professional unit like appearance settings.</p>
Picture Mode Reset	Reset all settings and adjustments to the default setting for each Picture Mode (Vivid, Standard, Custom) (except for the options grayed out).
Picture	Adjust to increase or decrease picture contrast.
Brightness	Adjust to brighten or darken the picture.
Color	Adjust to increase or decrease color intensity.
Hue	Adjust to increase or decrease the green tones.
Color Temperature <i>White adjustment</i>	<p>Cool Select to give the white colors a blue tint.</p> <p>Neutral Select to give the white colors a neutral tint.</p> <p>Warm Select to give the white colors a red tint.</p>
Sharpness	Adjust to sharpen or soften the picture.
Noise Reduction	Select to reduce the noise level of connected equipment. Select from On and Off.
CineMotion	Select Auto to optimize the screen display automatically detecting film content and applying a reverse 3-2 pull down process. Moving picture will appear clearer and more natural looking. Select Off to disable the detection.

(Continued)

Selecting PC Picture Options

To display the PC screen:

Press V5 on the remote control, or press INPUT repeatedly on the top panel until Video 5 (PC) appears.

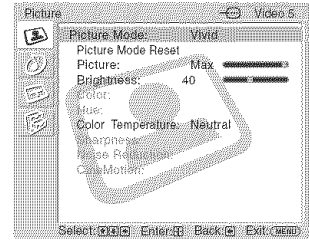

 You can change the settings for the PC input while the unit is displaying the PC screen.

The PC Input Picture setting includes the following options:

Option	Description
Picture Mode <i>Customized picture viewing</i>	Vivid Select for enhanced picture contrast and sharpness.
	Standard Select for standard picture settings. Recommended for home entertainment.
	Custom Select for professional unit like appearance settings.
Picture Mode Reset	Reset all settings and adjustments to the default setting for each Picture Mode (Vivid, Standard, Custom) (except for the options grayed out).
Picture	Adjust to increase or decrease picture contrast.
Brightness	Adjust to brighten or darken the picture.
Color Temperature	Cool Select to give the white colors a blue tint.
	Neutral Select to give the white colors a neutral tint.
	Warm Select to give the white colors a red tint.

Using the Sound Settings

To select the Sound settings

1. Press MENU
2. Press \uparrow \downarrow to highlight Sound
3. Press \leftarrow or \rightarrow to select

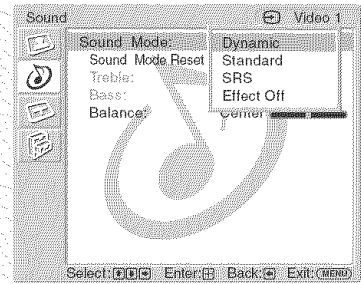

To exit the Sound settings, press MENU.

Selecting Sound Options

To change from one Sound Mode option to another, use SOUND on the remote control.

The Sound settings includes the following options:

To highlight an option and to change settings, press \uparrow \downarrow \leftarrow \rightarrow .

Press \leftarrow to confirm the selection.

Option	Description
Sound Mode	Dynamic
<i>Customized sound listening</i>	Standard
	SRS
	Effect Off
Sound Mode Reset	Reset the following settings; Treble, Bass and Balance to the default setting.
Treble*	Adjust to increase or decrease higher-pitched sounds.
Bass*	Adjust to increase or decrease lower-pitched sounds.
Balance	Adjust to emphasize left or right speaker balance.

* Available when Effect Off is selected in Sound Mode.

Using the Screen Settings

To select the Screen settings

1. Press MENU
2. Press $\uparrow \downarrow$ to highlight Screen
3. Press $\left[\right]$ or \rightarrow to select

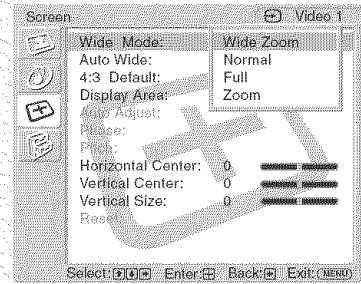

To exit the Screen settings, press MENU.

Selecting Screen Options

The Screen settings includes the following options:

To highlight an option and to change settings, press $\uparrow \downarrow \leftarrow \rightarrow$.

Press $\left[\right]$ to confirm the selection.

- To change from one Wide Mode option to another, use WIDE on the remote control.
- Select Zoom in the Wide Mode option to display movies and other content on DVD, using the entire viewable area of the screen.
- For Wide Zoom and Zoom modes, you can adjust the vertical position of the picture. For details, see page 37.
- 4:3 Default functions only when the unit receives 480i or 480p signals.
- If 4:3 Default option is set to anything but Off, the Wide Mode setting changes only for the current input. When you change inputs, Wide Mode is automatically replaced with the 4:3 Default setting for 4:3 sources. To retain the current Wide Mode setting as inputs are changed, set 4:3 Default to Off.

Option	Description	
Wide Mode <i>Select a Wide Mode to use for 4:3 sources</i>	Wide Zoom	Select to enlarge to fill screen with minimum distortion.
	Normal	Select to display 4:3 picture in original size when the original source is 4:3 (Standard definition source).
	Full	Select to enlarge the original picture horizontally to fill the screen when the original source is 4:3 (Standard definition source). When the original source is 16:9 (High definition source), select this mode to display 16:9 picture in original size.
	Zoom	Select to enlarge the original picture without distorting the aspect ratio.
Auto Wide	On	Select to detect the image and change it automatically to the appropriate screen mode.
	Off	The screen mode does not change automatically.
4:3 Default <i>Select the default Screen Mode to use for 4:3 sources</i>	Wide Zoom	Select to enlarge the 4:3 picture to fill the 16:9 screen, keeping the original image as much as possible.
	Normal	Select to return the 4:3 picture to its original size.
	Full	Select to enlarge the 4:3 picture horizontally only, to fill the 16:9 screen.
	Zoom	Select to enlarge the 4:3 picture horizontally and vertically to an equal aspect ratio that fills the 16:9 screen. Useful for watching Letterbox movies.
Off	Select to continue using the current Wide Screen Mode setting when the input is changed.	

💡 Auto Wide, 4:3 Default, Display Area and Vertical Size are not available for PC Input.

💡 Horizontal Center feature is useful if unit is connected to game equipment.

Option	Description	
Display Area	Normal -1/-2	Displays a standard size picture. Allows you to adjust the viewable picture area size. This is useful for viewing ticker tape or banners at the top or bottom of the screen.
Horizontal Center	Allows you to move the position of the picture left and right in the window. This function allows for horizontal adjustment of the picture being displayed. (Available only in Wide Zoom and Zoom modes.)	
Vertical Center	Allows you to move the position of the picture up and down in the window. Available only in Wide Zoom and Zoom modes. Press ▲/▼ and press ⊞ to choose a correction.	
Vertical Size	Allows you to adjust the vertical size of the picture. (Available only in Wide Zoom and Zoom modes.) Press ▲/▼ and press ⊞ to choose correction.	

(Continued)

Selecting PC Screen Options

To display the PC screen:

Press V5 on the remote control, or press INPUT repeatedly on the top panel until Video 5 (PC) appears.

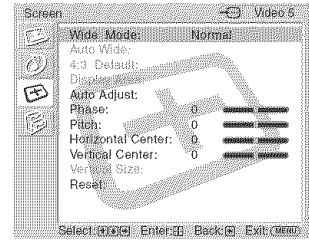

You can change the settings for the PC input while the unit is displaying the PC screen.



The PC Input Screen setting includes the following options:

Option	Description
Wide Mode	Normal Select to display the picture in its original size. A black frame will appear on the surrounding of the picture.
	Full 1 Select to enlarge the picture to fill the display area, keeping its original horizontal-to-vertical aspect ratio. A black frame will appear on the surrounding of the picture.
	Full 2 Select to enlarge the picture to fill the display area.
Auto Adjust	Select to automatically adjust the display position and phase of the picture when the unit receives an input signal from the connected PC. Note that Auto Adjust may not work well with certain input signals. In such cases, manually adjust the options below.
Phase	Select to adjust the phase when the screen flickers.
Pitch	Select to adjust the pitch when the picture has unwanted vertical stripes.
Horizontal Center	Select to adjust the horizontal position of the picture. Allows you to move the picture left and right in the window. Press and press to choose a correction.
Vertical Center	Select to adjust the vertical position of the picture. Allows you to move the picture up and down in the window. Press and press to choose a correction.
Reset	Clear Phase, Pitch, Horizontal Center and Vertical Center adjustments you made to the factory settings.

PC Input Signal Compatibility Chart

Resolution Signals	Horizontal (Pixel)	×	Vertical (Line)	Horizontal frequency (kHz)	Vertical frequency (Hz)	VESA standard
VGA	640	×	480	31.5	60	—*
	640	×	480	37.9	72	✓
	640	×	480	37.5	75	✓
	720	×	400	31.5	70	—*
SVGA	800	×	600	35.2	56	✓
	800	×	600	37.9	60	✓
	800	×	600	46.9	75	✓
	800	×	600	48.1	72	✓
	848	×	480	31.0	60	✓
XGA	1024	×	768	48.4	60	✓
	1024	×	768	56.5	70	✓
	1024	×	768	60	75	✓
WXGA	1280	×	768	47.4	60	✓
	1280	×	768	47.8	60	✓
	1280	×	768	60.3	75	✓
	1360	×	768	47.7	60	✓

*: Corresponding to the VGA signal

-  This unit does not support Sync on Green or Composite Sync.
-  If a signal other than in the above chart is input, it may not be displayed properly or may not be displayed as you set.
-  Using the Vertical frequency (Hz) of the personal computer at 60 is recommended.

Using the Setup Settings

To select the Setup settings

1. Press MENU
2. Press \uparrow/\downarrow to highlight Setup
3. Press \leftarrow/\rightarrow or \leftarrow/\rightarrow to select

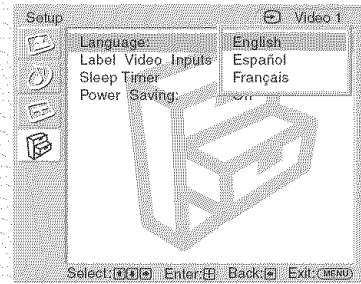

To exit the Setup settings, press MENU.

Selecting Setup Options

The Setup settings includes the following options:

To highlight an option and to change settings, press $\uparrow/\downarrow/\leftarrow/\rightarrow$.

Press \leftarrow/\rightarrow to confirm the selection.

Option	Description						
Language	Select to display all on-screen Settings in your language of choice: English, Español, Français.						
Label Video Inputs	<p>Allows you to identify A/V equipment you connected to the unit, such as a VCR, DVD, etc. For example, if you have a DVD player connected to the VIDEO 3 jack, you can select the label DVD for the VIDEO 3 input. Then when you press V3 on the remote control or press INPUT repeatedly on the top panel to select Video 3, the video label you assigned to that input appears on the screen.</p> <ol style="list-style-type: none"> 1 Press \uparrow/\downarrow to highlight the video input (VIDEO 1-5) to which you want to assign a label. Then press \leftarrow/\rightarrow to select the input. 2 Press \uparrow/\downarrow to highlight one of the displayed labels. Then press \leftarrow/\rightarrow to select the label. <p>You can select from the following labels for each input:</p> <table border="1"> <tr> <td>Video 1-2</td> <td>Video 1-2, VHS, DVD, Satellite, Cable Box, 8mm, Game, Skip</td> </tr> <tr> <td>Video 3-4</td> <td>Video 3-4, VHS, DVD, Satellite, Cable Box, Game, Skip</td> </tr> <tr> <td>Video 5</td> <td>Video 5, PC, Skip</td> </tr> </table> <p> If you select Skip, your unit skips this input when you press INPUT on the top panel.</p>	Video 1-2	Video 1-2, VHS, DVD, Satellite, Cable Box, 8mm, Game, Skip	Video 3-4	Video 3-4, VHS, DVD, Satellite, Cable Box, Game, Skip	Video 5	Video 5, PC, Skip
Video 1-2	Video 1-2, VHS, DVD, Satellite, Cable Box, 8mm, Game, Skip						
Video 3-4	Video 3-4, VHS, DVD, Satellite, Cable Box, Game, Skip						
Video 5	Video 5, PC, Skip						
Sleep Timer	Set the time in minutes (15 minutes, 30 minutes, 45 minutes, 60 minutes, 90 minutes, 120 minutes, or Off) that you want the unit to remain on before shutting off automatically.						

The Skip label is useful for inputs to which no equipment is connected.

💡 To change from one Power Saving option to another, use POWER SAVING on the remote control.

<i>Option</i>	<i>Description</i>
Power Saving	Off Select to view picture without the benefit of Power Saving.
	Low/High Select to view picture with reduced power consumption. It also enhances the black level.
	Picture Off Select to turn off the picture. Audio stays on with your selected volume setting.

Other Information

Troubleshooting

Problem	Possible Remedies
No picture.	
No picture.	<input type="checkbox"/> Check Power Saving settings (page 41).
The unit turns off automatically.	<input type="checkbox"/> Check if Sleep Timer is activated (pages 31, 40).
No picture from some video sources.	<input type="checkbox"/> Check the connection between the video equipment and the unit. <input type="checkbox"/> Press V1 to V5 on the remote control (page 28) or press INPUT repeatedly on the top panel (page 13).
Poor picture.	
No color/Dark picture/The picture is too bright/Color is not correct	<input type="checkbox"/> Press PICTURE to select the desired Picture mode (pages 28). <input type="checkbox"/> Adjust the Picture Mode options in the Picture settings (page 33).
Noisy picture.	<input type="checkbox"/> Keep the set-top box/VCR antenna cable away from other connecting cords. <input type="checkbox"/> Do not use 300-ohm twin lead cables as interference may occur.
No sound/Noisy sound.	
Good picture, no sound.	<input type="checkbox"/> Check the volume control. <input type="checkbox"/> Press MUTING or VOL + so that "Muting" disappears from the screen (page 28). <input type="checkbox"/> Disconnect your headphones.
Audio noise.	<input type="checkbox"/> Keep the set-top box/VCR antenna cable away from other connecting cords.
Striped noise during playback/recording of a VCR.	<input type="checkbox"/> This is caused by video head interference. Keep your VCR away from the unit. <input type="checkbox"/> Leave a space of 30 cm (11 7/8 inches) between your VCR and the unit to avoid noise. <input type="checkbox"/> Avoid installing your VCR in front of the unit or at the side of the unit.
Wide Screen Mode changes automatically.	<input type="checkbox"/> The current Wide Screen Mode setting is automatically replaced with the 4:3 Default setting when you change the video input, if 4:3 Default in the Screen settings is set to other than Off. If you want to lock in the Wide Screen Mode selected with the WIDE button, set 4:3 Default to Off in the Screen settings (page 36).
Remote control does not operate.	<input type="checkbox"/> Check the polarity of the batteries or replace the batteries. <input type="checkbox"/> Point the remote control at the remote control sensor of the unit. <input type="checkbox"/> Fluorescent lamps can interfere with remote control operation; try turning off the fluorescent lamps. <input type="checkbox"/> Keep the remote control sensor area clear from obstacles.

Contacting Sony

If, after reading the following instructions, you have additional questions related to the use of your Sony[®] unit, please call one of the following numbers.

Customers in the continental United States contact the Direct Response Center at:

1-800-222-SONY (7669)

or visit <http://www.sony.com/TVsupport>

Customers in Canada contact the Customer Relations Center at:

1-877-899-SONY (7669)

or visit <http://www.sony.com/TVsupport>

Other Information

Specifications

Screen size (measured diagonally):

KLV-32U100M: 32 inches
KLV-40U100M: 40 inches

Panel System:

LCD (Liquid Crystal Display) Panel

Display resolution (horizontal × vertical):

1,366 dots × 768 lines

VIDEO IN 1/2 (NTSC Video Standard):

S VIDEO (4-pin mini DIN):

Y: 1.0 Vp-p, 75 ohms unbalanced, sync negative
C: 0.286 Vp-p (Burst signal), 75 ohms
1 Vp-p, 75 ohms unbalanced, sync negative
AUDIO: 500 mVrms (100% modulation)
Impedance: 47 kilohms

VIDEO:

AUDIO:

HD/DVD IN 3:

YPbPr (Component Video):

Y: 1.0 Vp-p, 75 ohms unbalanced, sync negative
Pb: 0.7 Vp-p, 75 ohms
Pr: 0.7 Vp-p, 75 ohms
Signal format: 480i, 480p, 720p, 1080i

AUDIO:

500 mVrms (100% modulation)
Impedance: 47 kilohms

HDMI IN 4:

HDMI:

Video: 480i, 480p, 720p, 1080i
Audio: Two channel linear PCM 32, 44.1 and 48 kHz, 16, 20 and 24 bits

AUDIO:

500 mVrms (100% modulation)
Impedance: 47 kilohms

PC IN 5:

D-sub 15-pin, analog RGB, 0.7 Vp-p, 75 ohms, positive
See the PC Input Signal Compatibility Chart on page 39

PC AUDIO INPUT:

Stereo mini jack, 500m Vrms, 47 kilohms

Headphones:

Stereo mini jack

Impedance: 16 ohms

Speaker:

Full range: 4 × 20 cm (1⁵/₈ × 7⁷/₈ inches) (2)

Speaker output:

10 W + 10 W

Power requirement:

120 V AC, 60 Hz

Power consumption:

In use: KLV-32U100M: 150 W

KLV-40U100M: 220 W

In standby: Less than 1 W

Dimensions (W/H/D):

KLV-32U100M: (with stand) 798 × 580 × 220 mm

(31¹/₂ × 22⁷/₈ × 8³/₄ inches)

(without stand) 798 × 548 × 120 mm

(31¹/₂ × 21⁵/₈ × 4³/₄ inches)

KLV-40U100M: (with stand) 989 × 685 × 270 mm

(39 × 27 × 10³/₄ inches)

(without stand) 989 × 653 × 127 mm

(39 × 25³/₄ × 5 inches)

Mass:

KLV-32U100M: (with stand) 17.5 kg (38 lb. 10 oz.)

(without stand) 15.5 kg (34 lb. 3 oz.)

KLV-40U100M: (with stand) 29 kg (63 lb. 15 oz.)

(without stand) 25 kg (55 lb. 2 oz.)

Supplied accessories:

Remote control RM-YA004 (1)

Size AA batteries (2)

AC power cord (1)

HD15-HD15 cable (1)

Support belt (1), securing screw (1) and wood screw (1)

Operating Instructions (1)

Quick Setup Guide (1)

Leaflet (Installing the Wall-Mount Bracket, KLV-32U100M only) (1)

Warranty Card (1)

Optional accessories:

Headphones plug adaptor

Connecting cables

Wall-Mount Bracket SU-WL31 (KLV-32U100M)

SU-WL51 (KLV-40U100M)

 Select the desired mounting angle from 0, 5, 10 or 15 degrees for these models.

 Optional accessories' availability may depend on its stock.

Design and specifications are subject to change without notice.

Index

4:3 Default 36

A

AC IN 16

Auto Adjust 38

Auto Wide 36

B

Balance 35

Bass 35

Brightness 33, 34

C

CineMotion 10, 33

Color 33

Color Temperature 33, 34

Connections

 Camcorder or video game
 equipment 27

 DVD player 22

 DVI-HDTV-equipped device
 25

 HD equipment 20

 HDMI-equipped device 24

 Personal computer 26

 Satellite receiver 18

 VCR and cable 19

D

Display Area 37

DISPLAY button 28

F

Freeze 30

FREEZE button 28

H

HD/DVD IN jack (1080i/720p/
480p/480i) 15

HDMI IN jack 16

Headphones jack 13

High-Definition Multimedia
Interface (HDMI) 10

Horizontal Center 37, 38

Hue 33

I

Infrared Receiver (IR) 14

INPUT 13

INPUT button 28

L

Label Video Inputs 40

Language 40

M

MENU 13

MENU button 28

MUTING button 28

N

Noise Reduction 33

P, Q

PC IN 16

Phase 38

PIC OFF/TIMER LED 13

Picture 33, 34

PICTURE button 28

Picture Mode 33, 34

Picture Mode Reset 33, 34

Pitch 38

POWER button 13, 28

POWER LED 14

Power Saving 30, 41

POWER SAVING button 28

R

Reset 38

S

S VIDEO jack 15

Settings

 Picture 32, 33

 Screen 32, 36

 Setup 32, 40

 Sound 32, 35

Sharpness 33

Sleep 31

SLEEP button 28

Sleep Timer 40

SOUND button 28

Sound Mode 35

Sound Mode Reset 35

STANDBY LED 14

Support Belt 11

T, U

Treble 35

Troubleshooting 42

turning on/off the unit 13

V

Vertical Center 37, 38

Vertical Size 37

VIDEO/AUDIO (L/R) jacks 15

VOL button 13, 28

W, X, Y

WIDE button 28

Wide Mode 36, 38

Wide Screen Mode 10, 29



<http://www.sony.net/>

Printed in China