

LC-45GD5U

LIQUID CRYSTAL TELEVISION

ENGLISH

OPERATION MANUAL

- The illustrations and on-screen displays in this operation manual are for explanation purposes and may vary slightly from the actual operations.
- Menu items that are not selectable are grayed out.

IMPORTANT:

To aid reporting in case of loss or theft, please record the TV's model and serial numbers in the space provided. The numbers are located at the rear of the TV.

Model No.:

Serial No.:

IMPORTANT INFORMATION

WARNING: TO REDUCE THE RISK OF FIRE OR ELECTRIC SHOCK, DO NOT EXPOSE THIS PRODUCT TO RAIN OR MOISTURE.



CAUTION

RISK OF ELECTRIC SHOCK
DO NOT OPEN



CAUTION: TO REDUCE THE RISK OF ELECTRIC SHOCK,
DO NOT REMOVE COVER (OR BACK).
NO USER-SERVICEABLE PARTS INSIDE.
REFER SERVICING TO QUALIFIED SERVICE
PERSONNEL.



The lightning flash with arrow-head symbol, within an equilateral triangle, is intended to alert the user to the presence of uninsulated "dangerous voltage" within the product's enclosure that may be of sufficient magnitude to constitute a risk of electric shock to persons.



The exclamation point within a triangle is intended to alert the user to the presence of important operating and maintenance (servicing) instructions in the literature accompanying the product.

IMPORTANT INFORMATION

CAUTION: TO PREVENT ELECTRIC SHOCK, MATCH WIDE BLADE OF PLUG TO WIDE SLOT, FULLY INSERT.

CAUTION:

DO NOT PLACE THIS PRODUCT ON AN UNSTABLE CART, STAND, TRIPOD, BRACKET, OR TABLE. THE PRODUCT MAY FALL CAUSING SERIOUS PERSONAL INJURY AND SERIOUS DAMAGE TO THE PRODUCT. USE ONLY WITH A CART, STAND, TRIPOD, BRACKET, OR TABLE RECOMMENDED BY THE MANUFACTURER OR SOLD WITH THE PRODUCT. FOLLOW THE MANUFACTURER'S INSTRUCTIONS WHEN INSTALLING THE PRODUCT AND USE MOUNTING ACCESSORIES RECOMMENDED BY THE MANUFACTURER. A PRODUCT AND CART COMBINATION SHOULD BE MOVED WITH CARE. QUICK STOPS, EXCESSIVE FORCE, AND UNEVEN SURFACES MAY CAUSE THE PRODUCT AND CART COMBINATION TO OVERTURN.



WARNING: FCC Regulations state that any unauthorized changes or modifications to this equipment not expressly approved by the manufacturer could void the user's authority to operate this equipment.

CAUTION:

This product satisfies FCC regulations when shielded cables and connectors are used to connect the unit to other equipment. To prevent electromagnetic interference with electric appliances such as radios and televisions, use shielded cables and connectors for connections.

DECLARATION OF CONFORMITY

SHARP LIQUID CRYSTAL TELEVISION, MODEL LC-45GD5U

This device complies with Part 15 of the FCC Rules. Operation is subject to the following two conditions: (1) This device may not cause harmful interference, and (2) this device must accept any interference received, including interference that may cause undesired operation.

RESPONSIBLE PARTY:

SHARP ELECTRONICS CORPORATION

Sharp Plaza, Mahwah, New Jersey 07430-2135

TEL: 1-800-BE-SHARP

For Business Customers: URL <http://www.sharppusa.com>

INFORMATION:

This equipment has been tested and found to comply with the limits for a Class B digital device, pursuant to Part 15 of the FCC Rules. These limits are designed to provide reasonable protection against harmful interference in a residential installation. This equipment generates, uses and can radiate radio frequency energy and, if not installed and used in accordance with the instructions, may cause harmful interference to radio communications. However, there is no guarantee that interference will not occur in a particular installation. If this equipment does cause harmful interference to radio or television reception, which can be determined by turning the equipment off and on, the user is encouraged to try to correct the interference by one or more of the following measures:

- Reorient or relocate the receiving antenna.
- Increase the separation between the equipment and receiver.
- Connect the equipment into an outlet on a circuit different from that to which the receiver is connected.
- Consult the dealer or an experienced radio/TV technician for help.

"Note to CATV system installer: This reminder is provided to call the CATV system installer's attention to Article 820-40 of the National Electrical Code that provides guidelines for proper grounding and, in particular, specifies that the cable ground shall be connected to the grounding system of the building, as close to the point of cable entry as practical."

This product utilizes tin-lead solder, and fluorescent lamp containing a small amount of mercury. Disposal of these materials may be regulated due to environmental considerations. For disposal or recycling information, please contact your local authorities or the Electronic Industries Alliance: www.eia.org

DEAR SHARP CUSTOMER

Thank you for your purchase of the Sharp Liquid Crystal Television. To ensure safety and many years of trouble-free operation of your product, please read the Important Safety Instructions carefully before using this product.

IMPORTANT SAFETY INSTRUCTIONS

Electricity is used to perform many useful functions, but it can also cause personal injuries and property damage if improperly handled. This product has been engineered and manufactured with the highest priority on safety. However, improper use can result in electric shock and/or fire. In order to prevent potential danger, please observe the following instructions when installing, operating and cleaning the product. To ensure your safety and prolong the service life of your Liquid Crystal Television, please read the following precautions carefully before using the product.

- 1) Read these instructions.
- 2) Keep these instructions.
- 3) Heed all warnings.
- 4) Follow all instructions.
- 5) Do not use this apparatus near water.
- 6) Clean only with dry cloth.
- 7) Do not block any ventilation openings. Install in accordance with the manufacturer's instructions.
- 8) Do not install near any heat sources such as radiators, heat registers, stoves, or other apparatus (including amplifiers) that produce heat.
- 9) Do not defeat the safety purpose of the polarized or grounding-type plug. A polarized plug has two blades with one wider than the other. A grounding type plug has two blades and a third grounding prong. The wide blade or the third prong are provided for your safety. If the provided plug does not fit into your outlet, consult an electrician for replacement of the obsolete outlet.
- 10) Protect the power cord from being walked on or pinched particularly at plugs, convenience receptacles, and the point where they exit from the apparatus.
- 11) Only use attachments/accessories specified by the manufacturer.
- 12) Use only with the cart, stand, tripod, bracket, or table specified by the manufacturer, or sold with the apparatus. When a cart is used, use caution when moving the cart/apparatus combination to avoid injury from tip-over.
- 13) Unplug this apparatus during lightning storms or when unused for long periods of time.
- 14) Refer all servicing to qualified service personnel. Servicing is required when the apparatus has been damaged in any way, such as power-supply cord or plug is damaged, liquid has been spilled or objects have fallen into the apparatus, the apparatus has been exposed to rain or moisture, does not operate normally, or has been dropped.



Additional Safety Information

- 15) Power Sources — This product should be operated only from the type of power source indicated on the marking label. If you are not sure of the type of power supply to your home, consult your product dealer or local power company. For products intended to operate from battery power, or other sources, refer to the operating instructions.
- 16) Overloading — Do not overload wall outlets, extension cords, or integral convenience receptacles as this can result in a risk of fire or electric shock.
- 17) Object and Liquid Entry — Never push objects of any kind into this product through openings as they may touch dangerous voltage points or short-out parts that could result in a fire or electric shock. Never spill liquid of any kind on the product.
- 18) Damage Requiring Service — Unplug this product from the wall outlet and refer servicing to qualified service personnel under the following conditions:
 - a) When the AC cord or plug is damaged,
 - b) If liquid has been spilled, or objects have fallen into the product,
 - c) If the product has been exposed to rain or water,
 - d) If the product does not operate normally by following the operating instructions.

Adjust only those controls that are covered by the operating instructions as an improper adjustment of other controls may result in damage and will often require extensive work by a qualified technician to restore the product to its normal operation,
 - e) If the product has been dropped or damaged in any way, and
 - f) When the product exhibits a distinct change in performance – this indicates a need for service.
- 19) Replacement Parts — When replacement parts are required, be sure the service technician has used replacement parts specified by the manufacturer or have the same characteristics as the original part. Unauthorized substitutions may result in fire, electric shock, or other hazards.
- 20) Safety Check — Upon completion of any service or repairs to this product, ask the service technician to perform safety checks to determine that the product is in proper operating condition.
- 21) Wall or ceiling mounting — When mounting the product on a wall or ceiling, be sure to install the product according to the method recommended by the manufacturer.

IMPORTANT SAFETY INSTRUCTIONS

- Water and Moisture — Do not use this product near water – for example, near a bath tub, wash bowl, kitchen sink, or laundry tub; in a wet basement; or near a swimming pool; and the like.

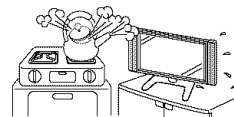

- Stand — Do not place the product on an unstable cart, stand, tripod or table. Placing the product on an unstable base can cause the product to fall, resulting in serious personal injuries as well as damage to the product. Use only a cart, stand, tripod, bracket or table recommended by the manufacturer or sold with the product. When mounting the product on a wall, be sure to follow the manufacturer's instructions. Use only the mounting hardware recommended by the manufacturer.



- Selecting the location — Select a place with no direct sunlight and good ventilation.

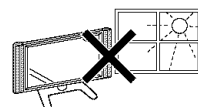

- Ventilation — The vents and other openings in the cabinet are designed for ventilation. Do not cover or block these vents and openings since insufficient ventilation can cause overheating and/or shorten the life of the product. Do not place the product on a bed, sofa, rug or other similar surface, since they can block ventilation openings. This product is not designed for built-in installation; do not place the product in an enclosed place such as a bookcase or rack, unless proper ventilation is provided or the manufacturer's instructions are followed.

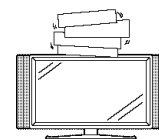

- The Liquid Crystal panel used in this product is made of glass. Therefore, it can break when the product is dropped or applied with impact. Be careful not to be injured by broken glass pieces in case the panel breaks.

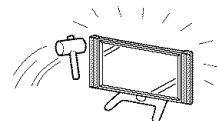

- Heat — The product should be situated away from heat sources such as radiators, heat registers, stoves, or other products (including amplifiers) that produce heat.

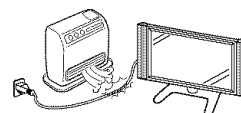

- The Liquid Crystal panel is a very high technology product with 6,220,800 thin film transistors, giving you fine picture details. Occasionally, a few non-active pixels may appear on the screen as a fixed point of blue, green or red. Please note that this does not affect the performance of your product.

Precautions when transporting the TV

When transporting the TV, never carry it by holding onto the speaker. Be sure to always carry the TV by two people holding it with two hands—one hand on each side of the TV.

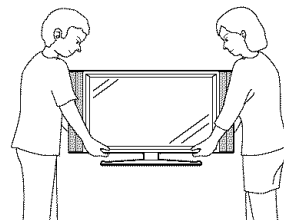

- Lightning — For added protection for this television equipment during a lightning storm, or when it is left unattended and unused for long periods of time, unplug it from the wall outlet and disconnect the antenna. This will prevent damage to the equipment due to lightning and power-line surges.

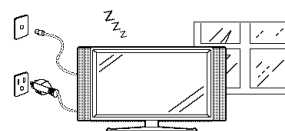

- Power Lines — An outside antenna system should not be located in the vicinity of overhead power lines or other electric light or power circuits, or where it can fall into such power lines or circuits. When installing an outside antenna system, extreme care should be taken to keep from touching such power lines or circuits as contact with them might be fatal.

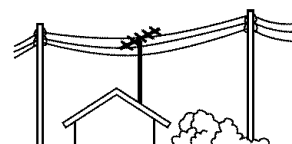

IMPORTANT SAFETY INSTRUCTIONS

- **Outdoor Antenna Grounding** — If an outside antenna is connected to the television equipment, be sure the antenna system is grounded so as to provide some protection against voltage surges and built-up static charges. Article 810 of the National Electrical Code, ANSI/NFPA 70, provides information with regard to proper grounding of the mast and supporting structure, grounding of the lead-in wire to an antenna discharge unit, size of grounding conductors, location of antenna-discharge unit, connection to grounding electrodes, and requirements for the grounding electrode.

EXAMPLE OF ANTENNA GROUNDING AS PER NATIONAL ELECTRICAL CODE, ANSI/NFPA 70

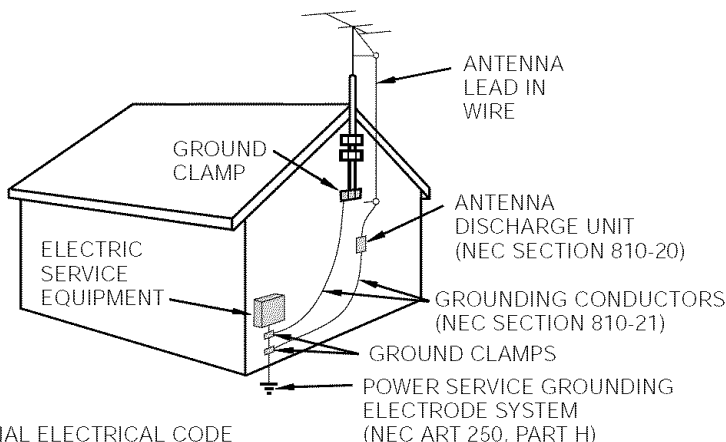

- To prevent fire, never place any type of candle or flames on the top or near the TV set.

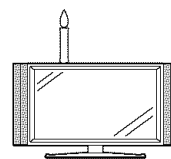

- To prevent fire or shock hazard, do not expose this product to dripping or splashing. No objects filled with liquids, such as vases, should be placed on the product.

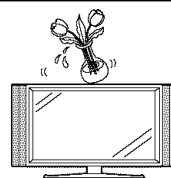

- To prevent fire or shock hazard, do not place the AC cord under the TV set or other heavy items.

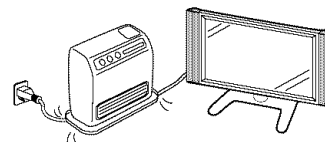

- Turn off the main power and unplug the AC cord from the wall outlet before handling.
- Use a soft cloth and gently wipe the surface of the TV panel. Using a hard cloth may scratch the panel surface.
- Use a soft damp cloth to gently wipe the panel when it is really dirty. (It may scratch the panel surface when wiped strongly.)
- If the panel is dusty, use an anti-static brush, which is commercially available, to clean it.
- To protect the panel, do not use a dirty cloth, liquid cleaners or chemical cloth to clean it, such materials may damage the panel surface.

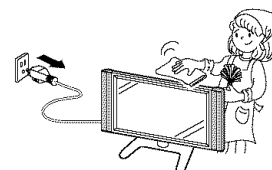

- Do not display a still picture for a long time, as this could cause an afterimage to remain.

QUICK REFERENCE

STOP! To safely remove the AQUOS television from the box

It's best to use 2 people to remove the AQUOS television for stability.

1. Use the cardboard holders on either side of the AQUOS television to remove it from the box.
2. Remove the cardboard; however, keep the wrapping on the AQUOS television to protect it while moving.
3. Lift onto installation location as the diagram illustrates.

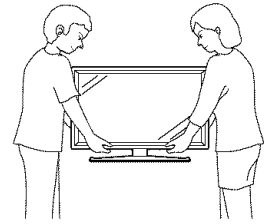

Ventilation & Cleaning Tips

Keep your AQUOS television in a well ventilated area and make sure not to place it by a heat source or use near water. The AQUOS television is designed for AC use only and should be used with supplied AC cord.

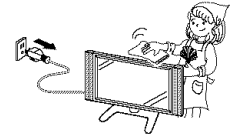

Clean the screen by spraying a soft lint free cloth with water to lightly moisten. Gently wipe and avoid pressing on the screen. To clean the outer cabinet, use the same method. Do not use liquid or aerosol cleaners.

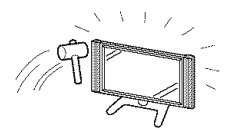

The screen is glass and can be scratched or broken when dropped or impacted.

QUICK INSTALLATION TIPS

1. Facing the back of the AQUOS television, remove the terminal cover.

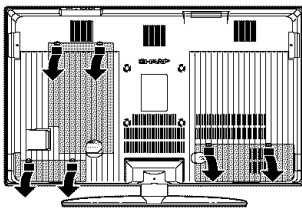

Press down the upper hooks to remove the cover toward you.

2. Attach your antenna to the back of the TV. (See page 17.)
3. Connect the AC plug for the AQUOS television into the wall outlet.

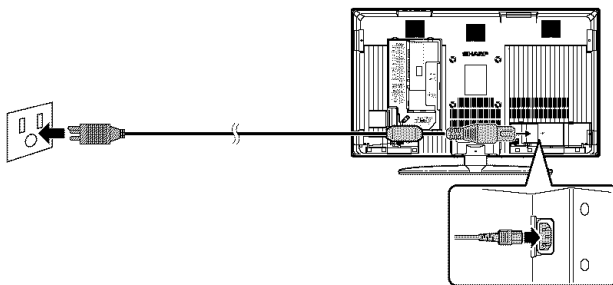

4. Bundle the cords properly with a cable clamp and cable tie, and close the terminal cover.

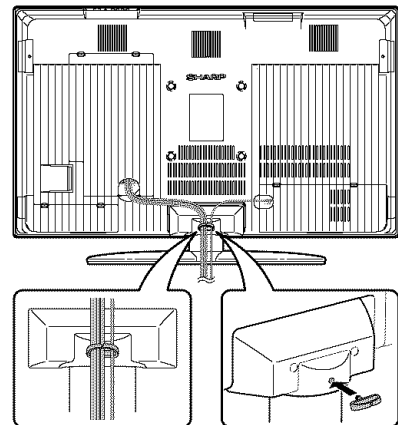

5. How to turn on the AQUOS television for the first time.

A) Press **POWER** on AQUOS television.

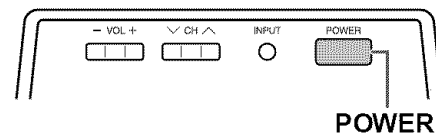

B) POWER indicator on the front of the AQUOS television lights blue.

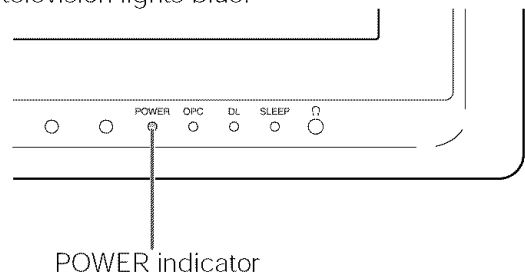

CAUTION

- TO PREVENT RISK OF ELECTRIC SHOCK, DO NOT TOUCH UN-INSULATED PARTS OF ANY CABLES WITH THE AC CORD CONNECTED.

NOTE

- The TV can be swiveled 5 degrees right and left with TV stand attached.
- You cannot tilt the screen vertically.

Attaching speakers

1

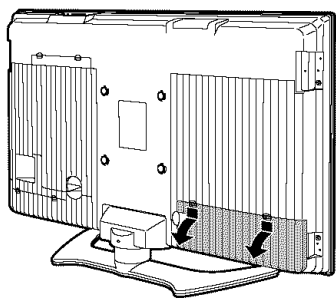

Remove the terminal cover as shown in the illustration.

4

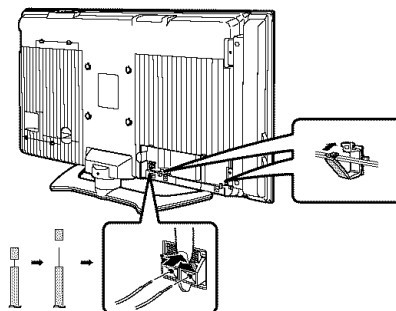

Fasten the speaker cable with the holder. Connect the ends of the cable to the speaker terminals as shown in the illustration. Connect leads to speaker terminals of the same color.

2

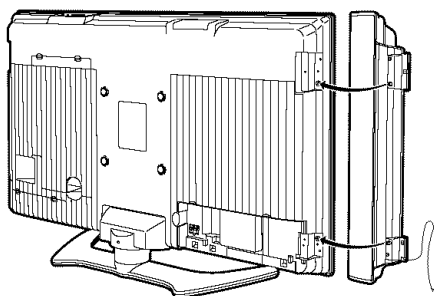

Insert the projecting bulges on the side of the speakers into the corresponding slots in the display.

5

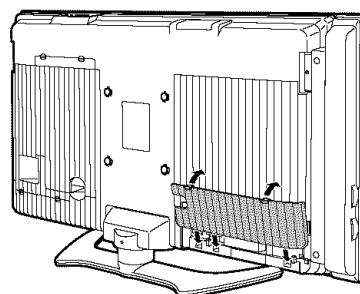

Attach the terminal cover as shown in the illustration.

3

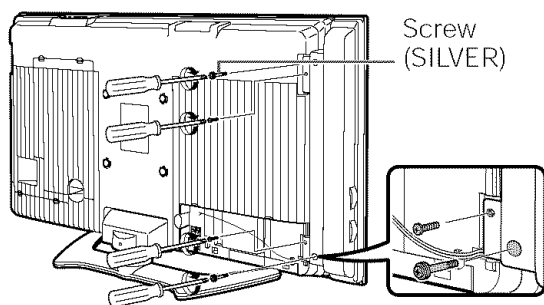

Fasten the screw.

CAUTION

- Do not remove the stand and speaker from the TV unless using an optional bracket to mount it.
- Before performing work spread cushioning over the base area to lay the TV on. This will prevent it from being damaged.

NOTE

- Perform the same steps for right speaker.
- To remove the speakers, perform the steps in reverse order.

QUICK REFERENCE

If the remote control fails to operate TV functions, replace the batteries in the remote control unit.

- 1 Open the battery cover.
- 2 Insert two "AAA" size batteries (supplied with the product).
- 3 Close the battery cover.

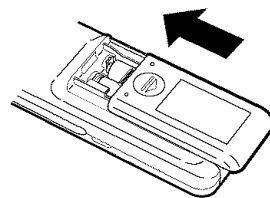
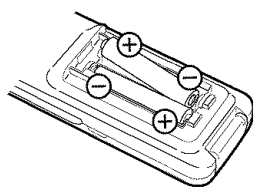
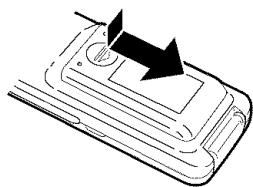

- Place the batteries with their terminals corresponding to the (+) and (-) indications in the battery compartment.

CAUTION

Improper use of batteries can result in chemical leakage or explosion. Be sure to follow the instructions below.

- Do not mix batteries of different types. Different types of batteries have different characteristics.
- Do not mix old and new batteries. Mixing old and new batteries can shorten the life of new batteries or cause chemical leakage in old batteries.
- Remove batteries as soon as they are worn out. Chemicals that leak from batteries that come in contact with skin can cause a rash. If you find any chemical leakage, wipe thoroughly with a cloth.
- The batteries supplied with this product may have a shorter life expectancy due to storage conditions.
- If you will not be using the remote control unit for an extended period of time, remove batteries from it.

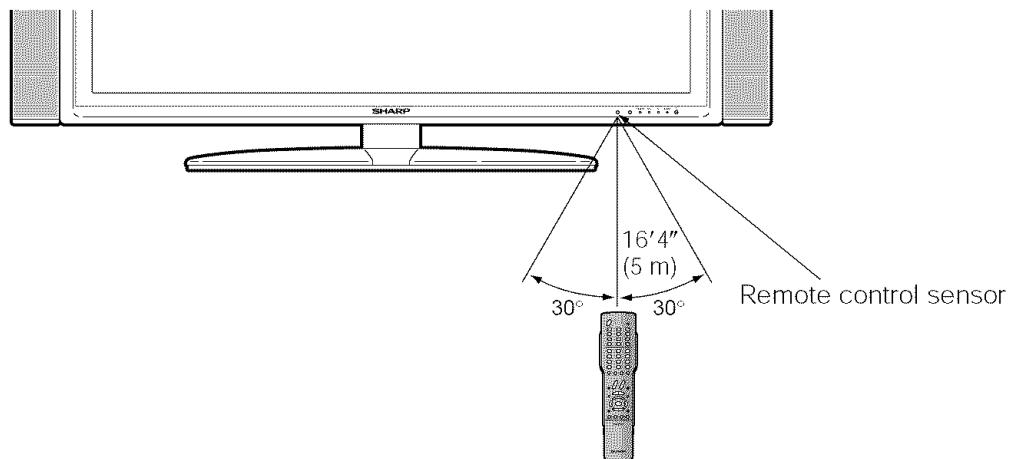

IMPORTANT:

The POWER indicator on the AQUOS television should light blue indicating you have power to the AQUOS television.

If the POWER indicator on the AQUOS television still does not light up, press **TV POWER** on the remote control to turn the power on.

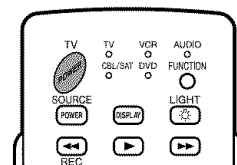

IMPORTANT:

IF THE UNIT DOES NOT POWER ON - UNPLUG THE AQUOS TELEVISION FROM THE OUTLET AND REPEAT THE INSTALLATION STEPS.

IF YOU STILL ENCOUNTER NO POWER, PLEASE CONTACT US AT 1-800-BE-SHARP.

Please refer to the BASIC ADJUSTMENT SETTINGS SECTION for EZ setup and basic channel setup functions and USING EXTERNAL EQUIPMENT SECTION for other device connections (DVD, VCR, AUDIO, etc) in your AQUOS operation manual.



TV GUIDE ON SCREEN™ QUICK SETUP SHEET

Once you set up the TV according to this operation manual, you are ready to set up TV Guide On Screen!

Note: TV Guide On Screen™ interactive program guide supports cable-ready, cable box and digital cable services as well as over-the-air broadcast. It does not provide listings for satellite services.

After completing the TV's initial set up, you see the TV Guide On Screen Setup **Welcome Screen**.

Note: If TV Guide On Screen is not set up, pressing **TV GUIDE** while watching TV will display the **Welcome Screen**.

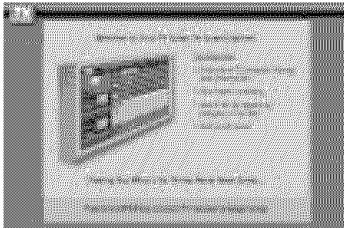

Follow the on-screen instructions

If you previously skipped TV Guide On Screen setup, you see the **Reminder Screen**.

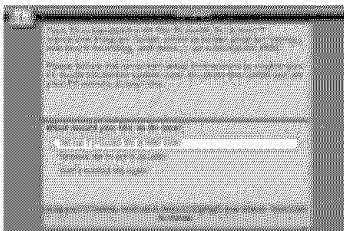

Note: If you press **ENTER** and the screen does not change, make sure that the batteries in the remote control are properly installed.

If you need to control a cable box and/or a VCR, complete steps 1 through 3. If not, go to step 4.

1

Find and Connect the included G-LINK cable into the G-LINK terminal.

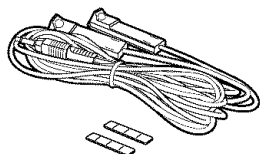

G-LINK cable with Double-Sided Tape

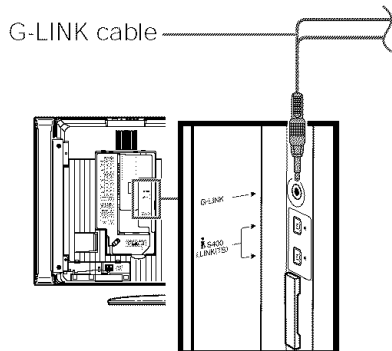

2

Find the VCR and Cable Box IR Sensors.

To control recording, find the VCR's IR sensor.

- ① Turn the VCR off.
- ② Hold the VCR remote so that it touches the front of the VCR (Figure 1).
- ③ Move the remote across the front while pressing **POWER** (Figure 2). (You must press and release the power button each time you move the remote; holding down the button will not work).
- ④ When the VCR powers on, you have found the sensor.
- ⑤ Remember the location of the sensor, and go to step 3.

If you have a cable box, repeat this procedure using the cable box and its remote, and then go to step 3.

Figure 1

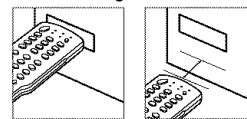

Correct

Incorrect

Figure 2

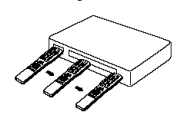

3

Place the G-LINK cable(s)

To control a VCR, place one of the G-LINK wands underneath the VCR approximately 1 inch in front of the sensor you found in step 2.

If you have a cable box, place the other G-LINK wand approximately 1 inch in front of the sensor you found in step 2.

Use the double-sided tape to secure each G-LINK cable.

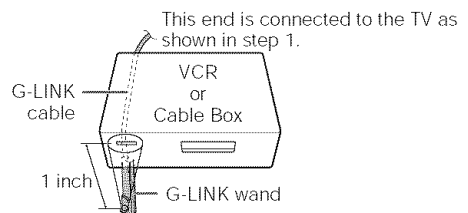

4

Use the TV remote for On-Screen Setup

- ① Press **▲/▼/◀/▶** and **ENTER** to highlight an item in a Setup screen.
- ② Press **ENTER** to select that item.

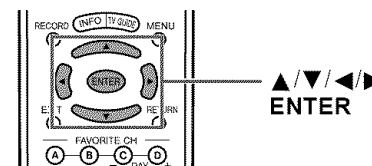

QUICK REFERENCE

On-Screen Setup

- TV Guide uses setup information to provide TV listings and lineups.

5

The first two screens ask you about your location.

Follow the on-screen instructions.

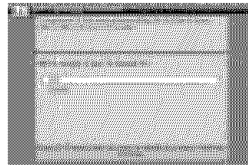

Press ◀/▶ to move the highlight.
Press 0-9 or ▲/▼ to enter a ZIP Code or Postal Code.

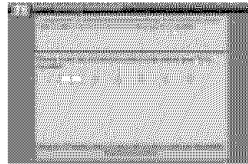

6

These screens ask you about cable.

If the answer is "YES", you next see a screen about a cable box.

If the answer is "NO", you next see the screen in step 7 which asks about an antenna connection.

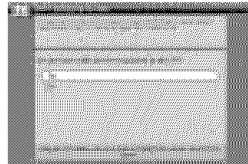

If the answer is "YES", you are directed through additional screens, which include selecting the input used on the TV for the cable box and verifying the cable box and verifying the cable box brand. When successfully completed, you next see the screen in step 7 which asks about an antenna connection.



- **Please refer to the note on step 3 in page 22 for details.**

If the answer is "NO", you next see the screen in step 7 which asks about an antenna connection.

7

This screen asks you about an antenna connection.

If the answer is "YES", you may see an additional screen to select the input. Then you next see the screen in step 8 about confirming your basic settings.

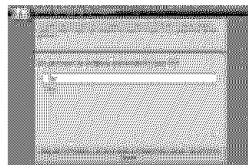

If the answer is "NO", you next see the screen in step 8 about confirming your basic settings.

Important: If you selected that you do not have cable service connected to this TV in the previous screens, you must select "YES" in this screen to receive a channel lineup and listings.

8

This screen asks you if the settings are correct, so far.

If the answer is "YES", you next see an information screen and then the screen in step 9 which asks about a VCR.



If the answer is "NO", you are returned to step 5, from where you can change any incorrect information by repeating the Setup process.

9

This screen asks you about a VCR.

If the answer is "YES", you are directed through additional screens, which include selecting and verifying the VCR brand. When successfully completed, you next see the screen in step 10 which asks about confirming all of your settings.

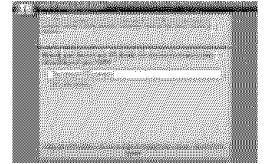

If the answer is "NO", you next see the screen in step 10 which asks about confirming all of your settings.

10

This screen asks you to confirm that the settings are correct.

If the answer is "YES", you next see the screen in step 11.

If the answer is "NO", you are returned to step 5 from where you can change any incorrect information by repeating the Setup process.

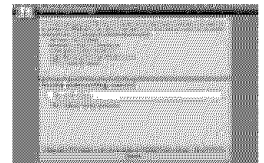

11

This screen indicates you have successfully completed setup for TV Guide On Screen.

Important: Power off your recorder overnight and if you have a cable box, leave it on.

Within 24 hours, you will begin to receive TV program listings.

Note: If you have a cable box, it is normal for the TV to switch channels on the cable box while the unit is setting up. DO NOT interfere with the process. If you want to resume TV viewing and stop the TV from changing channels, you need to power on the TV.

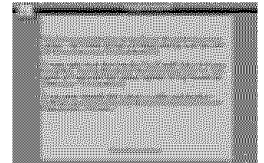

12

This screen gives helpful information about TV Guide On Screen.

Congratulations, you are done!



In the United States, TV GUIDE and other related marks are registered marks of Gemstar-TV Guide International, Inc. and/or one of its affiliates. In Canada, TV GUIDE is a registered mark of Transcontinental Inc., and is used under license by Gemstar-TV Guide International, Inc.

Contents

IMPORTANT INFORMATION	1	Using external equipment	47
DEAR SHARP CUSTOMER	3	Displaying an external equipment image	47
IMPORTANT SAFETY INSTRUCTIONS	3	Connecting a DVD player	48
QUICK REFERENCE	6	Connecting a VCR	49
Attaching speakers	7	Connecting a game console	
Contents	11	or camcorder	49
Trademarks	12	Connecting a Digital TV STB (Air or Cable) ...	50
COPYRIGHT AND LICENSE NOTICE	12	Connecting HDMI equipment	51
PATENT NOTICE	12	Displaying an image from HDMI	
Supplied accessories	13	equipment	51
Part names	14	Connecting a PC	52
TV (Front)	14	Using Digital Audio Output	52
TV (Rear)	15	Connecting D-VHS decks/AV-HDD recorder/	
Remote control unit	16	Blu-ray Disc recorder (i.LINK connection) ...	53
Preparation	17	About i.LINK	53
Using the remote control unit	17	i.LINK connection	53
Cautions regarding remote control unit ...	17	Connecting two or more i.LINK devices ...	53
Antennas	17	Setting the Recording Mode (i.LINK)	54
Watching TV	18	Setting the Standby Mode (i.LINK)	54
Turning on the power	18	Selecting an i.LINK device	55
Turning off the power	18	Disabling the TV's operation of	
Initial setup	19	an i.LINK device	55
Using the TV Guide On Screen™		Deleting registered i.LINK devices	55
(Interactive Program Guide)	20	Controlling an i.LINK device	56
TV Guide On Screen Initial setup	21	Automatic input switching to i.LINK	57
Using TV Guide On Screen	24	Recording digital programs	
Program recording using		with a D-VHS deck (i.LINK)	57
LISTINGS function	27	Recording digital programs with AV-HDD	
Using Reminder function	27	recorder/Blu-ray Disc recorder	58
Using SCHEDULE function	28	Playing back using REC LIST (i.LINK) ...	58
Changing system settings	30	Useful adjustment settings	59
Changing channel display	31	Image position (AV input mode only)	59
Changing default options	31	Moving the picture on the screen	59
Changing channels-Air/Cable	33	Auto Sync. adjustment (PC input mode only) ...	60
Changing volume/sound	34	Fine Sync. adjustment (PC input mode only) ...	60
Setting MTS/SAP stereo mode	35	Input Select	61
Setting Digital broadcasting audio mode	35	Input Label	62
Connecting Digital Cable Module	36	Picture Flip	62
Basic adjustment settings	37	AV MODE	63
AV input mode menu items	37	View mode for 4:3 Programs	63
PC input mode menu items	37	View mode for HD Programs	63
EZ setup	38	View mode (for PC input mode)	64
Channel Setup	38	Input signal (for PC input mode)	65
Antenna Setup – DIGITAL – Air	39	3D Noise Reduction	65
Standby Mode	40	Mosquito Noise Reduction	65
Favorite channel setting	40	Audio Only	65
Language setting	40	Output Select	66
Picture adjustments	41	Quick Shoot	66
OPC setting	42	Sleep Timer	66
Advanced picture adjustments	42	Program Title Display	66
C.M.S. (Color Management System)	42	Closed Captions and Digital Closed	
Color temperature	42	Captions	67
Sharpness Enhancement	43	Caption Setup	68
Automatic Contrast	43	Secret number setting for parental control	
3D-Y/C	43	(AV input mode only)	69
Monochrome	43	Parental control (setting V-CHIP level)	71
Film Mode (3:2 pull-down)	43	How to temporarily release	
I/P Setting	43	the V-CHIP BLOCK	74
Sound adjustment	44	Reactivating the temporarily released	
Dolby Virtual	44	V-CHIP BLOCK	74
Power Control	45		
Power control for AV source	45		
Power control for PC source	45		
Digital Setup	46		
Video Setup	46		
Audio Setup	46		

Contents

Other viewing options	75
Viewing information of the program	75
Picture and still image	75
Presetting remote control function	75
Appendix	80
Removing the stand	80
Setting the TV on the wall	80
Troubleshooting	81
Troubleshooting-TV Guide On Screen	82
Troubleshooting-Digital broadcasting	83
PC compatibility chart	83
RS-232C port specifications	84
Specifications	86
Dimensional drawings	87

Trademarks

- Manufactured under license from Dolby Laboratories. "Dolby", "Pro Logic" and the double-D symbol are trademarks of Dolby Laboratories.

- Manufactured under license from BBE Sound, Inc. Licensed by BBE Sound, Inc. under USP5510752 and 5736897. BBE and BBE symbol are registered trademarks of BBE Sound, Inc.
- BBE Mach3Bass extends the bass response of a given loudspeaker and provides deep, tight and musically accurate bass frequencies.

- "HDMI, the HDMI logo and High-Definition Multimedia Interface are trademarks or registered trademarks of HDMI Licensing LLC."

- CableCARD™ is a trademark of Cable Television Laboratories, Inc.

- In the United States, TV GUIDE and other related marks are registered marks of Gemstar-TV Guide International, Inc. and/or one of its affiliates. In Canada, TV GUIDE is a registered mark of Transcontinental Inc., and is used under license by Gemstar-TV Guide International, Inc.

COPYRIGHT AND LICENSE NOTICE

- It is the intent of Sharp that this product be used in full compliance with the copyright laws of the United States and that prior permission be obtained from copyright owners whenever necessary.
- This product incorporates copyright protection technology that is protected by U.S. patents and other intellectual property rights. Use of this copyright protection technology must be authorized by Macrovision, and is intended for home and other limited viewing uses only unless otherwise authorized by Macrovision. Reverse engineering or disassembly is prohibited. U. S. Patent Nos. 4,631,603; 4,577,216; 4,819,098; 4,907,093; 5,315,448; 6,381,747; and 6,516,132.
- This digital television is capable of receiving analog basic, digital basic and digital premium cable television programming by direct connection to a cable system providing such programming. A security card provided by your cable operator is required to view encrypted digital programming. Certain advanced and interactive digital cable services such as video-on-demand, a cable operator's enhanced program guide and data-enhanced television services may require the use of a set-top box. For more information call your local cable operator.
- The TV Guide On Screen system is manufactured under license from Gemstar-TV Guide International, Inc. and/or one of its affiliates.

PATENT NOTICE

The TV Guide On Screen system is protected by one or more of the following issued United States patents 6,498,895, 6,418,556, 6,331,877; 6,239,794; 6,154,203; 5,940,073; 4,908,713; 4,751,578; 4,706,121.

Supplied accessories

Make sure the following accessories are provided with the product.

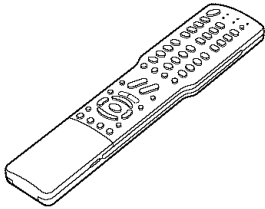
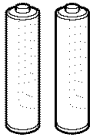
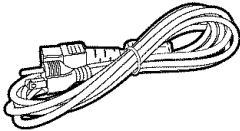
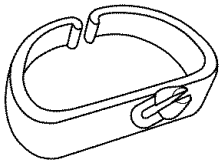
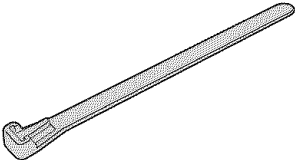
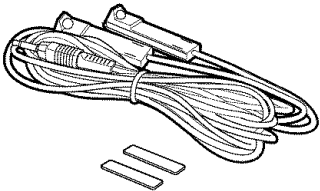
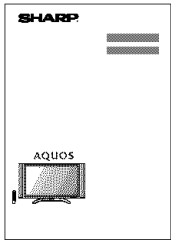
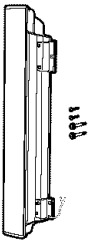
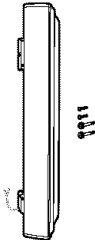
Remote control unit (×1)	"AAA" size battery (×2)	AC cord (×1)
 <p>Page 8</p>	 <p>Page 8</p>	 <p>Page 6</p>
Cable clamp (×1)	Cable tie (×1)	G-LINK cable (×1)
 <p>Page 6</p>	 <p>Page 6</p>	 <p>Page 9</p>
Operation manual (×1)	Speaker unit (×2)	
	 <p>Left speaker Page 7</p>	 <p>Right speaker Page 7</p>

NOTE

- Always use the AC cord supplied with the LCD-TV.

Part names

TV (Front)

Volume buttons (VOL -/+) Channel buttons** (CH V/∧) INPUT button* POWER button

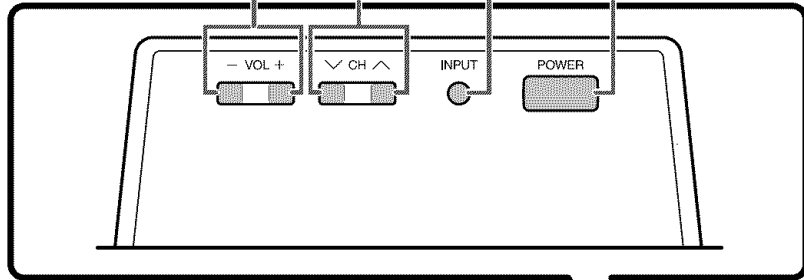

* **INPUT** button works as **ENTER** in TV Guide On Screen

** Channel buttons work as **▲/▼** in TV Guide On Screen

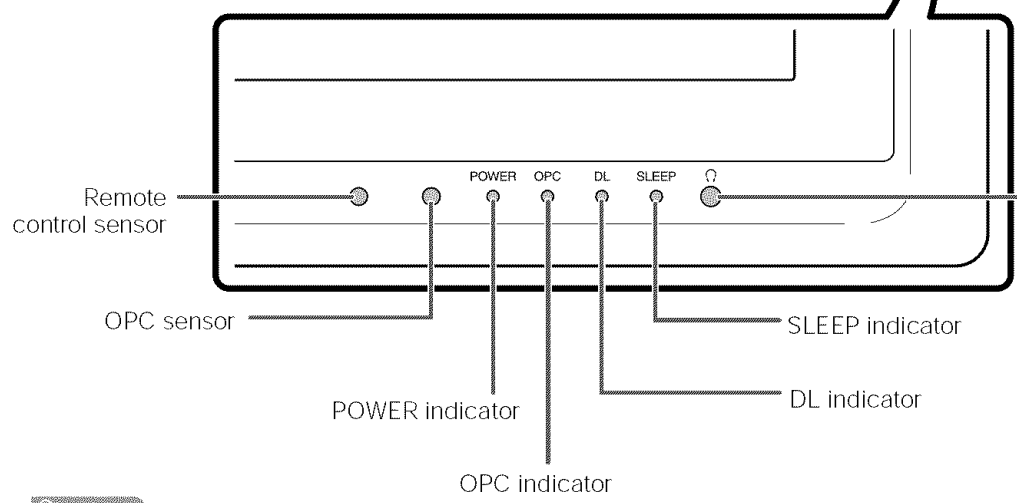
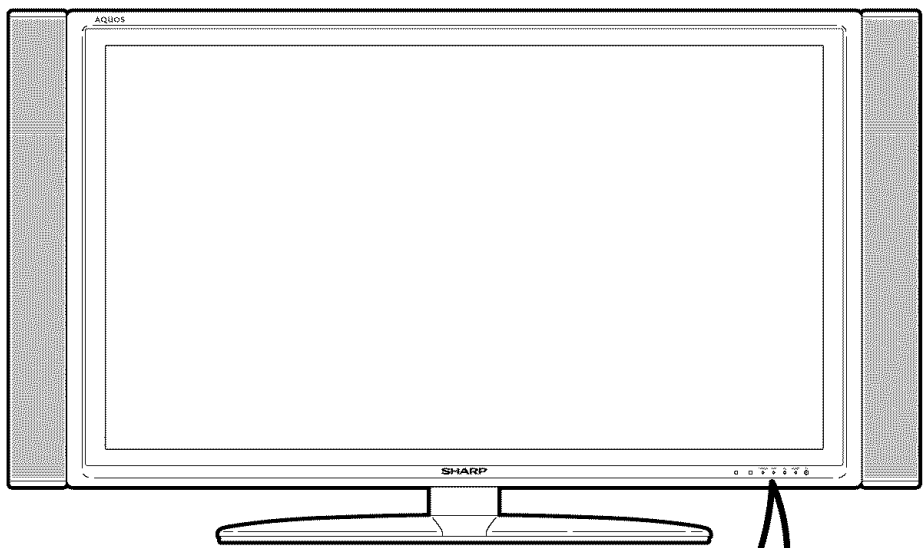
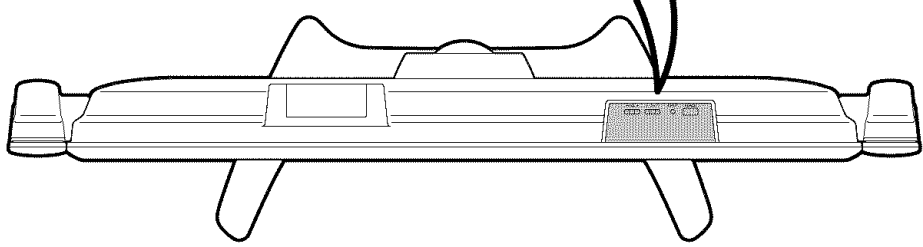

Headphone jack (When connecting headphones, the sound from the speakers is muted.)

NOTE

• See page 18 for the TV status indicator.

*OPC: Optical Picture Control (See page 42.)
*DL: Download

Part names

TV (Rear)

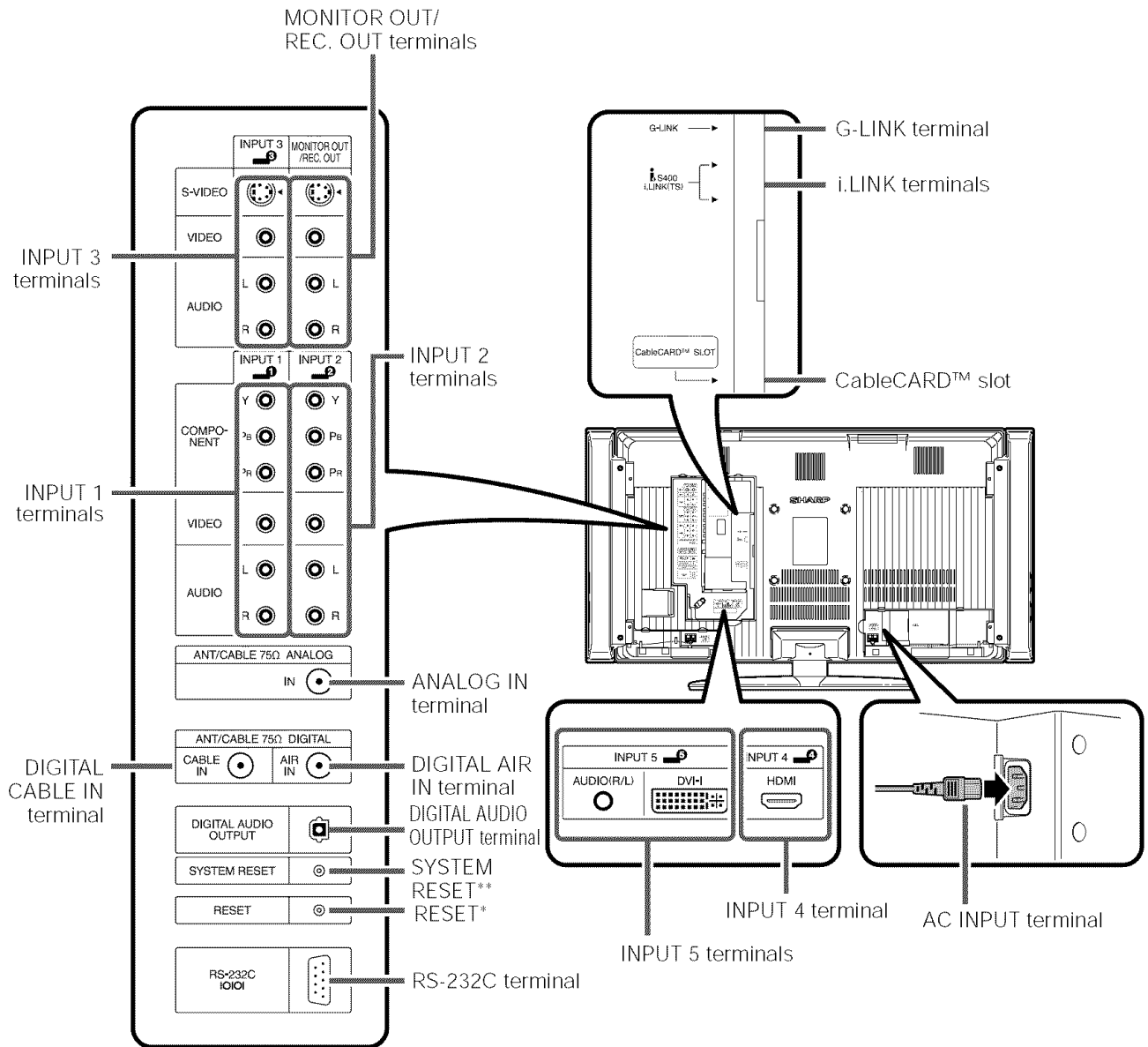

* Press **RESET** if the TV cannot return to its original state after performing various operations.

- AV MODE resets to DYNAMIC (Fixed)
- TV channel returns to initial channel (Air:2ch, Cable:1 or 2ch)
- Audio setting initializes
- Dolby Virtual resets to off
- Image position initializes

** Press **SYSTEM RESET** if the TV does not operate after starting up.

NOTE

- Pressing **RESET** will not work if the TV is in standby mode.
- Pressing **RESET** will not delete channel preset or secret number. See page 70 for clearing the secret number when you know it. See page 87 for initializing to the factory preset values when you forget your secret number.

Remote control unit

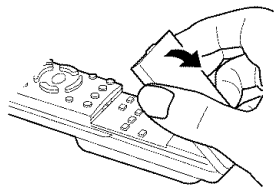
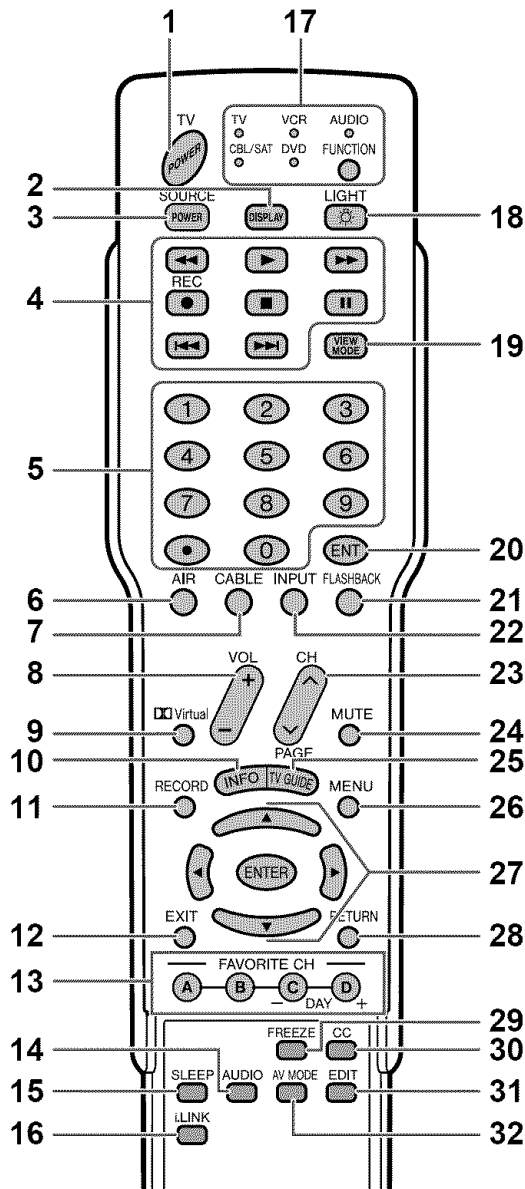

- 1 **TV POWER:** Switches the Liquid Crystal Television power on or enters Standby mode. (See page 18.)
- 2 **DISPLAY:** Displays the channel information.
- 3 **SOURCE POWER:** Turns the power of the external equipment on and off.
- 4 **External equipment operational buttons:** Operates the external equipment.
- 5 **0 - 9/• (DOT):** Sets the channel. (See page 33.)

- 6 **AIR:** Receives air signal.
- 7 **CABLE:** Receives cable signal.
- 8 **VOL +/-:** Sets the volume. (See page 34.)
- 9 **Virtual:** Selects Virtual Dolby Surround settings. (See page 34.)
- 10 **INFO:** Displays the program information screen. (See page 75.)
- 11 **RECORD:** Records the program to equipment (capable of recording). (See page 27.)
In TV Guide On Screen, initiates the recording process.
- 12 **EXIT:** Turns off the menu screen and TV Guide On Screen.
- 13 **FAVORITE CH**
A, B, C, D: Selects four preset favorite channels in four different categories. (See page 40 for details.)
While watching, you can toggle the selected channels by pressing A, B, C and D.
DAY -/DAY +: In TV Guide On Screen, moves forward or backward in 24 hour increments in the listing grid.
- 14 **AUDIO:** Selects the MTS/SAP or the audio mode during multi-channel audio broadcasts. (See page 35.)
- 15 **SLEEP:** Sets the sleep timer. (See page 66.)
- 16 **i.LINK:** Displays the i.LINK panel. (See page 55.)
- 17 **FUNCTION:** Switches the remote control for TV, CBL/SAT, VCR, DVD and AUDIO operation. Indicator lights up for the current mode. (See pages 75 to 78 for details.)
* To enter the code registration mode, you need to press **FUNCTION** and **DISPLAY** at the same time.
- 18 **LIGHT** : When pressed all buttons on the remote control unit will light. The lighting will turn off if no operations are performed within about 5 seconds. This button is used for performing operations in low-light situations.
- 19 **VIEW MODE:** Selects the screen size. (See pages 63 and 64.)
- 20 **ENT:** Enters a channel selection when choosing with the 0-9 buttons.
- 21 **FLASHBACK:** Returns to the previous channel or external input mode. (See page 33.)
- 22 **INPUT:** Selects a Liquid Crystal Television input source. (TV, CableBox, INPUT 1, INPUT 2, INPUT 3, INPUT 4, INPUT 5, i.LINK) (See pages 47 and 61.)
If the CableBox is set up in the TV Guide On Screen setting menu, the CableBox option appears.
- 23 **CH** : Selects the channel. (See page 33.)
In the TV Guide On Screen, moves one page up or one page down in the LISTINGS grid.
- 24 **MUTE:** Mutes the sound. (See page 34.)
- 25 **TV GUIDE:** Displays TV Guide On Screen.
- 26 **MENU:** Displays the menu screen.
- 27 **▲/▼/◀/▶/ENTER:** Selects a desired item on the screen.
- 28 **RETURN:** Returns to the previous menu screen.
- 29 **FREEZE:** Sets the still image. Press again to return to normal screen. (See page 75.)
- 30 **CC:** Displays captions when receiving closed-caption signals. (See page 67.)
- 31 **EDIT:** Registers favorite channel. (See page 40.)
- 32 **AV MODE:** Selects an audio or video setting. (AV mode: STANDARD, MOVIE, GAME, USER, DYNAMIC (Fixed), DYNAMIC. PC mode: STANDARD, USER.) (See page 63.)

Preparation

Using the remote control unit

Use the remote control unit by pointing it towards the remote control sensor on the TV. Objects between the remote control unit and the remote control sensor may prevent proper operation.

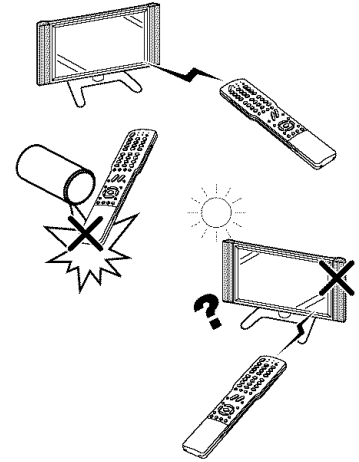

Cautions regarding remote control unit

- Do not expose the remote control unit to shock. In addition, do not expose the remote control unit to liquids, and do not place in an area with high humidity.
- Do not install or place the remote control unit under direct sunlight. The heat may cause deformation of the remote control unit.
- The remote control unit may not work properly if the remote control sensor on the TV is under direct sunlight or strong lighting. In such cases, change the angle of the lighting or the TV, or operate the remote control unit closer to the remote control sensor.

Antennas

To enjoy a clearer picture, use an outdoor antenna. The following is a brief explanation of the types of connections that are used for a coaxial cable. If your outdoor antenna uses a 75-ohm coaxial cable with an F-type connector, plug it into the antenna terminal at the rear of the TV set.

1. A 75-ohm system is generally a round cable with F-type connector that can easily be attached to a terminal without tools (Commercially available).
2. A 300-ohm system is a flat "twin-lead" cable that can be attached to a 75-ohm terminal through a 300/75-ohm adapter (Commercially available).

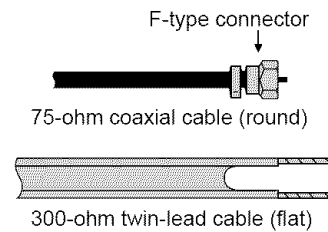

NOTICE

F-type connector

F-type connector should be finger-tightened only.

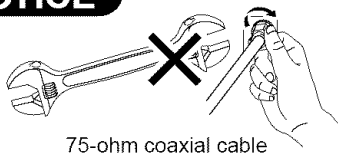

75-ohm coaxial cable

When connecting the RF cable to the TV set, do not tighten F-type connector with tools. If tools are used, it may cause damage to your TV set. (The breaking of internal circuit, etc.)

Connecting Antenna Cable

Cable without a CATV converter
Combination VHF/UHF antenna

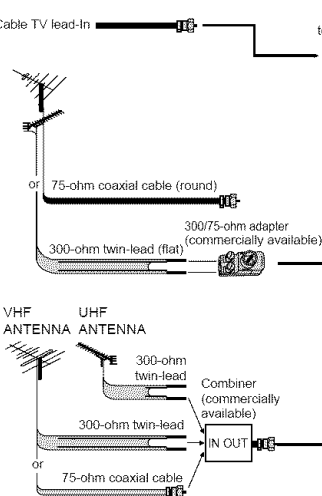

Separate VHF/UHF antenna

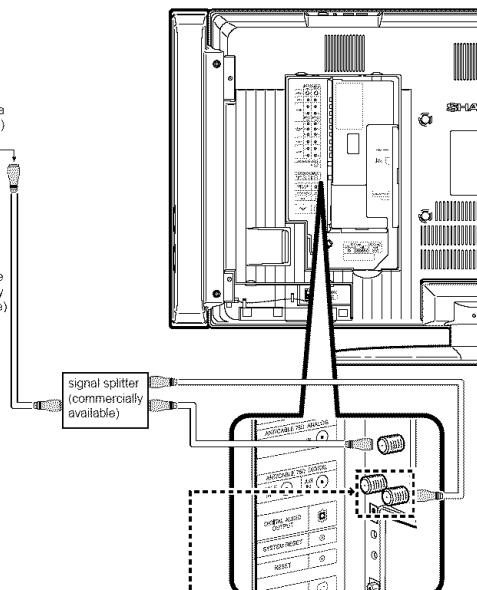
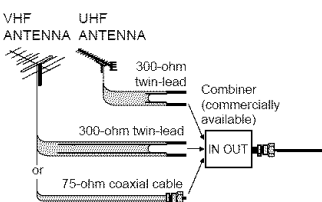

Depending on your reception environment, either CABLE IN or AIR IN may be used, or both CABLE IN and AIR IN may be used.

Watching TV

Simple operations for watching a TV program

Turning on the power

Press **POWER** on the TV or press **TV POWER** on the remote control.

- POWER indicator (Blue): The TV is on. (After a few seconds, a window appears with sound.)

NOTE

- The initial setup starts when the TV powers on for the first time. If the TV has been turned on before, the EZ setup will not be invoked. See page 38 for performing EZ setup from the Setup menu.

Turning off the power

Press **POWER** on the TV or press **TV POWER** on the remote control.

- The TV enters standby mode and the image on the screen disappears.
- The POWER indicator on the TV gradually turns off.

NOTE

- If you are not going to use this TV for a long period of time, be sure to remove the AC cord from the power outlet.

CAUTION

- Please do not unplug the AC cord when the DL indicator is red.

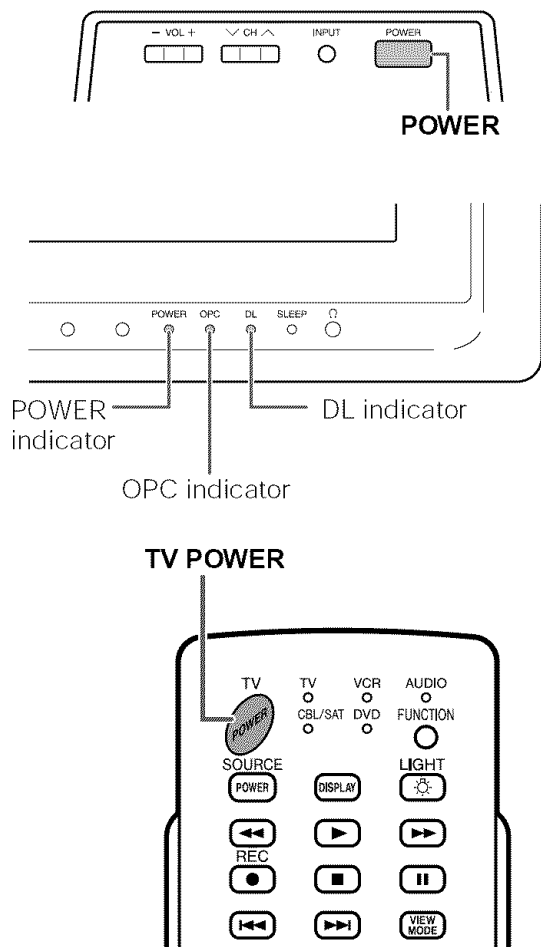

TV status indicator (POWER)

ON	Lighting (Blue)
OFF/Standby	Lights off

TV status indicator (OPC)

"Off" is selected in OPC setting	Lights off
"On" or "On: Display" is selected in OPC setting	Lighting (Green)

TV status indicator (DL)

CableCARD security module is downloading data	Lighting (Red)
TV Guide On Screen system is downloading data	Lighting (Red)
Timer recording (in TV Guide On Screen system) is in progress	Lighting (Red)
TV Guide On Screen system is preparing to start timer recording or display reminder screen	Lighting (Red)

*OPC: Optical Picture Control

*DL: DownLoad

Initial setup

When you turn on the TV for the first time, it will automatically memorize the broadcasting channels where you live. Perform the following steps before you press **TV POWER** on the remote control unit.

1. Insert the batteries into the remote control unit. (See page 8.)
2. Connect the antenna cable to the TV. (See page 17.)
3. Plug in the AC cord to the AC outlet. (See page 6.)

1 Language setting

Select from among 3 languages: English, French and Spanish.
Press **▲/▼** to select the desired language listed on the screen, and then press **ENTER**.

2 Standby Mode setting

Select the standby setting. (See page 40.)

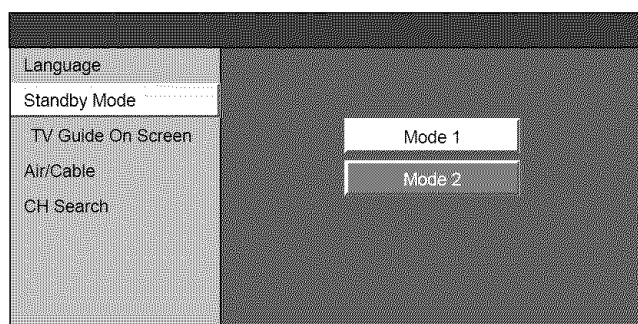

Mode 1: Starting TV is quick from standby.

Mode 2: Power consumption is small at the standby.

NOTE

- When the CableCARD security module is inserted, power consumption will be higher.

3 TV Guide On Screen setting

Press **ENTER** to continue the setting. (See page 21.)

4 Antenna setting

Make sure what kind of connection is made with your TV.

Press **◀/▶** to select "Air", "Cable" for ANALOG, then press **▼** to move down.

Press **◀/▶** to select "Standard", "HRC" or "IRC" for DIGITAL (Cable).

Press **ENTER** to enter the setting.

- There are 3 kinds of CATV system, including Standard, HRC and IRC. Select the one that matches to your TV.

NOTE

- Some items are not selectable because the antenna setting is linked to the TV Guide On Screen setting.
- DIGITAL (Cable) setting cannot be selected when a proper CableCARD security module is inserted.

5 Channel search

Channel auto search makes the TV look for all channels viewable in the set area.

Press **◀/▶** to select "Yes" for ANALOG, then press **▼** to move down.

Press **◀/▶** to select "Yes" for DIGITAL (Air), then press **▼** to move down.

Press **◀/▶** to select "Yes" for DIGITAL (Cable), and press **▼** to move down.

Select "Search Start", and then press **ENTER**.

- This operation makes the TV search for both ANALOG, DIGITAL (Air) and DIGITAL (Cable) channels.

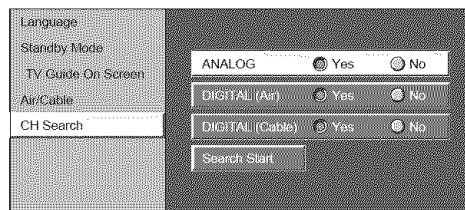

Example

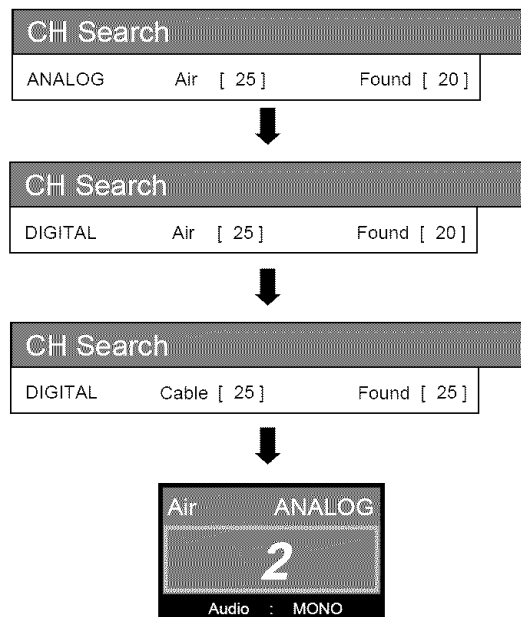

NOTE

- Make sure what kind of connection is made with your TV.
- If no channel is found, make sure what kind of connection is made with your TV and try EZ setup again. (See page 38.)

Using the TV Guide On Screen™ (Interactive Program Guide)

The TV Guide On Screen system is a free, on-screen interactive television program guide ("IPG") built into your LCD-TV. The TV Guide On Screen system was developed to help today's TV viewers, overwhelmed by myriad viewing choices, find what they want to watch quickly and easily, directly from their TV screen. The TV Guide On Screen system displays all the major TV channels and programs available in the viewer's household.

NOTE

- Over-the-air or cable access to stations carrying TV Guide On Screen data is required for the TV Guide On Screen system to operate. The data provider may elect to discontinue the service or it may cease to be available in your area. In either of these cases, the TV Guide On Screen feature will not function. Also, since the program information provided by TV Guide On Screen system is based on your location, you will need to run SETUP again if you move to a different ZIP or postal code.

About the Key features of TV Guide On Screen

LISTINGS Service

- Displays eight days of viewers' local program listings and descriptions for broadcast and cable.
- Viewers can tune to any program, schedule a program to record, or set a reminder.
- The Video Window lets viewers monitor the last channel tuned while viewing program listings, or preview channels as they page through listings.
- Color-coded program genres help viewers quickly identify movies, sports, and children's programming.

SEARCH Feature

- Viewers can search for programs by categories such as HDTV, movies, sports or children's shows. Within categories, viewers can sort by show type, such as baseball or football.
- Viewers can sort alphabetically, or by a keyword such as a show title or a starring actor.

One-touch Recording

- To record, viewers simply highlight a program title and then press a button on the remote control. TV Guide On Screen will automatically record the program.
- Programs may be set to record one time or every time they air.

NOTE

- A VCR or a supported i.LINK recording device is required for one-touch recordings. If you connect a VCR, it is recommended that you connect it according to the instructions on pages 9 and 49.

Reminder Feature

- Viewers may set reminders to ensure they never miss their favorite programs.
- Reminders can even be set to automatically turn on the TV when a program begins.

Important!

The TV Guide On Screen system automatically comes up when you turn on the LCD-TV. You can turn off this feature by changing default options. (See page 31 for details.)

Screen Components

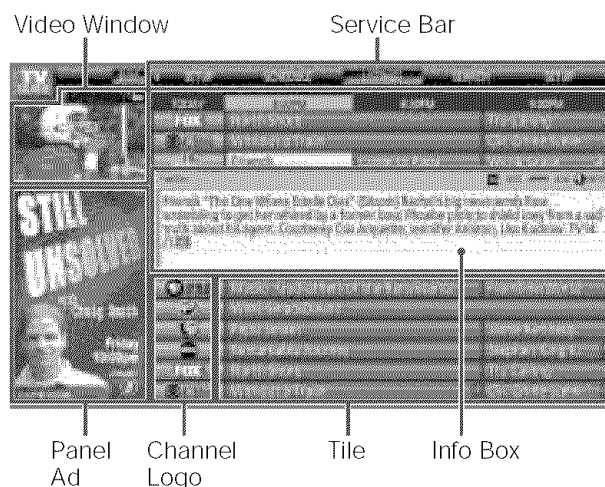

Video Window - displays the last TV program or the preview of the next TV program

Service Bar - provides access to the 4 main Guide Services (LISTINGS/SEARCH/SETUP/SCHEDULE)

Tile - displays program title

Info Box - provides information for a highlighted item

Channel Logo - identifies network

Panel Ad - displays promotional information

The screening times of the selected programs Names and categories of the selected programs

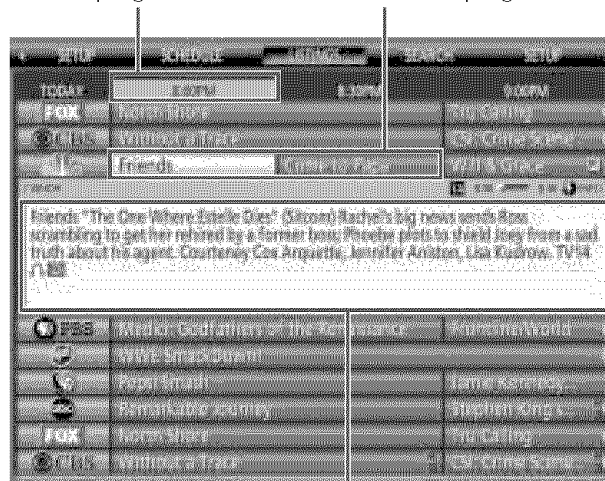

Information on the selected programs

Watching TV (TV Guide On Screen)

Info Box

Info Box contains information about a show, service, ad, or provides general help. A Show Listing Info Box can have up to three sizes: Small, Large, and "No". The default size of the Info Box is Small. Press **INFO** to cycle among the sizes.













Info Button

The Info button appears on the button bar, if the Info box size can change and/or if there are additional Info screens.

- Press **INFO** on the remote control to cycle between Info box sizes, as available.
- In some instances, the Info key is used to page forward, if there are additional pages of information, such as a Panel Ad, Channel Ad, or help text.

Icons

The following icons indicate the current program information and the current and future actions & status.

Name	Icon	Description
INFO button		• Display the additional information.
Progress bar		• Elapsed time in current program. This appears in LISTINGS, SEARCH and when INFO is pressed while watching TV.
HDTV		• The program is presented in High-Definition TV, if available.
New		• The program is new (not a repeat program).
Stereo		• The program is available in Stereo.
CC		• Closed Caption is available for the program.
TV Rating		• TV rating for the program.
Record once		• The program is set to record once. Other frequencies are Daily (manual recording only), Regularly, and Weekly.
Record off		• The program is set to Record but is currently off. (The program remains in schedule.)
Record suspend		• The program is suspended due to a schedule conflict. (The program remains in Schedule.) • Recording resumes when the conflict no longer exists.
Remind once		• The program is set to remind once. Other frequencies are Daily (manual reminder only), Regularly, and Weekly.
Remind off		• The program is set to remind but is currently off. (The program remains in Schedule.)
Remind suspend		• The program is suspended due to a schedule conflict. (The program remains in Schedule.) • Remind resumes when the conflict no longer exists.

IMPORTANT: When using TV Guide On Screen or if program information does not download, please follow the instructions below.

The TV must be off to download information. Leave your TV off overnight to receive the initial download in your area. (Refer to Troubleshooting-TV Guide On Screen on page 82 for details.)

TV Guide On Screen Initial setup

The Guide uses Setup information to provide you with show listings and lineups in your area - which are updated several times a day. Once you setup the LCD-TV according to this operation manual, you are ready to set up TV Guide On Screen.

1

Press **TV GUIDE** to start setup.

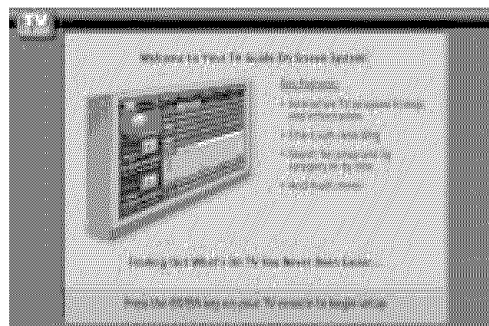

2

Press **ENTER**. Basic initial setup will start.

Reminder screen

If you previously skipped Guide setup you will see the Reminder Screen when you power on your LCD-TV.

1

- Press **▲/▼** to select an option.
- "Set up TV Guide On Screen now": Basic initial setup will start.
 - "Remind me to set it up later": Returns to watching TV.
 - "Don't remind me again": Returns to watching TV and stops the reminder screen from appearing upon powering on.

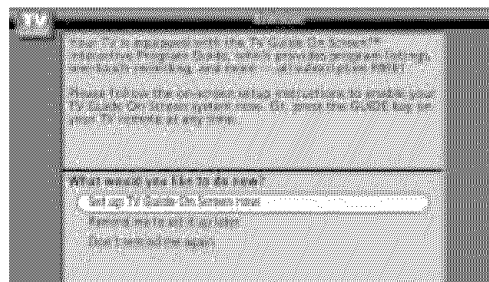

NOTE

- If you decide not to set up the Guide now, this reminder screen will appear each time you power on the LCD-TV (except if you selected "Don't remind me again").

Watching TV (TV Guide On Screen)

Basic initial setup

Follow the on-screen prompts to configure the basic settings.

1

Select your location.

- 1 Press ▲/▼ to select the country.
- 2 Enter the ZIP code (or postal code) for your location using the number buttons or ▲/▼.

2

Indicate the cable service connection.

Press ▲/▼ to select "Yes" or "No", and then press **ENTER**.

- If your answer is "No", skip to step 10.

3

Indicate the cable box connection.

Press ▲/▼ to select "Yes" or "No", and then press **ENTER**.

- If your answer is "No", skip to step 11.

NOTE

- To receive TV program listings in the TV Guide On Screen system, please ensure to connect your cable box to the input marked "VIDEO", if you are connecting your cable box to your TV using INPUT 1 or INPUT 2. Do not connect the cable box to the "COMPONENT" video of INPUT 1 or INPUT 2, as you will not receive any TV program listings through this input.

4

Indicate which input the cable box is plugged into.

Press ▲/▼ to select the input you connected, and then press **ENTER**.

- To receive TV program listings in the TV Guide On Screen system, if you select "Input 1" or "Input 2", please ensure your cable box is connected to the input marked "VIDEO", and proceed to step 6. Do not connect your cable box to the "COMPONENT" video of INPUT 1 or INPUT 2, as you will not receive any TV program listings. If you select "Analog" input, proceed to step 5.

5

Indicate the channel your TV is tuned to when using the cable box.

Press ▲/▼ to select from "Ch 2", "Ch 3" and "Ch 4", and then press **ENTER**.

- Please consult your cable provider if you are unsure.

6

The diagram on the screen shows the correct way to connect the G-LINK cable from the back of the TV to the cable box. Make sure the G-LINK cable is properly connected, and then press **ENTER**.

7

Indicate the cable box brand name.

Press ▲/▼ to select the cable box brand, and then press **ENTER**.

- Press ▲/▼ to view more cable box brands.

8

The TV Guide On Screen is now ready for testing. Do the following:

- 1 Tune your cable box to channel 02.
- 2 Make sure to leave your cable box turned on, and then press **ENTER**.

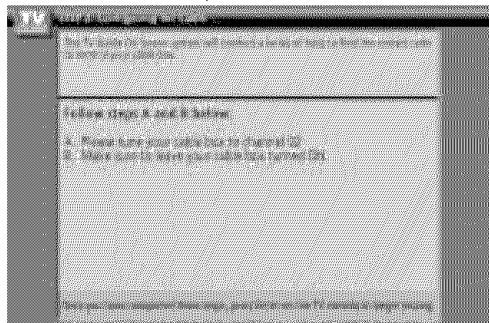

The TV Guide On Screen system will conduct a series of tests and when the testing is completed the next screen will be displayed automatically.

Do not press any buttons while testing is in progress.

9

Confirm that your cable box is now tuned to channel 09.

Press ▲/▼ to select "Yes", "No" or "Test this code again", and then press **ENTER**.

- If you select "Yes", go to the next step.
- If you select "No", a different code is tested in the previous screen.
- If you select "Test this code again", the same code is tested again in the previous screen.

10

Indicate the antenna connection.

Press ▲/▼ to select "Yes" or "No", and then press **ENTER**.

- If you select "Yes", go to the next step.
- If you selected "No" in step 2, you must connect an antenna to your TV and select "Yes" to receive a channel lineup and listings.

11

Confirm the settings.

Confirm the settings displayed on the screen and press ▲/▼ to select "Yes, end setup" or "No, repeat setup process", and then press **ENTER**.

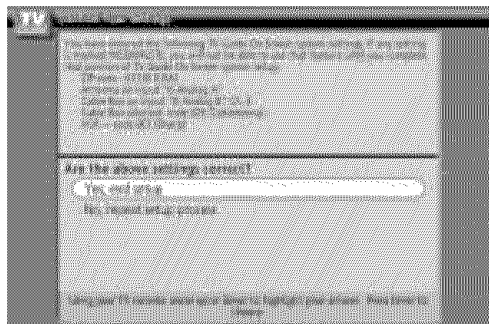

Press **ENTER** to continue.

NOTE

- Please do not use the CableCARD security module while using cable box.

Watching TV (TV Guide On Screen)

VCR setting

Connect a VCR to your TV and use the TV Guide On Screen system's program listings to easily schedule recordings using the one-touch recording feature.

1 Set TV Guide On Screen to control your VCR.

Press **▲/▼** to select "Yes, setup VCR control", and then press **ENTER**.

- If you select "Yes", go to the next step.
- If you select "No", setup will end.

2 This screen shows the correct way to connect the G-LINK cable from the back of the TV to the recording device. Make sure the G-LINK cable is properly connected, and then press **ENTER**.

3 Indicate the VCR brand name.

Press **▲/▼** to select the VCR brand, and then press **ENTER**.

4 The TV Guide On Screen is now ready for testing. Do the following:

- ① Turn on your VCR and insert a tape.
- ② Play the media on the VCR, and then press **ENTER**.

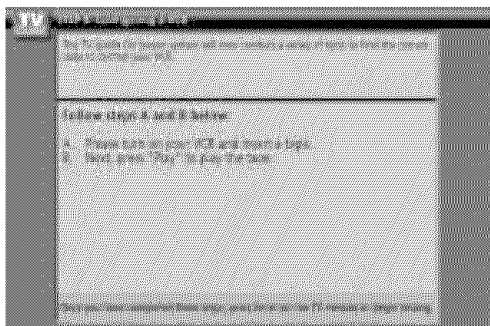

The TV Guide On Screen system will conduct a series of tests and when the testing is completed the next screen will be displayed automatically.

Do not press any buttons while testing is in progress.

5 Confirm that your VCR has stopped playing.

Press **▲/▼** to select "Yes", "No" or "Test this code again", and then press **ENTER**.

- If you select "Yes", go to the next step.
- If you select "No", a different code is tested in the previous screen.
- If you select "Test this code again", the same code is tested again in the previous screen.

6 Confirm the settings.

Confirm the settings displayed on the screen and press **▲/▼** to select "Yes, end setup" or "No, repeat setup process", and then press **ENTER**.

Press **ENTER** to complete the SETUP.

NOTE

- Up-to-date listings will begin loading over the next 24 hours when your LCD-TV is powered off. (Do not unplug the AC cord.)
- It may take more than one day for all eight days of listings to update. The guide will automatically receive updates during the period when your LCD-TV is turned off.
- To receive your channel lineup and program listings, leave your cable box on. Your VCR and LCD-TV should be turned off overnight. (Do not unplug the AC cord.)
- To record a TV program, make sure your cable box is on. Put a tape in your VCR, tune the device to the Line input, then turn the VCR off. (Do not unplug the AC cord.)
- You must redo the TV Guide On Screen system setup if you:
 - Move your LCD-TV to a new ZIP or postal code.
 - Cancel cable service or change cable boxes.
 - Change your VCR brand or model.

7 Press **ENTER** twice to watch TV.

Using TV Guide On Screen

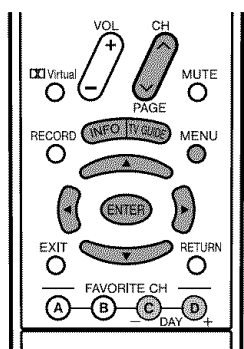

Basic buttons on the remote control

Button	Description
TV GUIDE	<ul style="list-style-type: none"> When watching TV, enters the Guide and highlights a program listing. When in the Guide, exit the Guide without changing channels.
INFO	<ul style="list-style-type: none"> The Info Box contains information about a program, service, ad, or provides general help. The size of the Info Box can be set to "Small" or "Large", or not to be displayed by selecting "No". The default size of the Info Box is "Small". Press INFO to cycle among "Small", "Large" and "No".
▲/▼/◀/▶	<ul style="list-style-type: none"> Provides directional control. When watching TV, press ▲/▼ to scroll through the channel list.
ENTER	<ul style="list-style-type: none"> Makes a selection or executes an action. With a currently airing program listing highlighted, returns to normal TV viewing and tunes to the program channel. With a future airing program listing highlighted, displays a Panel menu with viewing options.
DAY -/+ ◀/▶	<ul style="list-style-type: none"> Shows the program listing for a different day. Selects the time on the changed listing.
MENU	<ul style="list-style-type: none"> Display the Options for the Guide.
PAGE ▲/▼ (CH ▲/▼)	<ul style="list-style-type: none"> Moves one page up or one page down in the LISTINGS grid.

● How to go to Service Bar

The service provided by TV Guide On Screen is composed of four services: SETUP, LISTINGS, SEARCH and SCHEDULE. To make detailed settings for each service, it is necessary to select the service bar and change the selected service.

- 1 Press **MENU** to display "Service Options".
- 2 Press ▲/▼ to select "go to Service Bar".
- 3 Press **ENTER**.

Video Window

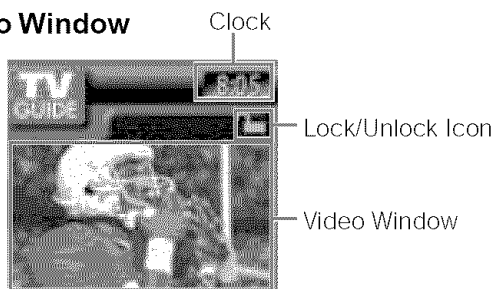

When you enter the Guide, the TV program for the current show appears in the Video Window. The Video Window also includes a clock display and a lock/unlock icon to indicate the status of the Video Window. You can set the Video Window to remain on a single channel (locked) or change channels (unlocked) as you navigate through Listings.

How to set the Video Window

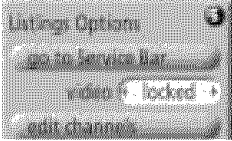
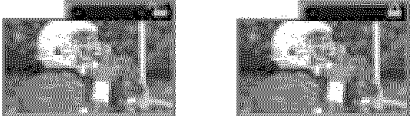
- 1 Press ◀/▶ to highlight the desired Channel Logo.
- 2 Press **MENU** to display the Listings Options.
 
- 3 Press ▲/▼ to select "video" and then press ◀/▶ to select "locked" or "unlocked".
 

NOTE

- The TV Guide On Screen menus shown in this manual are for illustration purposes only. The channels, programs, and TV Guide On Screen information illustrated in this manual may not be available in your area. The options and features illustrated in this manual are subject to change when updates are downloaded from the TV Guide On Screen service to your TV.
- The TV Guide On Screen system does not display program listings for satellite TV systems.

Choosing a program to watch - Using the LISTINGS

- 1 Press **TV GUIDE**.
- 2 Press ▲/▼/◀/▶ to select the program to watch, and then press **ENTER**.

NOTE

- The current position of the cursor is highlighted in yellow.
- To cancel the Guide screen, press **TV GUIDE**.

Changes the day from within LISTINGS

- Press **DAY -** or **DAY +** to select the day you want to check the TV program table.

Watching TV (TV Guide On Screen)

Searching programs

You can search for programs alphabetically, by category - HDTV, MOVIES, SPORTS, CHILDREN, EDUCATIONAL, NEWS, VARIETY, SERIES - or by keyword, and the result is displayed in a list.

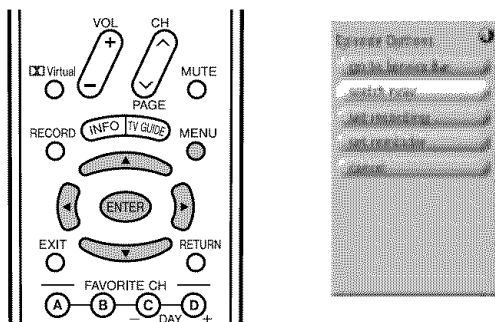

● Search by category

You can search for programs by specifying category in the "Confirmation" screen.

1 When the LISTINGS screen is displayed, press **MENU**. Press **▲/▼** to select "go to Service Bar" from the "Episode Options" menu, and press **ENTER**.

2 Press **◀/▶** to select "SEARCH" and then press **ENTER** or **▼**.

3 **Example: Searching for a program in the category "MOVIES".** Press **◀/▶** buttons to select "MOVIES" (=Search type) and press **▼** to display the movies genre.

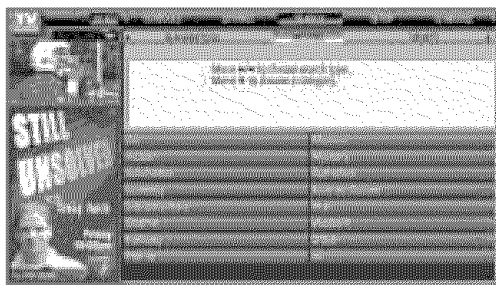

4 Press **▲/▼/◀/▶** to select a genre within "MOVIES". (e.g.: select "ALL" and press **ENTER**)

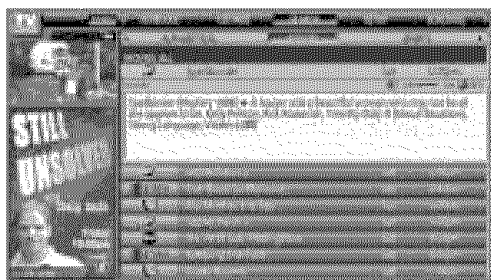

5 Press **▲/▼** to select a program you want to watch, and then press **ENTER**.

NOTE

- Repeat the same steps for the other categories.
- When you want to record a program found during a search, press **MENU** and after "Episode options" displays, carry out "Set recording". (See page 27.)

● Search by keyword

Keyword Search lets you enter a word to look for, a particular program by category or for every program title that matches.

1 Repeat steps 1 to 2 in **Search by category**.

2 Press **◀/▶** to select "KEYWORD", and then press **ENTER** to display the "Keyword Search" menu.

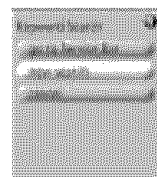

3 Press **▲/▼** to select "new search", and then press **ENTER** to display the "Search Options" menu.

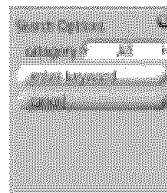

4 Press **▲** to select "category" to search, and then press **◀/▶** to select the desired category.

5 Press **▼** to select "enter keyword", and then press **ENTER**. Press **▲/▼/◀/▶** to select a character, and press **ENTER** to display it. When complete, press **▲/▼/◀/▶** to select "DONE" and press **ENTER**.

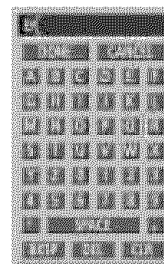

NOTE

- BKSP: Backspace
- DEL: Delete
- CLR: Clear

6 A list of all matching programs is displayed. Press **▼** to highlight the program you want to watch, and press **ENTER**.

Watching TV (TV Guide On Screen)

Edit keyword

This Guide stores all the keywords you created.

1 When the LISTINGS screen is displayed, press **MENU**. Press **▲/▼** to select "go to Service Bar" from the "Episode Options" menu, and press **ENTER**.

2 Press **◀/▶** to select "SEARCH" and then press **ENTER** or **▼**.

3 Press **◀/▶** to select "KEYWORD".
• The keyword list is displayed.

4 Press **▲/▼** to select the keyword you want to edit.

5 Press **MENU** to display the "Search Options" menu.

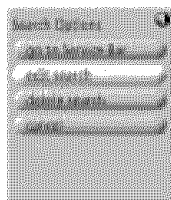

6 Press **▼** to select "edit search", and press **ENTER**.

Delete keyword

Keywords may be deleted from the keyword list.

1 Repeat steps 1 to 2 in **Edit Keyword**.

2 Press **◀/▶** to select "KEYWORD".

3 Press **▲/▼** to select the keyword you want to delete.

4 Press **MENU** to display "Search Options" menu.

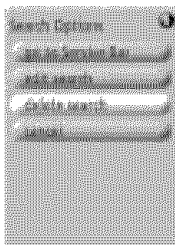

5 Press **▼** to select "delete search", and press **ENTER**.

6 Press **▲/▼** to select "Yes" to delete the keyword, or "No" to close the "Search Options" menu.

ALPHABETICAL search

1 Repeat steps 1 to 2 in **Edit Keyword**.

2 Press **◀/▶** to select "ALPHABETICAL".

3 Press **▲/▼/◀/▶** to select the initial letter of the program.

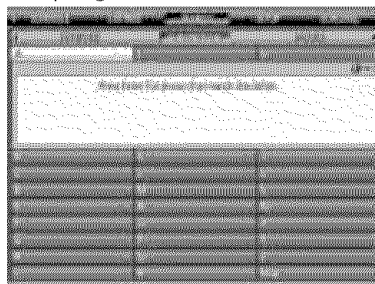

4 Press **ENTER** and then the search result displays.

5 Press **MENU** to display "Episode Options".

6 Press **▲/▼** to select "tune to channel". You can watch the program on the LCD-TV.

NOTE

- On the "Episode Options", if you want to set timer recording, select "set recording". (See page 27.)
- If you want to set the reminder function for this program, select "edit reminder". (See page 29.)

Program recording using LISTINGS function

You can set any programs to record on a G-LINK connected recording device (VCR) directly from the LISTINGS for the appropriate day.

● Set recording

1 Press **▲/▼/◀/▶** to select the program you want to record in the LISTINGS.

2 Press **MENU** to display "Episode Options". Press **▲/▼** to select "set recording", and then press **ENTER** to display "Record Options".

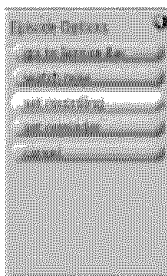

3 Press **▲/▼/◀/▶** to set the following items.

Setup items	Selectable items	Description
frequency	once/regularly/weekly/off	Set the recording cycle
start	on time/120 min early ... 120 min late	Set the start timing of recording
end	on time/120 min early ... 120 min late	Set the end timing of recording
recorder	VCR/i.LINK	Set the external recording device

4 Press **ENTER** to highlight "schedule recording".

5 Press **ENTER** again to exit.

NOTE

- Device must be selected beforehand when using i.LINK as a recording device.

Using RECORD button on the remote control

1 Press **▲/▼/◀/▶** to select the program you want to record on the LISTINGS.

2 By pressing **RECORD**, the program you want to record is set to record on time. "on time" is the default setting and can be changed.

NOTE

- Each time you press **RECORD**, you can change the record frequency.

Using Reminder function

You can set this function to remind you of the screening times for programs from LISTINGS and of programs you have set to record.

Using Episode Options

1 Press **MENU** to display "Episode Options". Press **▲/▼** to select "set reminder", and then press **ENTER** to display "Remind Options".

2 Press **▲/▼/◀/▶** to set the following items.

Setup items	Selectable items	Description
frequency	once/regularly/weekly/off	Set the reminder cycle
power on TV	yes/no	When this is set to "yes", the TV will automatically switch on at the time the reminder was set for.
auto tune TV	yes/no	When this is set to "yes", the channel will be automatically changed before the reminder screen is displayed.
when	on time/30 sec - 15 min early ... 30 sec - 15 min late	Set the timing to perform above two functions

3 Press **ENTER** to highlight "schedule reminder".

4 Press **ENTER** again to exit.

Using SCHEDULE function

The SCHEDULE is a list of programs created whenever you set a recording, or a reminder to watch a program. You can use this list to edit or delete the reminders and recordings you have set.

1 Press **MENU** to display "Episode Options". Press **▲/▼** to select "go to Service Bar", and then press **ENTER**.

2 Press **◀/▶** to select "SCHEDULE".

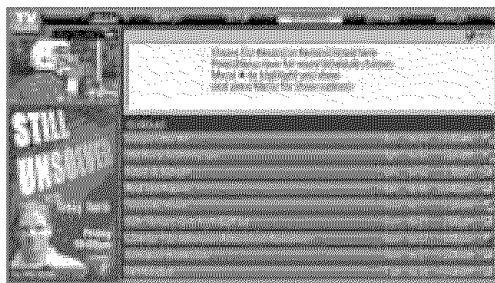

The program listings in SCHEDULE display a range of icons and show information about the settings for each program.

Function	Icon	Description
Record (Using "Record Options")	Once	Records the program one time.
	Daily	Indicates the program is set to record daily (manual record setting only).
	Regularly	Records the program every time the program airs on the same channel and starts at the same time.
	Weekly	Records the program each time the program airs on the same day of the week, on the same channel and starts at the same time.
	Off	Keeps the program in the list but will not record this program until the frequency is changed.
	Suspend	<ul style="list-style-type: none"> The program is suspended due to a schedule conflict. (The program remains in Schedule.) Recording resumes when the conflict no longer exists.
Remind (Using "Remind Options")	Once	Set a program reminder one time.
	Daily	Indicates the program is set to remind daily (manual remind setting only).
	Regularly	Set a program reminder every time the program airs on the same channel and starts at the same time.
	Weekly	Set a program reminder each time the program airs on the same day of the week, on the same channel and starts at the same time.
	Off	Keeps the program in the list but will not remind this program until the frequency is changed.
	Suspend	<ul style="list-style-type: none"> The program is suspended due to a schedule conflict. (The program remains in Schedule.) Remind resumes when the conflict no longer exists.

Sort programs

You can sort Record and Remind programs in SCHEDULE list.

1 Press **MENU** to display "Schedule Options".



2 Press **◀/▶** to select how to sort the SCHEDULE.

Selected item	Description
date	Both Record and Remind programs are intermixed and sorted by scheduled date, with the next scheduled program at the top.
title	Both Record and Remind programs are intermixed and sorted by program title into alphabetical order.
event	Sorts first Record programs and then Remind programs, by date.

3 Press **▲/▼** to select "done".

Watching TV (TV Guide On Screen)

Delete recording

- 1 Repeat steps 1 and 2 in **Using SCHEDULE function**.
- 2 Press **▲/▼** to select the program you want to delete.
- 3 Press **MENU** to display "Schedule Options".
- 4 Press **▲/▼** to select "delete recording", and then press **ENTER**.
 - Confirmation screen displays.
- 5 Press **▲/▼** to select "yes" or "no".

Edit recording

- 1 Repeat steps 1 to 2 in **Using SCHEDULE function**.
- 2 Press **▲/▼** to select the program you want to edit.
- 3 Press **MENU** to display "Schedule Options".
- 4 Press **▲/▼** to select "edit recording", and then press **ENTER** to display "Record Options".
 - You can change the setting items again.
- 5 Press **ENTER** to highlight "schedule recording".
- 6 Press **ENTER** again to exit.

Edit reminder

- 1 Repeat steps 1 to 2 in **Using SCHEDULE function**.
- 2 Press **▲/▼** to select the program for which you want to set the reminder.
- 3 Press **MENU** to display "Schedule Options".
- 4 Press **▲/▼** to select "edit reminder", and then press **ENTER** to display "Remind Options".
 - You can change the setting items again.
- 5 Press **ENTER** to highlight "schedule reminder".
- 6 Press **ENTER** again to exit.

New manual recording

Aside from setting recordings using the program LISTINGS menus, you can also define the schedule of recordings manually by following the steps below.

- 1 Press **▲/▼** to select the program you want to record.
- 2 Press **MENU** to display "Record Options".
- 3 Press **▲/▼** to select "new manual recording" and then press **ENTER**.

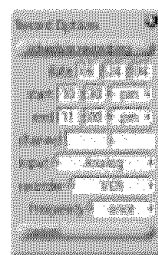

- "Record Options" screen displays.

Setup items	Selectable items	Description
date	—	Set a date to record
start	—	Set a start time to record
end	—	Set an end time to record
channel	—	Set a channel to record using 0-9
input	analog/digital air/ digital cable/input 1/ input 2/input 3	Set the external recording device or antenna source
recorder	VCR/i.LINK	Select a recorder you connected
frequency	once/weekly/daily/off	Set the recording cycle

- 4 Press **ENTER** to highlight "schedule recording".
- 5 Press **ENTER** again to exit.

NOTE

- The program set to be manually recorded is listed by channel number in the SCHEDULE.

Watching TV (TV Guide On Screen)

New manual reminder

Instead of setting a reminder from the program LISTINGS, you can set a reminder manually for a program that you want to watch or a recording you have set.

1 Press **▲/▼** to select the program you want to set reminder.

2 Press **MENU** to display "Remind Options".

3 Press **▲/▼** to select "new manual reminder" and then press **ENTER**.

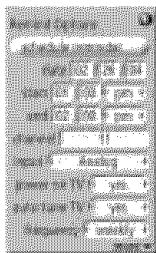

• "Remind Options" screen displays.

Setup items	Selectable items	Description
date	—	Set a date to remind
start	—	Set a start time to remind
end	—	Set an end time to remind
channel	—	Set a channel to remind using 0-9
input	analog/digital air/ digital cable/input 1/ input 2/input 3	Set the external device or antenna source
power on TV	yes/no	When this is set to "yes", the TV will automatically switch on at the time the reminder was set for.
auto tune TV	yes/no	When this is set to "yes", the channel will be automatically changed before the reminder screen is displayed.
frequency	once/weekly/daily/off	Set the reminder cycle

4 Press **ENTER** to highlight "schedule reminder".

5 Press **ENTER** again to exit.

NOTE

- The program set to be manually reminded is listed by channel number in the SCHEDULE.

Changing system settings

After you initially complete Guide Setup, you can make changes to System settings in the "SETUP" screen.

1 Press **TV GUIDE** and then press **MENU**.

2 Press **▲/▼** to select "go to Service Bar" in "Episode Options", and then press **ENTER**.

3 Press **◀/▶** to select "SETUP".

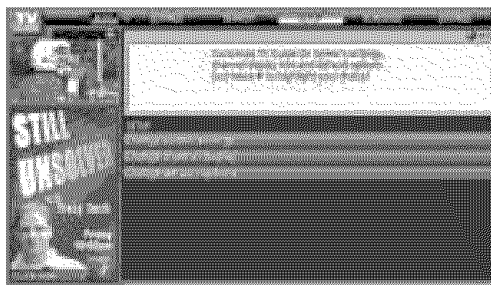

4 Press **▼** to select "Change system settings".

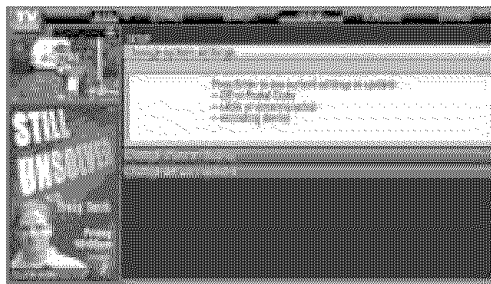

5 Press **ENTER** to display the "Confirming Your Settings" screen.

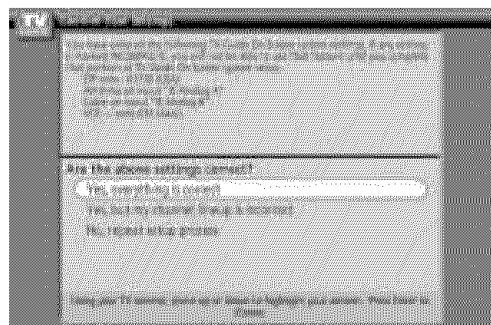

- If you want to change System settings, select "No, repeat setup process" and then press **ENTER**.
- If the setting details displayed on the screen is correct, select "Yes, everything is correct", and then press **ENTER**.
- If the channel lineup is incorrect, select "Yes, but my channel lineup is incorrect", and then press **ENTER**.

Watching TV (TV Guide On Screen)

Changing channel display

This setting lets you edit channel information that appears in LISTINGS.

You can set each function as follows:

1. Re-order the position the channel appears in LISTINGS
2. Change the channel number
3. Switch a channel
 - **On** - the channel is always displayed
 - **Off** - the channel is never displayed
 - **Auto-Hide** - the channel is only displayed when program information is available

1 Press **TV GUIDE** and then press **MENU**.

2 Press **▲/▼** to select "go to Service Bar" in "Episode Options", and then press **ENTER**.

3 Press **◀/▶** to select "SETUP".

4 Press **▲/▼** to select "Change channel display", and then press **ENTER**.

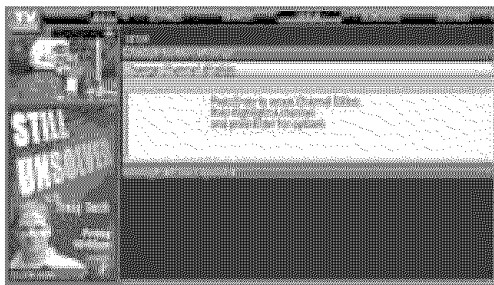

5 Press **ENTER** to display the "Grid Options" screen.

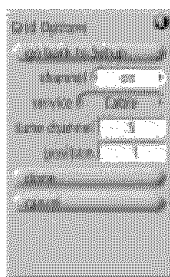

6 Press **▲/▼/◀/▶** to set the following items.

Selected item	Description
channel	off/on/auto-hide
service	Air/Cable/cable box
tune channel	Set the channel number you want to display
position	Set the channel display position

- Depending on the channel currently being received you may be able to select "service".

7

Press **▲/▼** to select "done", and then press **ENTER** to exit.

Changing default options

This setting lets you change the default settings as follows.

General default options

1

Repeat steps 1 to 3 in **Changing channel display**.

2

Press **▼** to select "General default options", and press **ENTER**.

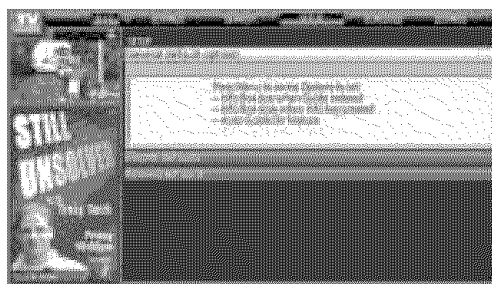

3

Press **MENU** to display "General Defaults".



4

Press **▲/▼/◀/▶** to set the following items.

Setup items	Selectable items	Description
info box size	last used/no/small/large	Set the initial info box size when you enter the TV Guide On Screen
box cycle	all/no only/small only/large only/no & small/no & large/small & large	Set the info box rotation when you press INFO
auto guide	on/off	When this is set to "on", automatic entry into the TV Guide On Screen when you turn on the TV

5

When you have finished, press **▲/▼** to select "done", and then press **ENTER** again to exit.

Watching TV (TV Guide On Screen)

Record default options

1 Press **TV GUIDE** and then press **MENU**.

2 Press **▲/▼** to select "go to Service Bar" in "Episode Options", and then press **ENTER**.

3 Press **▼** to select "Record defaults", and press **ENTER**.



4 Press **ENTER** to display "Record Defaults".

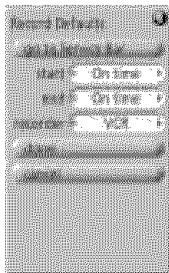

5 Press **▲/▼/◀/▶** to set the following items.

Setup items	Selectable items	Description
start	on time/120 min early ... 120 min late	Set the start timing of recording
end	on time/120 min early ... 120 min late	Set the end timing of recording
recorder	VCR	Set the external recording device

6 When you have finished, press **▲/▼** to select "done", and then press **ENTER** again to exit.

Remind Default Options

1 Press **TV GUIDE** and then press **MENU**.

2 Press **▲/▼** to select "go to Service Bar" in "Episode Options", and then press **ENTER**.

3 Press **▼** to select "Remind defaults", and then press **ENTER**.

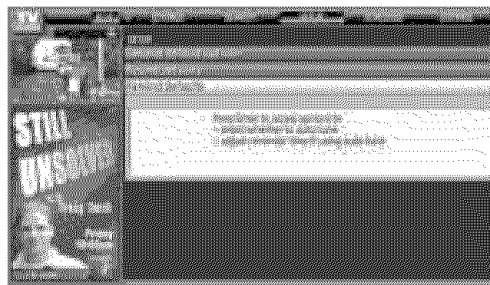

4 Press **ENTER** to display "Remind Defaults".

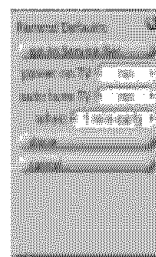

5 Press **▲/▼/◀/▶** to set the following items.

Setup items	Selectable items	Description
power on TV	yes/no	When this is set to "yes", the TV will automatically switch on at the time the reminder was set for.
auto tune TV	yes/no	When this is set to "yes", the channel will be automatically changed before the reminder screen is displayed.
when	on time/30 sec - 15 min early ... 30 sec - 15 min late	Set the timing to perform above two functions

6 When you have finished, press **▲/▼** to select "done", and then press **ENTER** again to exit.

Watching TV

Changing channels-Air/Cable

You can change channels in several ways by pressing **AIR** or **CABLE** to select the antenna and then following one of the methods below .

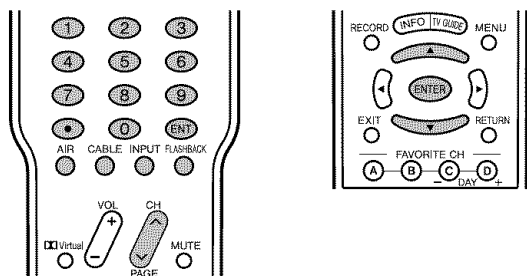

Method 1

Using **CH** \wedge \vee on the remote control unit or on the TV.

Method 2

1. Press **FLASHBACK** to switch to the previously tuned channel.
2. Press **FLASHBACK** again to switch back to the currently tuned channel.

NOTE

- **FLASHBACK** will not work if no channel has been changed after TV is turned on.

Method 3

Using remote control buttons **0-9**, **•** (DOT) to select channels for VHF/UHF/CATV/DIGITAL.

To select a 1 or 2-digit channel number (e. g., Channel 5):

Press 5 → **ENT**

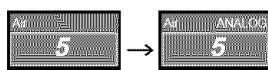

NOTE

- When selecting a 1-digit channel number, it is not necessary to press **0** before the number.
- When you enter **0-9** only, channel selection will be made if there is no operation for a few seconds.

To select a 3-digit channel number (e. g., Channel 115):

Press 1 → 1 → 5

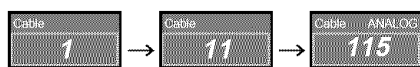

To select a 4-digit channel number (e. g., Channel 22.1):

Press 2 → 2 → **•** (DOT) → 1 → **ENT**



NOTE

- When you enter **0-9** only, channel selection will be made if there is no operation for a few seconds.
- If you push "0" by itself, nothing will happen.
- Complete the above steps within a few seconds.
- When you enter **0-9** and **•** (DOT), channel selection will be made if there is no operation for a few seconds.

Method 4

1. Press **INPUT**.
2. Press \blacktriangle / \blacktriangledown to select CableBox [TV], and then press **ENTER**.

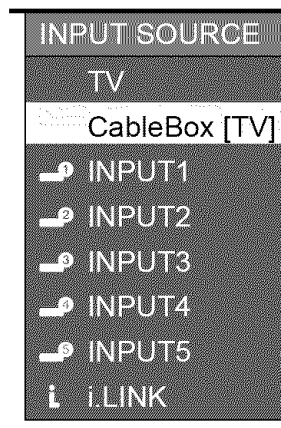

3. Press **CH** \wedge \vee to change the channel of the cable box.

Watching TV

Changing volume/sound

■ Changing the volume

You can change the volume on the TV or on the remote control unit.

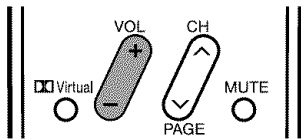
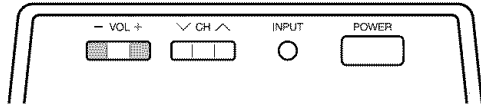

■ Using VOL +/-

- To increase the volume, press **VOL +**.
- To decrease the volume, press **VOL -**.

Volume adjustment



NOTE

- **VOL -/+** on the TV operates the same as **VOL +/-** on the remote control unit.

Audio status

Output device	Output Select	
	Fixed	Variable
Speaker	Variable sound	Mute
MONITOR OUT	Constant as specified	Variable sound

* When "Output Select" is set to "Variable", the indicator on the screen changes as shown below.



NOTE

- See page 66 for details on the output select function.

■ Using MUTE on the remote control unit

Mutes the current sound output.

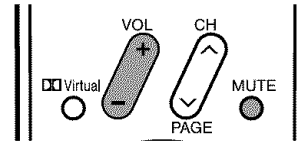

1

Press **MUTE**.

- "⊘" will be displayed on the screen for 30 minutes, and the sound is silenced.

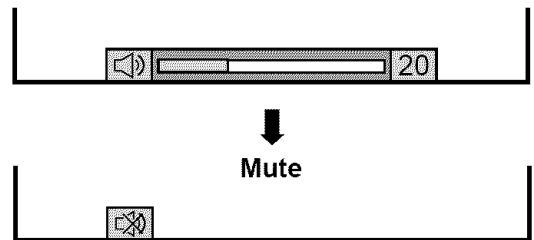

NOTE

- Within 30 minutes of pressing **MUTE**, mute can be canceled by using one of the methods below.
 - Mute will cancel if you press **VOL -/+** or **MUTE**.
- Mute will be canceled after 30 minutes have passed. However, the TV will not suddenly output a loud sound as the volume level is set to 0 automatically.

■ Using Virtual on the remote control unit

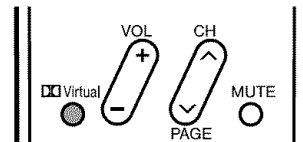

Virtual produces Dolby Virtual effect from the speakers. Each time you press **Virtual**, the mode changes between On and Off.

Dolby Virtual sound options

- On: Makes it possible to enjoy natural, realistic surround sound.
- Off: Outputs the normal sound.



NOTE

- You can have the same settings by choosing "Dolby Virtual" on the menu items. (See page 44.)

Setting MTS/SAP stereo mode

The TV has a feature that allows reception of sound other than the main audio for the program. This feature is called Multi-channel Television Sound (MTS). The TV with MTS can receive mono sound, stereo sound and Secondary Audio Programs (SAP). The SAP feature allows a TV station to broadcast other information, which could be audio in another language or something completely different like weather information.

You can enjoy Hi-Fi stereo sound or SAP broadcasts where available.

- **Stereo broadcasts**
View programs like live sporting events, shows and concerts in dynamic stereo sound.
- **SAP broadcasts**
Receive TV broadcasts in either MAIN or SAP sound.
MAIN sound: The normal program soundtrack (either in mono or stereo).
SAP sound: Listen to second language, supplementary commentary and other information. (SAP is mono sound.)

If stereo sound is difficult to hear.

- Obtain a clearer sound by manually switching to fixed mono-sound mode.

NOTE

- MTS only operates while in TV mode.

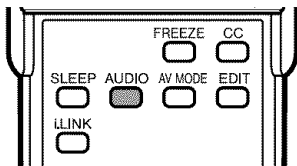

You can change MTS as shown below to match the television broadcast signal.

Examples: when receiving MTS and SAP

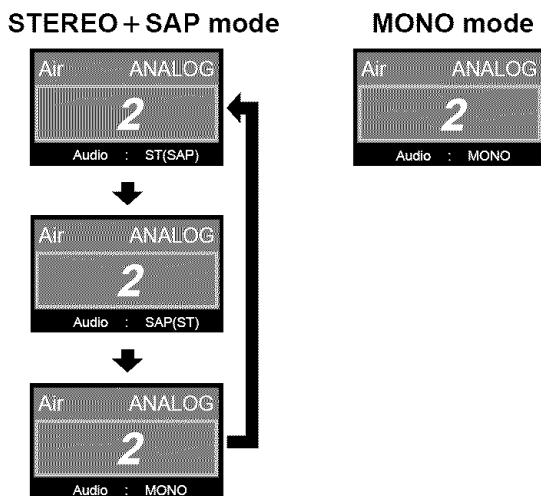
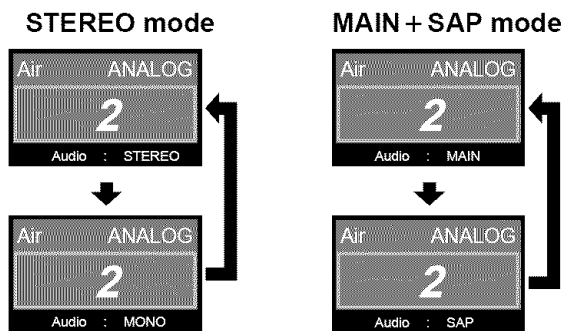

Setting Digital broadcasting audio mode

The types of audio transmitted in a digital broadcast include SURROUND as well as MONO and STEREO. In addition, it is possible for multiple audio tracks to accompany a single video track.

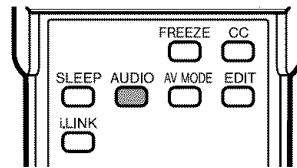

Press **AUDIO** to toggle between audio modes.

Examples: when receiving Digital broadcasting

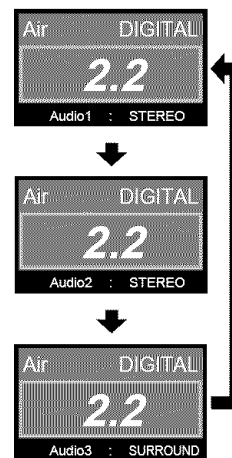

Connecting Digital Cable Module

Digital Cable Module is called CableCARD™. By attaching the CableCARD security module, you can receive various digital services provided by your Cable Company. To obtain and use a CableCARD security module you need to first submit an application. Please contact your cable company to discuss receiving an application.

NOTE

- If your cable company does not have CableCARD security module available, you must connect to the cable-TV set-top box via component video or DVI in order to receive HDTV programs. (See page 50.)
- When you change your address (See page 79.)
- About EAS (Emergency Alert System) (See page 79.)

1 Turn on the power of the TV.

2 Connect the antenna cables to both **ANALOG IN** and **DIGITAL CABLE IN** terminals.

NOTE

- Use a signal splitter (commercially available) for this type of connection. (See page 17.)

3 Insert the CableCARD security module (lower side facing right) into the **CableCARD** slot.

- When the CableCARD security module is inserted, a message appears, asking you to confirm the cable connections. Press **RETURN** to cancel the message, or wait until the screen in step 4 appears.

4 A message will appear on the screen. (It might take a couple of minutes before the message appears.) Call the number on the screen and tell the operator the CableCARD security module ID and Host ID numbers displayed on the screen.

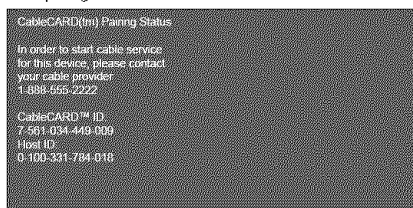

NOTE

- Do not insert any PCMCIA card other than CableCARD security module into the CableCARD slot.
- Please do not pull the AC cord out while the CableCARD security module is inserted.
- After inserting the CableCARD security module, it may take several minutes before video output from the selected channel appears on screen.

■ If the above procedure does not work, please follow the following steps instead.

1 Press **MENU** and the MENU screen displays.

2 Press **◀/▶** to select "Digital Setup", **▲/▼** to select "CableCARD Menu", **▲/▼** to select "Pairing Information", and then press **ENTER**.

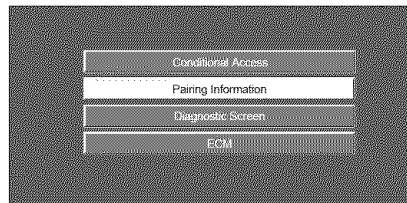

- The words "Pairing Information" may be replaced by a different expression depending on the manufacturer of the CableCARD security module.

3 A message will appear on the screen. Call the number on the screen and tell the operator the CableCARD security module ID and Host ID numbers displayed on the screen.

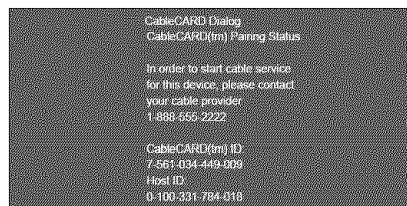

- If there is a white triangle at the right side of the screen, the screen is not showing the entire message. Press **▲/▼** on your remote control to display the rest of the message.
- When there is a "LINK" button on the screen, there is a link to the next page. Press **ENTER** to go to the next page.

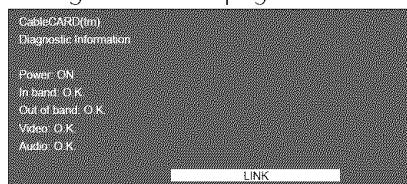

Removing CableCARD security module

- ① Turn on the power of the TV.
- ② Check that the CableCARD security module upgrade screen is not displayed. If it is displayed, wait until it disappears.
- ③ Remove the CableCARD security module.

Disconnecting the cable antenna

- ① Turn on the power of the TV.
- ② Check that the CableCARD security module upgrade screen is not displayed. If it is displayed, wait until it disappears.
- ③ Disconnect the cable antenna.

Basic adjustment settings

AV input mode menu items

List of AV menu items to help you with operations

Picture

OPC	Page 42
Backlight	Page 41
Contrast	Page 41
Brightness	Page 41
Color	Page 41
Tint	Page 41
Sharpness	Page 41
Advanced	
C.M.S.	Page 42
Color Temp.	Page 42
Sharpness Enhancement	Page 43
Automatic Contrast	Page 43
3D-Y/C	Page 43
Monochrome	Page 43
Film Mode	Page 43
I/P Setting	Page 43

Audio

Treble	Page 44
Bass	Page 44
Balance	Page 44
Dolby Virtual	Page 44

Power Control

No Signal Off	Page 45
No Operation Off	Page 45

Setup

EZ Setup	Page 38
CH Setup	Pages 38, 39
Antenna Setup-DIGITAL	Page 39
Input Label	Page 62
Parental CTRL	Pages 69-74
Position	Page 59
Picture Flip	Page 62
Standby Mode	Page 40
Language	Page 40

Option

Audio Only	Page 65
3D Noise Reduction	Page 65
Mosquito Noise Reduction	Page 65
HDMI Setup	Page 51
Input Select	Page 61
Output Select	Page 66
Quick Shoot	Page 66
Caption Setup	Page 68
Program Title Display	Page 66

Digital Setup

CableCARD Menu	Page 36
Video Setup	Page 46
Audio Setup	Page 46
i.LINK Setup	Pages 53-58

*PC input mode menu items

List of PC menu items to help you with operations

*When INPUT5 is set to PC.

Picture

OPC	Page 42
Backlight	Page 41
Contrast	Page 41
Brightness	Page 41
Red	Page 41
Green	Page 41
Blue	Page 41
Advanced	
C.M.S.	Page 42
Sharpness Enhancement	Page 43

Audio

Treble	Page 44
Bass	Page 44
Balance	Page 44
Dolby Virtual	Page 44

Power Control

Power Management	Page 45
------------------------	---------

Setup

Input Signal	Page 65
Auto Sync.	Page 60
Input Label	Page 62
Fine Sync.	Page 60
Picture Flip	Page 62
Standby Mode	Page 40
Language	Page 40

Option

Audio Only	Page 65
Input Select	Page 61
Output Select	Page 66
Quick Shoot	Page 66

Digital Setup

i.LINK Setup	Pages 53-58
--------------------	-------------

Basic adjustment settings

EZ Setup

You can run EZ Setup again, even after setting up the preset channels.

Language setting

Select from among 3 languages: English, French and Spanish.

1 Press **MENU** and the MENU screen displays.

2 Press **◀/▶** to select "Setup".

3 Press **▲/▼** to select "EZ Setup", and then press **ENTER**.

- If you already set the Secret No., go to step 4. If not, skip to step 5.

4 Input the 4-digit secret number by using **0 – 9**.

5 Press **▲/▼** to select the desired language listed on the screen, and then press **ENTER**.

Antenna setting

Make sure what kind of connection is made with your TV when selecting "Air" or "Cable" for ANALOG and DIGITAL (Cable).

6 Press **◀/▶** to select "Air", "Cable", for ANALOG, then press **▼** to move down. Press **◀/▶** to select "Standard", "HRC", "IRC" for DIGITAL (Cable).

Press **ENTER** to enter the setting.

- There are 3 kinds of CATV system, including Standard, HRC and IRC. Select the one matches to your TV.
- If cable or antenna connection was selected for the **ANALOG IN** terminal at the time when you set up TV Guide On Screen, the analog settings cannot be changed afterward. If you need to change the analog settings, you will have to change the TV Guide On Screen settings first.

Channel search

Channel auto search makes the TV look for all channels viewable in the set area.

7 Press **◀/▶** to select "Yes" for ANALOG, then press **▼** to move down. Press **◀/▶** to select "Yes" for DIGITAL (Air), then press **▼** to move down. Press **◀/▶** to select "Yes" for DIGITAL (Cable), and press **▼** to move down. Select "Search Start", and then press **ENTER**.

- This operation makes the TV search for both ANALOG, DIGITAL (Air) and DIGITAL (Cable) channels.

NOTE

- If no channel is found, make sure what kind of connection is made with your TV and try EZ Setup again.
- Make sure what kind of connection is made with your TV.

Channel Setup

If initial setup does not memorize all the channels in your region, follow the instructions below to manually memorize the channels.

Antenna setting

1 Press **MENU** and the MENU screen displays.

2 Press **◀/▶** to select "Setup".

3 Press **▲/▼** to select "CH Setup", and then press **ENTER**.

- If you already set the Secret No., input the 4-digit secret number here. See page 69 for setting a secret number.

4 Press **▲/▼** to select "Air/Cable", and then press **ENTER**.

5 Press **◀/▶** to select "Air", "Cable", for ANALOG, then press **▼** to move down. Press **◀/▶** to select, "Standard", "HRC", "IRC" for DIGITAL (Cable). Press **ENTER** to enter the setting.

NOTE

- Make sure what kind of connection is made with your TV.
- There are 3 kinds of CATV system, including Standard, HRC and IRC. Select the one matches to your TV.

Channel search

Channel auto search makes the TV look for all channels viewable in the set area.

1 Repeat steps 1 to 3 in Antenna setting in **Channel Setup**.

2 Press **▲/▼** to select "CH Search", and then press **ENTER**.

3 Press **◀/▶** to select "Yes" for ANALOG, then press **▼** to move down. Press **◀/▶** to select "Yes" for DIGITAL (Air), then press **▼** to move down. Press **◀/▶** to select "Yes" for DIGITAL (Cable), and press **▼** to move down. Select "Search Start", and then press **ENTER**.

NOTE

- Make sure what kind of connection is made with your TV.

Basic adjustment settings

Channel memory setting

1 Press **MENU** and the MENU screen displays.

2 Press **◀/▶** to select "Setup".

3 Press **▲/▼** to select "CH Setup", and then press **ENTER**.

- If you already set the Secret No., input the 4-digit secret number here. See page 69 for setting a secret number.

4 Press **▲/▼** to select "CH Memory", and then press **ENTER**.

5 Press **▲/▼** to select ANALOG, DIGITAL (Air), DIGITAL (Cable) and CableCARD, and then press **ENTER**.

6 Perform the following steps after confirming the type of antenna connection made with your TV, and the channel type selected in Step 5.

When viewing ANALOG broadcasts:

- ① Press **▲/▼**, and then press **◀/▶** to select the channel to skip or not.
- ② Press **▲/▼** to select "Skip", and then press **◀/▶** to select "On" or "Off".

When viewing DIGITAL broadcasts:

- ① Press **▲/▼** to select the channel to skip or not, and then press **◀/▶** to select "On" or "Off".

- On: Skips channels. (Channel selection disabled using **CH▲/▼**.)
- Off: Does not skip channels. (Channel selection enabled using **CH▲/▼**.)

NOTE

- Make sure what kind of connection is made with your TV.

Antenna Setup – DIGITAL – Air

In order to receive digital air broadcasts, you need a digital broadcast antenna. You can confirm the antenna configuration through the "Antenna Setup - DIGITAL" screen.

If necessary, adjust the direction of the antenna to obtain the maximum signal strength.

Signal Strength

1 Press **MENU** and the MENU screen displays.

2 Press **◀/▶** to select "Setup".

3 Press **▲/▼** to select "Antenna Setup - DIGITAL", and then press **ENTER**.

- If you already set the Secret No., input the 4-digit secret number here. See page 69 for setting a secret number.

4 Press **▲/▼** to select "Signal Strength".

- The signal strength of the DIGITAL (Air) antenna is displayed. The signal information is based on the current channel.

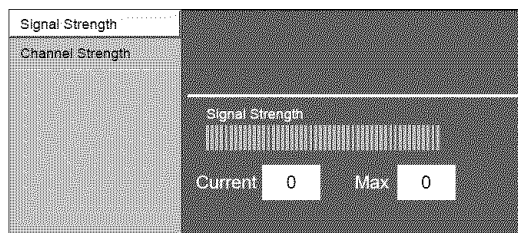

Channel Strength

- The channel signal strength can also be checked separately.

1 Repeat steps 1 to 3 in Signal Strength in **Antenna Setup - DIGITAL - Air**.

2 Press **▲/▼** to select "Channel Strength", and then press **ENTER**.

3 Input the 2-digit channel number to check the signal strength of the selected channel.

- Make sure the appropriate signal strength of each channel received is obtained.

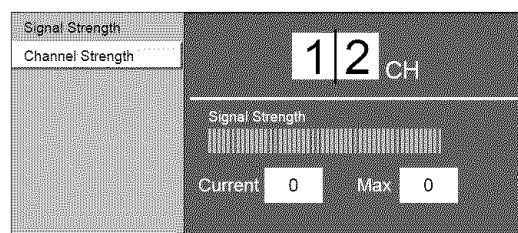

NOTE

- This function is available for DIGITAL (Air) only.

Basic adjustment settings

Standby Mode

Standby Mode may be set to either start the TV quickly from standby or conserve energy while on standby.

1 Press **MENU** and the MENU screen displays.

2 Press **◀/▶** to select "Setup".

3 Press **▲/▼** to select "Standby Mode", and then press **ENTER**.

4 Press **▲/▼** to select "Mode1" or "Mode2", and then press **ENTER**.

Selected item	Description
Mode1	Starting TV is quick from standby.
Mode2	Power consumption is small at the standby.

Favorite channel setting

This function allows you to program 4 favorite channels, in 4 different categories. By setting the favorite channels in advance, you can select your favorite channels easily.

1 Select the channel you want to register as a favorite channel.

2 Press **EDIT**.

3 Press **▲/▼** to select "Register", and then press **ENTER**.

4 Press **▲/▼/◀/▶** to select the position in the area, and then press **ENTER** to register.

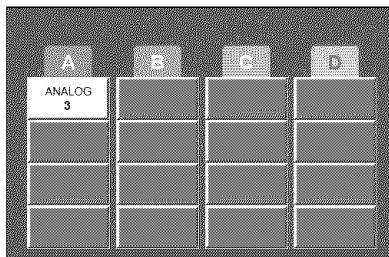

Deleting favorite channel

1 Press **EDIT** and the favorite channel screen displays.

2 Press **▲/▼** to select "1 Data Clear", and then press **ENTER**.

3 Press **▲/▼/◀/▶** to select the channel you want to delete, and then press **ENTER**.

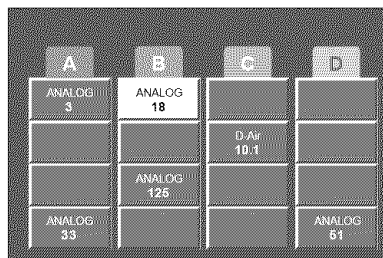

4 Press **◀/▶** to select "Yes", and then press **ENTER**.

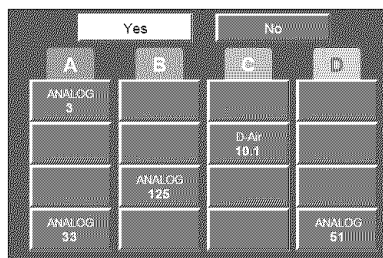

NOTE

- You can delete all the favorite channels by selecting "All Data Clear" in step 2 in **Deleting favorite channel**.

Language setting

You can also select a language from the Setup menu. Select from among 3 languages: English, French and Spanish.

1 Press **MENU** and the MENU screen displays.

2 Press **◀/▶** to select "Setup".

3 Press **▲/▼** to select "Language", and then press **ENTER**.

4 Press **▲/▼** to select the desired language listed on the screen, and then press **ENTER**.

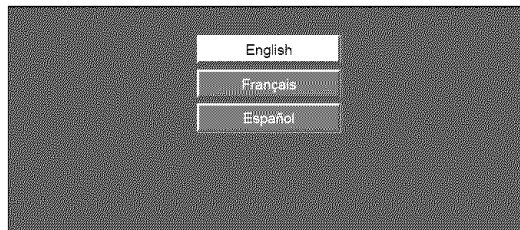

Basic adjustment settings

Picture adjustments

Adjusts the picture to your preference with the following picture settings.

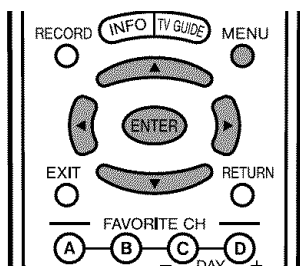

1

Press **MENU** and the MENU screen displays.

2

Press ◀/▶ to select "Picture".

3

Press ▲/▼ to select a specific adjustment item.

4

Press ◀/▶ to adjust the item to your desired position.

NOTE

- For resetting all adjustment items to factory preset values, press ▲/▼ to select "Reset", press **ENTER**, press ◀/▶ to select "Yes", and then press **ENTER**.

Adjustments for AV source

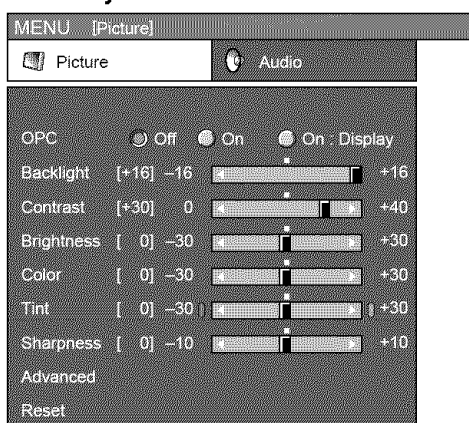

Adjustments for PC source

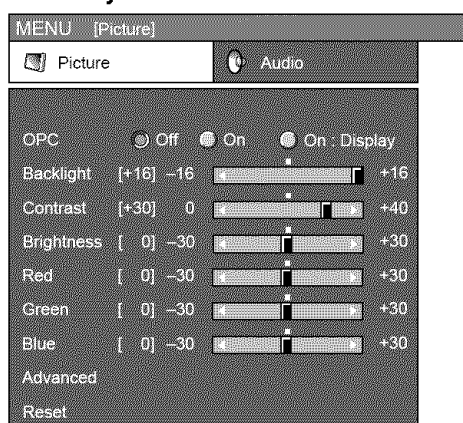

Selected item	◀ button	▶ button
Backlight	The screen dims	The screen brightens
Contrast	For less contrast	For more contrast
Brightness	For less brightness	For more brightness
Color	For less color intensity	For more color intensity
Tint	Skin tones become purplish	Skin tones become greenish
Sharpness	For less sharpness	For more sharpness

NOTE

- Select "Advanced" and then press **ENTER** to set "C.M.S-Hue", "C.M.S-Saturation", "C.M.S-Value", "Color Temp.", "Sharpness Enhancement", "Automatic Contrast", "3D-Y/C", "Monochrome", "Film Mode" or "I/P Setting". See pages 42 to 43.

Selected item	◀ button	▶ button
Backlight	The screen dims	The screen brightens
Contrast	For less contrast	For more contrast
Brightness	For less brightness	For more brightness
Red	For weaker red	For stronger red
Green	For weaker green	For stronger green
Blue	For weaker blue	For stronger blue

NOTE

- Select "Advanced" and then press **ENTER** to set "C.M.S-Hue", "C.M.S-Saturation", "C.M.S-Value" and "Sharpness Enhancement". See pages 42 to 43.

Basic adjustment settings

OPC setting

Automatically adjusts the brightness of the screen.

1 Press **MENU** and the MENU screen displays.

2 Press **◀/▶** to select "Picture".

3 Press **▲/▼** to select "OPC".

4 Press **◀/▶** to select "On" or "On: Display".

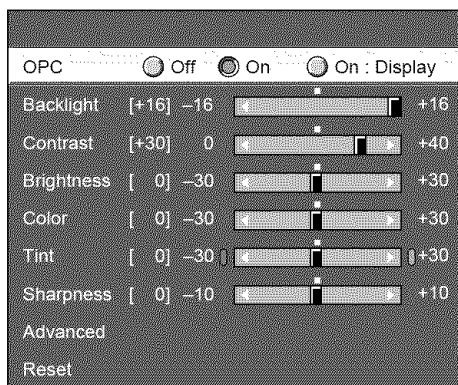

Selected item	Description
Off	The brightness is fixed at the value set in "Backlight" (see page 41).
On	Automatically adjusts
On: Display	Displays the OPC effect on the screen while adjusting the brightness of the screen.

NOTE

- When set to "On", the OPC senses the surrounding light and automatically adjusts the backlight brightness. Make sure no object obstructs the OPC sensor, which could affect its ability to sense surrounding light.
- When set to "On: Display", OPC effect displays on the screen while OPC is adjusting the screen brightness.

Advanced picture adjustments

This TV provides various advanced functions for optimizing the picture quality.

1 Press **MENU** and the MENU screen displays.

2 Press **◀/▶** to select "Picture".

3 Press **▲/▼** to select "Advanced", and then press **ENTER**.

4 Press **▲/▼** to select a specific adjustment item.

- You can select "C.M.S-Hue", "C.M.S-Saturation", "C.M.S-Value", "Color Temp.", "Sharpness Enhancement", "Automatic Contrast", "3D-Y/C", "Monochrome", "Film Mode" or "I/P Setting".

5 Press **▲/▼** (or **◀/▶**) to select the desired parameter.

- See the table for the selectable parameters.

C.M.S. (Color Management System)

Color tone is managed using the six-color adjustment setting.

Selected item	Description
C.M.S-Hue	This is a standard to adjust the color either more reddish or more bluish in tone.
C.M.S-Saturation	Increases or decreases the saturation of a selected color.
C.M.S-Value	A higher value makes the image brighter. A lower value makes the image darker.

NOTE

- For resetting all adjustment items to the factory preset values, press **▲/▼** to select "Reset", and then press **ENTER**.

Color temperature

For a better white balance, use color temperature correction.

Selected item	Description
High	White with Bluish tone ⇕ White with Reddish tone
Mid-High	
Middle	
Mid-Low	
Low	

Basic adjustment settings

Sharpness Enhancement

Provides sharper images with more depth by adjusting background sharpness.

NOTE

- The higher the number of the level, the more sharpness and depth you will get in images. However, this may also add more background noise.

Automatic Contrast

Adjusts black level and white level in images automatically as appropriate to a particular scene.

Selected item	Description
On	Automatically adjusts
Off	For normal images

3D-Y/C

Provides high quality images with minimal dot crawl and cross color noise.

Selected item	Description
Standard	Normal adjustment
Fast	For movie image
Slow	For still image

NOTE

- 3D-Y/C is available for input signal from Composite Video and ANALOG IN.

Monochrome

For viewing a video in monochrome.

Selected item	Description
Off	Normal color
On	For viewing in monochrome

Film Mode (3:2 pull-down)

Automatically detects a film-based source (originally encoded at 24 frames/second), analyzes it then recreates each still film frame for high-definition picture quality.

Selected item	Description
Off	Normal viewing mode
On	Detects, analyzes, converts film source

I/P Setting

Converts input signals from interlace to progressive.

NOTE

- "I/P Setting" is not selectable when channel display shows an input resolution of 480P or 720P.

Basic adjustment settings

Sound adjustment

You can adjust the sound quality to your preference with the following settings.

1 Press **MENU** and the MENU screen displays.

2 Press **◀/▶** to select "Audio".

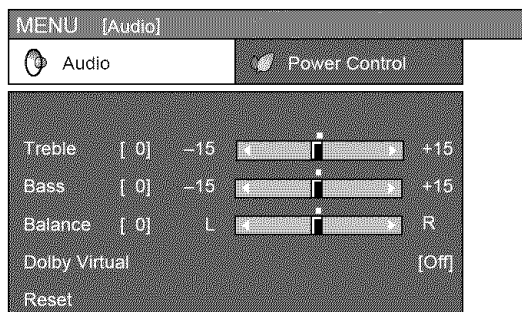

3 Press **▲/▼** to select a specific adjustment item.

4 Press **◀/▶** to adjust the item to your desired position.

Selected item	◀button	▶button
Treble	For weaker treble	For stronger treble
Bass	For weaker bass	For stronger bass
Balance	Decrease audio from the right speaker	Decrease audio from the left speaker

NOTE

- Audio menu is grayed out when Output Select is set to "Variable".
- "Balance", "Treble" and "Bass" are grayed out when Dolby Virtual is set to "On".
- For resetting all adjustment items to factory preset values, press **▲/▼** to select "Reset", press **ENTER**, press **◀/▶** to select "Yes", and then press **ENTER**.

Dolby Virtual

You can enjoy the SURROUND 2ch stereo with Dolby Pro Logic II technology.

VIRTUAL DOLBY DIGITAL is a technology certified by Dolby Laboratories that creates a virtualized surround sound experience from two speakers using Dolby Pro Logic or Dolby Pro Logic II.

VIRTUAL DOLBY DIGITAL retains all the original multichannel audio information and provides the listener with the sensation of being surrounded by additional speakers.

1 Press **MENU** and the MENU screen displays.

2 Press **◀/▶** to select "Audio".

3 Press **▲/▼** to select "Dolby Virtual", and then press **ENTER**.

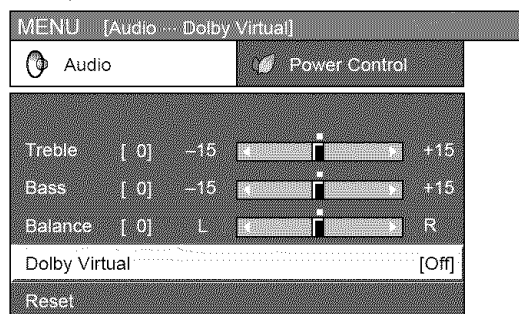

4 Press **◀/▶** to select "On", and then press **ENTER**.

NOTE

- You can choose Dolby Virtual by pressing **Virtual** on the remote control unit.
- Audio menu is grayed out when Output Select is set to "Variable".
- "Balance", "Treble" and "Bass" are grayed out when Dolby Virtual is set to "On".
- For some discs, setup may be required on your DVD. In this case, please refer to the operation manual of your DVD player.

Basic adjustment settings

Power Control

Power control setting allows you to save energy.

Power control for AV source

No signal off

When set to "Enable", the power will automatically shut down if no signal inputs for 15 minutes.

1 Press **MENU** and the MENU screen displays.

2 Press **◀/▶** to select "Power Control".

3 Press **▲/▼** to select "No Signal Off", and then press **ENTER**.

4 Press **◀/▶** to select "Enable", and then press **ENTER**.

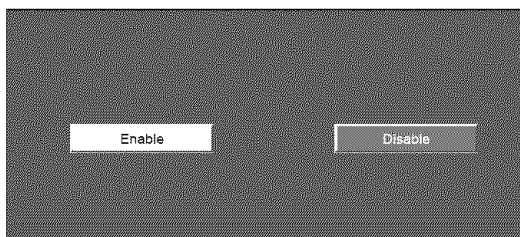

- Five minutes before the power shuts down, remaining time displays every minute.

NOTE

- "Disable" is factory preset value.
- When a TV program finishes, this function may not operate.

No operation off

When set to "Enable", the power will automatically shut down if there is no operation for 3 hours.

1 Repeat steps 1 and 2 in **No signal off**.

2 Press **▲/▼** to select "No Operation Off", and then press **ENTER**.

3 Press **◀/▶** to select "Enable", and then press **ENTER**.

- Five minutes before the power shuts down, remaining time displays every minute.

NOTE

- "Disable" is factory preset value.

Power control for PC source

Power control setting allows you to save energy.

Power management

When set, the power will automatically shut down.

1 Repeat steps 1 and 2 in **No signal off**.

2 Press **▲/▼** to select "Power Management", and then press **ENTER**.

3 Press **▲/▼** to select "Mode1" or "Mode2", and then press **ENTER**.

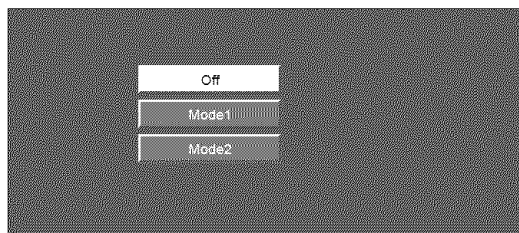

Selected item	Description
Off	<ul style="list-style-type: none"> • No power management • Factory preset value.
Mode1	<ul style="list-style-type: none"> • If no signal inputs for 8 minutes, the power shuts down. • Even if you start using the PC and the signal inputs again, the TV stays off. • The TV turns on again by pressing TV POWER on the remote control unit. (See page 18). • Pressing POWER on the TV will have the same result.
Mode2	<ul style="list-style-type: none"> • If no signal inputs for 8 seconds, the TV enters standby mode. • When you start using the PC and the signal inputs again, the TV turns on.

NOTE

- When using a digital PC and setting "Mode2" in Power management, the power may not turn back on automatically even if the signal inputs again.
- If you turn off the power by disconnecting AC cord when setting "Mode2" in power management, the TV may not function properly after turning the power on again. In such case, press **TV POWER** on the remote control unit.
- Pressing **POWER** on the TV will have the same result.

Basic adjustment settings

Digital Setup

This setting allows you to set the image of Digital broadcasting.

Video Setup

You can adjust the settings for Digital image.

Screen Size

Set the format of image of Digital broadcasting.

1 Press **MENU** and the MENU screen displays.

2 Press **◀/▶** to select "Digital Setup".

3 Press **▲/▼** to select "Video Setup", and then press **ENTER**.

4 Press **▲/▼** to select "Screen Size", and then press **ENTER**.

5 Press **◀/▶** to select "Manual" or "Auto".

Selected item	Description
Manual	With 480i/480p/720p broadcasts you can change the screen size to the size of your choice.
Auto	All broadcasts will be converted and displayed in the 1080i format.

NOTE

- "Manual" is factory preset value.

REC Picture Size

Select the screen size to record on 16:9 video.

1 Press **MENU** and the MENU screen displays.

2 Press **◀/▶** to select "Digital Setup".

3 Press **▲/▼** to select "Video Setup", and then press **ENTER**.

4

Press **▲/▼** to select "REC Picture Size", and then press **ENTER**.

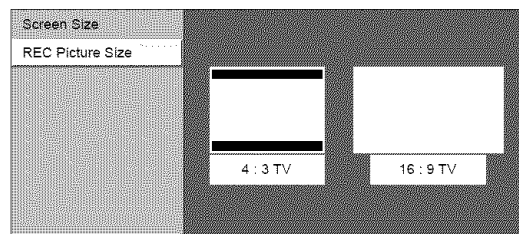

5

Press **◀/▶** to select the desired picture size, and then press **ENTER**.

Selected item	Description
4:3 TV	Bars may appear on the top and bottom with some programs
16:9 TV	Displays in full screen

Audio Setup

You can output digital audio to an AV amplifier or similar device whose DIGITAL AUDIO INPUT terminal is connected to the DIGITAL AUDIO OUTPUT terminal on the TV (see page 52). Please select an audio output format compatible with the audio format of the program you are watching and the equipment connected.

1

Press **MENU** and the MENU screen displays.

2

Press **◀/▶** to select "Digital Setup".

3

Press **▲/▼** to select "Audio Setup", and then press **ENTER**.

4

Press **▲/▼** to select "PCM" or "Dolby Digital", and then press **ENTER**.

Selected item	Description
PCM	The optical output terminal outputs audio signal by PCM form. If your digital audio system does not support Dolby Digital, select "PCM".
Dolby Digital	The optical output terminal outputs audio signal by Dolby Digital form. It reproduces sound from surround program of digital.

Using external equipment

You can connect many types of external equipment to your TV, like a DVD player, VCR, Digital TV tuner, PC, HDMI equipment, game console and camcorder. To view external source images, select the input source with **INPUT** on the remote control unit or on the TV.

Displaying an external equipment image

Explanation here is for the setting when connecting DVD to INPUT1 terminal.

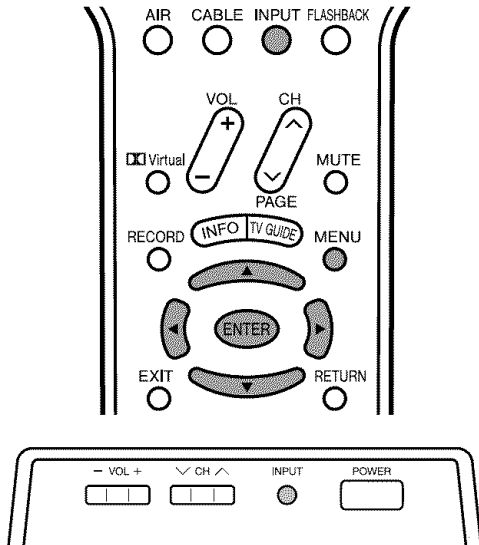

To watch a DVD image, select "INPUT1" from "INPUT SOURCE" menu using **INPUT** on the remote control unit or on the TV. (See page 61.)

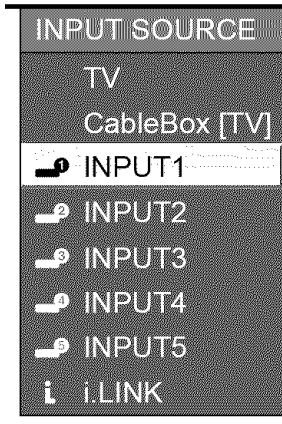

NOTE

- If the image does not come in clearly, you may need to change the input signal type setting on the "Input Select" menu.

Selecting the INPUT signal

1

Press **MENU** and the MENU screen displays.

2

Press ◀▶ to select "Option".

3

Press ▲/▼ to select "Input Select", and then press **ENTER**.

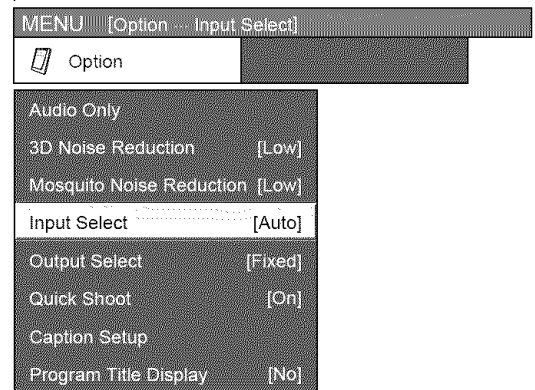

4

Select the desired signal type.

For INPUT1 signal

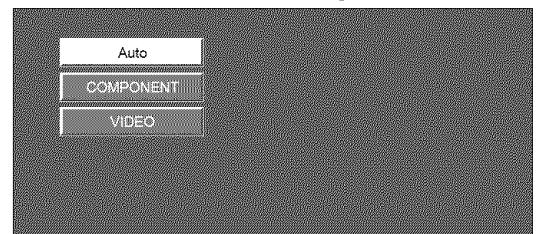

The setting is stored and can be selected on the "INPUT SOURCE" menu.

CAUTION

- To protect all equipment, always turn off the TV before connecting to a DVD player, VCR, Digital TV tuner, PC, HDMI equipment, game console, camcorder or other external equipment.

NOTE

- See pages 48 to 53 for external equipment connection.
- Please refer to the relevant operation manual (DVD player, PC, etc.) carefully before making connections.
- Each time **INPUT** is pressed, the input source toggles.
- Refer to your external equipment operation manual for the signal type.

Using external equipment

Connecting a DVD player

You can use the INPUT 1, INPUT 2, INPUT 4 or INPUT 5 terminals when connecting to a DVD player and other audiovisual equipment.

When using component cable.

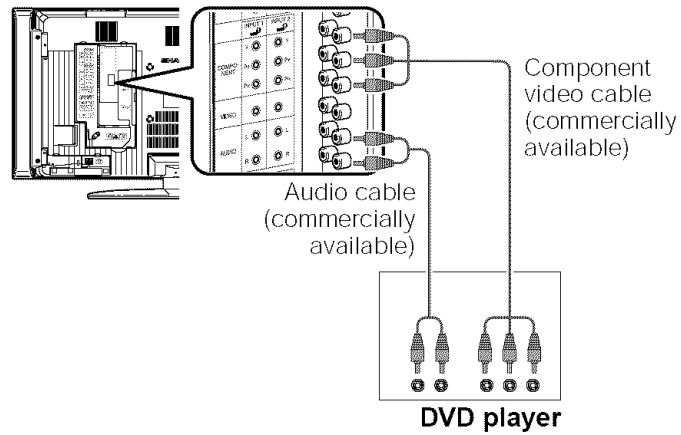

When using composite cable.

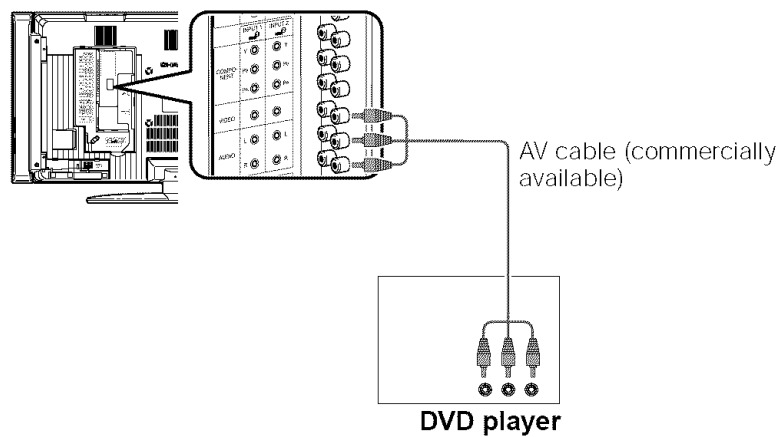

When using DVI cable. (INPUT 5)

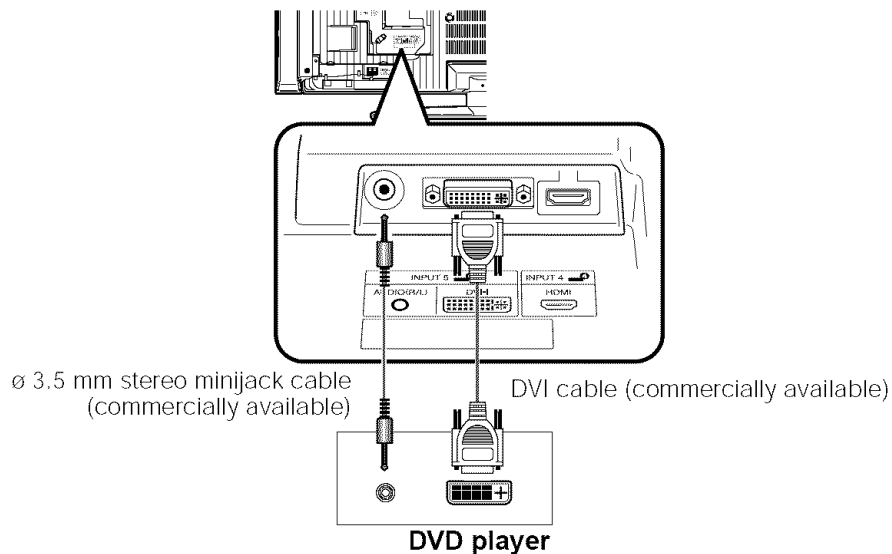

NOTE

- See page 51 for connecting a DVD player with HDMI terminal.

Using external equipment

Connecting a VCR

You can use the INPUT 3 terminal when connecting a VCR and other audiovisual equipment.

NOTE

- The S-video terminal has priority over the video terminals.
- The G-LINK cable connection is necessary if you want to use the recording features of the TV Guide On Screen system with your VCR.

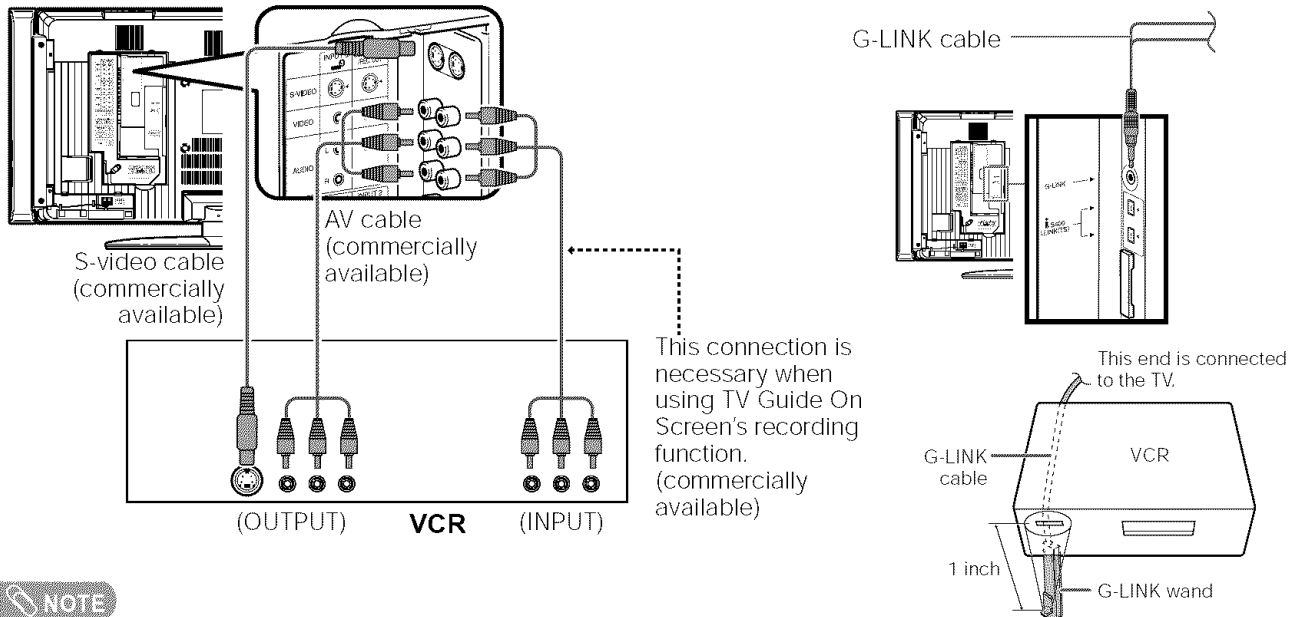

NOTE

- When attempting to record copy protected material on a VCR or other recording device, the copy protection will activate and the protected material will not be recorded correctly. In addition, attempting to display copy protected material on a monitor connected via a VCR, whether for the purpose of viewing or not, will cause an inferior quality picture to be displayed. This is not a fault of the equipment. Please view copy protected material by connecting the product directly to the monitor.

Connecting a game console or camcorder

A game console, camcorder and some other audiovisual equipment are conveniently connected using the INPUT 3 terminals.

NOTE

- The S-video terminal has priority over the video terminals.

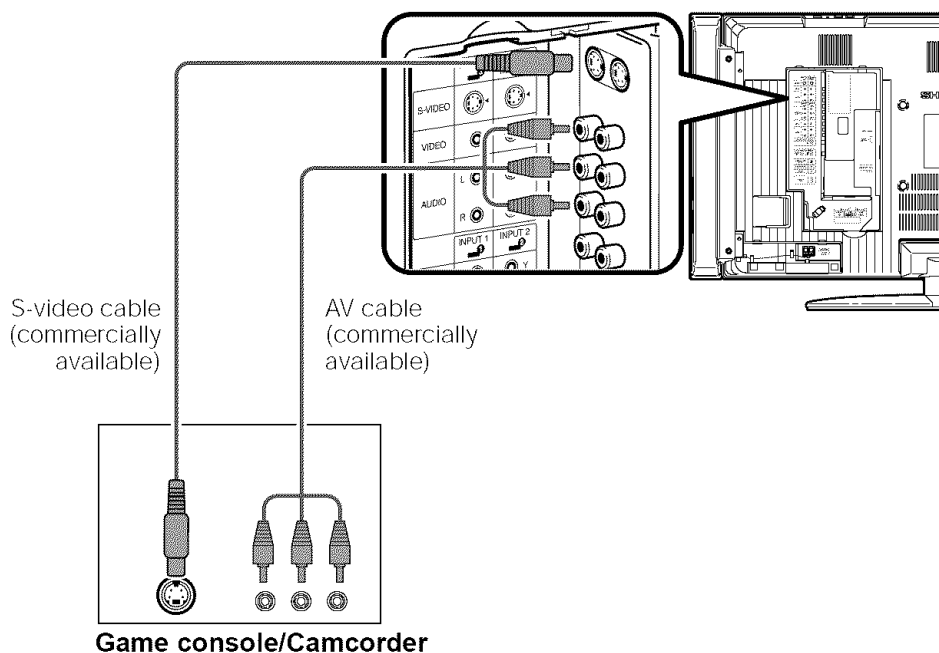

Using external equipment

Connecting a Digital TV STB (Air or Cable)

You can use the INPUT 1, INPUT 2, INPUT 4 or INPUT 5 terminals when connecting a Digital TV STB (Air or Cable) and other audiovisual equipment.

NOTE

- If your cable-TV company has CableCARD security module available, you can also use the CableCARD security module to receive HDTV programs. (See page 36.)

When using component cable.

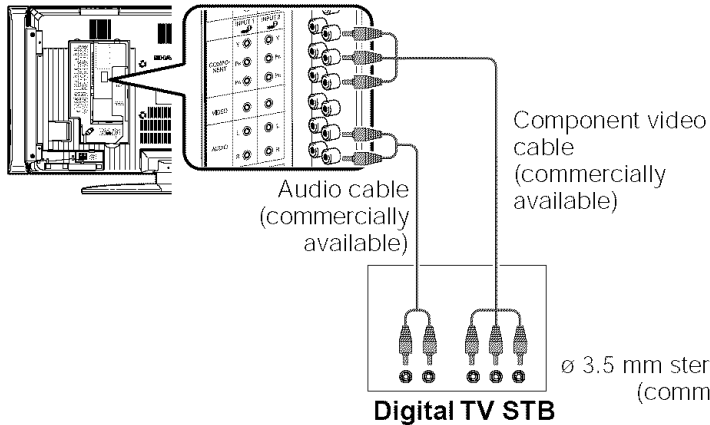

When using DVI cable. (INPUT 5)

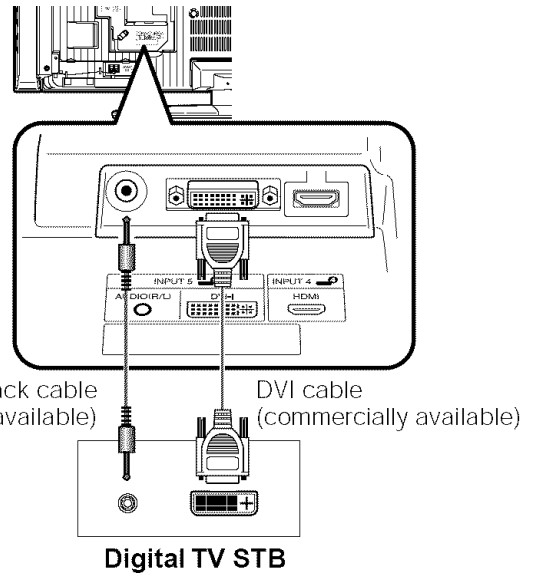

NOTE

- See page 51 for connecting a Digital TV STB to HDMI terminal.

When using composite cable.

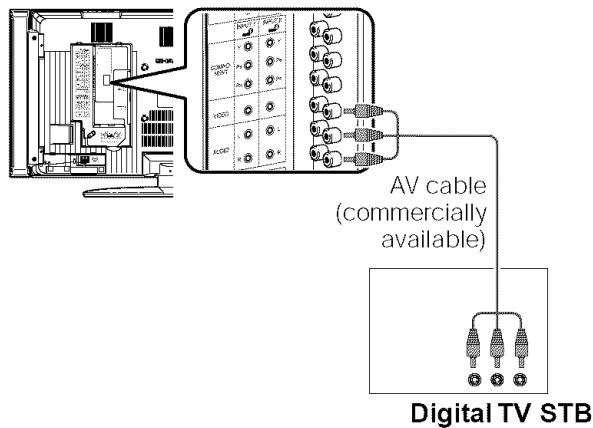

Cable box connection (for TV Guide On Screen)

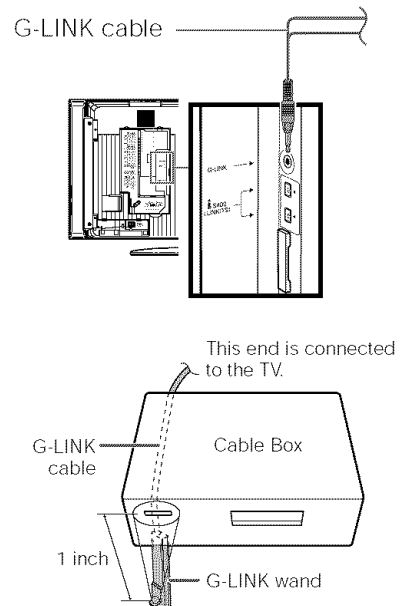

NOTE

- To receive TV program listings in the TV Guide On Screen system, please connect your cable box using this input, marked "VIDEO". Do not connect the cable box to the "COMPONENT" video as you will not receive any TV program listings.

Connecting HDMI equipment

Please use the INPUT 4 terminal when connecting HDMI equipment.

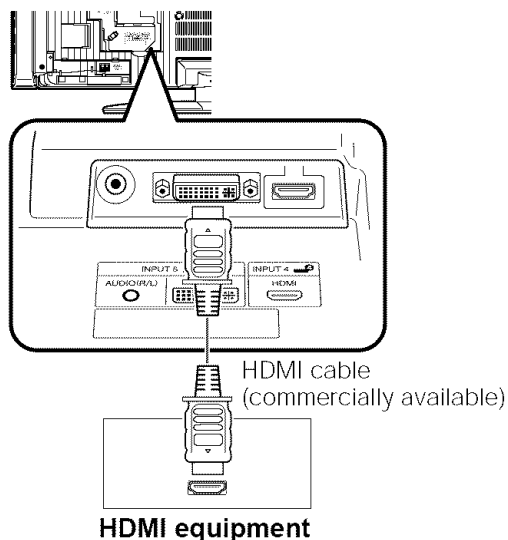

Displaying an image from HDMI equipment

1

To watch an HDMI equipment image, select "INPUT4" from "INPUT SOURCE" menu using **INPUT** on the remote control unit or on the TV. (See page 61.)

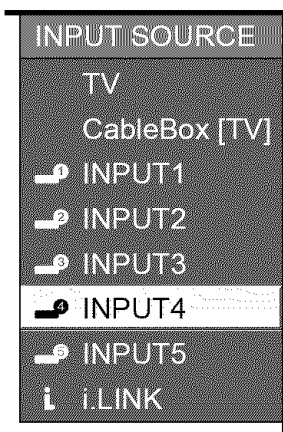

2

Press **MENU** and the MENU screen displays.

3

Press **◀▶** to select "Option".

4

Press **▲▼** to select "HDMI Setup", and then press **ENTER**.

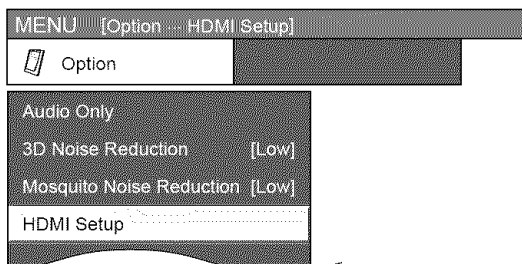

5

Press **▲▼** to select the desired item and press **ENTER**.

6

Press **▲▼/◀▶** to select the desired setting and press **ENTER**.

HDMI Setup items	Selectable items	Description
Signal Type	Auto/RGB/YCbCr 4:4:4/YCbCr 4:2:2	Select the signal type from an HDMI terminal. Unless the image quality looks obviously poor, select Auto.
Color Matrix	Auto/ITU601/ITU709	Select the internal color space conversion method when an RGB signal is input. Normally, select Auto.
Dynamic Range	Standard/Out of Standard	Select the signal amplitude range. Normally, select Standard.
Auto View	Enable/Disable	Set whether or not to use VIEW MODE based on signal recognition, including an HDMI signal.

NOTE

• Refer to your external equipment operation manual for the signal type.

Using external equipment

Connecting a PC

Use the INPUT 5 terminal to connect a PC.

NOTE

- Refer to page 83 for a list of PC signals compatible with the TV.

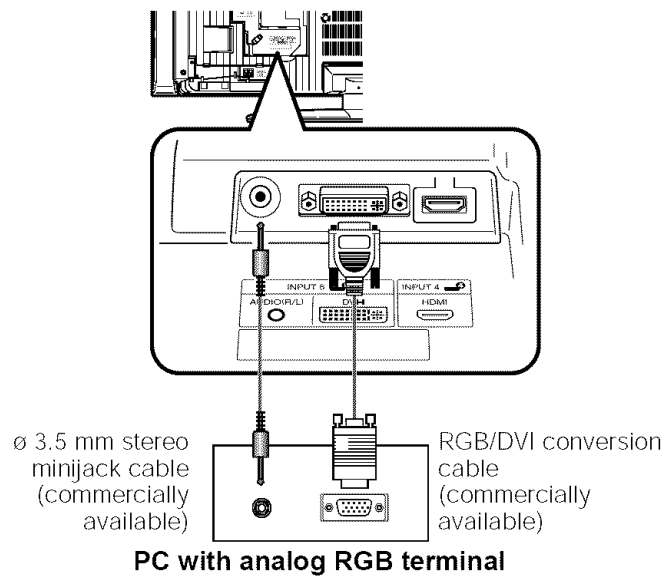
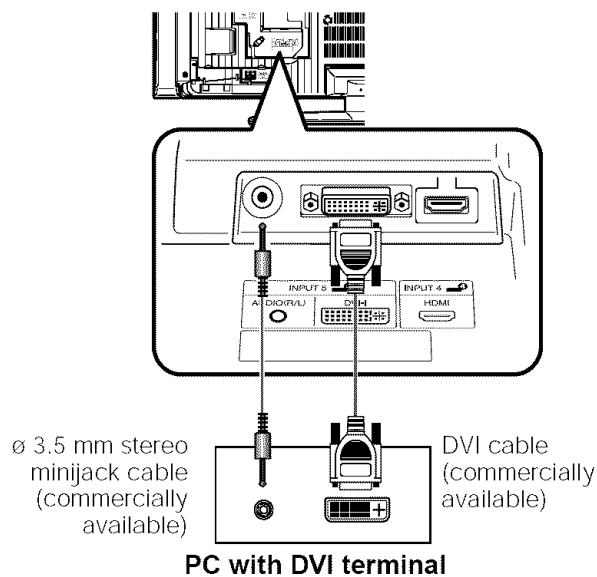

Using Digital Audio Output

It is possible to output audio through the DIGITAL AUDIO OUTPUT terminal. PCM audio outputs from the terminal.

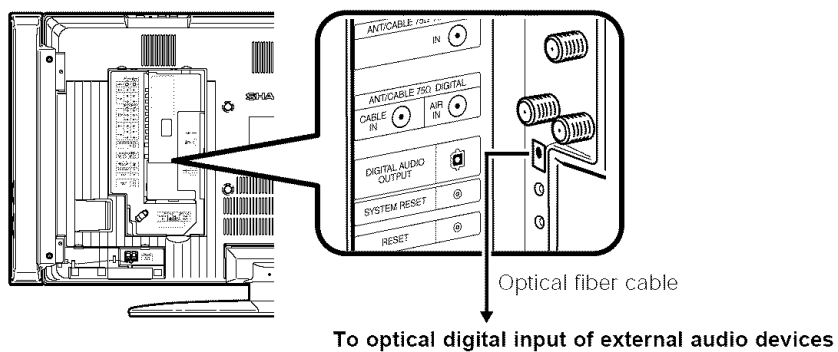

Using external equipment

Connecting D-VHS decks/AV-HDD recorder/Blu-ray Disc recorder (i.LINK connection)

About i.LINK

i.LINK is an interface connection using a serial transfer system and is able to transfer multimedia data, such as digital images and digital sound, between devices that have i.LINK terminals. i.LINK is a term defined in the IEEE1394 (Institute of Electrical and Electronics Engineers) standard. Currently, the transfer speeds are at 100 Mbps, 200 Mbps and 400 Mbps, each of them expressed as S100, S200 and S400 respectively. On this TV, the maximum speed is 400 Mbps.

i.LINK devices that can be connected to this TV.

Only D-VHS decks, AV-HDD recorders and Blu-ray Disc recorders can be connected to this TV via i.LINK. Other devices such as DVD recorders, digital video cameras, computers or computer peripheral devices do not meet the specifications for this TV and therefore cannot be connected via i.LINK. Even for the types of i.LINK device mentioned above, device recognition, control, recording and playback operations may not be possible on some devices.

Materials that can be recorded with the i.LINK

Only digital programs can be recorded by i.LINK devices connected to this TV using the i.LINK. i.LINK recording is not compatible with analog broadcasts or external input signals (INPUT terminals 1 through 5).

i.LINK connection

NOTE

- Please make sure the shapes of the terminal and the plug match, and insert the plug into the terminal straight, not on an angle.
- Use either one of the terminals. These two terminals do not differ in quality or function.

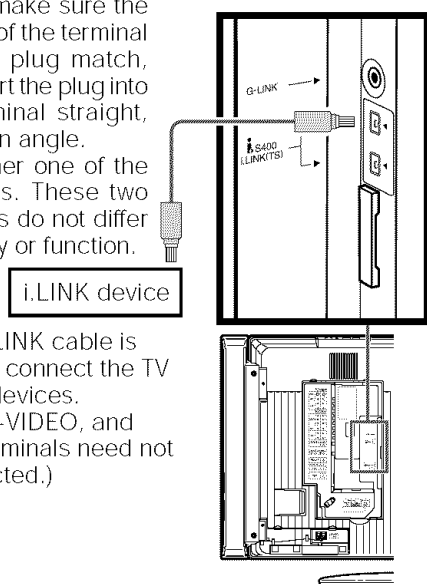

Only an i.LINK cable is needed to connect the TV to i.LINK devices. (VIDEO, S-VIDEO, and AUDIO terminals need not be connected.)

Connecting two or more i.LINK devices

Up to 16 i.LINK devices can be connected using a daisy-chain connection with i.LINK cables.

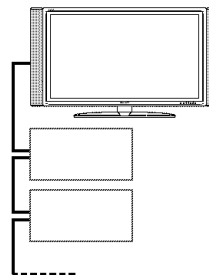

When 3 or more i.LINK devices are connected, branch connection can be used. With branch connections, up to 62 i.LINK devices can be connected.

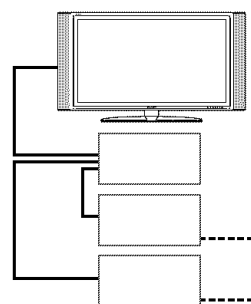

Cautions regarding i.LINK connection

- Please use S400 type i.LINK cables.
- Some i.LINK devices may not relay data if their power is off. In this case the device should be connected at the end of any series of connections.
- This TV can relay data during power off, by selecting "Active" in the "Standby Mode" option in "i.LINK Setup". (See page 54.)
- Please do NOT use a loop connection as shown in the diagram.

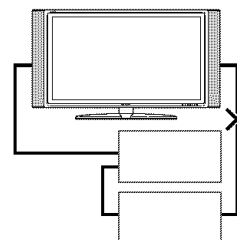

- When using the i.LINK, do not turn off the power of, or pull the cable from i.LINK devices, even if that i.LINK device is not in use. This may affect the picture and the sound from an i.LINK device in use.
- If devices such as a DVD recorders, digital video cameras, computers and computer peripheral devices which are not compatible with this TV, are connected to the TV using i.LINK, other i.LINK connections may be disrupted.
- When device recognition, control, recording or playback, on an i.LINK connected device does not function correctly, correct operation may be restored by disconnecting and reconnecting the i.LINK cable.
- When connecting multiple i.LINK devices, depending on the specifications and the interoperability of the connected devices, their operation may not be stable. In that case, disconnecting all devices not in use and changing the method of connection may result in stable operation.

Setting the Recording Mode (i.LINK)

- The function for automatically adjusting the recording mode of connected i.LINK devices can be turned on or off.
- Since most of the currently available i.LINK devices automatically recognize the transfer rates of the pictures and sound being recorded and control the recording mode accordingly, **you should always set this Mode to "Pass through" in normal circumstances.**
- Depending on the i.LINK devices used and the type of broadcast being recorded, this TV may not adjust the recording mode properly. In this case, please set the "Recording Mode" to "Pass through".

1 Press **MENU** and the MENU screen displays.

2 Press **◀/▶** to select "Digital Setup".

3 Press **▲/▼** to select "i.LINK Setup", and then press **ENTER**.

4 Press **▲/▼** to select "Recording Mode", and then press **ENTER**.

5 Press **◀/▶** to select "Auto" or "Pass through", and then press **ENTER**.

- Normally, this should be set to "Pass through".

Setting the Standby Mode (i.LINK)

- Power consumption during standby mode can be minimized by changing the setting of the "Standby Mode" in "i.LINK Setup".
- When i.LINK is not in use, select "Inactive" in "Standby Mode".

1 Press **MENU** and the MENU screen displays.

2 Press **◀/▶** to select "Digital Setup".

3 Press **▲/▼** to select "i.LINK Setup", and then press **ENTER**.

4 Press **▲/▼** to select "Standby Mode", and then press **ENTER**.

5 Press **◀/▶** to select "Active" or "Inactive", and then press **ENTER**.

"Active": Power continues to pass through the i.LINK circuit so data can be relayed.

"Inactive": Power consumption is minimized during stand-by mode. Data cannot be relayed at this setting.

NOTE

- When the main power of the TV is in standby mode (POWER indicator lights off), i.LINK control commands cannot be received from an i.LINK device. This does not change even if the "Standby Mode" is set to "Active". To control the TV from an i.LINK device, turn the TV power on (POWER indicator lights up in blue).
- Data cannot be relayed between i.LINK devices when all the following conditions are met: 1) More than one i.LINK device is connected to the TV with i.LINK cables, 2) "Standby Mode" is set to "Inactive", and 3) The power of the TV is in standby mode (POWER indicator lights off). When the TV is connected between two i.LINK devices in series, select "Active" in "Standby Mode" or connect the TV at an end of the series as shown in the diagram.

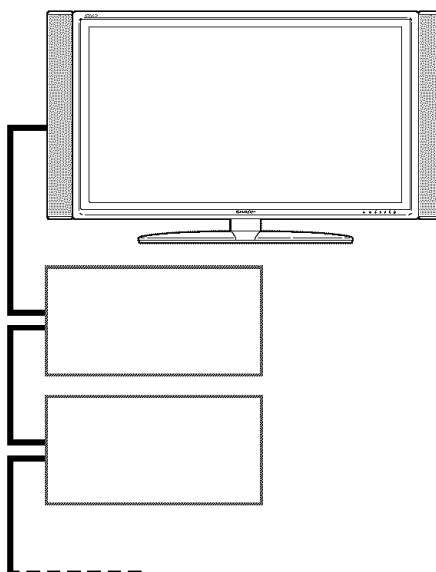

Using external equipment

Selecting an i.LINK device

- In order to control an i.LINK device from the TV, you must first choose the i.LINK device to be controlled.
- One i.LINK device can be chosen from up to 16 i.LINK connected decks.
- All i.LINK devices connected with i.LINK cables should automatically appear in the selection screen.

1

Press **i.LINK** to display the i.LINK control panel.

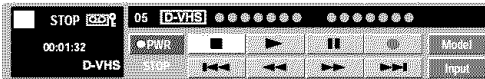

- When there is no i.LINK device connected, "No i.LINK model is available" appears. Please connect an i.LINK device. (See page 53.)
- When there is no i.LINK device selected, the selection screen appears. Please go to step 3.

2

Press **▲/▼/◀/▶** to select "Model", and press **ENTER**.

- Selection screen appears.

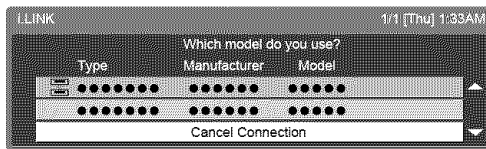

3

Press **▲/▼** to select a device, and then press **ENTER**.

- The control panel for the i.LINK device appears.

NOTE

- Devices that cannot be used with this TV will not appear in the selection screen.
- Depending on the i.LINK devices connected, the manufacturer's name and model name of some devices may not display correctly.
- In the case where the manufacturer's and model names are not correctly displayed, disconnect the i.LINK cable. Follow the procedure for "Deleting registered i.LINK devices" and cancel all i.LINK devices you have registered before reconnecting the i.LINK cable.
- When an item in the selection screen is grayed out, the item is not recognized by the TV and cannot be selected. (The item may not be connected properly.)
- The i.LINK device selected above will be automatically set as a recording device in the TV Guide On Screen system and may be used to record digital broadcasts.

Disabling the TV's operation of an i.LINK device

- By disabling the TV's operation of an i.LINK device, the device can be operated from another i.LINK device.

1

Press **i.LINK** to display the i.LINK control panel.

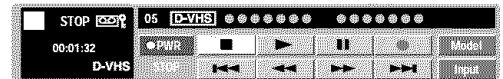

- When there is no i.LINK device connected, the message "No i.LINK device is available" appears. In this case, please connect an i.LINK device. (See page 53.)
- When there is no i.LINK device selected, the selection screen appears. In this case, please go to step 3.

2

Press **▲/▼/◀/▶** to select "Model", and then press **ENTER**.

- Selection screen appears.

3

Press **▼** to select "Cancel Connection" and then press **ENTER**.

- Operation of the i.LINK device from the TV is disabled.

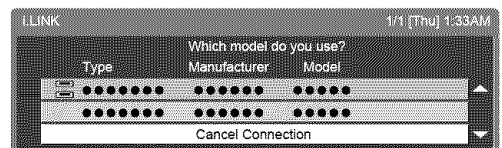

Deleting registered i.LINK devices

- Registered i.LINK devices can be deleted from a list.
- If an i.LINK device is connected, it cannot be deleted from the list.

1

Press **i.LINK** to display the i.LINK control panel.



2

Press **▲/▼/◀/▶** to select "Model", and then press **ENTER**.

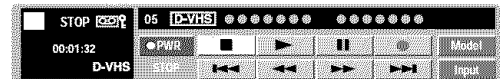

3

Press **▲/▼** to select a device to be deleted, and then press **ENTER**.

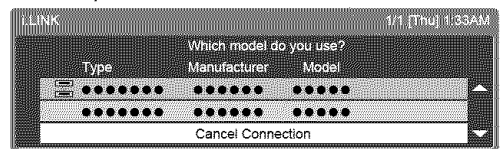

4

Press **◀** to select "Delete", and then press **ENTER**.

- The selected i.LINK device is deleted from the list.
- Select "Cancel" if you do not want to delete any device.

Using external equipment

Controlling an i.LINK device

- An i.LINK compatible device can be controlled from the TV using the i.LINK control panel on the screen.
- The steps in "i.LINK Setup" on page 54 need to be completed beforehand.
- Please also refer to the operation manual of the i.LINK device to be used with this TV.

Basic operation

- ① Press **i.LINK** to display the i.LINK control panel.
- The **i.LINK** button is also used to exit the i.LINK control panel.
- ② Press **▲/▼/◀/▶** to select a function, and then press **ENTER**.

i.LINK control panel (D-VHS decks)

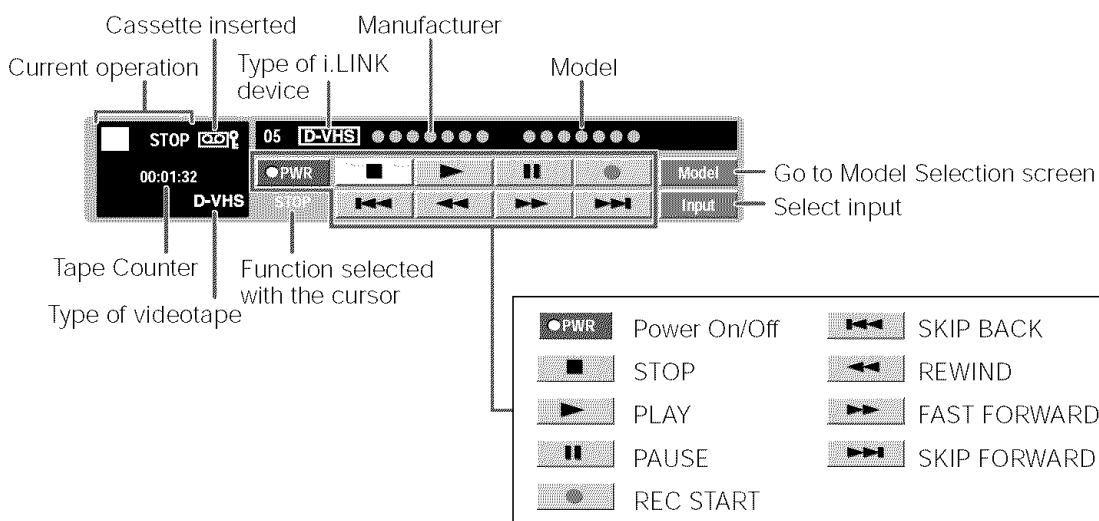

i.LINK control panel (AV-HDD recorder/Blu-ray Disc recorder)

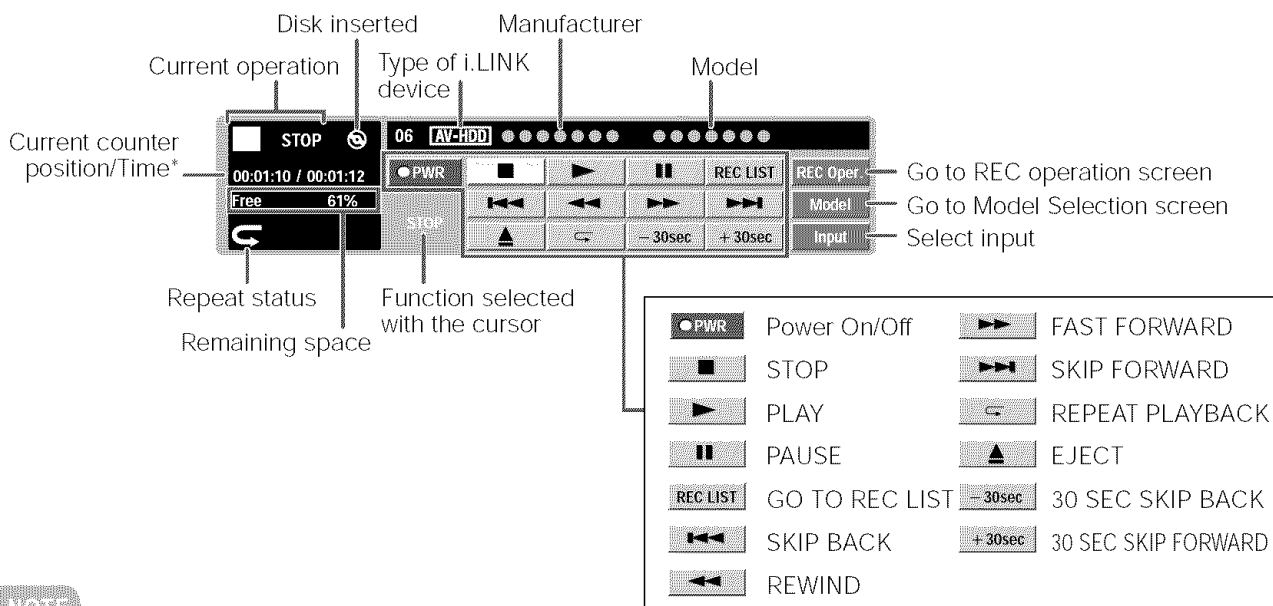

NOTE

- The input selection button is used to select either i.LINK input or others.
- The EJECT button is displayed for Blu-ray Disc recorder only.
- * Time: If you commence playback before Time is displayed, Time will not be displayed during the playback.

Using external equipment

NOTE

- IEEE1394 is the IEEE's international standard.
- i.LINK and the i.LINK logo are registered trademarks of Sony Electronic, Inc.
- A copy protection technology is used on i.LINK devices that incorporate copyright protection. This technology has received the approval of the Digital Transmission Licensing Administrator (DTLA), an organization that administers copyright protection technologies. Some picture and sound data have restrictions on duplication. Such data cannot be digitally copied using the i.LINK. Some picture and sound data may not be able to be sent back and forth between an i.LINK device that has DTLA copyright protection technology and one that does not.

Notes on i.LINK connection of D-VHS deck/AV-HDD recorder/Blu-ray Disc recorder

- Even when a connected i.LINK device is playing, input signal can be switched to input mode other than i.LINK by shifting the cursor to the input selection button and pressing **ENTER**.
- This TV may not be able to operate some i.LINK devices using the control panel, or to display picture and/or sound input from some i.LINK devices.
- When the TV's control panel is used to record a program, what is recorded with the i.LINK device are the pictures and sound of the digital program that the TV is receiving.
- The i.LINK control panel cannot be used during timer recording.
- There may be some programs which i.LINK devices cannot record.
- With some i.LINK devices, the quality of the picture may be distorted during fast forwarding or rewinding.

Notes specifically on i.LINK connection of D-VHS deck

- Depending on the D-VHS deck, this TV's i.LINK may not allow viewing of VHS and S-VHS tape or analog recorded D-VHS tape. In this case, connect the D-VHS deck's analog output with the TV's analog input, and switch the TV's input mode to external input.
- If a D-VHS deck is operated with the TV's control panel during timer recording, the recording may fail. Do not use the TV's control panel to operate the D-VHS deck during timer recording.
- To record the picture and sound of a digital program which the TV is receiving, use D-VHS tape. VHS or S-VHS tape will not record.

Notes specifically on i.LINK connection of AV-HDD recorder/Blu-ray Disc recorder

- Depending on the AV-HDD recorder and/or Blu-ray Disc recorder, some functions, such as playback during recording, display of the recording list screen during recording, and so on, may not be able to be operated.
- Depending on the AV-HDD recorder and/or Blu-ray Disc recorder, playback may stop automatically when switching to another i.LINK device.
- If an AV-HDD recorder/Blu-ray Disc recorder is operated with the TV's control panel during timer recording, the recording may fail. Do not use the TV's control panel to operate the AV-HDD recorder/Blu-ray Disc recorder during timer recording.

Notes specifically on i.LINK connection of AV-HDD recorder

- Depending on the AV-HDD recorder, it may be possible to change the recorder's operations mode (D-VHS mode, HDD recorder mode). When the operations mode is D-VHS mode, the HDD recorder is recognized as a D-VHS Deck.

Automatic input switching to i.LINK

- Input mode can be set to automatically switch to i.LINK when an i.LINK device connected to the TV is played.

1

Press **MENU** to display the MENU screen.

2

Press **◀/▶** to select "Digital Setup", and then press **ENTER**.

3

Press **▲/▼** to select "i.LINK Setup", and then press **ENTER**.

4

Press **▲/▼** select "i.LINK Autoswitch", and then press **ENTER**.

5

Press **◀/▶** to select "Yes", and then press **ENTER**.

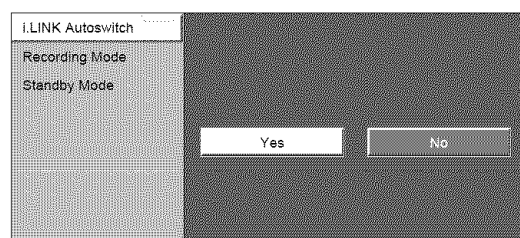

Recording digital programs with a D-VHS deck (i.LINK)

- Before commencing this procedure, the steps in "i.LINK Setup" on page 54 need to be completed beforehand.
- Please also refer to the operation manual of the D-VHS deck to be used with this TV.

1

Select a digital program to be recorded.

2

Press **i.LINK** to display the i.LINK control panel.

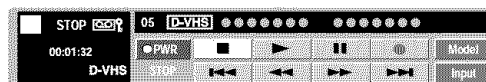

3

Press **▲/▼/◀/▶** to select **●**, and then press **ENTER**.

- Recording starts.
- Select **■** and press **ENTER** to stop recording.

NOTE

- Input mode cannot be switched to i.LINK during recording.
- When a D-VHS deck connected to the TV is under timer recording, the deck cannot be operated using the TV's control panel.

Using external equipment

Recording digital programs with AV-HDD recorder/Blu-ray Disc recorder

- Before commencing this procedure, the steps in "i.LINK Setup" on page 54 need to be completed beforehand.
- Please also refer to the operation manual of the AV-HDD recorder/Blu-ray Disc recorder to be used with this TV.

1 Select a digital program to be recorded.

2 Press **i.LINK** to display the i.LINK control panel.

3 Press **▲/▼/◀/▶** to select "REC Oper.", and then press **ENTER**.

4 Press **▲/▼/◀/▶** to select **●**, and then press **ENTER**.

- Recording starts.
- Select "REC STOP" and press **ENTER** to stop recording.



NOTE

- Input mode cannot be switched to i.LINK during recording.
- When the input mode is i.LINK, you cannot operate recording.
- When an AV-HDD recorder/Blu-ray Disc recorder connected to the TV is under timer recording, the recorder cannot be operated using the TV's control panel.

Playing back using REC LIST (i.LINK)

- You can display a list of the programs you have recorded on AV-HDD recorder and Blu-ray Disc.

1 Press **i.LINK** to display the i.LINK control panel.

2 Press **▲/▼/◀/▶** to select "REC LIST", and then press **ENTER** to display the REC LIST.

3 Press **▲/▼** to select the desired program, and then press **ENTER**.

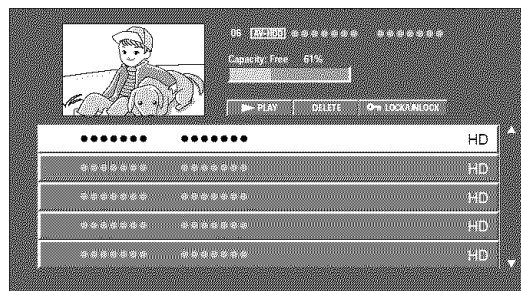

4 Press **◀/▶** to select "PLAY", and then press **ENTER**.

5 Press **◀/▶** to select "From Top" or "From current position", and then press **ENTER**.

Selected item	Description
From top	Playback will start from the beginning of the selected program.
From current position	Playback will start from the point playback stopped last time.

NOTE

- A program in the REC LIST may be deleted by performing: Select the program → Press **ENTER** → Select "DELETE" on REC LIST → Press **ENTER** → Select "Delete" → Press **ENTER**
- A program in the REC LIST may be locked or unlocked by performing: Select the program → Press **ENTER** → Select "LOCK/UNLOCK" → Press **ENTER**
- Depending on the device connected, the audio and images of the program selected with the cursor may not be displayed in the small play screen.
- Depending on the device connected, when the recording list is displayed during recording, the recording may stop.
- The program information displayed in the title (Program name, date and time, etc.) will be taken from the program information for the program broadcast at the time recording commenced.
- When recording several programs in succession, the program information displayed will be that of the first program recorded at the time recording originally commenced.
- When playing back content recorded on other devices, the program information in the title may not be displayed correctly in some cases.

Useful adjustment settings

Image position (AV input mode only)

For adjusting a picture's horizontal and vertical position.

1 Press **MENU** and the MENU screen displays.

2 Press **◀/▶** to select "Setup".

3 Press **▲/▼** to select "Position", and then press **ENTER**.

4 Press **▲/▼** to select "H-Pos." or "V-Pos.".

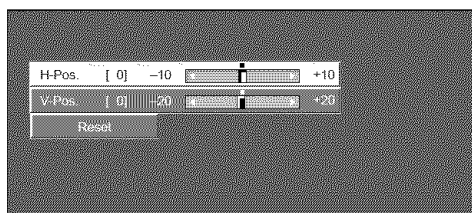

Selected item	Description
H-Pos.	Centers the image by moving it to the left or right.
V-Pos.	Centers the image by moving it up or down.

5 Press **◀/▶** to adjust the item to your desired position.

NOTE

- For resetting all adjustment items to the factory preset values, press **▲/▼** to select "Reset", and then press **ENTER**.
- **Adjustments are stored separately according to input source.**
- You can easily move the image position as shown on this page, but when the power is switched off the image will return to the previously memorized position.

Moving the picture on the screen

You can move the picture around on the screen.

Press **▲/▼/◀/▶** to move an image on the screen to the desired position. Press **ENTER** to return to the initial image position.

NOTE

- While pressing **▲/▼/◀/▶**, an on-screen image, "Adjusting Position" displays to the desired position.
- This setting cannot be stored. Once the TV shuts down or enters standby mode, the setting is erased. To move the picture around the screen again, you must perform the above procedure again.
- The image position setting using the steps on this page can be stored. Select either according to your objectives.
- "TV", "INPUT1", "INPUT2", "INPUT3" and "INPUT4" can each adjust the image position setting on this page. The same for view modes.
- An on-screen image from PC cannot be moved around.
- Even when the image fills the screen, its position can be adjusted with this function.
- Press **ENTER** to reset the image to original positions.

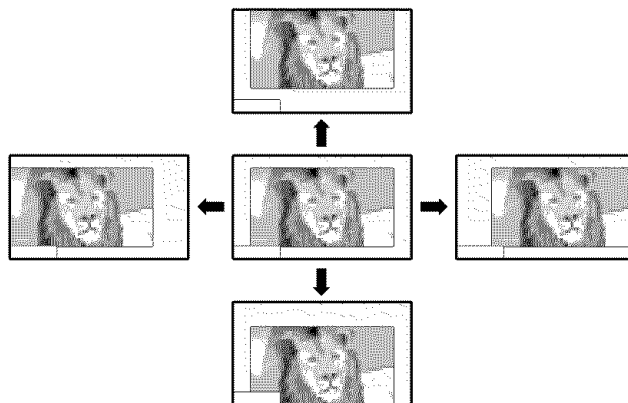

Useful adjustment settings

Auto Sync. adjustment (PC input mode only)

For automatically adjusting the PC image.

1 Press **MENU** and the MENU screen displays.

2 Press **◀/▶** to select "Setup".

3 Press **▲/▼** to select "Auto Sync.", and then press **ENTER**.

4 Press **◀/▶** to select "Yes", and then press **ENTER**.

- Auto Sync. starts and "Now adjusting the image" displays.

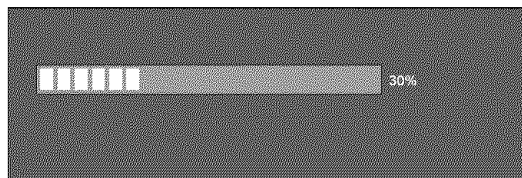
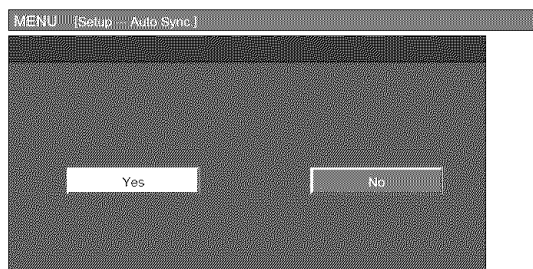

NOTE

- When Auto Sync. is successful, "Completed" displays. If not, Auto Sync. failed.
- Auto Sync. may fail even if "Completed" displays.
- Auto Sync. may fail if the computer image has low resolution, has unclear (black) edges, or is moved while executing Auto Sync.
- Be sure to connect the PC to the TV and switch it on before starting Auto Sync.

Fine Sync. adjustment (PC input mode only)

Ordinarily you can easily adjust the picture as necessary to change image position using Auto Sync. In some cases, however, manual adjustment is needed to optimize the image.

1 Press **MENU** and the MENU screen displays.

2 Press **◀/▶** to select "Setup".

3 Press **▲/▼** to select "Fine Sync.", and then press **ENTER**.

4 Press **▲/▼** to select the specific adjustment item.

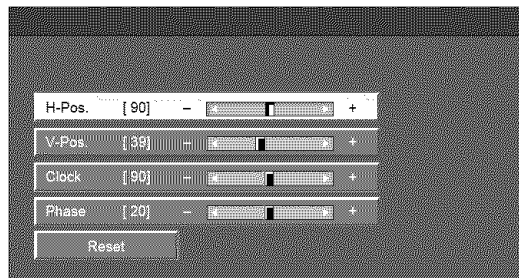

5 Press **◀/▶** to adjust the item to your desired position.

NOTE

- For resetting all adjustment items to the factory preset values, press **▲/▼** to select "Reset", and then press **ENTER**.

Selected item	Description
H-Pos.	Centers the image by moving it to the left or right.
V-Pos.	Centers the image by moving it up or down.
Clock	Adjust when the image flickers with vertical stripes.
Phase	Adjust when characters have low contrast or when the image flickers.

Input Select

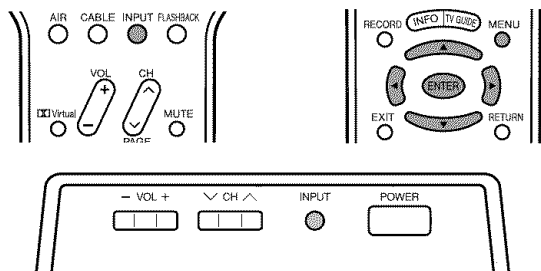

Selecting input source

Use this menu to select the input source.

1 Press **INPUT**.
 • A list of selectable sources appears.

2 Press **INPUT** again to select the input source.
 • An image from the selected source automatically displays.
 • You can also select the input source by pressing **▲/▼**.
 • If the corresponding input is not plugged in, you cannot change the input. Be sure to connect the equipment beforehand.
 • When the CableBox is selected in TV Guide On Screen setting, CableBox will be displayed in the INPUT SOURCE screen. If you select CableBox in the INPUT SOURCE screen you can change the channels of the CableBox.

Selecting input signal type

For setting the signal type of external equipment connected to INPUT 1 and INPUT 2 terminals.

1 Press **MENU** and the MENU screen displays.

2 Press **◀/▶** to select "Option".

3 Press **▲/▼** to select "Input Select", and then press **ENTER**.

4 Press **▲/▼** to select a signal type you want to set, and then press **ENTER**.
 • If the selected signal type is incorrect, images are not displayed or displayed without any color.

NOTE

- If you set INPUT1 and INPUT2 to Auto, the TV will automatically select the input signal.
- Check the operation manual of the external equipment for the signal type.
- Setting INPUT 1 and INPUT 2 signal selection to "Auto" when other equipment is connected will result in the following connectivity priority.

INPUT 1 and INPUT 2

1. COMPONENT VIDEO
2. VIDEO

DVI input signal setting

1 Press **INPUT** to select INPUT5.

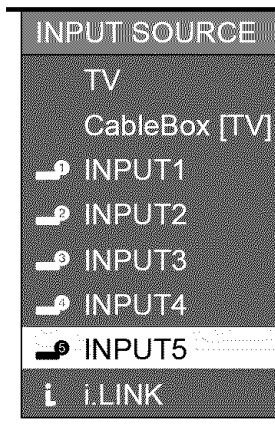

2 Press **MENU** and the MENU screen displays.

3 Press **◀/▶** to select "Option".

4 Press **▲/▼** to select "Input Select", and then press **ENTER**.

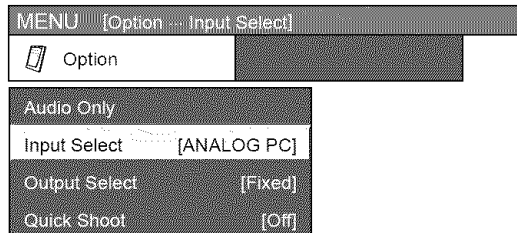

5 Press **▲/▼** to select the equipment connected to INPUT 5 terminal, and then press **ENTER**.

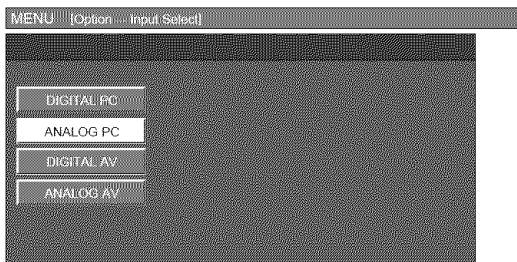

Useful adjustment settings

Input Label

Lets you set the input terminal displayed using the INPUT SOURCE menu or channel display.

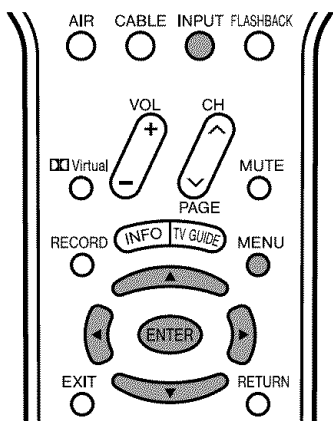

1 Press **INPUT** to select the desired input mode.

2 Press **MENU** and the MENU screen displays.

3 Press **◀/▶** to select "Setup".

4 Press **▲/▼** to select "Input Label", and then press **ENTER**.

5 Press **▲/▼/◀/▶** to select the new name for the input mode, and then press **ENTER**.

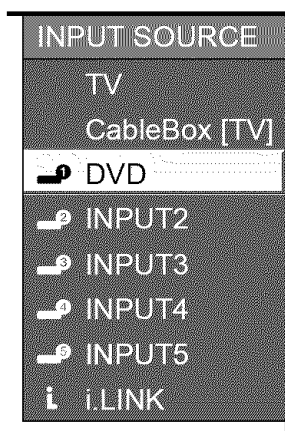

(Example)

NOTE

- You cannot change labels if the INPUT SOURCE is TV, or i.LINK.

Picture Flip

You can set the orientation of the picture.

1 Repeat steps 1 and 2 in **Input Label**.

2 Press **▲/▼** to select "Picture Flip", and then press **ENTER**.

3 Press **▲/▼** to select the desired mode, and then press **ENTER**.

[Standard]: normal image.

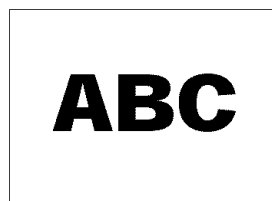

[Mirror]: mirror image.



[Upside Down]: upside down image.



[Rotate]: rotated image.



Useful adjustment settings

AV MODE

AV MODE gives you six viewing options to choose from to best match environment of the TV, which can vary due to factors like room brightness, type of program watched or the type of image input from external equipment.

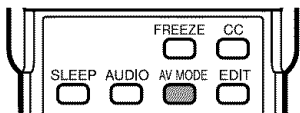

1

Press **AV MODE**.

- Present AV MODE displays.

2

Press **AV MODE** again before the mode displayed on the screen disappears.

- The mode changes as shown below.

Mode selection for TV, INPUT 1 to 5 and i.LINK mode (Example)

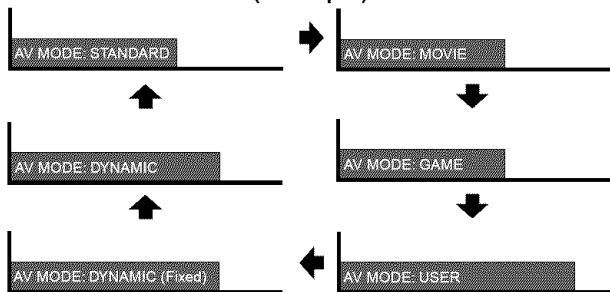

Mode selection for the PC terminal (Example)



Selected item	Description
STANDARD	For a highly defined image in a normally bright room
MOVIE	For a movie
GAME	Lowers image brightness for easier viewing
USER	Allows the user to customize settings as desired. You can set the mode for each input source.
DYNAMIC (Fixed)	Changing image and sound settings to factory preset values. No adjustments are allowed.
DYNAMIC	For a clear-cut image emphasizing high contrast for sports viewing

NOTE

- You can select a different AV MODE item for each input mode. (For example, select STANDARD for TV input and DYNAMIC for VIDEO input.)

View mode for 4:3 Programs

1

Press **VIEW MODE**.

- The View mode menu displays.
- The menu lists the view mode options selectable for the type of video signal currently received.

2

Press **VIEW MODE** or ▲/▼ while the View mode menu is still on the screen.

- You can sequentially select a view mode that has its own aspect ratio.

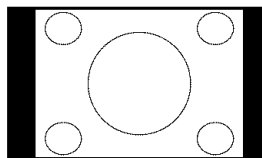
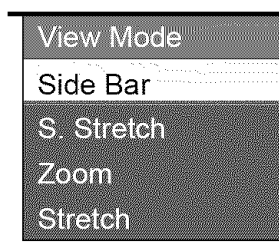
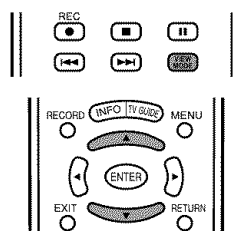

Side Bar:

Suitable for viewing conventional 4:3 programs in their normal format.

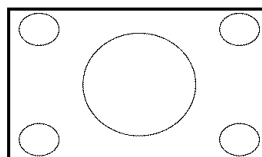

S.Stretch (Smart stretch):

Suitable for stretching 4:3 programs to fill the screen.

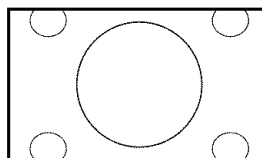

Zoom:

Suitable for viewing wide-screen 2.35:1 anamorphic DVDs in full screen.

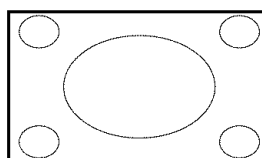

Stretch:

This mode is useful for 1.78:1 DVDs. When viewing 1.85:1 DVDs, stretch mode will still show very thin black bands at the top and bottom of the screen.

View mode for HD Programs

The following modes are available for HD programs.

S.Stretch: (Smart stretch) Suitable for stretching 4:3 programs to fill the screen.

Zoom: Suitable for viewing wide-screen 2.35:1 aspect-ratio programs in full screen.

Stretch: Suitable for viewing wide-screen 1.78:1 aspect-ratio programs. When viewing 1.85:1 programs, stretch mode will still show very thin black bands at the top and bottom of the screen.

Dot by Dot: Detects the resolution of the signal and displays an image with the same number of pixels on the screen.

NOTE

- When using Dot by Dot, it is possible to see noise or bars around different outer portions of the screen. Please change view mode to correct this.

Useful adjustment settings

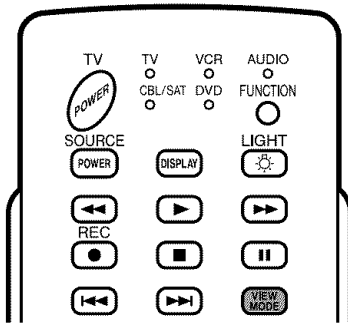

EXAMPLE

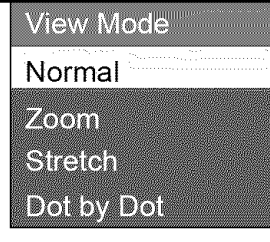

View mode (for PC input mode)

You can select the screen size.

NOTE

- Connect the PC before making adjustments. (See page 52.)
- Selectable screen size may vary with input signal type.

1

Press **VIEW MODE**.

- The View mode menu displays.

2

Press **VIEW MODE** or **▲/▼** to select a desired item on the menu.

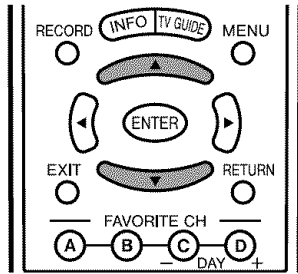

EXAMPLE

Screen size images.

Input signal	Normal	Zoom	Stretch	Dot by Dot
	Keeps the original aspect ratio in a full screen display.	Keeps the original aspect ratio in a full screen display. The top and bottom of the image is slightly cropped.	An image fully fills the screen.	Detects the resolution of the signal and displays an image with the same number of pixels on the screen.

Useful adjustment settings

Input signal (for PC input mode)

- Some input signals may have to be registered manually to display properly.
- The pairs of input signals (resolutions) in the list below are not distinguishable when received. In such case, you have to set the correct signal manually. After setting once, it will display when the same signal (resolution) is input again.

640 × 400	720 × 400
640 × 480	848 × 480
1024 × 768	1280 × 768

NOTE

- You can only select the "Input Signal" on the Setup menu when receiving one of the 6 input signals listed above.

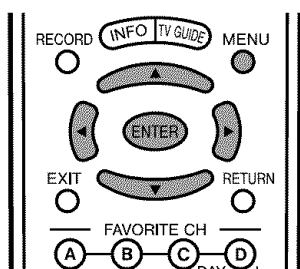

1 Press **MENU** and the MENU screen displays.

2 Press **◀/▶** to select "Setup".

3 Press **▲/▼** to select "Input Signal" and then press **ENTER**.

4 Press **▲/▼** to select the desired input signal on the display.

Example

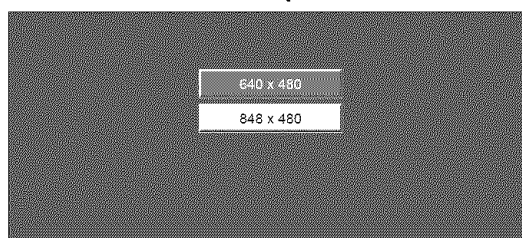

3D Noise Reduction

Produces a clearer video image.

1 Press **MENU** and the MENU screen displays.

2 Press **◀/▶** to select "Option".

3 Press **▲/▼** to select "3D Noise Reduction", and then press **ENTER**.

4 Press **▲/▼** to select the desired level, and then press **ENTER**.

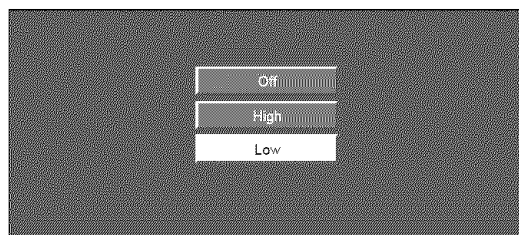

Mosquito Noise Reduction

Reduces fine detail mosquito noise.

1 Repeat steps 1 and 2 in **3D Noise Reduction**.

2 Press **▲/▼** to select "Mosquito Noise Reduction", and then press **ENTER**.

3 Press **▲/▼** to select the desired level, and then press **ENTER**.

Selected item	Description
Off	For normal images
High	For enhanced Mosquito Noise Reduction
Low	For moderate Mosquito Noise Reduction

Audio Only

When listening to music from a music program, you can set the Liquid Crystal display off and enjoy audio only.

1 Repeat steps 1 and 2 in **3D Noise Reduction**.

2 Press **▲/▼** to select "Audio Only", and then press **ENTER**.

3 Press **◀/▶** to select "On", and then press **ENTER**.

Selected item	Description
On	Audio is output without screen image.
Off	Both screen images and audio are output.

Useful adjustment settings

Output Select

Allows you to select what controls the audio output.

- 1 Press **MENU** and the MENU screen displays.
- 2 Press **◀/▶** to select "Option".
- 3 Press **▲/▼** to select "Output Select", and then press **ENTER**.
- 4 Press **◀/▶** to select "Fixed" or "Variable", and then press **ENTER**.

Selected item	Description
Fixed	<ul style="list-style-type: none"> • Sound via speaker is adjusted with VOL +/- on the remote control unit or VOL -/+ on the TV. • Sound via the MONITOR OUT terminal is not adjustable and constantly outputs.
Variable	<ul style="list-style-type: none"> • Sound via the MONITOR OUT terminal is adjusted with VOL +/- on the remote control unit or VOL -/+ on the TV. • Sound via speaker is muted.

Quick Shoot

Use Quick Shoot to view fast-action video more clearly.

- 1 Repeat steps 1 and 2 in **Output Select**.
- 2 Press **▲/▼** to select "Quick Shoot", and then press **ENTER**.
- 3 Press **◀/▶** to select "On", and then press **ENTER**.

NOTE

- If video noise occurs, turn the function "Off".

Sleep Timer

Allows you to set a time when the TV automatically switches to standby.

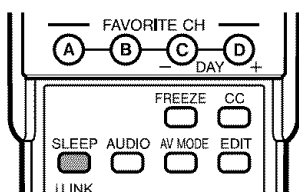

- 1 Press **SLEEP**.
 - Remaining time displays when sleep timer has been set.

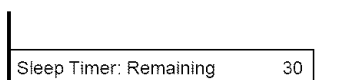

2

Each time you press **SLEEP**, the remaining time switches as shown below.

- When set, the time automatically starts counting down.
- If you want to adjust the sleep timer, you can press **SLEEP** twice then change the time setting.
- Five minutes before time expires, the remaining time displays each minute.

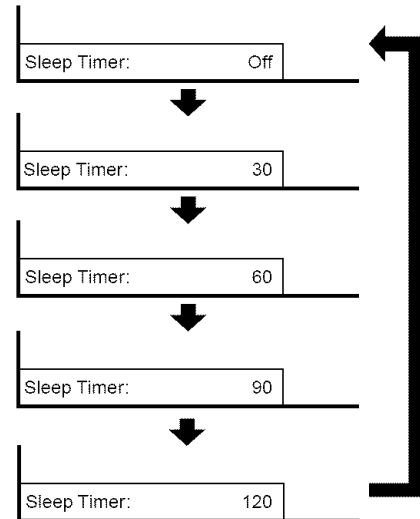

NOTE

- Select "Off" by pressing **SLEEP** to cancel the sleep timer.
- The TV will enter the standby mode when the remaining time reaches zero.
- When the sleep timer is working, its indicator on the TV lights red.

Program Title Display

Select the CH display when changing channels for digital broadcasting.

- 1 Press **MENU** and the MENU screen displays.
- 2 Press **◀/▶** to select "Option".
- 3 Press **▲/▼** to select "Program Title Display", and then press **ENTER**.
- 4 Press **◀/▶** to select "Yes" or "No", and then press **ENTER**.

Selected item	Description
Yes	"Program Info." displays
No	"Program Info." does not display

Closed Captions and Digital Closed Captions

- Your TV is equipped with an internal Closed Caption decoder. It allows you to view conversations, narration and sound effects as subtitles on your TV. Closed Captions are available on some TV programs, and on some VHS home video tapes, at the election of the program provider.
- Digital Closed Caption service is a new caption service available only on digital TV programs (also at the election of the service provider). It is a more flexible system than the original Closed Caption system, because it allows a variety of caption sizes and font styles. When the Digital Closed Caption service is in use, it will be indicated by appearance of a 3-letter abbreviation that also indicates the language of the Digital Closed Captions: ENG (English) or SPA (Spanish) or FRA (French), or other language codes.
- Not all programs and VHS videotapes offer closed caption. Please look for the "CC" symbol to ensure that captions will be shown.
- In the Closed Caption system, there can be more than one caption service provided. Each is identified by its own number. The "CC1" and "CC2" services display subtitles of TV programs superimposed over the program's picture.
- In the Closed Caption system, the "Text1" or "Text2" services display text that is unrelated to the program being viewed (e.g., weather or news). These services are also superimposed over the program currently being viewed.

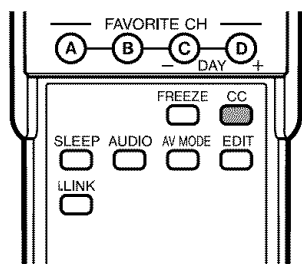

1

Press **CC**.

- This will present the Closed Caption information display.

2

Press **CC** while the Closed Caption information is still on the screen.

- Press repeatedly until you select a closed caption service which you prefer.

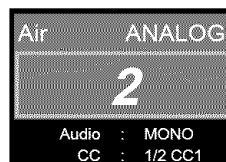

Closed Caption information

- Depending on the number of caption services in the signal being received, you will see information such as 1/2 or 1/4 displayed. 1/2 means "the first of two services".

Example:

If a program has three services (Digital CC(ENG), CC1 and Text1), the closed caption display will toggle in this sequence:

1/3 ENG → 2/3 CC1 → 3/3 Text1 → OFF

- The CC button keeps a record of the last service selected in its memory.

If the last closed caption mode (e.g. 1/3ENG) you selected is not available for the next program, or on another channel, the closed caption service that is available is automatically selected, and this service appears in parentheses, e.g.1/3(CC1).

Closed caption services that appear in parentheses will not be recorded in the CC button's memory as your last selected service. Only services that you have selected with the CC button are recorded.

Examples:

In a case where there are two closed caption services provided, (for instance, Digital CC(ENG) and CC1), and Digital CC(ENG) is displayed as your current selection, if Digital CC(ENG) is not broadcast for the next program, the other closed caption service, CC1, will be displayed in parentheses.

A closed caption service appears in parentheses because the service you selected is not available and a different service is displayed on your screen. "1/1(CC1)" is displayed instead of "1/2/ENG".

NOTE

- See page 68 for detailed closed caption settings.
- When using Freeze functions, closed captions will not be displayed on the right-most screen (still image).
- When the program contains no closed caption, "--" displays in the closed caption information.
- If the language code, e.g. "ENG", is not found on Digital TV programs, "--" will be shown.
- Four kinds of closed caption service (CC1, CC2, Text1, Text2) are potentially available, but a broadcast may contain none, or only some of these services, at the election of the program provider.

Useful adjustment settings

Caption Setup

This function allows you to adjust the closed caption screen appearance to suit your preference.

1 Press **MENU** and the MENU screen displays.

2 Press **◀/▶** to select "Option".

3 Press **▲/▼** to select "Caption Setup", and then press **ENTER**.

4 Press **▲/▼** to select a specific adjustment item.

- You can choose 7 items here; they are,
 - ① "Caption Size",
 - ② "Font Style",
 - ③ "Foreground Color",
 - ④ "Foreground Opacity",
 - ⑤ "Background Color",
 - ⑥ "Background Opacity" and
 - ⑦ "Character Edge".

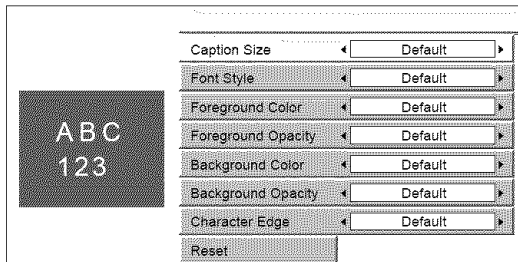

5 Press **◀/▶** to select the desired parameter.

NOTE

- For resetting all adjustment items to the factory preset values, press **▲/▼** to select "Reset", and then press **ENTER**.
- Each default value is specified by broadcasting station where available.

Selectable items available for "Font Style".

Selected item	Description
Default	The font specified by broadcasting station or default font.
Type 0	Proportional font used in the MENU screen.
Type 1	Monospaced with serifs.
Type 2	Proportionally spaced with serifs.
Type 3	Monospaced without serifs.
Type 4	Proportionally spaced without serifs.
Type 5	Casual font type.
Type 6	Cursive font type.
Type 7	Small capitals.

Useful adjustment settings

Secret number setting for parental control (AV input mode only)

Allows you to use a secret number to protect certain settings from being accidentally changed.

IMPORTANT:

Three conditions must be met to enable V-Chip (see pages 69 to 74):

- ① Secret No. is registered.
- ② V-Chip settings have been made.
- ③ "Status" is set to "On".

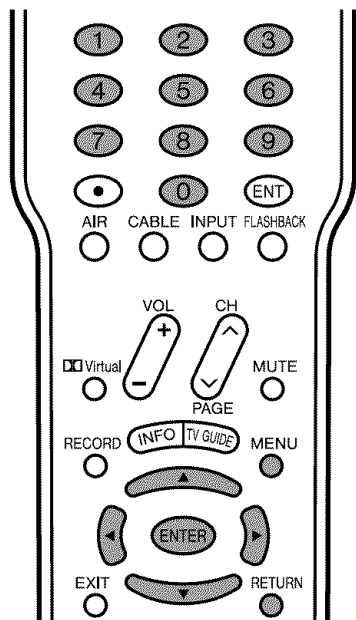

Setting a secret number

- 1 Press **MENU** and MENU screen displays.
- 2 Press **◀/▶** to select "Setup".
- 3 Press **▲/▼** to select "Parental CTRL", and then press **ENTER**.
- 4 Press **▲/▼** to select "Secret No.", and then press **ENTER**.

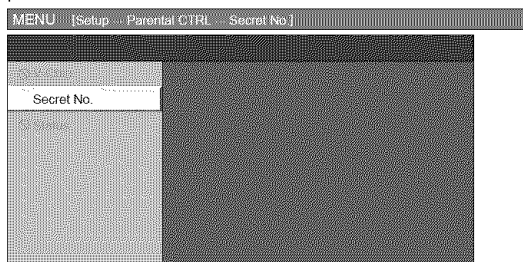

5

Select "New Secret No.", and then press **ENTER**.

Input the new 4-digit secret number by using **0 – 9**.

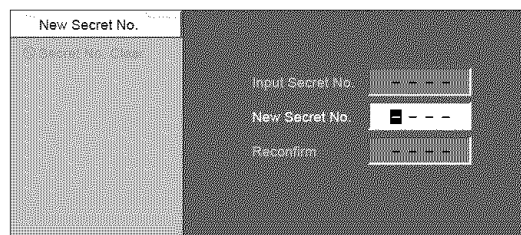

6

Input the same 4-digit number on the "Reconfirm" screen as in step 5 to confirm.

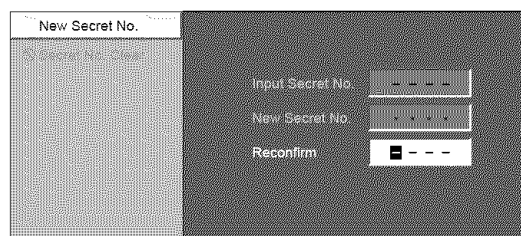

7

Press **RETURN** to start configuring V-Chip settings. (See pages 72 and 74 for details.)

Setting parental control status

Used to enable or disable the parental control function.

1

Repeat steps 1 to 3 in **Setting a secret number**.

- Secret number setting menu displays.

2

Input the 4-digit secret number by using **0 – 9**.

3

Press **▲/▼** to select "Status", and then press **ENTER**.

4

Press **◀/▶** to select "On" or "Off", and then press **ENTER**.

- Select "On" to enable and "Off" to disable Parental CTRL.

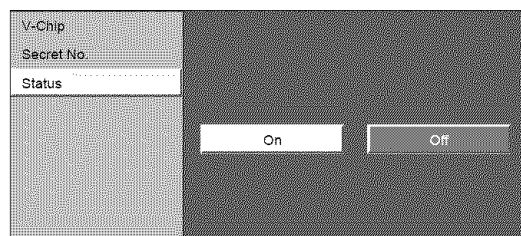

NOTE

- You can skip step 1 and 2 above while in Parental CTRL screen.

Useful adjustment settings

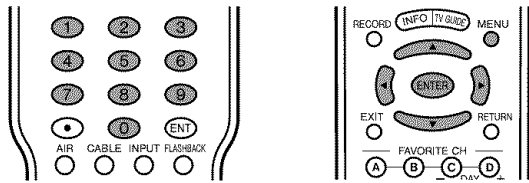

Changing the secret number

Allows you to change your current secret number.

1 Repeat steps 1 to 3 in **Setting a secret number**.

- Secret number setting menu displays.

2 Input the 4-digit secret number by using **0 – 9**.

3 Press **▲/▼** to select "Secret No.", and then press **ENTER**.

4 Press **▲/▼** to select "New Secret No.", and then press **ENTER**.

5 Input the old 4-digit number you have set using **0 – 9**.

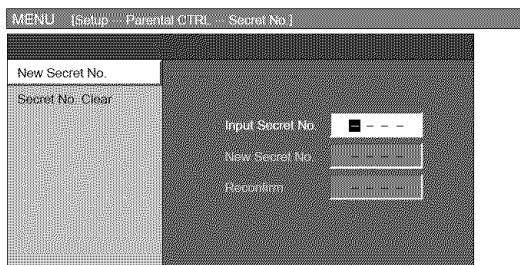

6 Input the new 4-digit number using **0 – 9**.

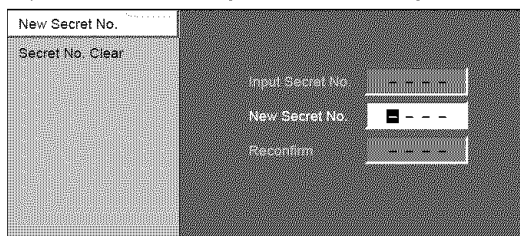

7 Input the same 4-digit number on the "Reconfirm" screen as in step 6 to confirm.

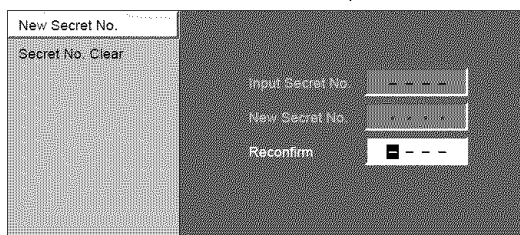

Clearing the secret number

Allows you to clear your secret number.

1 Repeat steps 1 to 3 in **Setting a secret number**.

- Secret number setting menu displays.

2 Input the 4-digit secret number by using **0 – 9**.

3 Press **▲/▼** to select "Secret No.", and then press **ENTER**.

4 Press **▲/▼** to select "Secret No. Clear", and then press **ENTER**.

5 Press **◀/▶** to select "Yes", and then press **ENTER**.

- Your secret number is cleared.

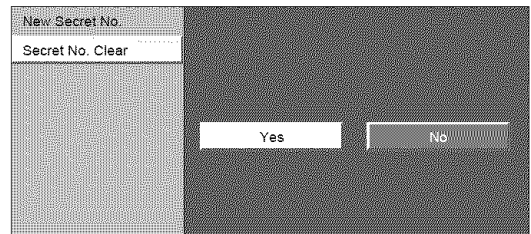

NOTE

- See page 69 for re-registering with a new secret number after being cleared.
- **As a precautionary measure, make a note of your secret number and keep it in a familiar place. If you lose or forget your secret number, initialize the Liquid Crystal Television to return all settings except for the TV channel settings to factory preset values. (See page 87.)**
- If the secret number is cleared the Status setting automatically sets to "Off". "V-Chip" and "Status" will not be selectable from the menu.

Useful adjustment settings

Parental control (setting V-CHIP level)

V-CHIP is an electronic filtering device built into your TV. This tool gives parents a great degree of control over broadcasts accessed by their children. It allows parents to select programs judged suitable for child viewing while blocking ones judged not suitable. It does so automatically once you activate the V-CHIP feature in your Liquid Crystal Television.

“V-Chip” and “Status” will not be selectable from the menu if you do not first configure your secret number. (See page 69 for Secret number setting for parental control.)

- The U.S. has two rating systems for viewing content: TV Parental Guidelines and movie ratings.
- The TV Parental Guidelines work in conjunction with the V-CHIP to help parents screen out inappropriate television shows from their children.
- Movie ratings are used for original movies rated by the Motion Picture Association of America (MPAA) as watched on cable TV and not edited for television. The V-CHIP can also be set to block MPAA-rated movies.

Voluntary movie rating system (MPAA)

Rating		Description
Age	G	General audiences. All ages admitted.
	PG	Parental guidance suggested. Some material may not be suitable for children.
	PG-13	Parents strongly cautioned. Some material may be inappropriate for children under 13.
	R	Restricted. Under 17 requires accompanying parent or adult guardian (age varies in some jurisdictions).
	NC-17	No one 17 and under admitted.
	X	X is an older rating that is unified with NC-17 but may be encoded in the data of older movies.

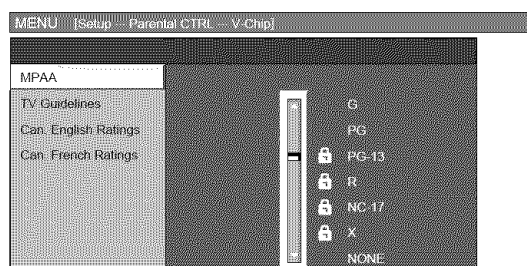

EXAMPLE

- If you select “PG-13”, this will automatically block the higher ratings “R”, “NC-17” and “X”.

NOTE

- Voluntary movie rating system only uses an age-based rating.

TV Parental Guidelines

Rating		Content				
		FV (Fantasy violence)	V (Violence)	S (Sexual situation)	L (Adult language)	D (Sexually suggestive dialog)
Suggested age	TV-Y (All children)					
	TV-Y7 (Directed to older children)	X				
	TV-G (General audience)					
	TV-PG (Parental Guidance suggested)		X	X	X	X
	TV-14 (Parents strongly cautioned)		X	X	X	X
	TV-MA (Mature audience only)		X	X	X	

X: Content rating can be set.

Useful adjustment settings

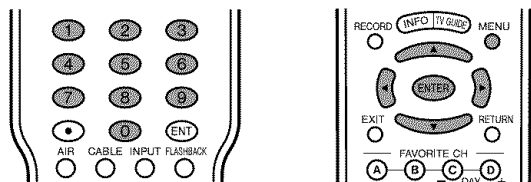

Voluntary movie rating system (MPAA)

1 Press **MENU** and the MENU screen displays.

2 Press **◀/▶** to select "Setup".

3 Press **▲/▼** to select "Parental CTRL", and then press **ENTER**.

- Secret number setting menu displays only when "Secret No." is set. (See page 69.)
- "V-Chip" and "Status" will not be selectable from the menu if you do not first configure your secret number. (See page 69.)

4 Input the 4-digit secret number by using **0 - 9**.

5 Press **▲/▼** to select "V-Chip", and then press **ENTER**.

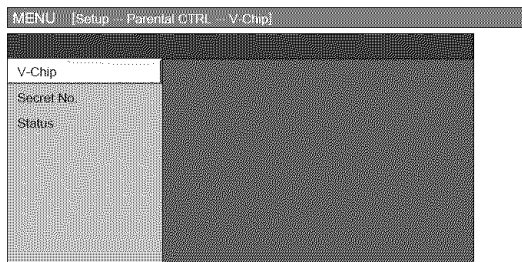

6 Press **▲/▼** to select "MPAA", and then press **ENTER**.

7 Press **▲/▼** to adjust the item to your desired position. "🔒" indicates the item is blocked. Press **RETURN**.

- The setting automatically enters "Block" for any ratings below your selection.
- If Status is not set to "On" the configuration settings will not work. (See page 69.)

Example

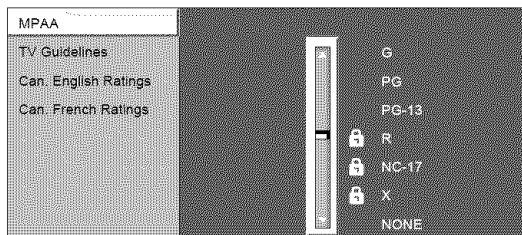

TV Parental Guidelines (TV Guidelines)

1 Repeat steps 1 to 5 in **Voluntary movie rating system (MPAA)**.

2 Press **▲/▼** to select "TV Guidelines", and then press **ENTER**.

3 Press **▲/▼** to adjust the item to your desired position. "🔒" indicates the item is blocked.

- The setting automatically enters "Block" for any ratings below your selection.

Example

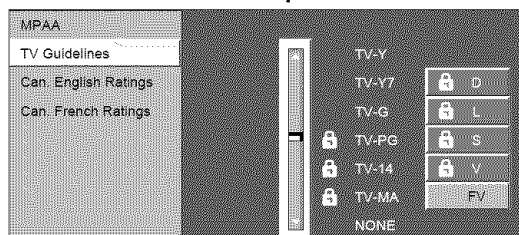

When setting an individual content-based rating item, do as follows:

- ① Press **▶** to access block content items from the currently selected age-based rating item.
- ② Press **▲/▼** to select an individual item, and then press **ENTER** to unblock ("🔒" is removed). Repeat the same steps for other items.
- ③ Press **◀** or **RETURN** to register after all individual content rating items are set.

Example

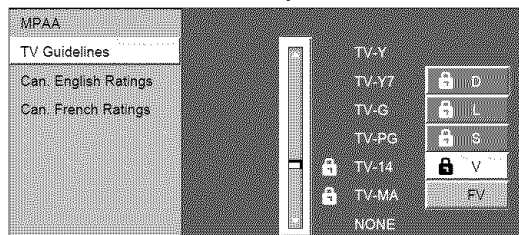

- If Status is not set to "On" the configuration settings will not work. (See page 69.)

Useful adjustment settings

Canadian Rating Systems

- The TV rating systems in Canada are based on the Canadian Radio-Television and Telecommunications Commission (CRTC) policy on violence in television programming.
- While violence is the most important content element to be rated, the structure developed takes into consideration other program content like language, nudity, sexuality and mature themes.
- When setting the V-CHIP on the Canadian system you can choose either the Canadian English ratings or the Canadian French ratings.

Canadian English ratings

Rating		Description
Age	E	Exempt: Includes news, sports, documentaries and other information programming; talk shows, music videos, and variety programming.
	C	Children: Intended for younger children under the age of 8 years. Pays careful attention to themes that could threaten their sense of security and well-being.
	C8+	Children over 8 years old: Contains no portrayal of violence as the preferred, acceptable, or only way to resolve conflict; nor encourage children to imitate dangerous acts which they may see on the screen.
	G	General: Considered acceptable for all age groups. Appropriate viewing for the entire family, contains very little violence, physical, verbal or emotional.
	PG	Parental Guidance: Intended for a general audience, but may not be suitable for younger children (under the age of 8) because it could contain controversial themes or issues.
	14+	Over 14 Years: Could contain themes where violence is one of the dominant elements of the storyline, but it must be integral to the development of plot or character. Language usage could be profane and nudity present within the context of the theme.
	18+	Adults: Intended for viewers 18 years and older and might contain depictions of violence, which while related to the development of plot, character or themes, are intended for adult viewing. Could contain graphic language and portrayals of sex and nudity.

Canadian French ratings

Rating		Description
Age	E	Exempt programming.
	G	General: All ages and children, contains minimal direct violence, but may be integrated into the plot in a humorous or unrealistic manner.
	8ans+	General but inadvisable for young children: May be viewed by a wide public audience, but could contain scenes disturbing to children under 8 who cannot distinguish between imaginary and real situations. Recommended for viewing with parent.
	13ans+	Over 13 years: Could contain frequent violent scenes and therefore recommended for viewing with parent.
	16ans+	Over 16 years: Could contain frequent violent scenes and intense violence.
	18ans+	Over 18 years: Only for adult viewing. Could contain frequent violent scenes and extreme violence.

Useful adjustment settings

Canadian English ratings

1 Press **MENU** and the MENU screen displays.

2 Press **◀/▶** to select "Setup".

3 Press **▲/▼** to select "Parental CTRL", and then press **ENTER**.

- Secret number setting menu displays only when "Secret No." is set. (See page 69.)
- "V-Chip" and "Status" will not be selectable from the menu if you do not first configure your secret number. (See page 69.)

4 Input the 4-digit secret number by using **0 – 9**.

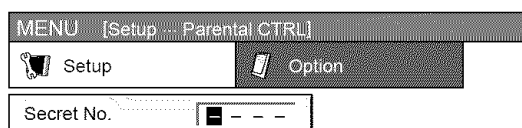

5 Press **▲/▼** to select "V-Chip", and then press **ENTER**.

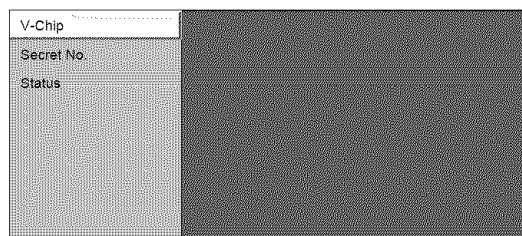

6 Press **▲/▼** to select "Can. English Ratings", and then press **ENTER**.

7 Press **▲/▼** to adjust the item to your desired position. "🔒" indicates the item is blocked.

- The setting automatically enters "Block" for any ratings below your selection.
- If Status is not set to "On" the configuration settings will not work. (See page 69.)

Example

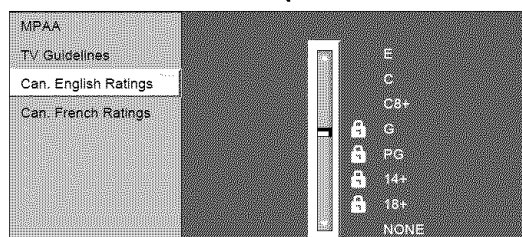

Canadian French ratings

1 Repeat steps 1 to 5 in **Canadian English ratings**.

2 Press **▲/▼** to select "Can. French Ratings", and then press **ENTER**.

3 Press **▲/▼** to adjust the item to your desired position. "🔒" indicates the item is blocked.

- The setting automatically enters "Block" for any ratings below your selection.
- If Status is not set to "On" the configuration settings will not work. (See page 69.)

Example

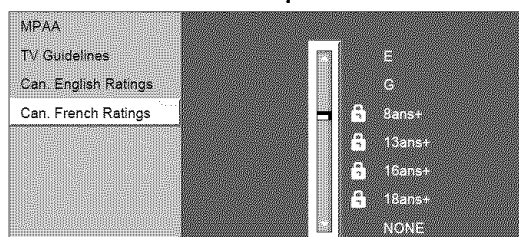

How to temporarily release the V-CHIP BLOCK

- The V-CHIP BLOCK is working and censors a broadcast, "V-CHIP HAS BEEN ACTIVATED." displays.

1 Press **ENTER** while the V-CHIP is working and then the secret number setting menu displays.

2 Enter your 4-digit secret number with **0 – 9**. At this time V-CHIP BLOCK temporarily releases.

Reactivating the temporarily released V-CHIP BLOCK

- You can reactivate the temporarily released V-CHIP BLOCK as shown below.

Method 1:

Select "Status" setting from the Parental CTRL menu to reactivate BLOCK. (See page 69.)

Method 2:

Select "V-Chip" setting ("MPAA", "TV Guidelines", "Can. English Ratings" or "Can. French Ratings") from the Parental CTRL to reactivate BLOCK. (See pages 72 and 74.)

Method 3:

Switch off the TV power.

NOTE

- Performing any of the three above will activate the V-CHIP BLOCK.

Other viewing options

Viewing information of the program

You can view information about a program you are currently watching.

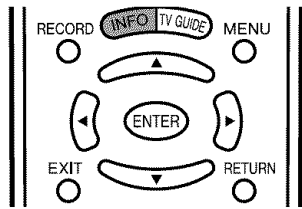

1

Press **INFO** while watching a broadcast.

- Information of the current program will be displayed.



Sample program information

- If the program you are receiving is copy-protected, an icon will be displayed in the program information. Recording digital programs via i.LINK, or recording digital audio via digital audio output terminals, is restricted.

Icon	Description
	Digital copying prohibited
	One digital copy only

NOTE

- Sometimes the name of the program is not broadcast. In that case, the program name will not be displayed.

Picture and still image

You can display two same-sized pictures – one moving and one still.

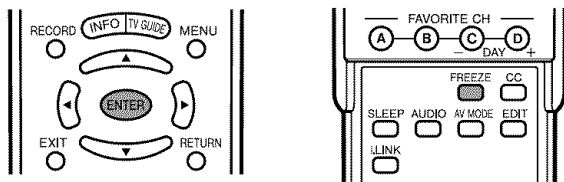

1

Press **FREEZE**.

- A moving image displays on the left screen and a still image displays on the right screen. The still image is one frame captured from a moving image at the moment you press **FREEZE**.

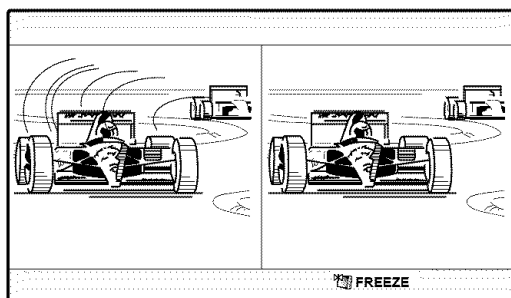

2

Update the still image by pressing **ENTER**.

- Each time you press **ENTER**, the image on the right screen updates.

3

Press **FREEZE** to exit still image.

NOTE

- This function does not work in INPUT 4 (HDMI) and INPUT 5 (DVI-I).
- When this function is not available, "No displaying still image available" will display.
- The still image is automatically erased after 30 minutes.
- If you are using freeze function and a broadcast activates the V-CHIP BLOCK, freeze function will be cancelled and a V-CHIP BLOCK message will appear.

Presetting remote control function

You can operate the connected AV products (AV Receiver, Cable Box, SAT tuner, DTV, VCR, DVD, LD) using the presetting manufacturer function for your remote control unit.

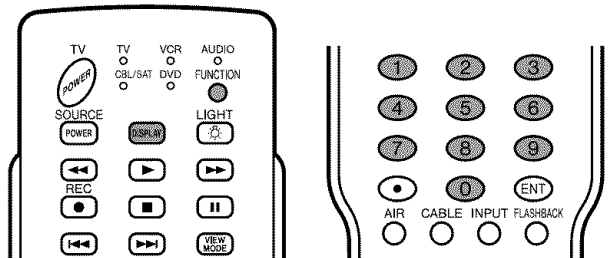

Presetting manufacturer codes

1

Press **FUNCTION** until the LED for your device lights up.

2

After the LED for your device lights up, if you press **FUNCTION** and **DISPLAY** and enter the code registration mode, the LED will blink.

3

Press **0 – 9** to enter the manufacturer code. (See page 76.)

- Preset mode is finished once the LED no longer lights up.

4

After registering the code, the LED will stop blinking then turn off after one second. (If you perform an incorrect operation, the LED will blink quickly then turn off.)

Other viewing options

Manufacturer codes

VCR BRAND	REMOTE CONTROL CODE NUMBER
Akai	25, 26, 37
Audio	15, 22, 30
Broksonic	32
Canon	04
Capehart	34
Craig	10, 31
Curtis Mathis	04
Daewoo	34
DBX	15, 22, 30
Dynatech	29
Emerson	21, 32, 35
Fisher	09, 10, 11
Funai	28, 29
G.E.	04
Goldstar	24
Hitachi	06, 47
Instant Replay	04
JC Penney	04, 06, 24, 30
JVC	15, 41, 42, 53
Kenwood	14, 15
Lloyds	29
Magnavox	04, 05, 08
Magnin	31
Marantz	30
Memorex	04, 10, 24, 29
Minolta	06
Mitsubishi	17, 18, 39, 40
Montgomery Ward	02, 43
Multitech	29
NEC	15, 22, 30
Panasonic	44, 45
Pentax	05, 06
Philco	05
Philips	05, 08
RCA	06, 07, 33, 51
Realistic	01, 02, 10, 24
Samsung	23, 31
Sanyo	10, 14, 52
Scott	20
Sears	06, 11, 24
Sharp	01, 02, 03
Shintom	36
Sony	12, 13, 38
Sound Design	29
Sylvania	05, 08
Symphonic	29
Tatung	15
Teac	15, 29
Teknika	27, 29
Thomas	29
TMK	21
Toshiba	19, 20
Video Concepts	30
Yamaha	15, 29, 30
Zenith	16

DVD/LD BRAND	REMOTE CONTROL CODE NUMBER
Denon	02
JVC	09, 13
Kenwood	21
Magnavox	04
Marantz	04
Mitsubishi	06
Panasonic	02, 22
Philips	04, 23
Pioneer	08, 11, 20
Proscan	03
RCA	03, 24
Samsung	07, 12
Sharp	01, 10
Sony	05, 25
Toshiba	04
Yamaha	02
Zenith	04

CATV/SAT BRAND	REMOTE CONTROL CODE NUMBER
Anvision	04, 05
Cable Star	04, 05
Eagle	05
General Instrument	02, 03, 07, 12, 13, 14, 19, 22
Jerrold	02, 03, 07, 12, 13, 14, 19, 22, 31, 32, 33, 34, 35, 36, 37, 38, 39, 40
Magnavox	04, 05, 09, 14, 17, 18, 20, 21, 24, 25
Oak Sigma	8
Panasonic	16, 23
Philips	04, 05, 09, 15, 17, 18, 20, 21, 24, 25
Pioneer	08, 10, 29, 30, 43*, 46
Randtek	04, 05
RCA	16, 27, 44*, 45*
Scientific Atlanta	01, 26
Sony	28
Viewstar	04, 05, 09, 15, 17, 18, 20, 21, 24, 25
Zenith	06, 14

NOTE

- Numbers marked with * are SAT codes, all others are CATV codes.

AUDIO BRAND	REMOTE CONTROL CODE NUMBER
Sharp	01

Other viewing options

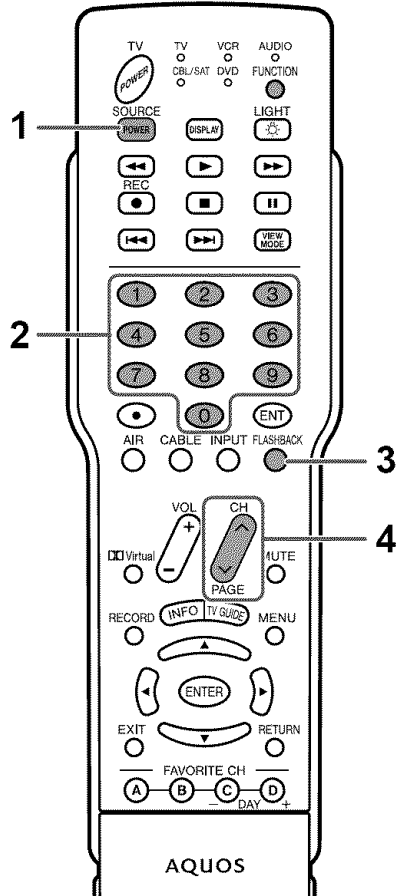

Cable control buttons

When the **FUNCTION** is set to CBL/SAT the cable converter connected to the TV can operate using **1** to **4**.

- 1 SOURCE POWER**
Turns the cable converter power on and off.
- 2 0 - 9**
Press a button (or buttons) that corresponds to the channel that you wish to watch.
- 3 FLASHBACK ***
Press to switch between the current channel and the channel you were watching immediately before.
- 4 CH \wedge / \vee**
Press **CH \wedge** or **CH \vee** to tune in a higher or lower channel.

* Some manufacturers do not preset **FLASHBACK**.

NOTE

- CABLE and SAT cannot be selected at the same time.

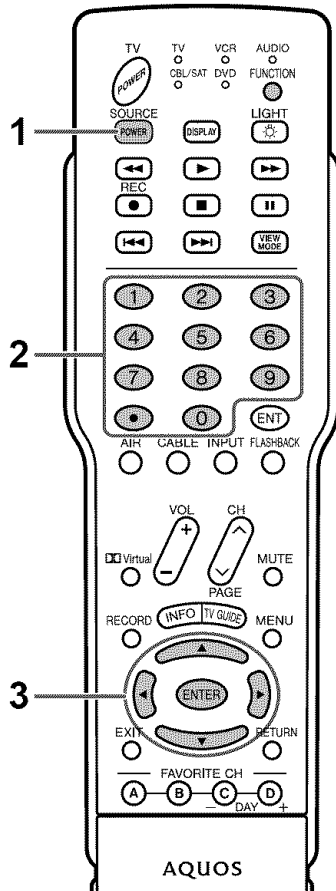

SAT control buttons

- 1 SOURCE POWER**
Turns the Satellite broadcast tuner power on and off.
- 2 0 - 9, • (DOT)**
Press a button (or buttons) that corresponds to the channel that you wish to watch.
- 3 ENTER, \blacktriangle / \blacktriangledown / \blacktriangleleft / \blacktriangleright**
ENTER: Press to activate the selected function.
 \blacktriangle / \blacktriangledown / \blacktriangleleft / \blacktriangleright : Press the button to select items on the SAT GUIDE screen or SAT MENU screen.

NOTE

- CABLE and SAT cannot be selected at the same time.

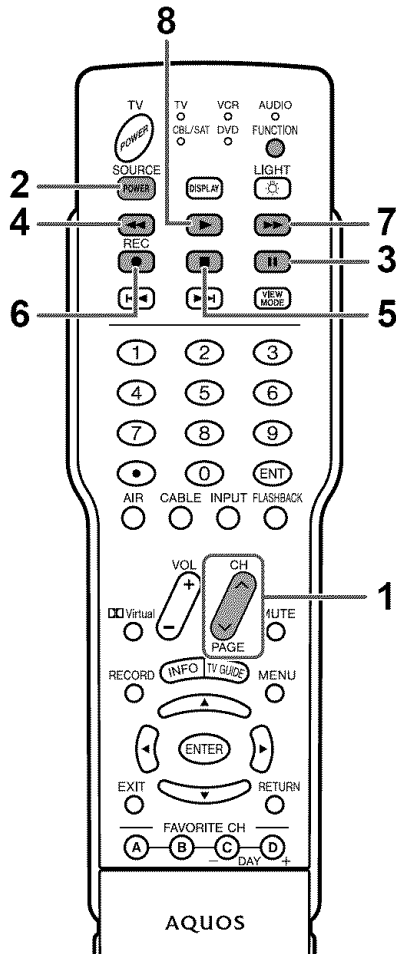

VCR control buttons

The remote control unit button will function as follows when the **FUNCTION** of the remote control unit is set to VCR.

- When the input selector button having the same number as the input terminal connecting the VCR is pressed, the VCR can operate using 1 to 8.
- 1 **CH \wedge/\vee**
Press to select the channel of the TV tuner on the VCR.
 - 2 **SOURCE POWER**
Turns the power of the VCR on and off.
 - 3 **||**
Sets pauses and still pictures.
 - 4 **◀◀**
Rewinds the tape and allows picture search.
 - 5 **■**
Stops the tape transport.
 - 6 **REC**
Starts recording.
 - 7 **▶▶**
Rapidly advances the tape and allows picture search.
 - 8 **▶**
Starts playback.

DVD control buttons

The remote control unit button will function as follows when the **FUNCTION** of the remote control unit is set to DVD.

- When the input selector button having the same number as the input terminal connecting a DVD player is pressed, these players can operate using 1 to 10.
- 1 **▶▶▶**
Pressing quickly once takes you to the start of the next chapter. Each time you press it, you move ahead to the start of the next chapter.
 - 2 **◀◀◀**
Pressing quickly once takes you to the start of the chapter currently playing. Each time you press it, you move back to the start of the previous chapter.
 - 3 **SOURCE POWER**
Turns the power of the DVD player on and off.
 - 4 **||**
Sets pauses and still pictures.
 - 5 **◀◀**
Continue pressing to go backward.
 - 6 **■**
Playback stops when pressing once. With some DVD players, pressing the button twice may open the disc tray.
 - 7 **MENU**
When this button is pressed, the DVD menu will display.
 - 8 **ENTER, $\blacktriangle/\blacktriangledown/\blacktriangleleft/\blacktriangleright$**
ENTER: Press to activate the selected function.
 $\blacktriangle/\blacktriangledown/\blacktriangleleft/\blacktriangleright$: Press the button to select items on the DVD MENU screen.
 - 9 **▶▶▶**
Continue pressing for fast forward.
 - 10 **▶**
Starts playback.

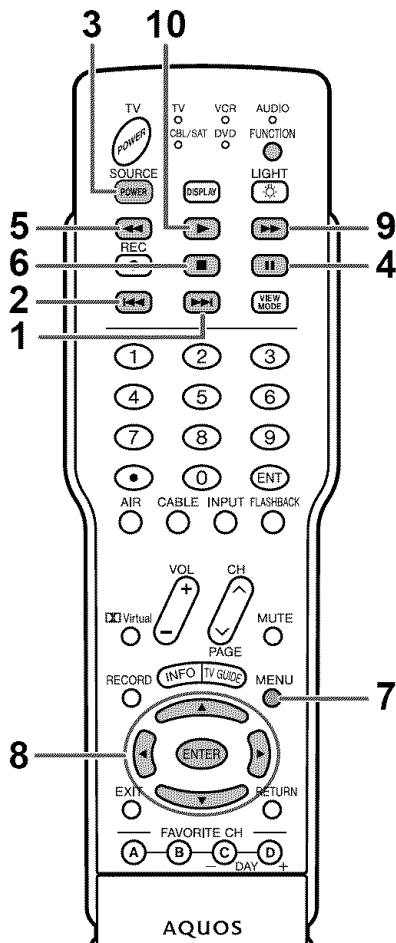

Notice

■ When you change your address

- If you change your address, please return the CableCARD security module to your Cable Provider Company.
- You will need to request a new CableCARD security module from the cable provider at your new location.

■ About EAS (Emergency Alert System)

- In the case of a national emergency, natural disaster, or other emergency situation, Cable MSO will broadcast an Emergency Alert Message (EAS message). When this unit receives an EAS message, if the level of emergency is comparatively low, an alert text message will be displayed on screen. If the level of emergency is high, the receiver will be force tuned to a details channel.
- Alert text messages will be displayed, and force tuning will occur, even during paid programming. Even when force tuning is active, the user can still change the channel.
- If the unit is force tuned to a channel that has been blocked by Parental Control, the Parental Control setting will be given priority.

NOTE

- If you have a digital cable antenna connected, you can receive EAS messages whether CableCARD security module is inserted or not.
- EAS messages may be broadcast not only via digital cable, but also via Analog Cable or over-the-air Analog transmission.
- When force tuning occurs, Video output from the MONITOR OUT terminal will also be switched to the details channel.
- An alert text message does not output from MONITOR OUT terminal.
- While TV Guide On Screen is on display, force tuning and alert text messages are NOT available and the details channel will not be displayed on the full screen.

Appendix

Removing the stand

Before detaching (or attaching) stand, unplug the AC cord from the AC input terminal.

CAUTION

- Do not remove the stand from the TV unless using an optional wall mount bracket to mount it.

Before attaching/detaching stand

- Before performing work make sure to turn off the TV.
- Before performing work spread cushioning over the base area to lay the TV on. This will prevent it from being damaged.

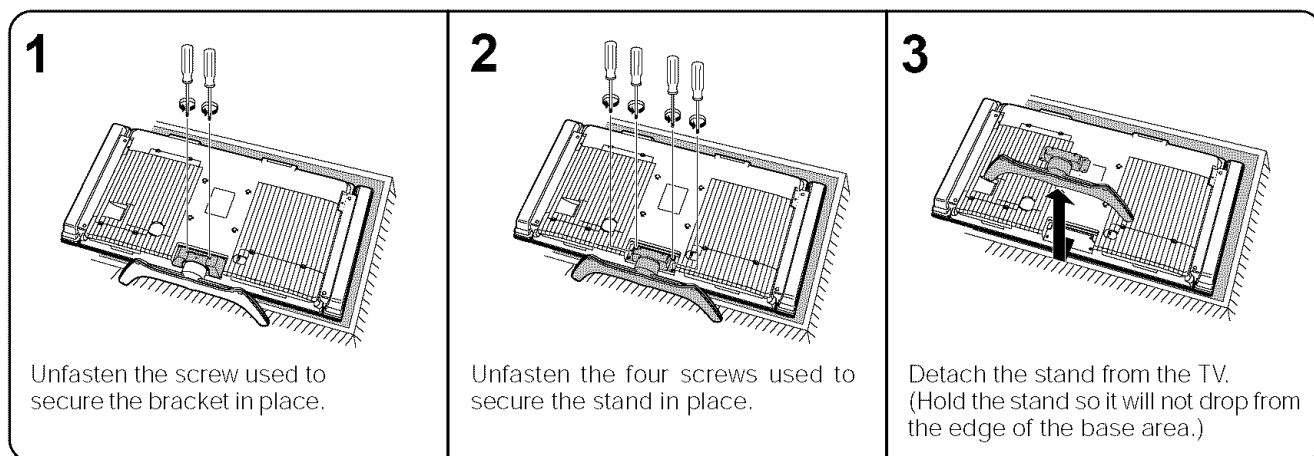

CAUTION

- Do not remove the stand from the TV unless using an optional bracket to mount it.

NOTE

- To attach the stand, perform the above steps in reverse order.

Setting the TV on the wall

CAUTION

- Installing the Liquid Crystal Television requires special skill that should only be performed by qualified service personnel. Customers should not attempt to do the work themselves. SHARP bears no responsibility for improper mounting or mounting that results in accident or injury.

Using an optional bracket to mount the TV

- You can ask a qualified service professional about using an optional bracket to mount the TV to the wall.
- Carefully read the instructions that come with the bracket before beginning work.

Hanging on the wall

Wall mount bracket. (See the bracket instructions for details.)

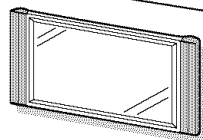

Vertical mounting

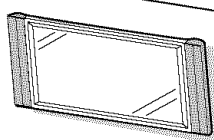

Angular mounting

Troubleshooting

Problem	Possible Solution
<ul style="list-style-type: none"> No power 	<ul style="list-style-type: none"> Check if you pressed TV POWER on the remote control unit. (See page 18.) If the indicator on the TV is off, press POWER on the TV. Is the AC cord disconnected? (See page 6.)
<ul style="list-style-type: none"> Unit cannot be operated. 	<ul style="list-style-type: none"> External influences such as lightning, static electricity, may cause improper operation. In this case, operate the unit after first turning on the power of the TV or unplugging the AC cord and replugging it in after 1 or 2 minutes.
<ul style="list-style-type: none"> Remote control unit does not operate. 	<ul style="list-style-type: none"> Is the FUNCTION set correctly? Set it to the TV setting position. Are batteries inserted with polarity (+, -) aligned? (See page 8.) Are batteries worn out? (Replace with new batteries.) Are you using it under strong or fluorescent lighting? Is a fluorescent light illuminated near the remote control sensor?
<ul style="list-style-type: none"> Picture is cut off/with sidebar screen. 	<ul style="list-style-type: none"> Is the image position correct? (See page 59.) Are screen mode adjustments such as picture size made correctly? (See pages 63 and 64)
<ul style="list-style-type: none"> Strange color, light color, or color misalignment 	<ul style="list-style-type: none"> Adjust the picture tone. (See pages 41 to 42.) Is the room too bright? The picture may look dark in a room that is too bright. Check the input signal setting. (See page 61.)
<ul style="list-style-type: none"> Power is suddenly turned off. 	<ul style="list-style-type: none"> Is the sleep timer set? (See page 66.) Check the power control settings. (See page 45.) The unit's internal temperature has increased. Remove any objects blocking vent or clean the vent.
<ul style="list-style-type: none"> No picture 	<ul style="list-style-type: none"> Is connection to other components correct? (See pages 48 to 53.) Is correct input signal source selected after connection? (See page 61.) Is the correct input selected? (See page 61.) Is a non-compatible signal being input? (See page 83.) Is picture adjustment correct? (See pages 41 to 43.) Is "On" selected in "Audio Only"? (See page 65.) If, after inserting the CableCARD security module, you are unable to receive broadcast service, remove the CableCARD security module and reinsert.
<ul style="list-style-type: none"> No sound 	<ul style="list-style-type: none"> Is the volume too low? (See page 34.) Is "Variable" selected in "Output Select"? (See page 66.)
<ul style="list-style-type: none"> Upgrade is displayed continuously. 	<ul style="list-style-type: none"> Verify your antenna cable is connected property. Reinsert the CableCARD security module. If the trouble still exists after reinserting the CableCARD security module and verifying the antenna cable, please contact your Cable Provider Company.

Cautions regarding use in high and low temperature environments

- When the unit is used in a low temperature space (e.g. room, office), the picture may leave trails or appear slightly delayed. This is not a malfunction, and the unit will recover when the temperature returns to normal.
 - Do not leave the unit in a hot or cold location. Also, do not leave the unit in a location exposed to direct sunlight or near a heater, as this may cause the cabinet to deform and the Liquid Crystal panel to malfunction.
- Storage temperature: -4°F to +140°F (-20°C to +60°C)

Troubleshooting-TV Guide On Screen

Problem	Possible Solution
<ul style="list-style-type: none"> • LISTINGS disappeared after a power failure. 	<ul style="list-style-type: none"> • You should begin to receive listings again within 24 hours.
<ul style="list-style-type: none"> • Some channel numbers in the TV Guide On Screen are incorrect. 	<ul style="list-style-type: none"> • You can correct them using "Changing channel display" under SETUP.
<ul style="list-style-type: none"> • You have not received any local program listings. 	<p>Listings usually appear within 24 hours after a successful Setup.</p> <ul style="list-style-type: none"> • Check the connections between the TV, cable, antenna, and the G-LINK cable if using a cable box. • Verify Setup information under "Changing system settings". • Make sure the cable box is on, if applicable. • Review step 3 and step 4 of "Basic Initial Setup" on page 22.
<ul style="list-style-type: none"> • A program you set to record did not record. 	<ul style="list-style-type: none"> • Make sure your recorder is turned off before the recording begins. • Make sure there is free space available for recording on the tape or recording device. • Check the SCHEDULE menu and verify that the program is listed, before recording begins. • Check the placement of the G-LINK cable in front of your recorder.
<ul style="list-style-type: none"> • The TV did not tune to a program you scheduled with the reminder feature. 	<ul style="list-style-type: none"> • Check the SCHEDULE menu and verify that the program is listed. • If you have a cable box, check the G-LINK cable.
<ul style="list-style-type: none"> • You set a program to "auto tune TV" and it did not. 	<ul style="list-style-type: none"> • Check the SCHEDULE menu and verify that the program is listed as a Reminder. • Highlight the program under LISTINGS and do the following: <ul style="list-style-type: none"> - Press MENU on the remote control. - Use ▼ to highlight "edit reminder", and press ENTER. - Verify that the "auto tune TV" option reads "yes". • The TV must be on at the scheduled time for "auto tune TV".
<ul style="list-style-type: none"> • You set a program with the "power on TV" option and it did not. 	<ul style="list-style-type: none"> • Check the SCHEDULE menu and verify that the program is listed as a Reminder. • Highlight the program under LISTINGS and do the following: <ul style="list-style-type: none"> - Press MENU on the remote control. - Use ▼ to highlight "edit reminder", and press ENTER. - Verify that the "power on TV" option reads "yes". • The TV must be off at the scheduled time for "power on TV".

Troubleshooting-Digital broadcasting

- The error message about reception of broadcast

The example of an error message displayed on a screen	Error code	Possible Solution
<ul style="list-style-type: none"> Failed to receive broadcast. 	E202	<ul style="list-style-type: none"> Check the antenna cable. Check that the antenna is correctly setup.
<ul style="list-style-type: none"> No broadcast now. 	E203	<ul style="list-style-type: none"> Check the broadcast time in the program guide.

- The cautions about i.LINK

Caution sentence	Possible Solution
<ul style="list-style-type: none"> Record/Playback may fail on the selected model. 	<ul style="list-style-type: none"> Displayed when you have selected a device that is not compatible with the TV, or that does not have DTLA copy protection technology installed.
<ul style="list-style-type: none"> Wrong connection or no i.LINK connection was found. Refer to Operation Manual on connection. 	<ul style="list-style-type: none"> Displayed when a problem is experienced with a connection using i.LINK cable. Check the connection, and re-connect the cable if necessary.
<ul style="list-style-type: none"> The selected model is disabled to record/play. Check that no other model is used. 	<ul style="list-style-type: none"> Displayed when the device you have selected is already being used by another i.LINK connected device. To operate the selected device from the TV, you will first have to override control from the other device.

PC compatibility chart

PC/MAC	Resolution	Horizontal Frequency	Vertical Frequency	VESA Standard	
PC	VGA	640 x 400	31.5 kHz	60 Hz	
			37.9 kHz	85 Hz	○
		720 x 400	31.5 kHz	60 Hz	
			37.9 kHz	85 Hz	○
		640 x 480	31.5 kHz	60 Hz	○
			37.9 kHz	72 Hz	○
	37.5 kHz		75 Hz	○	
	WVGA	848 x 480	43.3 kHz	85 Hz	○
			31.5 kHz	60 Hz	
			35.1 kHz	56 Hz	○
	SVGA	800 x 600	37.9 kHz	60 Hz	○
			48.1 kHz	72 Hz	○
			46.9 kHz	75 Hz	○
			53.7 kHz	85 Hz	○
			48.4 kHz	60 Hz	○
	XGA	1024 x 768	56.5 kHz	70 Hz	○
			60.0 kHz	75 Hz	○
68.7 kHz			85 Hz	○	
WXGA	1280 x 720	45.0 kHz	60 Hz		
	1280 x 768	48.1 kHz	60 Hz		
SXGA	1280 x 1024	64.0 kHz	60 Hz	○	
MAC13"	VGA	640 x 480	34.9 kHz	67 Hz	
MAC16"	SVGA	832 x 624	49.7 kHz	75 Hz	
MAC19"	XGA	1024 x 768	60.2 kHz	75 Hz	

Apple and Macintosh are registered trademarks of Apple Computer, Inc.
 DDC is a registered trademark of Video Electronics Standards Association.
 Power Management is a registered trademark of Sun Microsystems, Inc.
 VGA and XGA are registered trademarks of International Business Machines Co., Inc.

RS-232C port specifications

PC Control of the TV

- When a program is set, the TV can be controlled from the PC using the RS-232C terminal. The input signal (PC/AV) can be selected, the volume can be adjusted and various other adjustments and settings can be made, enabling automatic programmed playing.
- Attach an RS-232C cable cross-type (commercially available) to the supplied Din/D-Sub RS-232C for the connections.

NOTE

- This operation system should be used by a person who is accustomed to using computers.

Communication conditions

Set the RS-232C communications settings on the PC to match the TV's communications conditions. The TV's communications settings are as follows:

Baud rate:	9,600 bps
Data length:	8 bits
Parity bit:	None
Stop bit:	1 bit
Flow control:	None

Communication procedure

Send the control commands from the PC via the RS-232C connector. The TV operates according to the received command and sends a response message to the PC. Do not send multiple commands at the same time. Wait until the PC receives the OK response before sending the next command.

Command format

Eight ASCII codes + CR

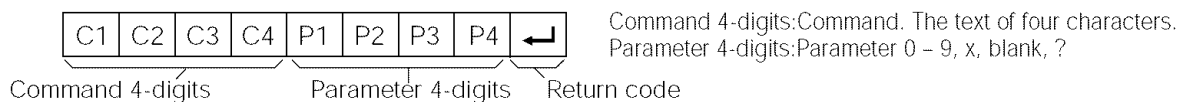

Parameter

Input the parameter values, aligning left, and fill with blank(s) for the remainder. (Be sure that 4 values are input for the parameter.)

When the input parameter is not within an adjustable range, "ERR" returns. (Refer to "Response code format".) Any numerical value can replace the "x" on the table.

0			
0	0	0	9
-	3	0	
1	0	0	
0	0	5	5

When "?" is input for some commands, the present setting value responds.

?			
?	?	?	?

Appendix

Response code format

Normal response

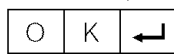

Return code (0DH)

Problem response (communication error or incorrect command)

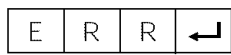

Return code (0DH)

Command table

- Commands not indicated here are not guaranteed to operate.

CONTROL ITEM		COMMAND	PARAMETER	CONTROL CONTENTS
POWER SETTING		P O W E R	0 _ _ _	It shifts to standby.
INPUT SELECTION A	TOGGLE	I T G D	x _ _ _	(Toggle)
	TV	I T V D	x _ _ _	It input-switches to TV. (A channel remains as it is. (Last memory))
	INPUT1-5	I A V D	* _ _ _	Input terminal number (1-5)
	I.LINK	L I N K	x _ _ _	It input-switches to I.LINK.
INPUT SELECTION B	INPUT 1	I N P 1	0 _ _ _	AUTO
			1 _ _ _	VIDEO
			2 _ _ _	COMPONENT
	INPUT 2	I N P 2	0 _ _ _	AUTO
			1 _ _ _	VIDEO
			2 _ _ _	COMPONENT
	INPUT 5	I N P 5	5 _ _ _	DIGITAL PC
			6 _ _ _	ANALOG PC
			7 _ _ _	DIGITAL AV
8 _ _ _			ANALOG AV	
AV MODE SELECTION		A V M D	0 _ _ _	(Toggle)
			1 _ _ _	STANDARD
			2 _ _ _	MOVIE
			3 _ _ _	GAME
			4 _ _ _	USER
			5 _ _ _	DYNAMIC (Fixed)
			6 _ _ _	DYNAMIC
VOLUME		V O L M	* * _ _	Volume (0-60)
POSITION	H-POSITION	H P O S	* * * _	AV mode. (± 10)
			* * * _	INPUT5: AV mode. (± 90)
			* * * _	PC mode. (0-180)
	V-POSITION	V P O S	* * * _	AV mode. (± 20)
			* * * _	INPUT5: AV mode. (± 50)
CLOCK	C L C K	* * * _	Only PC mode. (0-180)	
PHASE	P H S E	* * * _	Only PC mode. (0-40)	
VIEWMODE		W I D E	0 _ _ _	(Toggle) [AV]
			1 _ _ _	Side Bar [AV]
			2 _ _ _	S.Stretch [AV]
			3 _ _ _	Zoom [AV]
			4 _ _ _	Stretch [AV]
			5 _ _ _	Normal [PC]
			6 _ _ _	Zoom [PC]
			7 _ _ _	Stretch [PC]
			8 _ _ _	Dot by Dot [PC]
MUTE		M U T E	0 _ _ _	(Toggle)
			1 _ _ _	On
			2 _ _ _	Off
Dolby Virtual		A C D V	0 _ _ _	(Toggle)
			1 _ _ _	On
			2 _ _ _	Off
AUDIO SELECTION		A C H A	x _ _ _	(Toggle)
SLEEP TIMER		O F T M	0 _ _ _	OFF
			1 _ _ _	OFF TIMER - 30 MIN.
			2 _ _ _	OFF TIMER - 60 MIN.
			3 _ _ _	OFF TIMER - 90 MIN.
			4 _ _ _	OFF TIMER - 120 MIN.
CHANNEL	DIRECT CHANNEL (ANALOG)	D C C H	* * * _	The channel number of TV (1-125) In Air, 2-69ch is effective.
	DIRECT CHANNEL (DIGITAL)	D C 2 U	* * * _	(0101-9999) DIGITAL Air (Two-Part numbers, 2-digit plus 2-digit)
			* * * _	(0-999) DIGITAL Cable (Two-Part numbers, 3-digit plus 3-digit)
			* * _ _	(0-999) DIGITAL Cable (Two-Part numbers, 3-digit plus 3-digit)
			* * * _	(0-9999) Rear half of DIGITAL CABLE CHANNEL NO. (Designate minor channel)
			* * * _	(0-6383) DIGITAL Cable (One-Part numbers, 5-digit, more than 10,000)
	CH UP	C H U P	x _ _ _	The channel number of TV + 1 If it is not TV display, it will input-switch to TV. (same function as CH▲)
CH DOWN	C H D W	x _ _ _	The channel number of TV - 1 If it is not TV display, it will input-switch to TV. (same function as CH▼)	
Air/Cable SELECT		A C S L	0 _ _ _	(Toggle)
			1 _ _ _	AIR
			2 _ _ _	CABLE
CC		C L C P	x _ _ _	(Toggle)
				Toggle operation of a closed caption.

NOTE

- If an underbar (_) appears in the parameter column, enter a space.
- If an asterisk (*) appears, enter a value in the range indicated in brackets under CONTROL CONTENTS.
- As long as that from which the parameter (x) in the table is a numerical value, it may write anything.

Appendix

Specifications

Item		Model: LC-45GD5U	
LCD panel		45" Advanced Super View & BLACK TFT LCD	
Number of dots		6,220,800 dots (1920 × 1080 × 3 dots)	
TV Function	TV-standard (CCIR)	American TV Standard ATSC/NTSC System	
	Receiving Channel	VHF/UHF	VHF 2-13ch, UHF 14-69ch
		CATV	1-125ch
		Digital Terrestrial Broadcast (8VSB)	2-69ch
		Digital cable (64/256 QAM)	1-135ch
Audio multiplex	BTSC System		
Brightness		450 cd/m ²	
Backlight Life		60,000 hours (at Backlight Standard position)	
Viewing angles		H : 170° V : 170°	
Audio out		10W × 2	
Terminals	Rear	INPUT 1	AV in, COMPONENT in
		INPUT 2	AV in, COMPONENT in
		INPUT 3	S-VIDEO in, AV in
		INPUT 4	HDMI in with HDCP
		INPUT 5	Audio in, DVI-I in with HDCP
		ANALOG ANTENNA	75 Ω Unbalance, F Type for VHF/UHF/CATV in × 1
		DIGITAL ANTENNA	75 Ω Unbalance, F Type × 2 (for Digital Air × 1/Digital Cable in × 1)
		MONITOR/REC OUT	S-VIDEO out, AV out
		G-LINK	Ø 3.5mm jack
		DIGITAL AUDIO OUTPUT	Optical Digital audio output × 1 (PCM/Dolby Digital)
		i.LINK	IEEE1394 × 2 with DTCP
		CableCARD slot	68 pin PCMCIA × 1
	Front	Headphones	Ø 3.5mm jack
OSD language		English/French/Spanish	
Power Requirement		AC 120 V, 60 Hz	
Power Consumption		300 W	
Weight	TV only	60.6 lbs./27.5 kg	
	TV with speaker	69.4 lbs./31.5 kg	
	TV with speaker and stand	78.3 lbs./35.5 kg	
Dimension (W × H × D) (in inches)		49 ²¹ / ₆₄ × 28 ⁴⁵ / ₆₄ × 11 ³¹ / ₃₂ (TV + stand + speaker)	
		43 ⁹ / ₆₄ × 28 ⁴⁵ / ₆₄ × 11 ³¹ / ₃₂ (TV + stand)	
		49 ²¹ / ₆₄ × 25 ²⁵ / ₃₂ × 4 ³¹ / ₆₄ (TV+ speaker)	
		43 ⁹ / ₆₄ × 25 ²⁵ / ₃₂ × 4 ³¹ / ₆₄ (TV only)	
Accessories		Operation manual (× 1), Remote control unit (× 1), AC cord (× 1), "AAA" size battery (× 2), Cable clamp (× 1), G-LINK cable (× 1), Cable tie (× 1), Speaker Unit (× 2)	
Operating temperature		+ 32°F to + 104°F (0°C to + 40°C)	

- As part of policy of continuous improvement, SHARP reserves the right to make design and specification changes for product improvement without prior notice. The performance specification figures indicated are nominal values of production units. There may be some deviations from these values in individual units.

Dimensional drawings

Unit: inch/(mm)

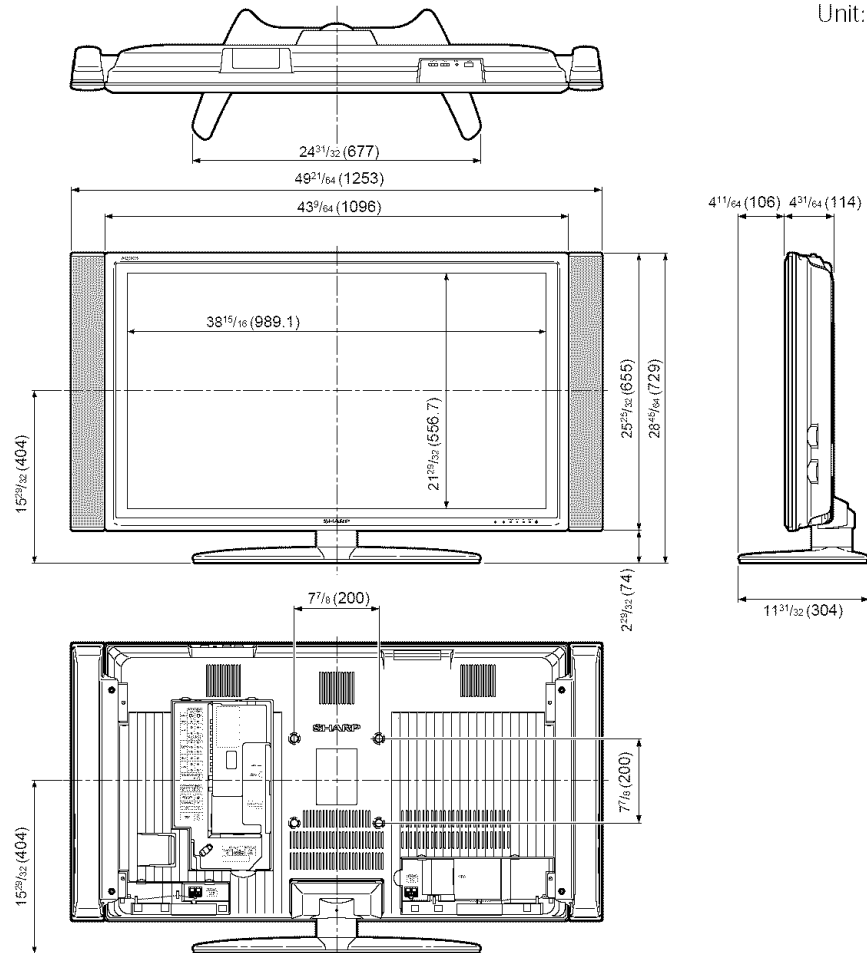

HOW TO SET THE FACTORY PRESETS

Check that the power indicator is not on.

Remove the AC cord and switch off the power.

Press and hold down **RESET** at the same time as you re-insert the AC Cord into the outlet and switch on the TV.

All setting items (except TV channel) return to the factory presetting.

NOTE

- Running the factory presetting operation also clears the secret number.

You can run the EZ Setup again by using the following steps.

- 1 Turn on the power of the TV.
- 2 Press **MENU**. (Make sure the menu screen displays.)
- 3 Press **◀/▶** to select "Setup".
- 4 Press **▲/▼** to select "EZ Setup".
- 5 Press **ENTER**.

NOTE

- If the secret number setting screen displays, you need to enter your secret number.
- If you forget your secret number, refer to HOW TO SET THE FACTORY PRESETS above.

The secret number is

--	--	--	--

NOTE

- As a precautionary measure, make a note of your secret number above, scissor it from this manual, and keep it in a familiar place.

Calling for Service

For location of the nearest Sharp Authorized Service, or to obtain product literature, accessories, supplies, or customer assistance, please call 1-800-BE-SHARP.

LIMITED WARRANTY

CONSUMER LIMITED WARRANTY

SHARP ELECTRONICS CORPORATION warrants to the first consumer purchaser that this Sharp brand product (the "Product"), when shipped in its original container, will be free from defective workmanship and materials, and agrees that it will, at its option, either repair the defect or replace the defective Product or part thereof with a new or remanufactured equivalent at no charge to the purchaser for parts or labor for the period(s) set forth below.

This warranty does not apply to any appearance items of the Product nor to the additional excluded item(s) set forth below nor to any Product the exterior of which has been damaged or defaced, which has been subjected to improper voltage or other misuse, abnormal service or handling, or which has been altered or modified in design or construction.

In order to enforce the rights under this limited warranty, the purchaser should follow the steps set forth below and provide proof of purchase to the servicer.

The limited warranty described herein is in addition to whatever implied warranties may be granted to purchasers by law. ALL IMPLIED WARRANTIES INCLUDING THE WARRANTIES OF MERCHANTABILITY AND FITNESS FOR USE ARE LIMITED TO THE PERIOD(S) FROM THE DATE OF PURCHASE SET FORTH BELOW. Some states do not allow limitations on how long an implied warranty lasts, so the above limitation may not apply to you.

Neither the sales personnel of the seller nor any other person is authorized to make any warranties other than those described herein, or to extend the duration of any warranties beyond the time period described herein on behalf of Sharp.

The warranties described herein shall be the sole and exclusive warranties granted by Sharp and shall be the sole and exclusive remedy available to the purchaser. Correction of defects, in the manner and for the period of time described herein, shall constitute complete fulfillment of all liabilities and responsibilities of Sharp to the purchaser with respect to the Product, and shall constitute full satisfaction of all claims, whether based on contract, negligence, strict liability or otherwise. In no event shall Sharp be liable, or in any way responsible, for any damages or defects in the Product which were caused by repairs or attempted repairs performed by anyone other than an authorized servicer. Nor shall Sharp be liable or in any way responsible for any incidental or consequential economic or property damage. Some states do not allow the exclusion of incidental or consequential damages, so the above exclusion may not apply to you.

THIS WARRANTY GIVES YOU SPECIFIC LEGAL RIGHTS. YOU MAY ALSO HAVE OTHER RIGHTS WHICH VARY FROM STATE TO STATE.

Model Specific Section

Your Product Model Number & Description:	LC-45GD5U Color Television (Be sure to have this information available when you need service for your Product.)
Warranty Period for this Product:	One (1) year parts and labor from the date of purchase.
Additional Item(s) Excluded from Warranty Coverage (if any):	Non-rechargeable batteries.
Where to Obtain Service:	From a Sharp Authorized Servicer located in the United States. To find the location of the nearest Sharp Authorized Servicer, call Sharp toll free at 1-800-BE-SHARP.
What to do to Obtain Service:	Contact your Sharp Authorized Servicer to obtain in-home service for this Product. The Servicer will come to your home and if it is necessary to remove the Product, the Servicer will reinstall it. Be sure to have Proof of Purchase available.

TO OBTAIN PRODUCT INFORMATION, CALL 1-800-BE-SHARP OR VISIT www.sharpusa.com

SHARP®

SHARP ELECTRONICS CORPORATION

Sharp Plaza, Mahwah, New Jersey 07430-2135

SHARP CORPORATION

SHARP®

LIMITED WARRANTY

Consumer Electronics Products

Congratulations on your purchase!

Sharp Electronics of Canada Ltd. (hereinafter called "Sharp") gives the following express warranty to the first consumer purchaser for this Sharp brand product, when shipped in its original container and sold or distributed in Canada by Sharp or by an Authorized Sharp Dealer:

Sharp warrants that this product is free, under normal use and maintenance, from any defects in material and workmanship. If any such defects should be found in this product within the applicable warranty period, Sharp shall, at its option, repair or replace the product as specified herein.

This warranty shall not apply to:

- (a) Any defects caused or repairs required as a result of abusive operation, negligence, accident, improper installation or inappropriate use as outlined in the owner's manual.
- (b) Any Sharp product tampered with, modified, adjusted or repaired by any party other than Sharp, Sharp's Authorized Service Centres or Sharp's Authorized Servicing Dealers.
- (c) Damage caused or repairs required as a result of the use with items not specified or approved by Sharp, including but not limited to head cleaning tapes and chemical cleaning agents.
- (d) Any replacement of accessories, glassware, consumable or peripheral items required through normal use of the product including but not limited to earphones, remote controls, AC adapters, batteries, temperature probe, stylus, trays, filters, belts, ribbons, cables and paper.
- (e) Any cosmetic damage to the surface or exterior that has been defaced or caused by normal wear and tear.
- (f) Any damage caused by external or environmental conditions, including but not limited to transmission line/power line voltage or liquid spillage.
- (g) Any product received without appropriate model, serial number and CSA/cUL markings.
- (h) Any products used for rental or commercial purposes.
- (i) Any installation, setup and/or programming charges.

Should this Sharp product fail to operate during the warranty period, warranty service may be obtained upon delivery of the Sharp product together with proof of purchase and a copy of this LIMITED WARRANTY statement to an Authorized Sharp Service Centre or an Authorized Sharp Servicing Dealer. In home warranty service may be provided at Sharp's discretion on any Sharp television with the screen size of 27" or larger and on any Sharp Over-the-Range Microwave Oven.

This warranty constitutes the entire express warranty granted by Sharp and no other dealer, service centre or their agent or employee is authorized to extend, enlarge or transfer this warranty on behalf of Sharp. To the extent the law permits, Sharp disclaims any and all liability for direct or indirect damages or losses or for any incidental, special or consequential damages or loss of profits resulting from a defect in material or workmanship relating to the product, including damages for the loss of time or use of this Sharp product or the loss of information. The purchaser will be responsible for any removal, reinstallation, transportation and insurance costs incurred. Correction of defects, in the manner and period of time described herein, constitute complete fulfillment of all obligations and responsibilities of Sharp to the purchaser with respect to the product and shall constitute full satisfaction of all claims, whether based on contract, negligence, strict liability or otherwise.

WARRANTY PERIODS:

	Parts & Labour (exceptions noted)
Audio Products	1 year
Camcorder	1 year
DVD Products	1 year
Projector	1 year (lamp 90 days)
LCD & Plasma Display TV	1 year
Microwave Oven	1 year (magnetron component-4 additional years)
Television Products	1 year (picture tube component-1 additional year)
VCR Products	1 year
Vacuum Cleaner	1 year

To obtain the name and address of the nearest Authorized Sharp Service Centre or Dealer, please contact:
SHARP ELECTRONICS OF CANADA LTD. 335 Britannia Road East, Mississauga, Ontario L4Z 1W9

For more information on this Warranty, Sharp Extended Warranty Offers, Sharp Canada Products, Accessory Sales, Dealer or Service Locations, please call (905) 568-7140
Visit our Web site: www.sharp.ca

