

Use and Care Guide

WASHER DRYER COMBO
COMBINADA LAVADORA SECADORA
COMBINE LAVE-LINGE/SECHE-LINGE

Contents

Appliance Registration	2	Care & Cleaning	14
Model and Serial Numbers	2	Vacation & Winter Storage	15
Safety Instructions	3	Safety Features	16
Installation Instructions	4~7	Fabric Care Symbols	17~18
Water and Electrical Requirements	8	Troubleshooting Guide	19~21
Operating Guide	9~10	Warranty	Backcover
Cycle Selection	11~12	Supra Appliances Call Center	
Detergent Guide	13	For service call: 1.877.447.8772	

Model SW5L30D

A 110 Volt Product

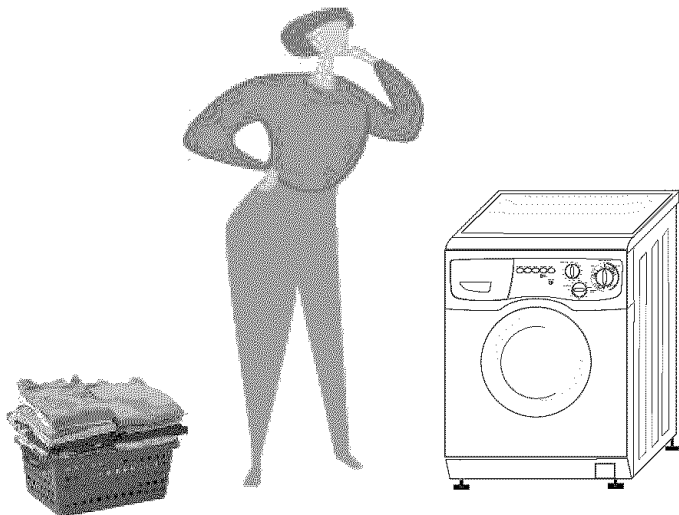

461305597

CENELEC
UL HARMONIZED

Help us Help You...

Before using your washer dryer read this book carefully.

It is intended to help you properly operate and maintain your new washer dryer.

Keep it handy for answers to your questions. If you don't understand something or need technical assistance, please contact:
Technical Service and Support

101 3rd Street
Kentwood, LA 70444
Phone: 1.877.447.8772

Write down the model and serial numbers

You will find them on a label fastened at the rear of the unit. Before using your washer dryer please write these numbers here.

Model Number

Serial Number

If you received a damaged washer dryer

Immediately contact the delivery company, dealer or the builder from which the unit was purchased. Damage is not covered under the manufacturers warranty.

Save Time and Money Before you request service

Check the trouble shooting guide (Pages 19 to 21). It lists causes of minor operating problems that you can correct yourself.

Energy - Saving Tips

The power and water consumption of your washer dryer can be minimized if you follow these suggestions.

- **Operate washer dryer only in full load**
When you put in a partial cotton load, press the Super Rinse button. This automates the cycle for energy needs.
- **If you don't need pre-wash** avoid using cycle 1.
- **Always select cycle 3** for cotton load and keep temperature at 140.
- **Always soak or treat stains** before the wash.
- **Always select the maximum rpm spin speed** to reduce moisture content.

If you need Service

To obtain service see the consumer services page in the back of this book. We're proud of our service and want you to be pleased. If for some reason you are not happy with the service you receive, here are two steps to follow for further help.

FIRST contact the people who serviced your appliance. Explain why you are not pleased. In most cases, this will solve the problem.

NEXT if you are still not pleased, write down all the details and call 1.877.447.8772. Explain your problem. A customer service representative will assist you.

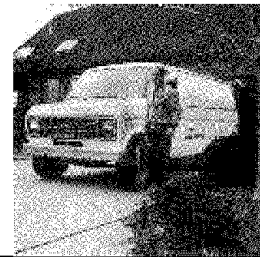

IMPORTANT SAFETY INSTRUCTIONS

Read all instructions before using this appliance.

WARNING -- When using this appliance, always exercise basic safety precautions, including the following:

Use this appliance only for its intended purpose, as you will find described in this Use and Care Guide. This washer dryer must be properly installed and located in accordance with installation instructions before it is used. If you did not receive an installation instruction sheet with this book, please call 1.877.447.8772 to receive assistance in installation.

This appliance must be connected to a grounded metal, permanent wiring system, or an equipment grounding conductor must be run with the circuit conductors and connected to the equipment grounding terminal or lead of the appliance.

Connect to a properly rated protected and sized power supply circuit to avoid electrical overload.

Do not store or use combustible materials, gasoline or other flammable vapors and liquids in the vicinity of this or any other appliance.

Use only detergents recommended for use in a front loading washer.

Do not wash steel, plastic, knives, or other hard or abrasive items, to avoid damage to the drum.

To minimize the possibility of injury

- Do not touch the heating element during or immediately after use.
- Do not abuse or tamper with controls.
- Do not sit on or stand on the top of the appliance.
- Close supervision is necessary if this appliance is used by or near children. Do not allow children to play inside, on or with this appliance. Dispose of discarded appliances and shipping or packing material properly. Before discarding a washer dryer remove the door.
- Keep all washing detergents out of the reach of children, preferably in a locked cabinet. Observe all warnings on container labels to avoid personal injury.
- To minimize the possibility of electric shock, disconnect this appliance from the power supply before attempting any maintenance
- Do not reach into the appliance if the tub or drum is moving.

- Do not install or store this appliance, where it will be exposed to extreme weather
- Do not dry clothing containing rubber, foam rubber or any rubber textured materials.
- Note: Pressing the Power button does not disconnect the appliance from the power supply.
- We recommend having a qualified technician service your appliance.
- Gas is produced by the chemical action within the tub of your washer dryer. It can accumulate in the tub and/or water pipes if hot water is not used for two weeks or longer. Some of these gases may be noxious or even combustible. To prevent the possibility of damage or injury, if you have not used the appliance for two weeks or more, or moved into a residence in which the water pipes may not have been used for sometime, turn on all water faucets and allow them to run for several minutes before using this appliance.



The down lightning flash icon enclosed within a triangle is intended to warn the user that parts used inside this product risk electric shock to persons.



The exclamation icon within the triangle is intended to tell the user that important operating and servicing instructions accompany this product in paper form.



SAVE THESE INSTRUCTIONS

Installation sheet

Tools needed for Installation

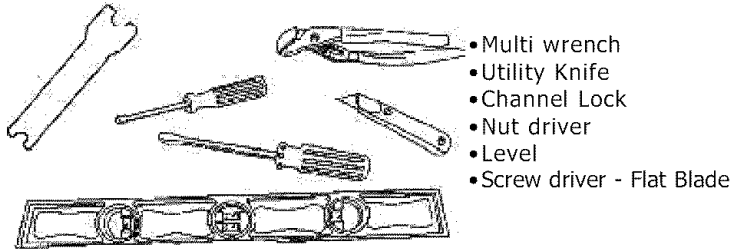

Electrical

Refer to serial plate for specific electrical requirements

Water

Washer Dryer needs one standard 3/4 inch water supply faucet with a pressure between 30 to 120 pounds per square inch

Parts supplied for installation.

Inlet Water Hose - One
Washers - Two

Cabinet Dimensions

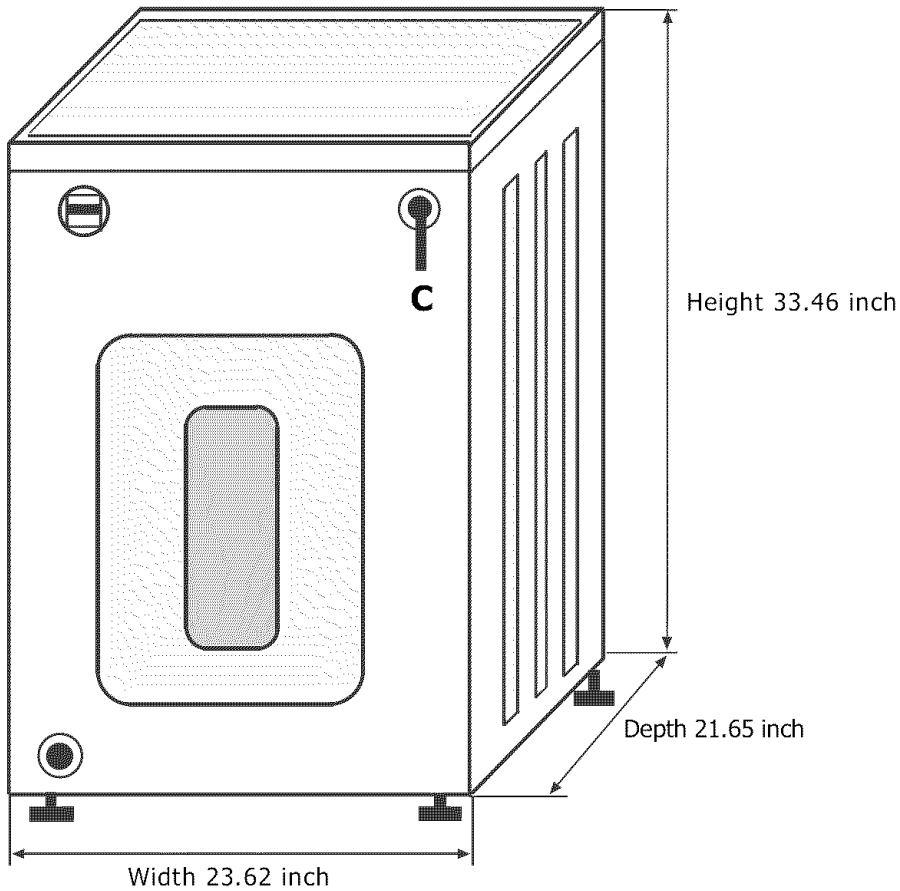

Installation sheet

Proper installation is extremely important for your washer dryer to function correctly. When you first receive your washer dryer remove the box and packing material from the unit and inspect it carefully. If you find damage, immediately contact the delivery company and the company from which the unit was purchased.

STEP 1 PREPARE WASHER DRYER

1. Carefully remove the box and packaging materials from the outside of the washer dryer.
2. The drain hose and the power cord are secured on the back of the unit. Please unstrap them.
3. Unscrew and remove the four shipping bolts from the back of the washer dryer. Remove the four spacers that the bolts were attached to as well. Store these in a safe place in case you need to move the washer dryer in the future.
4. Loosen the two front adjustable legs and lock nuts. Install the included vinyl feet under all four legs.

STEP 2 INSTALL WASHER DRYER

1. Place the drain hose in the drain. Do not allow the hose to kink or get damaged. Prevent hose from collapsing or becoming damaged.
2. Do not install the drain hose into the drain in an air-tight connection; ensure there is some airflow possible.
3. For best performance the drain hose should not be restricted in any way.
4. The drain stand pipe should be not be higher than 2.6 ft and not lower than 1.64 ft.
5. Caution must be exercised to avoid collapsing or damaging the drain hose.
6. Strap the drain hose to the stand pipe.
7. Thread the inlet water hose to your cold water faucet connection. Tighten by hand until snug. Turn an additional 2/3rd turn by pliers.
8. Do not **OVERTIGHTEN**. Make sure the water line connection into the back of the unit is secure.
9. Turn on the cold water supply. Check all connections for leaks.
10. Plug the power cord into a grounded 110V, 60Hz approved electrical service protected by a 10 amp fuse or a comparable circuit breaker. The washer dryer is grounded through the third and fourth prong G & W (refer to page 7.).
11. Slide washer dryer into position. Make sure the drain hose remains routed straight through the clip without collapsing or kinking.
12. Level washer dryer by turning the leveling legs in or out as necessary.
13. Tighten leg lock nuts.
14. The washer dryer must be level on four sides. To properly level use a carpenters level. It is always a good idea to check for level again after the first few washes and re-level if necessary.

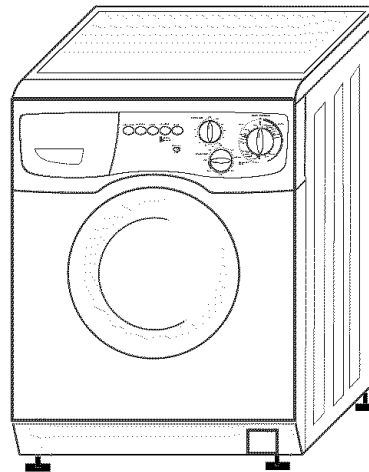

Installation Sheet

STEP 3

Final Installation Check List

1. Instructions and other items have been removed from the tub.
- 2. Shipping bolts have been removed.**
3. Washer dryer is plugged in to an electric outlet and is properly grounded.
4. Water hose is connected to the faucet with inlet screens and washers.
5. Water is turned on and checked for leaks at faucet and machine end connections.
6. Drain hose is properly located into drain facility and is not collapsed or damaged.
7. Washer dryer has been properly levelled, all legs firmly on the floor and lock nuts engaged.
8. Water fills properly.
9. Test for proper operation by running the washer dryer through a complete cycle.

SW5L30D Test Run

1. Prepare your laundry
2. Select fabric type and Wash cycle Program. Refer to fabric care label for instructions.
3. Load cotton laundry into the drum. Load no more than 6 lbs. of laundry. Do not over load. (Load unit approximately 2/3 visually full with similar fabrics).
4. Load detergent in dispenser 2 for main wash. Follow detergent guide. Use low sudsing detergent.
5. Turn Wash Program knob to select the desired wash cycle.
6. Press the desired buttons.
7. Press dry time button to start drying.
8. Press Start.
9. Verify washer dryer is filling with water.
10. Verify washer dryer stops filling.
11. Verify drum is turning and the cycle is ON.
12. Verify unit rinses during the rinse cycle.
13. Verify unit spins during spin cycle.
14. Pull on the door to make sure it does not open.
15. Allow the cycle to finish. Release start button to unlock door. (Allow 2-3 minutes for door to unlock).
16. Open door, take out laundry.
17. Verify laundry is clean and dry. Fold and put away.
- 18. Repeat 1 to 8 for a second cotton load of 6 lbs.** Do not overload.
19. Press Antiwrinkle button.
20. Press Start.
21. Check if your clothes are wrinkle free.

Make any corrections necessary to properly complete the installation. If in doubt, call tollfree 1.877.4470.8772 for guidance on installation issues.

WARNING

Proper installation is the responsibility of the owner. Service performed as a result of improper setup, adjustment or connection are the responsibility of the installer.

Installation sheet

Shipping Bolts

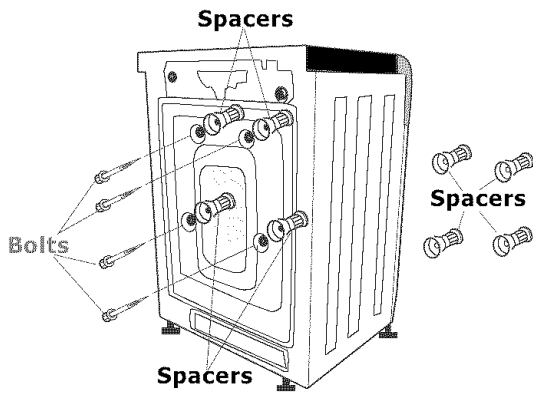

Plumbing

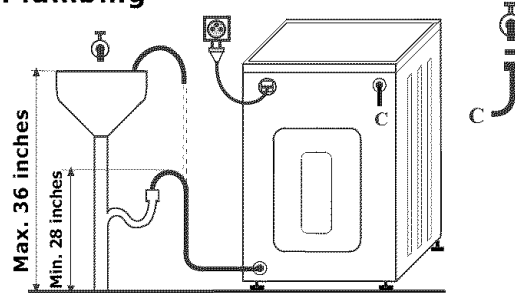

Leveling

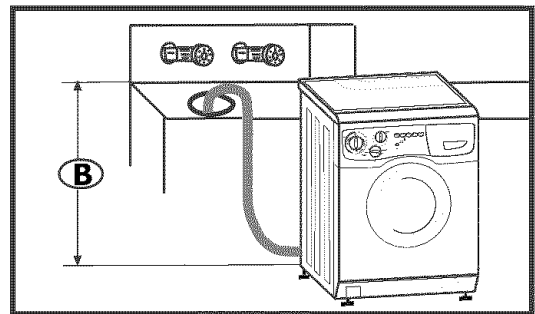
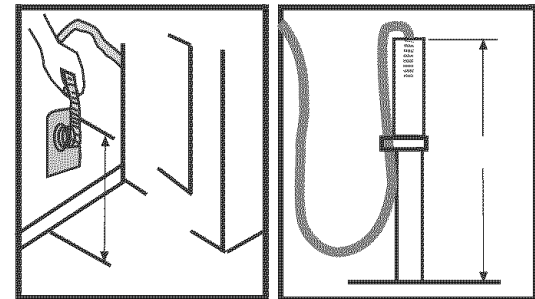
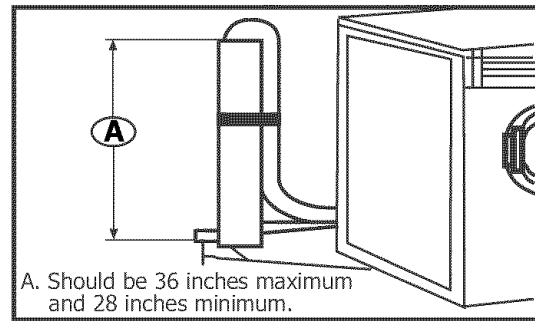
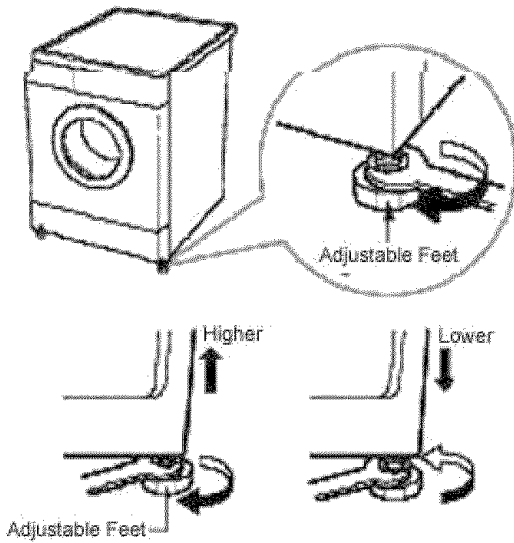

Plug and Wall Receptacle

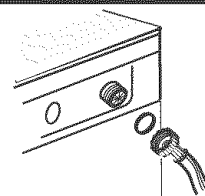
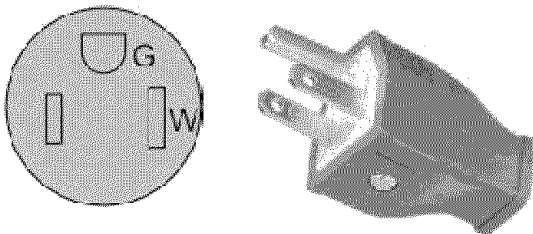

Water and Electrical Requirements

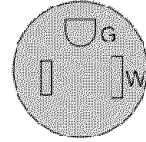

Electrical

110V, 60Hz 16 Amp fuse or circuit breaker

We recommend a dedicated circuit meant only for the washer dryer.

The washer dryer is equipped with a power cord and a three prong NEMA 5-20P plug.

Never use an Extension cord.

An electrical ground is required on this appliance. This unit is equipped with a four prong grounding plug for use in a properly installed and grounded outlet.

Warning

Improper connection of the equipment grounding conductor can result in a risk of electric shock. Check with a qualified electrician or servicer if you are in doubt on grounding the appliance. Do not modify the plug provided with this appliance. Have a qualified electrician install the plug into the wall receptacle if the plug does not fit the outlet. To prevent risk or fire, electric shock or personal injury all wiring and grounding must be done in accordance with National Electrical Code, local codes and ordinances. The owner of the appliance is responsible for providing adequate electrical service for this appliance.

Water

Water pressure of 30 to 120 p.s.i. is required to correctly fill the washer dryer. Pressure of less than 30 p.s.i. may cause a failure in the water valve or extended fill time. The inlet valve system may not shut off correctly. To avoid the possibility of water damage should a hose leak, always have faucets accessible. Turn off faucet when washer dryer is not in use.

Drain Facility

We recommend the height of the standpipe to be not higher than 2.63ft and not lower than 1.64 ft. Make sure the drain facility is capable of accepting the drain hose in a secure manner.

Flooring

For best performance the unit must be installed on a solidly constructed floor. Wooden floors need reinforcement to minimize machine vibration. Carpeting and soft tile surfaces are contributing factors in vibration and may cause the washer dryer to move slightly during the spin and dry cycles. Never install the washer dryer on a raised platform or on any weak structure. Proper flooring is the responsibility of the owner.

Location

We recommend the washer dryer not be installed in areas where water may freeze or boil. The washer dryer maintains some amount of water internally at all times in components like the valve, the pump, and in the hose areas. If this water freezes, it can damage belts, the pump, the motor, hoses or other components. Make sure the operating temperature is not below 60 degrees F. Your washer dryer is a ventless system, therefore it can be installed in a closet or in an alcove.

Warning

Your washer dryer is manufactured for operation on 60Hz AC approved electrical service. This model is not designed for use on 50 Hz AC electrical service. We do not recommend conversion.

For Technical Assistance or if your washer dryer requires service, replacement parts or accessories contact Technical Services and Support toll free at 1.877.447.8772.

HOW TO USE YOUR WASHER DRYER

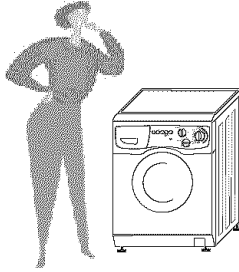

Making It Easy For You

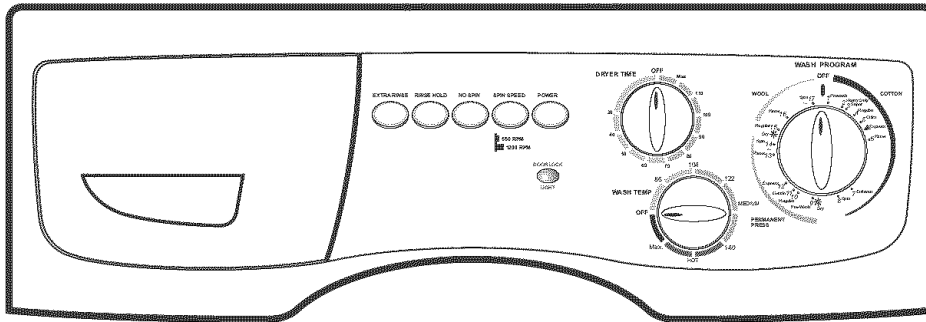
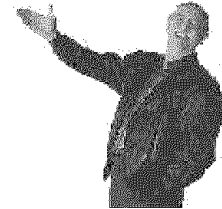

110 V. 60Hz

Wash Program Knob

Use this knob to select wash program of your choices. Always turn knob clockwise. To choose a program align the colored mark on the knob to the program number or text.

Dryer Timer Knob

Allows you to preset drying time. Based on your needs to make your laundry damp dry or bone dry. Refer to Drying table for details. This is a Timer, not a Thermostat.

Wash Temperature Knob

Allows you to choose desired Temperature setting for water during the Wash cycle. Refer to clothing care label for guidance.

Lamp

Lights up when power is turned ON. Goes away when power is turned OFF.

Power Button

Push to turn power ON. Push again to turn OFF. Keep button at OFF position for the door to open at the end of the cycle. Door will not open if this button is kept at ON position.

Door Handle

Use the handle to open and close door. A click sound is heard when door is closed. This activates a safety device that prevents door from opening during wash/dry cycles. Always turn off the appliance, wait for 30 seconds. The warning light must go off before attempting to open door. Do not open the door during Wash or Dry cycles. This could lead to water spills and drum damage.

No Spin Button

Push button to skip spin cycle in Automatic mode, dryer will not turn.

Use this button for delicate fabrics only. Refer clothing label instructions.

Super Rinse Button

Allows you to do a Super Rinse at full load or turns ON the Intelligent recognition system at Half load. Press when your laundry load is 6 lbs or less. The unit will set water level and adjust to the load intelligently. Do not press at full load.

Rinse Hold Button

Allows you to stop the wash cycle during the last rinse with the drum full of water. Use this button for synthetic and wool programs only. Push to activate. Some fabrics need to be drip dried only to prevent creasing. Press again to stop, dryer will not turn ON.

Spin

Push to select 550 rpm. Release to select 1000 rpm.

How To Operate Your Washer Dryer

Good Washing starts with hot water. To get your clothes clean and dry you need hot water. Your washer dryer automatically heats the water in the wash cycle.

AUTOMATIC PROGRAM

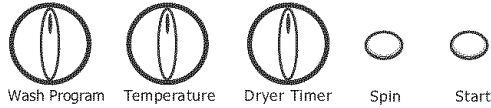

Select fabric type and program. Turn wash program knob to the program number on the dial. Turn temperature knob to select desired heat setting. Turn dryer knob to select time in minutes. Press spin button to select 550 rpm or release for 1000 rpm. Push start button. This program allows wash through dry automatically. When drying is complete drum stops turning. Press stop button, open door and take away laundry. The cool down feature towards the end of drying cycle prevents creases & wrinkles. Choose bone dry settings to fold and put away your clothes. In this program drying capacity must not exceed 6 lbs.

WASH ONLY

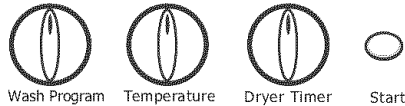

Select fabric type and program. Turn wash program knob to the program number required. Turn temperature number to the desired heat setting. Turn dryer knob to off position. Press start button.

TIME DRY ONLY

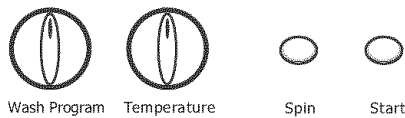

Turn wash program knob to off position. Turn dry knob to select time in minutes. Press spin button to select 550 rpm or release for 1000 rpm. Press start button. Refer drying table to determine the correct time. Always remember that time to dry varies by dampness and fabric type. Your Supra dryer is constructed to deliver bone dry laundry and allow you to fold and put away.

WASH ONLY - NO SPIN

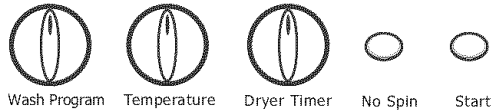

Select fabric type and program. Turn wash program knob to the program number required. Turn temperature number to the desired heat setting. Turn dryer knob to off position. Press No spin button. Press start button. In this program the machine skips spin cycle. It is meant for stopping the machine after rinse and drain. Use this button for delicate fabrics where the clothing label does not recommend spinning. Do not press No spin button in Automatic program, dryer will not turn on.

WASH ONLY - RINSE HOLD

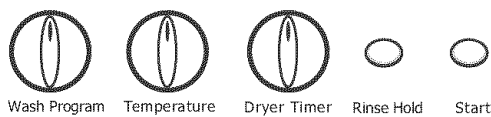

Select fabric type and program. Turn wash program knob to the program number required. Turn temperature number to the desired heat setting. Turn dryer knob to off position. Press Rinse hold button. Press start button. This program is meant for pausing the machine after rinse without draining. In this program the machine stops after the last rinse with drum full of water. Press stop button, open door and take out your laundry. Some fabrics need to be drip dried. Refer clothing label to identify such fabrics. Do not press Rinse hold button in Automatic program, dryer will not turn on.

WASH ONLY - SUPER RINSE

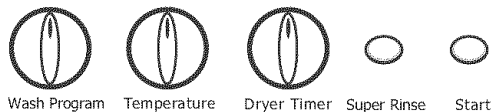

Select fabric type and program. Turn wash program knob to the program number required. Turn temperature number to the desired heat setting. Turn dryer knob to off position. Press Super Rinse button. Press start button. Press stop button at the end of the cycle to remove laundry. In this program the machine runs a super rinse on your laundry. Do not press Super Rinse button in Automatic program, dryer will not turn on.

Wash Cycle Selection

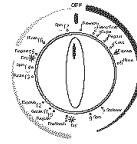

What happens in each cycle?

Wash Cycles	Fabric Type	Temperature °F	Load	Cycle Sequence	Wash Cycle Time Minutes (Approx)	Drying Condition
1 Pre-wash	Cotton Whites	104 140	Wash 12 lbs Dry 6 lbs	Pre-wash, 4 times Wash, 3 Rinses & Spin, 1 Rinse & Spin, Final Spin	155	Select Dry or Damp Dry
2 Heavy Duty	Cotton Very Dirty Whites	140	Wash 12 lbs Dry 6 lbs	4 Times Wash, 3 Rinses & Spin, 1 Rinse & Spin, Final Spin	140	Select Dry or Damp Dry
3 Super	Cotton Jeans	140	Wash 12 lbs Dry 6 lbs	3 Times Wash, 3 Rinses & Spin, 1 Rinse & Spin, Final Spin	120	Select Dry or Damp Dry
4 Regular	Cotton Resistant Colors	122	Wash 12 lbs Dry 6 lbs	3 Times Wash, 3 Rinses & Spin, 1 Rinse & Spin, Final Spin	120	Select Dry or Damp Dry
5 Color	Cotton Delicate Colors	104	Wash 12 lbs Dry 6 lbs	2 Times Wash, 3 Rinses & Spin, 1 Rinse & Spin, Final Spin	105	Select Dry or Damp Dry
Rapid Wash Express	Cotton Assorted Colors	95	Wash 12 lbs Dry 6 lbs	One Wash, 3 Rinses & Spin, 1 Rinse & Spin, Final Spin	74	Select Dry or Damp Dry
9 Pre-wash	Synthetic Resistant Colors	104~140	6 lbs	Pre-wash, 3 Times Wash, 3 Rinses & Spin, 1 Rinse & Spin, Final Spin	110	Select Damp Dry
10 Regular	Synthetic Assorted Colors	140	6 lbs	3 Times Wash, 3 Rinses & Spin, 1 Rinse & Spin, Final Spin	90	Select Damp Dry
11 Gentle	Synthetic Quick Wash	122	6 lbs	2 Times Wash, 3 Rinses & Spin, 1 Rinse & Spin, Final Spin	85	Select Damp Dry
12 Express	Synthetic Delicate Color	104	6 lbs	One Wash, 3 Rinses & Spin, 1 Rinse & Spin, Final Spin	64	Select Damp Dry
15 Regular	Wool	86	2.2 lbs	One Wash, 3 Rinses & Spin, 1 Rinse & Spin, Final Spin	60	Do Not Dry

Wash Cycle Selection

Drying Options

Choose your drying options from the table below to suit your personal preference.

Fabric	Load	RPM	Dry Minutes	Damp Dry Minutes
Cotton & Linen	6 lbs	1000	90	75
Cotton & Linen	4.4 lbs	1000	80	65
Synthetic & Delicate	3.3 lbs	850	90	75
Synthetic & Delicate	2.2 lbs	850	70	55

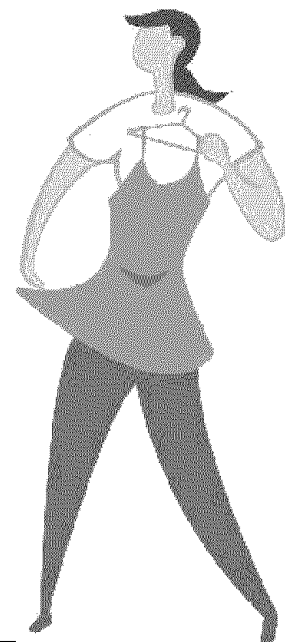
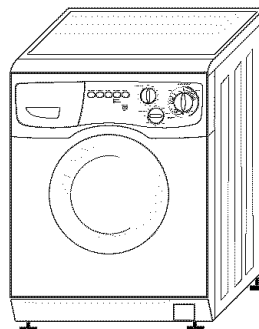
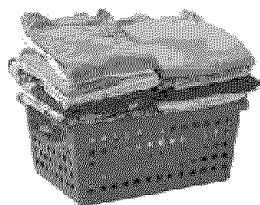
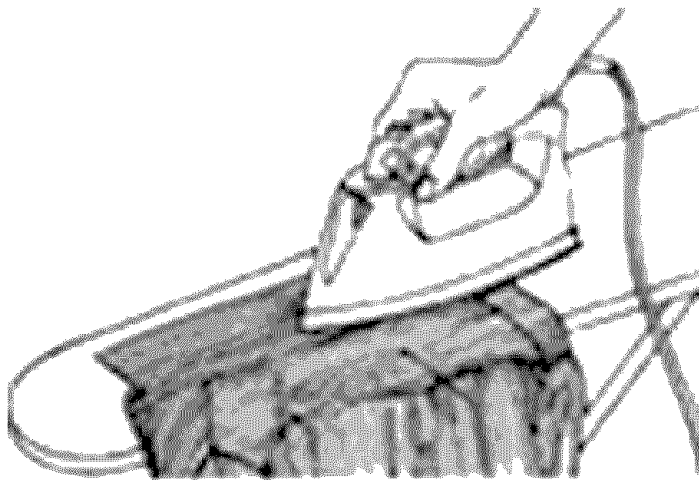

Detergent Guide

How to choose and use the right detergent

First, use only detergent specifically made for use in front load Washers. Other types will cause over sudsing.

Second, use only low sudsing powder or liquid detergent. Performance of this machine will be adversely effected if high suds detergents are used.

Third, check your water hardness. If your water is hard (7 grains or more) your detergent has to work harder.

Your water department can tell you how hard your water is. So can your county extension agent or your area's water softener company. Just call and ask them how many grains of hardness are in your water.

How much detergent do you use? That depends. Is your water hard or soft? With hard water you need extra detergent to get your clothes clean. With soft water you need less detergent. Too much detergent can be harmful-potentially causing serious problems with your washer dryer. For this reason, it is always best to find out your water hardness and adjust your detergent usage.

Keep your detergent fresh. Under the sink isn't a good place to store detergent. Too much moisture will cause the powder to cake.

If your powder detergent gets older or lumpy throw it away. It won't wash well. Old detergent often won't dissolve. If you use a liquid detergent these precautions are not necessary because liquid detergents don't lump as they age or come in contact with water.

You will find four compartments in your Washer Dryer dispenser. Pre-wash, Wash, Softener, Bleach.

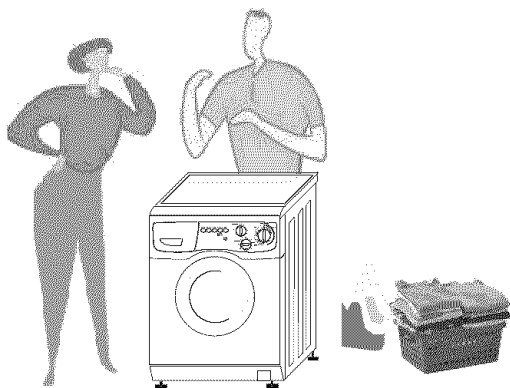

Front load machines need much less detergent than top load washing machines. Follow detergent manufacturer instructions for front load machines. Detergent is flushed automatically into the drum from the detergent dispenser. Over sudsing will cause your unit to malfunction. Suds may rise through detergent dispenser and may spill on your floor, so, be very careful in choosing the detergent quantity based on laundry load, fabric type and soil/stain conditions. **Always choose a low sud detergent for this machine.**

Bleach Recommendation

Always dilute bleach before using.

Excessive/ Frequent use of bleach can damage clothes.

Bleaching Whitens clothes, removes problem stains, deodorizes & sanitizes.

Use discretely and always follow bleach manufacturer instructions.

Do not add bleach while rinsing. Pour bleach in detergent dispenser 3.

Do not overfill bleach. This can damage clothes.

Fabric Softener Recommendation

All fabrics benefit by the use of softeners. We recommend use of softener to reduce the "clinging" effect in synthetics and make laundry feel soft.

Pour the softener in detergent dispenser 4.

Do not overfill. Excessive use of softener may affect wash results. Always follow softener manufacturer instructions.

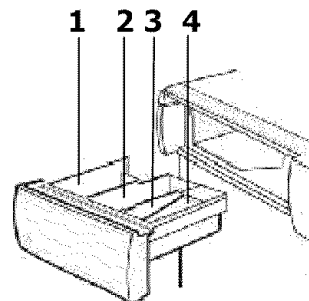

- 1 - Pre Wash 1.76 ounce Max.
- 2 - Main Wash 4.41 Ounce Max.
- 3 - Bleach 2.71 Fluid Ounce
- 4 - Softener 2.71 Fluid Ounce Max.

Care and Cleaning

⚠ Unplug electric power cord before cleaning washer dryer to avoid shock.

Cleaning the Exterior

Use a soft damp cloth or sponge to wipe up any spills. Occasionally wipe the outside of your unit to keep it looking new.

Cleaning the Interior

The drum is made of stainless steel so it will no rust. However, specks of rust can be caused by small metal articles like safety pins, paper clips or belt buckles washed in the washer dryer. The drum should be cleaned regularly. Not cleaning the drum may lead to a build up of scale clogs, limescale and dirt leading to replacement. Clean the drum by using chlorine bleach. Mix one cup of bleach and two scoops or caps of detergent. Pour this into detergent drawer compartment two. Choose automatic wash program, rotate Wash program knob to position four. Rotate Water Temperature knob to 203 °F position. Push Power button to start. Repeat if necessary. To remove hard water deposits or scales, use Washer safe labeled cleaners. Wipe drum thoroughly with a damp cloth. Apply a liquid nonflammable household cleaner to stained areas and wipe with a soft cloth to remove stains or colors. Never use steel wool. Use descaling agents suitable for use on stainless steel. Some descalers contain chemical components that can attack parts of your washer dryer. Be careful in selecting the right descaler. After cleaning run a cycle with plain water to remove any residual agents before inserting laundry.

Water Inlet hose

Replace hose after five years of use to reduce risk of hose failure. Periodically inspect and replace if bulges, kinks, cuts, wear or leaks are found. Mark the date of replacement on the hose by a permanent marker.

Lint Filter

⚠ To avoid water spills during removal of lint filter, place a bowl or tray under filter assembly.

The Lint filter is located at the bottom right corner. Always run the unit on spin mode before removing the lint filter to drain away residual water. Place a bowl or tray under the lint filter area to catch any residual water. **We recommend this strongly to avoid water spills on your floor.** Open bottom panel, unscrew and remove the lint filter. Run water on the filter to clean away detergent or softener residue. Rinse with hot water, dry using a clean towel and reinsert the filter back. Turn it clock wise and lock it in position. We recommend cleaning after every 25 full loads. It is not necessary to clean the lint filter after every load.

Detergent Drawer

Pull the detergent drawer out. Wash all compartments under running water. Clean the recess with an old toothbrush. Make sure all detergent accumulations are removed. Use a jet of running hot water to flush out residues. Replace the drawer and run a rinse cycle without laundry.

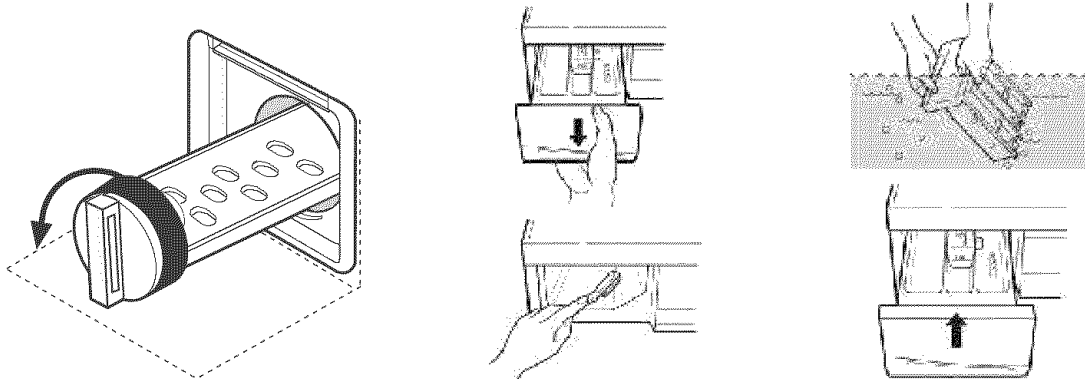

Vacation & Winter Storage

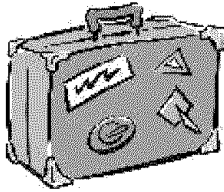

Install and store your washer/dryer where it will not freeze. Because some water may stay in the hoses and other parts and components, freezing can damage your washer dryer. If storing or moving your washer dryer during freezing weather, winterize it.

Nonuse or Vacation care

If you are going away on vacation or not using your washer/dryer for an extended period of time, you should....

- Unplug washer/dryer or disconnect power
- Turn off water supply. This helps avoid accidental flooding due to a water pressure surge while you are away.

To Winterize Washer Dryer

- Shut off water tap.
- Disconnect and drain water inlet hose.
- Fill all four detergent drawer compartments with RV-type antifreeze. Run washer dryer on Program 4 for about 30 seconds to mix antifreeze in water. Unplug washer dryer or disconnect power.

To use Washer Dryer again

- Flush out Water pipe and hose.
- Reconnect Water inlet hose.
- Turn on water tap.
- Plug in washer dryer or reconnect power
- Run washer dryer through a complete automatic cycle. Choose program four position on the dial.
- Load the detergent drawer compartment two with 4.41 ounces of low sudsing detergent to clean out anti freeze.

Note: Please make sure it is safe to discharge antifreeze into your drain pipe before doing so.

To Transport the Washer Dryer

- Shut the Water tap.
- Disconnect and drain water inlet hose.
- Disconnect drain hose from the drain system.
- If your washer/dryer is moved during freezing weather, winterize it before moving.
- Unplug washer/dryer or disconnect power.
- Wash lint filter.
- Make sure leveling legs are secure.
- Place inlet hose into the drum.
- Drape power cord and drain hose over edge and secure it firmly with tape.
- Insert shipping bolts and spacers.
- Use masking tape to secure washer dryer door.

Reinstalling your washer dryer

Follow installation instructions as given. Run the washer dryer through an automatic cycle. Select program four. Use one scoop or cap full of detergent to remove the antifreeze if used. Load detergent in compartment two.

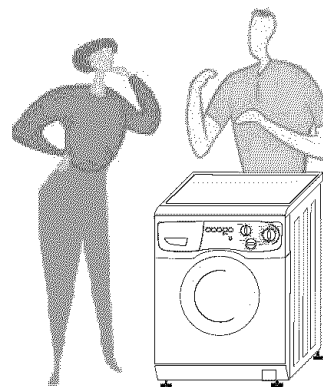



Safety Features

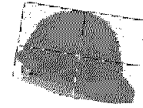

We Care For You...

For the protection of your family and loved ones your washer dryer is equipped with many safety features.

Child Safe Door

An electromechanical safety device in the door prevents it from opening during operation. Door will not open until the unit is shut down and the power button is turned off.

Washer Motor

A thermal safety device protects the motor from overload or underload giving the motor long life.

Temperature

A safety thermostat prevents excessive water temperature. Water will not heat if the water level is inadequate, water from the tap stops flowing or the tap is not turned ON. The machine will not start if prescribed water level is not available.

Water Spills

The filling valve stops if the water inlet filter is clogged or if the drain pump motor malfunctions. This protects your flooring, carpets, and rugs from water spills.

Safe Areas

By design, access is denied to children/adults reaching into the door or touching the pump motor filter while the unit is ON.

Fuse

A safety fuse built into the unit prevents excessive electrical overload.

Plug

Your washer dryer is equipped with two grounded plug to protect against leakage currents. System and equipment are both grounded by the plug.

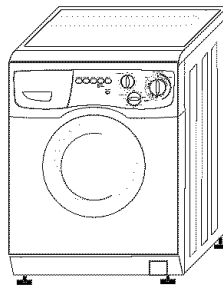
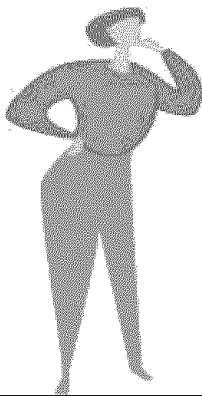

Fabric Care

Care Label Guide

The following information is provided by U.S. Federal Trade Commission as part of Project Clean. The symbols appearing on garment labels provide care instructions from the garment manufacturer. These symbols seen on the fabric serve as minimum laundering instructions to indicate washing, bleaching, drying, ironing and dry cleaning. Additional symbols or words or both may be used to clarify the instructions. The water temperatures listed below are provided as a guideline. Actual water temperatures obtained in the home depend on washing machine settings, regional supply temperatures and water heater settings.



It's time to wash new clothes that you brought last week and you don't understand a care label?

Care information tags are available on most clothes sold in the United States. These written instructions normally give a single care method for your garment. When an international care symbol tag is also present, all care methods will usually be shown. We are happy to present the international symbol guide as a handy reference to help you select a correct wash and dry program that supports the care method prescribed by the garment manufacturer.

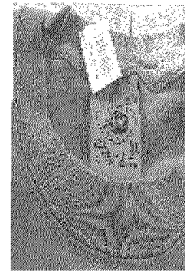

WASH



Normal



Permanent Press/Wrinkle Resistant



Gentle/Delicate



Hand Wash



Water Temperature 120 °F (Hot)



Water Temperature 105 °F (Warm)



Water Temperature 85 °F (Cold/Cool)



Warning: Do Not Wring



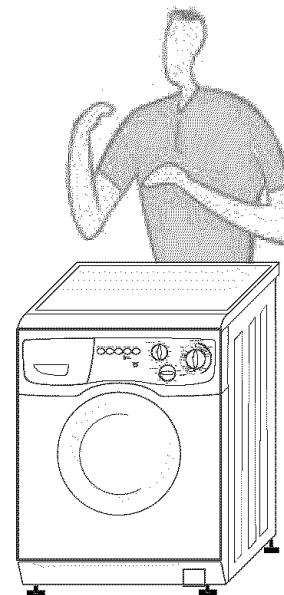

Warning: Do Not Wash















Fabric Care







BLEACH

-  Any Bleach (when needed)
-  Only non-chlorine bleach (when needed)
-  Warning: Do Not Bleach









DRY

-  Dry
-  Normal
-  Permanent Press/Wrinkle Resistant
-  Gentle/Delicate
-  Heat Setting: High
-  Heat Setting: Medium
-  Heat Setting: Low
-  Special Instructions: Line Dry/Hang to Dry
-  Special Instructions: Drip Dry
-  Special Instructions: Dry Flat
-  Special Instructions: Dry in Shade
-  Warning: Do Not Dry (used with do not wash)
-  Warning: Do Not Tumble Dry

IRON

-  Iron
-  High
-  Medium
-  Low
-  Warning: Do Not Iron
-  Warning: No Steam

DRY-CLEAN

-  Dry Clean
-  Any Solvent
-  Dry Clean - Normal Cycle: Any Solvent Except Trichloroethylene
-  Dry Clean - Normal Cycle: Petroleum Solvent Only
-  Professionally Dry-clean: Reduce Moisture
-  Professionally Dry-clean: Short Cycle
-  Professionally Dry-clean: No Steam Finishing
-  Professionally Dry-clean: Low Heat
-  Warning: Do Not Dry-clean



Questions? Use This Troubleshooting Guide

PROBLEM

POSSIBLE CAUSE AND REMEDY

Washer won't fill, rinse or drum will not turn

- Is power cord plugged into a 110V power receptacle?
- Is Wash Program knob pointing to the correct program number?
- Is water inlet hose kinked?
- Is water pressure at the tap correct? Is the tap ON?
- Is the door closed?
- Is the fuse blown or circuit breaker tripped?
- Are shipping bolts and spacers removed?
- Are knobs rotated clock wise?
- Is your Wash Program knob working correctly?

Drum does not fill, but Water is flowing

- Is your drain hose fixed at the correct height?
- Is the power cord plugged into a 110V power receptacle?
- At the start of the cycle Water inflow is low and is absorbed by the laundry quickly. This creates a perception that water is not flowing.
- This is normal, allow the program and the cycle to continue.

Washer dryer stops

- Is power cord plugged into a 110V power receptacle?
- Are all knobs correctly rotated?. Do they point to the program?
- Is water inlet hose blocked or kinked? Is the tap on?
- Is there electrical power at the wall receptacle?
- Call an electrician to check the wall socket.
- Are you using an extension cord? Do not use an extension cord.
- Is the drum overloaded with laundry?
- Is the lint filter clogged? (Do not open while unit is full of water).

Washer won't drain

- Is the drain hose clogged? Is the end of drain hose more than 2.63 ft above the floor?.
- Is the lint filter clogged? (Do not open while unit is full of water).
- See installation instructions for proper installation of drain hose.
- Is the door open?
- Are there excessive suds?
- Is your voltage low? Check your electrical service or call an electrician. Do not use an extension cord.

Washer continues to fill or drain or the cycle seems stuck

- Is the end of the drain hose more than 2.63 ft above the floor?
- Is there a air gap in the drain hose?
- Is the lint filter clogged? (Do not open while unit is full of water).
- Are all knobs correctly positioned?
- Is the unit plugged into a 110V power receptacle?
- Is voltage low? Check electrical service or call an electrician.

Washer makes noise

- Are shipping bolts and spacers removed?
- Are gears engaging? These are normal Washer Dryer noises.
- Coins or safety pins or other metals items may be in the drum
- Heavy wash loads can produce a thumping sound. This is normal.
- Is the Washer Dryer levelled? Are all four feet resting firmly on the floor?
- Adjust leveling legs if necessary.
- Is your flooring correct? Refer page 8.

Troubleshooting Guide

PROBLEM	POSSIBLE CAUSE AND REMEDY
Washer/Dryer leaks	<ul style="list-style-type: none"> • Is Water inlet hose tight? Are all hose washers properly seated? • Is the drain hose clamped and properly installed? • Is the sink or drain clogged? • Was too much detergent used? Excessive suds will cause the unit to overflow. • Is the unit leveled and resting firmly on the floor? • Check leveling and adjust. Check household plumbing for leaks. • Check filter cap is closed tightly? Is trim in place? • Check detergent dispenser for clogs.
Detergent dispenser clogged	<ul style="list-style-type: none"> • Did you use excessive detergent? Is the detergent low sudsing? Always measure and use low sudsing detergents. Pour it carefully and wipe up spills. • Did you pour fabric softener in the fabric softener dispenser? • Did you pour bleach into its correct dispenser? • Did you use a powered bleach? Use liquids only.
Load too wet	<ul style="list-style-type: none"> • Is your wash cycle program correct? See pages 11 and 12. • Did you select 1000 rpm spin speed? • Is the temperature setting correct? • Did you turn your knobs correctly? Do they point correctly? • Did you press Rinse and Hold button? Is voltage correct?
Residue or lint on load	<ul style="list-style-type: none"> • Did you sort your laundry properly? • Did you overload the washer/dryer? Lint can be trapped in the load if overloaded. Wash smaller loads. • Was paper or tissue left in the pockets? • Did you use enough detergent? Follow detergent guide. • Did you set temperature correctly? Cold water will not dissolve detergent completely. • Did you clean lint filter?
Stains after Wash	<ul style="list-style-type: none"> • Did you follow the guide when adding detergents? Refer page 13 • Use just enough detergent to remove soil and become soluble. • Use correct fabric softener depending on fabric type. • Is water in your tap hard? Install an ion filter if possible. • Did you properly sort the load? Is color bleeding? Mix only if color does not run. • Did you leave clothes in the drum at the end of the cycle? Some dyes transfer during dry cycle. Make sure color does not run. • Is detergent dispenser clean? Clean if necessary.
Load is wrinkled	<ul style="list-style-type: none"> • Is your wash cycle correct? Is the drum overloaded? • Did you remove clothes after the wash cycle, hang dry and then use the dryer? • Allow the unit to run from wash to dry without interruption. • Check the fabric type-some fabrics are drip dry only. • Did you set the temperature knob correctly? Excess temperature may cause the load to wrinkle.

Troubleshooting Guide

PROBLEM	POSSIBLE CAUSE AND REMEDY
Load is tangled or twisted	<ul style="list-style-type: none">• Did you overload drum? Loads should move freely during washing.• Did you place laundry loosely into the drum? Do not wrap clothing together.
Fabric damage	<ul style="list-style-type: none">• Were sharp items removed from the pockets before washing?• Empty pockets, zip zippers, snap or hook fasteners before washing.• Were strings and sashes tied to prevent tangling?• Were items previously damaged? Mend rips & broken threads in seams before washing.• Did you overload drum? Laundry should move freely during washing.• Did you pour bleach directly on the laundry? Did you follow clothing care label instructions?
Washer does not dry	<ul style="list-style-type: none">• Did you overload drum? Is your washer dryer draining properly?• Is your laundry load too small to tumble properly? Add more laundry.• Is the water turned on? The dryer uses cold water during the dry cycle to create the condensation process. Is the unit connected to cold water?
Door does not open	<ul style="list-style-type: none">• Check that washer dryer is off. Have you pressed Stop? Wait for about three minutes.• Gently hit the door to cause a vibration to release the safety device.

Troubleshooting Guide

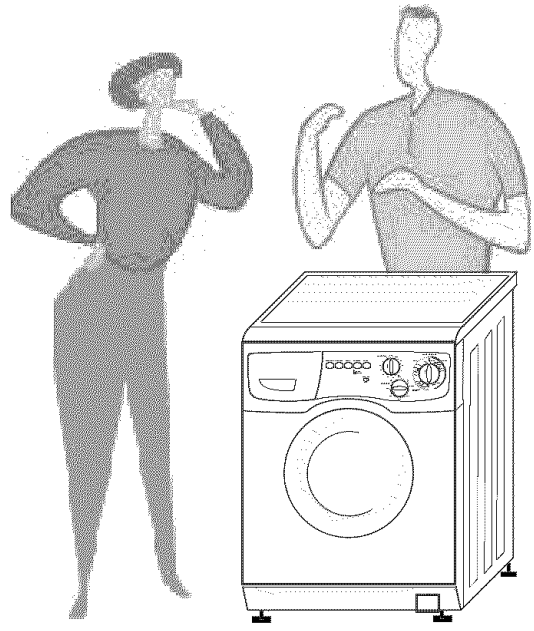

To receive more information
call toll-free 1.877.447 8772

Notes

We'll Be There

Congratulations on the purchase of your new washer dryer. If you ever need information or assistance, we'll be there. All you have to do is call us toll-free at 1.877.447.8772.

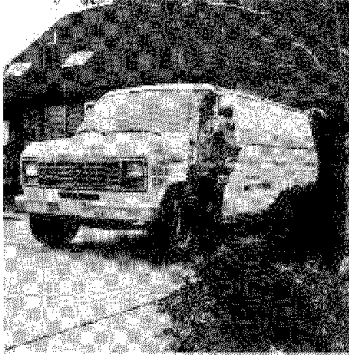

In-Home Repair Services 1.877.447.8772

An authorized consumer service professional will provide expert repair service and schedule a time that is convenient for you. Many consumer service company operated locations offer you service today, tomorrow or at your convenience. Trained technicians will handle your repair smoothly to your satisfaction.



Service 1.877.447.8772

You can have the secure feeling that consumer service will be there right after you purchase your washer dryer. Call Toll - Free to obtain information on a servicer close to your home.

Parts & Accessories 1.877.447.8772

Our parts system provides access to all parts and all genuine replacement parts are fully warranted. Call toll-free to obtain parts or accessories.



Call Center

Ask any question about washer dryers. Our call center information service is available to help. Your call and your question is important to us and will be answered promptly and courteously.

Hours of operation are Monday - Friday 8:00 am to 4:30 pm Central Standard Time.

User Maintenance instructions contained in this book cover procedures intended to be performed by any user. Other Servicing should be referred to a qualified service personnel. Caution must be exercised since improper servicing may cause unsafe operation.

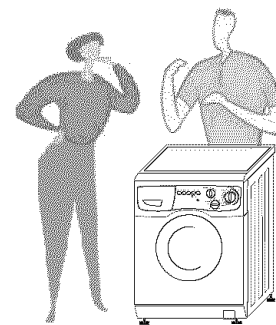

Service

*The manufacturer does not guarantee for possible impressions due to print or transcription errors contained in this manual. The manufacturer reserves the right to change/alter/modify product specifications and design without compromise to enhance product safety and standards and in the user's interest.

YOUR AUTOMATIC WASHER DRYER COMBINATION UNIT WARRANTY

Save proof of original purchase date such as your sales slip to establish warranty period.

WHAT IS COVERED

FULL ONE-YEAR WARRANTY

For one year from the date of original purchase, parts and service labor in your home to repair or replace any part of the washer dryer that fails because of manufacturing defect will be provided free of charge.

LIMITED SECOND YEAR WARRANTY

For the second year from the date of original purchase, replacement parts for the stainless steel drum and gear case assembly that fails because of a manufacturing defect will be provided free charge. Associated parts and plumbing parts are not covered by this warranty. You pay for the service trip to your home and service labor charges.

This Warranty is extended to the original purchaser and any succeeding owner for products purchased for ordinary home use in the 48 mainland states and Washington DC. All warranty services will be provided by BSI Service Corporation authorized and trained servicers during normal working hours. Call toll-free 1.877.447.8772 to receive guidance on service issues.

WHAT IS NOT COVERED

1. Service trips to your home to teach you how to use the product.
2. Improper installation
3. Replacement of house fuses or resetting of circuit breakers.
4. Cleaning or servicing of hose pipes or drain facility.
5. Failure of the product if it is used for other than its intended purpose or used commercially or used outside the United States.
6. Damage to product caused by accident, fire, flood, riots or acts of God.
7. Unauthorized modifications made to the unit or unauthorized repair.
8. If used on a 220 V power grid or on a 50Hz electrical cycle.

Read your Use and Care guide book carefully. If you have any questions about operating the product, please call toll-free 1.877.447.8772. If you have an installation problem contact your dealer or installer. You are responsible to provide adequate electrical, plumbing, drain and other connecting facilities. WARRANTOR is not responsible for consequential damages.

Some states do not allow the exclusion or limitation of incidental or consequential damages, so the above limitation or exclusion may not apply to you. This warranty gives you specific legal rights, and you may have other rights which vary from state to state

Warrantor: Supra Corporation

Warranty Administrator in the United States: BSI Services Corporation

Technical Service Provider in the United States: Technical Service and Support

Contact BSI Services Corporation at 1.877.447.8772

Contact Technical Service and Support at 1.877.447.8772

**SUPRA CORPORATION
6F, SHARMAN BLDG, 17-21, NISHIWASEDA CHOME
SHINJUKU-KU, TOKYO, 169-0051, JAPAN**