

WindTunnel™ with V2 Technology™ by HOOVER

Congratulations
on your purchase!

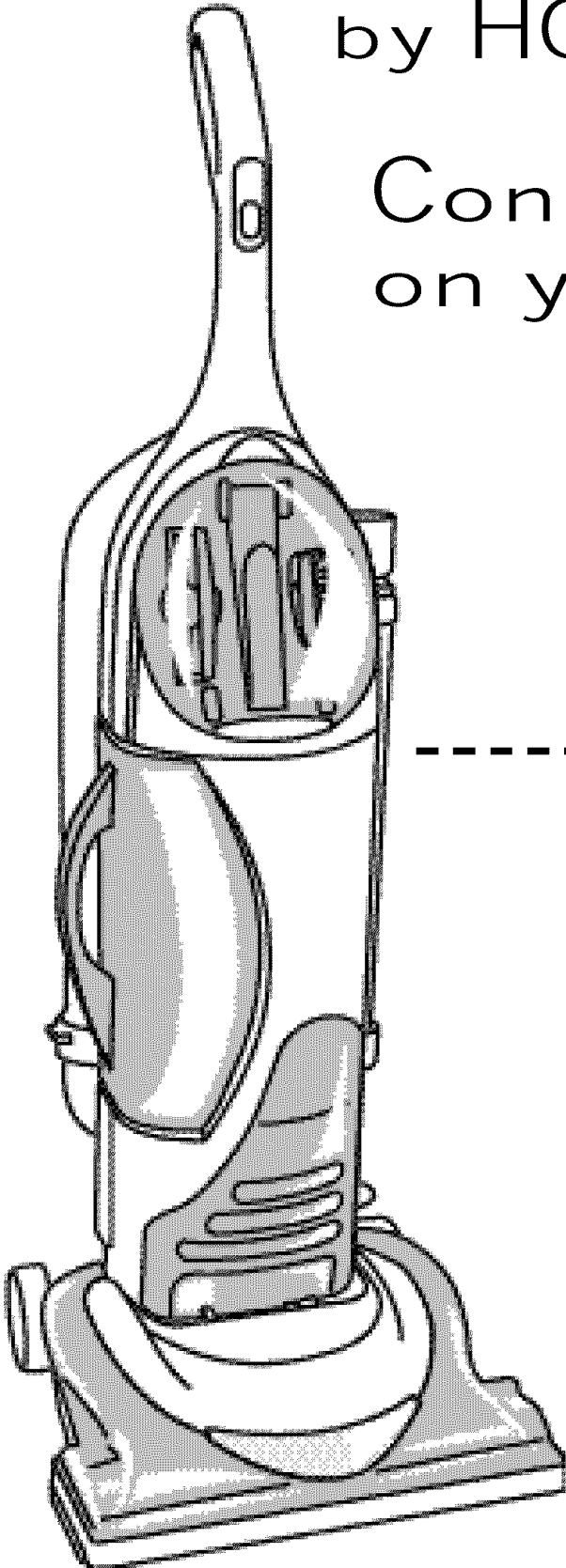

Owner's Manual

ENGLISH → pp. 1-12

ESPAÑOL → pág. 15-22

FRANÇAIS → p. 23-30



This product was designed for
easy assembly (see page 3)

Review this manual before
operating cleaner

Thank you for choosing a HOOVER product.

Please enter the COMPLETE model and serial numbers in the spaces provided.

The numbers are located on the back of your cleaner

Model _____

Serial number _____

Hint: Attach your sales receipt to this owner's manual.
Verification of date of purchase may be required for warranty service
of your HOOVER product.

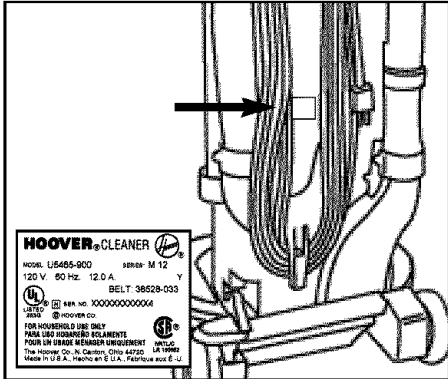

Contents

Assembling Cleaner.....	3-4
Carton Contents.....	3
Cleaner Descriptions.....	5
How To Use.....	5-7
Cleaning Tools	7
Carpet Height Adjustment.....	6
Brush Roll Switch	6
Circuit Breaker	6
If You Have a Problem.....	11
Clearing Blockages	12
Important Safeguards	2
Lubrication	11
Maintenance	
Authorized Service.....	12
Cleaning HEPA Filter	8
Replacing Edge Groomers	9
Replacing Filter Bag	8
Replacing Headlight	8-9
Thermal Protector	11
Warranty	12

Important Safeguards

When using an electrical appliance, always follow
basic precautions, including the following:

READ ALL INSTRUCTIONS BEFORE USING THIS APPLIANCE

Warning: To reduce the risk of fire, electric shock, or injury:

- Do not use outdoors or on wet surfaces.
- Close supervision is necessary when any appliance is used by or near children. Do not allow vacuum cleaner to be used as a toy or to run unattended at any time.
- Keep hair, loose clothing, fingers, feet and all parts of body away from openings, rotating agitators and other moving parts. Do not operate cleaner in bare feet or when wearing open toe shoes or sandals.
- Do not pick up anything that is burning or smoking, such as cigarettes, matches, or hot ashes.
- Do not use to pick up flammable or combustible materials such as gasoline or fine wood sandings or use in areas where they may be present.
- Avoid picking up hard, sharp objects with the cleaner. They may damage the cleaner and the bag.
- Always turn off this appliance before connecting or disconnecting hose.
- Do not use without dust bag or filter in place. Change bag frequently when picking up very fine materials such as powder.
- Use extra care when cleaning on stairs.
- Do not put any object into openings. Do not use with any opening blocked; keep free of dust, lint, hair, or anything that may reduce air flow.
- Do not pull or carry by cord, use cord as a handle, close door on cord or pull cord around sharp edges or corners. Do not run appliance over cord. Keep cord away from heated surfaces.
- Always disconnect cord from electrical outlet before servicing the cleaner.
- Unplug cleaner when not in use. Turn off all controls before unplugging.
- Do not unplug by pulling on cord. To unplug, grasp the plug, not the cord. Never handle plug or appliance with wet hands.
- The use of an extension cord is not recommended.
- Do not use with damaged cord or plug. If appliance is not working as it should, has been dropped, damaged, left outdoors, or dropped into water, take it to a Hoover Factory Service Center or Authorized Hoover Warranty Service Dealer (Depot).
- Use vacuum cleaner only for its intended use as described in the instructions. Use only attachments recommended by The Hoover Company; others may cause hazards.



© 2002 The Hoover Company

www.hoover.com

Save these instructions!

If you need any assistance:

Visit our website at www.hoover.com. Click on the "Service" button to find the service outlet nearest you OR

Call **1-800-944-9200** for an automated referral of service outlet locations (U.S. only) OR

Call 1-330-499-9499 to speak with a representative in our Consumer Response Center.

Please do not return this product to the store.

1. Cleaner Assembly

Carton contents

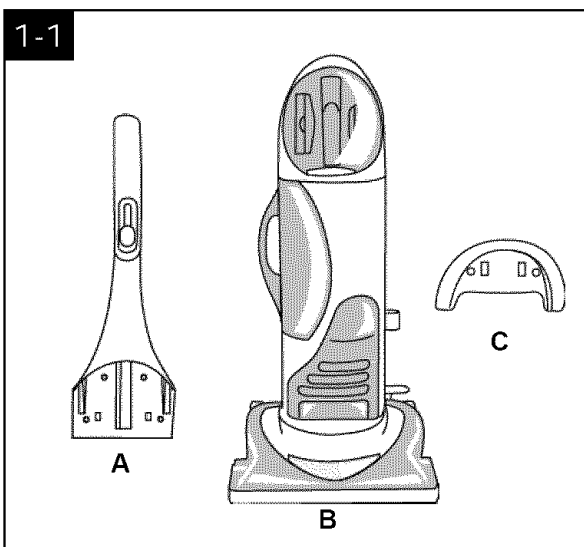

Empty carton. Find the parts shown above before disposing of packing materials.

- A. Handle section
- B. Cleaner body
- C. Hose holder

Accessories

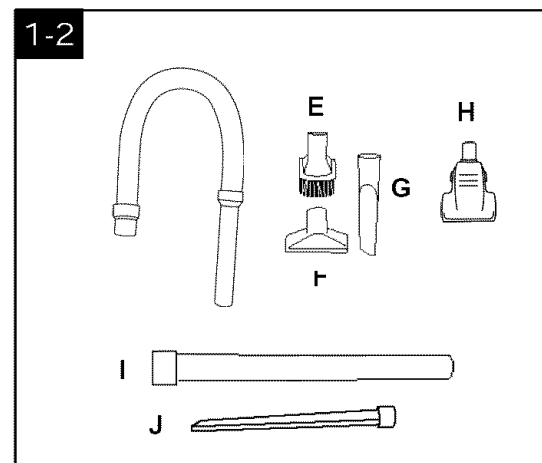

The accessories are packed on the cleaner.

Not all accessories are included with every model.

- D. Hose
- E. Dusting brush
- F. Furniture nozzle
- G. Crevice tool
- H. Powered hand tool
- I. Extension wand
- J. Crevice wand

Note: The **white switch lock** above the ON/OFF switch aids in the **assembly** of your cleaner. Assembly can be continued if the switch lock is missing. However, **do not remove** the switch lock **until assembly is completed**.

Cleaner Assembly

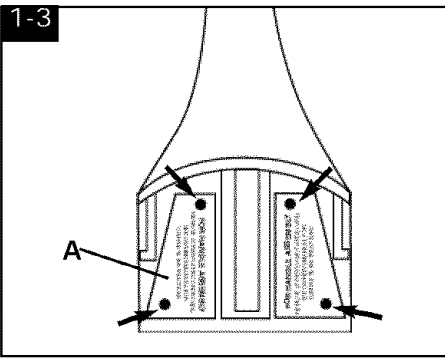

Remove cardboard (A) and four screws from handle section. Discard cardboard, but keep screws for assembly (Figs. 1-7 and 1-8).

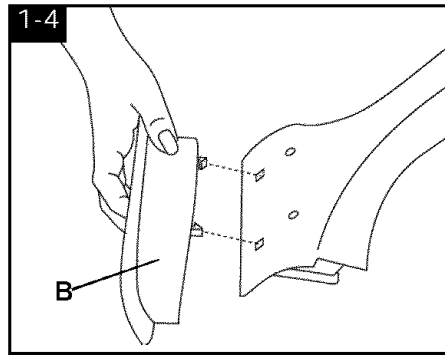

Snap tabs on hose holder (B) into holes on handle section.

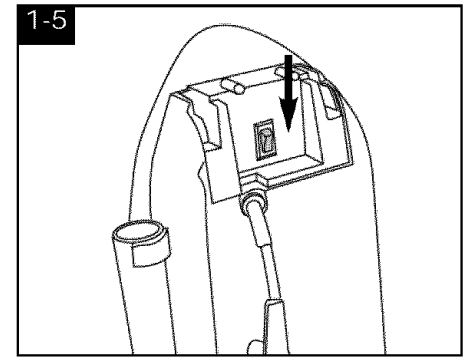

Push switch down to OFF position.

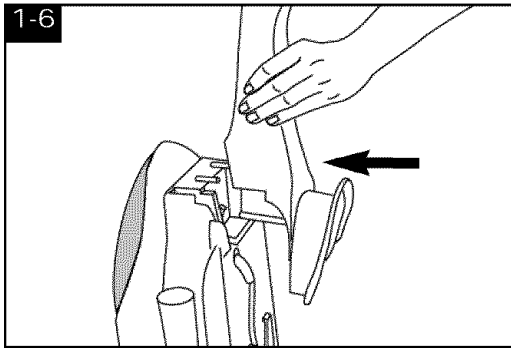

Slide handle section onto back of handle.

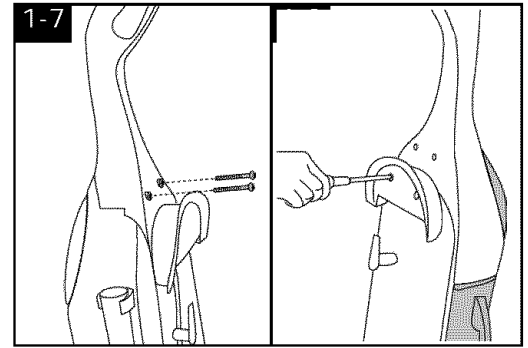

Push screws into holes on back of handle (Fig. 1-7) and hose holder (Fig. 1-8). Tighten screws securely with a Phillips screwdriver.

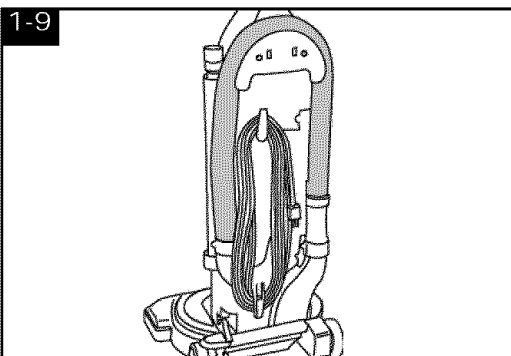

Place hose on holder.

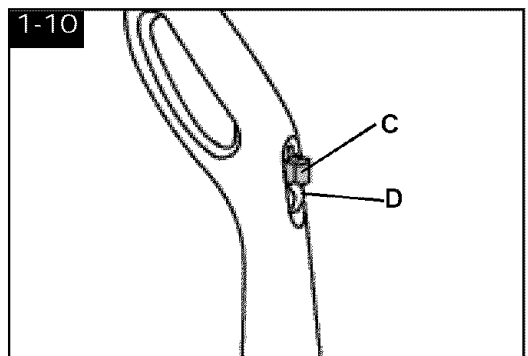

Pull switch lock (C) above ON/ OFF switch (D) straight out. Dispose of switch lock. **If switch lock has come off during assembly, make sure switch is in OFF position (down) before plugging into electrical outlet.**

2. How to use

The assembled cleaner will look like the drawing.

Cleaner description

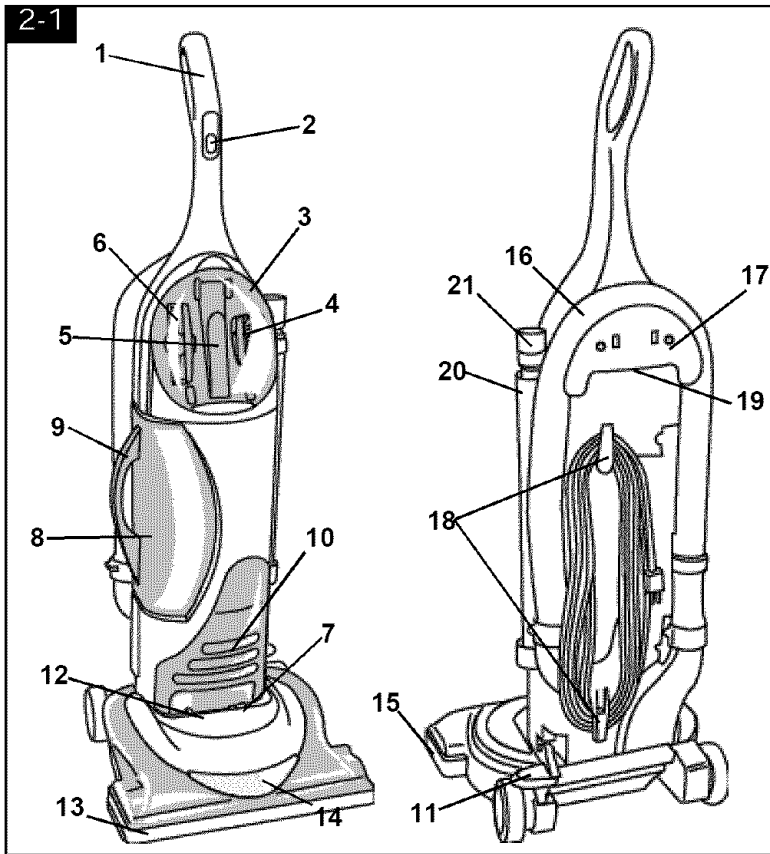

1. Handle
2. ON/OFF switch
3. Tool cover
4. Dusting brush
5. Crevice tool
6. Furniture nozzle
7. Brush roll ON/OFF switch
8. Bag container
9. Bag container handle
10. Final HEPA filter
11. Three position handle release pedal: step on lever to lower handle to operating or low positions.
12. Nozzle control knob: slide knob to correct setting for height of carpet being cleaned.
13. Furniture guard
14. Headlight
15. Edge groomers
16. Hose
17. Hose holder
18. Cord hooks: wrap cord around hooks for storage. The top hook rotates right or left for easy cord release.
19. Carrying handle
20. Extension wand
21. Crevice wand: stores in wand.

Operate cleaner only at voltage specified on data plate on bottom of cleaner.
This cleaner is intended for household use.

Polarized plug

To reduce the risk of electric shock, this appliance has a polarized plug (one blade is wider than the other). This plug will fit in a polarized outlet only one way. If the plug does not fit fully in the outlet, reverse the plug. If it still does not fit, contact a qualified electrician to install the proper outlet. Do not change the plug in any way.

ON-OFF switch

Plug cord into electrical outlet.

To turn cleaner ON, push switch up.

To turn cleaner OFF, push switch down.

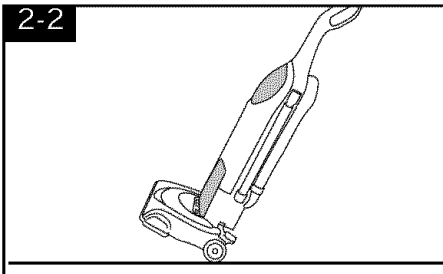

Transporting cleaner

Put handle in upright position. Tilt cleaner back on rear wheels. Push forward.

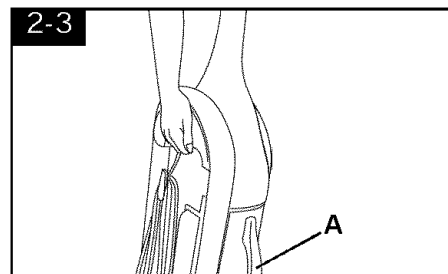

Carrying cleaner

Use the carrying handle to lift the cleaner.

Do not lift cleaner using dirt cup handle (A).

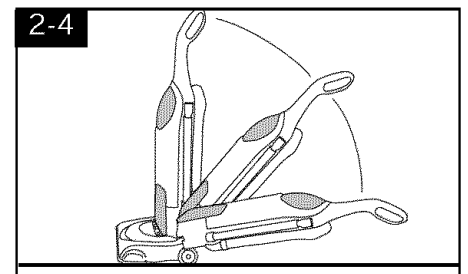

Handle positions

The handle of your cleaner has three positions; **upright** for storage and when using cleaning tools; **operating position** for general operation on carpet and floors; **low** for reaching under low furniture. Step on handle release lever to lower handle.

Continued →

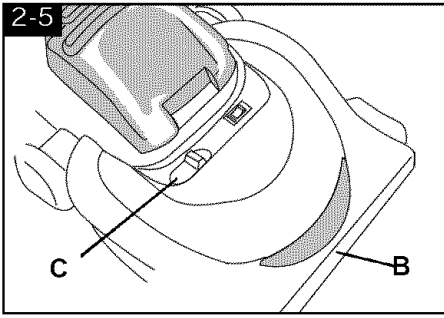

Carpet height adjustment

The cleaning of carpet and rugs takes place at the nozzle (B).

When it is necessary to raise and lower the nozzle for various carpet pile heights, slide the nozzle control knob (C) to the desired setting.

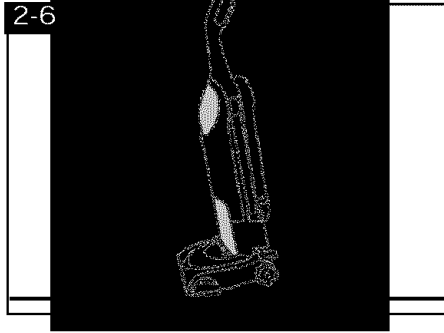

Handle position

For ease in sliding knob, place handle in the upright position and tilt cleaner forward.

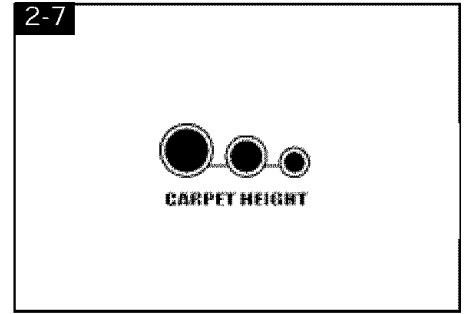

Settings

For maximum cleaning performance, the following carpet height settings are recommended.

 **Lowest setting:** for bare floors and all types of carpet

Note: If the cleaner is difficult to push, slide knob to the next higher setting.

 **Higher settings:** for very deep pile carpet where easier pushing effort is desired, while maintaining good cleaning performance.

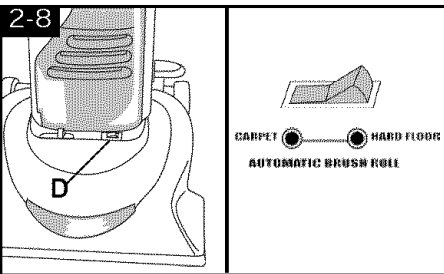

Brush roll switch

Turn brush roll switch (D) OFF to clean hard surface floors.

Turn brush roll switch ON to clean carpet and rugs.

The brush rolls will automatically turn off when the handle is in the upright position.

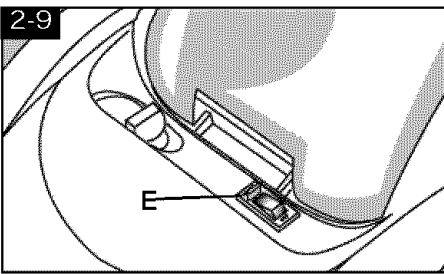

Circuit breaker

The circuit breaker turns off the brush rolls if there is an obstruction in them.

When tripped, the circuit breaker button (E) will pop up and the brush roll button will light up.

The brush rolls will not turn, but the suction motor **will continue to run.**

To reset the breaker, turn cleaner OFF and unplug it. Clear obstruction. Press circuit breaker button down. Turn cleaner ON and continue cleaning.

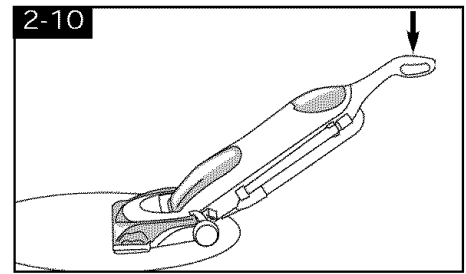

Cleaning lightweight flexible rugs

Stand on one end of rug and move cleaner toward other end or edge. Before reaching edge, push down on handle. This will lift up the nozzle (front of cleaner) and will prevent rug from clinging to cleaner. Continue to lift up nozzle so that when you have reached the edge, it is completely off the rug. Move cleaner back to start again, lower nozzle, and use only forward strokes.

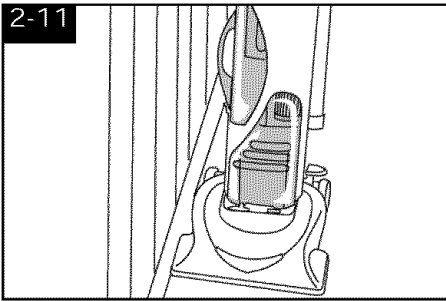

Edge cleaning

Special edge groomers are provided on both sides of the nozzle to remove dirt in carpet near baseboards and furniture.

Guide either side of nozzle parallel to edge of carpet or furniture.

Cleaning tools

When using cleaning tools, cleaner handle should be in the upright position to activate the automatic "brush roll OFF" and for convenience in moving the cleaner from one area to another.

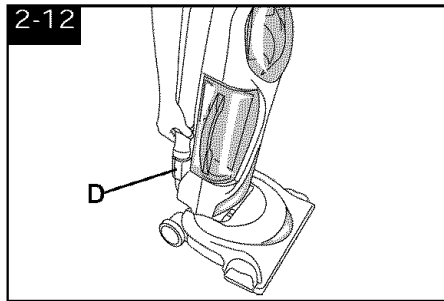

Turn cleaner OFF before disconnecting and connecting hose to hose tube (D).

To use hose, lift hose end as shown.

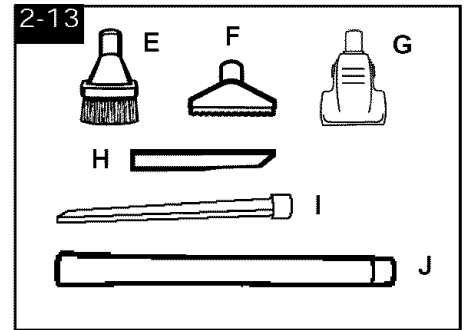

Select proper tool

E. Dusting brush may be used for carved furniture, table tops, books, lamps, lighting fixtures, venetian blinds, baseboards, shutters, and registers.

F. Furniture nozzle may be used for upholstered furniture, draperies, mattresses, clothing, automobile interiors, and carpeted stairs.

G. Powered hand tool* may be used for upholstered furniture, carpeted stairs and hard-to-reach places.

H. Crevice tool may be used in tight spaces, corners and along edges in such places as dresser drawers, upholstered furniture, stairs and baseboards.

I. Crevice wand can be used in tight spaces, corners and along edges in such places as dresser drawers, upholstered furniture, stairs, and baseboards. It can also be used for extra reach with the dusting brush and/or extension wand.

J. Wand is used to give extra length to your hose. Use it with any of the above tools.

*Available at additional cost if not included with you cleaner.

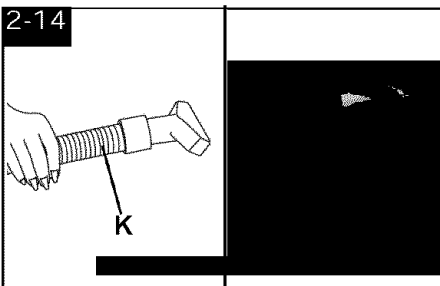

Attach wand and tools

Attach tool or wand to the hose (K).

Twist wand or tool slightly to tighten or loosen the connection.

How to clean tools

To clean the hose and the powered hand tool*, wipe off dirt with a cloth dampened in a mild detergent. Rinse with a damp cloth. Do not submerge powered hand tool in water.

Wash cleaning tools in warm water with a detergent. Rinse and air dry before using.

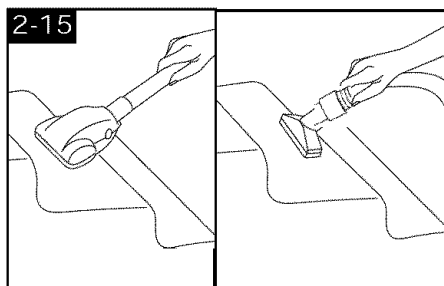

Stair cleaning

Use the hose and powered hand tool* or furniture nozzle for stair cleaning.

CAUTION: To prevent the cleaner from falling, always place it at the bottom of the stairs.

With handle in upright position, clean from bottom to top.

*Available at additional cost if not included with your cleaner.

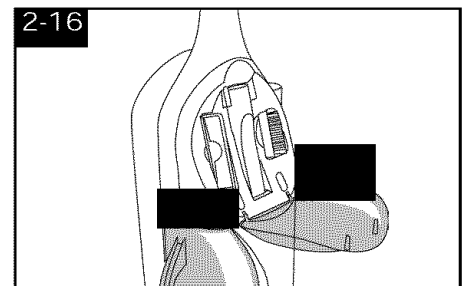

How to attach tool cover

The tool cover is designed with a "break-away" feature which allows it to snap free if it is pushed open too far.

To reattach, align hinges of cover with slots on sides of tool storage area.

Push cover down to secure in place.

3. Maintenance

Familiarize yourself with these home maintenance tasks as proper use and care of your cleaner will ensure continued cleaning effectiveness.

Filter bag

When to replace

Check filter bag from time to time. It is recommended that you change the filter bag when dirt reaches the dotted line. If more dirt than this accumulates, your cleaner will not operate effectively.

NOTE: All new carpet has loose fibers which can fill the bag quickly while vacuuming. If you are using the cleaner on new carpet, be sure to change the filter bag often.

Changing filter bag

Disconnect cleaner from electrical outlet.

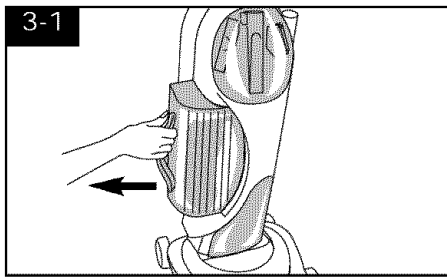

Remove filter bag container - Firmly pull cup **straight** out.

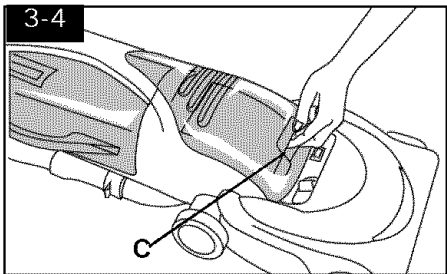

Cleaning final HEPA filter

The **final filter** assists in returning clean air to the room.

To remove this filter when it becomes dirty, lay handle flat on the floor. Press door tab (C) and remove door.

CAUTION: Very fine materials, such as face powder or cornstarch, may seal the filter bag and may cause it to burst even though it is only partially full of dirt. When cleaner is used to remove material of this nature, change filter bag often.

Where to buy

Filter bags may be purchased from your Authorized Hoover Dealer (Depot), Leading Retailers, Hoover Factory Service Centers or through The Hoover Company on-line at www.hoover.com

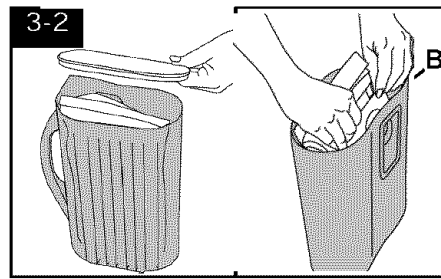

Remove and install filter bag - Remove lid. Grasp filter bag collar (A) and pull collar from tube (B).

Note: Do not clean out old filter bag and reuse. Discard used filter bag.

Align opening in new filter bag with dirt tube (B).

Push bag collar (A) firmly onto tube (B).

Tuck top of filter bag into container.

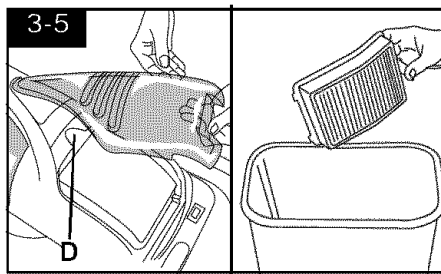

Press latch (D) and remove filter. The filter can be cleaned by tapping either of the ends. **Do not** tap soft pleated sides of the HEPA filter, as this could damage the filter. Reposition filter and replace door.

Should you want to replace this filter, ask for **HOOVER part No. 43613024.**

Do not operate cleaner without the filter in place.

What to buy

To assure cleaning effectiveness, use only **Genuine HOOVER® Allergen Filtration Type Y disposable filter bags.**



It is imperative that you use only genuine HOOVER filter bags made by The Hoover Company to assure that your cleaner operates at peak performance. HOOVER bags can be identified by these trademarks ---

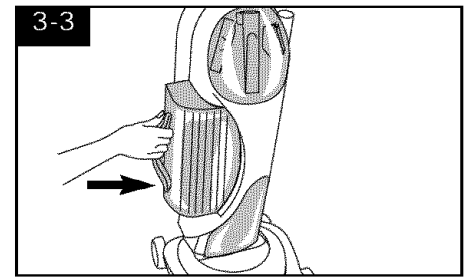

Replace container -

Replace bag container lid.

Slide container into place.

Press firmly until container locks in place.

Headlight replacement

What to buy

This cleaner uses a 12 volt, wedge base type 912 bulb, **HOOVER part No. 27313107.**

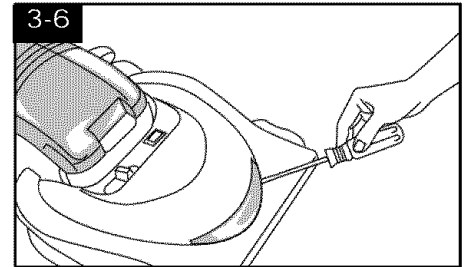

Remove lens -

Disconnect cleaner from electrical outlet.

Using a flat blade screwdriver, pry off lens as shown and lift off.

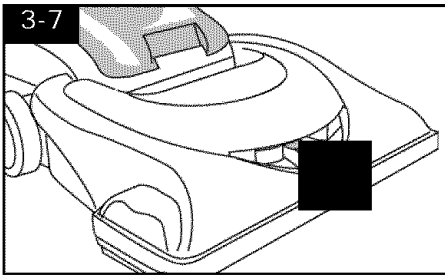

Install bulb - Pull old bulb straight out of socket. Push new bulb straight into socket until locked in place

Excessive force is not required.

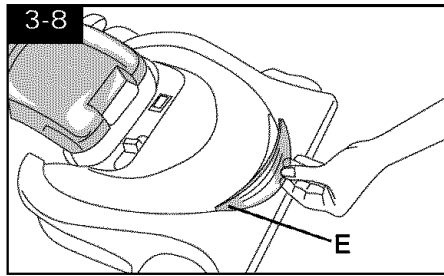

Replace lens - Place one tab (E) on lens into slot. Press on lens and secure other tab.

The agitator brush rolls

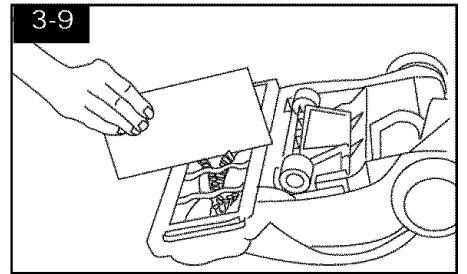

When to replace

When agitator brushes are worn, the agitators should be replaced.

To check condition of brushes, **disconnect cleaner from electrical outlet.**

Move edge of a card across bottom plate while turning agitators. To maintain cleaning effectiveness, have brush rolls replaced if brushes do not touch card.

New brush rolls can be installed at your nearest Hoover Factory Service Center.

The edge groomers

When to replace

The edge groomers, located on both sides of the nozzle, should be replaced when they appear worn.

What to buy

When purchasing edge groomers, ask for **HOOVER part No. 39511009.**

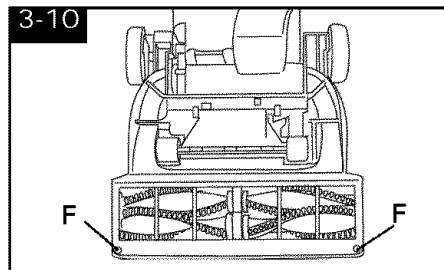

How to replace

Remove bottom plate

Disconnect cleaner from electrical outlet.

Lower handle to lowest position. Turn cleaner over.

Remove the two screws (F) on bottom plate.

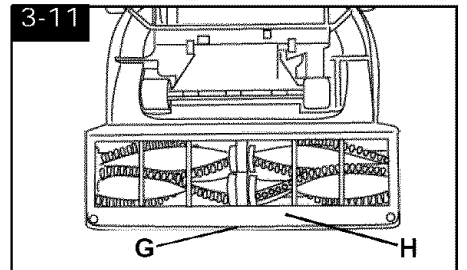

Insert screwdriver between latch (G) and bottom plate (H). Press outward on latch. Pull up on bottom plate and remove.

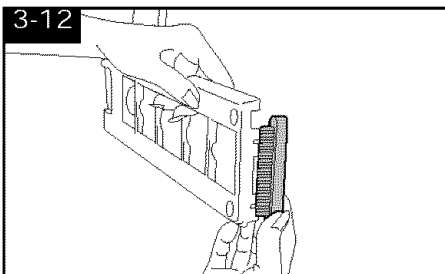

Install groomers

Lift off both old edge groomers and slide new edge groomers into position as shown.

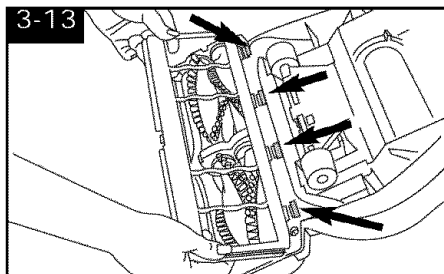

Insert tabs on bottom plate into slots on bottom of cleaner.

Press front bottom plate down and snap in place.

Replace screws.

Powered hand tool

(available at additional cost if not included with your cleaner)

Agitator brush roll replacement

When agitator brush roll brushes are worn, the brush roll should be replaced. Ask for **HOOVER part No. 48414088**.

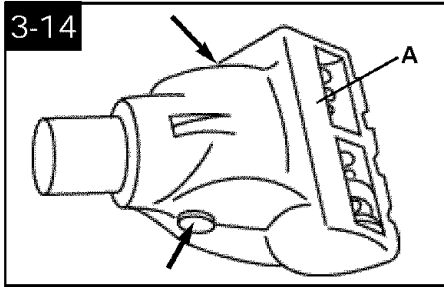

How to replace

1. Remove tool from hose and turn it so bottom faces up. Press the latches on either side of tool and remove bottom plate (A).

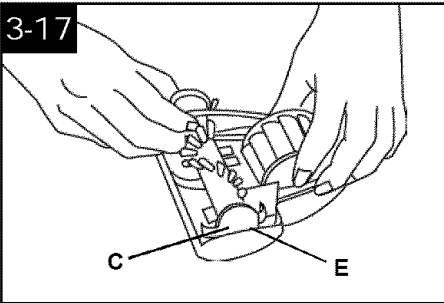

6. With curved ends down, slide end plates (C) of brush roll into slots (E) on tool.

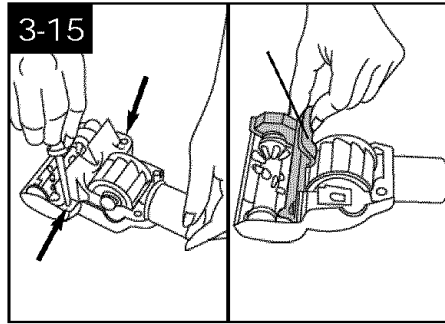

2. Unscrew the two Phillips screws and remove belt guard (B).

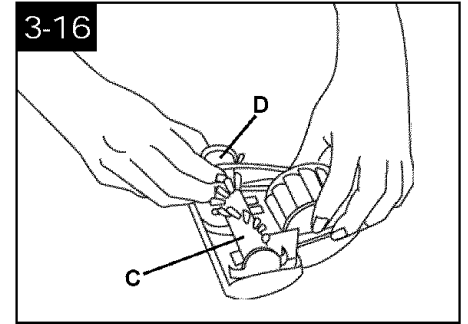

3. Remove agitator including end plates (C) and discard.

4. Inspect belt to ensure that it is in good condition. If belt is cracked, gouged or broken, replace it (see following section).

5. Insert brush roll through belt and position belt over gear teeth (D) on brush roll.

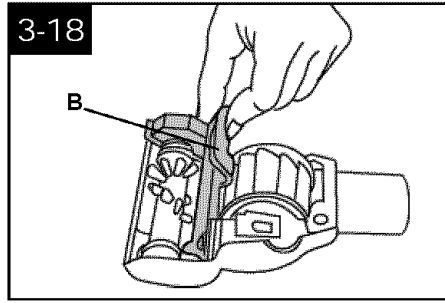

7. Replace belt guard (B) making sure not to pinch brush bristles in guard. Turn agitator, making sure it rotates freely.

Replace and tighten screws.

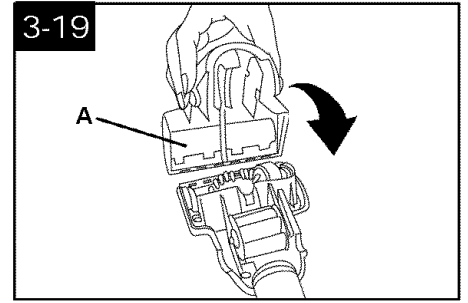

8. To replace bottom plate (A), insert the four tabs on edge of bottom plate into slots on front of tool.

Pivot bottom plate down and snap closed.

Powered hand tool

Belt replacement

Inspecting the belt

The powered hand tool belt is designed to last a long time and is not normally replaced. However, if the belt is cracked, gouged or broken, it should be replaced.

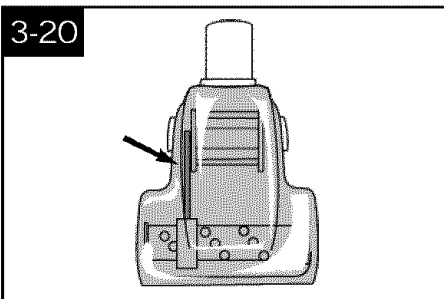

The belt can be seen through the top of the nozzle or by removing the bottom plate and belt guard (Figs. 3-14 and 3-15).

Replacing belt

When replacing belt, ask for **HOOVER part No. 38528037**.

1. Remove bottom plate, belt guard and brush roll as described in Figs. 3-14 through 3-16.

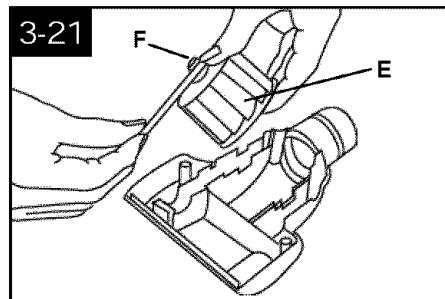

2. Grasp turbine (E) and pull firmly to remove.

3. Remove belt from turbine pulley (F). Replace with new belt.

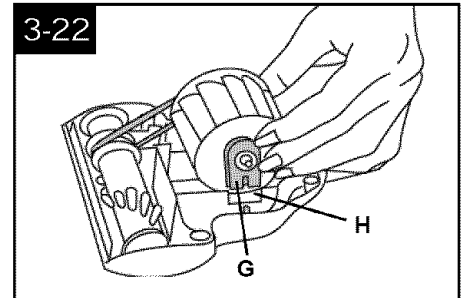

4. With flat sides of turbine retainers (G) pointing down, slide retainers into grooves (H) in tool housing and snap into place.

5. Replace brush roll, belt guard, and bottom plate as described in Figs. 3-16 through 3-19.

Lubrication

The cleaner is equipped with bearings that contain sufficient lubrication for the life of the cleaner. The addition of lubricant could cause damage. **Therefore, do not add lubricant to any bearings.**

Thermal protector

An internal thermal protector has been designed into your cleaner to protect it from overheating.

When the thermal protector activates, the suction motor will stop running, however the agitators will continue to run. If this happens, proceed as follows:

1. Turn the cleaner OFF and disconnect it from the electrical outlet.
2. Check bag. Replace if full.
3. Check final filter for dirt accumulation.
4. Refer to "Clearing blockages" section.
5. **When the motor cools**, the thermal protector automatically resets and cleaning may continue.

If the thermal protector continues to activate after following the above steps, your cleaner may need servicing (see "Service" section).

Hoover Cleaning Performance

This Hoover Cleaning Performance System is for comparing the relative progressive performance of **Hoover uprights only** and not for comparison with any other brands. The majority of this rating is based upon the American Society for Testing and Materials (ASTM) Carpet Cleaning Effectiveness Test (ASTM Test F608). Other performance factors include Hose Power (ASTM Test F558), Surface Litter Cleaning, Hard Floor Cleaning, Edge Cleaning, Cleaning Width, and Air Filtration.

4. If you have a problem

If a minor problem occurs, it usually can be solved quite easily when the cause is found by using the check list below.

Problem: Cleaner won't turn on

Possible cause

Possible solution

- **Not firmly plugged in**
- Plug unit in firmly
- **No voltage in wall plug**
- Check fuse or breaker
- **Blown fuse or tripped breaker**
- Replace fuse or reset breaker
- **Thermal protector activated**
- Allow cleaner to cool (this will reset the thermal protector) (see pg. 11).

Problem: Agitator brushes aren't turning

Possible cause

Possible solution

- **Brush roll switch in OFF position.**
- Turn brush roll switch ON.
- **Circuit breaker tripped**
- Reset circuit breaker as described in Fig. 2-9.
- **Agitators are obstructed.**
- Clear obstruction.

Problem: Cleaner won't pick up

Possible cause

Possible solution

- **Thermal protector activated**
- Allow cleaner to cool (this will reset the thermal protector) (see pg. 11).
- **Circuit breaker tripped**
- Reset circuit breaker as described in Fig. 2-9.
- **Filter bag full**
- Change filter bag.
- **Incorrect carpet height setting**
- Move nozzle control knob to lower setting.

Problem: Cleaner hard to push

Possible cause

Possible solution

- **Incorrect carpet height setting**
- Move nozzle control knob to a higher setting

Problem: Cleaning tools won't pick up

Possible cause

Possible solution

- **Blockage in hose**
- Clear blockage.
- **Thermal protector activated**
- Allow cleaner to cool (this will reset the thermal protector) (see pg. 11).

Problem: Powered hand tool (some models) brush roll won't turn

Possible cause

Possible solution

- **Too much pressure being applied to tool**
- Continue using tool applying light pressure.
- **Blockage in turbine channel**
- Remove blockage.
- **Broken or worn belt**
- Replace belt
- **Low cleaner suction**
- Check items under "Cleaner won't pick up".

Clearing blockages

Disconnect cleaner from electrical outlet.

Low suction or pick up may be due to a blockage in the system. Refer to the following steps to check for blockages **continuing with each step until the blockage is found:**

A. If a blockage occurs during floor cleaning:

Turn cleaner OFF and disconnect from electrical outlet.

1. Check fullness of filter bag; replace bag.

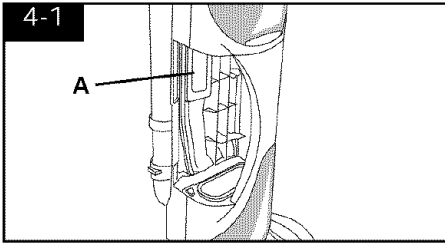

Check dirt duct

2. Remove bag container, look in duct (A).
3. Clear blockage from dirt duct.

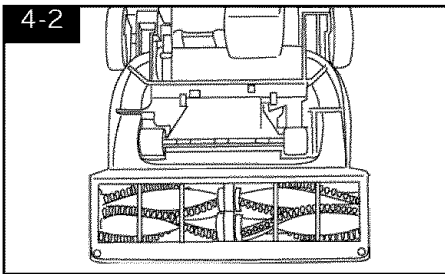

Checking brush rolls

4. Turn cleaner OFF and unplug.
5. Turn cleaner over and clear blockage from brush rolls. Reset circuit breaker if necessary (Fig. 2-9).

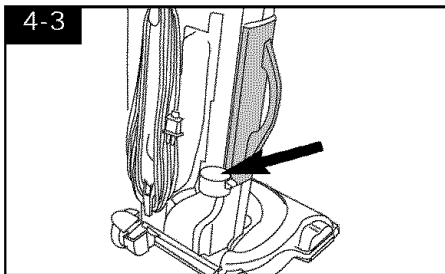

Check hose tube

6. Turn cleaner OFF and unplug.
7. Remove hose from tube. Clear blockage from tube. Also, check hose for blockage.

B. If a blockage occurs during tool use:

Turn cleaner OFF and disconnect from electrical outlet.

1. Look into hose end and remove any blockage.

C. If a blockage occurs during powered hand tool use (included with some models):

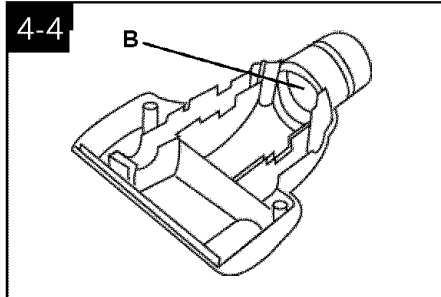

1. Disconnect powered hand tool from hose. Remove bottom plate, belt guard and turbine as described in Figs. 3-14, 3-15 and 3-21.

Remove any blockage from turbine channel (B).

Replace belt turbine, brush roll, belt guard and bottom plate.

Service

To obtain approved HOOVER service and genuine HOOVER parts, locate the nearest **Hoover Factory Service Center or Authorized Hoover Warranty Service Dealer (Depot)** by:

- checking the Yellow Pages under "Vacuum Cleaners - Household" OR -
- checking the list of Factory Service Centers provided with this cleaner OR -
- calling 1-800-944-9200 for an automated referral of authorized service outlet locations (U.S. only) OR -
- checking the Service section of The Hoover Company on-line at **www.hoover.com**

Do not send your cleaner to The Hoover Company in North Canton for service, this will only result in delay.

If further assistance is needed, contact The Hoover Company Consumer Response Center, North Canton, Ohio 44720, Phone: 330-499-9499.

In Canada, contact Hoover Canada, Burlington, Ontario L7R 4A8, Phone: 1-800-263-6376.

Always identify your cleaner by the **complete** model number when requesting information or ordering parts. (The model number appears on the back of the cleaner.)

Full One Year Warranty (Domestic Use)

Your HOOVER® appliance is warranted in normal household use, in accordance with the Owner's Manual against original defects in material and workmanship for a period of one full year from date of purchase. This warranty provides, at no cost to you, all labor and parts to place this appliance in correct operating condition during the warranted period. This warranty applies when the appliance is purchased in the United States including its territories and possessions, or in Canada or from a U.S. Military Exchange. Appliances purchased elsewhere are covered by a limited one year warranty which covers the cost of parts only. This warranty does not apply if the appliance is used in a commercial or rental application.

Warranty service can only be obtained by presenting the appliance to one of the following Authorized Warranty Service outlets. Proof of purchase will be required before service is rendered.

1. Hoover Factory Service Centers
2. Hoover Authorized Warranty Service Dealers (Depots)

For an automated referral of authorized service outlets in the U.S.A., phone 1-800-944-9200 OR visit The Hoover Company on-line at www.hoover.com

This warranty does not cover pick up, delivery, or house calls; however, if you mail your appliance to a Hoover Factory Service Center for warranty service, transportation will be paid one way.

While this warranty gives you specific legal rights, you may also have other rights which vary from state to state (or province).

If further assistance is needed, or if there are questions concerning this warranty or the availability of warranty service outlets, write or phone the Consumer Response Center, The Hoover Company, 101 East Maple St., North Canton, Ohio 44720. Phone 330-499-9499.

In Canada, contact Hoover Canada, Burlington, Ontario, L7R 4A8. Phone 1-800-263-6376.

HOOVER y  son marcas registradas

HOOVER et  sont des marques déposées

HOOVER and  are registered trademarks