

## 27" Electric Built-in Single and Double Ovens

### Quick Reference

#### Table of Contents:

##### Pages

1	Product dimensions	
1	Cutout dimensions	
1	Before you start	
2	Electrical requirements	
2	3	Installation steps

#### If you need assistance:

Check your Use and Care Guide for a toll-free number to call or call the dealer from whom you purchased this appliance. The dealer is listed in the Yellow Pages of your phone directory under "Appliances — Household — Major — Service and Repair."

Call when you:

- Have questions about built-in oven installation or operation.
- Need to obtain the name and number of an authorized service company.

When you call, you will need:

- The built-in oven model number.
- The built-in oven serial number.

Both numbers are listed on the model/serial rating plate, located on the oven door or on the oven frame.

# Product dimensions

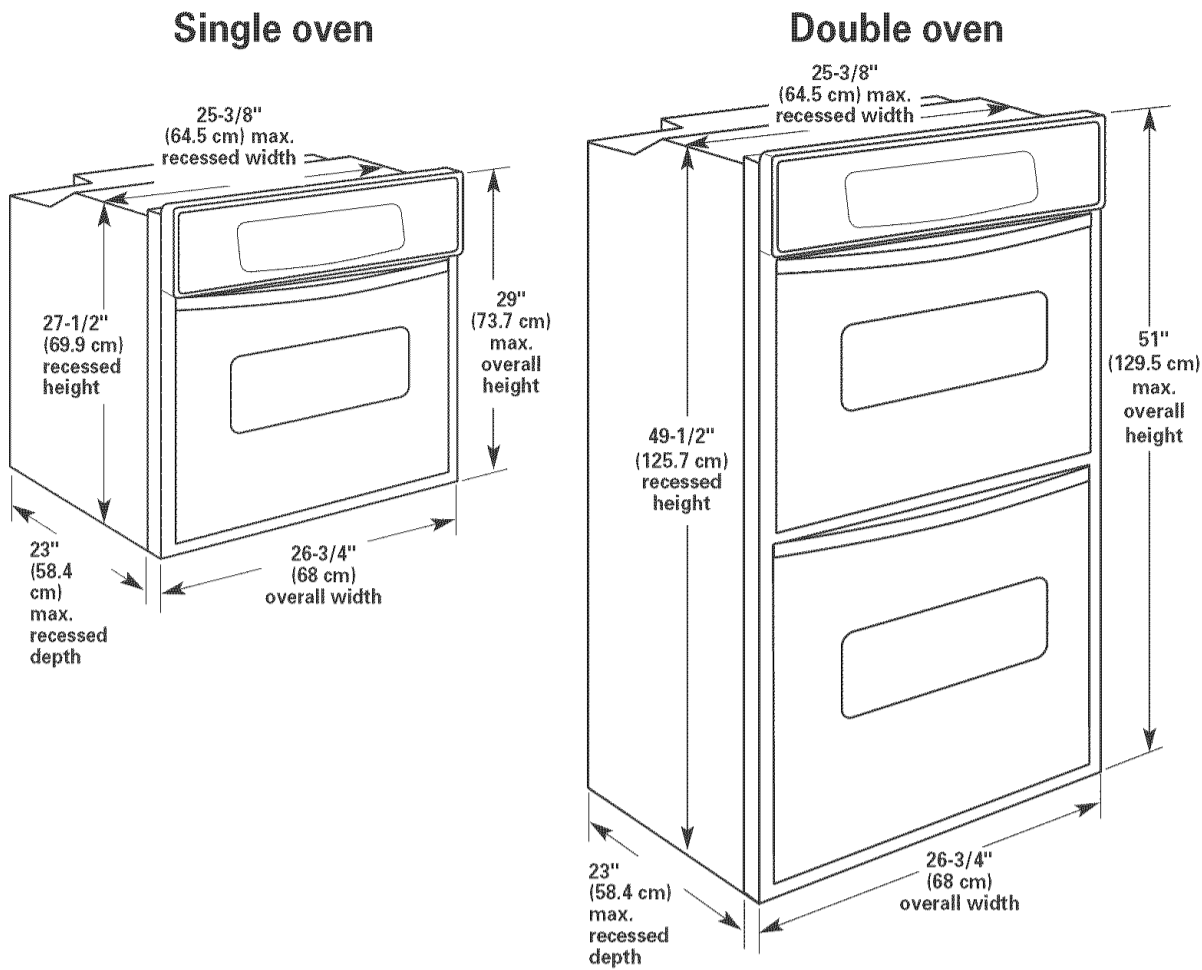

# Cutout dimensions

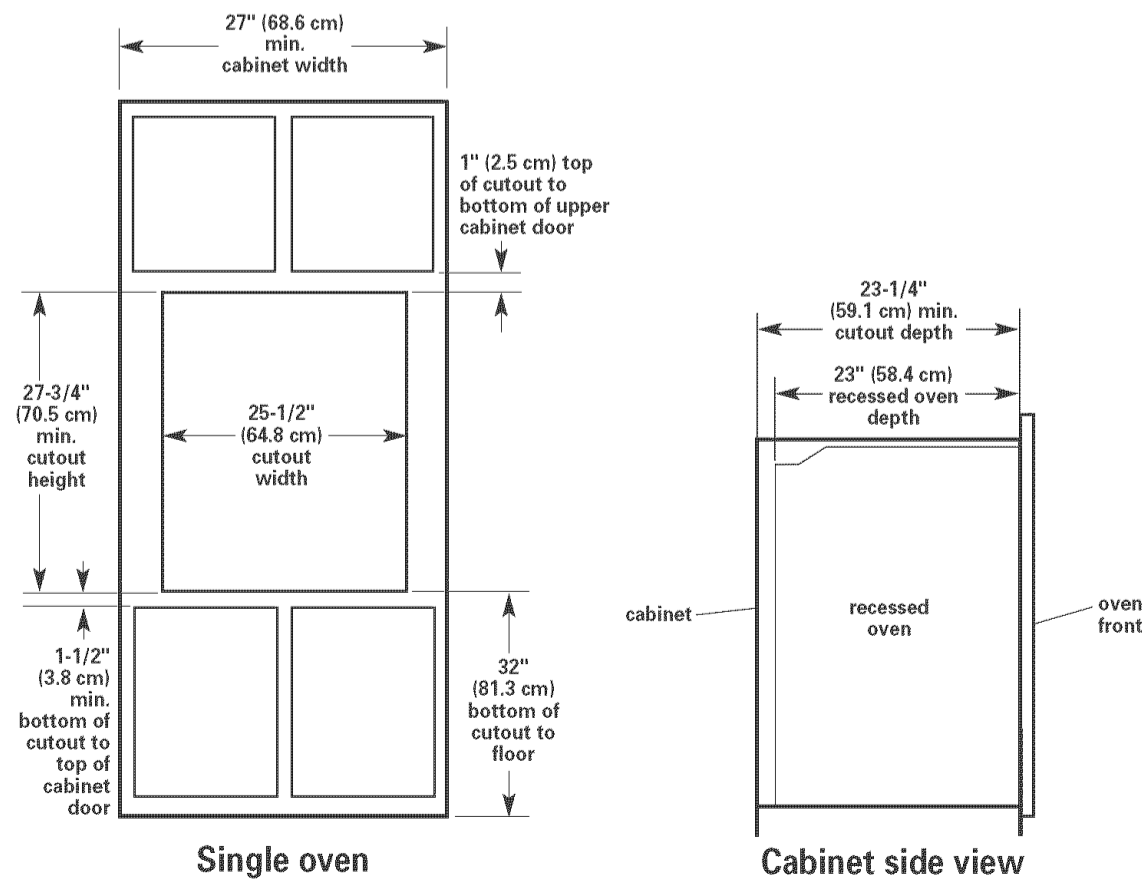
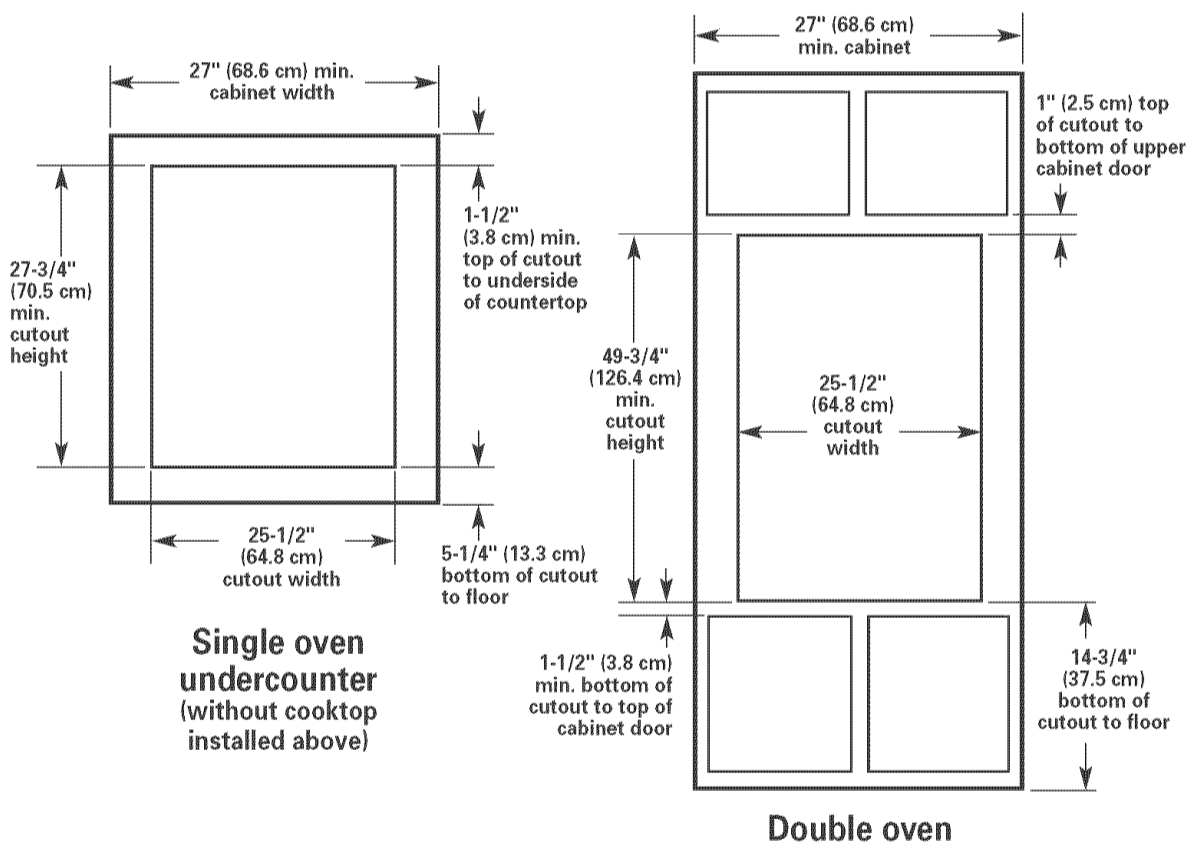

# Before you start...

Your safety and the safety of others are very important.

We have provided many important safety messages in this manual and on your appliance. Always read and obey all safety messages.



This is the safety alert symbol. This symbol alerts you to potential hazards that can kill or hurt you and others.

All safety messages will follow the safety alert symbol and either the word "DANGER" or "WARNING". These words mean:

## DANGER

You can be killed or seriously injured if you don't immediately follow instructions.

## WARNING

You can be killed or seriously injured if you don't follow instructions.

All safety messages will tell you what the potential hazard is, tell you how to reduce the chance of injury, and tell you what can happen if the instructions are not followed.

**Important: Observe all governing codes and ordinances.**

**Proper installation** is your responsibility. Have a qualified technician install this oven.

**Oven location** should be away from strong draft areas, such as windows, doors and strong heating vents.

**Cabinet opening dimensions** that are shown must be used. Given dimensions provide minimum clearance.

**Recessed installation area** must provide complete enclosure around the recessed portion of the oven.

**Electrical ground** is required. See "Electrical requirements."

**Electrical supply junction box** should be located 3 inches (7.6 cm) maximum below the support surface when oven is installed in a wall cabinet. Drill a 1-inch minimum (2.5 cm) diameter hole in the right rear or left rear corner of the support surface to pass the appliance cable through to the junction box. For undercounter installation, it is recommended that the junction box be located in the adjacent right or left cabinet. If installing the junction box on rear wall behind oven, junction box **must be recessed** and located in the upper or lower right or left corner of cabinet.

**It is the customer's responsibility:**

**To contact a qualified electrical installer.**

**To assure that the electrical installation is adequate and in conformance with National Electrical Code, ANSI/NFPA 70 — latest edition\*, or Canadian Electrical Code, C22.1-1982 and C22.2 No. 01982 (or latest edition)\*\* and all local codes and ordinances.**

Copies of the standards listed may be obtained from:

\* National Fire Protection Association  
Batterymarch Park  
Quincy, Massachusetts 02269

\*\* CSA International  
8501 East Pleasant Valley Road  
Cleveland, Ohio 44131-5575

## Tool needed:

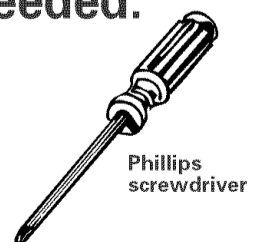

## Parts supplied:

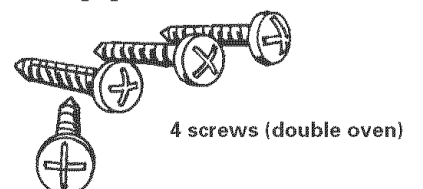

# Electrical requirements

If codes permit and a separate grounding wire is used, it is recommended that a qualified electrician determine that the grounding path and wire gauge is in accordance with local codes.

**Do Not ground to a gas pipe.**

**Check with a qualified electrician if you are not sure oven is properly grounded.**

**Do Not have a fuse in the neutral or grounding circuit.**

**This oven must be connected to a grounded metal, permanent wiring system.**

Oven **must** be connected to the proper electrical voltage and frequency as specified on the model/serial rating plate. (The model/serial rating plate is located on the oven door or on the oven frame.)

- ☑ Models rated from 7.3 to 9.6 kW at 240 volts (5.5 to 7.2 kW at 208 volts) require a separate 40-ampere circuit. Models rated at 7.2 kW and below at 240 volts (5.4 kW and below at 208 volts) require a separate 30-ampere circuit.

- ☑ A time-delay fuse or circuit breaker is recommended.
- ☑ Connect directly to the fused disconnect (or circuit breaker box) through flexible, armored or non-metallic sheathed, copper cable (with grounding wire).
- ☑ Flexible armored cable from appliance should be connected directly to junction box.
- ☑ Fuse both sides of the line.
- ☑ A U.L.-listed conduit connector **must** be provided at the junction box.
- ☑ Do Not cut the conduit.

**Wire sizes and connections** must conform with the rating of the appliance and to the requirements of the National Electrical Code, ANSI/NFPA 70 — latest edition\*, or Canadian Electrical Code, C22.1-1982 and C22.2 No. 01982 (or latest edition)\*\* and all local codes and ordinances.

If the house has aluminum wiring, follow the procedure below.

- a.) Connect the aluminum wiring to the copper wire using special connectors designed and Underwriters Laboratories-listed for joining copper to aluminum. Follow the electrical connector manufacturer's recommended procedure.
- b.) Aluminum/copper connection must conform with local codes and industry-accepted wiring practice.

Copies of the standards listed may be obtained from:

\* National Fire Protection Association  
Battery March Park  
Quincy, Massachusetts 02269

\*\* CSA International  
8501 East Pleasant Valley Road  
Cleveland, Ohio 44131-5575

# Installation Steps

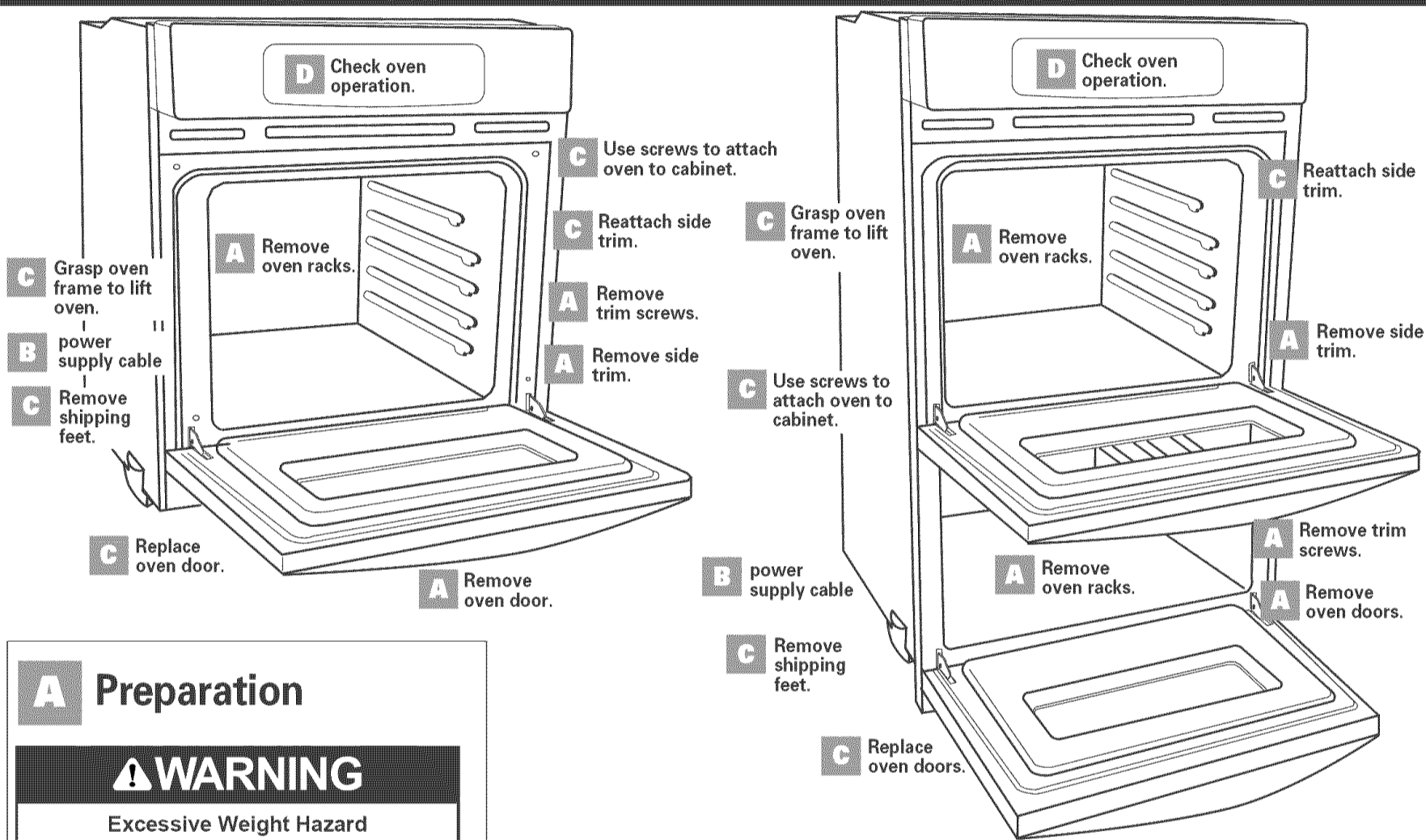

## A Preparation

### ⚠ WARNING

#### Excessive Weight Hazard

Use two or more people to move and install oven.

Failure to follow this instruction can result in back or other injury.

**Important:** Use both hands to remove oven doors.

**Do Not** use handle or any portion of the front frame or trim for lifting.

**Before moving oven across floor, check that oven is on shipping base or slide oven onto cardboard or hardboard.**

**Do Not** remove shipping feet at the front lower corners of oven.

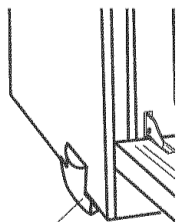

Do Not remove shipping feet.

**1.** Turn power supply off. Move oven close to final position.

- Remove and discard shipping materials, tape and protective film from the oven. **Do Not remove shipping base or shipping feet at the front lower corners of oven. The shipping feet will protect the lower oven trim until oven is inserted into cabinet.**
- Remove and set aside racks and other parts from inside oven.

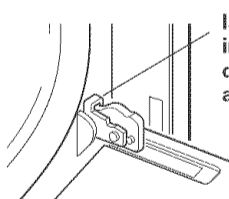

latch on the hinge in locked position — door free to open and close

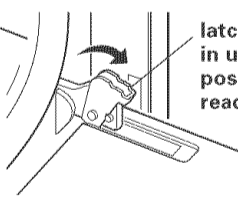

latch on the hinge in unlocked position — door ready for removal

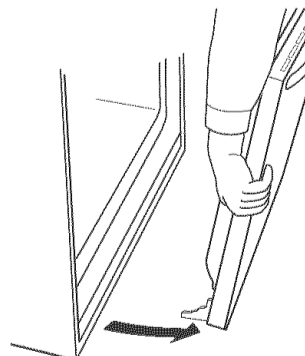

**2.** Completely open oven door. In both back corners of the door you will see door latches in the locked position. Rotate both latches forward to the unlocked position. Grasp outside edges of door with both hands.

- Begin closing door, at the moment the door stops closing, lift and pull door toward you.
- Set door aside on a protective surface.

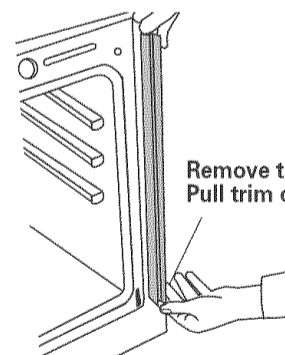

Remove trim screw. Pull trim out.

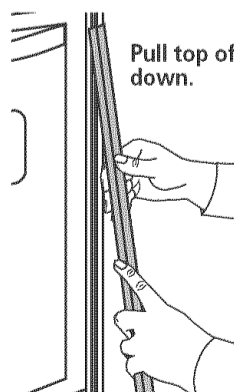

Pull top of trim down.

**3.** Remove trim screws attaching right and left side trim to oven. Grasp the bottom end of trim and pull away from oven. Slide top end of trim downward to remove trim from oven. Take care not to scratch other surfaces with ends of trim. Set trim and screws aside on protected surface.

## B Electrical connection

If your house has aluminum wiring, see "Electrical requirements", Page 2.

### ⚠ WARNING



#### Electrical Shock Hazard

Turn power supply off before connecting wires. Use 8 gauge solid copper wire. Electrically ground range. Failure to follow these instructions can result in death, fire, or electrical shock.

This oven is manufactured with white (neutral) power supply wire and a cabinet-connected bare grounding wire twisted together.

**4.** Feed oven cable through opening in the cabinet. Make electrical connection following the steps needed for your installation.

1. Disconnect the power supply.
2. Remove the junction box cover.
3. Connect oven cable to junction box through the U.L.-listed conduit connector.
4. Connect the two black wires together with twist-on connectors.
5. Connect the two red wires together with twist-on connectors.
6. Complete electrical connection according to local codes and ordinances.

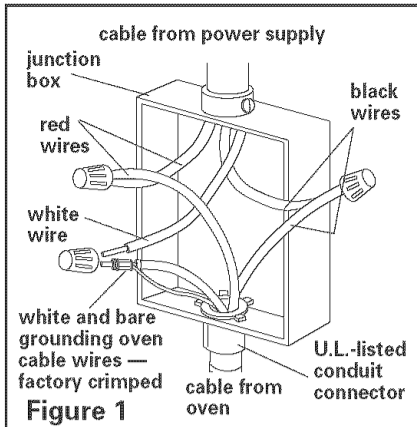

**Figure 1**

If local codes PERMIT connecting cabinet-grounding conductor to neutral white wire in junction box:

7. Connect the factory-cripped bare and white oven cable wires to the neutral (white) wire in junction box. See Figure 1.
8. Replace junction box cover.

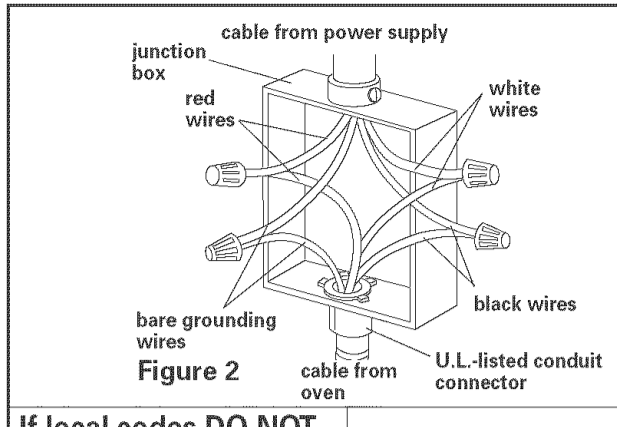

**Figure 2**

If local codes DO NOT PERMIT connecting cabinet-grounding conductor to neutral white wire in junction box:

7. Separate the factory-cripped bare and white oven cable wires.
8. Connect white oven cable wire to neutral (white) wire in junction box. See Figure 2.
9. Connect the bare grounding oven cable wire to a grounded wire in the junction box. See Figure 2.
10. Replace junction box cover.

If connecting to a four-wire electrical system:

7. Separate bare and white oven cable wires.
8. Connect white oven cable wire to neutral (white) wire in junction box. See Figure 2.
9. Connect the bare grounding oven cable wire to the green grounding wire in junction box. Do Not connect bare grounding wire to neutral (white) wire in junction box. See Figure 2.
10. Replace junction box cover.

## C Attachment

Carefully push against seal area of oven front frame when pushing oven into cabinet.

Do Not push against outside edges.

**5.** Lift oven into cabinet cutout using the oven opening as an area to grip.

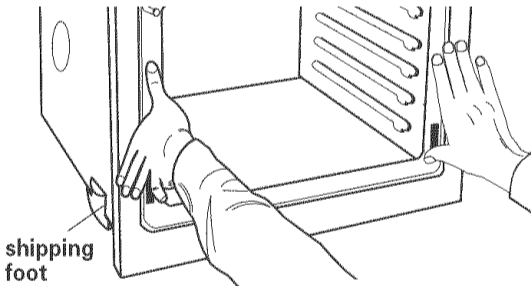

Push against seal area of front frame to push oven into cabinet until shipping feet almost contact cabinet. Use a Phillips screwdriver to remove screws attaching shipping feet. Remove and discard shipping feet.

Push oven completely into cabinet and center oven in cabinet cutout.

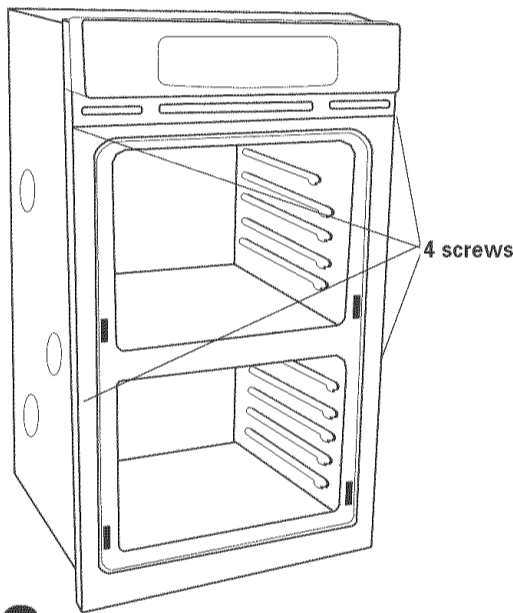

**6.** Important: Securely fasten oven to cabinet using the screws provided (two screws for a single oven or four screws for a double oven). Insert the screws through holes in mounting rails. Do Not overtighten screws.

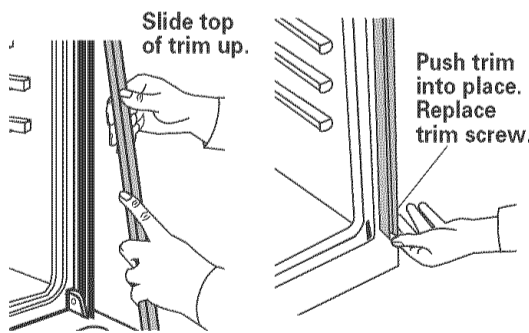

**7.** Slide top end of each trim upward onto oven side rails. Push each trim into place at bottom of trim. Use screws to attach each trim to oven. Take care not to scratch other surfaces with ends of trim.

**8.** Replace oven racks.

**9.** Reinstall the oven door by inserting ends of hinges into hinge slots in the oven frame. Push hinges in as far as they will go. Open the door (you will feel the door drop into place) and rotate both hinge latches back to the locked position.

Close and open the door to check that the door closes and opens completely. If door does not close or open completely, repeat the door removal step and reinstall door as described above.

Repeat for lower oven door.

## D Check operation

**10.** Turn on power supply. The display panel will light up briefly. "PF" should appear in the temperature display.

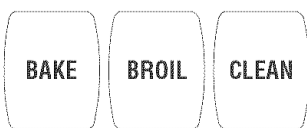

**11.** Check the operation of your single oven.

Press the "BROIL" pad. "BROIL" will appear in the display. Press the "START" pad.

Make sure the oven door is closed and the "ON" light is shown in the display area. After 2 minutes, partially open oven door. You should feel heat from the oven. Press the "CANCEL" pad.

Check the operation of your double oven.

Press the "Upper Oven" pad. Press the "BROIL" pad. "BROIL" will appear in the display. Press the "START" pad. Make sure the oven door is closed and the "ON" light is shown in the display area. After 2 minutes, partially open oven door. You should feel heat from the oven. Press the "CANCEL" pad.

Press the "Lower Oven" pad and repeat the steps you completed for checking the upper oven.

If your oven does not heat or an "F", followed by a number, appears in the display, contact your dealer or check the "If you need service..." section of this Installation Instructions.

To get the most efficient use from your new oven, read your Use and Care Guide. Keep Installation Instructions and Guide close to oven for easy reference.

## If oven does not operate:

- Check that circuit breaker is not tripped or house fuse blown.
- See Use and Care Guide for troubleshooting list.

## If you need assistance:

If you have questions about operating, cleaning or maintaining your oven:

- Refer to **Use and Care Guide**.
- Call the Consumer Assistance Center: Check your Use and Care Guide for a toll-free number to call or call the dealer from whom you purchased this appliance. The dealer is listed in the Yellow Pages of your phone directory under "Appliances — Household — Major — Service and Repair."

## If you need service:

Maintain the quality built into your built-in oven by calling an authorized service company. To obtain the name and number of an authorized service company:

- Contact the dealer from whom you purchased your built-in oven; or
- Look in the Yellow Pages of your telephone directory under "Appliances — Household — Major — Service and Repair" for an authorized service company; or
- Call the Consumer Assistance Center. The toll-free phone number is listed in your Use and Care Guide.

When you call, you will need:

- The built-in oven model number.
- The built-in oven serial number.

Both numbers are listed on the model/serial rating plate, located on the oven door or on the oven frame.