

Fisher & Paykel

READ AND SAVE THESE INSTRUCTIONS

Titan Canopy

88433 RH361
88434 RH361M

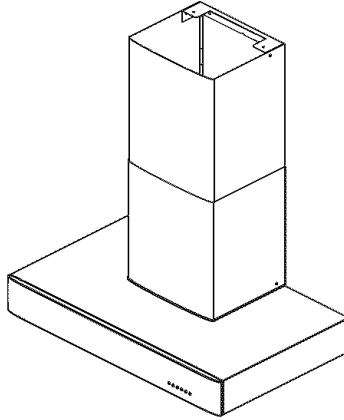

READ ENTIRE INSTRUCTIONS
BEFORE INSTALLATION.

PRODUCT DIMENSIONS

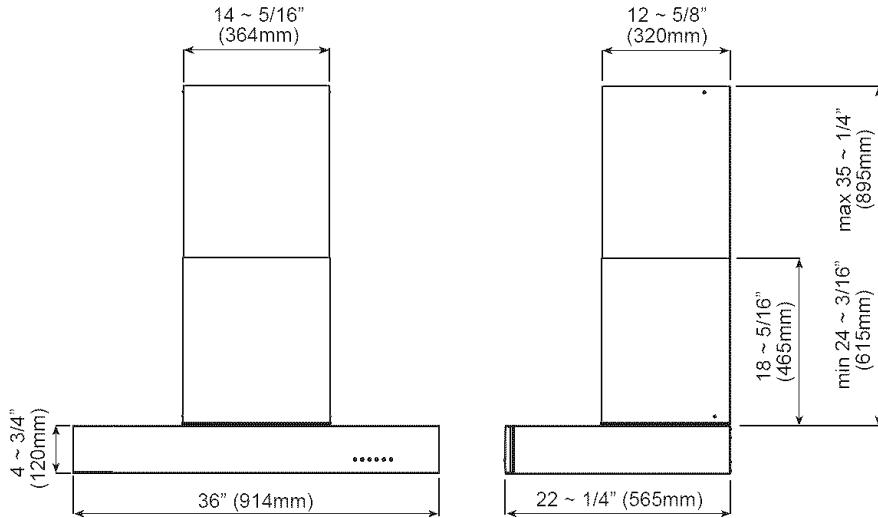

PRE-INSTALLATION INSTRUCTIONS

Thank you for purchasing a quality stainless steel or iridium canopy rangehood. We have a high standard of quality control and each rangehood is tested and approved before it leaves the factory.

WARNING - TO REDUCE THE RISK OF FIRE, ELECTRIC SHOCK, OR INJURY TO PERSONS, OBSERVE THE FOLLOWING:

- Use this unit only in the manner intended by the manufacturer. If you have any questions, contact the manufacturer.
- Installation work and electrical wiring must be done by qualified person(s) in accordance with all applicable codes and standards, including fire-rated construction.

- c) Warning - Remove transport tape from the lights and the filters before use.
- d) Sufficient air is needed to provide proper combustion and exhausting of gases through the flue (chimney) of fuel burning equipment to prevent back draughting. Follow the heating equipment manufacturer's guideline and safety standards such as those published by the National Fire Protection Association (NFPA), and the American Society for Heating, Refrigeration and Air Conditioning Engineers (ASHRAE), and the local code authorities.
- e) When cutting or drilling into wall or ceiling, do not damage electrical wiring and other hidden utilities.
- f) This appliance **must** always be vented to the outdoors.
- g) The canopy is heavy; overall weight 65 lbs (29kg). Please ensure adequate care when installing the canopy to prevent personal injury. The canopy must be installed onto a solid wall or solid studs.
- h) Before servicing or cleaning unit, switch power off at the service panel and lock the service disconnection means to prevent power from being switched on accidentally. When the service disconnection means cannot be locked, securely fasten a prominent warning device, such as a tag, to the service panel.
- i) **WARNING - TO REDUCE THE RISK OF FIRE, USE ONLY METAL DUCTWORK.**
WARNING - GROUNDING INSTRUCTIONS
 - a) This appliance must be grounded. In the event of an electrical short circuit, grounding reduces the risk of electrical shock by providing an escape wire for the electric current. This appliance is equipped with a cord having a grounding wire with a grounding plug. To provide protection against electric shock the plug must only be plugged into an outlet that is properly installed and grounded.
 - b) **WARNING - Improper grounding can result in a risk of electric shock.**
 - c) Appliance to be connected to a 15/20A circuit breaker.
 - d) Consult a qualified electrician if the grounding instructions are not completely understood, or if doubt exists as to whether the appliance is properly grounded.
 - e) Do not use an extension cord. If the power supply cord is too short, have a qualified electrician install an outlet near the appliance.

INSTALLATION INSTRUCTIONS

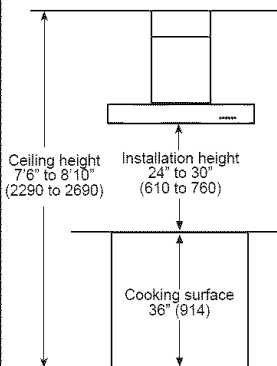

NOTE: Stainless steel and iridium is very easily damaged during installation if abraded or knocked by tools.

Read the instructions before starting the assembly. Remove the filters to allow access to wall mounting holes.

The unit is designed for ceilings 7' 6" to 8' 10" (2290 to 2690mm) high. The chimney is telescopic and is designed to adjust between 25~1/2" and 35~1/2" (650 to 900mm).

Ascertain the desired installation height of the canopy. **NOTE:** Installation height ranges from 24" to 30" (610 to 760mm).

DUCTING: Ducting accessories are not supplied. The air outlet from the adaptor (attached to the motor) is 7" (178mm). 7" (178mm) ducting will require a clearance hole of 7~5/16" (186mm) in the ceiling.

INSTALLING MOUNTING BRACKET (See diag. 1 on following page)

Align the center of the installation bracket with the center of the cooking surface (use of plumb bob recommend). Place the flat/horizontal surface of the mounting bracket 8~1/2" (216mm) above the installation height (diag.1). Ensuring the mounting bracket is level, mark and drill the holes in the wall. Use the screws and plugs provided to attach bracket.

INSTALLING CHIMNEY BRACKET

Cut cornice to suit the chimney cover. Align the center of the chimney bracket with the center of the cooking surface. Mark and drill the holes in the wall and ceiling. Use the mounting screws and anchors provided.

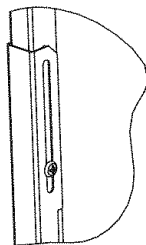
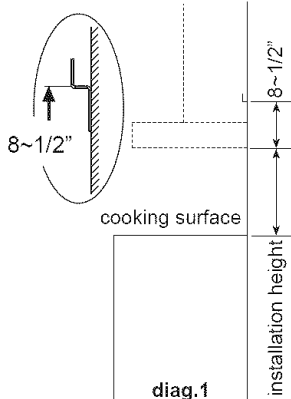

diag.2

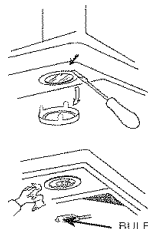

diag.4

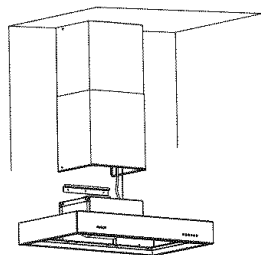

diag.3

INSTALLING THE CHIMNEY

A rubber extrusion has been provided to hide any irregularities between the chimney and the canopy, it is fitted by simply pushing it over the bottom visible edges of the chimney. This steel edge may be sharp so care must be taken to avoid damage to fingers. If desired the extrusion may be omitted from the assembly.

Remove the protective plastic film from the chimney. Prior to mounting, determine the height required on the chimney. The height can be adjusted by changing the screw on the back lip (diag.2). Do not tighten the screws because the chimney needs to slide up when installing the canopy. Mount the chimney to the ceiling bracket using the screws provided.

INSTALLING THE CANOPY

Ensure the filters are removed from the canopy. Hang the canopy onto the installation bracket. Align the canopy so it is central to the cooking surface and lines up with the chimney cover. Mark out the position of the two safety screw holes located on the back panel. Remove the canopy, drill the safety screw holes and fit wall plugs. Refit the canopy to the wall and secure using the appropriate mounting screws (diag.3). Remove the protective plastic film from the canopy and filters. Refit the filters to the canopy.

OPERATION INSTRUCTIONS

CONTROL PANEL



Fan On/Off



Mid Speed



High Speed



Delay Switch



Light On/Off

Delay switch - Fan will remain on at low, mid or high speed for 5 minutes before switching off automatically.

CLEANING INSTRUCTIONS

Care and attention should always be taken when cooking with oils, alcohol, etc, which give off flammable vapours. Pre-used oil is especially dangerous in this respect. Do not use an uncovered electrical grill. Particular care must be taken with grease filters which must be periodically cleaned, at least every two months. Remove the grease filters and wash them either by hand or in the dishwasher using mild detergent. Use lukewarm water and mild detergent to clean stainless steel/iridium components. In high humidity and coastal environments, cleaning should be carried out frequently. CAUTION: Never use abrasive or oil based liquid cleaners.

LIGHT REPLACEMENT (See diag. 4)

Disconnect the power to the rangehood. Using a small bladed screwdriver prise off the light cover. If the bulb is hot use a cloth to remove the bulb. Replace with a new bulb using a cloth. Do not touch the new bulb with your fingers as the grease from your fingers will crack the bulb when it is switched on. "Snap" the cover back in place. A halogen bulb 12Volt/20Watt is required.

For other accessories, parts or service, please contact your local supplier (Refer to the Warranty Certificate).

WARNINGS

Remove transport tape from the lights and the filters before use.

This appliance is not intended for use by young children or infirm persons without supervision.

Young children should be supervised to ensure that they do not play with the appliance.

Upon installation the appliance must be positioned so that the plug is accessible.

There should be adequate ventilation of the room when the rangehood is used at the same time as appliances burning gas or other fuels.

You must read the details concerning the method and frequency of cleaning.

There is a fire risk if cleaning is not carried out in accordance with the instructions.

Exhaust air must not be discharged into an existing flue used for exhausting fumes from appliances burning gas or other fuels.

The recommended minimum distance between the hob surface and the lowest part of the rangehood is 24" (610mm). This should be increased to at least 26" (660mm) (preferably 27" (685mm)) if installed over a gas hob.

Attention should be given to ensure that any applicable regulations concerning the discharge of exhaust air is fulfilled.

If the supply cord of this equipment is damaged, it must only be replaced by the manufacturer or its service agent, or a similarly qualified person in order to avoid a hazard.

WARNING - TO REDUCE THE RISK OF FIRE, USE ONLY METAL DUCTWORK.

WARNING - TO REDUCE THE RISK OF A RANGE TOP GREASE FIRE:

Never have surface units unattended at high settings. Boilovers cause smoking and greasy spillovers that may ignite. Heat oils slowly on low or medium settings.

Always turn hood ON when cooking at high heat or when flambéing food (ie crepes suzette, cherries jubilee, peppercorn beef flambé etc).

Clean ventilating fans frequently. Grease should not be allowed to accumulate on fan or filters.

Use proper pan size. Always use cookware appropriate for the size of the surface element.

WARNING - TO REDUCE THE RISK OF INJURY TO THE PERSONS IN THE EVENT OF A RANGE TOP GREASE FIRE, OBSERVE THE FOLLOWING: *

a) **SMOTHER FLAMES** with a close-fitting lid, cookie sheet, or metal tray and then turn off the burner.

BE CAREFUL TO PREVENT BURNS. If the flames do not go out immediately, **EVACUATE AND CALL THE FIRE DEPARTMENT.**

b) **NEVER PICK UP A FLAMING PAN** - you may be burned.

c) **DO NOT USE WATER**, including wet dishcloths or towels - a violent steam explosion will result.

d) Use an extinguisher **ONLY** if:

- 1) You know you have a Class ABC extinguisher and you already know how to operate it.
- 2) The fire is small and contained in the area where it started.
- 3) The fire department is being called.
- 4) You can fight the fire with your back to an exit.

Use only with rangehood cord-connection kits that have been investigated and found acceptable for use with this model of rangehood.

* Based on "Kitchen Fire Safety Tips" published by NFPA.

Fisher & Paykel

Fisher & Paykel Appliances, Inc.
27 Hubble, Irvine, CA 92618

Toll Free 1-888-9-FNP-USA (1-888-9-367-872)

MANUFACTURED FOR

Fisher & Paykel

BY:

ROBINHOOD LIMITED
6 ZELANIAN DRIVE, EAST TAMAKI
AUCKLAND, NEW ZEALAND
ISO9001 Certified

Electrical Rating

120V/60Hz/430W/3.57Amp

110V/50Hz/380W/3.44Amp

104613 issue C
ECN: 04 099