

TOSHIBA DVD VIDEO RECORDER D-R4SU/D-R4SC/D-KR4SU

**TOSHIBA**



DVD VIDEO RECORDER

# D-R4SU D-R4SC D-KR4SU

OWNER'S MANUAL



**OPERATIONS  
GUIDE**

Read "INSTALLATION GUIDE" first.

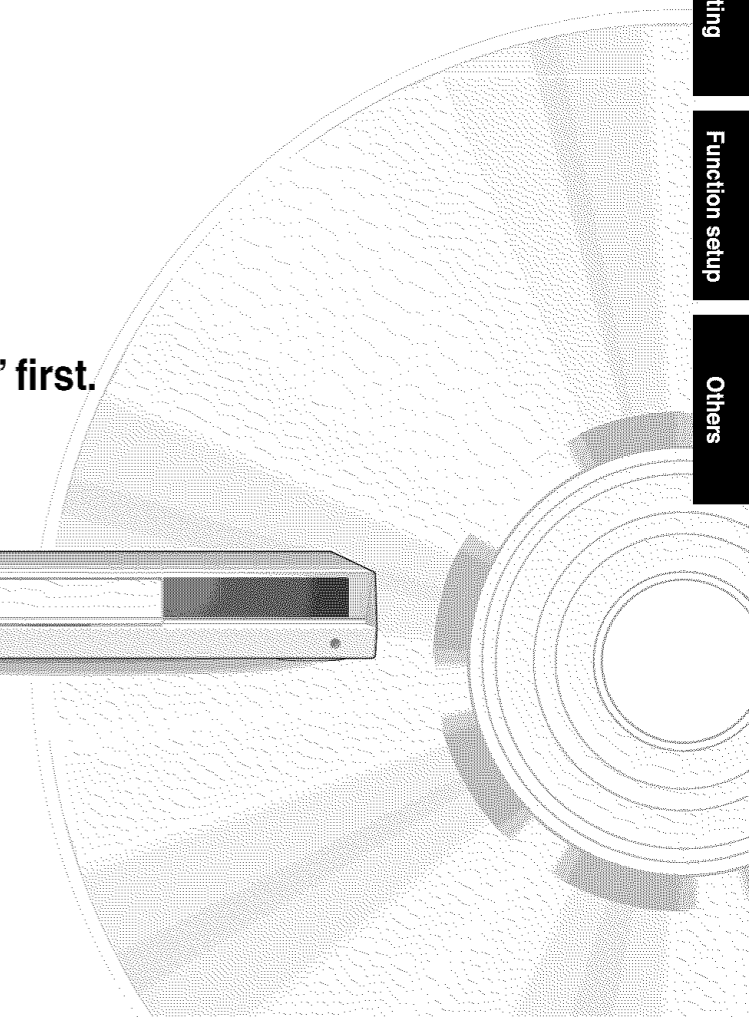
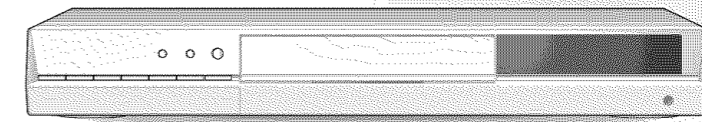

Introduction  
Recording  
Playback  
Editing  
Function setup  
Others

**TOSHIBA**

# Table of Contents

## Introduction

|  |    |
|--|----|
| ■ <b>Caution for safety</b> .....                      | 4  |
| ■ <b>About this product</b> .....                      | 5  |
| ■ <b>Choosing a disc</b> .....                         | 6  |
| ■ <b>Index to parts and controls</b> .....             | 12 |
| Front panel .....                                      | 12 |
| Rear panel .....                                       | 14 |
| Remote control .....                                   | 16 |
| Display .....  | 18 |
| ■ <b>Before operating this recorder</b> .....          | 20 |
| ■ <b>Key operation - EASY NAVI &amp; QUICK MENU</b> .. | 23 |

## Recording

|   |    |
|---|----|
| ■ <b>Before recording</b> .....   | 26 |
| Initializing a DVD-RAM/RW disc (Logical format) ....                            | 28 |
| DVD-RAM physical format .....   | 29 |
| Entering characters .....   | 30 |
| ■ <b>Selecting a disc according to purposes of use (DVD-RAM/DVD-R/RW)</b> ..... | 32 |
| ■ <b>Setting for recording on a DVD-R/RW disc in Video mode</b> .....           | 33 |
| ■ <b>Recording a TV program</b> .....   | 34 |
| ■ <b>Recording an external source</b> .....                                     | 38 |
| ■ <b>Programming a recording</b> .....  | 41 |
| ■ <b>Others</b> .....   | 47 |
| To delete recorded content .....  | 47 |
| To protect recorded content .....   | 47 |
| Technical information .....   | 48 |

## Playback

|   |    |
|---|----|
| ■ <b>Information on playback</b> .....                                    | 50 |
| ■ <b>Playing recorded contents</b> .....                                  | 51 |
| ■ <b>Playing a DVD video disc</b> .....                                   | 55 |
| Locating a title using the top menu .....                                 | 56 |
| ■ <b>Pausing a TV broadcast to resume later (Pause TV)</b> .....          | 57 |
| ■ <b>Playing a TV program currently being recorded (Chase Play)</b> ..... | 58 |

|   |    |
|---|----|
| ■ <b>Playing at various speeds</b> .....                                      | 59 |
| Playing in fast reverse or fast forward .....                                 | 59 |
| Skipping to the next/previous chapter or track .....                          | 60 |
| Playing in slow-motion .....  | 60 |
| Playing frame by frame .....  | 61 |
| Viewing still pictures<br>(Playing a disc that contains still pictures) ..... | 61 |
| ■ <b>Locating by entering the number</b> .....                                | 62 |
| Locating by entering the number of a desired section .....                    | 62 |
| Locating a specific point by entering its elapsed time (Time Search) .....    | 63 |
| ■ <b>Selecting the camera angle</b> .....                                     | 64 |
| ■ <b>Selecting subtitles</b> .....  | 65 |
| ■ <b>Zooming a picture</b> .....  | 66 |
| ■ <b>Selecting the sound</b> .....  | 67 |
| ■ <b>Viewing JPEG files</b> .....   | 70 |
| JPEG files compatibility .....  | 71 |
| ■ <b>Playing MP3/WMA files</b> .....  | 72 |
| Playable files .....  | 73 |
| ■ <b>Pausing a TV broadcast (Freeze function)</b> .....                       | 74 |
| ■ <b>Checking the current status and settings</b> .....                       | 75 |
| Operational status and setting details .....                                  | 75 |
| Using the time bar .....  | 76 |
| ■ <b>Functions in Quick Menu</b> .....  | 77 |

## Editing

|  |     |
|--|-----|
| ■ <b>Before editing</b> .....  | 82  |
| ■ <b>Creating chapters</b> .....   | 84  |
| ■ <b>Playlist editing (Collecting desired scenes)</b> .....                | 89  |
| ■ <b>Creating thumbnails (Changing the picture on CONTENT MENU)</b> ..     | 93  |
| ■ <b>High speed dubbing (Dubbing only a specified part)</b> .....          | 96  |
| ■ <b>Deleting selected items (Deleting multiple specified parts)</b> ..... | 98  |
| ■ <b>DVD-Video finalizing process</b> .....                                | 100 |

## Function Setup

|   |     |
|---|-----|
| ■ Customizing the function settings ..... | 106 |
| DVD player settings .....                 | 110 |
| Picture/Audio settings .....              | 113 |
| Display settings .....                    | 115 |
| Operational settings .....                | 116 |
| DVD recorder operation .....              | 117 |
| Management settings .....                 | 119 |

## Others

|   |     |
|---|-----|
| ■ Before calling service personnel .....  | 122 |
| ■ Error codes on the display window ..... | 124 |
| ■ Recording duration .....                | 125 |
| ■ Language code list .....                | 126 |
| ■ Specification .....                     | 127 |
| ■ Limited United States Warranty .....    | 128 |
| ■ CANADIAN WARRANTY INFORMATION .....     | 130 |

# Caution for safety

Read “SAFETY PRECAUTIONS”, “IMPORTANT SAFETY INSTRUCTIONS”, and all other sections of the “INSTALLATION GUIDE” that came with this product prior to reading this “OPERATIONS GUIDE”.

# About this product

## Some differences

Because of its recording capacity, this DVD recorder operates more like a computer and differently than a standard DVD player. In addition to containing a microprocessor, it contains an operating system, random access memory (RAM), and a DVD-RAM/R/RW drive. The operating system includes software that is transferred to the RAM when the machine is turned on and at other times during operation. This transfer can take time. Therefore, when you turn the DVD recorder on, it may take a little while before it is ready to use. Likewise, other functions may not be performed as quickly as they would on other AV equipment. Additionally, accessing those programs (or deleting a program from a DVD-RAM or DVD-RW disc) may take more time. Please take these factors into consideration as you use the DVD recorder.

## Playback Restrictions

This owner's manual explains the basic instructions for this recorder. Some DVD video discs are produced in a manner that allows specific or limited operation during playback. As such, the recorder may not respond to all operating commands. This is not a defect in the recorder. Please refer to the notes on compatible discs later in this Introduction and to the discussion of DVD playback and features later in this manual.

“Ⓢ” may appear on the TV screen during operation. “Ⓢ” means that the operation is not permitted by the recorder or the disc.

## Recording Restrictions and Copyright

Copy-protected contents of DVD-Video discs, VIDEO CDs or audio CDs on the market cannot be copied on this recorder. Contents without copy protection should be copied or edited only in accordance with applicable copyright laws, which may restrict copying or editing. Contents that permit single copying (copy once contents) can be recorded onto DVD-RAM discs, with some dubbing and editing restrictions. DVD-R/RW discs cannot record these contents.

The unauthorized recording, use, distribution, or revision of copyrighted materials including, without limitation, television programs, videotapes, and DVDs, is prohibited under the Copyright Laws of the United States and other countries, and may subject you to civil and criminal liability.

## Compatibility

In isolated cases, a disc bearing the DVD or CD logo may not fully and properly play back all features or as intended by the creator of the disc. This can be due, among other reasons, to problems and errors that can occur during the creation or recording of DVD and other software and the manufacture of software discs (including blank discs). Moreover, because of variations in the quality of discs, this recorder may not be able to record on all discs that bear a DVD-RAM, DVD-R or DVD-RW logo, but you should not encounter difficulty if you use only high quality recordable DVD discs. Additionally, discs recorded in this device may not operate properly in other DVD players, recorders and/or personal computer drives. If you happen to encounter difficulties playing or recording a DVD disc or playing a CD disc, please feel free to call our Customer Service Hotline at 1-800-319-6684.



# Choosing a disc

There are many types and formats of discs. Please use the following information to select an appropriate disc.

## Notes

- Handle the disc according to the disc instruction manual.
- Toshiba cannot guarantee that all discs bearing the DVD or CD logos will operate as expected. Additionally, Toshiba cannot guarantee that discs recorded in this device will operate properly in other DVD players, recorders and/or personal computer drives.

## For recording / playback

| Disc    | Mark   | Specification  | Remarks  |
|---------|--|--|--|
| DVD-RAM |   | <ul style="list-style-type: none"> <li>• Single sided 4.7GB (12cm (4<sup>3</sup>/<sub>4</sub> in.))</li> <li>• Double sided 9.4GB (12cm (4<sup>3</sup>/<sub>4</sub> in.))</li> </ul> | <p>Read carefully the section “On DVD-RAM discs” (➡ page 8).</p> <p>Select a DVD-RAM disc that shows a statement on its package such as “this disc can be used with video recorders and drives compatible with 4.7GB DVD-RAM discs” or “this disc can copy images that permit single copying.”</p> |
| DVD-R   |   | <ul style="list-style-type: none"> <li>• 4.7GB For General Ver.2.0 (12cm (4<sup>3</sup>/<sub>4</sub> in.))</li> </ul>  | <p>Read carefully the section “On DVD-R discs” (➡ page 9).</p> <p>Depending on the disc status or the recording equipment, playback of the disc may not be possible on this recorder.</p>  |
| DVD-RW  |  | <ul style="list-style-type: none"> <li>• Ver. 1.1 or later (12cm (4<sup>3</sup>/<sub>4</sub> in.))</li> </ul>  | <p>Read carefully the section “On DVD-RW discs” (➡ page 9).</p> <p>Depending on the disc status or the recording equipment, playback of the disc may not be possible on this recorder.</p>   |

## Using different disc types for different purposes

### DVD-RAM discs for your personal library

DVD-RAM discs comply with the global standard DVD-VR (Video Recording) format, and are optimized for recording of TV programs. You can rewrite repeatedly without deterioration of an image quality, erase unnecessary parts, divide a chapter, or specify playback area by frame. Its cartridge is suitable for a longer-term storage and family use, and its large capacity of 9.4 GB allows more recording space.

### DVD-R discs when creating your own original discs for distribution









DVD-R discs are designed to comply with the global standard DVD-Video format, and can be recorded only once. DVD-R discs are convenient when you edit your original content (recorded personal events such as a wedding party) with this recorder, transfer them to the recorder and make copies to send to your friends or relatives. The discs can be played on other compatible DVD players. DVD-RW discs, which are rewriteable, can be used as well.



\* DVD-R and DVD-RW may not be the best suited format for recording TV programs. Because of the way the discs are formatted, it may not be possible to edit or divide the program as you may prefer, to record secondary languages, or programs that are copy protected in a way that allows only one copy. (NOTE: “Copy once” protected programs generally can be recorded to DVD-RAM discs.)

\* This recorder records on a DVD-R/RW disc in DVD-Video format only. In DVD-VR format, recording is not possible.

We cannot guarantee that DVD-RAM/R/RW discs recorded on this recorder will be playable on all DVD recorders/players. Similarly, there is no guarantee that all DVD-RAM/R/RW discs recorded on other recorders will be playable on this recorder.

## For playback only

| Disc           | Mark  | Specification  | Remarks  |
|----------------|---|--|--|
| DVD video disc |    | <ul style="list-style-type: none"> <li>• 12cm (4<sup>3</sup>/<sub>4</sub> in.)</li> <li>• Region number</li> </ul>  or  <ul style="list-style-type: none"> <li>• Color system: NTSC</li> </ul> | <p>The region number of this DVD recorder is 1. If region numbers, corresponding to a specific playable area, are printed on your DVD video disc and you do not find  or , or the disc is encoded to permit playback only in regions other than Region 1, disc playback will not be allowed by the recorder.</p> |
| VIDEO CD       |    | <ul style="list-style-type: none"> <li>• 12cm (4<sup>3</sup>/<sub>4</sub> in.)</li> <li>• Color system: NTSC</li> <li>• Version 1.1 and 2.0</li> </ul>   |  |
| Audio CD       |    | <ul style="list-style-type: none"> <li>• 12cm (4<sup>3</sup>/<sub>4</sub> in.)</li> </ul>  |  |
| CD-R           |    | <ul style="list-style-type: none"> <li>• 12cm (4<sup>3</sup>/<sub>4</sub> in.)</li> <li>• CD-DA (audio CD) format</li> </ul>   | Depending on the disc status, playback may not be possible.  |
| CD-RW          |  |  |  |

- You cannot play discs other than those listed above.
- You cannot play non-standardized discs even if they may be labeled as above.
- You cannot play discs with specialized encoding (such as SACD discs) or the DVD audio portions of DVD Audio discs.
- This recorder uses the NTSC color system, and cannot play DVD video discs recorded in any other color system (PAL, SECAM, etc.), even if they have region marks  or .
- Toshiba cannot assure that all discs bearing the DVD or CD logos will operate as expected. Please see the discussion of compatibility on page 5.

- Toshiba is not liable for any damage or loss caused directly or indirectly by the malfunction of this recorder, including, without limitation, any one of the following:
  - Failure to record contents intended to be recorded by the consumer.
  - Failure to edit contents as intended by the consumer.
  - When a DVD-RAM/R/RW disc created on this recorder is used (e.g., insertion, playback, recording or editing) in another DVD player, recorder or personal computer drive.
  - When a DVD-RAM/R/RW disc that is used in the manner described in the immediately preceding bullet point is used again in this recorder.
  - When a DVD-RAM/R/RW disc that was recorded in another DVD recorder, or in a personal computer drive is used in this recorder.
- Discs recorded in this recorder may not operate as expected on other DVD players, recorders or personal computer drives.

## On DVD-RAM discs

### ■ Use only DVD-RAM discs that comply with DVD-RAM standard Version 2.0, 2.1 or 2.2.

The recorder cannot record on a disc formatted in any other standard. When using such a disc, initialize it by using the disc-format function of this recorder.

- The recorder may not record, dub, or edit some DVD-RAM discs, because they are edited/recorded with another manufacturer's equipment or PC, contain a large number of titles, or have little remaining capacity. Also, a DVD-RAM disc may not be edited or recorded if its title contains still pictures.
- DVD-RAM discs formatted in UDF2.0 on a PC are not compatible with this recorder. Before using these discs, initialize them on this recorder.
- This recorder complies with current copyright protection technology and can copy a disc only when the disc permits copying once. When there is no indication on the disc, copying will not be allowed.

### ■ DVD-RAM discs with cartridges are recommended for recording.

- Two types of DVD-RAM discs are available: ones with cartridges and ones without cartridges. You can use either of them with this recorder, but the former ones are recommended.

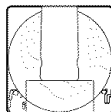

- In order to record highly detailed data, make sure the disc is clean. DVD-RAM discs with cartridges are easier to handle in this regard.
- Do not open the cartridge shutter. The disc may not play, or may not be recorded or edited once it becomes dirty.
- There are two types of DVD-RAM cartridges; removable (TYPE 2/4) and not removable (TYPE 1). It is recommended you do not remove the disc even when you can. Refer to the instruction manual that comes with the disc if it is absolutely necessary to remove the disc.
- Some commercially available cartridge discs cannot be recorded or edited once the inside discs are removed.

### ● To protect recorded contents

Slide the write-protect tab to "PROTECT" with something small enough. The disc can play, but cannot be edited or erased. Refer to the instructions that come with the disc.

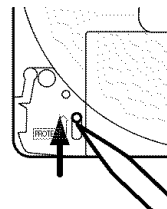

### ■ When using a disc without a cartridge (commercially available discs)

- Discs without cartridges can easily attract fingerprints and dust, which is the reason they are not recommended. If you cannot avoid using them, handle with proper care.
- When you write in a title column on a disc, use a pen with a soft tip. Do not use a pen with a hard tip, such as a ballpoint pen.



### Recommended discs

The following discs have been tested with this recorder:  
 9.4 GB double-sided cartridge: Panasonic 2X, 3X  
 4.7 GB single-sided cartridge: Panasonic 2X, 3X



## On DVD-R discs

### Standards

- DVD-R for General Ver.2.0 discs can be used for recording and playback.
- Discs compatible with 2X speed recording (labeled Ver.2.1/2X etc.) and discs compatible with 4X speed recording (labeled Ver.2.1/4X etc.) can also be used.
- Select discs labeled “for video,” “for recording,” “120 min.” etc.

### Recording conditions

- Images for which copying is prohibited or restricted (copy once or copy prohibited) cannot be recorded. Even if the disc is labeled as CPRM compatible, this recorder can only be used to record copy-free material.

### Recommended disc

That's (Taiyo-Yuden) 4X  
maxell 4X  
TDK 4X

## On DVD-RW discs

### Standards

- Discs labeled DVD-RW Ver.1.1 or 1.2 can be used.
- Discs compatible with 2X speed recording (labeled Ver.1.1/2X etc.) can also be used.
- Select discs labeled “for video,” “for recording,” “120 min.” etc.

### Recording conditions

- Images for which copying is prohibited or restricted (copy once or copy prohibited) cannot be recorded. Even if the disc is labeled as CPRM compatible, this recorder can only be used to record copy-free material.
- DVD-VR mode recording is not possible.





### Recommended discs\*

JVC 2X

\* Operation has been confirmed with recommended discs and tested disc, but some other discs may not be usable.

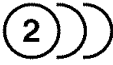
## Marks on DVD video discs

The following are examples of marks and the meanings.

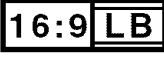
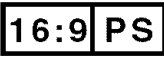
| Mark  | Meanings  |
|---|---|
|    | Number of audio streams recorded in the disc.<br>(2 streams such as English and Japanese in this example.)  |
|    | Number of subtitle languages recorded in the disc.<br>(2 subtitle languages are recorded in this example.)  |
|    | Number of camera angles recorded in the disc.<br>(3 camera angles are recorded in this example.)  |
|   | Pictures are recorded in the standard picture shape (4:3 aspect ratio).   |
|  |   |
|  | Pictures are recorded in the 16:9 wide picture shape.<br>TVs with 4:3 aspect ratio will display them in the letter box style.                                       |
|  | Pictures are recorded in the 16:9 wide picture shape.<br>TVs with 4:3 aspect ratio will display them in the pan scan style (one or both sides of pictures are cut). |
|   | Actual picture shape may vary depending on the aspect ratio or mode selection of the TV.  |

Choosing a disc (Continued)

**Structure of disc contents**

Normally, DVD video discs are divided into titles, and the titles are subdivided into chapters. VIDEO CDs/audio CDs are divided into tracks.

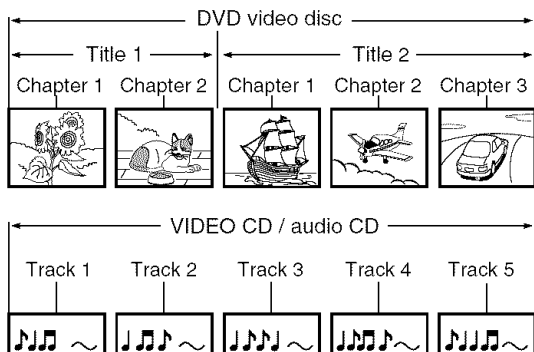

- Title:** Divided contents of a DVD video disc. Roughly corresponds to a story title in short stories.
- Chapter:** Divided contents of a title. This corresponds to a chapter in a story.
- Track:** Divided contents of a VIDEO CD or an audio CD.

Each title, chapter, or track is assigned a number, which is called "title number", "chapter number", or "track number" respectively. Some discs may not have these numbers.

When you record on a DVD-RAM/R/RW disc, one recording will always equal one title. You can divide a title into several chapters by marking borders in it to facilitate scene search.

**On handling discs**

- Do not touch the playback side of the disc.

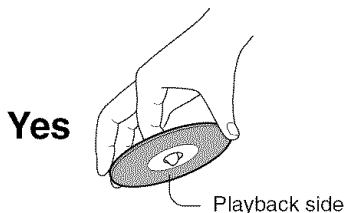

- Do not stick paper or tape to discs.



**On cleaning discs**

- Fingerprints and dust on the disc cause picture and sound deterioration. Wipe the disc from the center outwards with a soft cloth. Always keep the disc clean.



- Do not use any type of solvent such as thinner, benzene, commercially available cleaners or antistatic spray for vinyl LPs. It may damage the disc.

**On storing discs**

- Do not store discs in a place subject to direct sunlight or near heat sources.
- Do not store discs in places subject to moisture and dust such as a bathroom or near a humidifier.
- Store discs vertically in a case. Stacking or placing objects on discs outside of their case may cause warping.

## Discs and purposes

The table shows main functions which are available on this recorder per disc category. This will help you choose discs.

|   | DVD-RAM disc   | DVD-RW disc  | DVD-R disc  |
|---|--|--|---|
| Characteristics on this recorder  | Suitable for repeat use of the disc, and data storage for video library. Copy once contents can be recorded using a compatible disc. | Suitable for saving data in DVD-Video format to play on compatible devices.<br><br>You can erase recorded contents to use the disc repeatedly.   | Suitable for saving data in DVD-Video format to play on compatible devices.<br><br>Once you execute DVD-Video finalizing process on a recorded disc so that it can be played on other players, you cannot make addition, correction and deletion of contents on the disc. |
| For the first use   | No preparatory steps required, however initializing is recommended.  | Initialize the disc.   | No preparatory steps required.  |
| Recording a TV program  | Yes  | Yes  | Yes   |
| Erasing recorded contents   | Yes  | Yes<br>If the disc has been executed DVD-Video finalizing process, first cancel the process then delete contents.                                | Yes<br>Deleting contents cannot restore the disc space.<br><u>After you execute DVD-Video finalizing process on a recorded disc, you cannot delete contents of the disc.</u>  |
| Recording additional content on a recorded disc   | Yes  | Yes<br>If the disc has been executed DVD-Video finalizing process, first cancel the process then delete contents.                                | Yes<br><u>After you execute DVD-Video finalizing process on a recorded disc, you cannot add contents to the disc.</u>   |
| Indexing recorded contents<br>Naming a title<br>Creating a thumbnail                      | Yes<br>Yes   | Yes<br>Yes<br><u>After you execute DVD-Video finalizing process on a recorded disc, you cannot name a title or create a thumbnail.</u>           | Yes<br>Yes<br><u>After you execute DVD-Video finalizing process on a recorded disc, you cannot name a title or create a thumbnail.</u>  |
| Collecting favorite scenes (Playlist Editing)   | Yes  | No   | No  |
| Making a new title from a Playlist containing favorite scenes (Copy within the same disc) | Yes  | No   | No  |
| Playing contents recorded on this recorder, on other devices                              | Contents can be played on any devices compatible with DVD-RAM discs. Follow the instruction of the device to play.                   | Execute DVD-Video finalizing process on this recorder. This process makes the disc playable on other compatible devices. (Some models excepted.) | Execute DVD-Video finalizing process on this recorder. This process makes the disc playable on other compatible devices. (Some models excepted.)  |
| When a message appears and the loaded disc cannot be used:                                | Initialize the disc.<br>If it is still unusable, try to execute DVD-RAM physical Format.   | Initialize the disc.   | —   |

# Index to parts and controls

See pages with arrows for details.

## Front panel

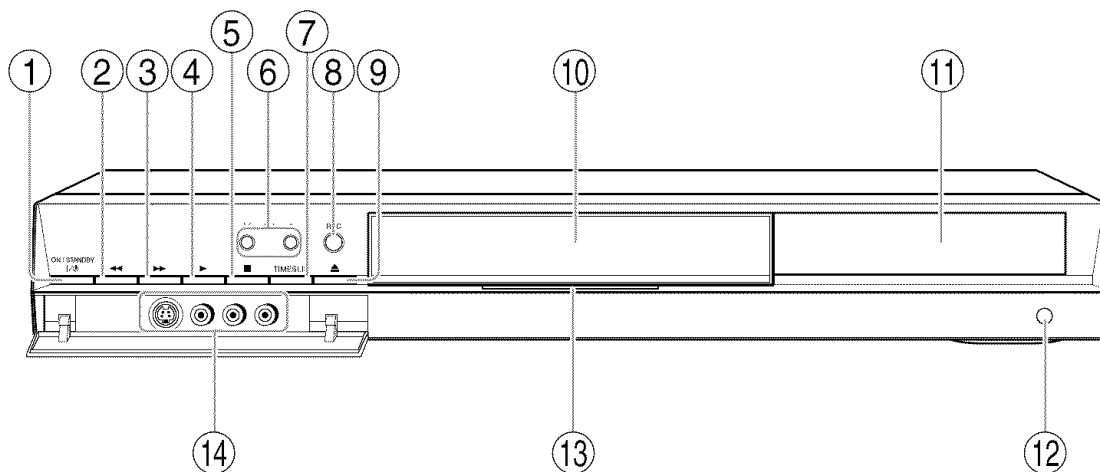

\* The above illustration displays the front panel with the cover open. See the following page on how to open or close the cover.

- |  |  |
|--|--|
| <p>① <b>ON/STANDBY button</b> ➡ <b>page 20, 21</b><br/>Turns the power on/restores the unit in the standby mode.</p> <p>② <b>◀ (REV) button</b> ➡ <b>page 59</b><br/>Scans the picture backwards.</p> <p>③ <b>▶▶ (FWD) button</b> ➡ <b>page 59</b><br/>Scans the picture forward.</p> <p>④ <b>▶ (PLAY) button</b> ➡ <b>page 55</b><br/>Starts playback.</p> <p>⑤ <b>■ (STOP) button</b> ➡ <b>page 37, 55</b><br/>Stops playback or recording.</p> <p>⑥ <b>CH buttons</b> ➡ <b>page 20, 34</b><br/>Selects the channel.</p> | <p>⑦ <b>TIMESLIP button</b> ➡ <b>page 57, 58</b><br/>Selects the time slip mode.</p> <p>⑧ <b>REC button</b> ➡ <b>page 35</b><br/>Starts recording.</p> <p>⑨ <b>▲ (OPEN/CLOSE) button</b> ➡ <b>page 20, 21</b><br/>Opens and closes the disc tray.</p> <p>⑩ <b>Disc tray</b> ➡ <b>page 20</b><br/>Loads a disc into the disc drive.</p> <p>⑪ <b>Front panel display</b> ➡ <b>page 18</b></p> <p>⑫ <b>Remote sensor</b> ➡ <b>page 18 in "INSTALLATION GUIDE"</b></p> <p>⑬ <b>LED</b> ➡ <b>page 20, 21</b><br/>Illuminates when the recorder is on.</p> |
|--|--|

**⑭ INPUT 2 jacks** ➡ **page 38**

Use this when recording from other input source such as a VCR or a camcorder.

**■ To open or close the cover on the front panel**

Put your finger on the left edge of the cover and pull it down to open.

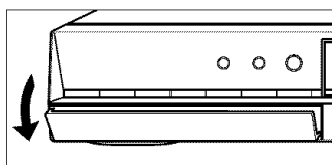
**Note**

- Do not place a heavy object on the cover while it is open. Doing so may damage the recorder.

## Rear panel

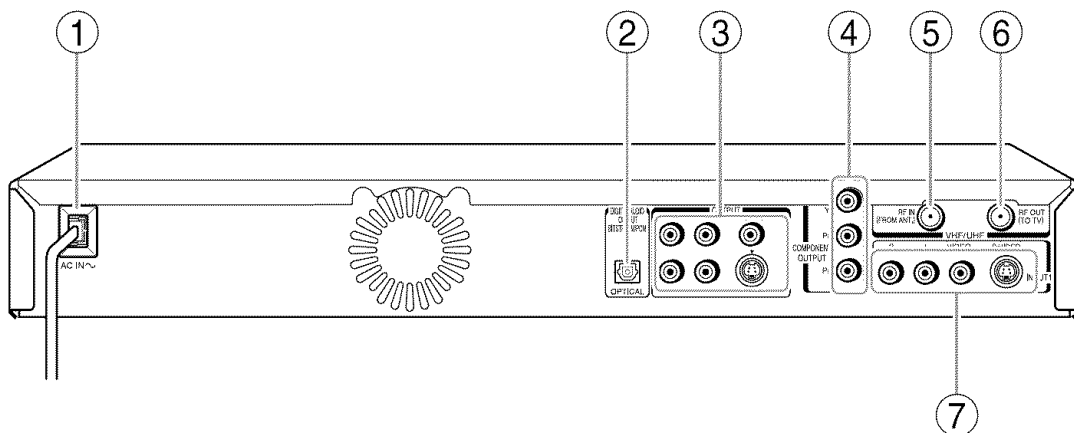

- ① **Power cord** ➔ page 21 in “INSTALLATION GUIDE”
- ② **DIGITAL AUDIO OUT BITSTREAM/PCM OPTICAL jack** ➔ page 26 in “INSTALLATION GUIDE”  
Use this to connect the recorder to an audio receiver equipped with an optical digital audio input jack.
- ③ **OUTPUT jacks** ➔ page 21, 23, 24, 25 in “INSTALLATION GUIDE”  
Outputs video and audio signals to a connected TV or amplifier.
- ④ **COMPONENT OUTPUT jacks** ➔ page 25 in “INSTALLATION GUIDE”  
Outputs video signals to a connected TV or monitor.  
Connects to a TV or monitor equipped with component video jacks.
- ⑤ **VHF/UHF RF IN (FROM ANT.) input socket** ➔ page 20 in “INSTALLATION GUIDE”  
Connects to an antenna or cable signal.
- ⑥ **VHF/UHF RF OUT (TO TV) output socket** ➔ page 20 in “INSTALLATION GUIDE”  
Connects the supplied coaxial cable to a TV.

⑦ **INPUT1 jacks**  **page 38**

Use this to connect the recorder to output jacks of external devices such as another player or camcorder.

Remote control

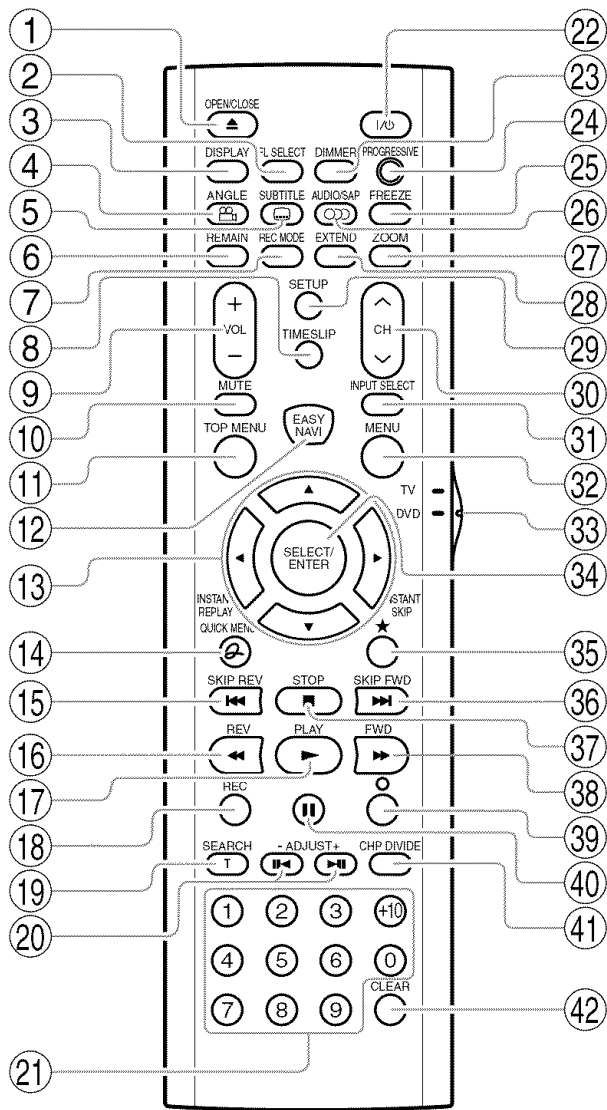



- ① OPEN/CLOSE button ➡ page 20, 21
- ② FL SELECT button ➡ page 19
- ③ DISPLAY button ➡ page 75
- ④ ANGLE button ➡ page 64
- ⑤ SUBTITLE button ➡ page 65
- ⑥ REMAIN button ➡ page 27
- ⑦ REC MODE button ➡ page 36
- ⑧ TIMESLIP button ➡ page 57, 58
- ⑨ VOL button\*<sup>2</sup>
- ⑩ MUTE button\*<sup>2</sup>
- ⑪ TOP MENU button ➡ page 56
- ⑫ EASY NAVI button ➡ page 23
- ⑬ Direction buttons (▲/▼/◀/▶) ➡ page 51, 106
- ⑭ QUICK MENU button ➡ page 24, 77
- ⑮ SKIP REV button ➡ page 60
- ⑯ REV button ➡ page 59
- ⑰ PLAY button ➡ page 55
- ⑱ REC button ➡ page 35
- ⑲ SEARCH button ➡ page 62
- ⑳ ADJUST buttons ➡ page 41, 61
- ㉑ Number buttons ➡ page 34, 62
- ㉒ ON/STANDBY button\*<sup>2</sup> ➡ page 20, 21
- ㉓ DIMMER button ➡ page 19
- ㉔ PROGRESSIVE button ➡ page 25 in "INSTALLATION GUIDE"
- ㉕ FREEZE button ➡ page 74
- ㉖ AUDIO/SAP button ➡ page 67
- ㉗ ZOOM button ➡ page 66
- ㉘ EXTEND button ➡ page 44, 46
- ㉙ SETUP button ➡ page 106
- ㉚ CH button\*<sup>2</sup> ➡ page 20, 34
- ㉛ INPUT SELECT button\*<sup>2</sup> ➡ page 39
- ㉜ MENU button\*<sup>1</sup>
- ㉝ TV/DVD selector ➡ page 42 in "INSTALLATION GUIDE"
- ㉞ SELECT/ENTER button ➡ page 51, 106
- ㉟ ★ button ➡ page 51
- ㊱ SKIP FWD button ➡ page 60
- ㊲ STOP button ➡ page 39
- ㊳ FWD button ➡ page 59
- ㊴ O button ➡ page 106
- ㊵ || button ➡ page 37, 52
- ㊶ CHP DIVIDE button ➡ page 84
- ㊷ CLEAR button ➡ page 62

\*<sup>1</sup> MENU

Use this to display a menu screen that is recorded on a DVD video disc.

Operate the menu screen as the same manner as "Locating a title using the top menu (➡ page 56)". A menu screen is not recorded on some discs.

\*<sup>2</sup> Buttons for TV operation ➡ page 42 in "INSTALLATION GUIDE".

## Display

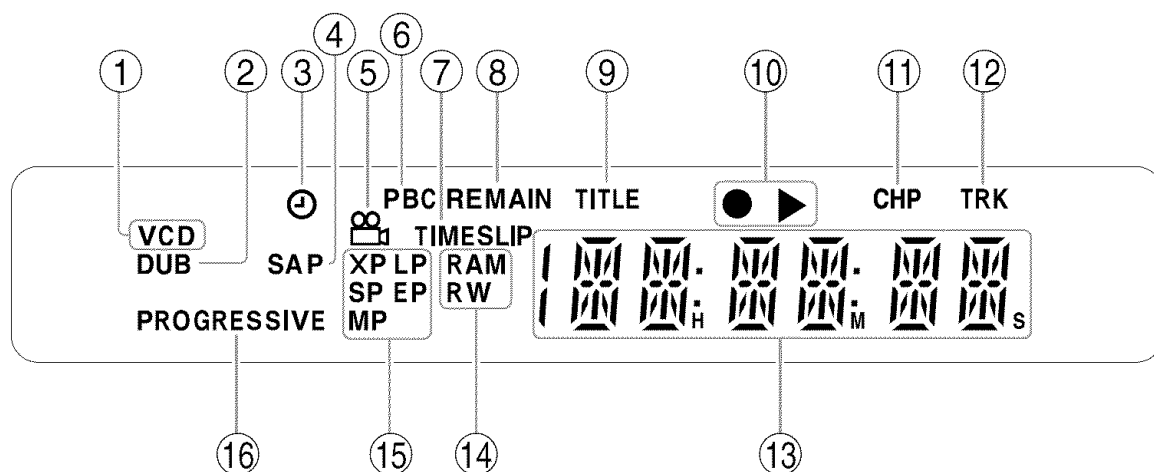

**① Disc indicator**

Indicates the category of a loaded disc.

CD : audio CD  
VCD : VIDEO CD

**② DUB indicator**

Illuminates when copying.

**③ Program recording indicator**

Illuminates when the recorder holds a timer program.

**④ SAP indicator**

Illuminates when receiving a SAP broadcast.

**⑤ Angle icon** ➡ **page 64**

Illuminates when playing a scene recorded with multi angles.

**⑥ PBC indicator**

Illuminates when a PBC-controllable VIDEO CD is loaded.

**⑦ TIMESLIP indicator** ➡ **page 57, 58**

Illuminates in the time slip mode.

**⑧ REMAIN (Remaining space) indicator**

Illuminates when an available recording time is displayed.

**⑨ Title indicator**

Illuminates when a title number is displayed.

**⑩ Operational status indicator**

Indicates the operational status of the recorder.

- : Illuminates when recording.
- ▶ : Illuminates when playing.
- ▶ : Illuminates when recording and playback are in progress at the same time.

**⑪ CHP (Chapter) indicator**

Illuminates when a chapter number is displayed.

**⑫ TRK (Track) indicator**

Illuminates when a track number is displayed.

**⑬ Multi display**

Displays the current channel or other numbers such as a title number, track number, input selection, the current time, elapsed time, remaining time, starting time of programmed recording, chapter number or message, etc.

### ■ Dimming the display

Pressing the DIMMER button on the remote control changes the brightness of the display (normal/dimmed). When dimming the display, the LED will be turned off.

### ■ Switching the display

Every time you press the FL SELECT button, the display changes between the channel, title number, and time. The display may not change, depending on the disc or recording conditions.

#### ⑭ Disc indicator

Indicates the category of a loaded disc.

RAM : DVD-RAM disc

RW : DVD-RW disc

R : DVD-R disc

#### ⑮ Picture quality mode indicator page 117

The current picture quality mode lights up.

#### ⑯ PROGRESSIVE indicator

Illuminates when video signals are output in the progressive format.

# Before operating this recorder

## ■ Is your recorder ready?

- Refer to "INSTALLATION GUIDE" and finish the necessary preparations.
- Turn on the connected equipment such as a TV or audio system and select the input from the recorder.

## ■ Turning the power on

(This owner's manual instructions are based on the premise that all proper connections have been completed and the TV is turned on.)

Press ON/STANDBY on the front panel of the recorder or on the remote control.

### ON/STANDBY button

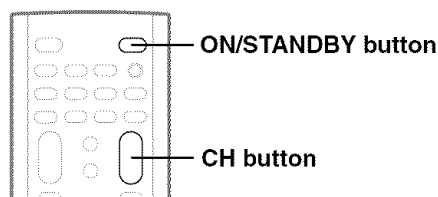
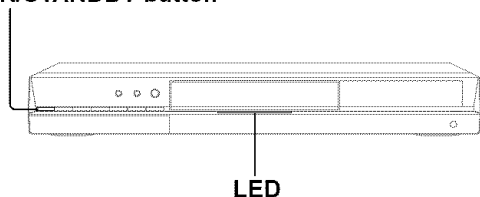

When the power turns on, the LED on the front panel illuminates.

After a few seconds, a start-up screen appears. The following icon appears at the top right corner of the screen.

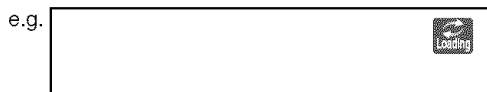

When this icon disappears, the recorder is ready to operate. If the disc drive contains a disc, it takes a little longer to start up.

## ■ Viewing TV channels through this recorder

After turning the power on, the recorder will output TV channel signals to the connected TV (also in the stop mode).

You can select a desired channel by pressing the CH button, or the number buttons.

## ■ Loading a disc

Check disc compatibility beforehand (➡ page 6, 7) and use a proper playable disc.

### Caution

- Keep your fingers well clear of the disc tray. Neglecting this may cause serious personal injury. Keep a close watch on children.
- Do not use a cracked, deformed, or repaired disc.

### 1 Open the disc tray.

Press ▲ on the front panel or OPEN/CLOSE on the remote control.

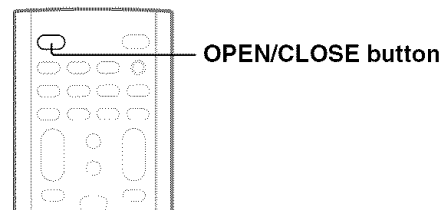
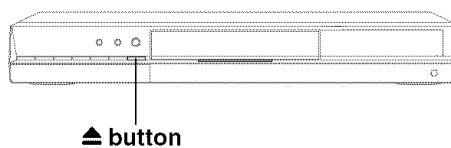

### 2 Insert a disc.

#### Disc without a cartridge

Insert with the playback side down.

There are two kinds of disc size. Place a disc to fit the guide. If a disc is out of the guide, it may result in damage to the disc or malfunction.

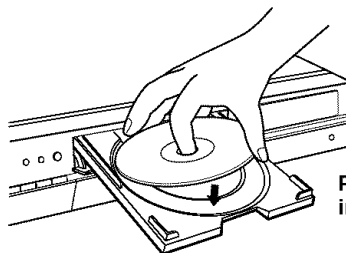

Place a disc in the inside hollow.

DVD-RAM disc with cartridge (TYPE1/TYPER2/TYPER4)

#### Single sided

Turn the printed side up, and insert the cartridge into the tray frame following the direction of the arrow on the cartridge.

#### Double sided

Turn the desired recording/playback side up, and insert the cartridge into the tray frame following the direction of the arrow on the cartridge.

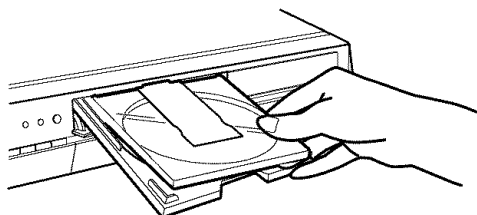

### 3 Close the disc tray.

Press **▲** on the front panel or **OPEN/CLOSE** on the remote control.

#### Notes

- Use the button on the front panel or the remote control to open and close the disc tray. Do not push or hold the disc tray while it is moving. Doing so may cause the recorder to malfunction.
- Do not insert a disc which is unplayable, or any object other than a playable disc.
- Do not apply downforce to the disc tray. Doing so may cause the recorder to malfunction.
- If the disc tray stops while closing, the mechanical protection system of this recorder will open it. Do not force it to close. Doing so may cause malfunction.
- If the disc tray will not open, turn the recorder off, and press the **▲** button on the front panel or the **OPEN/CLOSE** button on the remote control. This may turn the recorder on and open the disc tray. If it still won't open, contact your nearest TOSHIBA dealer.

### ■ Turning the power off

Press **ON/STANDBY** on the front panel of the recorder or on the remote control.

The "Unloading" icon appears at the top right corner of the screen, and the LED turns off if it is lighted, then the power turns off (Standby mode.)

#### Caution

- If the power fails or the power cord is disconnected from a wall outlet while the recorder is in operation (LED lit when the front panel display is not dimmed), the loaded disc may become recording disabled. In such a case, executing an initialization of the disc using the formatting function of the recorder may refresh it. However, all contents stored on the disc will be completely erased by this initialization process.
- This recorder may indicate alert messages with some DVD-RAM discs right after insertion. If such a disc is used for playback or recording on other equipment, all data in the disc may be damaged and the disc will not be played. By executing an initialization of the disc using the formatting function of the recorder, the disc will become operational.
- If the recorder freezes and does not respond at all, leave it alone for about 15 minutes or longer. This may restore the recorder. After the recorder has recovered, turn it off once and turn it on again to use as usual. If the recorder is still inoperable after more than 15 minutes have passed, press and hold the **ON/STANDBY** button on the front panel for about 10 seconds or longer. The recorder is forced to quit and the power turns off. Turn the recorder on again and use it as usual. (This is an emergency measure, which may cause losses and/or damages of data. Avoid casual use of this measure.) (This 15-minute measure is available only when "Screen Protector" is set to "On." (➡ page 115))

#### Note

- If there are any performance malfunctions of the disc drive, immediately discontinue use of this recorder, and disconnect the power cord from a wall outlet, then contact your dealer. Continuous use of the recorder in such a condition will aggravate the condition and result in increased cost and repair time.

### ■ Disc tray lock (Child lock)

You can lock the disc tray.

Press and hold **■** on the front panel or **STOP** on the remote control for longer than about 3 seconds.

To unlock, during stop press the button for longer than about 3 seconds.

#### Note

- Turning the power off also unlocks the disc tray.

Before operating this recorder (Continued)

■ Start-up/Shutdown (closing) icons

These icons are displayed at the top right corner of the screen when startup or finishing. While they are flashing, the recorder is operating as follows:



Start-up, reading a disc, finishing the recording



Unloading a disc, finishing the operation



Opening a disc tray



Closing a disc tray

■ Status display

Each time you operate the recorder, the following displays appear on the TV screen to indicate the status of the recorder.

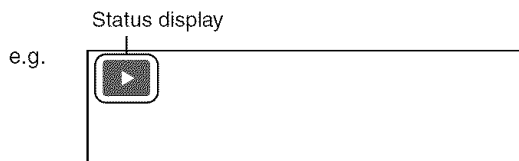

Main on-screen displays  
(Depending on the disc, some of these may not appear.)

- ▶ : Playback
- || : Pause
- : Stop
- ▶▶ : Fast-forward
- ◀◀ : Fast-reverse
- ▶▶ : Forward skip\*
- ◀◀ : Reverse skip\*
- ▶|x1/2 : Forward slow-motion
- ◀|x1 : Reverse slow-motion
- ||▶ : Forward frame by frame playback
- ◀|| : Reverse frame by frame playback
- : Recording
- || : Recording pause
- Title End : When title playback is completed
- ▶→ : Instant skip
- ▶↺ : Instant replay
- Chapter Divide : Chapter division

\* Accompanied with the followings:

**DVD-RAM** **DVD-R** **DVD-RW**:

Title number/title name and chapter number/  
chapter name

**DVD-VIDEO**:

Title number and chapter number

**VCD** **CD** :

Track number

**Note**

- You can add the current status of the settings to this display. See page 75.

# Key operation - EASY NAVI & QUICK MENU

The EASY NAVI button opens the “EASY NAVI Main Menu”, a main gate to the functions of this recorder. From this menu, you can access the desired functions while viewing a current picture. Additionally, the QUICK MENU button provides you a sub menu of the current function.

## ■ EASY NAVI

Press EASY NAVI.

Sound is muted and the following GUI appears. (Actual displays vary depending on operational status.)

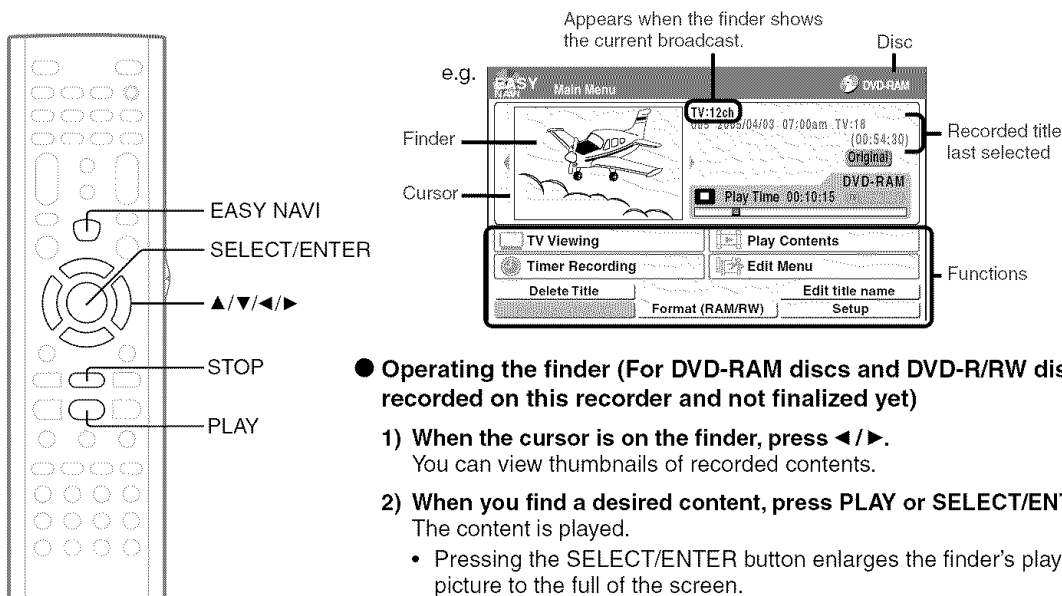

### ● Operating the finder (For DVD-RAM discs and DVD-R/RW discs recorded on this recorder and not finalized yet)

#### 1) When the cursor is on the finder, press ◀/▶.

You can view thumbnails of recorded contents.

#### 2) When you find a desired content, press PLAY or SELECT/ENTER.

The content is played.

- Pressing the SELECT/ENTER button enlarges the finder's playback picture to the full of the screen.
- You can change playback speed. See ➡ page 59.

#### 3) To stop, press STOP.

A current channel broadcast appears. (“TV:xxxch” accompanies.)

- Pressing the REC button starts recording. On recording, see ➡ page 26.

### ● Item selection

Press ▲/▼/◀/▶ to select an item, then press SELECT/ENTER.

(Unavailable features are grayed out.)

| Item            | Function  | ➡ page |
|-----------------|---|--------|
| TV Viewing      | Return to current broadcast channel.                                  | –      |
| Play Contents   | Recorded contents are listed in a thumbnail view.                     | 51     |
| Timer Recording | A list of timer programs appears.                                     | 41     |
| Edit Menu       | A menu of editing options appears.                                    | 98     |
| Delete Title    | You can delete the current content. Operate according to the message. | 47     |
| Edit title name | An on-screen keyboard appears.  | 30     |
| Finalize (R/RW) | You can execute the DVD-Video finalizing process on the loaded disc.  | 100    |
| Format (RAM/RW) | You can format the loaded disc.                                       | 28     |
| Setup           | A setup menu appears.   | 106    |

(Continued)

- **To exit the EASY NAVI**  
Press EASY NAVI again.

**Note**

- For a disc other than the specified one, the finder cannot be operated. To play the disc, exit the EASY NAVI then press the PLAY button, or select the “Play Contents” function.

■ **Quick Menu operation**

To access various optional functions of this recorder, open Quick Menu. Quick Menu displays a list of selections relevant to your current mode.

● **Opening a Quick Menu**

1) **Press QUICK MENU.**

The following menu (“Quick Menu”) appears.  
(Actual selections vary depending on operational status.)

e.g.

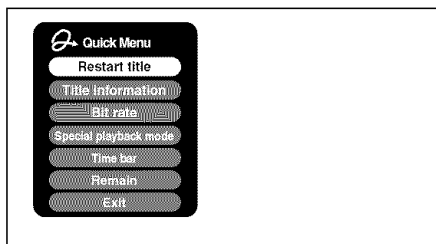

- 2) **Press ▲ / ▼ to select an item, then press SELECT/ENTER.**

● **To exit Quick Menu**

Press QUICK MENU again.

Alternatively

Select “Exit” with ▲ / ▼, then press SELECT/ENTER.



## Hint on reading this manual

The following icons show the playable discs for each function described on this instruction manual.



 : DVD-RAM disc

 : DVD-RW disc

 : DVD-R disc

 : DVD video disc

 : VIDEO CD

 : Audio CD  
(For CD containing JPEG or MP3/WMA files,  
see  page 70, 72.)

Most instructions are based on remote control operation, unless otherwise noted. You can use the buttons on the remote control and those on the main unit as well when they have the same function.

If copy protection signal is detected during recording on this recorder, the recording automatically pauses and a message appears. In this case, the  button cannot release the recording. (It is possible to end the recording by pressing the STOP button.) If the copy protection signal continues, the recording will terminate.

# Recording

Recording variations for many types of programs or situations.

- Before recording
- Selecting a disc according to purposes of use (DVD-RAM/ DVD-R/RW)
- Setting for recording on a DVD-R/RW disc in Video mode
- Recording a TV program
- Recording an external source
- Programing a recording
- Others

# Before recording

Please be sure to read this critical background information prior to making a recording.

Conventional video cassette recorders have required tapes to record, while this recorder enables recording on a DVD-RAM/R/RW disc whenever you want, without selecting an available tape and confirming a point to start a recording from. Further, if you use DVD-RAM discs, you can collect necessary scenes and store them in it to make your own video library.

## ■ Is your DVD recorder ready?

Before recording a TV program on this recorder, insure that channels you want to record are correctly tuned in on this recorder.

If not tuned in, read the separate "INSTALLATION GUIDE" volume again, and confirm all the necessary connections and settings have been done.

Also, insure the clock is set precisely for program recording. Set the clock using the "Initial settings" menu (➡ page 33, INSTALLATION GUIDE).

## ■ Disc initializing

Whenever you use a new DVD-RAM/RW disc on this recorder, be sure to initialize the disc.

DVD-R discs can be used on this recorder without initializing.

For details of initialization of DVD-RAM/RW discs, see ➡ page 28.

If an initialized DVD-RAM disc is still unusable, it may become usable by executing "DVD-RAM physical format" in the "Management settings" menu. For "DVD-RAM physical format", see ➡ page 29.

## ■ Note on recording on a DVD-RAM disc

Confirm disc compatibility and prepare an available DVD-RAM disc to record on (➡ page 6, 8).

Some discs may need to be formatted for use on this recorder. A message will appear asking you to execute disc formatting. Follow the procedure displayed on-screen to format the DVD-RAM disc compatible with this recorder.

Some DVD-RAM discs formatted on a PC may not be usable.

## Notes

- This recorder records on a DVD-RAM disc if it complies with DVD-RAM standard Version 2.0, 2.1 or 2.2. However, you may not record on some DVD-RAM discs that have complicated contents (often, to protect the recorded data). When you select a DVD-RAM disc that has already been recorded, check that the disc is suitable for recording or the remaining time of the disc is displayed. It is recommended to use a new DVD-RAM disc for an important recording.
- Depending on the source recording device used and how that device is set up, the video and sound quality of the recording may vary slightly from the video and sound quality of the source device.

## ■ Note on recording on a DVD-RW disc

Confirm disc compatibility and prepare an available DVD-RW disc to record on (➡ page 6, 9).

Some discs may need to be initialized for use on the recorder. A message will appear asking you to execute disc initializing. Follow the procedure displayed on-screen for initialize the DVD-RW disc compatible with this recorder.

Some DVD-RW discs initialized on a PC may not be usable.

To play a DVD-RW disc recorded on this recorder on other devices, finalize the DVD-RW disc on this recorder. (➡ page 100)

The finalization disables the disc's rewritability. To rewrite a finalized DVD-RW disc, cancel the finalization (➡ page 103).

- On DVD-RW discs recorded on other devices, you cannot execute DVD-Video finalize process or cancel the finalize process, or add recordings on this recorder.
- You cannot rewrite or edit a DVD-RW disc if recorded in DVD-VR mode.
- DVD-RW discs which are recorded on other devices and not finalized yet, cannot be read on this recorder. Do not rush to initialization. Check that the contents can be erased or not.

### ■ Note on recording on a DVD-R disc

Confirm disc compatibility and prepare an available DVD-R disc to record on (▶ page 6, 9).

To play a DVD-R disc recorded on this recorder on other devices, finalize the DVD-R disc on this recorder. (▶ page 100)

The finalization permanently disables the disc's rewritability. (Canceling the finalization is not possible.)

- DVD-Video finalize process cannot be canceled if once executed on a DVD-R disc.
- On DVD-R discs recorded on other devices, you cannot execute DVD-Video finalize process or add recordings on this recorder.

### ■ To check space remaining on a disc

#### 1) Press **REMAIN**.

The current capacity is displayed at the bottom of the screen and on the front panel display.

#### 2) After checking the capacity, press **REMAIN** again to turn off the display.

### Note

- You can also check the capacity of the disc by selecting "Disc budget calculation" from Quick Menu within the REC MENU (▶ page 45).

### ■ Programmed recording and operational status

The recorder gives priority to programmed recordings in every operating mode. Even if the recorder is playing, recording or editing, or even in standby mode, at a starting time of a programmed recording the recorder will make itself ready or stop those operations and start the recording.

However, "DVD-Video finalizing process" (▶ page 100) operations may have priority over programmed recordings.

### ■ When the programmed settings overlap

Before the first recording is completed, the second program is scheduled to begin recording. When using a DVD-RAM disc, the recording of the previous program stops 15 seconds before the next program starts.

When using a DVD-R or DVD-RW disc, the recording of the previous program stops about 2 minutes before the next program starts, to complete data process. In this 2 minutes, you cannot operate the loaded DVD-R or DVD-RW disc.

### ■ On a programmed recording across the change-over of Daylight-saving time

- When the clock gains across Daylight-saving time during a programmed recording, it means that the recording completion time is consequently set one-hour earlier. In this case, set the programmed recording one-hour longer in advance. If not set accordingly, the programmed recording stops one-hour shorter.
- When the clock loses across Daylight-saving time during a programmed recording, it means that the recording completion time is consequently set one-hour later. In this case, as the programmed recording continues one-hour longer, delete unnecessary chapters by chapter dividing after the completion of recording.

### Notes

- The "Loading" icon appears in the top right of the screen after recording. This indicates that the unit is executing the final recording process (writing managing information). Operations other than changing channels cannot be done until this icon disappears. The time for executing this process differs depending on the recording time or capacity of the disc.
- Note that all recording content may be deleted if the unit is disconnected from a wall outlet, or a power failure occurs, during recording.
- If a power failure occurs within five minutes prior to the programmed recording start time, the programmed recording may not be executed.
- A programmed recording may not be executed correctly if scheduled when Daylight-Saving time starts or ends.

## Initializing a DVD-RAM/RW disc (Logical format)

**Be sure to read this section prior to using a DVD-RAM/RW disc on this recorder for the first time. For DVD-R, initializing is not necessary.**

A disc should be initialized in the following cases: (The recorder may display a message to request you to do so.)

e.g.

- When you use a DVD-RAM/RW disc on this recorder for the first time.
- If data fragments produced by repeated recording or erasing have accumulated.
- If a disc error has occurred.
- When you want to record on a DVD-RAM disc for PC.  
(➡ page 8)

Initializing formats a disc logically and insures that it will perform to its full capability. However, this erases all data on the disc, so make sure that it does not matter if data on the disc is erased whenever you initialize a disc.

### ■ How to initialize a disc

To initialize a DVD-RAM disc, load it in the recorder. See ➡ page 20 for loading a disc.

#### 1) During stop, press QUICK MENU.

The following menu appears. (The actual contents depends on the operational status of the recorder.)

e.g.

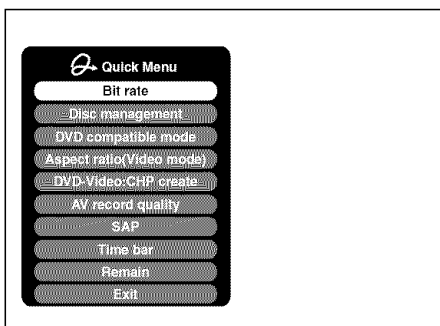

#### 2) Press ▲ / ▼ to select “Disc management,” then press SELECT/ENTER.

A sub menu appears on the right side.

e.g.

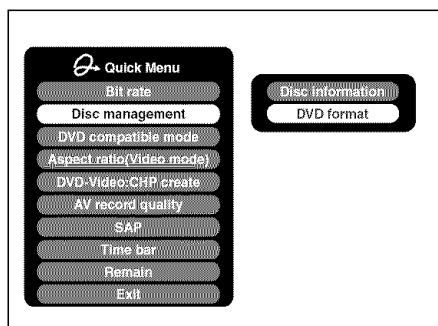

#### 3) Press ▲ / ▼ to select “DVD format,” then press SELECT/ENTER.

e.g.

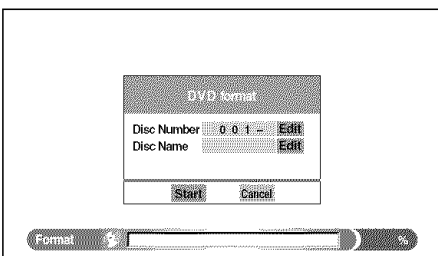

### Numbering a disc

The recorder automatically numbers discs when initializing. However, you can assign a desired number (using 3 digits) and designate sides A and B on a double-sided disc. (DVD-RW discs cannot be numbered.)

- (1) Press ▲ / ▼ buttons to select “Edit” of “Disc Number” then press SELECT/ENTER button.
- (2) Press ▲ / ▼ buttons to select a digit.
- (3) Press ◀ / ▶ buttons to shift.
- (4) Repeat steps (2) and (3).
- (5) Press SELECT/ENTER button.

### Naming a disc

You can name a disc.

- (1) Press ▲ / ▼ buttons to select “Edit” of “Disc Name,” then press SELECT/ENTER button.  
The character input window appears.
- (2) Enter a disc name following the procedure of “Entering characters” (➡ page 30).
- (3) Press ★ button to eliminate the window.

- 4) Press ◀/▶ to select “Start,” then press SELECT/ENTER.

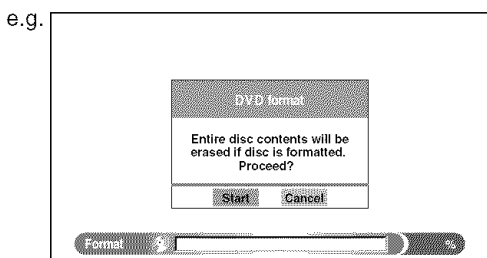

- 5) Press ◀/▶ to select “Start,” then press SELECT/ENTER.

Initialization starts.

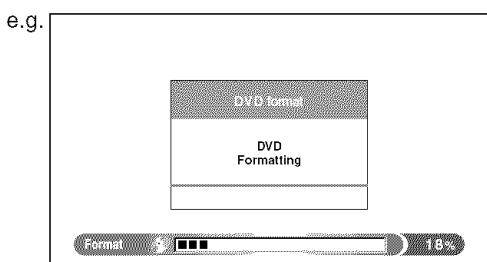

When initialization is completed, the setup window disappears.

## DVD-RAM physical format

Physical formatting is a simple execution for a disc which cannot be used or read (or which is becoming hard to read). It may refresh such a disc for recording and playback. (There is no guarantee that all such discs will be recovered.)

“DVD-RAM logical format” process only rewrites certain data on file system and management information, however, “DVD-RAM physical format” rewrites all data on a disc, therefore it takes a much longer time to complete. For a 4.7GB single sided DVD-RAM, about 70 minutes will be necessary. While processing, all recorder operations and functions including program recording will not work until the process is finished. Also this process erases all data stored on the DVD-RAM disc.

- 1) During stop, press SETUP.  
2) Press ◀/▶ to select “Management settings” then press SELECT/ENTER.

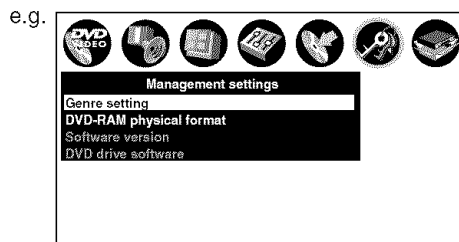

- 3) Press ▲/▼ to select “DVD-RAM physical format,” then press SELECT/ENTER.  
4) Press ◀/▶ to select “Yes,” then press SELECT/ENTER to execute.

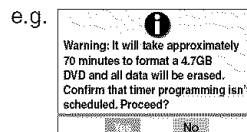

To cancel, select “No”, then press SELECT/ENTER button.

- 5) Read the message, and press ◀/▶ to select “Yes” or “No”, then press SELECT/ENTER.

### Notes

- The physical format process may fail if executed to a dirty DVD-RAM disc. Also, the disc may be difficult to record, even if it finished. Before executing DVD-RAM physical format process, be sure to confirm the disc is not dirty. Clean it if necessary. If the disc has scratches or dust beyond cleaner's efficacy, do not execute DVD-RAM physical format process on the disc.
- The following DVD-RAM discs require physical formatting:
  - A disc which is not formatted correctly.
  - The disc which has errors during writing because of dirt on the disc, and cannot be further recorded, or cannot initialize normally.
- You need to start physical formatting from the first step again when you use a failed disc.
- Physical formatting does not work if the disc contains a lot of voids beyond the limitation of this recorder.
- If an error occurs in physical formatting, “ERR-01” appears in the front panel display. To turn off the message, press DISPLAY button.

## Entering characters

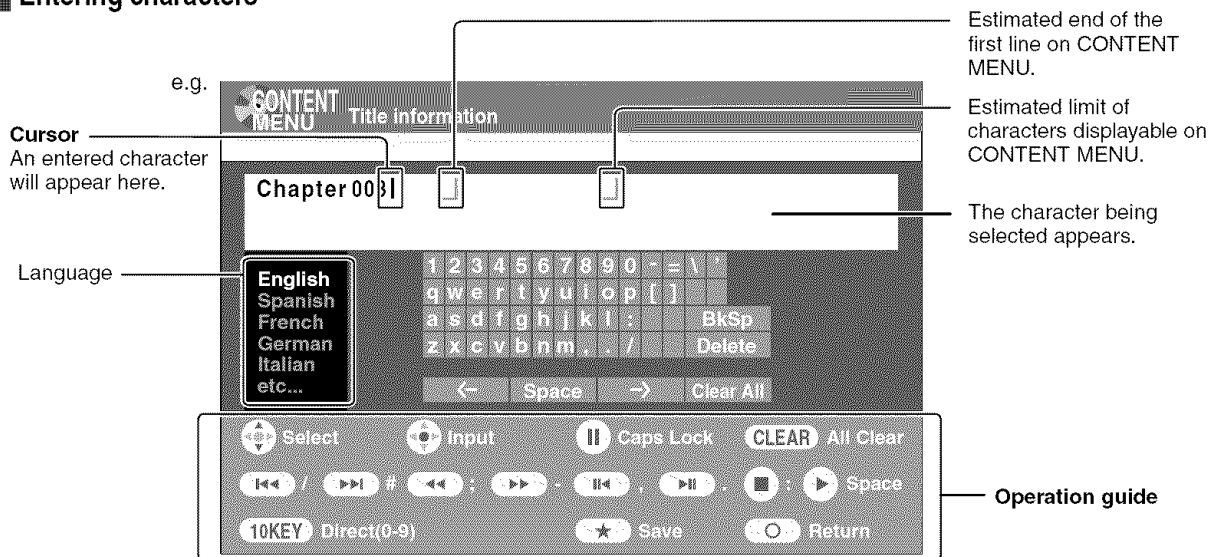

### ■ Operation guidance of the remote control

To enter the character, normally use ▲ / ▼ / ◀ / ▶ buttons on the remote. About the other buttons to be used are shown on the operation guide.

10KEY : Enters a number.

CLEAR : Erases all the characters.

|| : Caps Lock

★ : Saves the changes and returns to the previous screen.

○ : Cancels the changes and returns to the previous screen.

▶ : Enters a space.

◀▶ : Enters a symbol.

◀▶

### ■ Switching a language

Before entering a character, move a cursor to the language selection area by pressing ◀ / ▶ buttons. Then press ▲ / ▼ buttons to select a language, then press SELECT/ENTER button.

## ■ Entering characters

The cursor may be followed by unwanted characters.  
You can erase them if necessary by either of the following measures:

### Erasing characters

- Erasing all the characters on the writing board  
Select "Clear All" by pressing ▲/▼/◀/▶ buttons, then press SELECT/ENTER button.  
Alternatively, press CLEAR button.
- Erasing one character before the cursor  
Select "BkSp" by pressing ▲/▼/◀/▶ buttons, then press SELECT/ENTER button.

- (1) Press ■ button to select an input mode.
- (2) Press ▲/▼/◀/▶ buttons to select a character, then press SELECT/ENTER button.  
The selected character is input on the cursor.
- (3) Repeat steps (1) and (2) to enter characters.
- (4) When finished, press ★ button to save the characters.  
The characters you entered appears.

### Notes

- You can enter up to 64 characters.
- When unnecessary information appears, or when you want to alter the input character, press CLEAR button to erase all, or select "BkSp" or "Delete" to erase an unnecessary character.

# Selecting a disc according to purposes of use (DVD-RAM/DVD-R/RW)

There are various types of discs having different standards.  
Select one for your purpose of use.

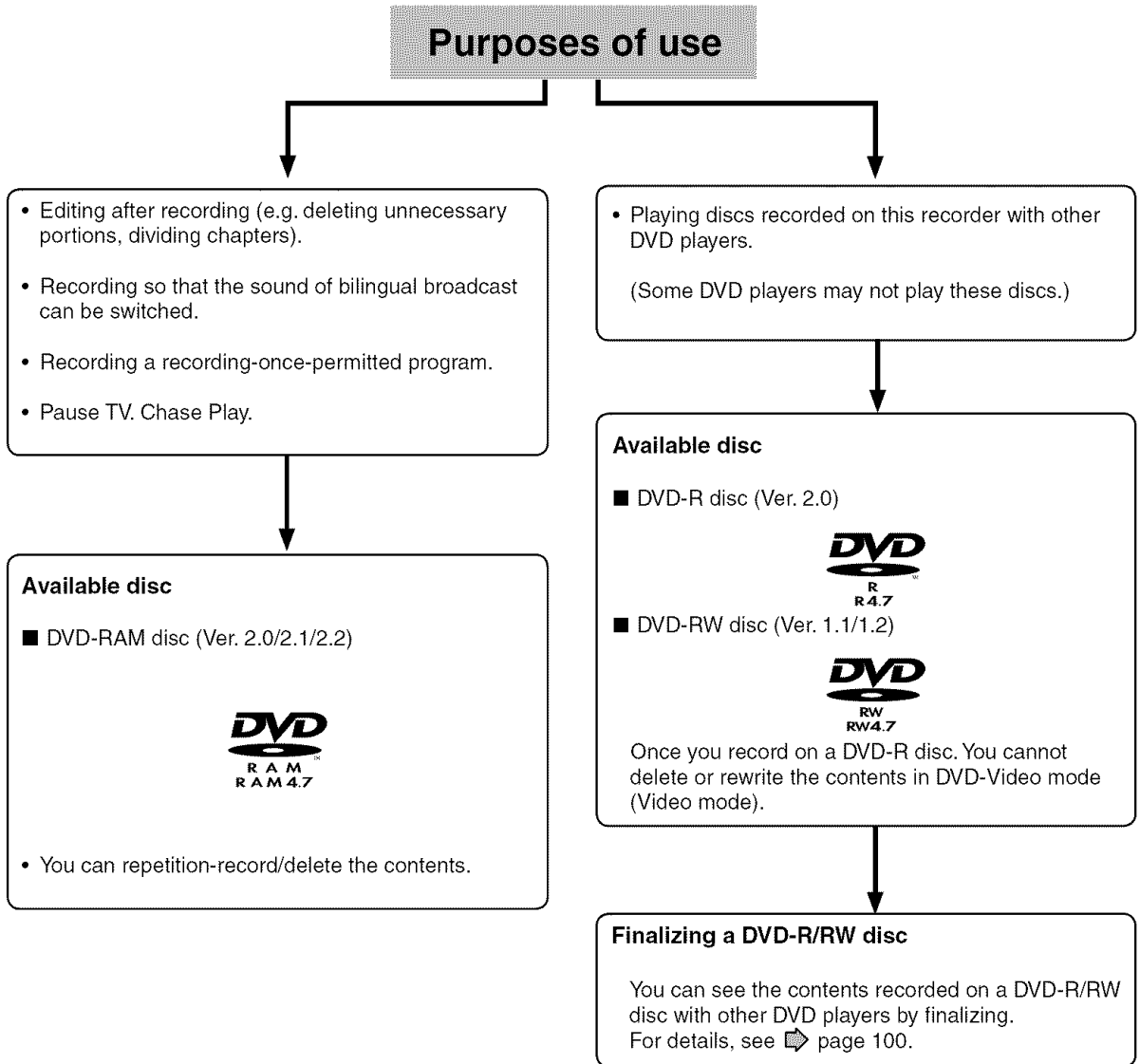

When recording on a DVD-R/RW disc you need to set up the recorder due to the restriction by DVD-Video standard.

For details, see the next page.



# Setting for recording on a DVD-R/RW disc in Video mode

This setting is necessary to play the contents on a DVD-R/RW disc with other DVD players.

## ■ Items to set up

When recording in Video mode, there are some restrictions by DVD-Video standard. Therefore, it is necessary to set up these items below. Set up the items in advance before recording onto a DVD-R/RW disc.

### ● DVD compatible mode

Only the main sound and SAP sound are available for recording in Video mode under DVD-R standard.

**Off:** This is not for recording on a DVD-R disc. Depending on Picture/Audio settings, making DVD Video may not be possible. (When recording directly on a DVD-R/RW disc of DVD-Video mode, the recording proceeds with "Main" on even though "Off" is set.)

**Main:** In multichannel broadcasting, only the main sound is recorded.

**SAP:** In multichannel broadcasting, only SAP sound is recorded.

### ● Aspect ratio

"4:3" and "16:9" cannot be mixed in one title. Therefore, set the aspect ratio before recording.

**4:3:** Set the aspect ratio to 4:3

**16:9:** Set the aspect ratio to 16:9

### ● Chapter dividing ("DVD-Video: CHP create")

This is the setting to divide a title into some chapters. It is convenient to skip scenes.

**Off:** Chapter dividing is not available.

5 min, 10 min, 15 min, 20 min:

Select an interval for chapter dividing.

## Note

- When the number of chapters reaches a limit, chapters are not divided anymore. The limit number of chapters is dependent on conditions of a DVD-R/RW disc.

## How to set up

### 1 Press SETUP.

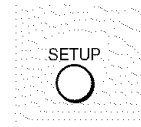

SETUP menu appears.

### 2 Select "DVD recorder operation" and press SELECT/ENTER.

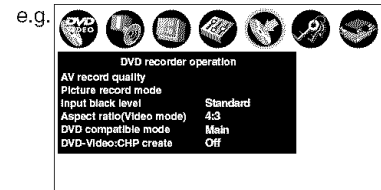
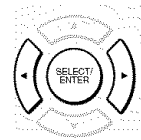

### 3 Select "Aspect ratio (Video mode)" and press SELECT/ENTER.

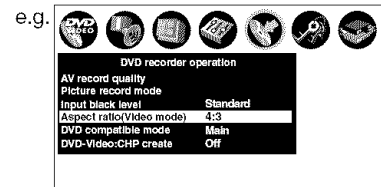
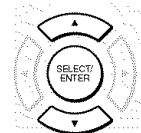

### 4 Select an item and press SELECT/ENTER.

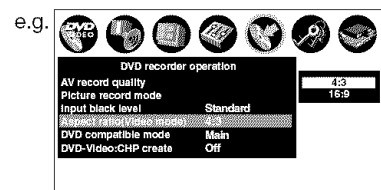
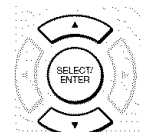

Set "DVD compatible mode" and "DVD-Video: CHP create" as step 3, 4.

# Recording a TV program

To record a TV program currently being broadcast, follow the procedures of this chapter.

## ■ Preparation

- Load a DVD-RAM/R/RW disc into the recorder.
  - Load a disc which has sufficient space available to record the program.
  - Make sure the loaded disc is not write-protected.
- If you record on a DVD-R or a DVD-RW disc, set "DVD compatible mode" (➡ page 33) to "Main" or "SAP." In DVD-R/RW recording, "Off" setting is regarded as "Main."
- If you record on a DVD-R or DVD-RW disc, set "Aspect ratio(Video mode)" (➡ page 33) according to recording sources.

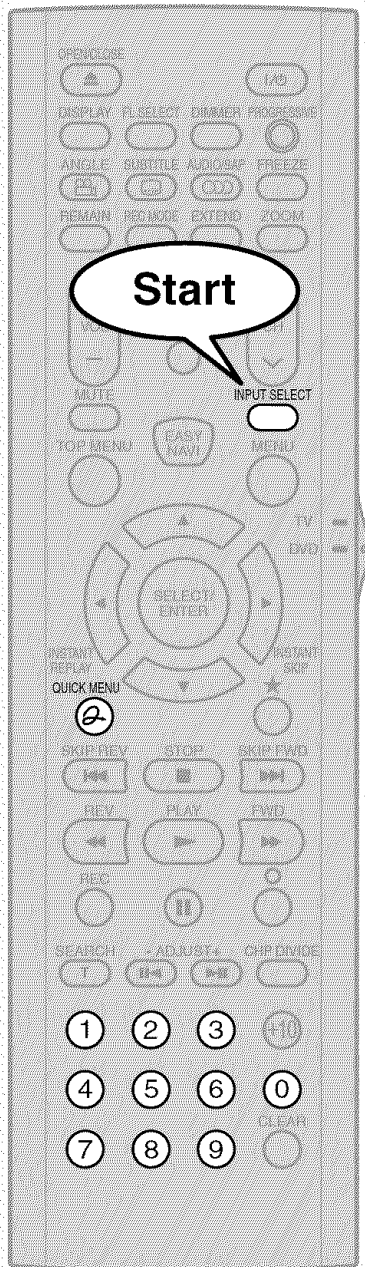

## 1 Press INPUT SELECT repeatedly to select a recording source.

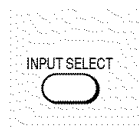

Each time you press the button, the indicator alternates.

**Ch-:** To record a TV program or cable program with recorder tuner.

**L-1:** To record a source connected to the INPUT1 jacks on the rear panel (➡ page 38).

**L-2:** To record a source connected to the INPUT2 jacks on the front panel (➡ page 38).

## 2 Press the number buttons to select a channel to record.

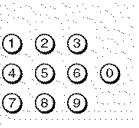

CH button (↖↗) is also available.

To record a program from a connected tuner, select the channel on the tuner.

## 3 Press QUICK MENU to display Quick Menu.

(If you want to use the default setting for "AV record quality," skip to step 7.)



e.g.

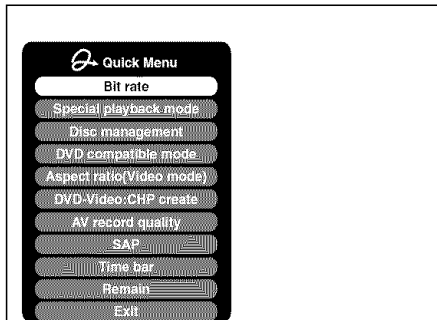

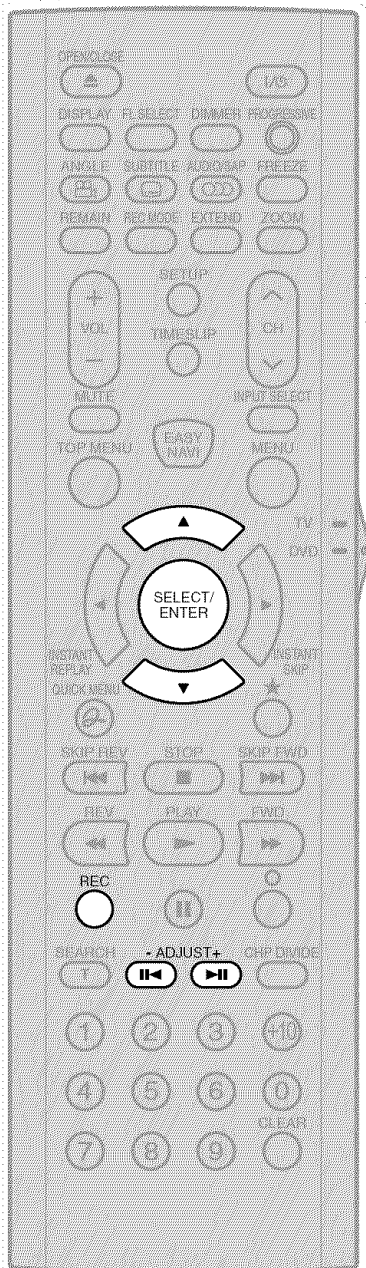

## 4 Press ▲ / ▼ to select “AV record quality,” then press SELECT/ENTER.

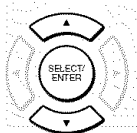

e.g.

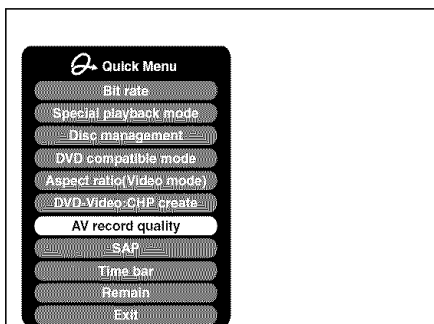

## 5 Press ADJUST (-/+) to select the setting number.



e.g.

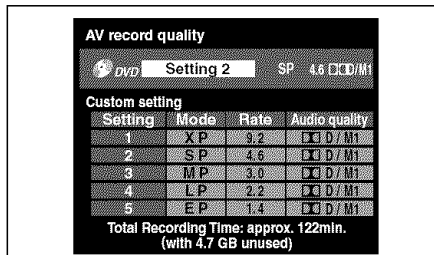

See page 42 for details on “Mode”.

## 6 Press SELECT/ENTER.

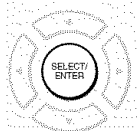

The menu disappears.

## 7 Press REC.

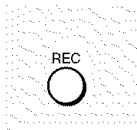



Recording starts.

### Recording a TV program (Continued)

#### ■ Selecting the recording mode

Before recording, you can select the recording mode. During stop mode, press REC MODE button. By pressing the button repeatedly, you can select one from 5 settings of "AV record quality" appearing in the front panel display.

#### Notes

- During recording, you cannot change the recording parameters, such as modes, channels, etc.
- The number of titles cannot exceed 99 for any disc.
- During normal recording, you can set the programmed recording using the REC MENU.
- You cannot start recording immediately before a programmed recording starts.
- For recorded sound, see  page 69.
- During monaural sound recording, the same sound is recorded on both the left and right channels.
- When "DVD compatible mode" is set to "Main" or "SAP", the unit records the same sounds on both the left and right channels when receiving monaural sound. When receiving the multi-channel sound, the selected sound, Main or SAP, is recorded on both the left and right channels.
- Depending on the disc contents, pressing REC button may take a longer time to start recording.
- When a starting time of a programmed recording comes, a recording in execution is stopped and the programmed recording starts. If you do not want to stop the recording, cancel the timer program before it starts.
- Even if you set "Aspect ratio(Video mode)" ( page 33) to "16:9", images are recorded in 4:3 aspect ratio when using a DVD-R or DVD-RW disc with "Rate" set to "EP" (1.4 Mbps).
- Be careful of a programmed recording across the change-over of Daylight-saving time ( page 27).

### ■ To stop recording

Press **STOP**.

### ■ To pause recording (to omit an unnecessary portion)

During recording, press **II**.

To resume recording, press it again.

### ■ To change a TV channel to be recorded

1) During recording, press **II**.

Recording pauses.

2) Press **CH** or the number buttons to change the channel.

3) Press **II** to resume recording.

### ■ To view a TV program while recording another

1) Start recording on this recorder.

2) On a connected TV, select the TV mode.

3) Using the channel selector of the TV, select a desired channel on the TV.

### ■ To set an end time of a recording which is in progress

1) During recording, press **QUICK MENU**.

Quick Menu appears.

2) Press **▲ / ▼** to select "End time" then press **SELECT/ENTER**.

The display changes as follows:

e.g.



3) Press **◀ / ▶** to select an item then press **ADJUST** to change the value.

4) Press **SELECT/ENTER**.

### Notes

- By setting an end time, it is memorized as a programmed one, and the  indicator in the front panel display illuminates to indicate that the recorder holds a timer program of recording.
- The programmed end time must be set for 5 minutes later than the current time.

### ■ To play a title recorded on a DVD-RAM disc while recording another on the same disc (Recorded Title Play)

During recording, you can play a title recorded on the same disc.

1) While recording on a DVD-RAM disc, press **EASY NAVI**.

2) Press **▲ / ▼ / ◀ / ▶** to select "Play Contents", then press **SELECT/ENTER**.

3) Press **▲ / ▼ / ◀ / ▶** to select a desired title, then press **SELECT/ENTER**.

Playback of the selected title starts.

Pressing **STOP** button stops playback, and the content currently recorded returns. If you press **PLAY** button, playback resumes from the location you last stopped.

### Notes

- The playback picture may appear after a delay of several seconds.
- While you are using this function, the following operations/functions are not available.
  - Programmed playback (repeat playback, etc.)
  - Editing (Playlist programming, dubbing, title/chapter naming, title thumbnail setting, etc.)
- Depending on the data condition, playback may pause.
- When the recording mode is set to "XP" or "AT" (when a high bit rate is automatically set.  page 42), this function is not available.

### ■ Creating chapters automatically at regular intervals

Set "DVD-Video:CHP create" ( page 33).

# Recording an external source

You can record programs from connected equipment on a DVD-RAM/R/RW disc.

## Connect according to A or B.

- To record a clearer picture, use the S video jack.

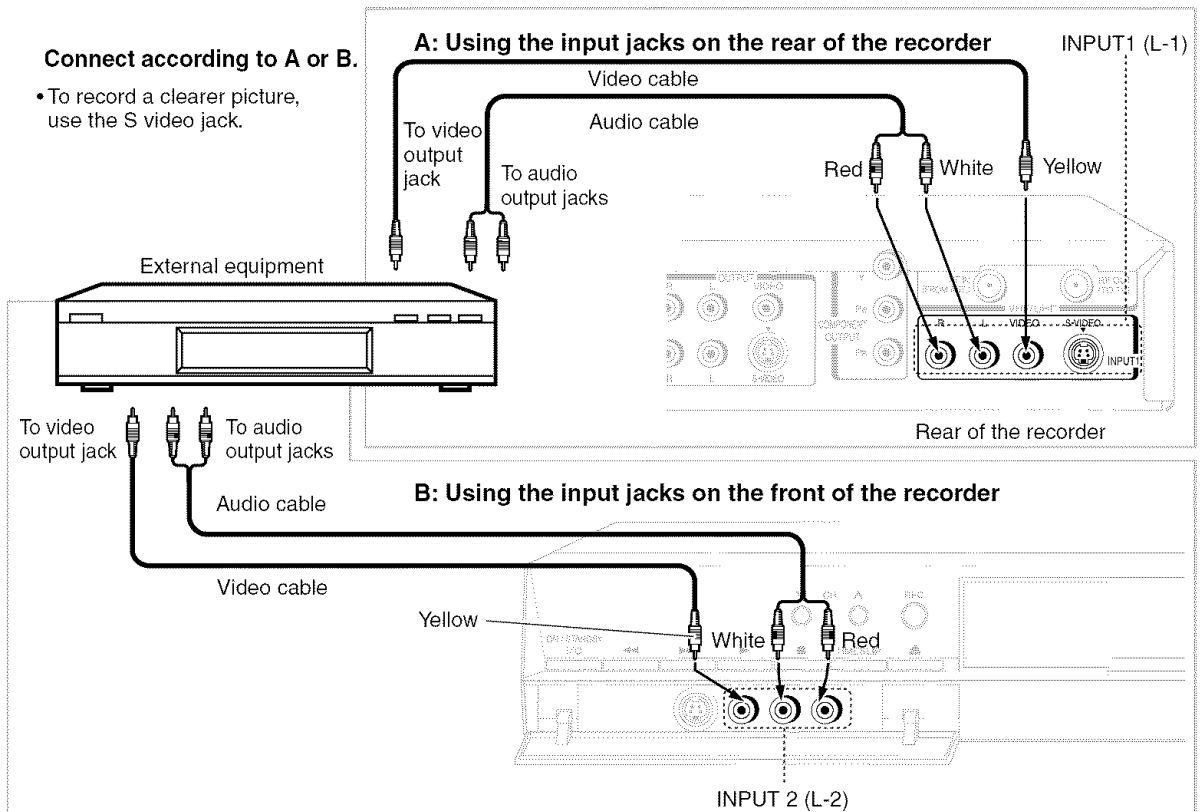

## ■ Preparation

- Load a DVD-RAM/R/RW into the recorder.
  - Load a disc which has sufficient remaining space to record the program.
  - Make sure the loaded disc is not write-protected.

## Notes

- If a source of high quality sound track such as DVD audio is recorded with this recorder, the sound quality becomes regular audio CD quality. Refer to the instructions of the connected equipment.
- When you record an external source onto a DVD-R/RW disc, set the connected equipment to output sound you want to record (if selectable such as multiplex broadcasting), as the recorder records sounds of external source in the stereo type onto a DVD-R/RW disc, neglecting the setting of "DVD compatible mode" (▶ page 33).
- DVD-R/RW discs cannot record contents with copy restriction signal embedded (copy-protected or copy once contents), DVD-RAM discs can record copy once contents.
- Some satellite programs via a connected tuner may contain both 4:3 pictures and 16:9 pictures. DVD-R/RW discs cannot record such contents, under restriction of the DVD-Video standard. To record these programs, use DVD-RAM discs.

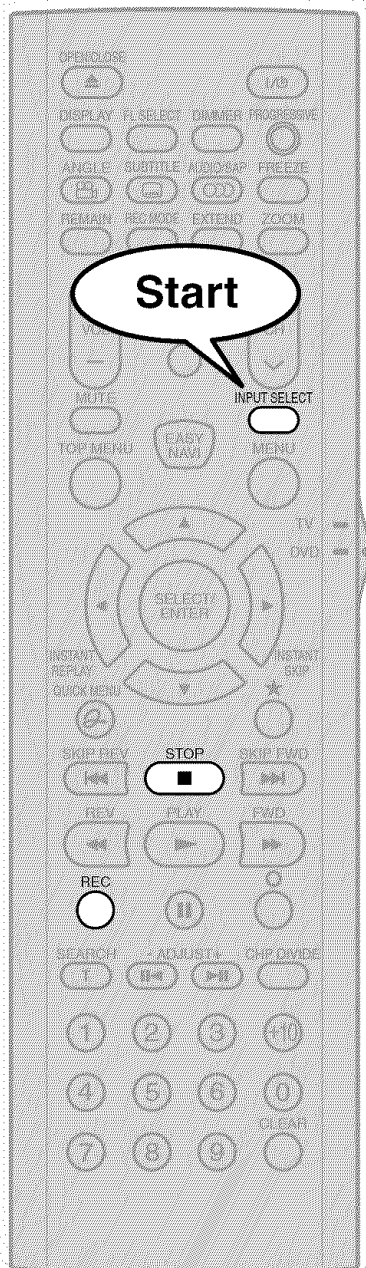

- 1 Press **INPUT SELECT** repeatedly so that “L-1” or “L-2” appears on the front panel display, corresponding to the input in which the device is connected.

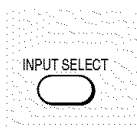

Each time you press the button, the indicator changes.

**L-1:** To record pictures from equipment connected to the INPUT 1 jacks on the rear panel.

**L-2:** To record pictures from equipment connected to the INPUT 2 jacks on the front panel.

- 2 Start playback of the source content on the connected equipment.

- 3 Press **REC** of this recorder to start recording.

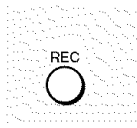

- 4 When recording is completed, press **STOP**.

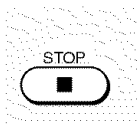

#### ■ Notes on recording from a connected VCR or camcorder

##### ● Check the condition of the source equipment before playing.

Set the equipment in good condition, e.g. clean the head or adjust the tracking, etc. to obtain optimum playback. Bad condition may produce noises in playback. These noises may be detected as copy protection signals, resulting in stop of recording on this recorder.

Play a source in an usual mode. Avoid using any correcting or enhancing features, as they may add signals which can be detected as copy protection signals.

Source quality or tape condition beyond adjustments on the source equipment may stop a recording on this recorder.

##### ● Do not operate the source equipment during recording on this recorder.

Operations such as pausing, resuming, fast-forwarding (CUE) and fast-reversing (REVIEW), etc. may produce noises, which may be detected as copy protection signals. Therefore, first start playback on the source equipment to confirm that the desired source can be played properly, and then start recording on this recorder.

Do not operate the source equipment during recording. After completing the desired scene, stop the recording on the recorder, and then stop the playback on the source equipment. Delete unnecessary scenes using editing functions (▶ page 98). If you want to operate the source equipment during recording, pause or stop the recording. After operating the source equipment, resume the recording as above.

##### ● When recording from a camcorder

Follow the above notes. Be sure to power the camcorder by its AC adapter, not batteries. If batteries are run down, the recording may not be finished completely.



# Programming a recording

Use REC MENU to program a recording. It will take less time to prepare, as it provides all necessary information for recording, including estimated disc space remaining.

For more information, see “Before recording” (▶ page 26).

Be careful when you program a recording across the change-over of Daylight-saving time (▶ page 27).

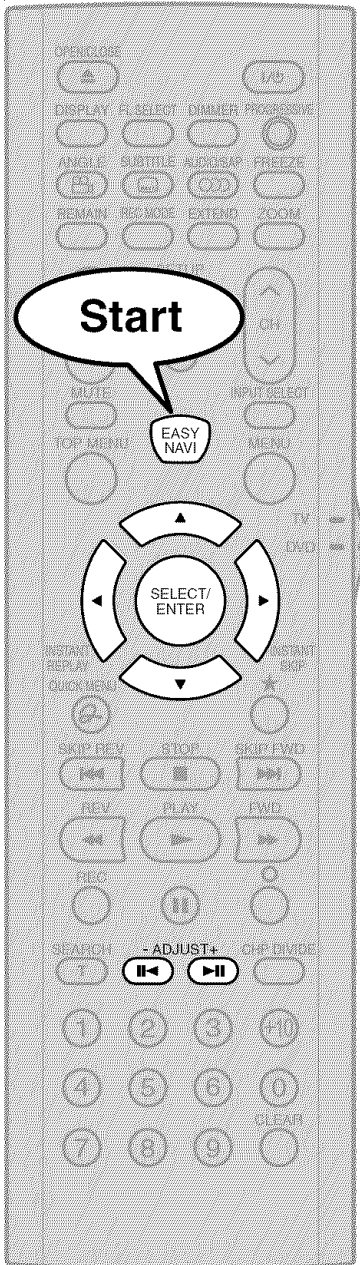

## 1 Press EASY NAVI.



EASY NAVI Main Menu appears.

## 2 Press ▲/▼/◀/▶ to select “Timer Recording”, then press SELECT/ENTER.

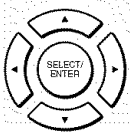

REC MENU appears.

e.g.

| Exec | CH | Date | Start | End | Media | Video  | Audio |
|------|----|------|-------|-----|-------|--------|-------|
|      |    |      |       |     | DVD   | SP 4.6 | DD/M1 |

## 3 Press SELECT/ENTER.

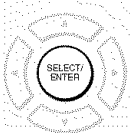

“CH” is ready for setting.

e.g.

| Exec | CH | Date | Start | End | Media | Video  | Audio |
|------|----|------|-------|-----|-------|--------|-------|
| ✓    |    |      |       |     | DVD   | SP 4.6 | DD/M1 |

## 4 Select an item by pressing ◀/▶, then press ADJUST (-/+) to set the item.

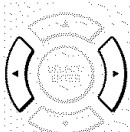

e.g.

| Exec | CH | Date      | Start   | End     | Media | Video  | Audio |
|------|----|-----------|---------|---------|-------|--------|-------|
| ✓    | 23 | 4/10 (Su) | 7:00 pm | 8:00 pm | DVD   | SP 4.6 | DD/M1 |

- Refer to the setting items on the next page.
- You can also set the item by pressing ▲/▼ button.
- “CH” can be input by the number buttons.

(Continued)

## Programming a recording (Continued)

## 5 When complete, press SELECT/ENTER.

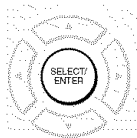

To program another recording, press ▼ button to move to the next line, then repeat steps 3 to 5.

## 6 Press EASY NAVI to exit.



Your program is entered.

- If you want to turn off the power, press ON/STANDBY button.

### ■ Setting items

|        |  |   |
|--------|--|---|
| Exec   | √  | A timer program with this mark will be executed. To disengage, remove this indicator.   |
| CH     | 2-69 (TV), 1-125 (Cable), L1, L2   | Select a channel you want to record.  |
| Date   | Specific date (from today to 2 month later)<br>Every Sunday to Saturday, Monday to Thursday, Monday to Friday, Monday to Saturday, everyday. | Select a date of a TV program you want to record.   |
| Start* | 12:00 am – 11:59 pm  | Enter a starting time of recording. (An initial setting is 10 minutes later.)<br>You can also use the number buttons.   |
| End*   | 12:00 am – 11:59 pm  | Enter an end time. (Set the timer to begin recording no sooner than 2 minutes past the current time.)<br>You can also use the number buttons.   |
| Media  | DVD  | Fixed. (Not adjustable.)  |
| Video  | XP 9.2   |   |
|        | SP 4.6   |   |
|        | MP 3.0   |   |
|        | LP 2.2   |   |
|        | EP 1.4   |   |
|        | AT (Auto)  | To set a rate automatically according to the remaining volume of the disc. (If the disc does not have room for the TV program, the program cannot be recorded to the end.) Even if you use a blank DVD disc, the maximum recording time is about 2 hours. |
| Audio  | □□ D /M1**   | Fixed. (Not adjustable.)  |

\* If you set summer time on the clock of the recorder, see the notes on page 34 in the “INSTALLATION GUIDE”.

\*\* The digital recording technology for consumer products of Dolby Laboratories is used for □□ D /M1. Dolby Digital 192 kbps is set for □□ D /M1.

#### Notes

- See page 48 for details on “Video”.
- If you record with setting the bit rate to MP (3.0 Mbps), LP (2.2 Mbps) or EP (1.4 Mbps), the recorded pictures may not be played properly if change the playback speed. There will be noise, and the picture quality is lower than other rate settings.

## ■ Suggestions for the picture quality setting

- **For normal recording or when you cannot decide which mode to choose.**  
Select “SP”.
- **When you need a longer recording time and video quality is not important**  
Select “EP”.
- **To record a high quality picture**  
Select “XP”.
- **To fill the disc**  
Select “AT (Auto).” A bit rate is calculated automatically according to the remaining volume of the disc. Some contents may not be recorded on the disc even if you select this function. This is not the function to make full use of the remaining space capacity.

## Notes

- The disc tray does not close automatically, even when the recording start time arrives. Set the recorder loaded an available DVD-RAM/R/RW disc beforehand.
- When there is little time before a programmed recording starts, you may not be able to start another recording.
- Playback pauses when a programmed recording starts.
- Do not change the “TV/Cable” selection of the Initial settings while a recording is programmed. If you want to change it, cancel the program recording. After then, make the programming again if necessary.
- Confirm the “DVD compatible mode” (➡ page 33) setting. “Main” or “SAP” records main sound or sub-sound of multiplex broadcasts respectively, and does not record the other. Therefore, select “Main” or “SAP” only when you record onto a DVD-R/RW disc.
- When recording onto a DVD-R/RW disc, set “DVD compatible mode” (➡ page 33) to the desired recording sound for each timer program.

## ■ Setting the details for every timer program

You can specify detail items for each of your timer program.

### 1) Press QUICK MENU at step 4 on ➡ page 41.

Quick Menu is displayed.

e.g.

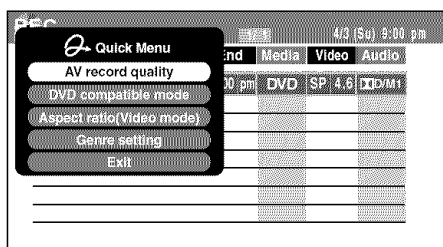

### 2) Press ▲ / ▼ to select an item and press SELECT/ ENTER.

For details, see “Quick menu items.”

## Quick menu items

### AV record quality

Select a recording mode.

### DVD compatible mode

When recording onto a DVD-R/RW disc, make this selection (➡ page 33) for each timer program. “Off” setting is neglected and regarded as “Main” in DVD-R/RW recording.

### Aspect ratio(Video mode)

Select the aspect ratio when recording onto a DVD-R/RW disc. (➡ page 33)

### Genre setting

You can set a genre before setting programmed recording.

To see the registered list, refer to Genre setting (➡ page 119).

Set the genre according to recording contents.

The selection you have made for the timer program is shown at the bottom of the display.

## Programming a recording (Continued)

### ■ Shifting the time period of a recording (Time Shift)

If a prior TV program extends beyond its scheduled time and into one that you programmed, you can shift the programmed start and end time of the recording.

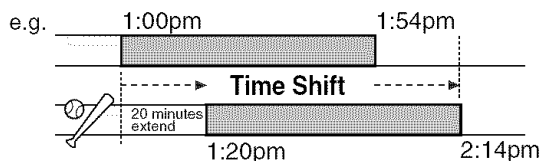

- 1) Press **EASY NAVI**.  
EASY NAVI Main Menu appears.
- 2) Press **▲ / ▼ / ◀ / ▶** to select “Timer Recording”, then press **SELECT/ENTER**.  
REC MENU appears.
- 3) Press **▲ / ▼** to select a timer program you want to shift the time period.
- 4) Press **EXTEND**.  
“Start” and “End” are ready to be input.
- 5) Press **EXTEND** repeatedly.  
Each time you press the button, “Start” and “End” is shifted in 10 minutes intervals to, up to 60 minutes later.
- 6) Press **SELECT/ENTER**.
- 7) Press **EASY NAVI** to exit.

#### Note

- After you shifted the time of a timer program which will be repeated daily or weekly, you should restore the original start/stop time for future recordings.

### ■ Adding a timer program

- 1) Press **EASY NAVI**.  
EASY NAVI Main Menu appears.
- 2) Press **▲ / ▼ / ◀ / ▶** to select “Timer Recording”, then press **SELECT/ENTER**.  
REC MENU appears.
- 3) Press **▼** to select a blank line, then press **SELECT/ENTER**.
- 4) Press **◀ / ▶** to select the item, then press **ADJUST** to set the item.
- 5) When complete, press **SELECT/ENTER**.
- 6) Press **EASY NAVI** to exit.

#### Note

- While the recorder is preparing for or executing a programmed recording, you cannot add a timer program which will start within 5 minutes and 15 seconds from the current time.

### ■ Deleting a timer program

- 1) Press **EASY NAVI**.  
EASY NAVI Main Menu appears.
- 2) Press **▲ / ▼ / ◀ / ▶** to select “Timer Recording”, then press **SELECT/ENTER**.  
REC MENU appears.
- 3) Press **▲ / ▼** to select a timer program you want to delete.
- 4) Press **QUICK MENU**.  
Quick Menu appears.
- 5) Press **▲ / ▼** to select “Program cancel”, then press **SELECT/ENTER**.  
Check the message, then delete the entry.
- 6) Press **EASY NAVI** to exit.

#### Note

- You cannot delete a timer program while another is executed.

### ■ Correcting a timer program

- 1) Press **EASY NAVI**.  
EASY NAVI Main Menu appears.
- 2) Press **▲ / ▼ / ◀ / ▶** to select “Timer Recording”, then press **SELECT/ENTER**.  
REC MENU appears.
- 3) Press **▲ / ▼** to select a timer program you want to change, then press **SELECT/ENTER**.
- 4) Press **◀ / ▶** to select an item, then press **ADJUST** to set the item.
- 5) Press **SELECT/ENTER**.  
The modification is registered.
- 6) Press **EASY NAVI** to exit.

#### Important

- You cannot correct a timer program within 5 minutes before the recording start time. You can only delete the timer program.

#### Note

- You can program a timer recording whose start time has already passed, unless the another program recording will start within 5 minutes. The portion of the program before the recording starts cannot be saved.

## ■ Remaining volume

- 1) Press **EASY NAVI**.  
EASY NAVI Main Menu appears.
- 2) Press **▲ / ▼ / ◀ / ▶** to select “Timer Recording”, then press **SELECT/ENTER**.  
REC MENU appears.
- 3) Press **QUICK MENU**.  
Quick Menu appears.
- 4) Press **▲ / ▼** to select “Disc budget calculation” then press **SELECT/ENTER**.  
Disc budget calculation menu appears.
- 5) Press **▲ / ▼** to select a timer program, then press **SELECT/ENTER** or press **ADJUST**.  
The recorder calculates on a bar graph how much a specific program (identified by a check mark) will occupy on the disc.  
Pressing **ADJUST** button can display or remove the check mark.

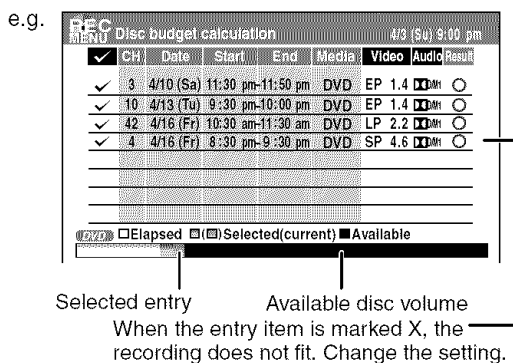

- 6) Correct the parameters of the timer program if necessary.  
(Skip to step 8), if you do not need this.)

You can change “Video”.

Select an item you want to modify and press **SELECT/ENTER** button. The item will be ready to be altered. Press **ADJUST** button to modify. When complete, press **SELECT/ENTER** button.

You can adjust to a lower mode to reduce the quality of the recording, and thus provide more disc capacity (space).

- 7) Press **★**.  
Program modification is registered.
- 8) Press **EASY NAVI** to exit the GUI.

## Notes

- The nearest 8 programs are calculated at a time.
- While the recorder is preparing for or executing a programmed recording, any program modification cannot be registered. Only programs which will start after 5 minutes or later can be modified.
- Available disc volume is not displayed for a DVD-R/RW disc on which DVD-Video finalize process was executed.

## ■ To stop a programmed recording

To finish,

Press **■** on the front panel twice.

When you press it once, a message appears. While the message is displayed, press **■** button once again.

## ■ Turning the power off automatically after completing a programmed recording

- 1) While executing a programmed recording, press **QUICK MENU**.  
Quick Menu appears.
- 2) Press **▲ / ▼** to select “Auto power off” then press **SELECT/ENTER**.

## ■ Keeping the power on even after the programmed recording finished

If the recorder turns itself on to execute a programmed recording, it will turn itself off after finishing the recording. You can restrict this and keep the recorder powered on.

- 1) While executing a programmed recording, press **QUICK MENU**.
- 2) Press **▲ / ▼** to select “Continuous power on” then press **SELECT/ENTER**.

### Programing a recording (Continued)

#### ■ Delaying the end time of a programmed recording while it is recording

**While a programmed recording is in progress, press EXTEND.**

The first press displays the programmed end time (in the front panel display).

Each time you press the button, it is delayed 10 minutes, up to 60 minutes.

#### **Notes**

- Pressing a button except EXTEND in the above procedure will set the currently selected delay.
- You cannot delay the end time of a programmed recording which will end within 1 minute from the current time.
- Even if you delay the end time of a programmed recording, the recording will stop when the disc is exhausted.

# Others

## To delete recorded content

DVD-RAM DVD-RW DVD-R

### Important note

Any deleted title/chapter (original) cannot be restored. Before deleting, be sure to check contents on the disc.

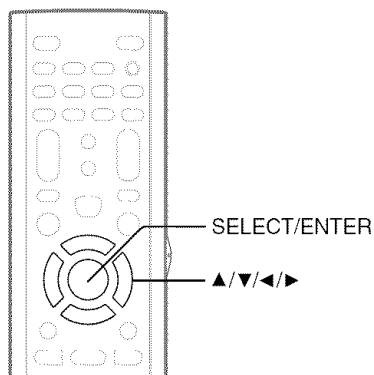

- 1) Perform steps 1 and 3 in “Playing recorded contents” (▶ page 51) to select a title (chapter).
- 2) Press QUICK MENU, then press ▲ / ▼ to select “Title delete” (“Chapter delete”) and press SELECT/ENTER.
- 3) Read the message and press ◀ / ▶ to select “Yes,” then press SELECT/ENTER.

### Notes

- When you display a title to delete, on the finder of EASY NAVI Main Menu, you can delete it by selecting “Delete Title” then press SELECT/ENTER button. Operate according to the message.
- Deleting a title (a chapter) decreases the numbers of the succeeding titles (chapters).
- A chapter of about 5 seconds or shorter may not be deleted. Deleting a short chapter may not change the display of the available disc volume.
- Deleting a playlist title/chapter does not affect the original title/chapter.
- Deleting an original title/chapter affects all the corresponding playlist title/chapters.
- Deleting all chapters in a title erases the title itself.
- Title and chapter which contains still pictures cannot be deleted.
- On a DVD-R/RW disc, deleting is not possible if the disc is finalized (▶ page 100).
- Chapters in a DVD-R/RW disc cannot be deleted.
- On a DVD-RW disc, only a title last recorded can restore the disc capacity by being deleted.
- On a DVD-R disc, deleting cannot restore the disc capacity.

## To protect recorded content

DVD-RAM

You can protect recorded content from unexpected deletion.

Protection is provided for each title (original).

- 1) Perform steps 1 and 3 in “Playing recorded contents” (▶ page 51) to select a title.
- 2) Press QUICK MENU, and press ▲ / ▼ to select “Title information”. Then press SELECT/ENTER.
- 3) Press QUICK MENU, and press the ▲ / ▼ to select “Lock” and then press SELECT/ENTER. The mark  appears.

### Notes

- To cancel protection, repeat this procedure.
- Disc initialization erases all titles on a disc even if they are protected.

## Technical information

### ● About recording time

The recording time of a typical VCR (Video Cassette Recorder) is determined by the length of a video tape and recording speed (SP, LP, etc.). Video tapes with various recording times are available in the market. On the other hand, the recording time of a DVD-RAM/R/RW depends on the bit rate (Mbps: amount of data transmitted per second), which can be varied in MPEG2 (Moving Picture Experts Group2) compression technology.

As an example, when you pour water into a bucket from a faucet, the faster the water flows, the sooner the bucket is filled with water. On the other hand, the slower the water flows, the more slowly the bucket is filled. The DVD-RAM/R/RW is, so to speak, such a bucket, and the degree you turn the faucet is bit rate, the time required to fill the bucket with water is the recording time available for a disc. The higher you set the bit rate (making much more water flow), the sooner a disc is filled. Consequently, the recording time becomes shorter. The lower you set the bit rate, the longer time it takes to fill a disc.

### ● About picture quality (XP, SP, MP, LP, EP)



The higher you set the bit rate, the more the volume of information for the picture. The lower the bit rate, the less the volume of picture information. However a high bit rate does not always mean that the picture quality is high. The difference between the 1.4 Mbps and 9.2 Mbps is obvious, but when comparing similar bit rates, the difference may be insignificant. Generally when you set the bit rate low for longer recording time, the data volume shortage will result in a lack of detail information. As a result, the picture quality is decreased (more noticeable with dynamically moving images). For example, square noises (block noise) may occur in a scene with fast action or a scene with light and shadows, such as a water surface.

This recorder has 6 settings. (e.g. "SP" records about 2 hours and "LP" about 4 hours onto a blank 4.7 GB DVD-RAM disc.  page 125) It is recommended to consider the "SP" mode as a standard mode and use the lower mode when you want to record for long time regardless of the picture quality. If you want to record for within 2 hours select the "AT" mode.

On a blank 4.7 GB DVD-RAM disc, the "AT" mode automatically sets the appropriate bit rate corresponded to the recording time from about 1 hour to up to 2 hours so that you can achieve the best picture quality. If a part of a DVD-RAM disc has already been recorded, the "AT" mode sets the bit rate suitable for the remaining space on the disc. (The picture quality is determined referring the remaining space just before recording. When the remaining space is scarce in the disc, the picture quality may decrease from what you set beforehand or the recording may stop halfway.) "AT" mode is available also on DVD-R/RW recordings.

When you want to record a music program or animation with high picture quality, it is recommended that you select the "XP" mode. If you select more than 6 Mbps, you can usually record with considerably higher picture quality. However the higher you set the bit rate, the shorter the recording time.

### ● D /M1

Sound recording format onto DVD-RAM discs. When recording, sounds are converted into digital signals and compressed. In playback, they are extracted to the original sound.  D /M1 is applied the digital recording technology for consumer products of Dolby Laboratories. Dolby Digital 192 kbps is set for  D /M1.



# Playback

Play your favorite contents.

- Information on playback
- Playing recorded contents
- Playing a DVD video disc
- Pausing a TV broadcast to resume later (Pause TV)
- Playing a TV program currently being recorded (Chase Play)
- Playing at various speeds
- Locating by entering the number
- Selecting the camera angle
- Selecting subtitles
- Zooming a picture
- Selecting the sound
- Viewing JPEG files
- Playing MP3/WMA files
- Pausing a TV broadcast (Freeze function)
- Checking the current status and settings
- Functions in the Quick Menu

# Information on playback

The operation procedure depends on the kind of disc. See the respective pages for basic procedure to play the disc.

## ■ To play contents recorded onto a DVD-RAM disc

Playing recorded contents (▶ page 51)

## ■ To play a DVD video disc

Playing a DVD video disc (▶ page 55)

## ■ To play a DVD-R/RW disc

DVD-R/RW discs recorded on this recorder  
Playing recorded contents (▶ page 51)

DVD-R/RW discs recorded on other devices  
Playing a DVD video disc (▶ page 55)

## ■ To switch the picture to view TV broadcasts

Press STOP button to stop playback.

## ■ To start recording

Press STOP button to stop playback.  
Then press REC button to start recording.

## ■ Screen Protection

If you pause playback, display a menu or use the freeze function and leave it still for about 15 minutes, the recorder switches the output picture source to a TV broadcast or connected equipment.

A still picture may be displayed after all titles are played. In this case, the screen protection activates after about 10 seconds.

## Notes

- Do not move the recorder during playback. It may damage the disc.
- Occasionally the picture may stop at the last scene, or the main menu may appear after playing.  
If you display a still picture such as the main menu on the TV screen for a prolonged period, the TV may be damaged (image burn). To prevent this, press STOP button to stop playback.
- A still picture for about 15 minutes while TIMESLIP indicator illuminates, will return to normal playback. If the playback is completed, a still picture of the title end will continue unless you press TIMESLIP button.

# Playing recorded contents

Titles and chapters recorded on a DVD-RAM/RW disc are displayed in thumbnail view, so that you can easily locate a desired one.

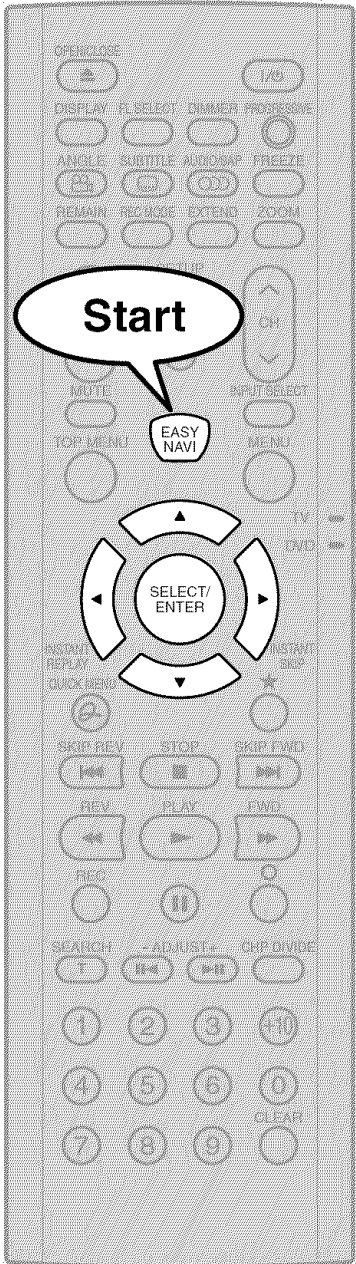

## 1 Press EASY NAVI.



EASY NAVI Main Menu appears.

## 2 Press ▲/▼/◀/▶ to select "Play Contents", then press SELECT/ENTER.

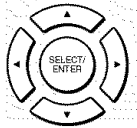

CONTENT MENU Title List appears.

e.g.

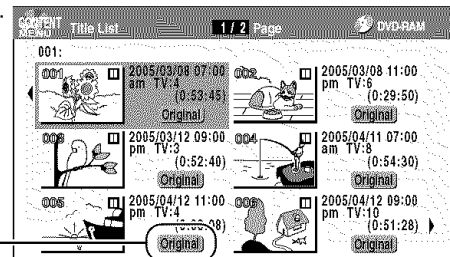

Attribution (Original/Playlist)

## 3 Press ▲/▼/◀/▶ to select a title (chapter).

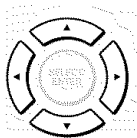

You can view succeeding or prior pages by pressing REV or FWD button.

To select a chapter, select a title and press ★ button. Chapter List appears.

By pressing ★ button again, you can return to Title List.

## 4 Press SELECT/ENTER.

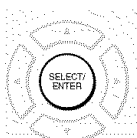

Playback starts from a selected title (chapter).

## Playing recorded contents (Continued)

### Notes

- On CONTENT MENU, titles (Original) precede titles (Playlist), in order from the oldest one respectively.
- To turn off CONTENT MENU, press EASY NAVI button. Absence of operations for longer than about 15 minutes also turns off CONTENT MENU.
- The mark **■** is displayed in every thumbnail when “Title playback” (➡ page 116) is set to “Title resume”. When set to “Serial playback”, it is displayed in a thumbnail last operated.
- You can change a thumbnail picture. See ➡ page 93.
- You cannot display CONTENT MENU for DVD-R/RW discs recorded on other devices.
- For playing a recorded title while recording another, see ➡ page 37.
- A black thumbnail with “Recording” means that the title is being recorded or its recording will start within 15 seconds. This thumbnail cannot start playback.
- When the recording mode is set to “XP” or “AT” (when a high bit rate is automatically set ➡ page 42), playback will not be available several minutes before recording starts.

### ■ To stop playback

Press **STOP**.



### ■ To pause playback (still playback)

Press **||**.



To resume normal playback, press PLAY button or **||** button.

### Note

- Sound is muted during still mode.

### ■ Resuming playback from the location last stopped (Title resume) **DVD-RAM**

The recorder memorizes the location you last stopped playback to resume there.

To use this function, set “Title playback” (➡ page 116) to “**Title resume.**” The recorder will memorize the location you last stopped at in each title, so you can resume playback there. For example, if there are 6 titles, you can start each of them as if you had stored 6 video tapes in the recorder.

#### • To return to the beginning of the title

During playback, press QUICK MENU button, then press **▲ / ▼** buttons to select “Restart title,” then press SELECT/ENTER button.

#### • To play another title

Perform steps 1 to 4 on ➡ page 51.

You can make the recorder memorize only the very last point, regardless of the number of titles. Set “Title playback” (➡ page 116) to “**Serial playback.**”

#### • To return to the beginning of the title

Press SKIP REV button repeatedly until the beginning of the title appears.

#### • To play the other title

Press SKIP REV or SKIP FWD button repeatedly.

### Notes

- Depending on conditions or contents, playback may not start from the location last stopped, but instead of another location. For example, from the beginning of the disc or title.
- Depending on a disc, there may be a slight difference between the location the recorder memorizes and the actual location where playback starts.
- This function is not available on DVD-R/RW discs.
- The resuming function will not work if the write-protect tab is set to “PROTECT” (➡ page 8).

### ■ Playing all titles (Original/Playlist) in a disc

#### **DVD-RAM**

Set “Title playback” (➡ page 116) to “Serial playback”. You can play all titles in a DVD-RAM disc in the order of the thumbnails on CONTENT MENU, as if they were recorded in one video tape.

## ■ Checking the background information on a selected title

- 1) At step 3 on  page 51, select a title (chapter) then press QUICK MENU.

Quick Menu appears.

- 2) Press  /  to select “Title information”, then press SELECT/ENTER.

Detailed information of a selected title (chapter) appears.

e.g.

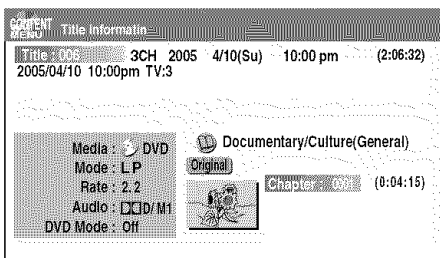



Changing the title information:

- 1) While “CONTENT MENU Title Information” is displayed, press QUICK MENU.

Quick Menu appears.

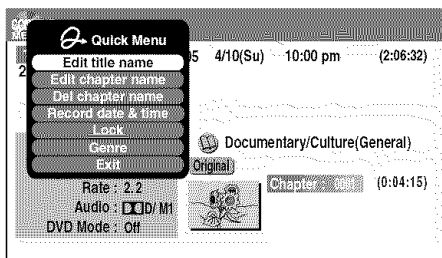
e.g.



- 2) Press  /  to select an title, then press SELECT/ENTER.

Edit title name:

The on-screen keyboard appears.

Following the procedure on  page 30, enter a new name for the title.

Edit chapter name:

(First press FWD or REV button to display the chapter you want, to put a name for, and select the chapter.)

The on-screen keyboard appears.

Following the procedure on  page 30, enter a new name for the chapter.

Del chapter name:



(First press FWD or REV button to display the chapter you want, then select this item.)

Record date & time:

The recording date is highlighted so that you can correct the digits.



Lock:

Set the protection for the currently selected title.

The protection icon “” appears. ( page 47)

Genre:

The submenu appears.

Press  /  buttons to select a genre, then press the SELECT/ENTER button.

A name of the selected genre and the icon appear.

### Notes

- To change the title information, be sure to load a DVD-RAM/R/RW disc which contains the desired title.
- You may not be able to change the title name, etc. of a DVD-R disc, if the disc is in a certain condition such as a minimal remaining space.
- You cannot set the protection of titles in DVD-R/RW discs.
- By pressing the O button, you can return to the previous display.
- To exit these steps, press EASY NAVI button.

## Playing recorded contents (Continued)

## ■ Viewing information of a loaded disc

- 1) Press **EASY NAVI**.  
EASY NAVI Main Menu appears.
- 2) Press **▲ / ▼ / ◀ / ▶** to select “Play Contents”, then press **SELECT/ENTER**.
- 3) Press **QUICK MENU**.  
Quick Menu appears.
- 4) Press **▲ / ▼** to select “Disc information”, then press **SELECT/ENTER**.

You can view information on a loaded disc.

e.g.

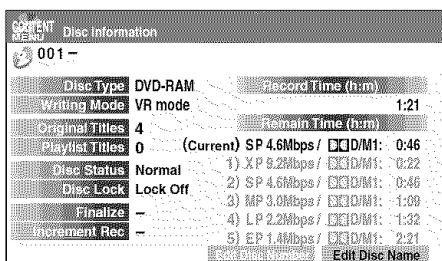
Changing the disc information:

You can change the number or name of a DVD-RAM disc. You can also change the name of a DVD-RW disc.

- 1) Press **◀ / ▶** to select “Edit Disc Number” or “Edit Disc Name”, then press **SELECT/ENTER**.
- 2) Following the procedure on  page 30, enter a new name for the disc.  
To change the disc number, press ADJUST button.

**Notes**

- You cannot change the disc name of a blank DVD-R disc. After recording, change the disc name.
- You may not be able to change the disc name of a DVD-R disc, if the disc is in a certain condition such as a minimal remaining space.

# Playing a DVD video disc

You can also play VIDEO CDs, audio CDs or finalization processed DVD-R/RW discs in the same manner. To play recorded contents, follow the instructions on  page 51.

## ■ Preparation

- Turn on a TV or audio system and select the corresponding input source that the recorder is connected to.
- Load a disc you want to play. ( page 20)

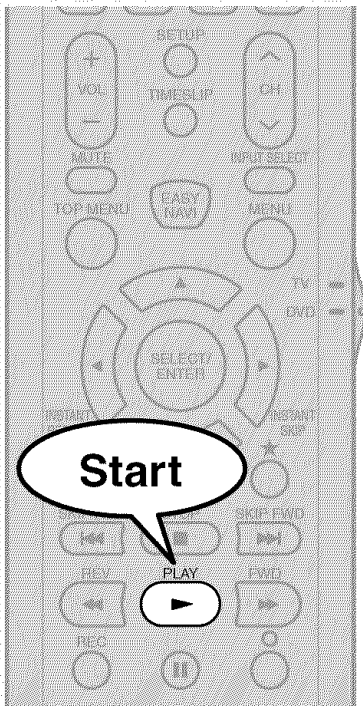

## 1 Press PLAY.

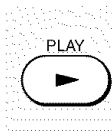

Playback starts.

- Depending on the disc, playback starts automatically by loading the disc.
- The recorder may take a short time to start playback. This occurs because the recorder is reading the data of a disc.

## ■ To stop playback Press STOP.



## ■ To pause playback (still playback) Press II.



To resume normal playback, press PLAY button or  button.

### Note

- Sound is muted during still mode.

### Note

- DVD video disc provides high resolution pictures and a lot of information. Because of this, you may notice some fine picture noises on TV screen, which you have never seen with regular broadcast TV program. While the amount of noise depends on the TV you use with the recorder, you should generally reduce the sharpness adjustment on your TV when viewing DVD video discs.

#### ■ Resuming playback from the location last stopped (Resume Play)

DVD-RW | DVD-R | DVD-VIDEO | VCD | CD

You can resume playback from the location where you stopped at.

If you press PLAY button after stopping playback, playback resumes from the location you have stopped.

If you stop playback by pressing STOP button twice, the resume playback feature will be canceled.

#### Notes

- Resume feature cannot function when:
  - you select a disc menu language (▶ page 110) or change the parental lock setting (▶ page 111).
  - you open the disc tray.
  - you cancel the DVD-Video finalizing process of a DVD-RW disc.
- There may be a difference in the location where playback resumes depending on the disc.
- While the recorder retains a location in memory, initial setting changes with GUI may function only after the memory is cleared.

#### Locating a title using the top menu

DVD-RW | DVD-R | DVD-VIDEO

Some DVD video discs may include a top menu, on which you can view the structure of contents or select a scene. Most of the top menus automatically appear in certain scenes, and also are displayed on demand. Actual operation of the top menu depends on the disc. This section explains a general example of how to operate a top menu. Also refer to the instructions of the disc itself.

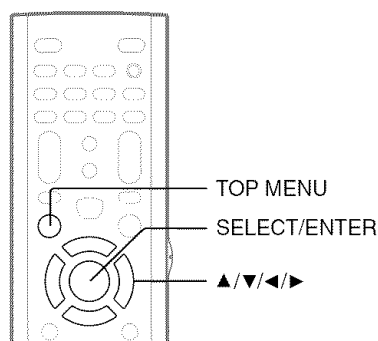

1) Press TOP MENU.

2) Press ▲/▼/◀/▶ to select the title you want.

If the titles in the top menu are assigned a number, you can directly locate a specific title by pressing its designated number with the number buttons.

3) Press SELECT/ENTER.

#### Notes

- The instructions above describe basic procedures which may vary depending on the contents of a DVD video disc. If different instructions appear on the TV screen, follow those instructions.
- If you display the top menu during playback and press TOP MENU button again without selecting any title, the recorder may resume playback from the point where you first pressed TOP MENU button. (depending on the actual DVD video disc.)
- This method of locating a title is available only on a disc that contains a top menu.
- Instruction notes of discs may refer to the button that displays the top menu as TITLE button.



# Pausing a TV broadcast to resume later (Pause TV)

This function enables you to pause a TV broadcast and resume viewing at a later, more convenient time, by storing the TV broadcast temporarily on a DVD-RAM disc.

When this function is used, a DVD-RAM disc which can be recorded needs to be loaded into the recorder beforehand.

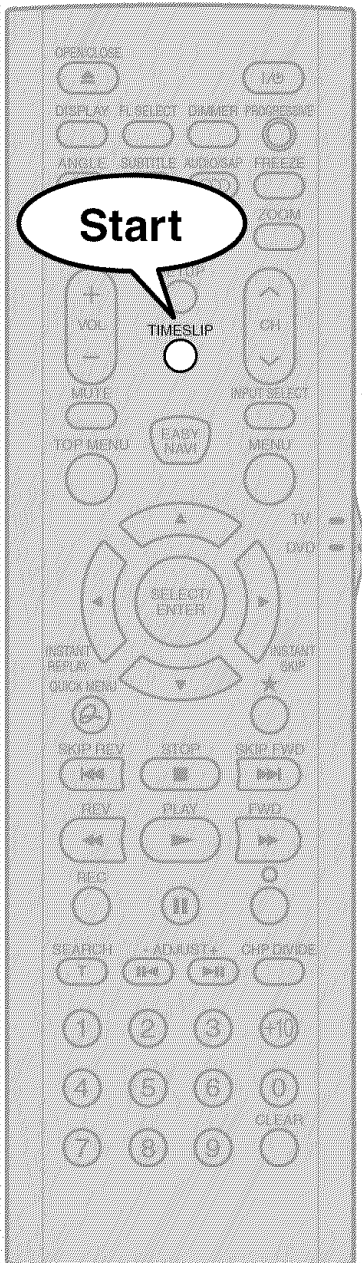

## 1 While viewing a TV broadcast via this recorder or immediately before it starts, press TIMESLIP.

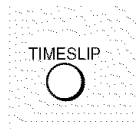

When Pause TV mode is ready, playback stops automatically.

The recorder begins to store the broadcast on a DVD-RAM disc the moment you press TIMESLIP button.

## 2 Locate a scene you want by the following methods.

### Fast-forward/fast-reverse:

Press FWD or REV button.

### Forward/reverse Slow-motion:

First press **||** button then press FWD or REV button.

### Forward/reverse frame by frame play:

First press **||** button then press ADJUST button.

- To resume normal playback, press PLAY button.
- You can play in fast-forward to within 10 seconds prior to the current broadcast.

## 3 Press TIMESLIP to exit this mode.

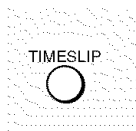

The recorder stops storing the broadcast on a DVD-RAM disc.

A message appears and asks you whether you will save the stored data or erase it.

Press **◀/▶** buttons to select, then press SELECT/ENTER button.

- When the recording mode is set to "XP", the recorder automatically changes "XP" to "SP" to record the broadcast.

### Notes

- This function is not available during recording.
- Pause TV recording stops when the DVD-RAM disc is filled up. It will not begin if a DVD-RAM disc is full.
- While using this pause TV recording, you cannot program a recording.
- Playback may jump a few seconds back or pause depending on a disc or data condition.

# Playing a TV program currently being recorded (Chase Play)

You can begin playback from the beginning of a program currently being recorded. You will find this function of great advantage on long programs, as you do not have to wait for the end of recording to begin playback.

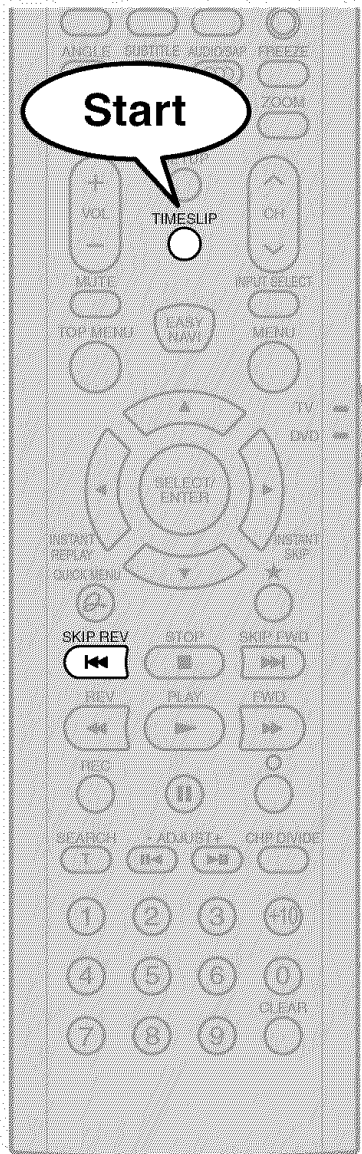

## 1 While recording a TV program on a DVD-RAM disc, press TIMESLIP.



The recorder displays a TV program as it is being recorded.

## 2 Go back to the beginning of the TV program using SKIP REV.



When you go back to the beginning, playback starts automatically.

You can confirm how far you are from the current broadcast by selecting "Time bar" from Quick Menu.

## 3 Locate a scene you want through the following operations if necessary.

### Fast-forward/fast-reverse:

Press FWD or REV button.

### Forward/reverse Slow-motion:

First press ■■ button then press FWD or REV button.

### Forward/reverse frame by frame play:

First press ■■ button then press ADJUST button.

- To resume normal playback, press the PLAY button.
- You can play in fast-forward to within 10 seconds prior to the current broadcast.

## 4 Press TIMESLIP to exit.

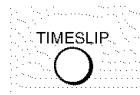

The current broadcast returns.

### Notes

- Time slip recording/playback stops when the DVD-RAM disc is filled up. You can play up to a location where the recorder stopped the recording. The time slip recording/playback cannot begin if a DVD-RAM disc is full.
- The playback picture may appear after a delay of several seconds.
- The playback location will never be identical to the record location in the program. It will always trail the record location by a few seconds.
- While using time slip recording/playback, you cannot program a recording.
- While the TIMESLIP indicator is on, you cannot change the setting of the feature that turns off the recorder after a programmed operation has finished.
- Even while "Auto power off" is selected, the recorder does not turn off if the recording end time comes during playback of a program being recorded.
- Playback may jump a few seconds back or pause depending on the disc or data condition.
- When a timer recording or normal recording is executing with the recording mode "XP" or "AT" (when a high bit rate is automatically set. ➡ page 42), this function is not available.

# Playing at various speeds

## Playing in fast reverse or fast forward

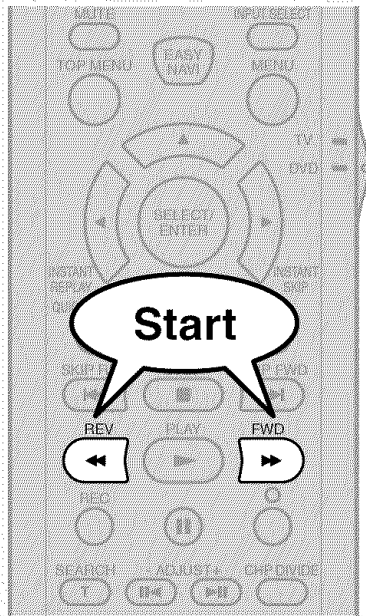

### 1 During normal playback, press FWD or REV.



FWD : Fast forward playback  
REV : Fast reverse playback

Each time you press the button, the playback speed changes.

During fast forward playback at “>>” speed, sound is reproduced. (Not available on VIDEO CD.)

- This function is not available when you play a title recorded on a DVD-RAM disc while recording another.

#### Notes

- The playback speed may vary depending on a disc.
- Depending on the disc or data condition, picture and sound in fast forward playback at “>>” speed may be disturbed.

- **To resume normal playback**  
Press **PLAY**.

- **To skip the contents in pre-determined increments**

**During playback, press INSTANT SKIP.**

Each time you press the button, you can skip by the specified time.

You can select the interval per press of the button. See “Instant skip interval” (▶ page 116).

#### ■ Time bar display

Fast-forward or fast-reverse playback automatically displays a time bar.

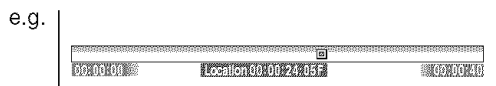

For details, see ▶ page 76.

- **To skip back in pre-determined increments**  
**During playback, press INSTANT REPLAY.**

Each time you press the button, you can go back by the specified time to resume playback.

You can select the interval per press of the button. See “Instant replay interval” (▶ page 116).

#### Notes

- Some discs may not permit this operation.
- Depending on the structure of a disc, some operations may be limited.
- Depending on playback status, some operations may not work.

**Skipping to the next/previous chapter or track** DVD-RAM DVD-RW DVD-R DVD-VIDEO VCD CD



**1 Press SKIP FWD or SKIP REV repeatedly until the chapter or track number you want appears.**



Playback starts from the selected chapter or track.

SKIP FWD : Playback starts from the beginning of the next chapter or track.

SKIP REV : Playback starts from the beginning of the current chapter or track. When you press twice, playback starts from the beginning of the previous chapter or track.

**Notes**

- Some titles may not display chapter numbers.
- When playing a DVD-RAM disc, you can access chapters only in the current title if “Title playback” (page 116) is set to “Title resume”. To access chapters in other titles, set to “Serial playback”.
- When playing a DVD video disc or a DVD-R/RW disc, you can locate chapters only in the current title if “DVD title stop” (page 112) is set to “On”. To access chapters in other titles, set to “Off”. However, in this instance even though you press the SKIP REV button to go back to the previous title, playback starts not from the last chapter of the title but from the first chapter.

**Playing in slow-motion** DVD-RAM DVD-RW DVD-R DVD-VIDEO VCD

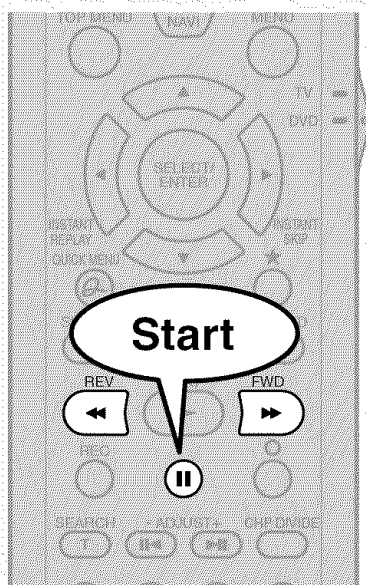

**1 Press || during playback.**

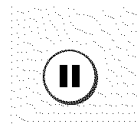

**2 Press FWD or REV.**

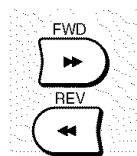

FWD : Forward slow-motion  
 REV : Reverse slow-motion

Each time you press the button, the slow-motion speed changes.

**Notes**

- Slow-motion does not provide smooth playback.
- When playing a VIDEO CD, reverse slow-motion playback is not available.
- The speed level displayed is approximate.

**■ To resume normal playback Press PLAY.**

### Playing frame by frame DVD-RAM DVD-RW DVD-R DVD-VIDEO VCD

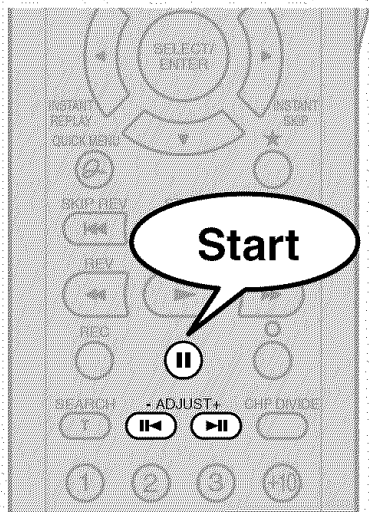

#### 1 During playback, press **II**.

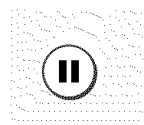

A still picture is displayed.

#### 2 Press **ADJUST (-/+)**.

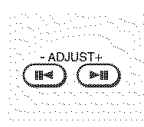

+ : Playback direction  
 - : Opposite direction

■ To resume normal playback  
 Press the **PLAY** or **II** button.

#### Notes

- Sound is muted during frame by frame playback.
- Frame by frame playback cannot provide smooth playback.
- Picture may advance more than 1 frame at a time.
- Depending on the scene, some frames may not be played.
- When playing a VIDEO CD, reverse frame by frame playback is not available.

### Viewing still pictures (Playing a disc that contains still pictures) DVD-RAM DVD-VIDEO

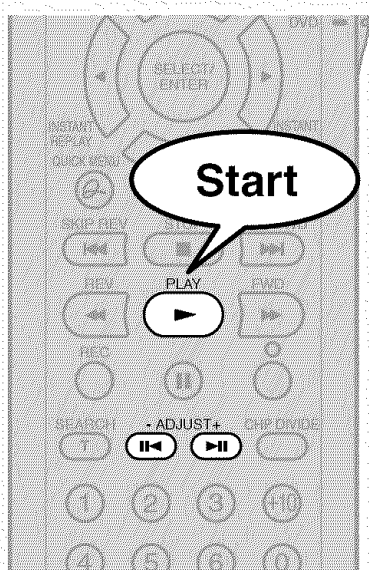

#### 1 Press **PLAY**.

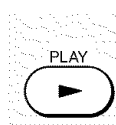

The first still picture on a disc is displayed.

Some DVD video discs may allow you to change the pictures using **PLAY**, **SELECT/ENTER** or **SKIP FWD** or **SKIP REV** button.

#### 2 Press **ADJUST (-/+)**.

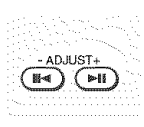

+ : Displays the next still picture.  
 - : Displays the previous still picture.

# Locating by entering the number

## Locating by entering the number of a desired section

Normally titles, chapters, and tracks are numbered. By entering these numbers, you can access a desired section.

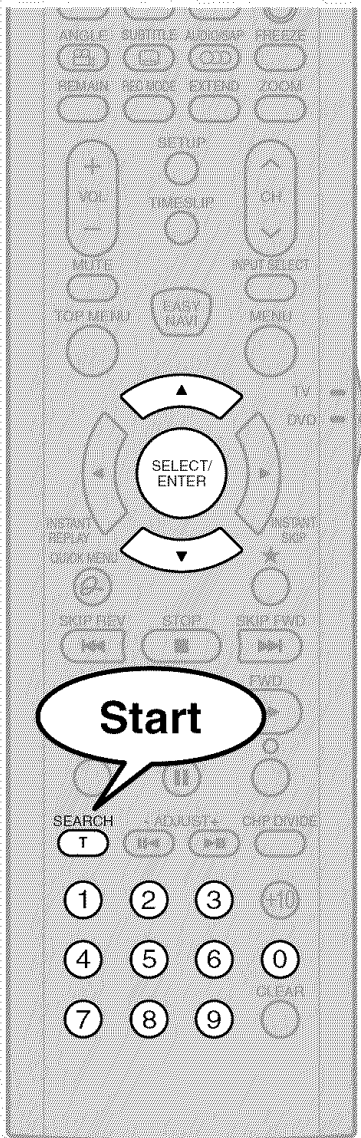

### 1 Press SEARCH.

If you are using a VIDEO CD/audio CD, skip step 2.  
e.g.

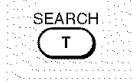

### 2 Press ▲ / ▼ to select a section (title or chapter) you want to locate.

e.g. When you want to locate a chapter.

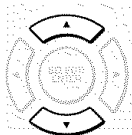

### 3 Press the number buttons to enter a number of the section.

e.g. To enter 25, press "2", then press "5".

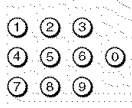

### 4 Press SELECT/ENTER.

Playback starts from the selected location.

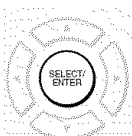

**Notes**

- Pressing CLEAR button resets the numbers. To clear the display, press SEARCH button several times (depending on a disc).
- This method of locating a title is available only on a disc that contains title numbers.
- If a title is erased, the numbers of the following titles decrease respectively.
- When you record a new title (Original) on a DVD-RAM disc, it is added prior to current titles (Playlist), and each following title (Playlist) reference number will advance by a factor of 1.

## Locating a specific point by entering its elapsed time (Time Search)

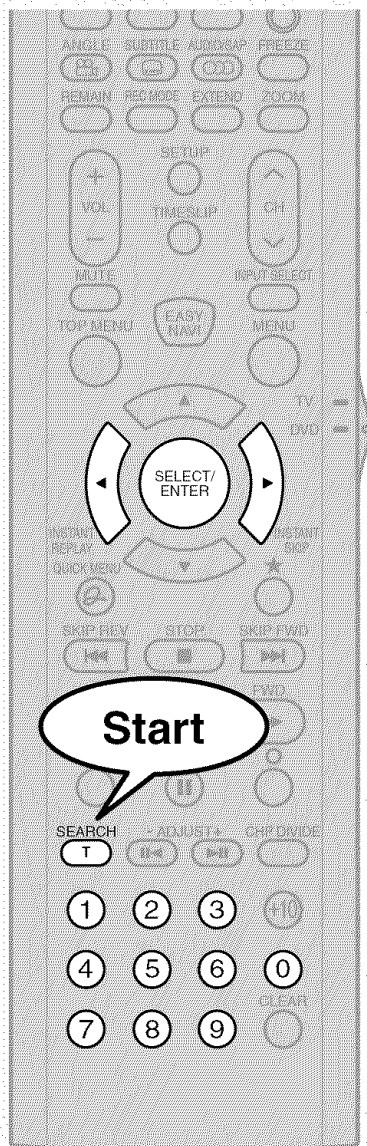

### 1 Press SEARCH.



You may have to press repeatedly, depending on a disc. Press the button until the following display appears.

e.g.

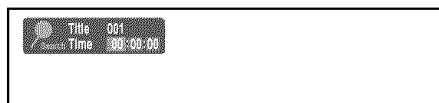

### 2 Press the number buttons and ◀/▶ to enter the desired time location on the disc.

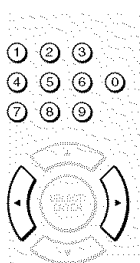

e.g. To enter 1 hour, 25 minutes, and 30 seconds



hour → minute → second

### 3 Press SELECT/ENTER.

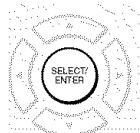

Playback starts from the selected location.

#### Notes

- Some discs may not respond to this process.
- Some scenes may not be accessed precisely as you specified.
- This method for accessing specific locations is available only within the current title of a DVD-RAM/R/RW/DVD video disc or within a current track of a VIDEO CD/audio CD.
- Pressing CLEAR button resets the numbers.

# Selecting the camera angle

If the scene was recorded with multiple angles, you can easily change the camera angle of the scene you are watching.

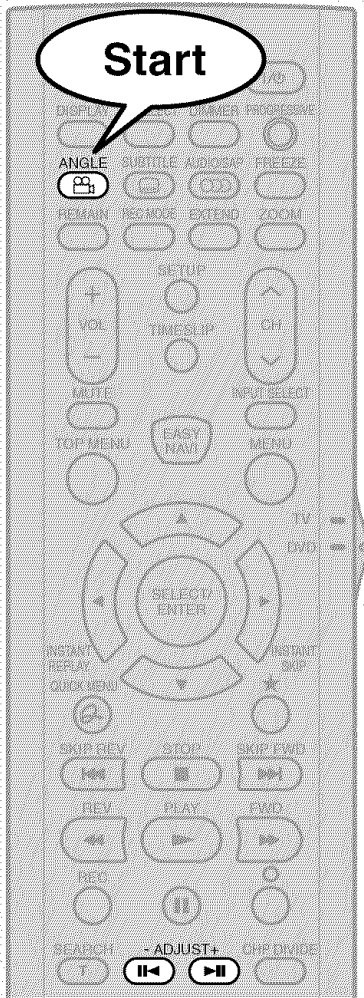

## 1 Press ANGLE while playing a scene recorded with multiple angles.

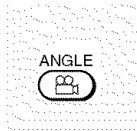

While playing a scene recorded with multiple angles, the angle icon appears on the TV screen and on the front panel. Press ANGLE button while the angle icon is displayed.

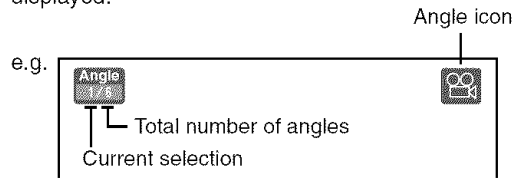

## 2 Press ADJUST while the angle number is displayed on the TV screen.



You can also select the camera angle by pressing ANGLE button several times.



- The angle icon disappears after about 3 seconds if no further selections are made.

### Notes

- You can also change the camera angle during still playback. The camera angle changes to the new setting when you resume normal playback.
- If you pause a picture immediately after changing a camera angle, the resumed playback picture may not display the new camera angle.
- Depending on a disc, the camera angle may not change even though the angle number changes.



# Selecting subtitles

You can display subtitles on the TV screen and select a subtitle language from those included on the disc.

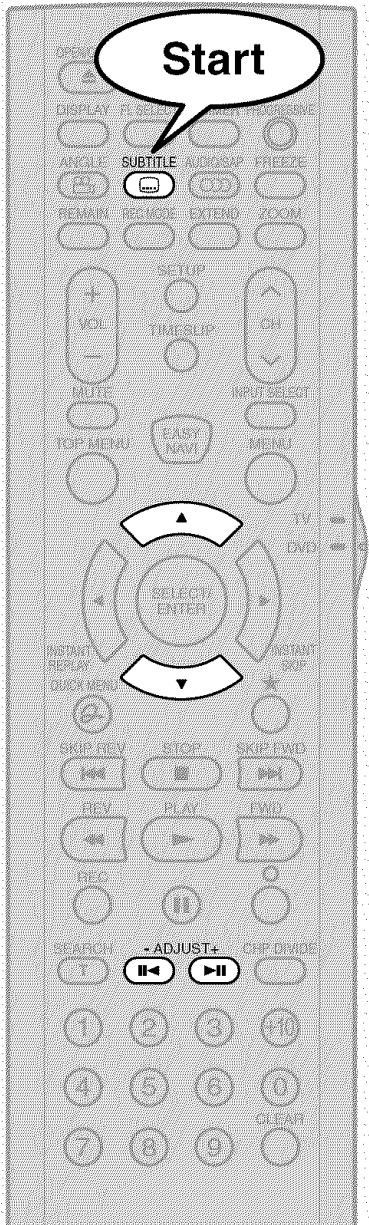

## 1 Press SUBTITLE during playback.

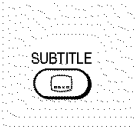

The current subtitle setting appears.

e.g.

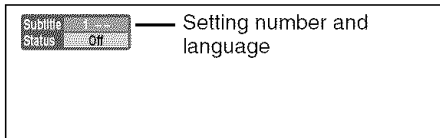

The language code appears instead of the language name. Refer to the list of languages and their abbreviations. (▶ page 126)

## 2 Press ▼ to select "Status," then press ADJUST to select "On."



Skip to step 3 if "On" is already displayed.

## 3 Press ▲ to select "Subtitle," then press ADJUST to select a language.

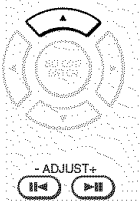

The subtitles of recorded languages appear.

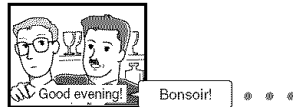

The display turns off after about 3 seconds if you do not make a selection.

### Notes

- Some DVD video discs are set to display subtitles automatically.
- Depending on the scene, subtitles may not appear immediately after you set the subtitle function to on.
- Some DVD video discs will allow you to change subtitle languages and turn subtitles on or off only via the disc menu.

### ■ To turn the subtitles on or off

At step 2, select "Off" by pressing ADJUST button.

# Zooming a picture

You can magnify areas within a picture.

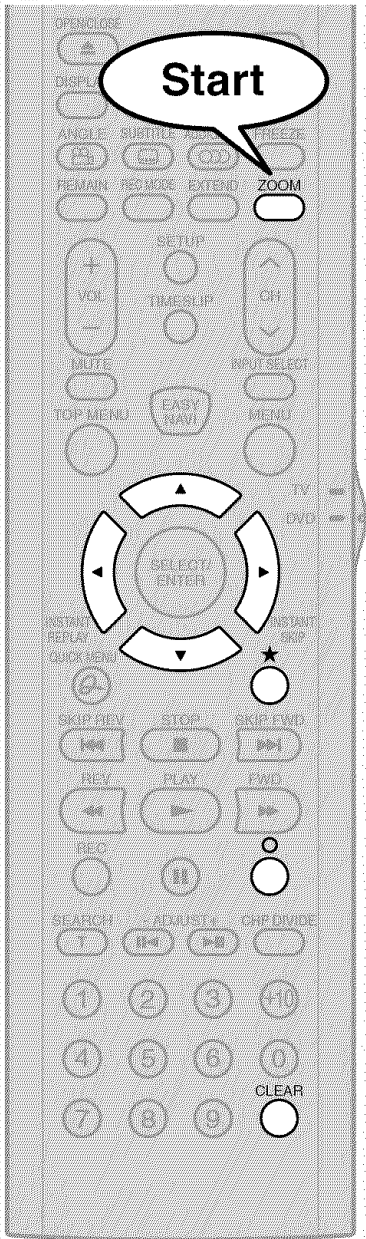

## 1 Press ZOOM.

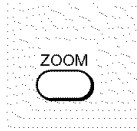

A zoom scope appears.

e.g.

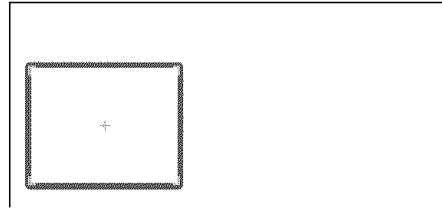

## 2 Select a zoom point and magnification level.

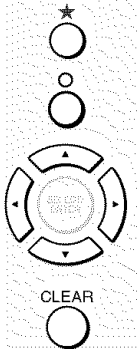

★:

Raises the magnification level.

○:

Lowers the magnification level.

▲/▼/◀/▶:

Moves the zoom point. (only after the image has been magnified)

CLEAR

CLEAR:

Returns the zoom point to the center of the picture.

### Notes

- Some discs may not respond to zoom feature.
- During some scenes, the buttons may not work as described.
- The zoom feature is canceled when the disc menu is operated.
- The magnification level varies depending on the picture size you select (▶ page 40, "INSTALLATION GUIDE").
- The zoom feature is not available while displaying a GUI.
- The zoom feature is canceled when you stop playback or start playback.

■ To cancel the zoom  
Press ZOOM.

# Selecting the sound

You can select a preferred language and a sound format.

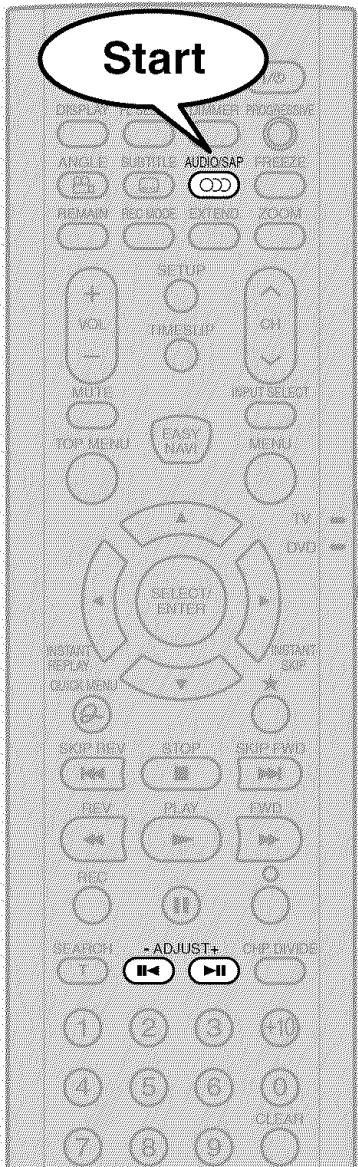

## 1 Press AUDIO/SAP during playback or while receiving a broadcast.



The current audio setting appears.

The language code appears instead of the language name. Refer to the list of languages and their abbreviations. (▶ page 126)

## 2 Press ADJUST while the audio setting is displayed on the TV screen.

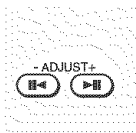

Variation of channels depends on the disc or the type of TV broadcast.

• **DVD-RAM**, TV channel signals

**Stereo sound**

→ "Stereo" (left channel and right channel)

→ "Stereo L" (left channel)

→ "Stereo R" (right channel)

(→ Back to "Stereo")

**SAP sound**

"Main" → "SAP" → "Main + SAP" (→ Back to "Main")

**DVD-RW** **DVD-R** **DVD-VIDEO**

Language name / sound recording system / No. of channels

e.g.

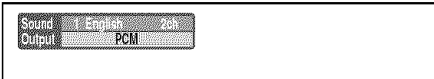

• **VCD**

"Stereo" → "Stereo L" → "Stereo R" (→ Back to "Stereo")

The display turns off if you do not operate for more than 3 seconds.

If you press the ▲ / ▼ buttons to select "Output," you can select the audio output setting (▶ page 114) by using ADJUST buttons.

### ■ MTS Broadcast Compatibility

This recorder can receive or record MTS (Multichannel TV sound) broadcast. By connecting the recorder to your stereo system or stereo TV, you will try the SAP or stereo sound.

#### SAP (Second Audio Program broadcast)

A separate audio program, usually broadcast in a second language with the main language.

#### Sounds in playback

You can play SAP and/or stereo broadcasts with this recorder. Refer to steps 1 and 2 to select a desired audio. While a SAP program is received, the SAP indicator on the front panel illuminates.

Selecting the sound (Continued)

**Recorded sounds**

According to your setting of "SAP" on the setup menu screen, (▶ page 114), the sound is recorded onto different channels of the disc below. Set "SAP" to "On" or "Off" appropriately.

| Setting on the setup screen |     | Type of receiving broadcast | Contents of recorded sound |       | Type of record |
|-----------------------------|-----|-----------------------------|----------------------------|-------|----------------|
| DVD Compatible Mode         | SAP |                             | Lch                        | Rch   |                |
| Off                         | Off | Stereo + SAP                | L                          | R     | Stereo         |
|                             |     | Mono + SAP                  | Mono                       | Mono  | Stereo         |
|                             |     | Stereo                      | L                          | R     | Stereo         |
|                             |     | Mono                        | Mono                       | Mono  | Stereo         |
|                             | On  | Stereo + SAP                | L + R                      | SAP   | Dual Mono      |
|                             |     | Mono + SAP                  | Mono                       | SAP   | Dual Mono      |
|                             |     | Stereo                      | L                          | R     | Stereo         |
|                             |     | Mono                        | Mono                       | Mono  | Stereo         |
| Main                        | Off | Stereo + SAP                | L                          | R     | Stereo         |
|                             |     | Mono + SAP                  | Mono                       | Mono  | Stereo         |
|                             |     | Stereo                      | L                          | R     | Stereo         |
|                             |     | Mono                        | Mono                       | Mono  | Stereo         |
|                             | On  | Stereo + SAP                | L + R                      | L + R | Stereo         |
|                             |     | Mono + SAP                  | Mono                       | Mono  | Stereo         |
|                             |     | Stereo                      | L                          | R     | Stereo         |
|                             |     | Mono                        | Mono                       | Mono  | Stereo         |
| SAP                         | Off | Stereo + SAP                | L                          | R     | Stereo         |
|                             |     | Mono + SAP                  | Mono                       | Mono  | Stereo         |
|                             |     | Stereo                      | L                          | R     | Stereo         |
|                             |     | Mono                        | Mono                       | Mono  | Stereo         |
|                             | On  | Stereo + SAP                | SAP                        | SAP   | Stereo         |
|                             |     | Mono + SAP                  | SAP                        | SAP   | Stereo         |
|                             |     | Stereo                      | L                          | R     | Stereo         |
|                             |     | Mono                        | Mono                       | Mono  | Stereo         |

## Notes

- Some discs allow you to change audio selections only via the disc menu. If this is the case, press MENU button and choose the appropriate language from the selections on the disc menu.
- When you turn on the recorder or replace a disc, the recorder returns to the initial default setting. (➡ page 110)  
Depending on a disc, a specific type of audio the disc has is output.
- Immediately after you have switched sounds, there may be a temporary discrepancy between the display and actual sound.
- The BITSTREAM/PCM jack may not output SAP sound you select. In this instance, set “Audio out select” to “PCM”. (➡ page 114)
- You cannot change SAP sound if recorded with “DVD compatible mode” (➡ page 33) set to “Main”. Even when “DVD compatible mode” (➡ page 33) is set to “Off,” the recorder regards it as “Main” when recording to a DVD-R/RW disc.

## ■ Output sound conversion table

| Disc                   | Sound format               | Audio setting (➡ page 114) and output in the default setting display |                       |                        |                       |                        |                       |
|------------------------|----------------------------|--|-----------------------|------------------------|-----------------------|------------------------|-----------------------|
|                        |                            | Bitstream  |                       | Analog 2ch             |                       | PCM                    |                       |
|                        |                            | BITSTREAM/<br>PCM jack   | Analog (L/R)<br>jacks | BITSTREAM/<br>PCM jack | Analog (L/R)<br>jacks | BITSTREAM/<br>PCM jack | Analog (L/R)<br>jacks |
| DVD-<br>video<br>disc* | Dolby Digital              | Bitstream  | 48 kHz/20 bit         | Bitstream              | 48 kHz/20 bit         | 48 kHz/16 bit          | 48 kHz/20 bit         |
|                        | Linear<br>PCM              | 48 kHz/16 bit  | 48 kHz/16 bit         | 48 kHz/16 bit          | 48 kHz/16 bit         | 48 kHz/16 bit          | 48 kHz/16 bit         |
|                        |                            | 48 kHz/20 bit  | 48 kHz/16 bit         | 48 kHz/20 bit          | 48 kHz/20 bit         | 48 kHz/16 bit          | 48 kHz/20 bit         |
|                        |                            | 48 kHz/24 bit  | 48 kHz/16 bit         | 48 kHz/24 bit          | 48 kHz/24 bit         | 48 kHz/16 bit          | 48 kHz/24 bit         |
|                        |                            | 96 kHz/16 bit  | 48 kHz/16 bit         | 48 kHz/16 bit          | —                     | 96 kHz/16 bit          | 48 kHz/16 bit         |
|                        |                            | 96 kHz/20 bit  | 48 kHz/16 bit         | 48 kHz/20 bit          | —                     | 96 kHz/20 bit          | 48 kHz/16 bit         |
|                        | 96 kHz/24 bit              | 48 kHz/16 bit  | 48 kHz/24 bit         | —                      | 96 kHz/24 bit         | 48 kHz/16 bit          |                       |
| DTS                    | Bitstream                  | —  | Bitstream             | —                      | —                     | —                      |                       |
| MPEG2                  | Bitstream                  | 48 kHz/16 bit  | Bitstream             | 48 kHz/16 bit          | 48 kHz/16 bit         | 48 kHz/16 bit          |                       |
| VIDEO CD               | MPEG1                      | 44.1 kHz/16 bit  | 44.1 kHz/16 bit       | 44.1 kHz/16 bit        | 44.1 kHz/16 bit       | 44.1 kHz/16 bit        | 44.1 kHz/16 bit       |
| Audio<br>CD            | Linear PCM 44.1 kHz/16 bit | 44.1 kHz/16 bit  | 44.1 kHz/16 bit       | 44.1 kHz/16 bit        | 44.1 kHz/16 bit       | 44.1 kHz/16 bit        | 44.1 kHz/16 bit       |
|                        | DTS                        | Bitstream  | (Noise)               | Bitstream              | (Noise)               | Bitstream              | (Noise)               |
| DVD-<br>RAM/RW/<br>R   | Dolby Digital              | Bitstream  | 48 kHz/20 bit         | Bitstream              | 48 kHz/20 bit         | 48 kHz/16 bit          | 48 kHz/20 bit         |
|                        | Linear PCM 48 kHz/16 bit   | 48 kHz/16 bit  | 48 kHz/16 bit         | 48 kHz/16 bit          | 48 kHz/16 bit         | 48 kHz/16 bit          | 48 kHz/16 bit         |
| CD-R/RW                | MPEG2                      | Bitstream  | 48 kHz/16 bit         | Bitstream              | 48 kHz/16 bit         | 48 kHz/16 bit          | 48 kHz/16 bit         |
|                        | MP3/WMA                    | 44.1 kHz or 32 kHz or 48 kHz/16 bit                                  |                       |                        |                       |                        |                       |

\* “DVD video disc” above does not include DVD-R/RW discs recorded on this recorder.

- Do not select a connection or setting indicated as “Noise” in the above list.

Manufactured under license from Dolby Laboratories. “Dolby” and the double-D symbol are trademarks of Dolby Laboratories.

# Viewing JPEG files

You can play JPEG files that have been recorded on a CD-R or CD-ROM on the recorder.

## ■ Preparations

- Prepare a compatible disc (▶ page 71) that contains JPEG files you want to view.
- Set "Priority contents" (▶ page 116) to "Photo".
- Make your TV shape conform to the 4:3 picture size. Only 4:3 pictures can be played regardless of the function settings via the on-screen displays of the recorder (▶ page 40, "INSTALLATION GUIDE"). If the TV is adjusted to other sizes, e.g. "WIDE," images will appear to be horizontally expanded. For details, refer to the owner's manual of your TV.

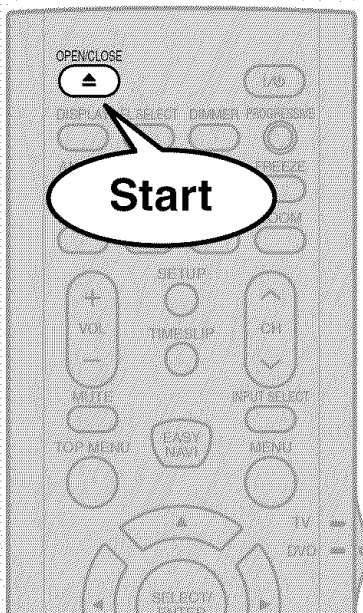

## 1 Load a CD that contains JPEG files.

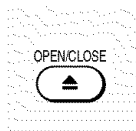

Each photo appears for about 3 seconds (slide show).

If a slide show does not start, press the PLAY button.

Depending on the disc, "CONTENT MENU Picture List" appears. See "On "CONTENT MENU Picture List"" (▶ page 71) to operate.

## Notes

- Some files may not display their own entire images depending on the size.
- Operation to JPEG file will be disabled at about 5 minutes before a programmed recording starts.

## ■ To stop playback (slide show)

Press **STOP**.

If you press PLAY button after pressing STOP button, playback will start from the photo you stopped.

## ■ To pause playback (slide show)

Press **II**.

To resume, press **II** button again or press PLAY button.

## ■ To skip photos

During playback, press **SKIP FWD** or **SKIP REV** button repeatedly.

SKIP FWD : To skip forward.

SKIP REV : To skip backward.

## ■ To rotate a picture

Press **ANGLE** repeatedly.

Each time you press the button, the picture rotates by 90° degree.

## Notes

- The rotated image is displayed after its original posture appears momentarily.

## ■ To magnify a picture

Follow the procedure on ▶ page 66.

## Notes

- The magnified image is displayed after its original posture appears momentarily.
- For small pictures, the reduction level may be limited.

## ■ Viewing a specified photo (single view)

Full screen still view.  
2 ways are available:

### ● On “CONTENT MENU Picture List”

- 1) Press **EASY NAVI**.
- 2) Press **▲ / ▼ / ◀ / ▶** to select “Play Contents”, then press **SELECT/ENTER**.

CONTENT MENU Picture List appears.

Depending on the disc, the recorder creates either temporary folder, “Auto” or “All”.

“Auto”: For CD of which compatibility confirmed by TOSHIBA. Only playable files are listed.

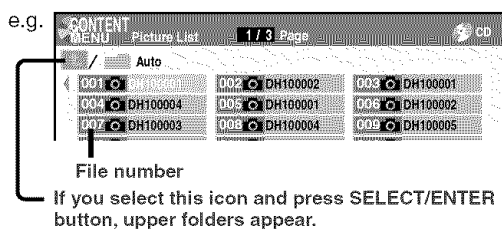

“All”: For CD other than above. All files are listed.

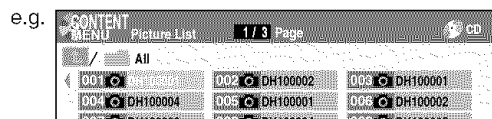

• Some CDs may not comply with the above.

- 3) Press **▲ / ▼ / ◀ / ▶** to select a folder or photo.  
Pressing **FWD** or **REV** button turns the pages.  
If you press **★** button, the list changes to thumbnail view (CONTENT MENU Pictures).

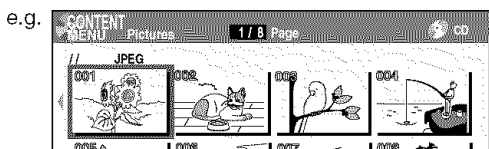

Pressing **ANGLE** button rotates the picture. The rotation of pictures is kept until the CD is ejected.

To return to the previous list, press **★** button again.

- 4) Press **SELECT/ENTER**.

If you select a folder at step 3), repeat steps 3) and 4) until your favorite file appears.

The selected photo appears in full screen.

## Notes

- CONTENT MENU Picture List cannot show all the files in a disc, but only ones regarded as objects of regular play of the disc.
- The larger the file size is, the longer the thumbnail takes time to appear.
- Letters of a file/folder name overflowing the given space are not displayed.

## ● Direct input of a photo number

- 1) During playback or stop, press **SEARCH**.  
An input window appears.

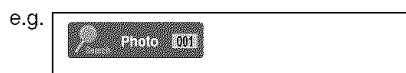

- 2) Input a photo number using the number buttons or **ADJUST**.
- 3) Press **SELECT/ENTER**.  
The selected photo appears in full screen.

## ■ To change the playback order

- 1) During playback (slide show) or stop, press **QUICK MENU**.
- 2) Press **▲ / ▼** to select an item, then press **SELECT/ENTER**.

To shift the cursor, press **▲ / ▼** buttons.

- Reverse** : To reverse the order.
- Repeat** : To repeat the current folder.

- 3) Press **SELECT/ENTER**.  
Playback in the selected mode starts.

## JPEG files compatibility

Discs whose compatibility with this recorder has been confirmed by TOSHIBA are as follows.

CANON QuickCD  
FUJICOLOR CD  
Kodak Picture CD  
NORITSU QSS CD

JPEG disc compatibility with this recorder is limited as follows:

- Playable discs:
  - CD-ROM, CD-R
  - CD-RW is not recommendable.
- CD physical format:
  - Mode 1, Mode 2 XA Form 1
- File system:
  - ISO9660 Level 1, 2 or Joliet
- File name:
  - A file name should be in alphabet and numerals only, and must incorporate “JPG” extension.
  - e.g. “\*\*\*\*\*.JPG”
- Total number of folders:
  - Less than 256
- Total number of files:
  - Less than 1000

Some files may not display their own entire image depending on the size.

Some discs may not permit this operation. Especially, the following conditions of included files will increase the disc's disability.

1. Pixels over 5000 x 5000 in height and/or width
2. File format except Exif

# Playing MP3/WMA files

You can play MP3/WMA files that have been recorded on a CD-R or CD-ROM on this recorder.

## ■ Preparations

- Make sure that a disc you want to play is compatible with this recorder. See ➡ page 73.
- Set "Priority contents" (➡ page 116) to "Audio".

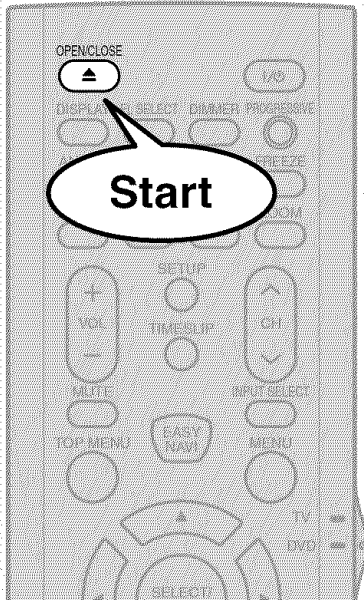

## 1 Load a CD that contains MP3/WMA files.

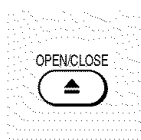

Playback starts from the first track of a current folder.

## Notes

- WMA tracks copy-protected cannot be played.
- The DIGITAL AUDIO OUT BITSTREAM/PCM jack outputs MP3/WMA sounds in the linear PCM format regardless of the current "Audio out select" (➡ page 114) selection.
- You cannot change the playback speed of MP3/WMA playback.

## ■ To stop playback

Press **STOP**.

If you press **PLAY** button after pressing **STOP** button, playback will start from the beginning of the track.

## ■ To pause playback

Press **||**.

To resume, press **||** button again or press **PLAY** button.

## ■ To skip tracks

During playback, press **SKIP FWD** or **SKIP REV** repeatedly.

**SKIP FWD** : To skip forward.

**SKIP REV** : To skip backward.

## ■ Selecting a track in the disc

2 ways are available:

## On "CONTENT MENU Audio List"

- 1) Press **EASY NAVI**.
- 2) Press **▲/▼/◀/▶** to select "Play Contents", then press **SELECT/ENTER**.

CONTENT MENU Audio List appears.

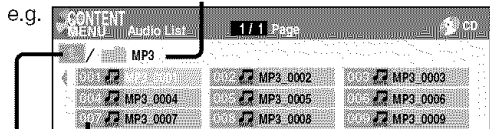

File number

If you select this icon and press **SELECT/ENTER** button, upper folders appear.

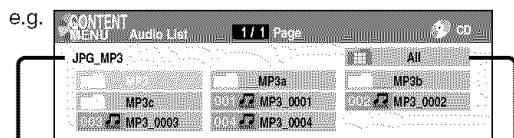

Disc name

The recorder creates temporary folder "All", which contains all playable files.



- 3) Press ▲ / ▼ / ◀ / ▶ to select a track or folder.  
Pressing FWD or REV button turns the pages.
- 4) Press SELECT/ENTER.  
If you select a folder at step 3), repeat steps 3) and 4) until your favorite file appears.

**Notes**

- CONTENT MENU Auto List cannot show all the tracks in a disc, but only ones regarded as objects of proper play of the disc.
- Letters of a file/folder name overflowing the given space are not displayed.

**Direct input of a track number**

- 1) During playback or stop, press SEARCH.  
An input window appears.



- 2) Input a track number using the number buttons or ADJUST button.
- 3) Press SELECT/ENTER.

**■ To change the playback order**

- 1) During playback or stop, press QUICK MENU.
- 2) Press ▲ / ▼ to select "Special playback mode", then press SELECT/ENTER.

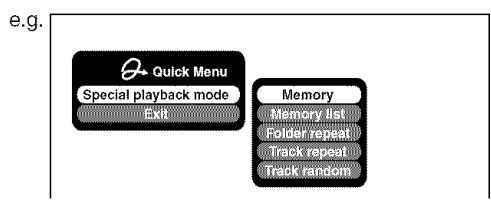

- 3) Press ▲ / ▼ to select an item, then press SELECT/ENTER.

**Memory list** : To play favorite tracks only in a favorite order.

Input a track number by using the number buttons or ADJUST button.

To shift the cursor, press ▲ / ▼ buttons.

**Folder repeat** : To repeat the current folder.

**Track repeat** : To repeat the current file.

**Track random** : To play files in the current folder in a random order.

**Note**

- To cancel these modes, stop the playback or select the cancel command from Quick Menu.

**Playable files**

MP3/WMA disc compatibility with this recorder is limited as follows:

- Playable discs:
  - CD-ROM, CD-R
  - CD-RW is not recommendable.
- Sampling Frequency / Bitrate:
  - WMA: 32 kHz / 48 Mbps (CBR), VBR  
44.1 kHz / 48-192 Mbps (CBR), VBR  
48 kHz / 128-192 Mbps (CBR), VBR
  - MP3: 8 kHz, 11.025 kHz, 12kHz, 16 kHz,  
22.05 kHz, 24 kHz / 8-160 kbps (CBR), VBR  
32 kHz, 44.1 kHz, 48 kHz / 32-320 kbps (CBR), VBR
- CD physical format:
  - Mode 1, Mode 2 XA Form 1
- File system:
  - ISO9660 Level 1, 2 or Joliet
- File name:
  - A file name should be in alphabet and numerals only, and must incorporate "MP3" or "WMA" extension.  
e.g. "\*\*\*\*\*.MP3", "\*\*\*\*\*.WMA"
- Total number of folders:
  - Less than 256
- Total number of files:
  - Less than 1000
- WMA codec version:
  - V7, V8, V9

\* This recorder supports ID3v2 (ID3 Tag Version 2) of MP3, to display text data such as names of title and artist. Some characters may be displayed properly.

This recorder requires discs/recordings to meet certain technical standards in order to achieve optimal playback quality. Pre-recorded DVDs are automatically set to these standards. There are many different types of recordable disc formats (including CD-R containing MP3/WMA files). Because this area of technology is still evolving, Toshiba cannot guarantee that all recordable discs will produce optimal playback quality. The technical criteria set forth in this owner's manual are meant only as a guide.

Please be advised that you must obtain permission from the applicable copyright owners to download copyrighted content, including music files, in any format, including the MP3 and WMA formats, prior to the downloading thereof. Toshiba has no right to grant and does not grant permission to download any copyrighted content.

Microsoft, Windows Media, and the Windows Logo are trademarks or registered trademarks of Microsoft Corporation in both the United States and other countries.

# Pausing a TV broadcast (Freeze function)

While watching a TV broadcast through this recorder, you can pause it. However, even if an image is still on the screen, the picture is running on the broadcast and you can still hear the sound on-going.

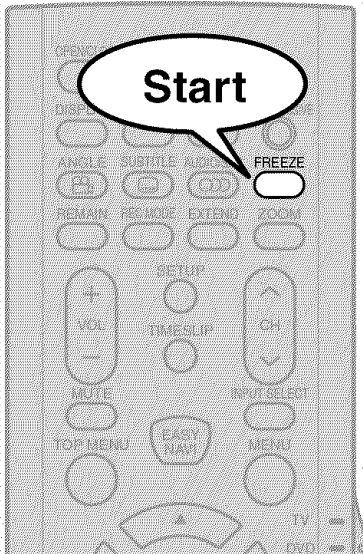

## 1 While watching a TV broadcast through this recorder, press FREEZE.



The TV broadcast pauses just as a still picture.

e.g.

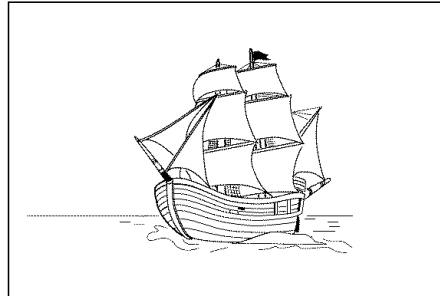

- When "Screen protector" is set to "On", the freeze function will be cancelled about 15 minutes later.

### ■ To cancel the freeze function

Press FREEZE.

- The picture being broadcast displays on the screen.

# Checking the current status and settings

You can confirm operational status and setting details.

## Operational status and setting details

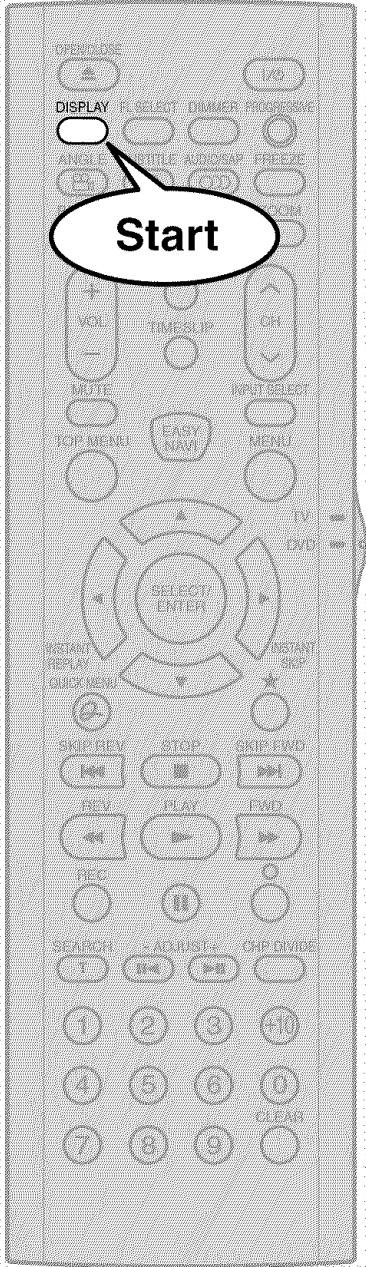

### 1 Press DISPLAY.

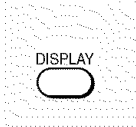

The following on-screen display appears. (The actual display varies depending on the disc.)

e.g. while playing a DVD-RAM disc

Elapsed time of a title/

Elapsed time of a chapter Mode indicator

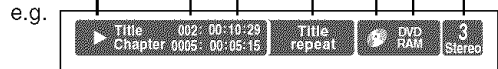
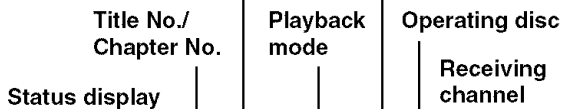

### 2 Press DISPLAY again.

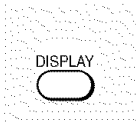

An expanded display appears. (Actual display varies depending on the disc.)

e.g.

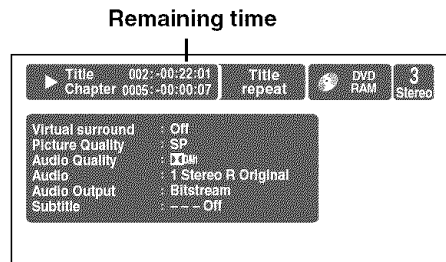

### 3 Press DISPLAY again to turn the display off.

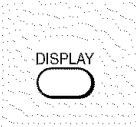

## Using the time bar

The time bar shows the current progress in playback or recording.

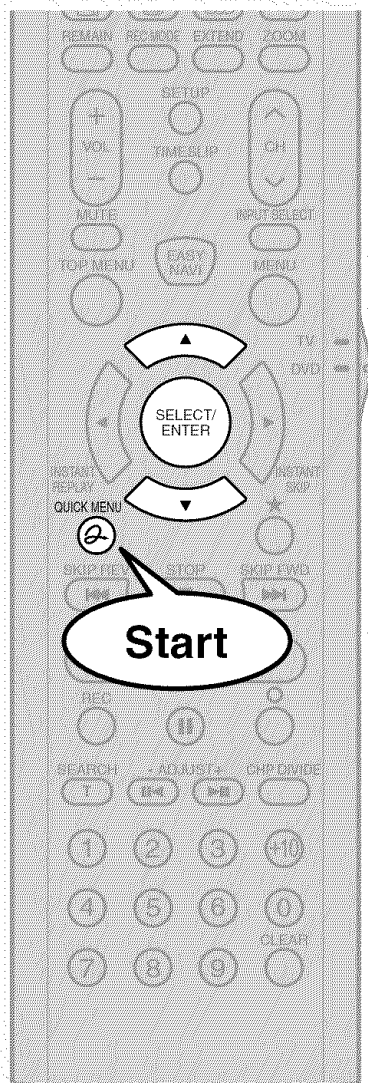

**1** During playback or recording, press **QUICK MENU**.



**2** Press **▲ / ▼** to select “Time bar”, then press **SELECT/ENTER**.

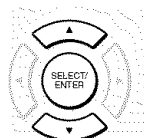

The time bar appears. (The actual display varies depending on the disc.)

e.g. Playback

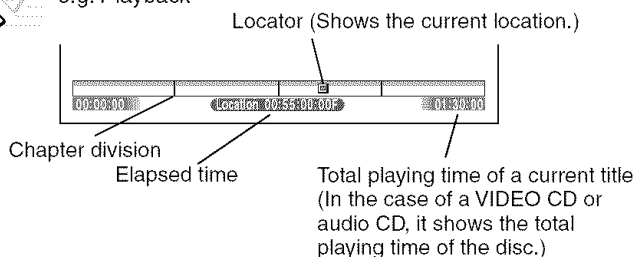

e.g. Recording

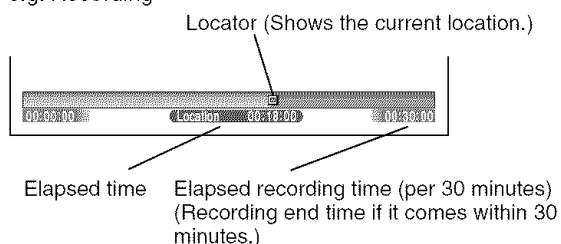

**Note**

- Time display is an approximation.

■ **Changing the location of the time bar**  
While the time bar is displayed, press **▲ / ▼**.  
The time bar shifts up and down.

■ **Turning off the time bar**  
Repeat steps 1 and 2.

# Functions in Quick Menu

Besides these examples, various other ones are introduced on respective pages for your convenience. See  page 24 on how to operate Quick Menu.

## ■ To play repeatedly (Repeat playback)

DVD-RAM DVD-RW DVD-R DVD-VIDEO VCD CD

You can repeat a desired section.

- 1) During playback, press **QUICK MENU**.
- 2) Press **▲ / ▼** to select “Special playback mode”, then press **SELECT/ENTER**.

### Special playback mode

The sub menu appears. Select the next item by pressing **▲ / ▼** buttons and **SELECT/ENTER** button.

#### A-B repeat

You can designate a portion in a title or track to repeat continuously.

If you select “A-B repeat” and press **SELECT/ENTER** button, the following display appears. Perform steps 1 and 2 below.

e.g.



To cancel the procedure, press **O** button.

- 1) Press **SELECT/ENTER** at the beginning of the segment (point A) you want to repeat. The location of point A is memorized. The display changes to “Set B”.
- 2) Press **SELECT/ENTER** at the end of the segment (point B). The location of point B is memorized, and repeat playback begins between point A and B.

#### Title repeat

To repeat the same title.

#### Chapter repeat

To repeat the same chapter.

#### Track repeat

VCD CD

To repeat the same track.

#### Disc repeat

DVD-RW DVD-R

To repeat the entire disc.

#### Cancel repeat

(in Repeat playback mode)  
To resume normal playback.  
Playback of a DVD-RAM disc stops.

#### Notes

- Some discs may not permit repeat operation.
- You cannot use the repeat playback function in conjunction with the random playback function.
- If you press **STOP** button during repeat playback, this operation is canceled.
- While you are performing repeat playback on a DVD-RAM disc, other operations ( pages 59 to 61) except pause play are not available.

## ■ To play in random order (Random play)

DVD-RW DVD-R DVD-VIDEO VCD CD

You can play sections in random order.

- 1) During playback or stop, press **QUICK MENU**.
- 2) Press **▲ / ▼** to select “Special playback mode”, then press **SELECT/ENTER**.

### Special playback mode

The sub menu appears. Select the next item by pressing **▲ / ▼** buttons and **SELECT/ENTER** button.

#### Title random

Plays all titles in a loaded disc in random order. Each title is played beginning from chapter 1.

#### Chapter random

Plays all chapters in a current title in random order.

#### Track random

Plays all tracks on a loaded disc in random order.

Functions in Quick Menu (Continued)

**Cancel random**: (in Random play mode)

Resumes normal playback.

**Notes**

- Some discs may not permit random playback operation.
- You cannot use the random playback function in conjunction with the memory playback function.
- You cannot use the random playback function in conjunction with the repeat playback function.
- Pressing STOP button during operation cancels random playback.

■ **To play in favorite order (Memory playback)**

DVD-RW | DVD-R | DVD-VIDEO | VCD | CD

You can select 30 titles, chapters, or tracks and play them in favorite order.

(To play contents in a DVD-RAM disc in favorite order, make a playlist. For details, see "Editing" on page 81.)

- 1) During playback or stop, press QUICK MENU.
- 2) Press ▲ / ▼ to select "Special playback mode", then press SELECT/ENTER.

**Special playback mode**

The sub menu appears. Select the next item by pressing ▲ / ▼ buttons and SELECT/ENTER button.

**Memory list**

If you select this and press SELECT/ENTER button, the following display appears. Perform the steps below.

e.g.

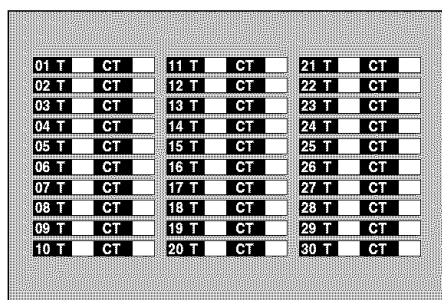

- 1) Input numbers of a titles, chapters, or tracks by using the number buttons, in favorite order. Input each 3-digit number. Input each 1- or 2-digit number, first input 0. (e.g. "0", "0", "3".) To cancel the numbers, press CLEAR button. To input a chapter number, press ◀ / ▶ buttons to shift the cursor.

- 2) Press ▲ / ▼ to select the next box, then perform step 1).

To select another chapter in the same title, you do not need to select the title number.

Repeat these steps if necessary.

You can program up to 30 selections into memory.

- 3) Press SELECT/ENTER.

Memory playback starts.

**Memory**: (in normal playback mode)

To display an entry box for one program selection.

**Memory release**: (in memory playback mode)

To resume normal playback.

**Memory repeat**: (in memory playback mode)

To repeat a current memory playback.

**Notes**

- Some discs may not permit memory playback operation.
- Inputting numbers of titles, chapters or tracks that a disc does not contain will result in error.
- You cannot program/change selections during memory playback. To change selections, cancel memory playback by pressing STOP button.
- When you turn off the power, the selected memory is erased.
- You can exit the memory playback display by pressing O button.

**■ To display the current bit rate**

DVD-RAM DVD-RW DVD-R DVD-VIDEO

- 1) During playback, press QUICK MENU.
- 2) Press ▲ / ▼ to select “Bit rate”, then press SELECT/ENTER.

A horizontal menu bar with a textured background and rounded ends. The text "Bit rate" is centered in the bar.**Note**

- To turn off the bit rate display, select this item again.

**■ To check information on a title**

DVD-RAM DVD-RW DVD-R

- 1) During playback, press QUICK MENU.
- 2) Press ▲ / ▼ to select “Title information”, then press SELECT/ENTER.

A horizontal menu bar with a textured background and rounded ends. The text "Title information" is centered in the bar.**■ To exit the Quick Menu**

DVD-RAM DVD-RW DVD-R DVD-VIDEO VCD CD

Press QUICK MENU again.

or

Press ▲ / ▼ to select “Exit”, then press SELECT/ENTER.

A horizontal menu bar with a textured background and rounded ends. The text "Exit" is centered in the bar.





# Editing

You can create your own movie from your assembled scenes.

- **Before editing**
- **Creating chapters**
- **Playlist editing**
- **Creating thumbnails**
- **High speed dubbing**
- **Deleting selected Items**
- **DVD-Video finalizing process**

# Before editing

## Process of editing

You can edit recorded contents and create your own library.

### ● Basic editing procedure

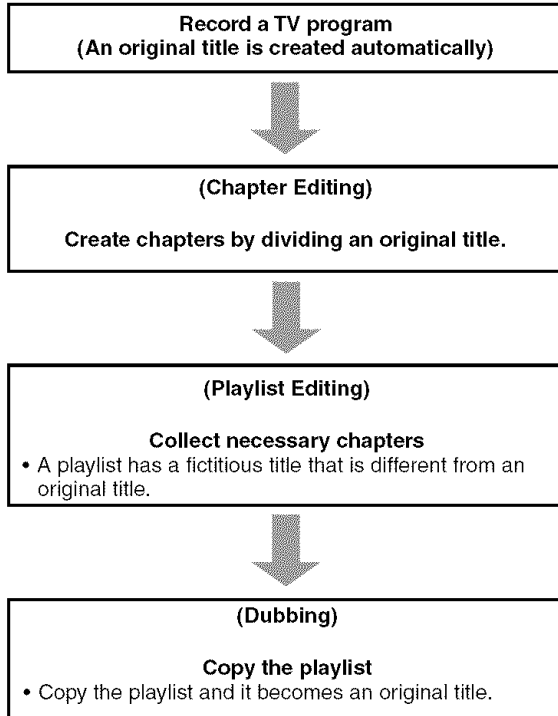

# Outline of basic editing

## ● Recording a TV program

Record a TV program and it becomes an original title.

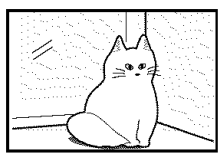

e.g.  
Title: The world of cats and dogs.

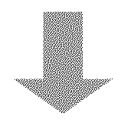

## ● Playlist editing

Collect your favorite chapters to make them as one title. (Playlist)  
If an original title is deleted, a playlist will be also deleted because playlists are fictitious titles.

e.g. Making a playlist by collecting scenes of cats from title 1 "The world of cats and dogs".

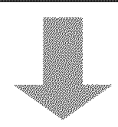
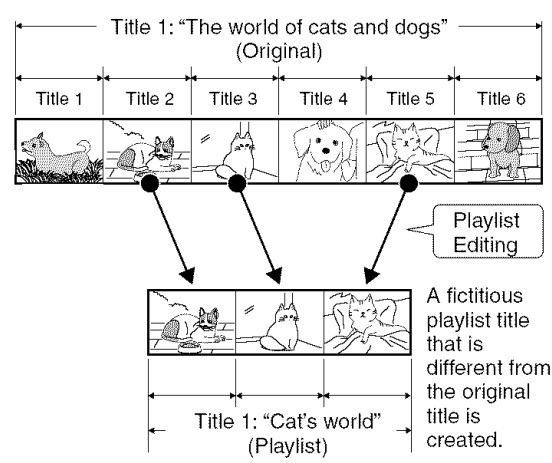

## ● Chapter editing

Divide the original title into chapters.

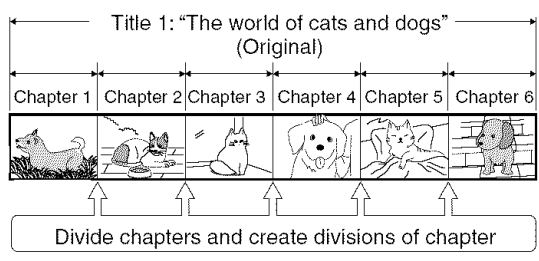

- You can play desired scenes from the top by "Chapter Divide".
- Divide chapters to edit a playlist.

## ● Dubbing

Copy the playlist and it becomes an original title.  
Once the dubbing is complete, you can delete unnecessary chapters to regain space for another recording.

Using these editing functions to modify copyrighted content for any purpose other than your private viewing may be prohibited under the Copyright Laws of the United States and other countries, and may subject you to civil and criminal liability.

# Creating chapters

**1 title is created by recording at a time, which includes 1 chapter. By dividing it into several chapters, it will be easier to access a desired scene, and your editing or playback will be much easier.**

To create chapters in a title, insert a chapter mark. Playback the content, locate a point where you want to divide, then press **CHP DIVIDE** button.

The point divides the chapter (into two). You can create multiple chapters by repeating the above operation.

## Notes

- Chapters cannot be created in the following modes:  
Dubbing / Fast-reverse, Fast-forward / Slow-motion
- You cannot divide a title of a DVD-R/RW disc into chapters. It is possible to create chapters in a DVD-R/RW disc by selecting an option that inserts chapter marks automatically during recording at regular intervals. (▶ page 118)

**If you want to modify the chapter division, or want to place a chapter mark more precisely monitoring the frame counter, follow the procedures below.**

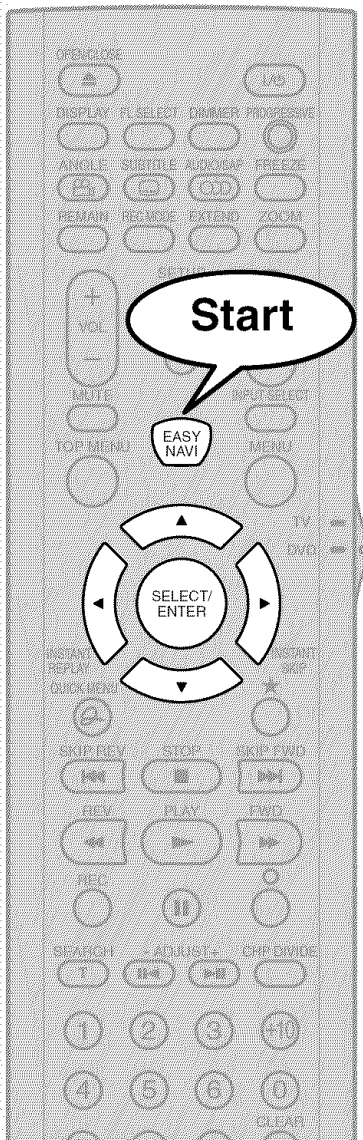

## 1 Press EASY NAVI.



EASY NAVI Main Menu appears.

## 2 Press ▲ / ▼ / ◀ / ▶ to select “Play Contents”, then press SELECT/ENTER.

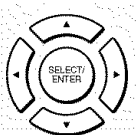

CONTENT MENU Title List appears.

## 3 Press ▲ / ▼ / ◀ / ▶ to select a title.

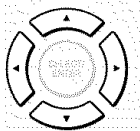

- To go to the next or previous page, press REV or FWD button.
- To select a chapter, first highlight the title that contains the chapter you want, then press ★ button. The display changes to CONTENT MENU Chapter List. To go back to the title display, press ★ button again.

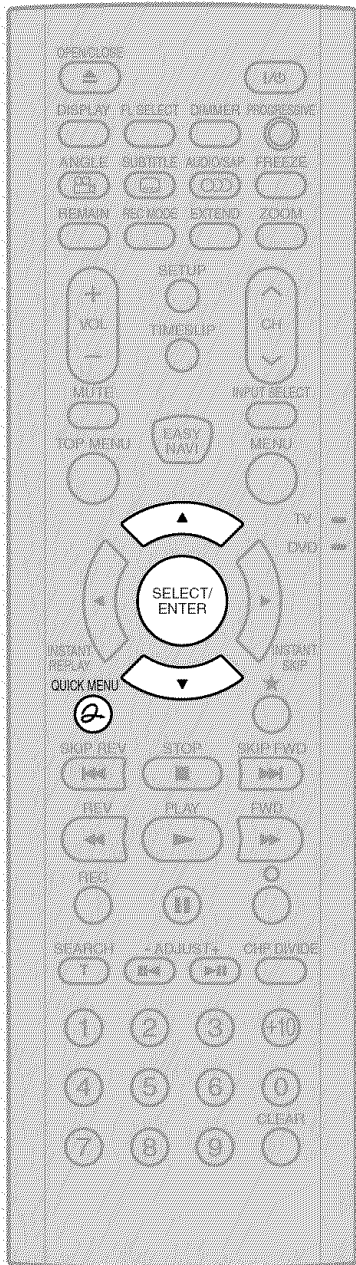

## 4 Press QUICK MENU.

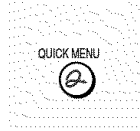

Quick Menu appears.

e.g.

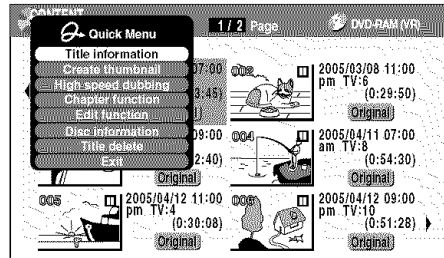

## 5 Press ▲ / ▼ to select “Chapter function”, then press SELECT/ENTER.

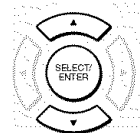

The submenu appears.

e.g.

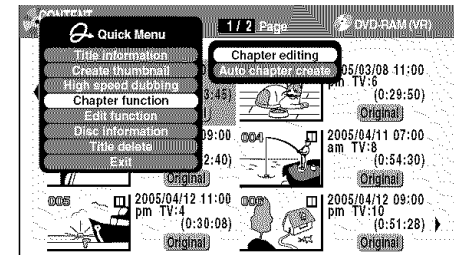

## 6 Press ▲ / ▼ to select “Chapter editing”, then press SELECT/ENTER.

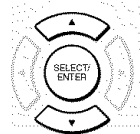

EDIT MENU Chapter Editing appears.

e.g.

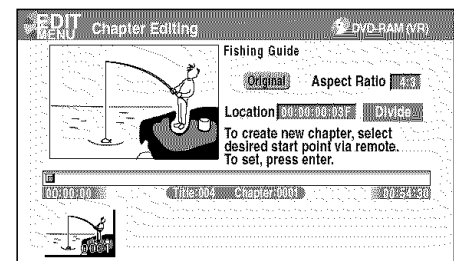

(Continued)

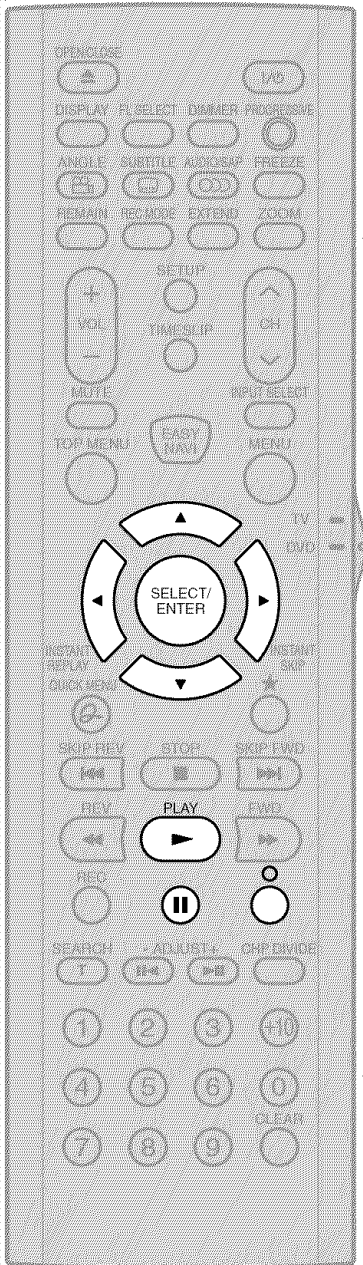

## 7 Press PLAY to start playback.

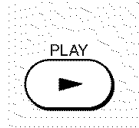

Locate a scene where you want to insert a chapter mark.

You can use the following buttons.  
FWD, REV, SKIP FWD, SKIP REV, **II**, ADJUST, etc.

The locator shows the current position on the time bar.  
And the live video plays in the upper left.

- To access other chapters:  
Press **▲** / **▼** buttons to move to the thumbnail display, then press **◀** / **▶** buttons to select a desired thumbnail. To go to the next page, press FWD button.
- You can confirm the first and last scenes of a chapter. Select a thumbnail and press SELECT/ENTER button. 3 seconds of the first and last scenes are played.

## 8 At a point where you want to make a chapter division, press **II**.



The picture pauses.

e.g.

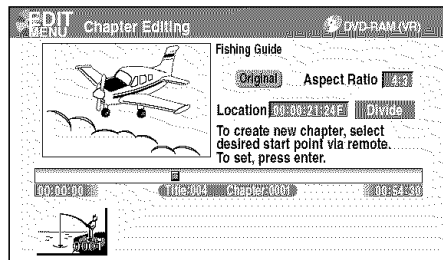

## 9 Press **▲** / **▼** / **◀** / **▶** to select "Divide," then press SELECT/ENTER.

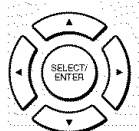

A chapter division is created at the selected location, and the first scene of the new chapter is registered as a chapter thumbnail.

e.g.

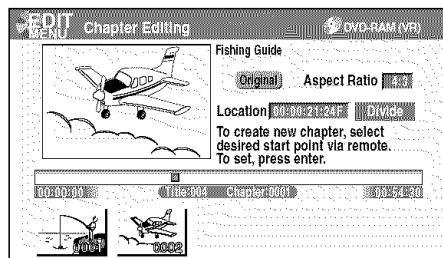

## 10 Repeat steps 7 to 9.

Locations of chapter division are indicated by the markers on the time bar.

To erase a chapter division, see “Merging chapters” (➡ page 88).

## 11 When all chapter divisions have been made, press **O**.

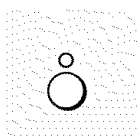

The recorder displays a message, and starts saving the chapter divisions on the time bar.

When complete, CONTENT MENU returns.

### Notes

- This recorder supports a limited number of chapters on a disc. If exceeded, a message appears. In this event, reduce the number of chapters by merging chapters. (➡ page 88)
- EDIT MENU Chapter Editing can also be viewed by selecting “Edit Menu” from EASY NAVI Main Menu, then “Chapter Editing”.

e.g.

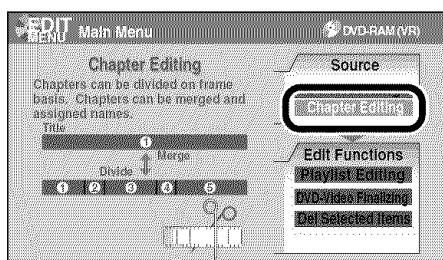

- To exit the EDIT MENU Main Menu, press EASY NAVI button.
- Making chapters in a title (Original) does not affect the related titles (Playlist).
- There may be a small difference between a location you marked and a chapter division actually played.
- Pausing a recording automatically creates a chapter division.

### ■ Creating chapters automatically when recording

You can create chapter marks from the beginning of a title at regular intervals automatically. (Chapter marks are added to those already existing.)

This is convenient for long programs, such as live sports games.

- 1) Perform steps 1 to 5 on ➡ pages 84 to 85.
- 2) Press ▲ / ▼ to select “Auto chapter create”, then press SELECT/ENTER.
- 3) Press ▲ / ▼ to select a chapter division interval, then press SELECT/ENTER.

Chapter divisions are automatically marked at the selected intervals.

■ Merging chapters

- 1) Perform steps 1 to 6 on pages 84 to 85, to view EDIT MENU Chapter Editing.
- 2) Press ▲ / ▼ / ◀ / ▶ to highlight a chapter.  
Pressing REV or FWD button can access preceding or following pages.
- 3) Press QUICK MENU.

e.g.

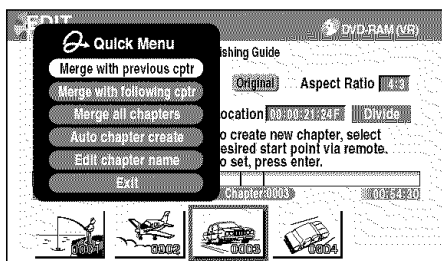

- 4) Press ▲ / ▼ to select an item.

**Merge with previous cptr:**

To delete the chapter division between the selected chapter and the previous one.

**Merge with following cptr:**

To delete the chapter division between the selected chapter and the succeeding one.

**Merge all chapters:**

To merge all chapters in the title.

- 5) Press SELECT/ENTER.

e.g. When “Merge with previous cptr” is selected:  
The selected chapter is merged into the previous chapter and its thumbnail is erased.

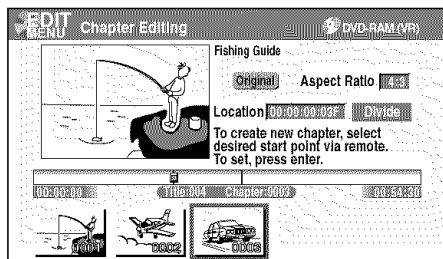

Notes

- To turn off EDIT MENU Main Menu, press EASY NAVI button.
- When chapters are merged, the numerical value of following chapters will decrease correspondingly.
- Merging chapters does not affect the related titles (Playlist). You can also merge chapters in the title (Playlist). In this case, the title (Original) is not affected.
- You can access the feature of merging chapters also from the Quick Menu on CONTENT MENU Chapter List.

■ Naming a chapter

- 1) From EDIT MENU Chapter Editing, select a chapter which you want to name.
- 2) Press QUICK MENU.
- 3) Press ▲ / ▼ / ◀ / ▶ to select “Edit chapter name”, then press SELECT/ENTER.  
A keyboard appears.  
Enter a name following the on-screen icon guides.

Notes

- There is a limit to the number of chapters which can be named. If exceeded, a message appears.
- You can also access the keyboard to enter a chapter name by selecting a chapter with REV or FWD button on CONTENT MENU Title Information, and by selecting “Edit chapter name” from Quick Menu on CONTENT MENU Chapter List.
- You can change chapter names also on a DVD-R/RW disc, if the disc is not finalized yet.



# Playlist editing (Collecting desired scenes)

Create a "Playlist" to omit unnecessary scenes for dubbing, or compile desired scenes.

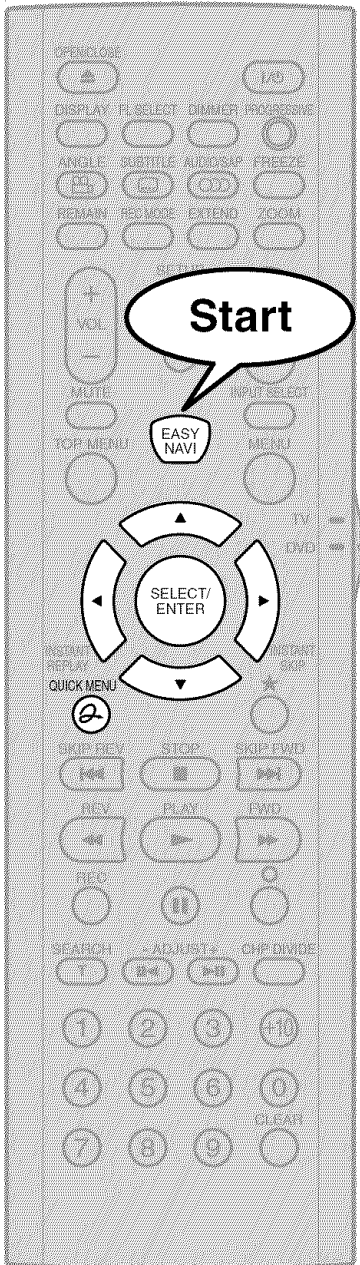

## 1 Press EASY NAVI.



EASY NAVI Main Menu appears.

## 2 Press ▲/▼/◀/▶ to select "Play Contents", then press SELECT/ENTER.

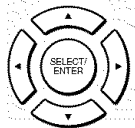

CONTENT MENU Main Menu appears.

## 3 Press QUICK MENU.



Quick Menu appears.

e.g.

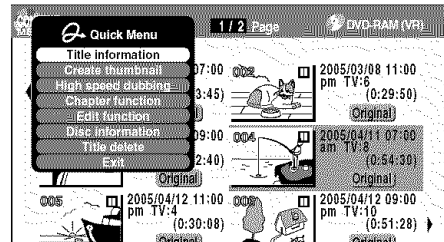

## 4 Press ▲/▼ to select "Edit function", then press SELECT/ENTER.

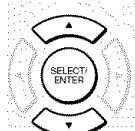

Submenu appears.

e.g.

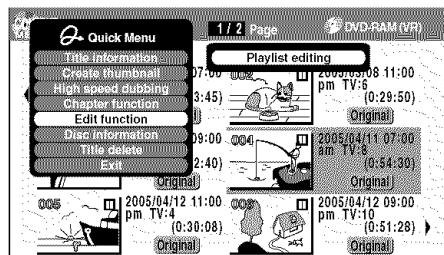

(Continued)

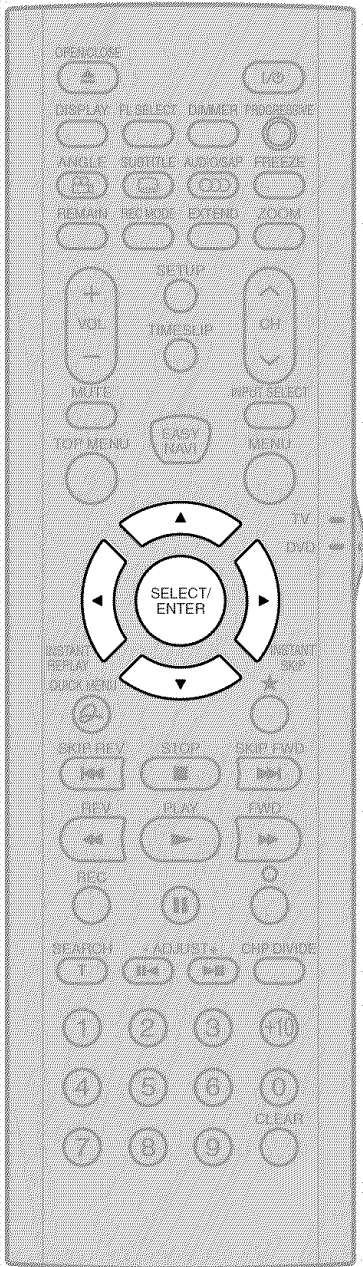

## 5 Press ▲ / ▼ to select “Playlist editing”, then press SELECT/ENTER.

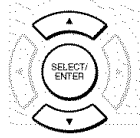

EDIT MENU Playlist editing appears.

e.g.

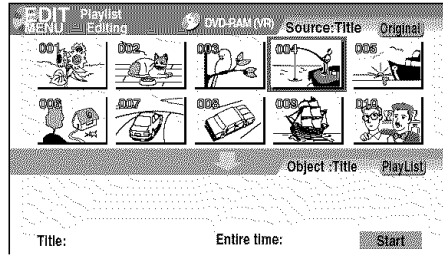

## 6 Press ▲ / ▼ / ◀ / ▶ to select a title or chapter.

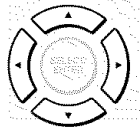

To select between titles and chapters, press ★ button.

e.g.

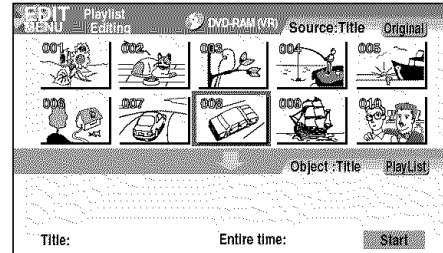

## 7 Press SELECT/ENTER.

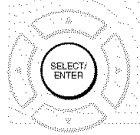

A cursor appears, indicating the point where the selected item will be inserted.

e.g.

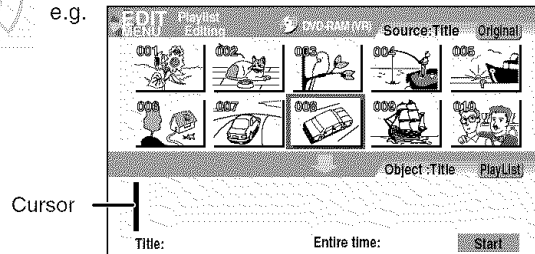

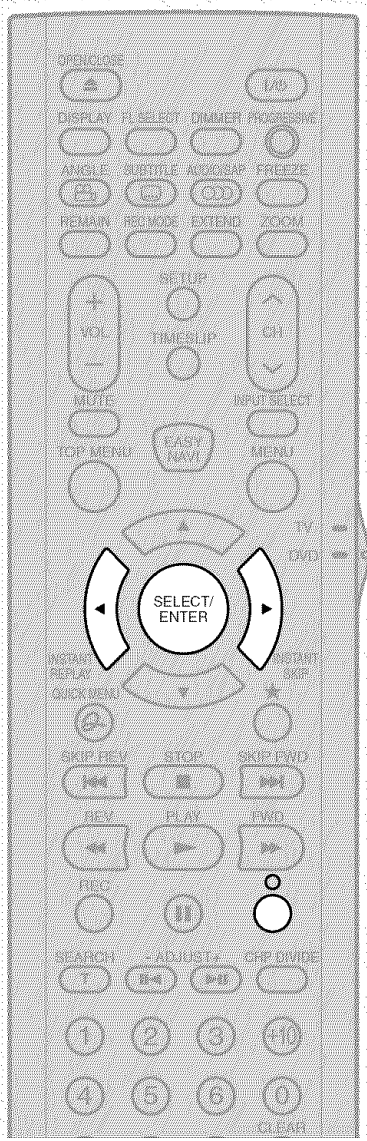

## 8 Press ◀/▶ to select a point where you want to insert the item, then press SELECT/ENTER.

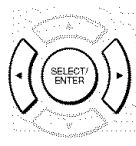

If there are no parts in the lower area, leave the cursor to the left and press SELECT/ENTER.

The selected part is inserted at the location of the cursor.

e.g.

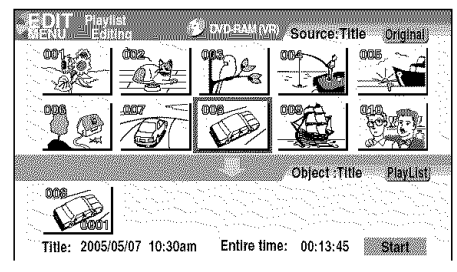

## 9 Repeat steps 6 to 8 to insert items.

To cancel the selection, see “Canceling selection of a part” (▶ page 92).

## 10 When all items have been inserted, press ○.

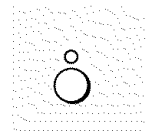

The recorder displays a message, and starts saving the Playlist.

When complete, CONTENT MENU is displayed.

### Notes

- You can access EDIT MENU Playlist editing also by selecting “Edit Menu” on EASY NAVI Main Menu, then “Playlist editing”.
- If you delete titles and chapters (Original), the corresponding titles and chapters (Playlist) are also deleted. Contrarily, if you delete titles and chapters (Playlist), the corresponding titles and chapters (Original) are not deleted.
- Playback may pause if a gap between the content is played.
- There may be a small difference between the chapter boundary and the actual playback picture.
- A title or chapter which is being edited cannot be selected as an item.
- You cannot add a title of still pictures, or a title or a chapter which contains both still and moving pictures, to a playlist.
- By copying (dubbing) a Playlist, a title (Original) of the same contents is created.
- You cannot program a Playlist of contents recorded on a DVD-R/RW disc.
- Down arrow on the thumbnails means: Orange: This title already selected. Green trimmed: Some chapters in this title already selected. Green: This chapter already selected.
- A black thumbnail with “Recording” means that the title is being recorded or its recording will start within 15 seconds. This thumbnail cannot start playback.

### ■ Canceling selection of a part

- 1) From EDIT MENU Playlist editing, press ▲ / ▼ / ◀ / ▶ to select a part to cancel.
- 2) Press QUICK MENU.  
Quick Menu appears.
- 3) Press ▲ / ▼ to select “Cancel selected title”, then press SELECT/ENTER.  
The part you have selected is canceled.

### ■ Confirming the first and last scenes of a part or a Playlist

You can play the first and last 3 seconds of a scene (Preview). (If a title contains several chapters, the first and last scenes of the chapters are also played.)

Preview of a part:

- 1) At step 6 on  page 90, select a title or a chapter, then press QUICK MENU.
- 2) Press ▲ / ▼ to select “Preview”, then press SELECT/ENTER.

Preview of all parts:

- 1) Move the cursor to an any part (in the lower area), then press QUICK MENU.
- 2) Press ▲ / ▼ to select “Preview all playlists”, then press SELECT/ENTER.

### ■ Confirming the title information

- 1) At step 6 on  page 90, select a title or a chapter, then press QUICK MENU.
- 2) Press ▲ / ▼ to select “Title information” then press SELECT/ENTER.

### ■ Correcting a Playlist

You can add or delete parts to correct a Playlist.

- 1) From CONTENT MENU, select a Playlist to correct.
- 2) Press QUICK MENU.
- 3) Press ▲ / ▼ to select “Playlist re-editing” and then press SELECT/ENTER.  
EDIT MENU Playlist editing appears.  
Follow the procedure from steps 6 on  page 90, add or delete parts as necessary.

#### Note

- You cannot edit a title (Playlist) of still pictures, or a title (Playlist) which contains both still and moving pictures.

### ■ Using a part in a Playlist also in another Playlist

- 1) In play or stop mode of a Playlist title, press EASY NAVI.  
EDIT MENU Main Menu appears.
- 2) Press ▲ / ▼ / ◀ / ▶ to select “Edit Menu”, then press SELECT/ENTER.
- 3) Press ▲ / ▼ to select “Playlist editing,” then press SELECT/ENTER.  
EDIT MENU Playlist editing appears.
- 4) Press ▲ / ▼ / ◀ / ▶ to select “Start” then press SELECT/ENTER.  
The areas of title name and part selection become blank.
- 5) Following the procedures outlined on  page 90, make a Playlist.

### ■ Naming a title (Playlist)

- 1) From EDIT MENU Playlist editing, move a cursor to the lower side (selected parts) then press QUICK MENU.
- 2) Press ▲ / ▼ to select “Edit title name,” then press SELECT/ENTER.  
A keyboard appears.
- 3) Following the procedures outlined on  page 30, enter a title name.

#### Note

- You can name a title also while viewing its information. From CONTENT MENU Title List, select a title and press QUICK MENU button then select “Title information” by ▲ / ▼ buttons and SELECT/ENTER button. Further press QUICK MENU button, and select “Edit title name” by ▲ / ▼ buttons and SELECT/ENTER button.

# Creating thumbnails (Changing the picture on CONTENT MENU)

You can register your favorite scene as a thumbnail displayed on CONTENT MENU. On a finalized DVD-R/RW disc, this feature is not available.

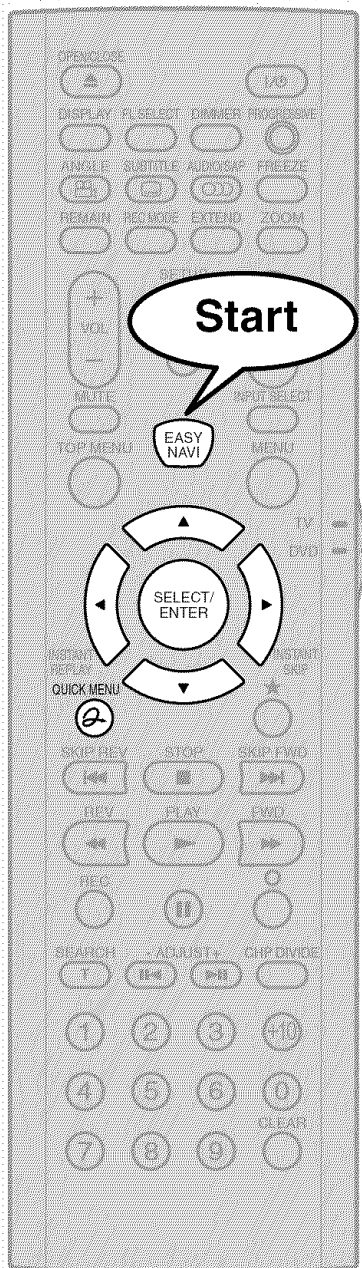

## 1 Press EASY NAVI.



EASY NAVI Main Menu appears.

## 2 Press ▲/▼/◀/▶ to select "Play Contents", then press SELECT/ENTER.

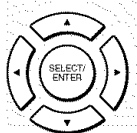

CONTENT MENU Title List appears.

e.g.

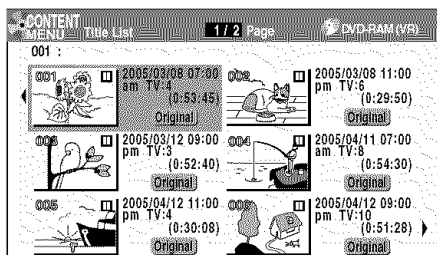

## 3 Press ▲/▼/◀/▶ to select a title whose thumbnail you want to change.

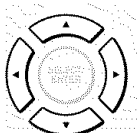

- To go to the next or previous page, press FWD or REV button.
- To select a chapter, select a title and press ★ button. Chapter List appears. By pressing ★ button again, you can return to Title List.

## 4 Press QUICK MENU.



Quick Menu appears.

e.g.

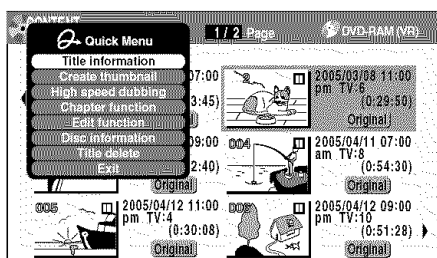

(Continued)

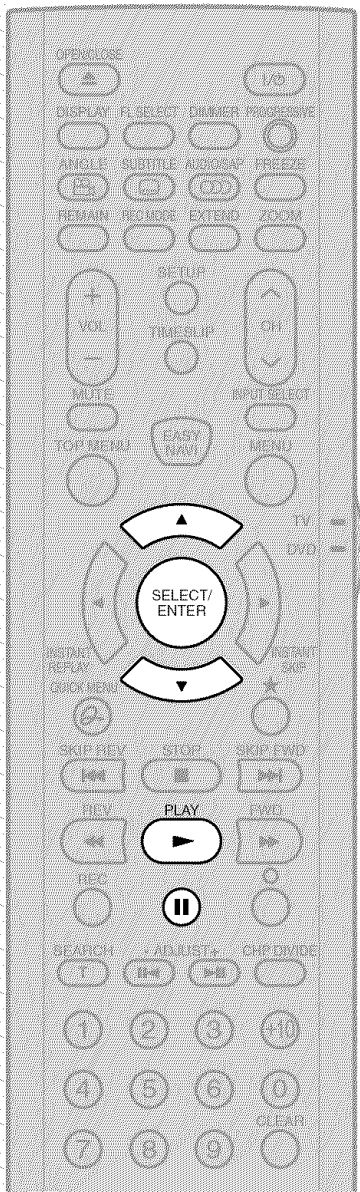

**Note**

- There may be a small difference between a thumbnail made on Create Thumbnail and that displayed in CONTENT MENU. Operation with FWD or REV button may extend the difference.

# 5

Press **▲ / ▼** to select “Create thumbnail” (or “Create CHP thumbnail” if selected a chapter at step 2), then press **SELECT/ENTER**.

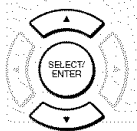

CONTENT MENU Create Thumbnail appears.

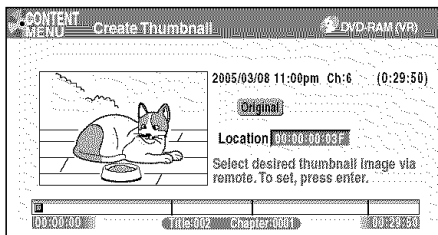

# 6

Press **PLAY** to start playback.



Locate a scene you want to capture as a thumbnail. You can use the following buttons. FWD, REV, **II**, SKIP FWD, SKIP REV, ADJUST, etc.

# 7

At the point where you want to capture a thumbnail image, press **II**.

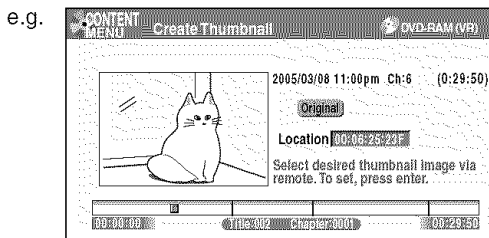
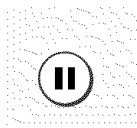

# 8

Press **SELECT/ENTER**.

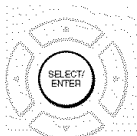

CONTENT MENU returns. The selected scene is displayed as a thumbnail.

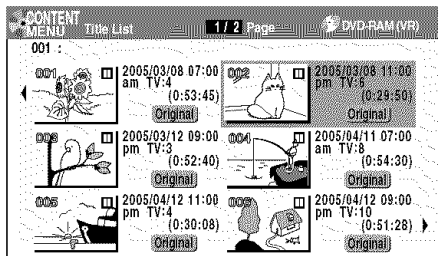

---

### Notes

- You cannot create thumbnails of chapters in a title that contains a still picture.
- If you create a chapter thumbnail, and then record or edit the disc on other devices, the chapter thumbnail may return to the top of the chapter.

# High speed dubbing (Dubbing only a specified part)

This section explains how to copy a title or chapter recorded on a DVD-RAM disc within the same disc at high speed (high speed: in a shorter time than actual playing time of the title or chapter). Follow this procedure when you convert a playlist into an original title.

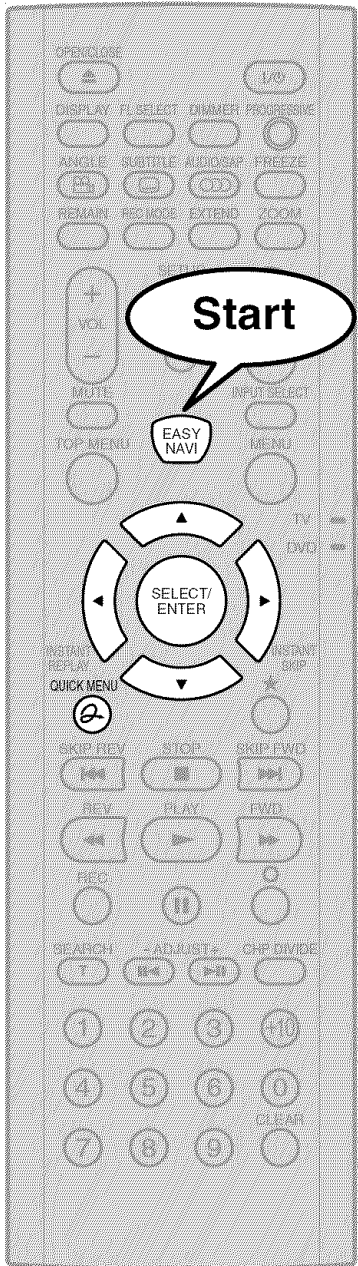

## 1 Press EASY NAVI.

EASY NAVI Main Menu appears.



## 2 Press ▲/▼/◀/▶ to select “Play Contents”, then press SELECT/ENTER.

CONTENT MENU Title List appears.

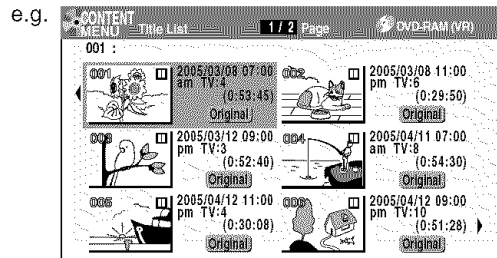
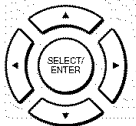

## 3 Press ▲/▼/◀/▶ to select a part (a title or chapter) to copy.

- You can go forward/back to pages by pressing FWD or REV button.
- To select a chapter, highlight a title and press ★ button. If you press the button again, the title list reappears.

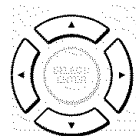

## 4 Press QUICK MENU then select “High speed dubbing” pressing ▲/▼ from Quick Menu, then press SELECT/ENTER.

CONTENT MENU High Speed Library Dubbing appears.

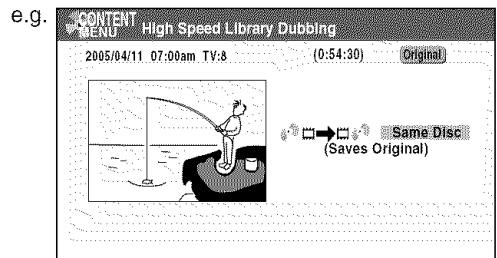
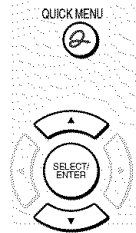



## 5 Press SELECT/ENTER.

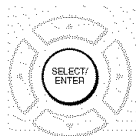

Copying starts.

A new title with the same contents is created on the same disc.

The job progress is displayed on the screen and the front panel display.

When the job finishes, the graph disappears.

You can set the recorder to turn off automatically when the job finishes.

(1) During the operation, press QUICK MENU button.

(2) Press ▲ / ▼ buttons to select "Auto power off".

(3) Press SELECT/ENTER button.

### Notes

- Copying a Playlist makes an Original, leaving the Playlist as it is.
- A title or a chapter becomes a title by being copied.
- Copying is interrupted when a program recording is about to start.
- This function is available only for copying contents on a DVD-RAM disc to the same disc.
- If copying is not allowed due to some conditions, such as lack of disc space, etc., a message will appear. Follow the procedure indicated there.
- Depending on the contents, some reference information or appendix data may not be copied.
- A title that contains a still picture cannot be copied.

### ■ To cancel copying halfway through the operation

#### 1) During copying, press QUICK MENU.

Quick Menu appears.

#### 2) Press ▲ / ▼ to select "Cancel dubbing", then press SELECT/ENTER.

### Note

- Cancellation of a copying operation will result in deletion of a portion of the title or chapter already copied.

# Deleting selected items (Deleting multiple specified parts)

This section explains how to simultaneously delete unnecessary titles and chapters.  
On a finalized DVD-R/RW disc, this feature is not possible.

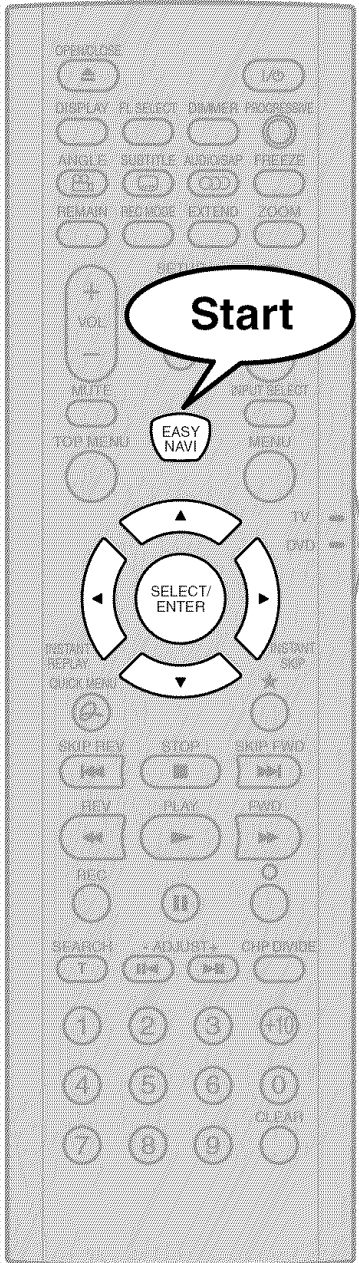

## 1 Press EASY NAVI.

EASY NAVI Main Menu appears.



## 2 Press ▲/▼/◀/▶ to select "Edit Menu", then press SELECT/ENTER.

EDIT MENU Main Menu appears.



## 3 Press ▲/▼ to select "Del Selected Items".

e.g.

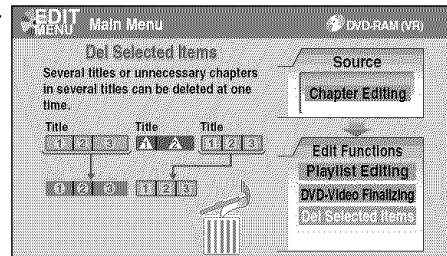

## 4 Press SELECT/ENTER.

EDIT MENU Del Selected Items appears.

e.g.

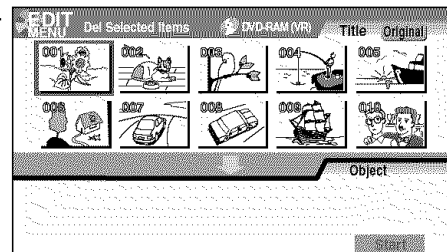

Thumbnails of the parts in the disc are displayed in the upper area.

**5** Following steps 6 to 8 on  page 90, 91, assemble the items to delete.

**6** Press **▼** repeatedly to select “Start”, then press **SELECT/ENTER**.

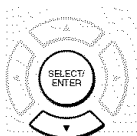

The recorder begins the deletion process.

To cancel deleting, press **◀/▶** buttons to select “No”, then press **SELECT/ENTER** button.

When the process is finished, **EDIT MENU Main Menu** returns.

#### Notes

- To confirm the first and last scenes of an item, first select an item then press **QUICK MENU** button. Press **▲/▼** buttons to select “Preview” (or “Title information”) then press **SELECT/ENTER** button. This is available only on contents recorded in DVD-RAM discs.
- Titles and chapters show their names for about 2 seconds at the bottom of the screen when they are selected.
- On a DVD-RW disc, deleting can restore the disc space only by deleting the last recorded title.
- Deleting cannot be canceled once started. Be careful when executing the deletion process.
- If you select a title for the part to be removed, you cannot select chapters in that title.
- Chapters in DVD-R/RW discs cannot be selected to delete.

# DVD-Video finalizing process

The recorder processes recorded data in a DVD-R/RW disc so that it can be played on other compatible devices.

## Important

- You cannot rewrite data onto a disc after you execute the DVD-Video finalizing process. However, the disabled rewritability of a DVD-RW disc can be restored by canceling the process of the disc. (▶ page 103) On DVD-R discs, canceling of the DVD-Video finalizing process is not available.

## ■ Preparation

- Load a DVD-R/RW disc you want to execute the finalizing process.

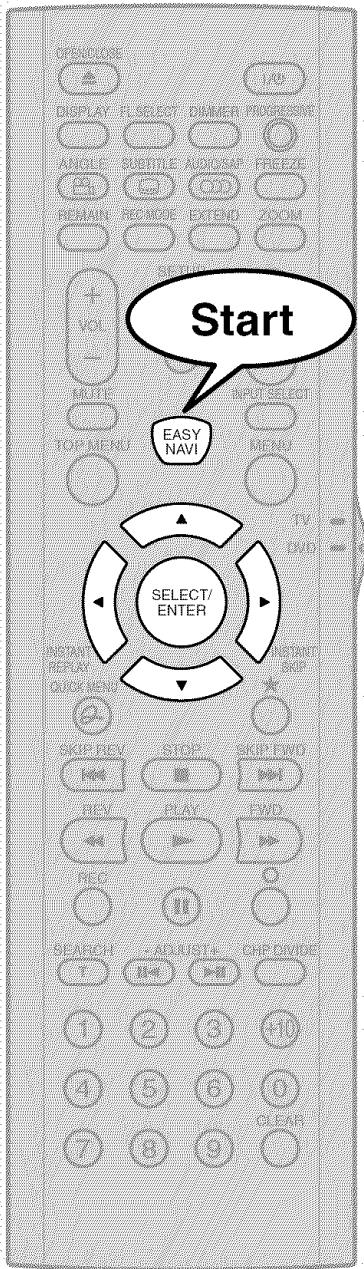

### 1 Press EASY NAVI.



EASY NAVI Main Menu appears.

### 2 Press ▲/▼/◀/▶ to select “Edit Menu”, then press SELECT/ENTER.

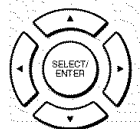

EDIT MENU Main Menu appears.

### 3 Press ▲/▼ to select “DVD-Video Finalizing”.

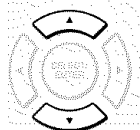

e.g.

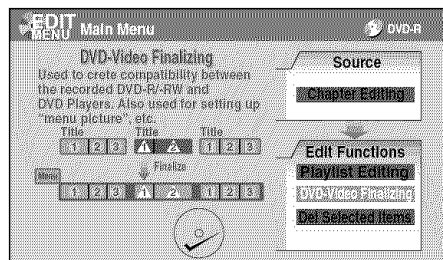

### 4 Press SELECT/ENTER.

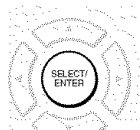

A display of option settings appears.

e.g.

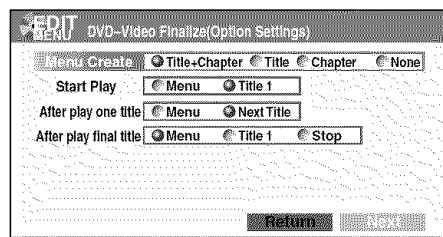

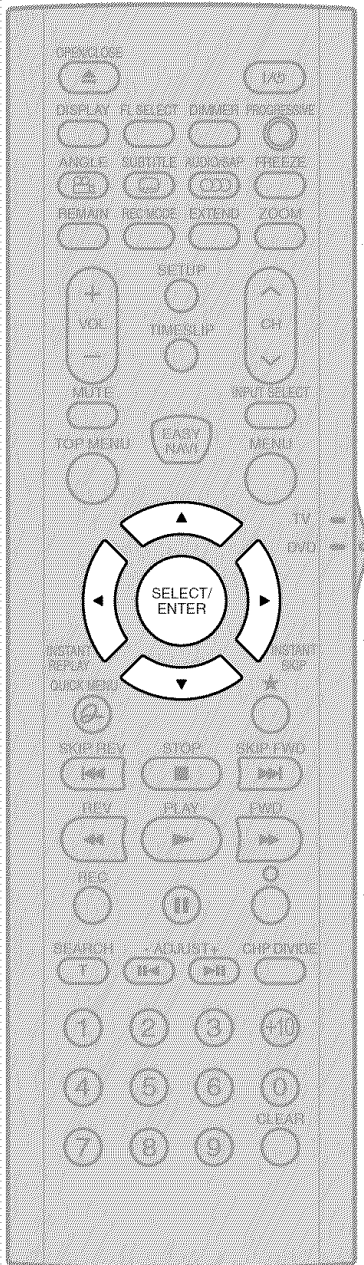

## 5 Press ▲/▼/◀/▶ to select.

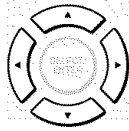

As you select each item, its function is explained.

When “Menu Create” is set to “None”:  
“Start Play” and “After play one title” are automatically omitted.

## 6 Press ▲/▼ to select “Next”, then press SELECT/ENTER.

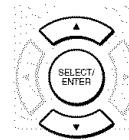

Information on data to be processed appears.

e.g.

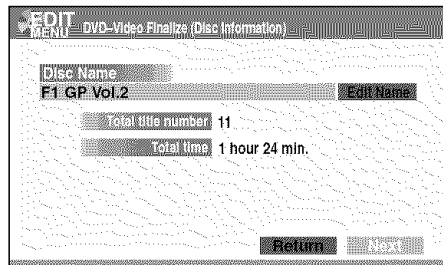

If you press ▲ button to select “Edit Name” then press SELECT/ENTER button, a keyboard appears so that you can enter a title name.  
When “Menu Create” is set to “None”:  
Select “Writing” at the right bottom by ▲/▼/◀/▶ buttons and press SELECT/ENTER button. Skip to step 11.

## 7 Press ▼ to select “Next”, then press SELECT/ENTER.

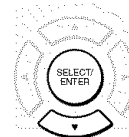

When “Menu Create” is set to “Title+Chapter” or “Title”, a display of title menu selection appears.

e.g.

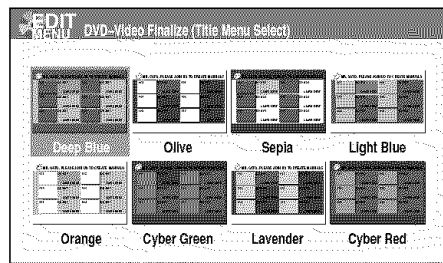

If you press ★ button, you can preview the selected menu. To return, press O button.

(Continued)

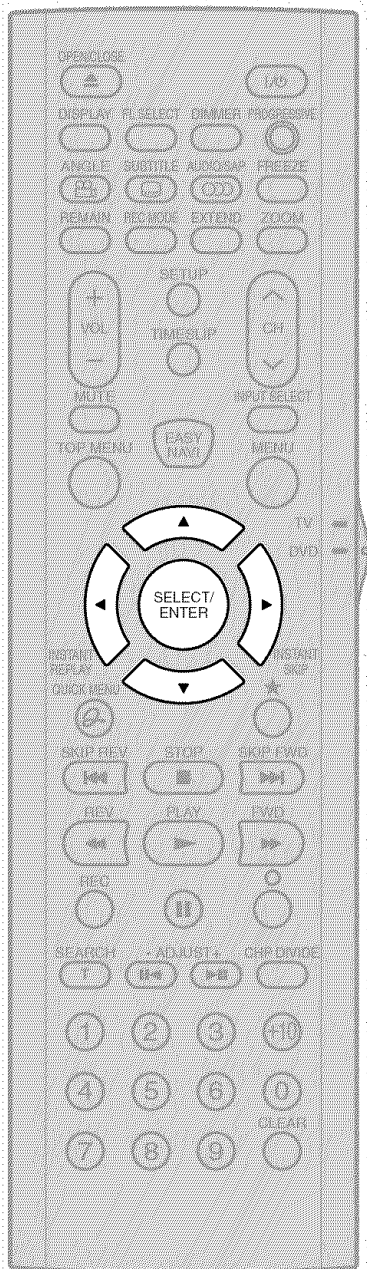

**8** Press **▲/▼/◀/▶** to select the title menu, then press **SELECT/ENTER**.

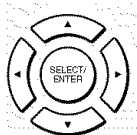

A display of menu selection for chapters appears.

**9** Press **▲/▼/◀/▶** to select the chapter menu.



A selected menu is applied to all chapters. You cannot allocate a menu to each chapter.

If you press **★** button, you can preview the selected menu. To return, press **O** button.

If you press **▼** button during preview, to select "Return" then press **SELECT/ENTER** button, you can go to the preview of the selected title menu. To return to preview of chapter menu, press **▲/▼/◀/▶** buttons to select a number next to "Chapter Menu" then press **SELECT/ENTER** button.

**10** On **EDIT MENU DVD-Video Finalize (Chapter Menu Select)**, press **SELECT/ENTER**, and select **"Yes"** by **◀/▶**, then press **SELECT/ENTER**.

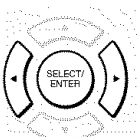

A message appears to ask you if you want the power to turn off automatically or not when the process is completed.

**11** Press **◀/▶** to select **"Yes"** or **"No"** then press **SELECT/ENTER**.

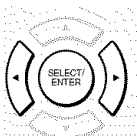

A message disappears and the finalize process starts. The progress is displayed on the screen and in the front panel display on the recorder.

### Notes

- DVD-R/RW discs recorded on this recorder may not be recognized on other devices unless you execute DVD-Video finalizing process to them.
- You can record onto a DVD-R disc additionally to the limit of the disc capacity, unless you execute the DVD-Video finalizing process to it. Deleting of recorded titles is also possible, however, the disc space cannot be restored.
- You can record additional content onto a DVD-RW disc additionally to the limit of the disc capacity unless you execute the DVD-Video finalizing process to it. Deleting of recorded titles is also possible, however, the disc space can be restored only by the volume of the title last recorded.
- On DVD-RW discs, it is possible to cancel the DVD-Video finalizing process or to initialize for a new use.

### ■ To cancel the finalize process **DVD-RW**

You can cancel the DVD-Video finalizing process executed to a DVD-RW disc so that the disc can be recordable again.

#### 1) During stop, press QUICK MENU.

Quick menu appears.

#### 2) Press ▲ / ▼ to select “Disc management” then press SELECT/ENTER.

#### 3) Press ▲ / ▼ to select “Cancel finalization” then press SELECT/ENTER.

#### 4) Read the message, and press ◀ / ▶ to select “Yes”, then press SELECT/ENTER.

The process starts.

### Notes

- While the recorder is ready to start a programmed recording, you cannot cancel the DVD-Video finalizing process.
- You cannot cancel the DVD-Video finalizing process executed on a DVD-RW disc recorded on other device.
- You cannot cancel the DVD-Video finalizing process executed on a DVD-RW disc if the disc is protected.
- Canceling the DVD-Video finalizing process may shift the thumbnails of titles/chapters.





# Function Setup

You can change the default settings to customize performance to your preference.

- **Customizing the function settings**

# Customizing the function settings

You can change the default settings to customize performance to your preference.

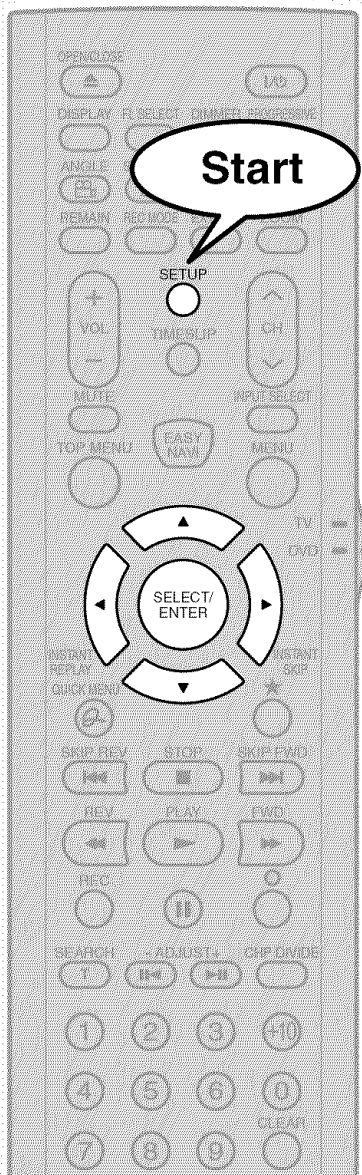

## 1 During stop, press SETUP.

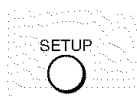

The following setup display appears.



## 2 Press ◀/▶ to select the icon of a group that contains a desired item, then press SELECT/ENTER.

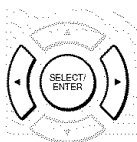

For details on each setting, see the next page.

e.g. When "Display settings" is selected:

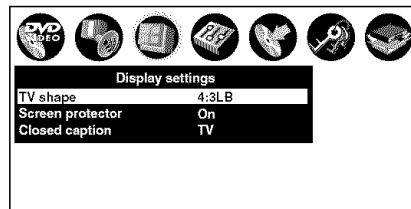

## 3 Press ▲/▼ to select a desired item, then press SELECT/ENTER.

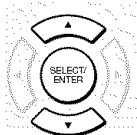

## 4 Refer to the explanations on pages beginning from 110, to change the selection by ▲/▼ or other buttons, then press SELECT/ENTER.

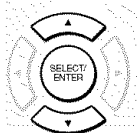

- To select another item in the same group, repeat steps 3 to 4.
- To shift to another group, press O button then repeat steps 2 to 4.

## 5 Press SETUP.

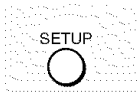

The setup display disappears and the setting is completed.

### Notes

- SETUP button can function even during normal playback. However some items may be grayed out and they cannot be selected. In this case, try again after playback is stopped.
- SETUP button does not function during recording, Recorded Title Play, Chase Play or Pause TV modes.

| Setting   | Details   | Page |
|---|---|------|
| <b>DVD player settings</b>  |   |      |
| <b>DVD disc menu language</b><br>DVD-VIDEO                          | To select a preferred language for disc menus.  | 110  |
| <b>DVD audio language</b><br>DVD-VIDEO                              | To select a preferred language for the sound track.   | 110  |
| <b>DVD subtitle language</b><br>DVD-VIDEO                           | To select a preferred language for subtitles.   | 110  |
| <b>DVD dynamic range control</b><br>DVD-RAM DVD-RW DVD-R DVD-VIDEO  | To turn on or off a function that makes faint sounds easier to hear even if you lower the volume during late-hour playback. | 111  |
| <b>Karaoke vocal</b><br>DVD-VIDEO                                   | To turn on or off the vocal output during DVD KARAOKE disc playback.  | 111  |
| <b>DVD parental lock</b><br>DVD-VIDEO                               | To turn the parental lock function on or off.   | 111  |
| <b>DVD title stop</b><br>DVD-RW DVD-R DVD-VIDEO                     | To turn on or off a feature that automatically stops playback after a title has been viewed.                                | 112  |
| <b>Picture/Audio settings</b>                                       |   |      |
| <b>Output black level</b><br>DVD-RAM DVD-RW DVD-R DVD-VIDEO VCD     | To select the black level of playback pictures.   | 113  |
| <b>Custom picture select</b><br>DVD-RAM DVD-RW DVD-R DVD-VIDEO VCD  | To select from standard or three customized picture settings.   | 113  |
| <b>Custom picture setting</b><br>DVD-RAM DVD-RW DVD-R DVD-VIDEO VCD | To customize picture quality settings and store them.   | 113  |
| <b>Progressive conversion</b><br>DVD-RAM DVD-RW DVD-R DVD-VIDEO VCD | To select the system of output signal. (Only when connected to a PROGRESSIVE TV.)   | 113  |
| <b>Play DNR</b><br>DVD-RAM DVD-RW DVD-R DVD-VIDEO VCD               | To select a setting for playback at a reduced noise level.  | 114  |
| <b>Audio out select</b><br>DVD-RAM DVD-RW DVD-R DVD-VIDEO<br>VCD CD | To select an output sound format corresponding to your system connection.   | 114  |
| <b>Virtual surround</b><br>DVD-RAM DVD-RW DVD-R DVD-VIDEO           | To turn on or off expansive virtual surround sound effects from just two speakers.  | 114  |
| <b>SAP</b>  | To monitor and record SAP broadcast.  | 114  |

(Continued)

Customizing the function settings (Continued)

| Setting  | Details  | Page |
|--|--|------|
| <b>Display settings</b>  |  |      |
| <b>TV shape</b><br>DVD-RAM DVD-RW DVD-R DVD-VIDEO VCD                      | To select a picture size according to the aspect ratio of your TV.   | 115  |
| <b>Screen protector</b><br>DVD-RAM DVD-RW DVD-R DVD-VIDEO<br>VCD CD        | To turn the screen saver on or off.  | 115  |
| <b>Closed caption</b>  | To select where you turn on or off closed caption.   | 115  |
| <b>Operational settings</b>  |  |      |
| <b>IR code</b>   | To switch the codes that operate the recorder.   | 116  |
| <b>Instant skip interval</b><br>DVD-RAM DVD-RW DVD-R DVD-VIDEO<br>VCD CD   | To set the width to skip when INSTANT SKIP button is pressed once.   | 116  |
| <b>Instant replay interval</b><br>DVD-RAM DVD-RW DVD-R DVD-VIDEO<br>VCD CD | To set the width to go back when INSTANT REPLAY button is pressed once.  | 116  |
| <b>Title thumbnail point</b><br>DVD-RAM DVD-RW DVD-R                       | To select the position of the thumbnail image counting from the beginning of the title that has been recorded. | 116  |
| <b>Title playback</b><br>DVD-RAM   | To activate resume play per title or continuous play.  | 116  |
| <b>Still group interval</b><br>DVD-RAM                                     | To select an interval of still picture display.  | 116  |
| <b>Priority contents</b>   | To select the playback priority between JPEG (picture) files and MP3/WMA (audio) files.                        | 116  |

| Setting  | Details   | Page |
|--|---|------|
| <b>DVD recorder operation</b>                      |   |      |
| <b>AV record quality</b><br>DVD-RAM DVD-RW DVD-R   | To select a recording mode for manual programme recording.  | 117  |
| <b>Picture record mode</b><br>DVD-RAM DVD-RW DVD-R | To make further setting when you cannot adjust the image quality with “Custom Picture Setting” of the “Picture/Audio Settings”. | 117  |
| <b>Input black level</b><br>DVD-RAM DVD-RW DVD-R   | To select the black level of recorded pictures.   | 117  |
| <b>Aspect ratio(Video mode)</b><br>DVD-RW DVD-R    | To set the aspect ratio for DVD-R/RW recording.   | 117  |
| <b>DVD compatible mode</b><br>DVD-RAM DVD-RW DVD-R | To set the audio for DVD-R/RW recording.  | 118  |
| <b>DVD-Video:CHP create</b><br>DVD-RW DVD-R        | To set whether or not chapters are to be automatically created at a specified interval for DVD-R/RW recording.                  | 118  |
| <b>Management settings</b>                         |   |      |
| <b>Genre setting</b><br>DVD-RAM DVD-RW DVD-R       | To register the frequently used genre in the menu.  | 119  |
| <b>DVD-RAM physical format</b><br>DVD-RAM          | To perform physical formatting of a DVD-RAM disc.   | 29   |
| <b>Software version</b>                            | To display the version of the software. The version is only displayed and cannot be set.  |      |
| <b>DVD drive software</b>                          | To display the version of the DVD drive software. The version is only displayed and it cannot be set.                           |      |
| <b>Initial settings</b>                            | See  page 30, “INSTALLATION GUIDE”.          |      |

## DVD player settings

### DVD disc menu language

DVD-VIDEO

**English:**

To display disc menus in English.

**French:**

To display disc menus in French.

**Spanish:**

To display disc menus in Spanish.

**Others:**

To make a further language choice.  
After pressing SELECT/ENTER button, follow steps 1) – 4) below.

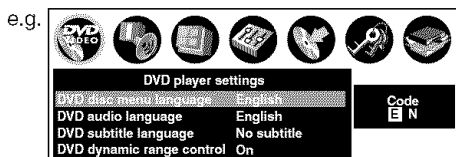

- 1) Obtain the language code of the preferred language from the Language code list (➡ page 126).
- 2) Select the first character by pressing ▲ / ▼ (or ADJUST).
- 3) Press ◀ / ▶ to shift. Select the second character by pressing ▲ / ▼ (or ADJUST).
- 4) Press SELECT/ENTER.

**Note**

- Some DVD video discs may not include your preset language. In this case, the recorder automatically displays disc menus consistent with the disc's initial language setting.

### DVD audio language

DVD-VIDEO

**English:**

To play sound tracks recorded in English.

**French:**

To play sound tracks recorded in French.

**Spanish:**

To play sound tracks recorded in Spanish.

**Others:**

To make further choices.  
After pressing SELECT/ENTER button, follow steps 1) - 4) below.



- 1) Obtain the language code of the preferred language from the Language code list (➡ page 126).
- 2) Select the first character by pressing ▲ / ▼ (or ADJUST).
- 3) Press ◀ / ▶ to shift. Select the second character by pressing ▲ / ▼ (or ADJUST).
- 4) Press SELECT/ENTER.

**Note**

- Some DVD video discs may be played in a different language from that you selected. A prior language may be programmed by the disc.

### DVD subtitle language

DVD-VIDEO

**English:**

To display subtitles in English.

**French:**

To display subtitles in French.

**Spanish:**

To display subtitles in Spanish.

**No Subtitle:**

To disable subtitles.

**Others:**

To make a further choice.  
After pressing SELECT/ENTER button, follow steps 1) – 4) below.



- 1) Obtain the language code of the preferred language from the Language code list (➡ page 126).
- 2) Select the first character by pressing ▲ / ▼ (or ADJUST).

- 3) Press ◀/▶ to shift. Select the proceeding character by pressing ▲/▼ (or ADJUST).
- 4) Press SELECT/ENTER.

**Notes**

- Some DVD video discs may be set to display subtitles in a different language from that you selected. A prior subtitle language may be programmed by the disc.
- Some DVD video discs allow you to change subtitle selections only via the disc menu. In this case, press MENU button and choose the appropriate subtitle language from the selection on the disc menu.

**DVD dynamic range control**

DVD-RAM DVD-RW DVD-R DVD-VIDEO

Turns on or off a function that makes faint sounds easier to hear even if you lower the volume during late-hour playback.

**Off:**

The DVD dynamic range control does not function.

**On:**

The DVD dynamic range control functions.

**Notes**

- This function is available only for a disc recorded in Dolby Digital format.
- Depending on the disc you play back, the actual effect of this function differs.

**Karaoke vocal**

DVD-VIDEO

**Off:**

The main vocal sound is not output.

**On:**

The main vocal sound is output.

**Notes**

- This function is available only for a DVD KARAOKE disc recorded in Dolby Digital Multi Channel format.
- If you want to enjoy the KARAOKE function, connect an amplifier or other such device to this recorder.

**DVD parental lock**

DVD-VIDEO

DVD video discs equipped with the Parental Lock function have a predetermined limitation level. The limitation level or limitation method may differ depending on the disc. For example the whole contents of a disc may not be played back, or an extreme violent scene maybe cut or replaced automatically by another scene.

**Important**

- Depending on discs, it may not be evident whether the disc is compatible with Parental Lock function. Make sure that Parental Lock function you set is activated correctly.

**On:**

Select this to activate Parental Lock function or to change the setting.  
After pressing SELECT/ENTER button, follow steps 1) – 3) below.

**Off:**

Deactivate Parental Lock function.  
After pressing SELECT/ENTER button, follow steps 1) below.

- 1) **Enter a 4-digit password by using the number buttons, then press SELECT/ENTER.**

If you make a mistake entering your password, press CLEAR button before pressing SELECT/ENTER button, and re-enter the correct password.

- 2) **Press ▲/▼/◀/▶ to move the cursor. Then press ADJUST to enter the code of a country/area whose standards were used to rate the DVD video disc, referring to the list below.**

(Continued)

Customizing the function settings (Continued)

| Country/Area       | Code |
|--------------------|------|
| AUSTRALIA          | AU   |
| BELGIUM            | BE   |
| CANADA             | CA   |
| CHINA              | CN   |
| CHINA HONG KONG    | HK   |
| DENMARK            | DK   |
| FINLAND            | FI   |
| FRANCE             | FR   |
| GERMANY            | DE   |
| INDONESIA          | ID   |
| ITALY              | IT   |
| JAPAN              | JP   |
| MALAYSIA           | MY   |
| NETHERLANDS        | NL   |
| NORWAY             | NO   |
| PHILIPPINES        | PH   |
| RUSSIAN FEDERATION | RU   |
| SINGAPORE          | SG   |
| SPAIN              | ES   |
| SWEDEN             | SE   |
| SWITZERLAND        | CH   |
| TAIWAN             | TW   |
| THAILAND           | TH   |
| UNITED KINGDOM     | GB   |
| UNITED STATES      | US   |

3) Select the desired limitation level by pressing ▲ / ▼, and then press SELECT/ENTER.

e.g.

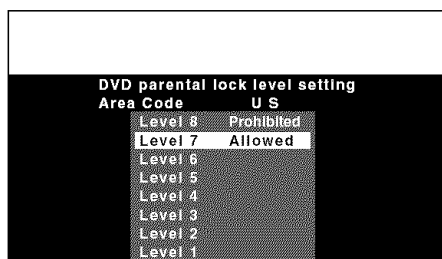

Unless the Parental lock function is set to “Off”, a disc that has a higher limitation level than your selected limitation level cannot be played back. For example, if you select level 7, discs exceeding level 8 are locked and cannot be played back.

When “US” is selected, its limitation level corresponds to the following settings.

- Level 7 : NC-17      Level 3 : PG
- Level 6 : R            Level 1 : G
- Level 4 : PG13

■ To change the limitation level of the Parental Lock function

Follow step 1) - 3) above.

■ To change the password

1) Press STOP 4 times after selecting “On” and “Off” in order, and then press SELECT/ENTER.

The password is cleared.

2) Enter a new 4-digit password by using the number buttons.

3) Press SELECT/ENTER.

DVD title stop



Off:

Plays back all following titles on the disc after the current title has been viewed.

On:

Recorder is stopped after playback of current title being viewed is completed.



## Picture/Audio settings

### Output black level

DVD-RAM DVD-RW DVD-R DVD-VIDEO VCD

You can adjust the black level of the output signal.

#### Standard:

Normal black level.

#### Enhanced:

To display deeper, richer black than in "Standard" setting.

#### Note

- This function is not available for the progressive format.

### Custom picture select

DVD-RAM DVD-RW DVD-R DVD-VIDEO VCD

Select from between 4 picture settings (Standard, Setting 1-3) you stored in the memory.

### Custom picture setting

DVD-RAM DVD-RW DVD-R DVD-VIDEO VCD

You can adjust fine picture quality and store up to 3 custom picture settings in the memory of the recorder.

- 1) Press **▲ / ▼** to select a desired setting from 3 settings, and then press **SELECT/ENTER**.

e.g.

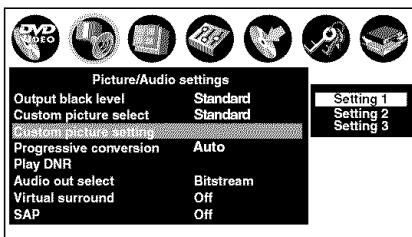

- 2) Press **▲ / ▼** to select adjustable items, and then press **◀ / ▶** to select each parameter.

#### Brightness

(0) Darker ⇔ Brighter (14)

#### Contrast

(-7) Lower ⇔ Higher (7)

#### Color

(-7) Duller ⇔ Brighter (7)

#### Tint

(-7) Red ⇔ Green (7)

#### Edge Enhance

SOFT/OFF/SHARP

#### Gamma

OFF/1/2

- 3) After adjusting the items, press **SELECT/ENTER**.

### Progressive conversion

DVD-RAM DVD-RW DVD-R DVD-VIDEO VCD

There are two types of source content in pictures recorded in DVD video discs: film content (pictures recorded from films at 24 frames per second) and video content (video signals recorded at 30 frames per second). Make this selection according to the type of content being viewed.

#### Auto:

Select this position normally.

The DVD player automatically detects source content, film or video, of playback source, and converts that signal in the progressive output format in an appropriate method.

#### Video:

The DVD player filters video signal, and converts it in the progressive output format appropriately. Suitable for playback of video content pictures.

#### Film:

The DVD player converts film content pictures in the progressive output format appropriately. Suitable for playback of film content pictures. The progressive output feature will be most effective under this selection.

#### Note

- Depending on the disc, pictures may be cut off or doubled.

### Customizing the function settings (Continued)

#### Play DNR

DVD-RAM DVD-RW DVD-R DVD-VIDEO VCD

Selects a setting for playback at a reduced noise level. Press ▲ / ▼ buttons to select an item then select "On" or "Off" using ◀ / ▶ buttons.

#### 3D-DNR:

##### Off:

Not activated.

##### On:

Reduces the noise levels of brightness signals and color signals present in the video signal during playback.

#### Mosquito NR:

##### Off:

Not activated.

##### On:

Reduces mosquito (flicker) noise occurring in the contour sections of images.

#### Block NR:

##### Off:

Not activated.

##### On:

Reduces noise that appears in the form of blocks (block noise) in a portion of the screen during playback of images with rapid movement.

DNR is the abbreviation for Digital Noise Reduction.

#### Notes

- DNR effects vary depending on the disc.
- Detailed images may no longer be visible depending on the scene due to the effects of DNR.
- Depending on the disc or scene, "On" may produce undesirable picture artifacts or increase noises on contours. In this instance, select "Off"
- While you are using the zoom feature, "DNR" does not function.

#### Audio out select

DVD-RAM DVD-RW DVD-R DVD-VIDEO VCD CD

Selects an output sound format corresponding to your audio system connection.

For details about output sound selection, see ➡ page 69.

#### Bitstream:

Select this when an amplifier equipped with built-in Dolby Digital, DTS or MPEG1 decoder is connected to this recorder.

When you play back a disc recorded in Dolby Digital, DTS or MPEG1 format, digital audio signal is output.

#### Analog 2ch:

Select this when a TV or other audio device is connected to this recorder via the ANALOG output connectors.

#### PCM:

Select this when a 2ch digital stereo amplifier is connected to this recorder. When you play back a disc recorded in Dolby Digital, MPEG1 or MPEG2 format, the sound is converted to the PCM (2ch) format and output.

"DTS" and "DTS Digital Out" are trademarks of Digital theater System, Inc.

#### Virtual surround

DVD-RAM DVD-RW DVD-R DVD-VIDEO

This lets you playback discs with acoustic effects having greater depth and presence even when using only two speakers.

##### Off:

Virtual surround effect not activated.

##### On:

Virtual surround effect activated.

#### Notes

- This function is only activated when playing back a disc recorded with Dolby Digital.
- This function is only activated when "Audio out select" is set to "PCM" if the BITSTREAM/PCM jack of this DVD recorder is connected to an amplifier or similar device.
- When the virtual surround effect is activated, Dolby Progressive Sound may be deactivated or sound differently than usual.
- When the virtual surround effect is activated, the volume may sound differently than usual.
- Set "Virtual surround" to "Off" if the audio sounds distorted.

Manufactured under license from QSound Labs, Inc. U.S. patent Nos. 5,105,462, 5,208,860 and 5,440,638 and various foreign counterpart. Copyright QSound Labs, Inc. 1998-2002. QXpander™ is a trademark of QSound Labs, Inc. All rights reserved.

#### SAP

SAP (Second Audio Program broadcast) is separate audio program, usually broadcast in a second language with the main language.

##### Off:

The main sound is received.

##### On:

SAP sound (second language) is received.

## Display settings

### TV shape

DVD-RAM DVD-RW DVD-R DVD-VIDEO VCD

Select a picture size according to the aspect ratio of your TV.

For details on this setting, see “TV shape setting” (➔ page 40, “INSTALLATION GUIDE”).

### Screen protector

DVD-RAM DVD-RW DVD-R DVD-VIDEO VCD CD

To reduce TV screen damage (image burn), this function disengages the pause mode of a playback image. The display returns to the normal TV screen when the recorder remains idle for more than 15 minutes. In time slip mode, the playback pause is released.

If this function is set to “On”, the recorder, if freezes, may return to the normal by leaving it for about 15 minutes or longer.

#### Off:

Deactivates the Screen Protector function.

#### On:

Activates the Screen Protector function.

#### Note

- Toshiba does not guarantee that this function protects the TV screen by all means.

### Closed caption

To select where you turn on or off closed caption.

#### Off:

To disable closed caption.

#### TV:

Closed caption data is decoded on the connected TV. To turn on or off closed caption, operate the connected TV.

#### Recorder:

Closed caption data is decoded on this recorder. You cannot turn off closed caption on the connected TV.

#### Notes

- While the recorder is sending signals in the progressive output format, closed caption is disabled regardless of this setting.
- Depending on the signal condition, closed caption may not be displayed properly. In this case, select “Off.”

## Operational settings

### IR Code

Switches the codes to operate the recorder. If you use the second and third TOSHIBA DVD video recorders, set the different remote codes for each recorder to avoid confusion in the response of the recorders.

For details about this setting, refer to "Operating the second and third TOSHIBA DVD video recorders with the remote control of this recorder" (➡ page 44, "INSTALLATION GUIDE").

**DR 1 : DR 2 : DR 3**

### Instant skip interval

DVD-RAM | DVD-RW | DVD-R | DVD-VIDEO | VCD | CD

Sets how much time is skipped when INSTANT SKIP button is pressed.

**5 sec. : 10 sec. : 30 sec. : 5 min.**

### Instant replay interval

DVD-RAM | DVD-RW | DVD-R | DVD-VIDEO | VCD | CD

Sets how far back is replayed when INSTANT REPLAY button is pressed.

**5 sec. : 10 sec. : 30 sec. : 5 min.**

### Title thumbnail point

DVD-RAM | DVD-RW | DVD-R

For recorded titles, sets how far a scene from the start is set as the title thumbnail.

**0 sec. : 3 sec. : 10 sec. : 35 sec. : 1 min. : 5 min.**

#### Note

- Thumbnails can also be changed to other scenes. See ➡ page 93.

### Title playback

DVD-RAM

Sets the resume play per title.

#### Title resume:

Remembers the point where you stop playback. Allows you to resume the playback from that point.

#### Serial playback:

You can play back titles (Original, Playlist) stored in the DVD-RAM continuously. Because there is no division between titles, the recorder remembers only the last point where you stopped playback.

### Still group interval

DVD-RAM

Sets an interval for display of still pictures (in seconds) when playing back a collection of still images.

**1 sec. : 2 sec. : 3 sec. : 5 sec. : 10 sec. : Default**

### Priority contents

To select the playback priority between JPEG (picture) files and MP3/WMA (audio) files.

**Photo:** JPEG files take priority over MP3/WMA files.

**Audio:** MP3/WMA files take priority over JPEG files.

#### Note

- If this selection does not correspond to disc contents, the recorder will take a longer time to start playback of the disc.

## DVD recorder operation

### AV record quality

DVD-RAM | DVD-RW | DVD-R

You can select from 5 recording modes prior to actual recording.

Actual selection applied becomes the default setting for the normal recording or programmed recording.

e.g.

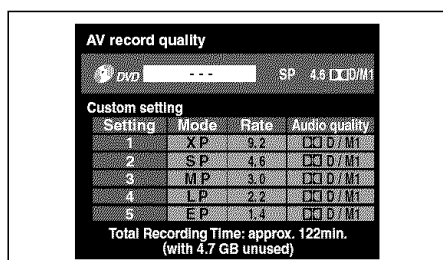

#### • To apply the recording mode

- 1) Press ADJUST to change the setting.  
You can confirm the available recording time for the selected setting on the bottom screen.
- 2) Press SELECT/ENTER.

#### Note

- You can change the recording mode also by displaying Quick Menu during stop mode, then selecting "AV record quality". Either of the above methods updates the setting of this recorder.

### Picture record mode

DVD-RAM | DVD-RW | DVD-R

Adjusts problems with the brightness of video signals of TV broadcasts or other external input.

Press ▲/▼ buttons to select the source, and ◀/▶ buttons to select the mode.

(Only use this setting when you cannot adjust the brightness satisfactorily with the Custom picture setting in the Picture/Audio settings (▶ page 113) of this recorder.)

#### Important:

- This setting changes the video signal to record and the recorded signal is not returned to the original state even when this setting is changed after recording. When duplicating from VHS tape, if you can check the video recording state beforehand, we recommend first playing back for a while and checking the overall brightness tendency, then setting an appropriate mode.

#### Standard:

The brightness of signals received with this recorder and external input signals is adjusted automatically. This is normally the setting to use.

#### Mode 1:

This setting is used to record the signals darker when the screen is too bright.

#### Mode 2, 3, 4:

As the number rises, the signals are recorded brighter. Use these modes to adjust the brightness.

### Input Black level

DVD-RAM | DVD-RW | DVD-R

You can adjust the black level of the input signal.

#### Standard:

Normal black level.

#### Enhanced:

Brighter black level than in "Standard" setting.

### Customizing the function settings (Continued)

#### Aspect ratio(Video mode)

---

**DVD-RW** **DVD-R**

To set the aspect ratio when recording onto a DVD-R/RW disc.

**4:3:**

Fixes the aspect ratio at 4:3.

**16:9:**

Fixes the aspect ratio at 16:9.

**Note**

- When “AV record quality” is set to “EP”, pictures are recorded in 4:3 aspect ratio even if “16:9” is selected.

#### DVD compatible mode

---

**DVD-RAM** **DVD-RW** **DVD-R**

To set whether or not recording is to be performed in the format for which recording is allowed by the DVD-Video standard (video, audio and other data) during recording.

**Off:**

When recording on a DVD-RAM disc, both the main and SAP sounds are recorded.  
When recording on a DVD-R/RW disc, this is ineffective. The recorder will automatically regard this as “Main,” and record sound of the main channel only in stereo. Select “Main” or “SAP” for a DVD-R/RW recording.

**Main:**

Records sound of the main channel only in stereo.

**SAP:**

Records sound of the SAP channel only in stereo.

**Notes**

- When “AV record quality” is set to “MP” and set this mode to “Main” or “SAP”, the picture quality may become lower than when you set this mode to “Off”.
- You can change the setting from Quick Menu.

#### DVD-Video:CHP create

---

**DVD-RW** **DVD-R**

To set whether chapters are to be automatically created at a selected interval during DVD-R/RW recording.

**Off:**

Chapters are not set.

**5 min. : 10 min. : 15 min. : 20 min.**

To set the interval at which chapters are automatically created to 5, 10, 15 or 20 minutes.

**Note**

- The number of chapters has the upper limit, which varies depending on the disc condition. If the number reaches it, no more chapters are created.

## Management settings

### Genre setting

DVD-RAM DVD-RW DVD-R

This registers a frequently used genre name onto the menu. Genre names registered here are displayed in “Genre” on Quick Menu.

- 1) Press ▲ / ▼ to select a position in the “Current Genre List” you want to change, then press SELECT/ENTER.

A list of genres appears.

You can turn the pages using the ► button.

- 2) Press ▲ / ▼ to select a genre, then press SELECT/ENTER.

A list of genre names appears.

- 3) Press ▲ / ▼ to select a genre name, then press SELECT/ENTER.

The selected genre name replaces the previous one of the position you selected at step 1).

- 4) Repeat steps 1) to 3) to register genre names.

- 5) When genre names are registered, press O button to return to “Management settings” menu.

### DVD-RAM physical format

DVD-RAM

See ➡ page 29.





# Others

- Before calling service personnel
- Error codes on the display window
- Recording duration
- Language code list
- Specification

# Before calling service personnel

If you experience any of the following difficulties while using this unit, check the list below before consulting your nearest Toshiba dealer.

## Power

### ■ The power is not turned on.

- The power cord is not connected securely.  
→ Connect the power cord securely.

## Connection to your TV

### ■ There is no TV picture.

- The video cable to this recorder and your TV is not connected securely.  
→ Connect the video cable to this recorder and your TV securely.
- The input select on your TV is not set properly.  
→ Select the input to which this recorder is connected.

## TV reception

### ■ There is no picture.

- The antenna cable is not connected securely.  
→ Reconnect the antenna cable securely.

### ■ There is poor reception.

- Channel settings are not completed.  
→ Set the channels.
- The antenna cable is not connected securely.  
→ Reconnect the antenna cable securely.
- Antenna signal is poor.  
→ Consult your dealer for adjustment.

## Playback

### ■ A DVD or CD does not play.

- The format of the recorded data does not correspond to this recorder, or the region number is neither "1" nor "ALL".  
→ Check the disc.
- A defective or dirty disc is inside.  
→ Change the disc.

### ■ During playback, picture noise appears.

- Picture noise may appear in the following cases. It is not a malfunction.
  - There is picture noise in the original recording.
  - Weather, reception conditions may cause noise.
  - The AV recording mode with the low data rate such as "LP" or "EP" is selected.
  - The image data processing of this recorder cannot follow dynamic movement on the screen. (High video data rate)
  - A physical error has occurred on the DVD disc.

If an error occurs while reading data of a disc, block noises may be produced there. Repeated reading of this location where the error occurred (retry) can decrease the generation of block noise. However, it can also raise the possibility of unintended delays or stops of playback. In order to prevent them, the recorder limits the number of times of retry.

## Note on when the recording mode is set to "XP" or "AT" (When a high rate is automatically set)

### ■ TIMESLIP

- Pause TV  
→ The recording mode is automatically set to "SP" and the recorder executes this function.
- Chase Play  
→ This function is not available.

### ■ Playback

- During a normal recording/a timer recording (includes: right before a timer recording is executed.)  
→ All the playback functions are not available.  
→ The search function is not available.

### ■ EASY NAVI

- During a normal recording/a timer recording (includes: right before a timer recording is executed.)  
→ "Edit menu" and "Play Contents" are not available on the menu.

## Recording

### ■ Data cannot be recorded on a DVD-RAM disc.

- The disc is protected from deleting data.  
→ Set the write-protect tab to the opposite of "PROTECT" (➡ page 8).
- The disc is protected by a PC or the recorder.  
→ Disable the protection on the device which protected the disc.
- The disc space is not sufficient.  
→ Delete unwanted data (➡ page 47) or prepare a new disc.
- The disc is not initialized.  
→ Initialize the disc (➡ page 28).
- The disc may contain errors.  
→ Complete the physical format on the disc (➡ page 29).
- The physical format on the disc is not completed.  
→ Complete the physical format on the disc (➡ page 29).

## Program

### ■ Timer programming cannot be completed.

- Clock setting has not been completed.  
→ Complete the clock setting (➡ page 33, "INSTALLATION GUIDE").
- The programs list is full.  
→ Cancel unwanted programs (➡ page 44).
- When the power goes down, timer programs will be deleted.  
→ Check the timer programs and set them again.

## Remote control

### ■ The remote control does not work.

- The batteries in the remote control are exhausted.  
→ Replace all the batteries in the remote control (➡ page 18, "INSTALLATION GUIDE").
- The light emitter of the remote control is not pointed at the receptor of this recorder.  
→ Point the emitter of the remote control at the receptor of this recorder.
- The receptor of this recorder is located too far away from the remote control.  
→ Operate the remote control within 7 meters (23 ft) from the receptor of this recorder.
- There are obstacles between the remote control and this recorder.  
→ Remove any obstacles.
- The receptor is disturbed by sunlight or fluorescent light.  
→ Change the place of this recorder or shield the light.
- The remote mode is not appropriate.  
→ Adjust the remote mode of the remote control and this recorder (➡ page 44, "INSTALLATION GUIDE").
- The setting of the TV/DVD selector is not correct.  
→ Set the TV/DVD selector to the equipment to operate.

## Clock

### ■ The clock blinks.

- Complete the initial setting again (➡ page 30, "INSTALLATION GUIDE").

### ■ The clock does not keep time.

- Set the time and date manually (➡ page 33, "INSTALLATION GUIDE").
- Set "Summer time" or "Time zone" correctly (➡ page 34, "INSTALLATION GUIDE").

# Error codes on the display window

The recorder display shows error codes in addition to the message screen.

Main examples are as follows.

The “\*\*\*” in the “ERR - \*\*” message indicates an error code. To delete this display, press the DISPLAY button on the remote control.

| Error code | Description   |                                       |
|------------|---|---------------------------------------|
| ERR-01     | Error detected in the physical format.                          |                                       |
| ERR-14     | DVD disc access error detected.                                 | • When creating a DVD-video.          |
| ERR-15     | Other errors detected.  |                                       |
| ERR-2E     | Menu encode error detected.                                     | • When recording onto DVD-R/RW discs. |
| ERR-2F     | Overflow of the menu size detected.                             |                                       |
| ERR-30     | Exceeded maximum number of menus detected.                      |                                       |
| ERR-31     | Recovery writing executed from compatibility of drive and disc. |                                       |
| ERR-32     | Incompatibility of disc format detected.                        |                                       |
| ERR-33     | Disc protected.   |                                       |
| ERR-34     | Disc protected or system control data error detected.           |                                       |
| ERR-35     | Exceeded volume in disc budget calculation detected.            |                                       |
| ERR-36     | Recording failed. (Title not saved.)                            |                                       |
| ERR-37     | Recording failed. (Title saved.)                                |                                       |
| ERR-38     | Writing failed. (Title not reserved.)                           |                                       |
| ERR-39     | Writing failed. (Title saved.)                                  |                                       |
| ERR-3A     | Unexpected error detected.                                      |                                       |

## Note

- If you find an error code other than listed above, consult your nearest TOSHIBA dealer.

# Recording duration

| Picture quality rate | D/D /M1(192kbps) |        | Remarks |
|----------------------|------------------|--------|---------|
|                      | DVD-RAM          |        |         |
|                      | Hour             | Minute |         |
| XP (9.2 Mbps)        | 01               | 01     |         |
| SP (4.6 Mbps)        | 02               | 02     |         |
| MP (3.0 Mbps)        | 03               | 02     |         |
| LP (2.2 Mbps)        | 04               | 01     |         |
| EP (1.4 Mbps)        | 06               | 07     |         |

- The recording durations listed above are for reference purposes only and are not guaranteed. Recording durations may vary.
- The recording durations for DVD-RAM discs listed above are applicable to DVD-RAM discs that have been initialized. Actual recording duration may vary depending on the disc used.
- If you subtract the actual recording duration from the duration listed in this table, the calculated time period does not represent the remaining time.
- The consumption of space may vary depending on the picture and sound conditions of the recorded content.
- Use the remaining disc space display feature to see the remaining space in the DVD-RAM disc.

For D/D /M1, the digital recording technology for consumer products of Dolby Laboratories is used.

D/D /M1 records in Dolby Digital at 192 kbps.

# Language code list

**Table of languages and their abbreviations**

| Abbreviation | Language              | Abbreviation | Language         | Abbreviation | Language       |
|--------------|-----------------------|--------------|------------------|--------------|----------------|
| ---          | No alternate language | GN           | Guarani          | PT           | Portuguese     |
| CHI (ZH)     | Chinese               | GU           | Gujarati         | QU           | Quechua        |
| DUT (NL)     | Dutch                 | HA           | Hausa            | RM           | Rhaeto-Romance |
| ENG (EN)     | English               | HI           | Hindi            | RN           | Kirundi        |
| FRE (FR)     | French                | HR           | Croatian         | RO           | Rumanian       |
| GER (DE)     | German                | HU           | Hungarian        | RU           | Russian        |
| ITA (IT)     | Italian               | HY           | Armenian         | RW           | Kinyarwanda    |
| JPN (JA)     | Japanese              | IA           | Interlingua      | SA           | Sanskrit       |
| KOR (KO)     | Korean                | IE           | Interlingue      | SD           | Sindhi         |
| MAY (MS)     | Malay                 | IK           | Inupiak          | SG           | Sango          |
| SPA (ES)     | Spanish               | IN           | Indonesian       | SH           | Serbo-Croatian |
| AA           | Afar                  | IS           | Icelandic        | SI           | Singhalese     |
| AB           | Abkhazian             | IW           | Hebrew           | SK           | Slovak         |
| AF           | Afrikaans             | JI           | Yiddish          | SL           | Slovenian      |
| AM           | Amharic               | JW           | Javanese         | SM           | Samoaan        |
| AR           | Arabic                | KA           | Georgian         | SN           | Shona          |
| AS           | Assamese              | KK           | Kazakh           | SO           | Somali         |
| AY           | Aymara                | KL           | Greenlandic      | SQ           | Albanian       |
| AZ           | Azerbaijani           | KM           | Cambodian        | SR           | Serbian        |
| BA           | Bashkir               | KN           | Kannada          | SS           | Siswati        |
| BE           | Belorussian           | KS           | Kashmiri         | ST           | Sesotho        |
| BG           | Bulgarian             | KU           | Kurdish          | SU           | Sundanese      |
| BH           | Bihari                | KY           | Kirghiz          | SV           | Swedish        |
| BI           | Bislama               | LA           | Latin            | SW           | Swahili        |
| BN           | Bengali, Bangla       | LN           | Lingala          | TA           | Tamil          |
| BO           | Tibetan               | LO           | Laotian          | TE           | Telugu         |
| BR           | Breton                | LT           | Lithuanian       | TG           | Tajik          |
| CA           | Catalan               | LV           | Latvian, Lettish | TH           | Thai           |
| CO           | Corsican              | MG           | Malagasy         | TI           | Tigrinya       |
| CS           | Czech                 | MI           | Maori            | TK           | Turkmen        |
| CY           | Welsh                 | MK           | Macedonian       | TL           | Tagalog        |
| DA           | Danish                | ML           | Malayalam        | TN           | Setswana       |
| DZ           | Bhutani               | MN           | Mongolian        | TO           | Tongan         |
| EL           | Greek                 | MO           | Moldavian        | TR           | Turkish        |
| EO           | Esperanto             | MR           | Marathi          | TS           | Tsonga         |
| ET           | Estonian              | MT           | Maltese          | TT           | Tatar          |
| EU           | Basque                | MY           | Burmese          | TW           | Twi            |
| FA           | Persian               | NA           | Nauru            | UK           | Ukrainian      |
| FI           | Finnish               | NE           | Nepali           | UR           | Urdu           |
| FJ           | Fiji                  | NO           | Norwegian        | UZ           | Uzbek          |
| FO           | Faroese               | OC           | Occitan          | VI           | Vietnamese     |
| FY           | Frisian               | OM           | (Afan) Oromo     | VO           | Volapük        |
| GA           | Irish                 | OR           | Oriya            | WO           | Wolof          |
| GD           | Scottish Gaelic       | PA           | Panjabi          | XH           | Xhosa          |
| GL           | Galician              | PL           | Polish           | YO           | Yoruba         |
|              |                       | PS           | Pashto, Pushto   | ZU           | Zulu           |

# Specification

## ■ Power requirement during operation

21W

## ■ Power requirement at standby

2.7W

## ■ Power supply

120V AC, 60 Hz

## ■ Mass

3.5kg

## ■ External dimension

Width 430 x Height 58 x Depth 304mm

## ■ Incoming channels

TV: 2-69CH, Cable:1-125CH

## ■ Antenna input/output terminal

VHF/UHF: 75Ω, F Connector

## ■ Signal system

Standard NTSC Color TV system

## ■ Laser

Semiconductor laser, Wavelength: 650nm/780nm

## ■ Format

DVD-VR format  
DVD-Video format

## ■ Image recording system

MPEG2

## ■ Sound recording system

Dolby digital

## ■ VIDEO input

1.0Vp-p (75Ω), Sync signal negative,  
Pin jack x 2 systems, 1 at rear, 1 in front

## ■ VIDEO output

1.0Vp-p (75Ω), Sync signal negative,  
Pin jack x 1 systems, 1 at rear

## ■ S-VIDEO input

(Y) 1.0Vp-p (75Ω), Sync signal negative,  
(C) 0.286Vp-p (75Ω), 1 at rear, 1 in front  
Mini DIN4 Pin x 2 systems

## ■ S-VIDEO output

(Y) 1.0Vp-p (75Ω), Sync signal negative,  
(C) 0.286Vp-p (75Ω), 1 at rear  
Mini DIN4 Pin x 1 system

## ■ COMPONENT output (Y, P<sub>B</sub>, P<sub>R</sub>)

Y output (green), 1.0Vp-p (75Ω),  
Sync signal negative, Pin jack x 1 system  
P<sub>B</sub>, P<sub>R</sub> output (blue, red), 0.7Vp-p (75Ω),  
Pin jack x 1 system each

## ■ AUDIO input

2.0V (rms), 22kΩ or above, pin jack  
(L, R) x 2 systems  
1 at rear, 1 in front

## ■ AUDIO output

2.0V (rms), 2.2kΩ or below, pin jack  
(L, R) x 2 systems  
2 at rear

## ■ DIGITAL AUDIO OUTPUT BITSTREAM/PCM (OPTICAL terminal)

Optical connector x 1 system

## ■ Remote control

Wireless remote control (SE-R0176)

## ■ Operating conditions

Temperature: 41°F ~ 95°F (5°C ~ 35°C),  
Position: Horizontal

## ■ Clock display

12 hour digital display

## ■ Clock accuracy

Quartz (monthly deviation: approximately ±30  
seconds)

- This model complies with the below specifications.
- Designs and specifications are subject to change without notice.
- This model may not be compatible with features and/or specifications that may be added in the future.
- The screen illustrations used in this Operating Guide are for reference purposes only. Because the screen illustrations used in this Operating Guide are simplified for easy recognition, they may vary slightly from the unit's actual screen displays.

## Limited United States Warranty

### Digital Audio Video ("DAV") Product-Depot Repair Warranty

Toshiba America Consumer Products, L.L.C., ("TACP") makes the following limited warranties to original consumers in the United States. THESE LIMITED WARRANTIES EXTEND TO THE ORIGINAL CONSUMER PURCHASER OR ANY PERSON RECEIVING THIS DAV PRODUCT AS A GIFT FROM THE ORIGINAL CONSUMER PURCHASER AND TO NO OTHER PURCHASER OR TRANSFEREE.

DAV PRODUCTS PURCHASED IN THE U.S.A. AND USED ANYWHERE OUTSIDE OF THE U.S.A., INCLUDING, WITHOUT LIMITATION, CANADA AND MEXICO, ARE NOT COVERED BY THESE WARRANTIES.

DAV PRODUCTS PURCHASED ANYWHERE OUTSIDE OF THE U.S.A., INCLUDING, WITHOUT LIMITATION, CANADA AND MEXICO, AND USED IN THE U.S.A., ARE NOT COVERED BY THESE WARRANTIES.

### Limited Ninety (90) Day Warranty on Labor\*

TACP warrants this DAV Product and its parts against defects in materials or workmanship for a period of ninety (90) days after the date of original retail purchase. DURING THIS PERIOD, TACP WILL, AT TACP'S OPTION, REPAIR OR REPLACE A DEFECTIVE PART WITH A NEW OR REFURBISHED PART WITHOUT CHARGE TO YOU FOR PARTS OR LABOR.

### Limited One (1) Year Warranty on Parts\*

TACP further warrants the parts in this DAV Product against defects in materials or workmanship for a period of one (1) year after the date of original retail purchase. DURING THIS PERIOD, TACP WILL, AT TACP'S OPTION, REPAIR OR REPLACE A DEFECTIVE PART WITH A NEW OR REFURBISHED PART WITHOUT CHARGE TO YOU FOR THE PART, PROVIDED THAT IF A DEFECTIVE PART IS REPAIRED OR REPLACED AFTER NINETY (90) DAYS FROM THE DATE OF ORIGINAL RETAIL PURCHASE, THE CONSUMER SHALL PAY ALL LABOR CHARGES INVOLVED IN THE REPAIR OR REPLACEMENT THEREOF.

### \*Rental Units

The warranty for DAV Product rental units begins on the date of the first rental or thirty (30) days after the date of shipment to the rental firm, whichever comes first.

### \*Commercial Units

DAV Products sold and used for commercial purposes have a limited warranty for all parts and labor, which warranty begins on the date of original retail purchase and ends on the date that is ninety (90) days thereafter.

### Owner's Manual and Product Registration Card

Read this owner's manual thoroughly before operating this DAV Product.

Complete and mail the enclosed product registration card or register your DAV Product on-line at [www.tacp.toshiba.com/service](http://www.tacp.toshiba.com/service) as soon as possible. By registering your DAV Product you will enable TACP to bring you new products specifically designed to meet your needs and help us to contact you in the unlikely event a safety notification is required under the Consumer Product Safety Act. Failure to complete and return the product registration card does not diminish your warranty rights.

### Your Responsibility

THE ABOVE WARRANTIES ARE SUBJECT TO THE FOLLOWING CONDITIONS:

- (1) You must retain your bill of sale or provide other proof of purchase.
- (2) All warranty servicing of this DAV Product must be made by the Depot Warranty Repair Center specified by the TACP Consumer Solutions Center.
- (3) The warranties from TACP are effective only if the DAV Product is purchased and operated in the Continental U.S.A. or Puerto Rico.
- (4) Labor service charges for set installation, setup, adjustment of customer controls and installation or repair of antenna systems are not covered by this warranty. Reception problems caused by inadequate antenna systems are your responsibility.
- (5) Warranties extend only to defects in materials or workmanship as limited above and do not extend to any DAV Product or parts that have been lost or discarded by you or to damage to DAV Product or parts caused by fires, misuse, accident, Acts of God, such as lightning or fluctuations in electric power, improper installation, improper maintenance or use in violation of instructions furnished by TACP; use or malfunction through simultaneous use of this DAV Product and connected equipment; or to units that have been modified or had the serial number removed, altered, defaced, or rendered illegible.



## How to Obtain Warranty Services

If, after following all of the operating instructions in this manual and checking the section “Before calling service personnel”, you find that service is needed:

- (1) For instructions on how to obtain warranty service for your DAV Product, contact TACP’s Consumer Solution Center toll-free at 1-800-631-3811.
- (2) You must include a copy of original bill of sale or other proof of purchase along with the entire DAV Product to the Depot Warranty Repair Center specified by the TACP Consumer Solutions Center. You are responsible for all inbound transportation and insurance charges for the DAV Product to the Depot Warranty Repair Center specified by the TACP Consumer Solutions Center.

For additional information, visit TACP’s web site:  
[www.tacp.toshiba.com](http://www.tacp.toshiba.com).

ALL WARRANTIES IMPLIED BY THE LAW OF ANY STATE OF THE U.S.A., INCLUDING THE IMPLIED WARRANTIES OF MERCHANTABILITY AND FITNESS FOR A PARTICULAR PURPOSE, ARE EXPRESSLY LIMITED TO THE DURATION OF THE LIMITED WARRANTIES SET FORTH ABOVE. WITH THE EXCEPTION OF ANY WARRANTIES IMPLIED BY THE LAW OF ANY STATE OF THE U.S.A. AS HEREBY LIMITED, THE FOREGOING WARRANTY IS EXCLUSIVE AND IN LIEU OF ALL OTHER WARRANTIES, GUARANTEES, AGREEMENTS, AND SIMILAR OBLIGATIONS OF TACP WITH RESPECT TO THE REPAIR OR REPLACEMENT OF ANY PARTS. IN NO EVENT SHALL TACP BE LIABLE FOR CONSEQUENTIAL OR INCIDENTAL DAMAGES (INCLUDING, BUT NOT LIMITED TO, LOST PROFITS, BUSINESS INTERRUPTION, OR MODIFICATION OR ERASURE OF RECORDED DATA CAUSED BY USE, MISUSE OR INABILITY TO USE THIS DAV PRODUCT).

No person, agent, distributor, dealer or company is authorized to change, modify or extend the terms of these warranties in any manner whatsoever. The time within which an action must be commenced to enforce any obligation of TACP arising under the warranty or under any statute, or law of the United States or of any state thereof, is hereby limited to ninety (90) days from the date you discovered or should have discovered, the defect. This limitation does not apply to implied warranties arising under state law.

THIS WARRANTY GIVES YOU SPECIFIC LEGAL RIGHTS AND YOU MAY ALSO HAVE OTHER RIGHTS WHICH MAY VARY FROM STATE TO STATE IN THE U.S.A. SOME STATES OF THE U.S.A. DO NOT ALLOW LIMITATIONS ON HOW LONG AN IMPLIED WARRANTY LASTS, WHEN AN ACTION MAY BE BROUGHT, OR THE EXCLUSION OR LIMITATION OF INCIDENTAL OR CONSEQUENTIAL DAMAGES, SO THE ABOVE PROVISIONS MAY NOT APPLY TO YOU UNDER SUCH CIRCUMSTANCES.



**- IMPORTANT -  
CANADIAN WARRANTY INFORMATION  
GARANTIE CANADIENNE**

STANDARD WARRANTY  
TYPE OF SET

DVD Player  
DVD/VCR Combination  
Home Theatre in a Box  
DVD Recorder  
Portable DVD

GARANTIE NORMALE  
TYPE D'APPAREIL

Lecteur DVD  
DVD/magnétoscope combo  
Cinéma maison dans une boîte  
Enregistreur DVD  
DVD Portatif

WARRANTY PERIOD

12 MONTHS

DURÉE DE LA GARANTIE:

12 MOIS

**CANADIAN WARRANTY**

Toshiba of Canada Limited (TCL) makes the following limited warranties to original consumers in Canada. Please retain your "Bill of Sale" as proof of purchase. **To obtain a "Canadian Warranty" please register online at [www.toshiba.ca](http://www.toshiba.ca).**

**Canadian Warranty Information**

Should service be required on this unit during the one year warranty period, TCL's option will be to repair or exchange the defective unit. It will be necessary to follow this procedure:

**Contact:** Toshiba of Canada Limited at the Consumer Electronics Group, customer support line.

**Phone:** 1-800-268-3404

**Email:** [ceg\\_customer\\_support@toshiba.ca](mailto:ceg_customer_support@toshiba.ca)

All in-warranty repairs must be made by an authorized TCL service centre.

For service exchange TCL will arrange to have the unit picked up by courier and a replacement unit will be returned via same courier. (Note: A major credit card number will be required as a charge of \$25.00 will apply if no fault is found with the unit.) During the first 3 months of ownership, a new unit will be supplied as a replacement. During the remainder of the warranty period a service-renewed unit will be supplied.

The original "Bill of Sale" must be provided as proof of purchase (it will be returned with the replacement unit.)

**This 12-month warranty will be strictly adhered to.**

Out of warranty units should be repaired by a TCL authorized service centre.

Note: It is the responsibility of the owner to ensure proper packaging. Should damage in shipping occur, due to poor packaging, a charge back for the repair will result.

This warranty applies to the original purchaser only and is not transferable.

This warranty does not apply to sets that have been subjected to misuse, neglect, accident, physical damage or acts of nature.

Sets with the serial number removed, altered, replaced or defaced will not be covered by this warranty.

The warranties from TCL are effective only if the product is purchased in Canada from an authorized TCL dealer and operated in Canada.

Products utilized for rental or commercial purposes are not covered by this warranty.

This warranty is in lieu of all other warranties, guarantees or agreements, whether expressed or implied, and no person, agent distributor, dealer, service centre or company is authorized to change, modify or extend its terms in any manner whatsoever.

**GARANTIE CANADIENNE**

1) Toshiba du Canada Limitée (TCL) offre au Canada les garanties limitées suivantes aux consommateurs originaux. Veuillez conserver votre « facture » comme preuve d'achat. **Pour obtenir une garantie canadienne, veuillez vous inscrire en ligne à [www.toshiba.ca](http://www.toshiba.ca)**

**Information sur la garantie Canadienne**

Si vous avez besoin de service sur cet appareil au cours de l'année de garantie, Toshiba du Canada Limitée aura l'option de réparer ou échanger l'appareil défectueux. Vous devrez suivre la procédure suivante:

**Contact:** Toshiba du Canada Limitée au Groupe Électronique aux consommateurs, service à la clientèle.

**Tél:** 1-800-268-3404

**Courriel:** [ceg\\_customer\\_support@toshiba.ca](mailto:ceg_customer_support@toshiba.ca)

Toutes les réparations au cours de la garantie doivent être faites par un centre de service autorisé Toshiba.

Pour un échange TCL s'assurera qu'un service de courrier ramassera l'unité et qu'un appareil de remplacement soit expédié par le même service de courrier.

(Note: Un numéro de carte de crédit sera requis car une charge de 25,00\$ sera appliquée si toutefois l'appareil n'avait aucun problème de fonctionnement.)

Une nouvelle unité sera fournie comme remplacement durant les premiers 3 mois de propriété. Par contre durant la balance de la garantie une unité remise à neuf sera fournie.

La «facture» originale doit être fournie comme preuve d'achat (elle vous sera retournée avec l'unité de remplacement.)

**Cette garantie de 12 mois sera strictement adhéree.**

Les unités hors de garantie devraient être réparées par un centre de service autorisé Toshiba.

Note: C'est la responsabilité du propriétaire de s'assurer que l'emballage est adéquat. Vous serez facturé pour toutes réparations causées par des dommages encourus à cause d'un emballage non adéquat.

Cette garantie est octroyée à l'acheteur initial et n'est pas transférable. Cette garantie ne s'applique pas aux appareils qui ont été sujets aux abus, négligences, accidents, dommages physiques ou actes naturels.

Les appareils dont le numéro de série a été enlevé, altéré, remplacé ou barbouillé ne sont pas couverts par cette garantie.

Les garanties de TCL sont valides seulement sur les unités qui sont achetées et utilisées au Canada d'un marchand autorisé TCL.

Cette garantie ne couvre pas les produits de location ou à usage commercial. Cette garantie remplace toutes autres garanties ou ententes exprimées ou sous-entendues. Aucune personne, agent, distributeur, concessionnaire ou compagnie n'est autorisé à changer, modifier ou prolonger les termes de cette garantie de quelque façon que ce soit.

---

# Memo

Introduction

Recording

Playback

Editing

Function setup

**Others**