

# ***LCD Color TV***

---

Operating Instructions

**WEGA**

***KLVS15G10***

***KLVS20G10***

### **Owner's Record**

The model and serial numbers are located at the rear of the TV. Record these numbers in the spaces provided below. Refer to them whenever you call upon your Sony dealer regarding this product.

Model No. \_\_\_\_\_

Serial No. \_\_\_\_\_

### **Contacting Sony**

If, after reading these operating instructions, you have additional questions related to the use of your Sony TV, please call our Customer Information Services Center at 1-800-222-SONY (7669) (US residents only) or 1-877-899-SONY (7669) (Canadian residents only).

## WARNING

To reduce the risk of fire or electric shock, do not expose this apparatus to rain or moisture.



This symbol is intended to alert the user to the presence of uninsulated "dangerous voltage" within the product's enclosure that may be of sufficient magnitude to constitute a risk of electric shock to persons.



This symbol is intended to alert the user to the presence of important operating and maintenance (servicing) instructions in the literature accompanying the appliance.

## For Safety

The apparatus shall not be exposed to dripping or splashing and no objects filled with liquids, such as vases, shall be placed on the apparatus.

## CAUTION

To prevent electric shock, do not use this polarized AC plug with an extension cord, receptacle or other outlet unless the blades can be fully inserted to prevent blade exposure.

## Note on Caption Vision

This TV provides display of TV closed captioning in accordance with §15.119 of the FCC rules.

## NOTIFICATION

This equipment has been tested and found to comply with the limits for a Class B digital device, pursuant to part 15 of the FCC Rules. These limits are designed to provide reasonable protection against harmful interference in a residential installation. This equipment generates, uses and can radiate radio frequency energy and, if not installed and used in accordance with the instructions, may cause harmful interference to radio communications. However, there is no guarantee that interference will not occur in a particular installation. If this equipment does cause harmful interference to radio or television reception, which can be determined by turning the equipment off and on, the user is encouraged to try to correct the interference by one or more of the following measures:

- Reorient or relocate the receiving antenna.
- Increase the separation between the equipment and receiver.
- Connect the equipment into an outlet on a circuit different from that to which the receiver is connected.
- Consult the dealer or an experienced radio/TV technician for help.

You are cautioned that any changes or modifications not expressly approved in this manual could void your authority to operate this equipment.

## Safety

- Operate the TV only on 120 V AC.
- Use the AC power cord specified by Sony and suitable for the voltage where you use it.
- The plug is designed, for safety purposes, to fit into the wall outlet only one way. If you are unable to insert the plug fully into the outlet, contact your dealer.
- If any liquid or solid object should fall inside the cabinet, unplug the TV immediately and have it checked by qualified service personnel before operating it further.
- If you will not be using the TV for several days, disconnect the power by pulling the plug itself. Never pull on the cord.
- For details concerning safety precautions, see "Important Safety Instructions" on page 4 and "Important Safeguards" on page 5.

## Installing

- The TV should be installed near an easily accessible power outlet.
- To prevent internal heat buildup, do not block the ventilation openings.
- Do not install the TV in a hot or humid place, or in a place subject to excessive dust or mechanical vibration.
- Avoid operating the TV at temperatures below 5°C (41°F).
- If the TV is transported directly from a cold to a warm location, or if the room temperature changes suddenly, the picture may be blurred or show poor color due to moisture condensation. In this case, please wait a few hours to let the moisture evaporate before turning on the TV.
- To obtain the best picture, do not expose the screen to direct illumination or direct sunlight. It is recommended to use spot lighting directed down from the ceiling or to cover the windows that face the screen with opaque drapery. It is desirable to install the TV in a room where the floor and walls are not of a reflective material.

## CAUTION

Use the following Sony appliance only with the following WALL-MOUNT BRACKET.

Use with other WALL-MOUNT BRACKET may cause instability and possibly result in injury.

SONY APPLIANCE MODEL NO.  
KLV-S20G10

SONY WALL-MOUNT BRACKET MODEL NO.  
SU-WL11 (KLV-S20G10)

## To Customers

Sufficient expertise is required for installing the specified product. Be sure to subcontract the installation to Sony dealers or licensed contractors and pay adequate attention to safety during the installation.

(Continued)

## For Customers in the United States

This product contains mercury. Disposal of this product may be regulated if sold in the United States. For disposal or recycling information, please contact your local authorities or the Electronics Industries Alliance (<http://www.eiae.org>).

## To Sony Dealers

For installation of SONY WALL-MOUNT BRACKET, be sure to read and follow the instructions supplied with those optional products.

## Trademark Information

WOW, SRS and  symbol are trademarks of SRS Labs, Inc. WOW technology is incorporated under license from SRS Labs, Inc.

Licensed by BBE Sound, Inc. under USP4638258, 4482866. "BBE" and BBE symbol are trademarks of BBE Sound, Inc. BBE High Definition Sound is fully activated maximizing the sound effect in the WOW mode.

Wega, Steady Sound and CineMotion are registered trademarks of Sony Corporation.



"PlayStation" is a trademark of Sony Computer Entertainment, Inc.



As an ENERGY STAR® Partner, Sony Corporation has determined that this product meets the ENERGY STAR® guidelines for energy efficiency.

ENERGY STAR® is a U.S. registered mark.

## Important Safety Instructions

- 1) Read these instructions.
- 2) Keep these instructions.
- 3) Heed all warnings.
- 4) Follow all instructions.
- 5) Do not use this apparatus near water.
- 6) Clean only with dry cloth.
- 7) Do not block any ventilation openings. Install in accordance with the manufacturer's instructions.
- 8) Do not install near any heat sources such as radiators, heat registers, stoves, or other apparatus (including amplifiers) that produce heat. An icon showing a laptop computer on a stack of books, with wavy lines representing heat or fire emanating from the laptop.
- 9) Do not defeat the safety purpose of the polarized or grounding-type plug. A polarized plug has two blades with one wider than the other. A grounding type plug has two blades and a third grounding prong. The wide blade or the third prong are provided for your safety. If the provided plug does not fit into your outlet, consult an electrician for replacement of the obsolete outlet.
- 10) Protect the power cord from being walked on or pinched particularly at plugs, convenience receptacles, and the point where they exit from the apparatus.
- 11) Only use attachments/accessories specified by the manufacturer.
- 12) Use only with the cart, stand, tripod, bracket, or table specified by the manufacturer, or sold with the apparatus. When a cart is used, use caution when moving the cart/apparatus combination to avoid injury from tip-over. An icon showing a person pushing a cart with a large television set on it, with a warning symbol (a circle with a diagonal line) over the scene.
- 13) Unplug this apparatus during lightning storms or when unused for long periods of time.
- 14) Refer all servicing to qualified service personnel. Servicing is required when the apparatus has been damaged in any way, such as power-supply cord or plug is damaged, liquid has been spilled or objects have fallen into the apparatus, the apparatus has been exposed to rain or moisture, does not operate normally, or has been dropped.

# Important Safeguards

Before using your TV, please read these instructions completely, and keep this manual for future reference.

Carefully observe and comply with all warnings, cautions and instructions placed on the unit or described in the operating instructions or service manual.

## WARNING

To guard against injury, the following basic safety precautions should be observed in the installation, use and servicing of the unit.

## Use

### Power Sources

This unit should be operated only from the type of power source indicated on the information label.

If you are not sure of the type of electrical power supplied to your home, consult your dealer or local power company.



### Grounding or Polarization

This unit is equipped with a polarized AC power cord plug (a plug having one blade wider than the other), or with a three-wire grounding type plug (a plug having a third pin for grounding). Follow the instructions below:

### For the unit with a polarized AC power cord plug

This plug will fit into the power outlet only one way. This is a safety feature. If you are unable to insert the plug fully into the outlet, try reversing the plug.

If the plug still fails to fit, contact your electrician to have a suitable outlet installed. Do not defeat the safety purpose of the polarized plug by forcing it in.

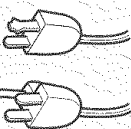

### Wall outlet

Do not use a poor fitting outlet.

Insert the plug fully into the outlet. If it is loose, it may cause arcing and result in fire.

Contact your electrician to have the outlet changed.

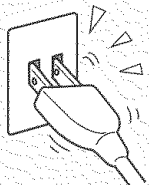

## Wiring

For your safety, unplug the AC power cord when wiring cables.

### Electric shock

Do not touch the AC power cord or the unit with a wet hand. If you plug/unplug the AC power cord from the unit with a wet hand, it may cause electric shock.

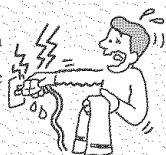

## Cleaning

- Clean the AC power plug regularly. If the plug is covered with dust and it picks up moisture, its insulation may deteriorate and result in fire. Unplug the AC power plug and clean it regularly.

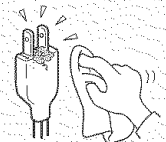

- Unplug the AC power cord when cleaning this unit. If not, it may result in electric shock.

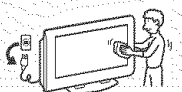

- Clean the cabinet of the TV with a dry soft cloth. To remove dust from the screen, wipe it gently with a soft cloth. Stubborn stains may be removed with a cloth slightly dampened with a solution of mild soap and warm water. Never use cloth or strong solvents such as thinner or benzine for cleaning.
- If using a chemically pretreated cloth, please follow the instruction provided on the package.
- If the picture becomes dark after using the TV for a long period of time, it may be necessary to clean the inside of the TV. Consult qualified service personnel.

## Overloading

Do not overload wall outlets, extension cords or convenience receptacles beyond their capacity, since this can result in fire or electric shock.



## Power

Always turn the unit off when it is not being used. When the unit is left unattended and unused for long periods of time, unplug it from the wall outlet as a precaution against the possibility of an internal malfunction that could create a fire hazard.



## Sound

If a snapping or popping sound from the TV is continuous or frequent while the TV is operating, unplug the TV and consult your dealer or service technician. It is normal for TV's to make occasional snapping or popping sounds, particularly when being turned on or off.

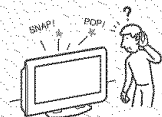

## AC Power Cord

If you damage the AC power cord, it may result in fire or electric shock.

- Do not pinch, bend, or twist the cord excessively. The core lines may be bared and cut, and cause short-circuit, resulting in fire or electric shock.
- Do not convert or damage the AC power cord.
- Do not put anything heavy on the AC power cord. Do not pull the AC power cord.
- Keep the AC power cord away from heat sources.
- Be sure to grasp the plug when disconnecting the AC power cord. If the AC power cord is damaged, stop using it and ask your dealer or Sony service center to exchange it.

## Batteries

Do not dispose of batteries in a fire.

Do not short circuit, disassemble or overheat the batteries.

## Disposal of used batteries

To preserve our environment, dispose of used batteries according to your local laws or regulations.

## Ventilation holes

Never push objects of any kind into the unit through the cabinet slots as they may touch dangerous voltage points or short out parts that could result in fire or electric shock. Never spill liquid of any kind on the unit.

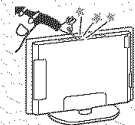

## Object and Liquid Entry

Do not place any objects on the unit.

The apparatus shall not be exposed to dripping or splashing and no objects filled with liquids, such as vases, shall be placed on the apparatus.

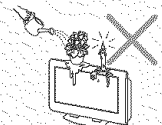

## Attachments

Do not use attachments which are not recommended by the manufacturer, as they may cause hazards.

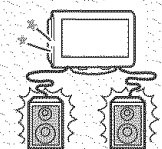

(Continued)

## Medical institution

Do not place this unit in a place where medical equipment is in use.

It may cause malfunction of medical instruments.

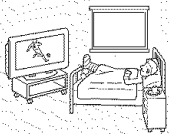

## Moisture and flammable objects

- Do not use plugged sets near water — for example, near a bathtub, washbowl, kitchen sink, or laundry tub, in a wet basement, or near a swimming pool, etc. It may result in fire or electric shock.
- Do not let this unit get wet. Never spill liquid of any kind on the unit. If any liquid or solid object does fall through, do not operate the unit. It may result in electric shock or damage to the unit. Have it checked immediately by qualified personnel.
- To prevent fire, keep flammable objects or open flame (e.g. candles) away from the unit.

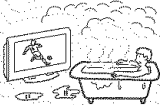

## Accessories

Use only accessories recommended by Sony for the specific model of TV. Do not place the unit on an unstable cart, stand, table or shelf. The unit may fall, causing serious injury to a child or an adult and serious damage to the unit. No part of the TV should overhang any edge of the TV cart or stand; any overhanging edge is a safety hazard. An appliance and cart combination should be moved with care. Quick stops, excessive force, and uneven surfaces may cause the appliance and cart combination to overturn.



## Broken pieces

Do not throw anything at the unit. The screen glass may break by the impact and cause serious injury.

## Cable wiring

Take care not to catch your feet on the cables. It may damage the unit.

## Heat

Do not touch the surface of the TV. It remains hot, even for some time after the TV is turned off.

## Volume adjustment

- Adjust the volume so as not to trouble your neighbors. Sound carries very easily at night time. Therefore, closing the windows or using headphones is suggested.
- When using headphones, adjust the volume so as to avoid excessive levels, as hearing damage may result.

## Disposal of the TV

- Do not dispose the TV with general household waste.
- The LCD contains a small amount of liquid crystal. The fluorescent tube used in this display contains mercury. Follow your local ordinances and regulations for disposal.

## Handling of broken glass and liquid crystal leakage

If the LCD panel gets damaged, crystalline liquid leakage may occur, or scattered broken glass may result. Do not touch broken glass or crystalline liquid (which is toxic), with bare hands as cuts or poisoning/skin irritation may occur. Also, do not let glass fragments or leaked crystalline liquid get into your eyes or mouth. Should either contact your eyes or mouth, rinse the contacted area thoroughly with water and consult your doctor.

## LCD screen

- Although the LCD screen is made with high-precision technology and has effective pixels of 99.99% or more, black dots may appear or bright points of light (red, blue, or green) may appear constantly on the LCD screen. This is a structural property of the LCD panel and is not a malfunction.
- Do not expose the LCD screen surface to the sun. Doing so may damage the screen surface.
- Do not push or scratch the LCD screen, or place objects on top of the TV. The image may be uneven or the LCD panel may be damaged.
- If the TV is used in a cold place, a smear may occur in the picture or the picture may become dark. This does not indicate a failure. These phenomena improve as the temperature rises.
- Ghosting may occur when still pictures are displayed continuously. It may disappear after a few moments.
- The screen and cabinet get warm when the TV is in use. This is not a malfunction.
- Avoid spraying insect repellent with volatile material to the screen.
- Avoid prolonged contact with rubber or plastic made material.

## Fluorescent lamp

This TV uses a special fluorescent lamp as its light source. If the screen image becomes dark, flickers, or does not appear, the fluorescent lamp has run down and should be replaced. For replacement, consult qualified service personnel.

## Installation

### Installation

- When installing or removing the TV on the wall, be sure to use qualified contractors. Wall mount installation requires the use of a wall-mount bracket. If the TV is installed or removed from the wall by a person other than a qualified contractor, the unit may fall and cause serious injury if the unit is not installed securely.
- To prevent injury, this apparatus must be securely attached to the stand/wall in accordance with the installation instructions.

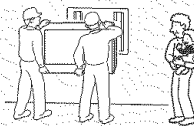

### Placement for viewing

It is recommended to watch the TV at a distance of 3 to 7 times that of the screen height, and in moderate brightness. Watching the TV for too long or in a dark room will cause eye fatigue.

### Optional accessories

Observe the following when installing the TV using a wall-mount bracket. If the TV is not secured properly, it may fall and cause injury.

- Be sure to follow the operating instructions supplied with the wall-mount bracket when installing the unit.
- Be sure to attach the brackets supplied with the wall-mount bracket.



### Protruding location

Do not install the TV in protruding locations. If you install the unit in the following locations, injury may result.

- Do not install the unit in a location where the unit protrudes, such as pillars.
- Do not install the unit in a location that may cause injury.

### Oils

Do not install this unit in restaurants where oily vapors occur. Dust absorbing oil may enter into the unit and damage the unit.

### Corrosion

Use of this TV near the seashore may subject the set to excessive salt, corrosion and internal damage and result in deterioration of the TV's performance. If the set will be subjected to these conditions, steps should be taken to reduce the humidity and temperature of the area where the TV is located.

## Ventilation

The slots and openings in the TV are provided for necessary ventilation. To ensure reliable operation of the unit, and to protect it from overheating, these slots and openings must never be blocked or covered.

Unless proper ventilation is provided, the unit may gather dust and get dirty. For proper ventilation, observe the following:

- Do not install the unit turned backward or sideways.
- Do not install the unit turned over or upside down.
- Never cover the slots and openings with a cloth or other materials.

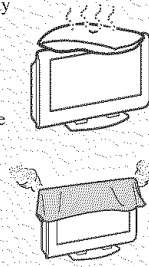

- Never block the slots and openings by placing the unit on a bed, sofa, rug or other similar surface.

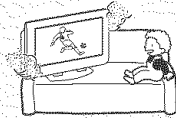

- Never place the unit in a confined space, such as a bookcase or built-in cabinet, unless proper ventilation is provided.

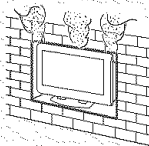

- Leave some space around the unit and the AC power adaptor. Otherwise, adequate air-circulation may be blocked causing overheating and cause fire or damage the unit.

When installing the unit on the wall, allow this much space.

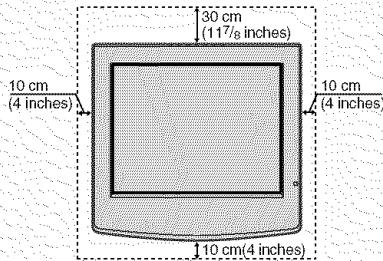

When installing the unit using a stand, allow this much space.

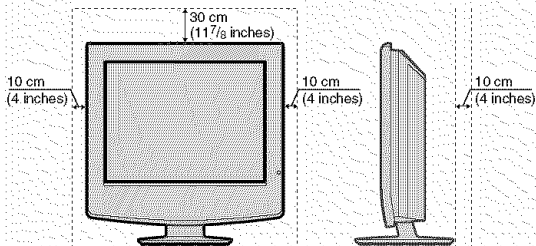

KLV-S15G10 only

When installing the AC power adaptor, allow this much space.

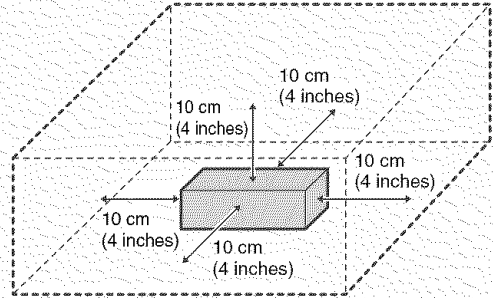

Never install the unit as follows:

Air circulation is blocked.

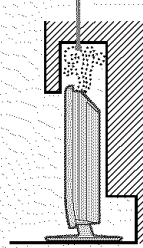

Air circulation is blocked.

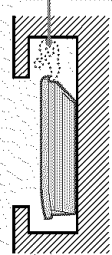

## Outdoor use

Do not install this unit outdoors. If the unit is exposed to rain, it may result in fire or electric shock. If the unit is exposed to direct sunlight, the unit may heat up and cause damage to the unit.

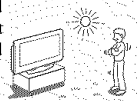

## Vehicle and ceiling

Do not install this unit in a vehicle or hung from the ceiling.

Bumping of the vehicle may cause the unit to fall down and cause injury.

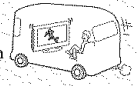

## Ship and vessel

Do not install this unit in a ship or vessel. If the unit is exposed to seawater, it may cause fire or damage the unit.

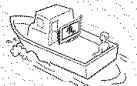

## Preventing the TV from toppling over

Take measures to prevent the unit from toppling over and causing injury. To prevent the unit from toppling over, secure the unit to the wall or pillar.

## Installing on a level surface

If you install the unit on a non-level surface, the unit may fall or drop and cause injury or damage.



(Continued)

## Placing on a stable surface

If you place the unit on an unstable surface, the unit may fall and cause injury or damage.

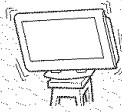

## Fall

Do not hang anything on the unit.

The unit may fall from the stand or wall-mount bracket, causing damage or serious injury.



## AC power cord

Unplug the AC power cord when moving the unit. Do not move the unit with the AC power cord plugged in. It may damage the AC power cord and result in fire or electric shock.

Do not allow anything to rest on or roll over the power cord, and do not place the unit where the power cord is subject to wear or abuse.

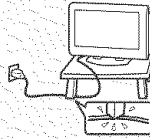

## Antennas

### Outdoor Antenna Grounding

If an outdoor antenna is installed, follow the precautions below. An outdoor antenna system should not be located in the vicinity of overhead power lines or other electric light or power circuits, or where it can come in contact with such power lines or circuits.

**WHEN INSTALLING AN OUTDOOR ANTENNA SYSTEM, EXTREME CARE SHOULD BE TAKEN TO KEEP FROM CONTACTING SUCH POWER LINES OR CIRCUITS AS CONTACT WITH THEM IS ALMOST INVARIABLY FATAL.**

Be sure the antenna system is grounded so as to provide some protection against voltage surges and built-up static charges.

Section 810 of the National Electrical Code (NEC) in USA and Section 54 of the Canadian Electrical Code in Canada provides information with respect to proper grounding of the mast and supporting structure, grounding of the lead-in wire to an antenna discharge unit, size of grounding conductors, location of antenna discharge unit, connection to grounding electrodes, and requirements for the grounding electrode.

### Antenna Grounding According to the National Electrical Code, ANSI/NFPA 70

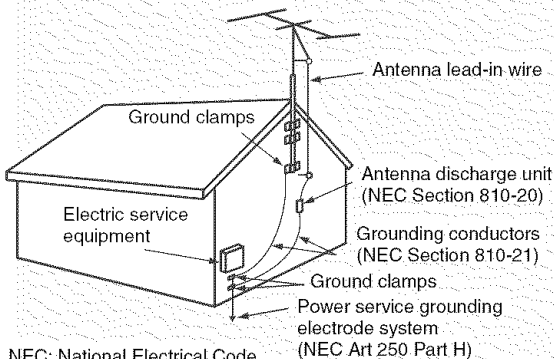





## Lightning

For added protection for this TV during a lightning storm, or when it is left unattended and unused for long periods of time, unplug it from the wall outlet and disconnect the antenna. This will prevent damage to the receiver due to lightning and power-line surges.

## Service

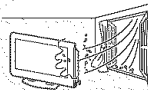
### Damage requiring service

Unplug the unit from the wall outlet and refer servicing to qualified service personnel under the following conditions:

- When the power cord or plug is damaged or frayed. 
- If liquid has been spilled into the unit.
- If the surface of the TV cracks, do not touch it, unplug the AC power cord.
- If the unit has been exposed to rain or water. 
- If the unit has been subjected to excessive shock by being dropped, or the cabinet has been damaged. 
- If the unit does not operate normally when following the operating instructions. Adjust only those controls that are specified in the operating instructions. Improper adjustment of other controls may result in damage and will often require extensive work by a qualified technician to restore the unit to normal operation. 
- When the unit exhibits a distinct change in performance, it indicates need for service. 

### Servicing

Do not attempt to service the unit yourself since opening the cabinet may expose you to dangerous voltages or other hazards. Refer all servicing to qualified service personnel.



### Replacement parts

When replacement parts are required, be sure the service technician certifies in writing that he/she has used replacement parts specified by the manufacturer that have the same characteristics as the original parts.

Unauthorized substitutions may result in fire, electric shock or other hazards.



### Safety check

Upon completion of any service or repairs to the unit, ask the service technician to perform routine safety checks (as specified by the manufacturer) to determine that the unit is in safe operating condition, and to so certify. Ask a qualified service technician to dispose of the unit.

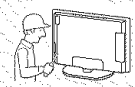



# Contents

## Introducing the TV

<b>Welcome</b> .....	<b>10</b>
Package Contents .....	10
Features .....	10
<b>Installing the TV</b> .....	<b>11</b>
Removing the rear cover .....	11
Attaching the rear cover .....	12
Attaching the VESA adaptor (KLV-S15G10 only) .....	13
Adjusting the Viewing Angle of the TV .....	14
<b>TV Controls and Connectors</b> .....	<b>15</b>
Front and Top Panel .....	15
Side Panel .....	16
Rear Panel .....	17

## Connecting the TV

Making Video and Audio Connections .....	19
<b>Basic Connections</b> .....	<b>20</b>
Cable System or VHF/UHF Antenna System .....	20
Cable Box/Digital Cable Box .....	20
Satellite Receiver and Cable/Antenna .....	21
HD Equipment .....	23
<b>Connecting Optional Equipment</b> .....	<b>25</b>
VCR, Cable and Antenna .....	25
DVD Player .....	28
Camcorder or "PlayStation" .....	30
<b>Setting Up the Channel List</b> .....	<b>31</b>
Using Initial Setup .....	31

## Watching the TV

<b>Button Descriptions</b> .....	<b>32</b>
<b>Programming the Remote Control</b> .....	<b>34</b>
<b>Using Other Equipment with Your Remote Control</b> .....	<b>36</b>
<b>Special Buttons on the Remote Control</b> .....	<b>37</b>
Using Favorite Channels .....	37
Using the Jump Function .....	38
Using the Freeze Function .....	38
Using the Sleep Function .....	39

## Using the Menus

<b>Overview of the Menus</b> .....	<b>40</b>
<b>Navigating through Menus</b> .....	<b>41</b>
<b>Using the Video Menu</b> .....	<b>42</b>
Selecting Video Options .....	42
<b>Using the Audio Menu</b> .....	<b>43</b>
Selecting Audio Options .....	43
<b>Using the Channel Menu</b> .....	<b>45</b>
Selecting Channel Options .....	45
<b>Using the Parent Menu</b> .....	<b>47</b>
Selecting Parent Options .....	47
US Models: Selecting Custom Rating Options .....	48
Viewing Blocked Programs .....	48
Canadian Models: Selecting Custom Rating Options .....	49
Viewing Blocked Programs .....	49
<b>Using the Setup Menu</b> .....	<b>50</b>
Selecting Setup Options .....	50

## Other Information

<b>Troubleshooting</b> .....	<b>53</b>
Trouble Symptoms and Remedies .....	53
<b>Contacting Sony</b> .....	<b>55</b>
<b>Specifications</b> .....	<b>56</b>
<b>Index</b> .....	<b>57</b>

# Introducing the TV

## Welcome

Thank you for purchasing this Sony LCD TV. This manual is for models KLV-S15G10 and KLV-S20G10.

---

## Package Contents

Along with your new TV, the packaging box contains a remote control, size AA batteries, 75-ohm coaxial cable (ferrite core attached), AC power cord, AC power adaptor (KLV-S15G10 only), VESA adaptor (bracket A and B) (KLV-S15G10 only), screws for bracket B (KLV-S15G10 only), Operating Instructions, Quick Setup Guide, Leaflet (Installing the Wall-Mount Bracket to the TV, KLV-S20G10 only) and warranty card. See page 56 for the quantity of each supplied accessory.

---

## Features

Some of the features that you will enjoy with your new TV include:

- CineMotion<sup>®</sup>**: Provides an optimized display by automatically detecting film content and applying a reverse 3:2 pulldown process. Moving pictures will appear clearer and more natural-looking.
- Favorite Channels**: Allows you to preview and select from 8 of your favorite channels.
- Steady Sound<sup>®</sup>**: Equalizes volume levels so there is consistent output between programs and commercials.
- Component Video Input**: Offers the best video quality for DVD (480p and 480i), and digital set-top box (480p and 480i) connections.
- Parental Control**: V-Chip technology allows parents to block unsuitable programming from younger viewers.
- Caption Vision/ Info Banner**: Allows Closed Caption and/or Channel Programming Information to be displayed.

## Installing the TV

### Removing the rear cover

Before connecting the TV, you need to remove the rear cover from the TV as illustrated below.

#### KLV-S15G10

- 1 Hold the stand of the TV.
- 2 Pull the rear cover down slowly, being careful not to catch your hand.

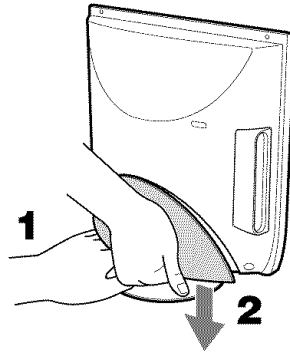

 The rear cover has tabs on the lower right and left sides. To remove the rear cover easily, grasp one side and pull out while stabilizing the other side with your other hand.

#### KLV-S20G10

- 1 Pull the rear cover out from the bottom.
- 2 Then, remove from the top.

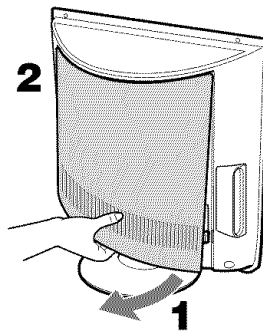

 Do not carry the TV holding the rear cover only as the rear cover is easily removed.

---

**Attaching the rear cover**

After connecting the cables, attach the rear cover to the TV as illustrated below.

- 1** Insert the two tabs of the upper side of the rear cover into the square holes of the TV.

KLV-S15G10

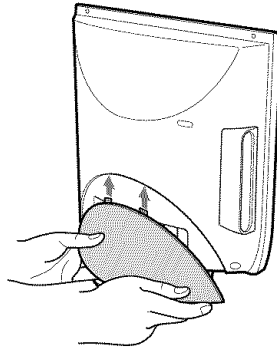

KLV-S20G10

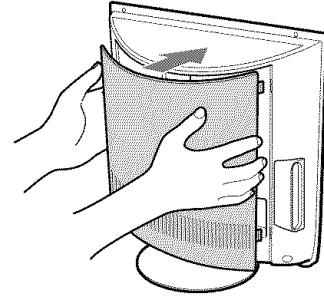

- 2** Push the two tabs of the lower side of the rear cover into the square holes of the TV.

KLV-S15G10

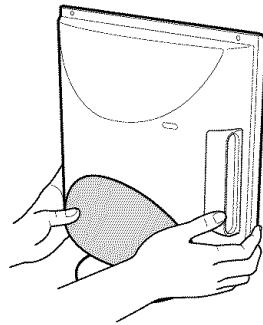

KLV-S20G10

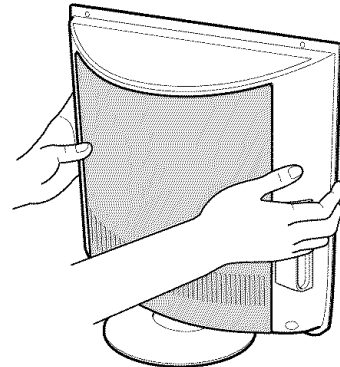

### Attaching the VESA adaptor (KLV-S15G10 only)

💡 Put soft cloth under the TV so as not to damage the LCD screen's surface.

If screw holes are required, attach the supplied VESA adaptor (brackets A and B) to the TV when you attach the TV to the FDMI (Flat Display Mount Interface) of VESA.

- 1 Remove the four screws illustrated below and remove the TV stand.

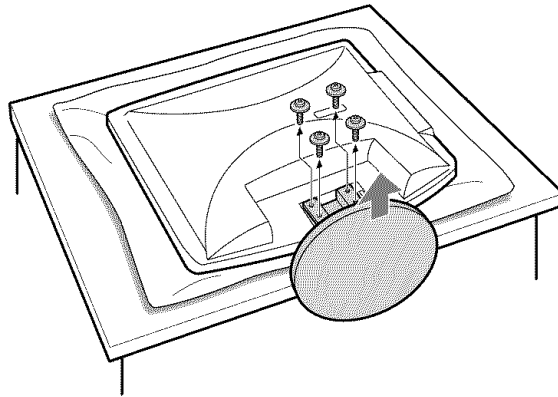

⚠️ If you put the TV and TV stand on the same level surface, it may affect stability and could present danger. Place the TV on a level surface as illustrated above.

⚠️ When removing the TV stand from the TV, firmly grasp the TV stand with both hands.

- 2 Attach bracket A (supplied) to the TV with four screws removed from the TV stand.

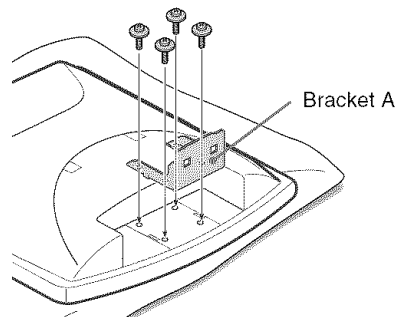

- 3 Put the tabs of bracket B (supplied) into the square holes of bracket A.
- 4 Slide bracket B towards the TV to fit the tabs into the square holes.

(Continued)

- 5 Screw bracket B to bracket A with two screws (supplied).

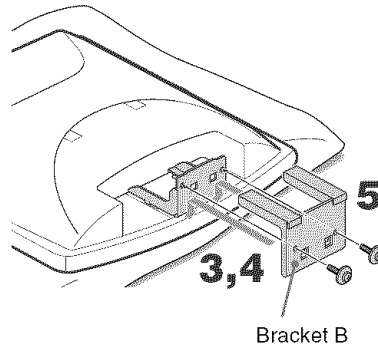

**Adjusting the Viewing Angle of the TV**

This TV can be adjusted within the angles shown below.

**Adjust the angle back and forth (tilt)**

**Adjust the angle left and right (swivel)**

Right view

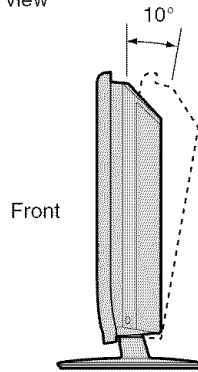

Top view

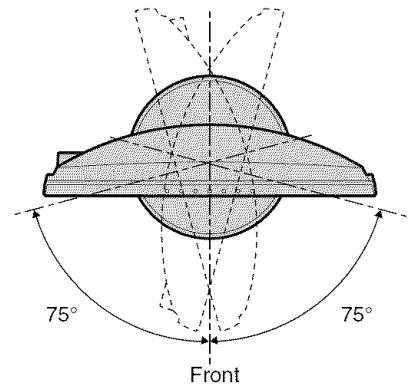

 **When adjusting the angle, hold the stand with one hand to avoid slipping or tipping the stand.**

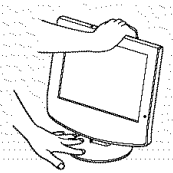

## TV Controls and Connectors

### Front and Top Panel

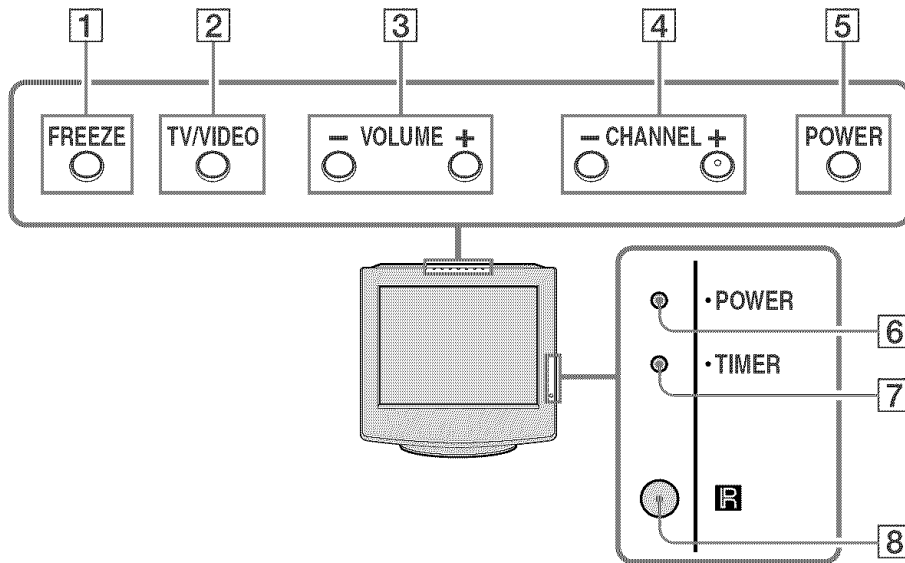

Item	Description
1	<b>FREEZE</b> Press to freeze the picture. The current program appears in the sub screen when freeze is selected. Press again to restore the picture. You can use this feature to write down information such as phone numbers, recipes, etc. For details, see page 38.
2	<b>TV/VIDEO</b> Press repeatedly to cycle through the video equipment connected to the TV's video inputs.
3	<b>- VOLUME +</b> Press to adjust the volume.
4	<b>- CHANNEL +</b> Press to scan through channels. To scan quickly through channels, press and hold down either CHANNEL.
5	<b>POWER</b> Press to turn on and off the TV.
6	<b>POWER LED</b> Lights up in green when the TV is turned on. The LED does not light up when the main power is turned off.
7	<b>TIMER LED</b> When lit, indicates the Sleep timer is set. For details, see page 39. If the LED blinks in red continuously, this may indicate the display unit needs servicing (see "Contacting Sony" on page 2).
8	<b>(IR) Infrared Receiver</b> Receives IR signals from the remote control.

 **The CHANNEL + button has a tactile dot. Use the tactile dot as a reference when operating the TV.**

**Side Panel**

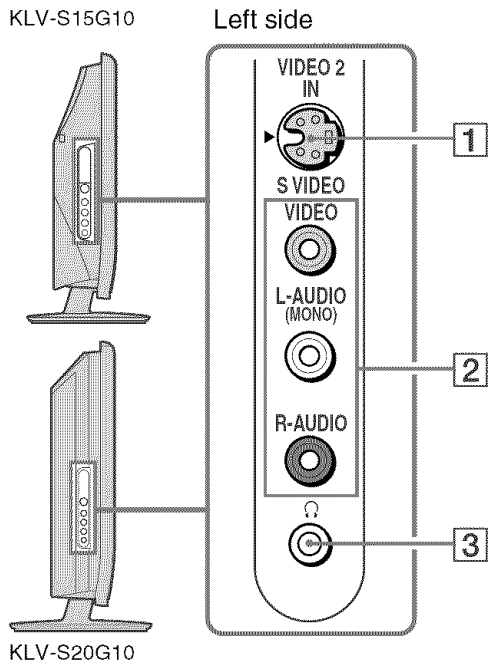

Jack	Description
<b>1</b> VIDEO 2 IN S VIDEO	Connects to the S VIDEO output jack on your camcorder or other video equipment that has S VIDEO. Provides better picture quality than composite video ( <b>2</b> ).
<b>2</b> VIDEO 2 IN VIDEO/ AUDIO L (MONO)/ AUDIO R	Connect to the composite video and audio output jacks on your camcorder or other video equipment.
<b>3</b> Headphones jack	Connects to your headphones. If your headphones do not match the jack, use a suitable plug adaptor (not supplied).



**Rear Panel**

KLV-S15G10

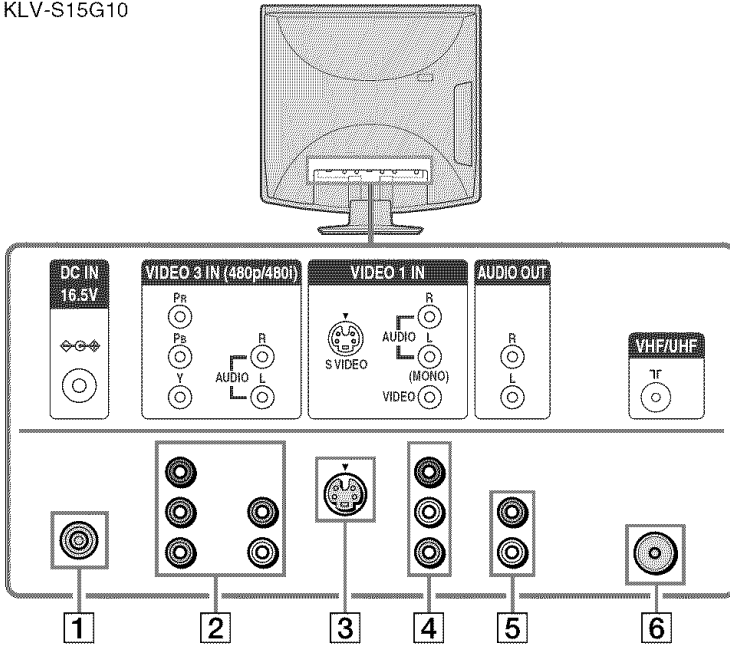

KLV-S20G10

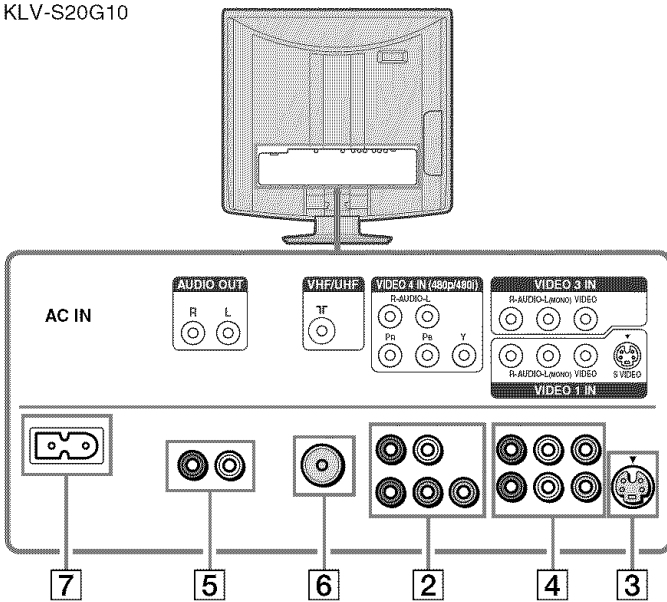

(Continued)

## Introducing the TV

Jack	Description
<b>1</b> DC IN (KLV-S15G10)	Connects the supplied AC power adaptor.
<b>2</b> VIDEO 3 IN (KLV-S15G10)/ VIDEO 4 IN (KLV-S20G10) (480p/480i)/ L-AUDIO-R	Connect to your DVD player's or digital set-top box's component video (YPbPr) and audio (L/R) jacks. Component video provides better picture quality than the S VIDEO ( <b>3</b> ) or the composite video ( <b>4</b> ) connections.
<b>3</b> VIDEO 1 IN/ S VIDEO	Connects to the S VIDEO output jack of your VCR or other video equipment that has S VIDEO. S VIDEO provides better picture quality than the composite video ( <b>4</b> ).
<b>4</b> VIDEO 1 IN/ VIDEO 3 IN (KLV-S20G10) VIDEO/ L(MONO)- AUDIO-R	Connect to the composite video and audio output jacks on your VCR or other video component. The other composite video and audio (VIDEO 2) is located on the left side panel of the TV.
<b>5</b> AUDIO OUT (L/R)	Connect to the left and right audio input jacks of your audio or video equipment. You can use these outputs to listen to your TV's audio through your stereo system.
<b>6</b> VHF/UHF	RF input that connects to your VHF/UHF antenna.
<b>7</b> AC IN (KLV-S20G10)	Connects the supplied AC power cord.

# Connecting the TV





To display clear crisp pictures, first you must connect your TV correctly and also need to choose the correct display format (see “16:9 Enhanced” in “Using the Setup Menu” on page 52). It is strongly recommended to connect the antenna using the supplied 75-ohm coaxial cable to receive optimum picture quality signal. A 300-ohm twin lead cable can be easily affected by radio noise and the like, resulting in signal deterioration. If you use a 300-ohm twin lead cable, keep it as far away as possible from the TV.

## Making Video and Audio Connections

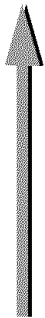
Your TV includes several types of video inputs. When connecting your TV, use the inputs that are available on your devices that provide the best video performance, as described below.

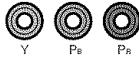
Best Video Performance



	Connector type	Separate audio connection required
	Component video (480i/480p)	Yes
	S VIDEO	
	Composite video	
	RF/Coaxial	No

 When you connect video equipment to both the VIDEO and the S VIDEO input jacks, make sure Auto YC in the Setup menu is set to On to view the S VIDEO input (see page 52).

## Basic Connections

### Cable System or VHF/UHF Antenna System

#### Cable or VHF only or VHF/UHF

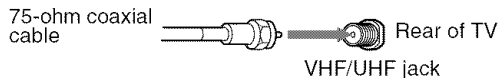

From the Channel menu, select Cable On or Cable Off for your type of input signal.

**Two ferrite cores are factory attached to the supplied 75-ohm coaxial cable. Do not detach the ferrite core from the coaxial cable.**

### Cable Box/Digital Cable Box

The supplied remote control can be programmed to operate your cable box (see "Programming the Remote Control" on page 34).

To change channels using the cable box, set your TV to channel 3 or 4 depending on the cable box channel output.

If you will be controlling all channel selection through your cable box, consider using the Channel Fix feature to set your TV to channel 3 or 4 (see page 45).

Use this hookup if:

- You subscribe to a cable TV system that uses scrambled or encoded signals requiring a cable box to view all channels, and
- You do not intend to hook up any other audio or video equipment to your TV.

- 1** Connect the coaxial connector from your cable service to the cable box's IN jack.
- 2** Using the supplied 75-ohm coaxial cable, connect the cable box's OUT jack to the TV's VHF/UHF jack.

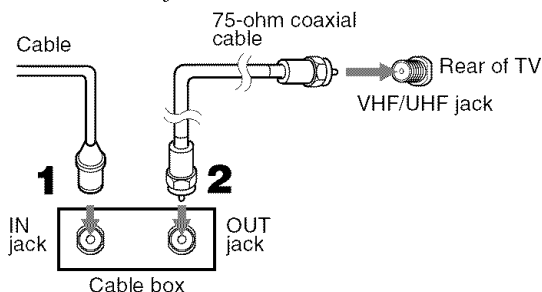

Also, set Cable to On in the Channel menu (see page 45).

### Notes on Using This Connection

To Do This ...	Do This ...
Use the cable box/digital cable box	Tune the TV to the channel the cable box is set to and then use the cable box to switch channels.
Set up the remote control to operate the cable box/digital cable box	Program the remote control. See "Programming the Remote Control" on page 34.
Activate the remote control to operate the cable box/digital cable box	Press SAT/CABLE (FUNCTION).
Control cable box/digital cable box functions with the remote control	See "Operating a Cable Box" on page 36.
Prevent the accidental switching of TV channels	When using the cable box, you need the TV to stay on the channel the cable box is set to. You can use the TV's Channel Fix feature to lock in a specific channel. For details, see "Using the Channel Menu" on page 45.

## Satellite Receiver and Cable/Antenna

💡 If you connect the Digital Satellite Receiver with component video cables, see page 23.

This scenario shows a SAT Box connected through the video inputs and the Cable/Antenna connected through the VHF/UHF input. Satellite signals are selected by the SAT Box through the video inputs while TV signal is selected by the TV tuner.

### To connect a satellite receiver

- 1 Connect the satellite antenna cable to the satellite receiver's satellite input jack.
- 2 Use A/V and S VIDEO cables to connect the satellite receiver's AUDIO and S VIDEO output jacks to the TV's AUDIO and S VIDEO input jacks (VIDEO 1 IN).
- 3 Connect the supplied 75-ohm coaxial cable from the antenna to the TV's VHF/UHF input jack.
- 4 Run the Initial Setup program, as described in "Setting Up the Channel List" on page 31.

🔗 If your satellite receiver is not equipped with S VIDEO, use a VIDEO cable (yellow) instead of the S VIDEO cable.

KLV-S15G10

Satellite Receiver

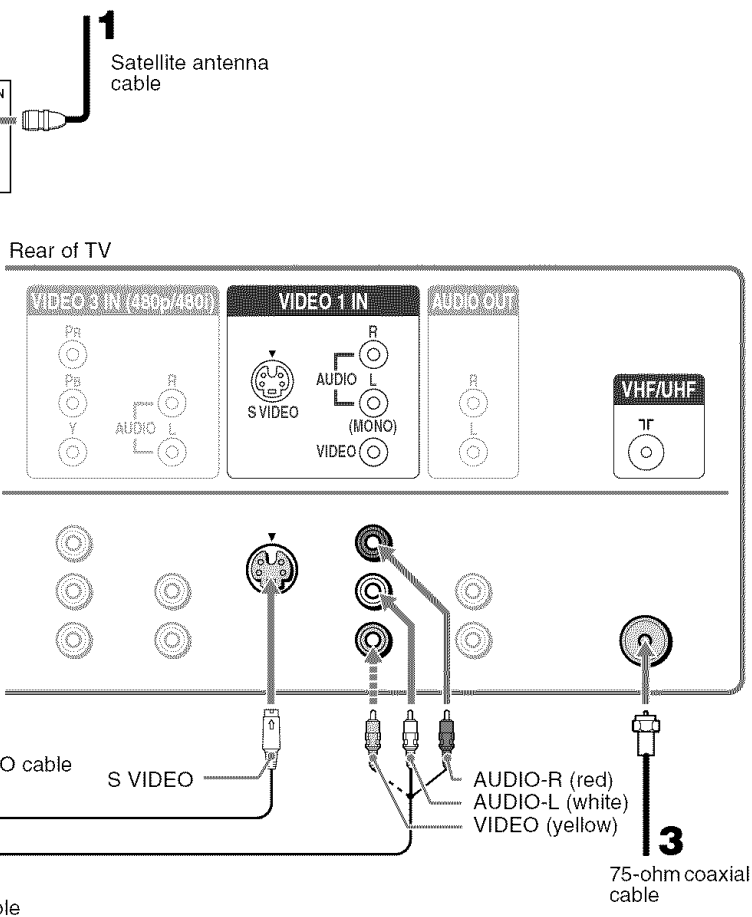

(Continued)

## Connecting the TV

KLV-S20G10

Satellite Receiver



**1** Satellite antenna cable

Rear of TV

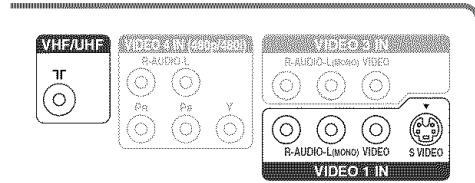

75-ohm coaxial cable

**3**

AUDIO-R (red)  
AUDIO-L (white)  
VIDEO (yellow)

S VIDEO

A/V cable

S VIDEO cable

### Notes on Using This Connection

To Do This ...	Do This ...
Watch the satellite receiver	Press TV/VIDEO repeatedly to select the satellite receiver input (Video 1, 2 or 3 for KLV-S20G10).
Set up the remote control to operate the satellite receiver	You must program the remote control. See "Programming the Remote Control" on page 34.
Activate the remote control to operate the satellite receiver	Press SAT/CABLE (FUNCTION).
Control satellite receiver functions with the remote control	See "Operating a Satellite Receiver" on page 36.
Label video inputs to easily identify equipment connected to the TV	See the instructions for setting up Label Video Inputs on page 51.

HD Equipment

Disconnect all power sources before making any connections.

- Using a component video cable, connect your equipment's YPBPR output jacks to the TV's YPBPR input jacks. Use the VIDEO 3 IN (KLV-S15G10) or VIDEO 4 IN (KLV-S20G10) connections.

**Component video (YPbPr) connection is necessary to view 480p formats. Note that this TV displays all format types of picture in a resolution of 640 dots × 480 lines.**

- Using an audio cable, connect your equipment's AUDIO output jacks to the TV's AUDIO input jacks.

**The YPBPR jacks do not provide audio, so audio cables must be connected to provide sound.**

KLV-S15G10

Rear of TV

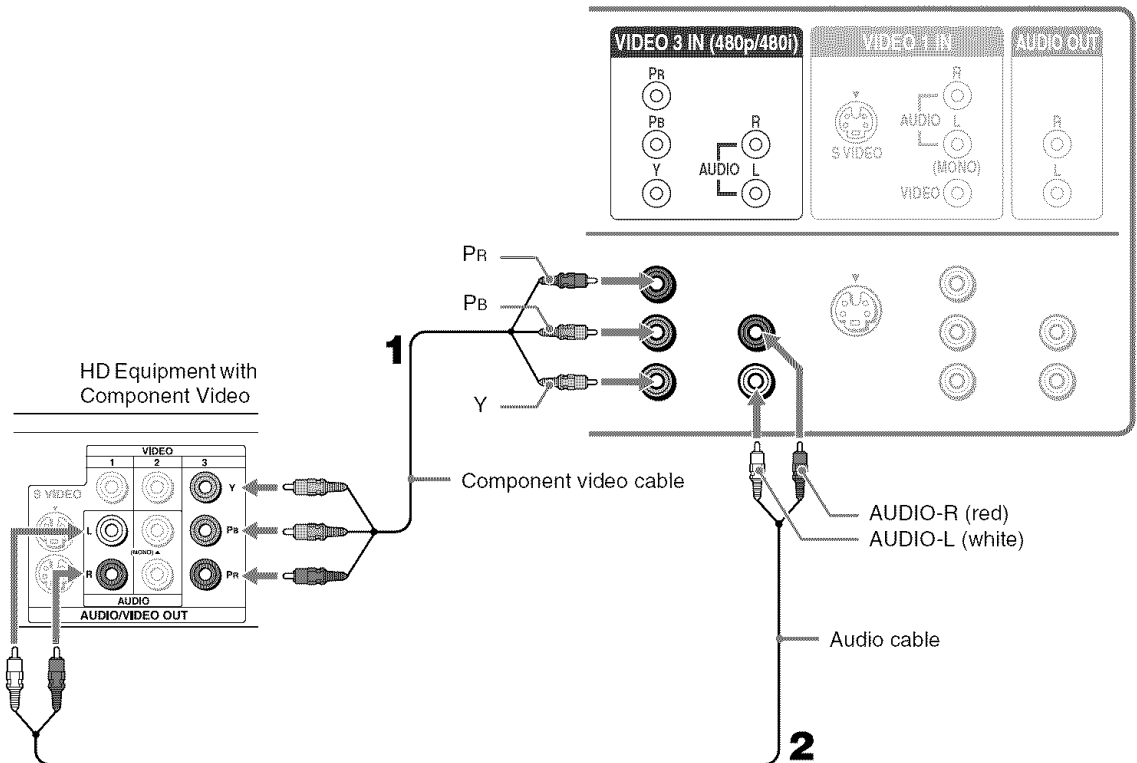



Connecting the TV

(Continued)

## Connecting the TV

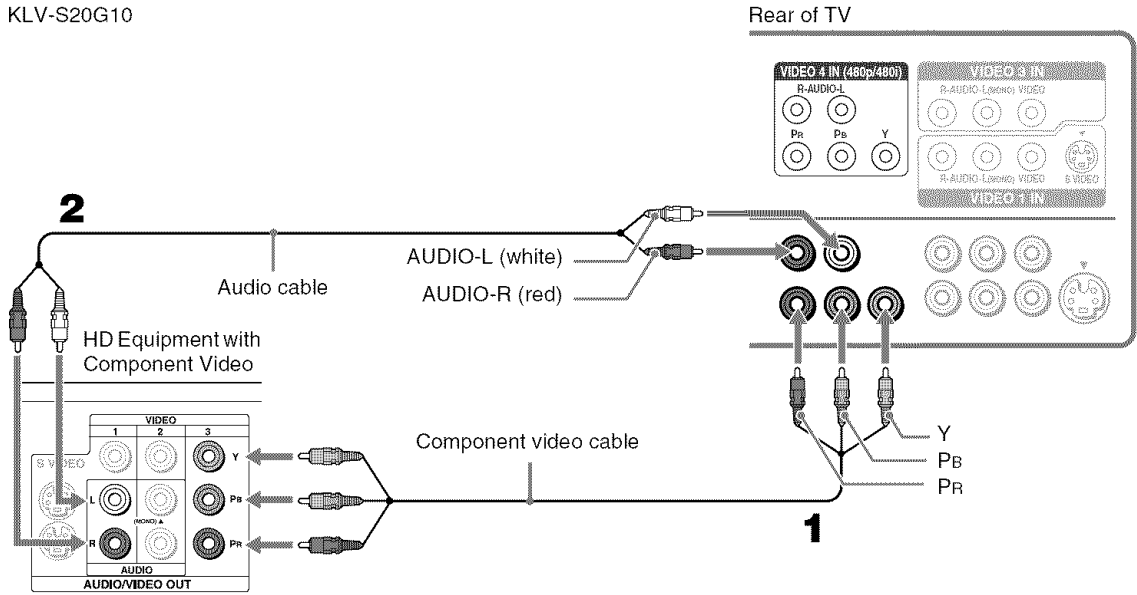
KLV-S20G10



 **Some of the HD equipment you can connect to receive the broadcasting signals are digital cable box, digital satellite receiver and digital TV receiver.**

### Notes on Using This Connection

To Do This ...	Do This ...
Watch the HD equipment	Press TV/VIDEO repeatedly to select the HD equipment input or Video 4. (For KLV-S15G10 model, select Video 3.)
Set up the remote control to operate the HD equipment	You must program the remote control. See "Programming the Remote Control" on page 34.
Activate the remote control to operate the HD equipment	Press SAT/CABLE (FUNCTION).
Control HD equipment functions with the remote control	See "Using Other Equipment with Your Remote Control" on page 36.
Label video inputs to easily identify equipment connected to the TV	See the instructions for setting up Label Video Inputs on page 51.



## Connecting Optional Equipment

You can connect a variety of optional equipment to your TV. This section provides some of the individual connections you can make. For multiple connections, please refer to the Quick Setup Guide.

### VCR, Cable and Antenna

 The most common setup is the Cable input into the VCR Antenna IN, the VCR Antenna Out to the VHF/UHF input.

This scenario shows a VCR with Cable signals connected through the video inputs and the Antenna connected through the VHF/UHF input. The Cable or VCR signals are selected by the VCR through the video inputs while TV signal is selected by the TV tuner.

#### To connect the VCR and cable

- 1** Connect the CATV cable to the VCR's VHF/UHF input jack.
- 2** Connect the supplied 75-ohm coaxial cable from the antenna to the TV's VHF/UHF input jack.
- 3** Use A/V and S VIDEO cables to connect the VCR's AUDIO and S VIDEO output jacks to the TV's AUDIO and S VIDEO input jacks (VIDEO 1 IN).
- 4** Run the Initial Setup Program, as described in "Setting Up the Channel List" on page 31.

 **If your VCR is not equipped with S VIDEO, use a VIDEO cable (yellow) instead of the S VIDEO cable.**

(Continued)

# Connecting the TV

KLV-S15G10

CATV cable

VCR



Rear of TV

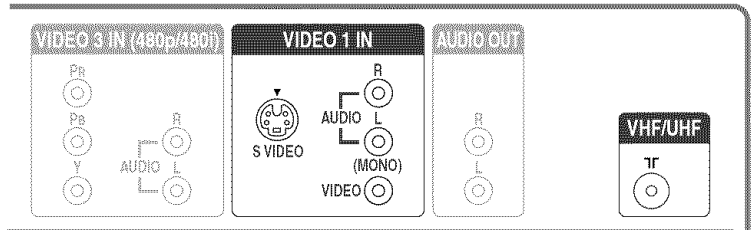

3

1

2

S VIDEO cable

S VIDEO

AUDIO-R (red)  
AUDIO-L (white)  
VIDEO (yellow)

75-ohm coaxial cable

A/V cable

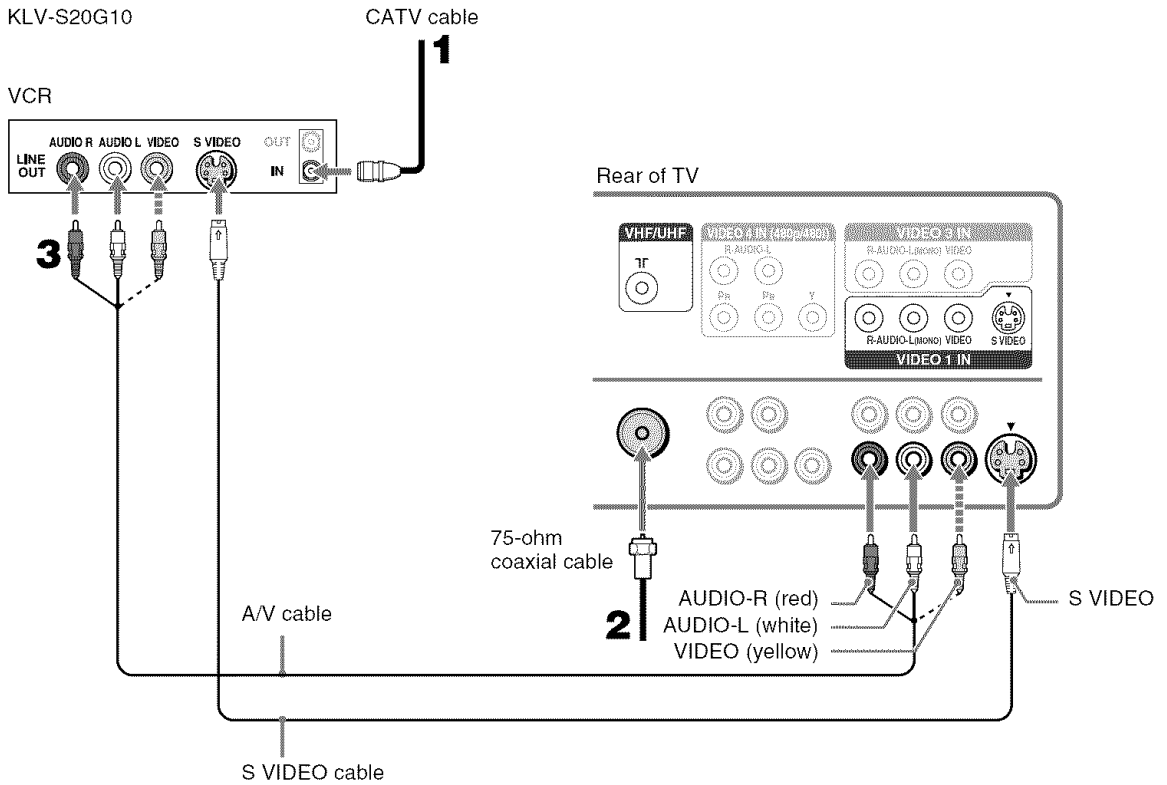



**Notes on Using This Connection**

To Do This ...	Do This ...
Watch the VCR	Press TV/VIDEO repeatedly to select the VCR input (Video 1, 2 or 3 for KLV-S20G10).
Watch cable channels	Press TV/VIDEO repeatedly to select the VCR input (Video 1, 2 or 3 for KLV-S20G10).
Set up the remote control to operate the VCR	You must program the remote control. See "Programming the Remote Control" on page 34.
Activate the remote control to operate the VCR	Press VCR/DVD (FUNCTION).
Control VCR functions with the remote control	See "Operating a VCR" on page 36.
Label video inputs to easily identify equipment connected to the TV	See the instructions for setting up Label Video Inputs on page 51.

## DVD Player

For best results, use this connection if your DVD player has component video (YPbPr) jacks.

### To connect a DVD player with component video connectors

- 1 Use a component video cable to connect the DVD player's YPbPr output jacks to the TV's YPbPr input jacks (VIDEO 3 IN (KLV-S15G10) or VIDEO 4 IN (KLV-S20G10)).  
 **The YPbPr jacks on your DVD player are sometimes labeled Y, CB and CR, or Y, B-Y and R-Y. If so, connect the cables to their matching color jacks.**
- 2 Use an audio cable to connect the DVD player's AUDIO output jacks to the TV's AUDIO input jacks (VIDEO 3 IN (KLV-S15G10) or VIDEO 4 IN (KLV-S20G10)).  
 **The YPbPr jacks do not provide audio, so audio cables must be connected to provide sound.**

KLV-S15G10

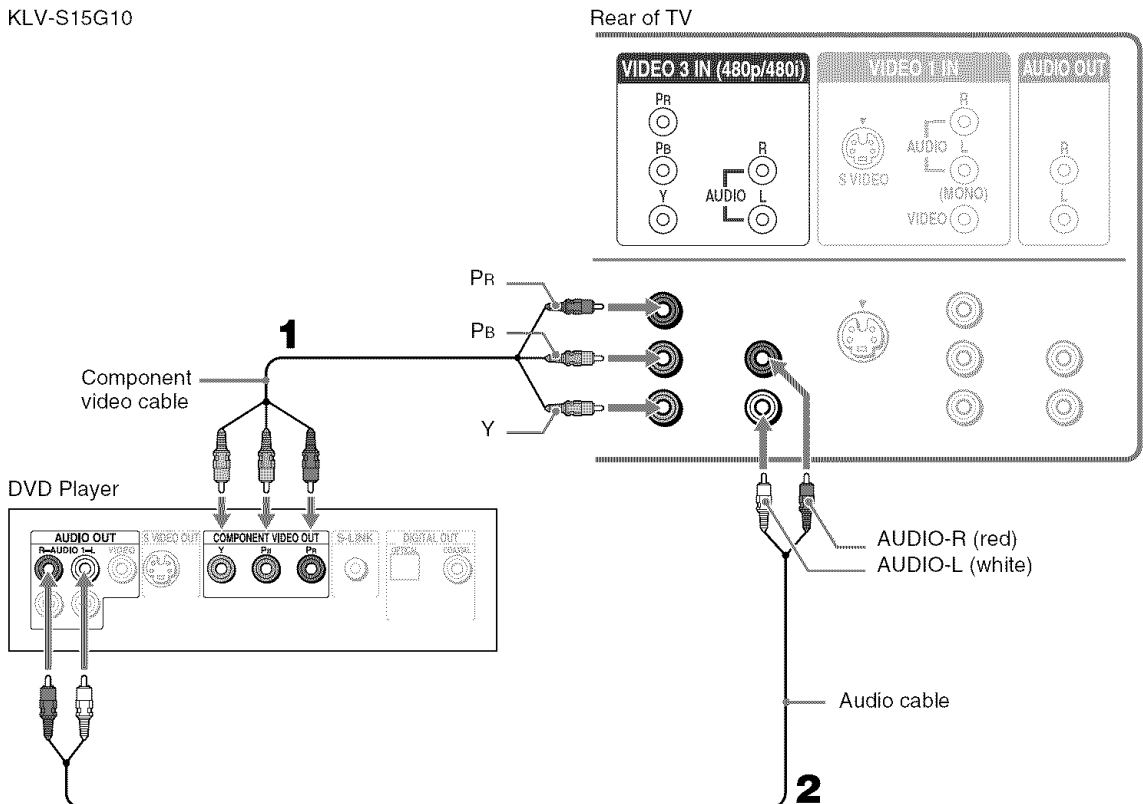

KLVS20G10

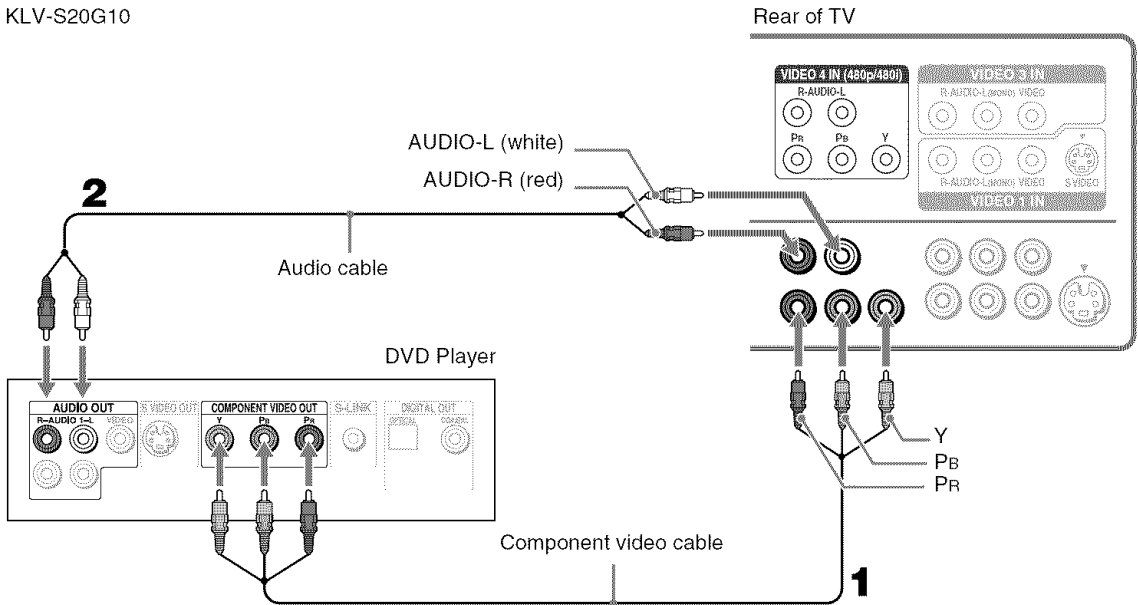

**Notes on Using This Connection**

To Do This ...	Do This ...
Watch the DVD player	Press TV/VIDEO repeatedly to select the DVD player input or Video 4. (For KLV-S15G10 model, select Video 3.)
Set up the remote control to operate the DVD player	If you have a non-Sony DVD player, you must program the remote control. See "Programming the Remote Control" on page 34.
Activate the remote control to operate the DVD player	Press VCR/DVD (FUNCTION).
Control DVD functions with the remote control	See "Operating a DVD Player" on page 36.
Label video inputs to easily identify equipment connected to the TV	See the instructions for setting up Label Video Inputs on page 51.

**To connect a DVD player with S VIDEO and audio connectors**

If your DVD player does not have component video (YPbPr) jacks, or the component video inputs are already connected to another device, use this connection.

- 1 Use an S VIDEO cable to connect the DVD player's S VIDEO output jack to the TV's S VIDEO input jack (VIDEO 1 IN).
- 2 Use an audio cable to connect the DVD player's AUDIO output jacks to the TV's AUDIO input jacks (VIDEO 1 IN).

**If your DVD player is not equipped with S VIDEO, use a VIDEO cable (yellow) instead of the S VIDEO cable.**

**Camcorder or  
"PlayStation"**

For easy connection to a camcorder or "PlayStation", the TV has left side A/V input jacks. If you prefer, you can connect the camcorder or "PlayStation" to the TV's rear A/V input jacks.

**To connect a camcorder or "PlayStation"**

Use A/V and S VIDEO cables to connect the camcorder or "PlayStation" AUDIO and S VIDEO output jacks to the TV's AUDIO and S VIDEO input jacks (VIDEO 2 IN) on the left side panel of the TV.

- ⚡ **If your camcorder is not equipped with S VIDEO, use a VIDEO cable (yellow) instead of the S VIDEO cable.**
- ⚡ **If you have a mono camcorder, connect its audio output jack to the TV's L AUDIO (MONO) input jack.**

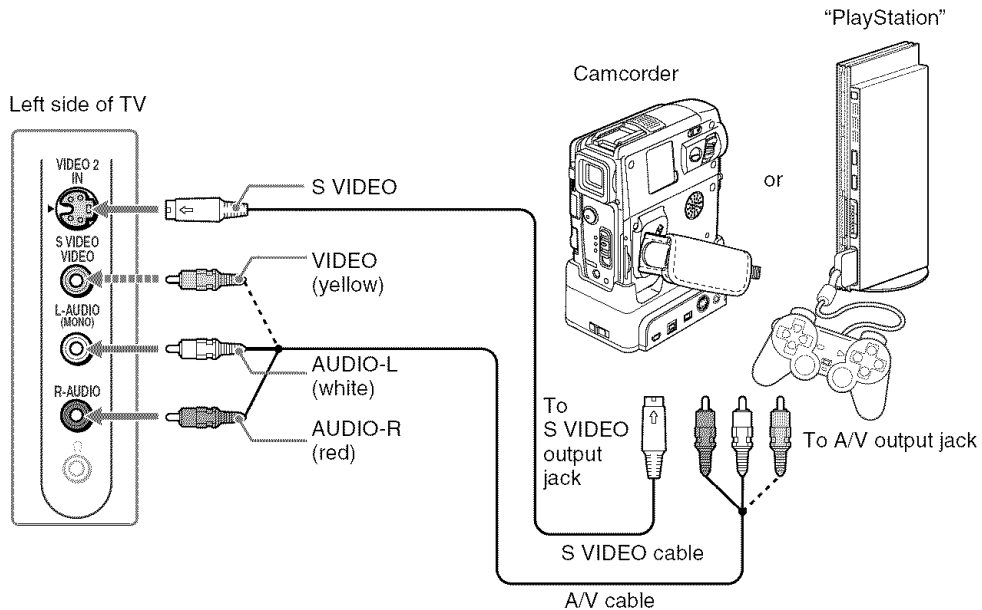



**Notes on Using This Connection**

To Do This ...	Do This ...
Watch the camcorder or "PlayStation"	Press TV/VIDEO repeatedly to select the camcorder or game input (Video 2).
Label video inputs to easily identify equipment connected to the TV	See the instructions for setting up Label Video Inputs on page 51.



## Setting Up the Channel List

After you finish connecting your TV, you need to run Initial Setup, which automatically sets up available channels. The Initial Setup screen appears when you turn on your TV for the first time after hooking it up. If you do not want to set up the channels at this time, you can do it later by selecting the Auto Program option in the Channel menu (see page 45).

-  **The Auto Program feature does not apply for installations that use a cable box.**
-  **The factory default setting for channel selection is Cable On. For antenna connections, run the Auto Program again after selecting Cable Off from the menu.**

### Using Initial Setup

#### To run Initial Setup the first time you turn on your TV

- 1** Press POWER to turn on the TV.  
The Initial Setup screen appears.
- 2** Press  or  on the remote control to select the on-screen display language. Then press .

The message “First please connect cable/antenna” appears.

-  **By default, Auto Program is set to scan cable TV channels.**

- 3** Press CH + to start Auto Program.

Auto Program automatically creates a list of receivable channels. When finished, the lowest numbered channel is displayed. When all the receivable channels are stored, the Show/Hide Channels menu appears.

#### To scan available VHF/UHF antenna channels instead of the cable TV channels

- 1** Press MENU, then go to Channel menu.
- 2** Set Cable to Off.
- 3** Start Auto Program by pressing .

To perform Auto Program again, follow the above instructions. Depending on your signal source, be sure to set Cable to On or Off accordingly (see page 45).

-  **The Initial Setup menu will appear each time the TV is turned on until you complete the scanning for the available channels.**

# Watching the TV



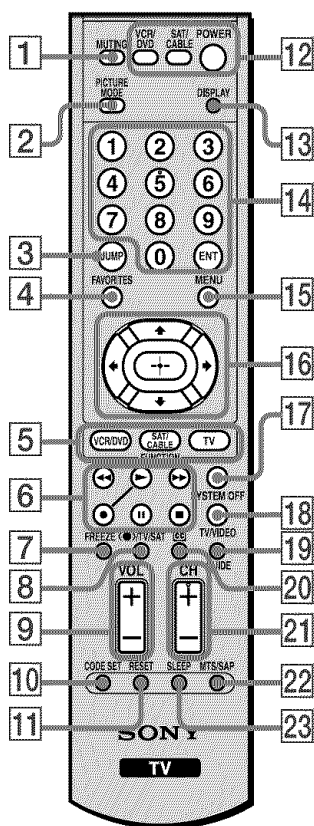



## Button Descriptions



 The 5 button, CH + button and MTS/SAP button have a tactile dot. Use the tactile dot as a reference when operating the TV.

Button	Description
<b>1</b> MUTING	Press to mute the sound. Press again or press VOL + to restore the sound.
<b>2</b> PICTURE MODE	Press repeatedly to cycle through the available video picture modes: Vivid, Standard, Pro. The video picture modes can also be accessed in the Video menu. See “Selecting Video Options” on page 42.
<b>3</b> JUMP	Press to jump back and forth between two channels. The TV alternates between the current channel and the last channel that was selected.
<b>4</b> FAVORITES	Press to display the Favorite Channels list. See “Using Favorite Channels” on page 37.
<b>5</b> FUNCTION Buttons	Press to have the remote control operate the equipment you want. See “Programming the Remote Control” on page 34.
<b>6</b> VCR/DVD Operating Buttons	When FUNCTION is switched on VCR/DVD, these buttons operate the video equipment you have programmed into the remote control. See “Using Other Equipment with Your Remote Control” on page 36.
	◀◀ Rewind
	▶▶ Play
	▶▶▶ Fast forward
	● Record (by pressing ● and ▶)
	▯▯ Pause
	■ Stop
<b>7</b> FREEZE	Press to freeze the picture. The current program appears in the sub screen when freeze is selected. Press again to restore the picture. You can use this feature to write down information such as phone numbers, recipes, etc. See “Using the Freeze Function” on page 38. The Freeze function may not be available in some cases.
<b>8</b> 	Press to select the sound effect modes: SRS WOW and Off. The sound effect modes can also be accessed in the Audio menu. See “Selecting Audio Options” on page 43.
	TV/SAT
<b>9</b> VOL +/-	Press to adjust the volume.
<b>10</b> CODE SET	Press to program the remote control to operate non-Sony video equipment. See “Programming the Remote Control” on page 34.



Button	Description
11 RESET	Press to reset the settings to the factory default settings. See pages 42 and 43.
12 POWER	Press to turn on and off the TV.
SAT/CABLE	Press to turn on and off the satellite receiver and cable box you have programmed into the remote control. See “Programming the Remote Control” on page 34.
VCR/DVD	Press to turn on and off the video equipment (VCR or DVD player) you have programmed into the remote control. See “Programming the Remote Control” on page 34.
13 DISPLAY	Press once to display the current channel number, channel label and time. The OSD (on screen display) will be canceled after a few seconds or press again to immediately cancel the display.
14 0 - 9 ENT	Press 0 - 9 to select a channel; the channel changes after 2 seconds. Press ENT to change channels immediately.
15 MENU	Press to display the Menu. Press again to exit from the Menu. See “Using the Menus” on page 40.
16  	Press  to move the on-screen cursor. To select an item, press  .
17 SYSTEM OFF	Press to turn off the TV and all other Sony equipment.
18 TV/VIDEO	Press repeatedly to cycle through the video equipment connected to the TV’s video inputs.  See page 51 on setting up the video input labels, including skip function.
19 GUIDE	Press to display the program guide of your satellite program provider.
20  (Closed Caption)	Press repeatedly to cycle through the Caption Vision: Off, CC1 - CC4, Text1 - Text4. The Caption Vision can also be accessed in the Setup menu. See “Selecting Setup Options” on page 50.
21 CH +/-	Press to scan through channels. To scan quickly through channels, press and hold down either CH + or CH -.
22 MTS/SAP	Press repeatedly to cycle through the Multi-channel TV Sound (MTS) options: Stereo, Auto SAP (Second Audio Program), and Mono. The MTS setting can also be accessed in the Audio menu. See “Selecting Audio Options” on page 43.
23 SLEEP	Press repeatedly until the TV displays the time in minutes (15, 30, 45, 60 or 90) that you want the TV to remain on before shutting off. To cancel Sleep Timer, press SLEEP repeatedly until Sleep Off appears.

 **TV/SAT and GUIDE buttons are functional when the SAT/CABLE function button is selected.**

## Programming the Remote Control

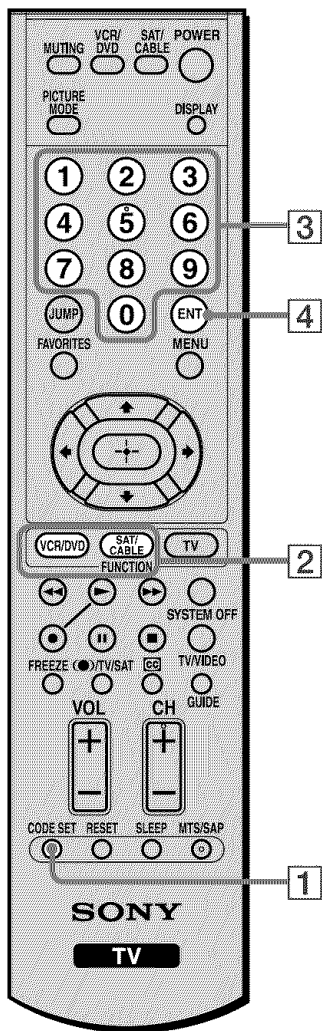

The remote control is preset to operate Sony brand video equipment.

Sony Equipment	Programmable Code Number
VCR/DVD	301 (Sony VCR)
SAT/CABLE	801 (Sony Satellite Receiver)

Follow the steps below to program your TV's remote control to operate non-Sony video equipment.

**The equipment must have infrared (IR) remote capability in order to be used with this remote control.**

Find the three-digit code for your equipment from the "Manufacturer's Codes" listed on page 35. If more than one code number is listed, try entering from the code listed first.

- 1** Press CODE SET.
- 2** Press the **VCR/DVD** or **SAT/CABLE** FUNCTION button you want to program on the remote control.  
The selected FUNCTION button (VCR/DVD or SAT/CABLE) will flash.
- 3** Enter the three-digit manufacturer's code number using the **0-9** buttons while the button is lit (approximately 10 seconds).
- 4** Press **ENT** button.

When the programming is correct, the selected FUNCTION button will flash twice slowly, and when not, flashes five times quickly.

### **1** To check if the code works

Aim your TV's remote control at the equipment, and press the VCR/DVD and/or SAT/CABLE (POWER) button that corresponds with the equipment. If the equipment responds, the programming is completed. If not, try the next code listed.

Insert two size AA batteries (supplied) by matching the **+** and **-** on the batteries to the diagram inside the remote control's battery compartment.

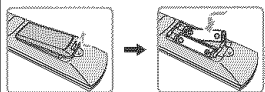

- If you enter a new code number, the code number you previously entered at that setting is erased.**
- If no code is input within the above specified time, or an invalid or incorrect code number is input, the remote control automatically goes back to the previous setting.**
- In some cases, you may not be able to program your remote control to operate other equipment. In such cases, use the equipment's own remote control.**
- Dead batteries or removing the batteries may cause the programmable codes to be lost and revert back to factory settings. Reprogramming the codes may be necessary.**

**Manufacturer's Codes**

**VCRs**

<i>Manufacturer</i>	<i>Code</i>
Sony	301, 302, 303, 348
Admiral (M. Ward)	327
Aiwa *	338, 344
Audio Dynamic	314, 337
Broksonic	319, 317
Canon	309, 308
Citizen	332
Craig	302, 332
Criterion	315
Curtis Mathes	304, 338, 309
Daewoo	341, 312, 309
DBX	314, 336, 337
Dimensia	304
Emerson	319, 320, 316, 317, 318, 341
Fisher	330, 335
Funai	338
General Electric	329, 304, 309
Go Video	322, 339, 340
Goldstar	332
Hitachi	306, 304, 305, 338
Instant Replay	309, 308
JC Penney	309, 305, 304, 330, 314, 336, 337
JVC	314, 336, 337, 345, 346, 347
Kenwood	314, 336, 332, 337
LXI (Sears)	332, 305, 330, 335, 338
LG	332
Magnavox	308, 309, 310
Marantz	314, 336, 337
Marta	332
Memorex	309, 335
Minolta	305, 304
Mitsubishi/MGA	323, 324, 325, 326
Multitech	325, 338, 321
NEC	314, 336, 337
Olympic	309, 308
Optimus	327
Panasonic	308, 309, 306, 307
Pentax	305, 304
Philco	308, 309
Philips	308, 309, 310
Pioneer	308
Quasar	308, 309, 306

<i>Manufacturer</i>	<i>Code</i>
RCA/PROSCAN	304, 305, 308, 309, 311, 312, 313, 310, 329
Realistic	309, 330, 328, 335, 324, 338
Sansui	314
Samsung	322, 313, 321
Sanyo	330, 335
Scott	312, 313, 321, 335, 323, 324, 325, 326
Sharp	327, 328
Shintom	315
Signature 2000 (M. Ward)	338, 327
SV2000	338
Sylvania	308, 309, 338, 310
Symphonic	338
Tashiro	332
Tatung	314, 336, 337
Teac	314, 336, 338, 337
Technics	309, 308
Toshiba	312, 311
Wards	327, 328, 335, 331, 332
Yamaha	314, 330, 336, 337
Zenith	331

**DVD Players**

<i>Manufacturer</i>	<i>Code</i>
Sony	751
Panasonic	753
Pioneer	752
RCA	755
Toshiba	754

**Cable Boxes**

<i>Manufacturer</i>	<i>Code</i>
Sony	230
Hamlin/Regal	222, 223, 224, 225, 226
Jerrold/G. I./Motorola	201, 202, 203, 204, 205, 206, 207, 208, 218
Oak	227, 228, 229
Panasonic	219, 220, 221
Pioneer	214, 215
Scientific Atlanta	209, 210, 211
Tocom	216, 217
Zenith	212, 213

**Satellite Receivers**

<i>Manufacturer</i>	<i>Code</i>
Sony	801
General Electric	802
Hitachi	805
Hughes	804
Panasonic	803
RCA/PROSCAN	802, 808
Toshiba	806, 807

\* If an Aiwa VCR does not work even though you enter the code for Aiwa, enter the code for Sony instead.

## Using Other Equipment with Your Remote Control

To operate other connected equipment with your TV, first turn to page 35 and program the necessary code. For operating video equipment, press TV/VIDEO repeatedly until you see the video input on the screen for your connected equipment. Remote control operation tips are provided below.

 **Some functions cannot be operated depending on the equipment. In that case, use the remote control supplied with the equipment.**

### Operating a VCR

To Do This ...	Press ...
Turn on/off	VCR/DVD (POWER)
Control a VCR	VCR/DVD (FUNCTION)
Change channels	CH +/-
Record	▶ while pressing ●
Play	▶
Stop	■

To Do This ...	Press ...
Fast forward	▶▶
Rewind	◀◀
Pause	(press again to resume normal playback)
Search the picture forward or backward	▶▶ or ◀◀ during playback (release to resume normal playback)

### Operating a DVD Player

To Do This ...	Press ...
Turn on/off	VCR/DVD (POWER)
Control a DVD player	VCR/DVD (FUNCTION)
Play	▶
Stop	■
Pause	(press again to resume normal playback)

To Do This ...	Press ...
Step through different tracks of an audio disc	▶▶ to step forward or ◀◀ to step backward
Step through different chapters of a video disc	CH + to step forward or CH - to step backward
Select a track directly	0-9 buttons
Display the menu (Setup)	MENU
Operate the DVD menu	▲, ▼, ◀, ▶, (◂)

### Operating a Cable Box

To Do This ...	Press ...
Turn on/off	SAT/CABLE (POWER)
Control a cable box	SAT/CABLE (FUNCTION)

To Do This ...	Press ...
Select a channel	0-9 buttons, ENT (enter)
Change channels	CH +/-
Go to the previous channel	JUMP

### Operating a Satellite Receiver

To Do This ...	Press ...
Turn on/off	SAT/CABLE (POWER)
Control a satellite receiver	SAT/CABLE (FUNCTION)
Select a channel	0-9 buttons, ENT (enter)
Change channels	CH +/-
Go to the previous channel	JUMP

To Do This ...	Press ...
Display the channel number	DISPLAY
Display the DBS guide	GUIDE
Display the DBS menu	MENU
Move the highlight (cursor)	▲, ▼, ◀, ▶
Select the item	(◂)

## Special Buttons on the Remote Control

### Using Favorite Channels

The Favorite Channels feature lets you select programs from a list of up to 8 favorite channels that you specify. You can create a list using the Add to Favorites option.

- 1 Press FAVORITES.

The Favorite Channels list appears. Make your selection.

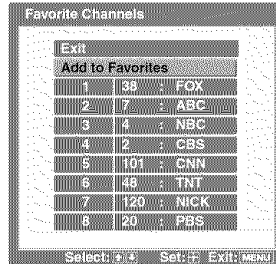

- 2 Press **↑/↓** to highlight the desired channel and press **+**.
  - To add the current channel to the list of Favorite Channels, highlight Add to Favorites and press **+**.
  - When the Favorite Channels list is full, remove a channel from your list using Favorite Channels in the Channel menu and try again (see page 45).

---

### Using the Jump Function

You can change or jump between the last two channels.

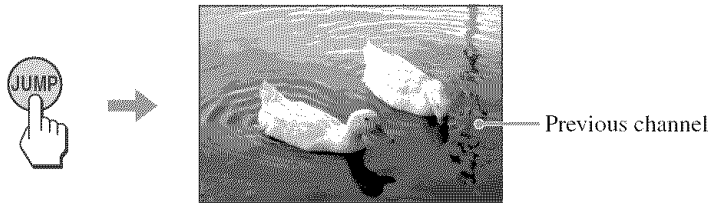

---

### Using the Freeze Function

💡 While the picture is frozen, the sound continues to be output normally.

You can use this feature to write down information such as phone numbers, recipes, etc. When you press the button once, the current screen is frozen and the sub screen appears. When you press the button twice, only the frozen screen is displayed, when you press it a third time, the normal screen returns.

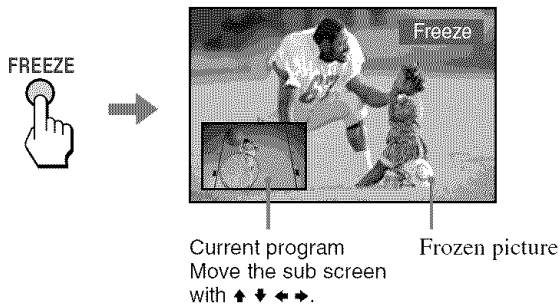

#### To cancel the Freeze function mode

Press FREEZE until the normal screen appears.

⚠ **The Freeze function may not be available in some cases.**

## Using the Sleep Function

- 💡 If you turn the TV off, and then turn it on again, the Sleep timer returns to Sleep Off.
- 💡 “TV will turn off soon” appears one minute before the TV shuts off. This message may not appear if you are performing other operations in the menu.

You can set the TV to turn off automatically after a predetermined period of time (15, 30, 45, 60, or 90 minutes).

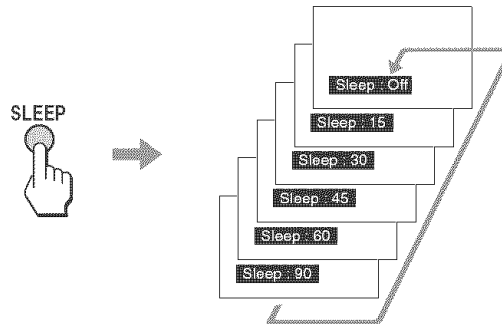

While the Sleep timer is activated, the TIMER LED on the TV lights up in red.

### To cancel the Sleep timer

Press SLEEP repeatedly until Sleep Off appears or turn the TV off then turn the TV on again.

# Using the Menus

## Overview of the Menus

The Menus provide you access to the following features:

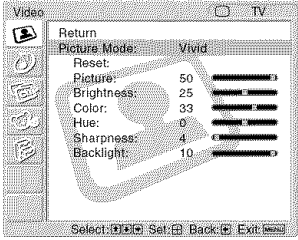
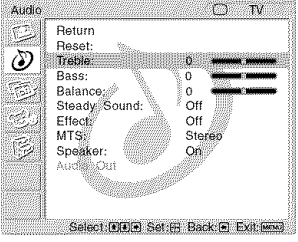
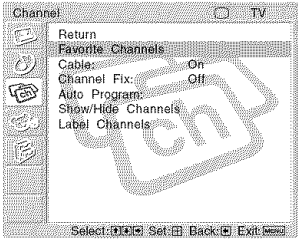
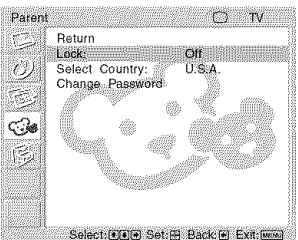
Menu	Allows you to set/change
<b>Video</b> 	<ul style="list-style-type: none"><li>Picture Mode (page 42)</li><li>Reset (page 42)</li><li>Picture (page 42)</li><li>Brightness (page 42)</li><li>Color (page 42)</li><li>Hue (page 42)</li><li>Sharpness (page 42)</li><li>Backlight (page 42)</li></ul>
<b>Audio</b> 	<ul style="list-style-type: none"><li>Reset (page 43)</li><li>Treble (page 43)</li><li>Bass (page 43)</li><li>Balance (page 43)</li><li>Steady Sound (page 43)</li><li>Effect (page 43)</li><li>MTS (page 43)</li><li>Speaker (page 44)</li><li>Audio Out (page 44)</li></ul>
<b>Channel</b> 	<ul style="list-style-type: none"><li>Favorite Channels (page 45)</li><li>Cable (page 45)</li><li>Channel Fix (page 45)</li><li>Auto Program (page 45)</li><li>Show/Hide Channels (page 46)</li><li>Label Channels (page 46)</li></ul>
<b>Parent</b> 	<ul style="list-style-type: none"><li>Lock (page 47)</li><li>Select Country (page 47)</li><li>Change Password (page 47)</li></ul>

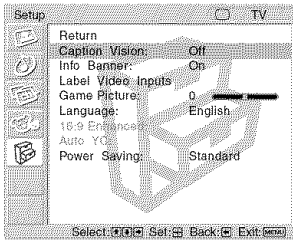

**Menu***Allows you to set/change***Setup**

Caption Vision (page 50)  
 Info Banner (page 50)  
 Label Video Inputs (page 51)  
 Game Picture (page 51)  
 Language (page 51)  
 16:9 Enhanced (page 52)  
 Auto YC (page 52)  
 Power Saving (page 52)

## Navigating through Menus

 Menus include navigation help text that appears at the bottom of each Menu.

<b>To Do This ...</b>	<b>Press ...</b>
Display the Menu	Press MENU.
Move through the Menu	Press <b>▲ ▼</b> .
Move through the Menu options	Press <b>▲ ▼</b> .
Select an option to change	Press <b>(+)</b> .
Change an option's setting	Press <b>▲ ▼ ◀ ▶</b> .
Select (confirm) changed setting	Press <b>(+)</b> .
Exit the Menu	Press MENU.

## Using the Video Menu

To select the Video menu

1. Press MENU
2. Highlight Video
3. Press to select

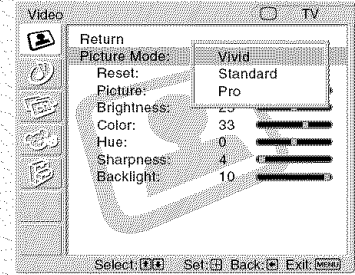

To exit the Video menu, press MENU.

To restore the factory default settings for the Video menu

- Press RESET on the remote control when in the Video menu.

## Selecting Video Options

- 💡 To change from one Picture Mode to another, press PICTURE MODE on the remote control.
- 💡 You can alter the Picture Mode options (Vivid, Standard, Pro) for each video input (including the TV antenna input).
- 💡 You can alter the Video settings (Picture, Brightness, Color, etc.) for each Mode.

The Video menu includes the following options:

To highlight an option and to change settings, press **↑ ↓ ← →**.

Press **+** to confirm the selection.

Option	Description
Picture Mode	Vivid
<i>Customized picture viewing</i>	Standard
	Pro
Reset	Reset all settings and adjustments to the default setting for each Picture Mode (Vivid, Standard, Pro) (except for the options grayed out).
Picture	Adjust to increase picture contrast or decrease picture contrast.
Brightness	Adjust to brighten or darken the picture.
Color	Adjust to increase or decrease color intensity.
Hue	Adjust to increase or decrease the green tones.
Sharpness	Adjust to sharpen or soften the picture.
Backlight	Adjust to brighten or darken the backlight.

## Using the Audio Menu

### To select the Audio menu

1. Press MENU
2. Highlight Audio
3. Press to select

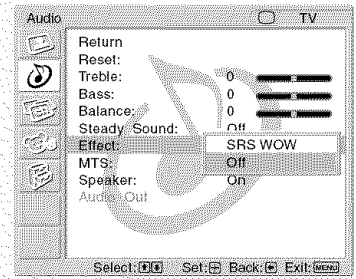

To exit the Audio menu, press MENU.

### To restore the factory settings for Treble, Bass, and Balance

- Press RESET on the remote control when in the Audio menu.

## Selecting Audio Options

- 💡 Treble, Bass and Balance are adjustable when the Audio Out option is set to Variable.
- 💡 To change from one Effect option to another, use (●) on the remote control.
- 💡 To change from one MTS option to another, use MTS/SAP on the remote control.
- 💡 MTS is not available when Video or Component input is selected.

The Audio menu includes the following options:

To highlight an option and to change settings, press **↑ ↓ ← →**.

Press **(+)** to confirm the selection.

Option	Description
Reset	Reset the following settings; Treble, Bass and Balance to the default setting.
Treble	Adjust to increase or decrease higher-pitched sounds.
Bass	Adjust to increase or decrease lower-pitched sounds.
Balance	Adjust to emphasize left or right speaker balance.
Steady Sound	Auto Select to stabilize the volume.
	Off Select to turn off Steady Sound.
Effect	SRS WOW Provides a panoramic stereo audio image by producing deep and rich bass tones and clear treble tones, enabling you to enjoy powerful sound effects like those in a movie theater.
	Off Select for normal stereo or mono reception.
	Stereo Select for stereo reception when viewing a program broadcast in stereo.
MTS <i>Enjoy stereo, bilingual and mono programs</i>	Auto SAP Select to automatically switch the TV to second audio programs when a signal is received. If no SAP signal is present, the TV remains in Stereo mode.
	Mono Select for mono reception. Use to reduce noise during weak stereo broadcasts.

(Continued)

## Using the Menus

🔊 Headphones are off when Speaker option is set to Off.

🔊 Variable in Audio Out is available only when the Speaker option is set to Off.

<i>Option</i>	<i>Description</i>	
Speaker	On	Select to turn on the TV speakers.
	Off	Select to turn off the TV speakers and listen to the TV's sound only through your external audio receiver and speakers.
Audio Out <i>Easy control of volume adjustments</i>	Variable	The TV's speakers are turned off, and the audio output from your audio system can still be controlled with the TV's remote control.
	Fixed	The TV's speakers are turned off and the audio output of the TV is fixed. Use your audio receiver's remote control to adjust the volume (and other audio settings) through your audio system.

## Using the Channel Menu

To select the Channel menu

1. Press MENU
2. Highlight Channel
3. Press  to select





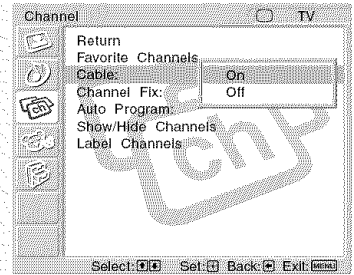

To exit the Channel menu, press MENU.











## Selecting Channel Options

- 💡 You can access the Favorite Channels list using FAVORITES on the remote control.

The Channel menu includes the following options:

To highlight an option and to change settings, press    .

Press  to confirm the selection.

Option	Description
Favorite Channels	Lets you set up a list of up to 8 of your favorite channels. <ol style="list-style-type: none"> <li>1 Press  to select Program.</li> <li>2 Press / to highlight a Favorite Channel number (1-8), then press  to select it.</li> <li>3 Press / to scroll through the channels until you find the channel that you would like to edit and then press  to select it.</li> <li>4 To select other Favorite Channel numbers, repeat steps 2-3.</li> <li>5 Press  to return to the Channel menu, or press MENU to exit the menu screen.</li> </ol>
Cable	<p>On Select if you are receiving cable channels with a CATV cable.</p> <p>Off Select if you are using an antenna.</p> <p> <b>You should run Auto Program after changing the cable setting.</b></p>
Channel Fix <i>Useful when you have a cable box or a satellite receiver connected</i>	<p>Off Turns off Channel Fix.</p> <p>2-6 Select one of these channels if something is connected to the VHF/UHF jack.</p> <p>Video 1, 4 (Video 3 for KLV-S15G10) Use this setting if you have connected the equipment to the A/V input jacks.</p>
Auto Program	Automatically sets up the channel list on the TV for all receivable channels.

(Continued)

## Using the Menus

 Channels that you set to be hidden can be accessed only with the 0-9 buttons.

Option	Description
Show/Hide Channels	<p>Allows you to show or hide channels that appear when you use the CH +/- buttons.</p> <ol style="list-style-type: none"><li>1 Press <b>▲/▼</b> to scroll through the channels until you find the channel you want to show or hide. Then press <b>(+)</b> to select it.</li><li>2 Press <b>▲/▼</b> to determine if the channel will be shown or hidden.</li><li>3 To show or hide more channels, repeat steps 1-2.</li><li>4 Press <b>←</b> to return to the Channel menu, or press <b>MENU</b> to exit the menu screen.</li></ol>
Label Channels	<p>Allows you to assign labels (such as station call letters) to channel numbers.</p> <ol style="list-style-type: none"><li>1 Press <b>▲/▼</b> to scroll through the channel numbers. Then press <b>(+)</b> to select the channel number that you want to assign a label.</li><li>2 Press <b>▲ ▼ ◀ ▶</b> to highlight Label and press <b>(+)</b>.</li><li>3 Press <b>▲/▼</b> to scroll through the label characters (A-Z, 0-9, etc.). Then press <b>(+)</b> to select the highlighted character. Repeat to add up to 5 characters to the label.</li><li>4 To assign labels to more channels, repeat steps 1-3.</li><li>5 Press <b>←</b> to return to the Channel menu, or press <b>MENU</b> to exit the menu screen.</li></ol>

## Using the Parent Menu

The Parent menu allows you to set up the TV to block programs according to their content and rating levels.

### To select the Parent menu

1. Press MENU
2. Highlight Parent
3. Press  to select



Use 0-9 on the remote control to enter a four-digit password.

The first time you create a password, confirm the password by entering it again. The Parent menu options appear.

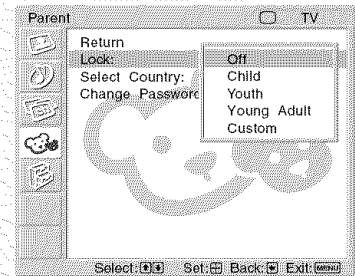

To exit the Parent menu, press MENU.

 **You need your password for any future access into the Parent menu. If you lose your password, see “Lost password.” on page 55.**

## Selecting Parent Options

 If you are not familiar with the Parental Guideline rating system, you should select Child, Youth, or Young Adult to help simplify the rating selection. To set more specific ratings, select Custom.

 For descriptions of Child, Youth, and Young Adult ratings, see page 48.

The Parent menu includes the following options:

To change settings, press    .

Press  to confirm the selection.

Option	Description	
Lock	Off	Parental lock is off. No programs are blocked from viewing.
<i>Turn ratings on/off and select a rating system</i>	Child	Maximum ratings permitted are: <input type="checkbox"/> US: TV-Y, TV-G, G <input type="checkbox"/> Canada: C, G, TV-Y, TV-G
	Youth	Maximum ratings permitted are: <input type="checkbox"/> US: TV-PG, PG <input type="checkbox"/> Canada: C8+, PG, 8 ans+, TV-PG
	Young Adult	Maximum ratings permitted are: <input type="checkbox"/> US: TV-14, PG-13 <input type="checkbox"/> Canada: 14+, 13 ans+, TV-14
	Custom	Select to set ratings manually. <input type="checkbox"/> US: See page 48 for details. <input type="checkbox"/> Canada: See page 49 for details.
Select Country	U.S.A.	Select to use USA ratings (see page 48).
	Canada	Select to use Canadian ratings (see page 49).
Change Password		For changing your password.

**US Models:  
Selecting Custom  
Rating Options**

💡 The Content-Based Ratings are linked to the level of the Age-Based Rating. For example, a program with an Age-Based Rating of TV-PG V (Violence) rating may contain moderate violence, while a TV-14 V (Violence) rating may contain more intense violence.

💡 To ensure maximum blocking capability, set the Age-Based Ratings.

💡 If you block unrated TV programs, be aware that the following types of programs may be blocked: programs broadcast from another country, emergency broadcasts, political programs, sports, news, public service announcements, religious programs and weather.

For US models, the Custom Rating menu includes the following options. For Canadian models, see page 49.

Option	Description	
Movie Rating	G All children and General Audience.	
	PG Parental Guidance suggested.	
	PG-13 Parental Guidance for children under 13.	
	R Restricted viewing, parental guidance is suggested for children under 17.	
	NC-17 and X No one 17 or under allowed.	
TV Rating <i>Block programs by their rating, content or both</i>	Age-Based Ratings	
	TV-Y All children.	
	TV-Y7 Directed to children age 7 and older.	
	TV-G General Audience.	
	TV-PG Parental Guidance suggested.	
	TV-14 Parents Strongly cautioned.	
	TV-MA Mature Audience only.	
	Content-Based Ratings	
	FV Fantasy Violence.	
	D Suggestive Dialog.	
L Strong Language.		
S Sexual situations.		
V Violence.		
Unrated <i>Block programs or movies that are broadcast without a rating</i>	Allow Allows programs and movies that are broadcast without a rating.	
	Block Blocks all programs and movies that are broadcast without a rating.	

**Viewing Blocked Programs**

You can view blocked programs by entering the password. Press ENT when tuned to a blocked program, then enter the password. This temporarily switches off Parent. To reactivate the Parent settings, turn off the TV. When the TV is turned on again, your Parent settings are reactivated.



---

### **Canadian Models: Selecting Custom Rating Options**

For Canadian models, the Custom Rating menu includes the following options. For US models, see page 48.

<i>Option</i>	<i>Description</i>	
English Rating	C	All children.
	C8+	Children 8 years and older.
	G	General programming.
	PG	Parental Guidance.
	14+	Viewers 14 and older.
	18+	Adult programming.
French Rating	G	General programming.
	8 ans+	Not recommended for young children.
	13 ans+	Not recommended for ages under 13.
	16 ans+	Not recommended for ages under 16.
	18 ans+	Programming restricted to adults.
U.S.A. Rating	See "US Models" on page 48 for details.	

---

### **Viewing Blocked Programs**

You can view blocked programs by entering the password. Press ENT when tuned to a blocked program, then enter the password. This temporarily switches off Parent. To reactivate the Parent settings, turn off the TV. When the TV is turned on again, your Parent settings are reactivated.

## Using the Setup Menu

To select the Setup menu

1. Press MENU
2. Highlight Setup
3. Press  to select





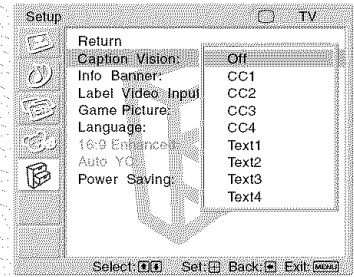

To exit the Setup menu, press MENU.



### Selecting Setup Options

To change from one Caption Vision option to another, use **CC** on the remote control.

The Setup menu includes the following options:

To highlight an option and to change settings, press    .

Press  to confirm the selection.

Option	Description
Caption Vision	Allows you to select from several closed caption modes (for programs that are broadcast with closed caption).
Off	Caption Vision is turned off.
CC1, CC2, CC3, CC4	Displays a printed version of the dialog or sound effects of a program. (Should be set to CC1 for most programs.)
Text1, Text2, Text3, Text4	Displays network/station information presented using either half or the whole screen (if available).
Info Banner	Set to On or Off. When on, displays the program name (if the broadcaster offers this service). Displays for up to four seconds when the channel is changed or the DISPLAY button is pressed.

Option	Description
Label Video Inputs	<p>Allows you to identify A/V equipment you connected to the TV, such as a VCR, DVD, etc. For example, if you have a DVD player connected to the VIDEO 3 jack, you can select the label DVD for the VIDEO 3 input. Then when you press TV/VIDEO to change inputs, the Video Label you assigned to that input appears on screen.</p> <ol style="list-style-type: none"> <li>1 Press  to highlight the video input (VIDEO 1-3, or 4 (KLV-S20G10)) to which you want to assign a label. Then press  to select the input.</li> <li>2 Press  to highlight one of the displayed labels. Then press  to select the label.</li> </ol> <p>You can select from the following labels for each input:</p> <hr/> <p>Video 1-3      Model KLV-S15G10: Use Video 1-2 for labeling Video 1-2, VHS, DVD, Receiver, Satellite, Cable Box, 8mm, DTV, Game, LD, Beta and Skip.</p> <p>Model KLV-S20G10: Use Video 1-3 for labeling Video 1-3, VHS, DVD, Receiver, Satellite, Cable Box, 8mm, DTV, Game, LD, Beta and Skip.</p> <hr/> <p>Video 3      Model KLV-S15G10: For labeling Video 3, DVD, Satellite, Cable Box, DTV, HD, Game, PVR and Skip.</p> <hr/> <p>Video 4      Model KLV-S20G10: For labeling Video 4, DVD, Satellite, Cable Box, DTV, HD, Game, PVR and Skip.</p> <hr/> <p> <b>If you select Skip, your TV skips this input when you press the TV/VIDEO button.</b></p> <hr/> <p>Game Picture      Allows you to move the position of the picture left and right in the window. This function allows for horizontal adjustment of the picture being displayed.</p> <hr/> <p>Language      Select to display all on-screen menus in your language of choice: English, Español, Français.</p> <hr/>

The Skip label is useful for inputs to which no equipment is connected.







(Continued)

## Using the Menus

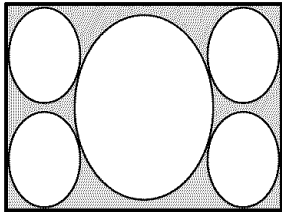
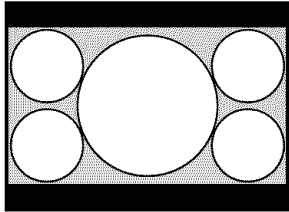
💡 The “aspect ratio” is the ratio of width to height of the screen. 16:9 is also referred to as wide screen format.

💡 If the TV does not automatically detect the 16:9 aspect ratio signal when 16:9 Enhanced is set to Auto, select On to turn on the 16:9 Enhanced feature.

💡 To use the 16:9 Enhanced feature with widescreen DVDs, set the TV’s aspect ratio to 16:9 on your DVD player.

Option	Description
16:9 Enhanced	<p>Provides enhanced picture resolution, which allows you to watch widescreen pictures that have been stretched in the vertical direction, such as certain DVD titles, at their original 16:9 aspect ratio.</p> <div style="display: flex; justify-content: space-around; align-items: center;"> <div style="text-align: center;"> <p>Original Picture</p>  </div> <div style="font-size: 2em;">➔</div> <div style="text-align: center;"> <p>16:9 Enhanced Picture</p>  </div> </div> <ul style="list-style-type: none"> <li>• Wide screen video camera or DVD picture</li> <li>• DTV 16:9 aspect ratio picture</li> </ul> <p>Compressed vertically and displayed on the screen at its original 16:9 aspect ratio. However, black bands appear at the top and bottom of the picture.</p>
Auto	Select to activate the 16:9 Enhanced feature automatically when a 16:9 aspect ratio signal is received (except when receiving 480p signal).
On	Select to activate the 16:9 Enhanced feature. This setting returns to Auto automatically when you change the video input (except when receiving 480p signal).
<p> <b>The option is available only when the TV is set to Video 1, 2, 3 or 4 (KLV-S20G10), which you can do by pressing the TV/VIDEO.</b></p>	
Auto YC	<p>When connecting both VIDEO IN and S VIDEO IN, you can select the jack from which the TV receives the input signal. The TV is factory set to receive S VIDEO input signals.</p> <ol style="list-style-type: none"> <li>1 Press TV/VIDEO repeatedly until the desired video input appears.</li> <li>2 After selecting the Auto YC option, to watch the pictures input from the S VIDEO input jack: Press  to select On, then press . To watch the pictures input from the VIDEO input jack: Press  to select Off, then press .</li> <li>3 Press MENU to exit the menu screen.</li> </ol>
Power Saving	<p><b>Standard</b> Select to view picture without the benefit of Power Saving.</p> <p><b>Reduced</b> Select to view picture with reduced power consumption. It also enhances the black level.</p>

# Other Information

## Troubleshooting

### Trouble Symptoms and Remedies

<b>Problem</b>	<b>Possible Remedies</b>
<b>No picture (screen not lit), no sound.</b>	<input type="checkbox"/> If your TV does not turn on, and a red light keeps flashing, your TV may need service. Call your local Sony Service Center.
<b>No picture.</b>	
Cannot receive any channels.	<input type="checkbox"/> Make sure the power cord is connected securely. <input type="checkbox"/> Turn on the power of the TV. <input type="checkbox"/> Check antenna/cable connections.
Cannot receive upper channels (UHF) when using an antenna.	<input type="checkbox"/> Set <b>Cable</b> to <b>Off</b> in the Channel menu (page 45). <input type="checkbox"/> Perform <b>Auto Program</b> to add receivable channels that are not presently in the TV's memory (page 45).
TV is locked to one channel.	<input type="checkbox"/> Check your <b>Channel Fix</b> setting (page 45). <input type="checkbox"/> Perform <b>Auto Program</b> to add receivable channels that are not presently in the TV's memory (page 45).
Cannot receive any channels when using cable TV.	<input type="checkbox"/> Perform <b>Auto Program</b> to add receivable channels that are not presently in the TV's memory (page 45). <input type="checkbox"/> Make sure <b>Cable</b> in the Channel menu is set to <b>On</b> (page 45).
Cannot receive or select channels.	<input type="checkbox"/> Perform <b>Auto Program</b> to add receivable channels that are not presently in the TV's memory (page 45).
The TV turns off automatically.	<input type="checkbox"/> Check if the <b>Sleep timer</b> is activated (page 39).
No picture from some video sources.	<input type="checkbox"/> Check the connection between the optional video equipment and the TV. <input type="checkbox"/> Press <b>TV/VIDEO</b> on the remote control (page 33). <input type="checkbox"/> If you connect video equipment to the <b>S VIDEO</b> input of the TV, set <b>Auto YC</b> to <b>On</b> in the Setup menu (page 52).
<b>Poor picture.</b>	
Double images or ghosts.	<input type="checkbox"/> Check antenna/cable connections. <input type="checkbox"/> Check the antenna location and direction.

(Continued)

## Other Information

<b>Problem</b>	<b>Possible Remedies</b>
Only snow and noise appear on the screen.	<input type="checkbox"/> Check if the antenna is broken or bent. <input type="checkbox"/> Check if the antenna has reached the end of its serviceable life. (3-5 years in normal use, 1-2 years at the seaside.)
Dotted lines or stripes.	<input type="checkbox"/> Keep the TV away from noise sources such as cars, motorcycles, or hair-dryers.
No color/Dark picture/Color is not correct	<input type="checkbox"/> Press PICTURE MODE to select the desired Picture mode (page 32). <input type="checkbox"/> Adjust the Picture Mode options in the Video menu (page 42).
The picture is too bright.	<input type="checkbox"/> Press PICTURE MODE to select the desired Picture mode (page 32).
Noisy picture.	<input type="checkbox"/> Make sure that the antenna is connected using the supplied 75-ohm coaxial cable. <input type="checkbox"/> Keep the antenna cable away from other connecting cords. <input type="checkbox"/> Do not use 300-ohm twin lead cables as interference may occur.
<b>No sound/Noisy sound</b>	
Good picture, no sound.	<input type="checkbox"/> Check the volume control. <input type="checkbox"/> Press MUTING or VOL + so that "Muting" disappears from the screen (page 32). <input type="checkbox"/> Disconnect your headphones. <input type="checkbox"/> Set Speaker to On in the Audio menu (page 44). If it is set to Off, sound is not output from the TV's speakers regardless of the TV's volume control.
Audio noise.	<input type="checkbox"/> Make sure that the antenna is connected using the supplied 75-ohm coaxial cable. <input type="checkbox"/> Keep the antenna cable away from other connecting cords. <input type="checkbox"/> Do not use 300-ohm twin lead cables as interference may occur. <input type="checkbox"/> Press MTS/SAP to select Mono (page 33).
<b>Striped noise during playback/recording of a VCR.</b>	<input type="checkbox"/> This is caused by video head interference. Keep your VCR away from the TV. <input type="checkbox"/> Leave a space of 30 cm (11 7/8 inches) between your VCR and the TV to avoid noise. <input type="checkbox"/> Avoid installing your VCR in front of the TV or at the side of the TV.
<b>Cannot operate menu item.</b>	<input type="checkbox"/> If the option you want to select appears in a pale color, you cannot select it.
<b>Screen Mode changes automatically with 16:9 Enhanced set to Auto.</b>	<input type="checkbox"/> The TV automatically detects the aspect ratio signal transmitted with the picture signal and displays the picture at its original aspect ratio (page 52).
<b>The picture looks distorted, with people appearing unnaturally short and thick, with 16:9 Enhanced set to On.</b>	<input type="checkbox"/> If you set 16:9 Enhanced to On, the picture is forcibly compressed vertically regardless of its aspect ratio signal. Therefore, a picture in the 4:3 aspect ratio, such as a normal 4:3 broadcast, looks unnatural because of compression. This problem is more serious for a Letterbox movie because the entire picture, including its upper and lower black bands, is compressed. You can watch these pictures at their original aspect ratio by setting 16:9 Enhanced to Auto.
<b>Remote control does not operate.</b>	<input type="checkbox"/> The batteries could be weak. Replace the batteries. <input type="checkbox"/> Check the polarity of the batteries. <input type="checkbox"/> Press the TV (FUNCTION) button first for TV operation. <input type="checkbox"/> Point the remote control at the remote control sensor of the TV. <input type="checkbox"/> Install the TV away from fluorescent lights. <input type="checkbox"/> Press FUNCTION button for the device you want to control.

<b>Problem</b>	<b>Possible Remedies</b>
<b>Cannot change channels with the remote control.</b>	<ul style="list-style-type: none"> <li><input type="checkbox"/> If you are using another device to change channels, be sure you have not inadvertently switched your TV from channel 3 or 4 setting. Use the Channel Fix option to “fix” the channel based on the type of hookup (page 45).</li> <li><input type="checkbox"/> If you are using another device to control channels, be sure the FUNCTION button for that device has been pressed. For example, if you are using your cable box to control channels, be sure to press SAT/CABLE (page 32).</li> </ul>
<b>Lost password.</b>	<ul style="list-style-type: none"> <li><input type="checkbox"/> Select the Parent menu on the menu screen, then enter the following master password: 4357. The master password clears your previous password and allows you to enter a new password (page 47).</li> </ul>

## **Contacting Sony**

If, after reading these operating instructions, you have additional questions related to the use of your Sony TV, please call our Customer Information Services Center at 1-800-222-SONY (7669) (US residents only) or 1-877-899-SONY (7669) (Canadian residents only).

Before calling Sony customer support, please write down the model and serial numbers of your TV. You'll find this information on the front cover of this manual.

## Other Information

# Specifications

### Television system:

American TV standard

### Channel coverage:

VHF: 2-13/UHF: 14-69/CATV: 1-125

### Antenna:

75-ohm external terminal for VHF/UHF

### Screen size (measured diagonally):

KLV-S15G10: 15 inches

KLV-S20G10: 20 inches

### Panel System:

LCD (Liquid Crystal Display) Panel

### Display resolution (horizontal × vertical):

640 dots × 480 lines

### VIDEO 1/2 IN

S VIDEO (4-pin mini DIN):

Y: 1.0 V<sub>p-p</sub>, 75 ohms unbalanced, sync negative

C: 0.286 V<sub>p-p</sub> (Burst signal), 75 ohms

VIDEO: 1 V<sub>p-p</sub>, 75 ohms unbalanced, sync negative

AUDIO: 500 mV<sub>rms</sub> (100% modulation)

Impedance: 47 kilohms

### VIDEO 3 IN (for KLV-S20G10)

VIDEO: 1 V<sub>p-p</sub>, 75 ohms unbalanced, sync negative

AUDIO: 500 mV<sub>rms</sub> (100% modulation)

Impedance: 47 kilohms

### VIDEO 3 IN (for KLV-S15G10):

### VIDEO 4 IN (for KLV-S20G10):

YPbPr (Component Video):

Y: 1.0 V<sub>p-p</sub>, 75 ohms unbalanced, sync negative

Pb: 0.7 V<sub>p-p</sub>, 75 ohms

Pr: 0.7 V<sub>p-p</sub>, 75 ohms

Signal format: 480i, 480p

AUDIO: 500 mV<sub>rms</sub> (100% modulation)

Impedance: 47 kilohms

### AUDIO OUT:

500 mV<sub>rms</sub> (100% modulation)

More than 1 V<sub>rms</sub> at the maximum volume setting (Variable)

More than 500 mV<sub>rms</sub> (Fixed)

### Headphones:

Stereo mini jack

Impedance: 16 ohms

### Speaker:

Full range: KLV-S15G10: ø5 cm (ø2 inches) (2)

KLV-S20G10: 4 × 7 cm (1 5/8 × 2 7/8 inches) oval (2)

### Speaker output:

KLV-S15G10: 2 W + 2 W

KLV-S20G10: 3 W + 3 W

### Power requirement:

KLV-S15G10: DC 16.5 V, with AC power adaptor

KLV-S20G10: AC 120 V, 50/60 Hz

### AC power adaptor for KLV-S15G10:

Model name: AC-FD006

Rating: Input AC 100 V-240 V

50/60 Hz, 74 W

Output DC 16.5 V 3.9 A

### Power consumption:

In use: KLV-S15G10: 48 W

KLV-S20G10: 67 W

Power Off: KLV-S15G10: 0.9 W

KLV-S20G10: 0.3 W

Dimensions (W/H/D):

KLV-S15G10: (with stand) 380 × 397 × 179 mm

(15 × 15 3/4 × 7 1/8 inches)

(without stand) 380 × 361 × 92 mm

(15 × 14 1/4 × 3 5/8 inches)

KLV-S20G10: (with stand) 504 × 509 × 250 mm

(19 7/8 × 20 1/8 × 9 7/8 inches)

(without stand) 504 × 467 × 110 mm

(19 7/8 × 18 1/2 × 4 3/8 inches)

### Mass:

KLV-S15G10: (with stand) 4.2 kg (9 lb. 4 oz.)

(without stand) 3.6 kg (7 lb. 15 oz.)

KLV-S20G10: (with stand) 9.0 kg (19 lb. 14 oz.)

(without stand) 7.5 kg (16 lb. 9 oz.)

### Supplied accessories:

Remote control RM-Y1104 (1)

Size AA batteries (2)

75-ohm coaxial cable (1)

AC power cord (1)

AC power adaptor (1) (KLV-S15G10 only)

VESA adaptor: bracket A (1), bracket B (1) and screws (2)

(KLV-S15G10 only)

Operating Instructions

Quick Setup Guide

Leaflet (Installing the Wall-Mount Bracket to the TV,

KLV-S20G10 only) (1)

Warranty Card

### Optional accessories:

Headphones plug adaptor

Connecting cables

Wall-Mount Bracket SU-WL11 (KLV-S20G10)

 **Optional accessories' availability may depend on its stock.**

Design and specifications are subject to change without notice.



# Index

16:9 Enhanced 52

## A

AC IN 18  
Audio menu 40, 43  
Audio Out 44  
AUDIO OUT jack, described 18  
Auto Program 31, 45  
Auto SAP, MTS setting 43  
Auto YC 52

## B

Backlight, adjusting 42  
Balance, adjusting 43  
Bass, adjusting 43  
Bilingual audio 43  
Brightness, adjusting 42

## C

Cable  
    channel setting 45  
    with VCR, connecting 25  
Cable box  
    using with remote control 36  
Camcorder connection 30  
Caption Vision 10, 50  
CH buttons 15, 33  
Change Password 47  
Channel Fix 45  
Channel menu 40, 45  
Channels  
    creating labels 46  
    setting up 31  
CineMotion 10  
**CC** (Closed Caption) button 33  
Closed caption modes 50  
CODE SET button 32  
Color, adjusting 42  
Component video/AUDIO (L/R)  
    jacks, described 18

## D

DC IN 18  
DISPLAY button 33  
DVD player  
    using with remote control 36  
    with A/V connectors,  
    connecting 29

## E

Effect, setting 43  
ENT button 33

## F

Favorite Channels 37, 45  
FAVORITES button 32  
Fixed, audio setting 44  
Freeze 38  
FREEZE button 15, 32  
FUNCTION buttons 32

## G

Game Picture 51  
GUIDE button 33

## H

Headphones jack, described 16  
Hue, adjusting 42

## I

Info Banner 10, 50  
Infrared Receiver (IR) 15

## J, K

Jump 38  
JUMP button 32

## L

Label  
    channels 46  
    video inputs 51  
Language, setup setting 51  
Lock, parent setting 47

## M

Menu  
    Audio 40, 43  
    Channel 40, 45  
    Parent 40, 47  
    Setup 41, 50  
    Video 40, 42  
MENU button 33  
Mono, MTS setting 43  
MTS 43  
MTS/SAP button 33  
MUTING button 32

## O

Off, turning off the TV 15  
On, turning on the TV 15

## P, Q

Parent menu 40, 47  
Parental control, described 10  
PICTURE MODE button 32  
Picture Mode, selecting 42  
Picture, adjusting 42  
POWER button 15, 33  
POWER LED 15  
Power Saving 52  
Pro mode 42  
Problems, troubleshooting 53–55

## R

Ratings, Parent setting 48–49  
Ratings, viewing blocked  
    programs 48, 49  
Reduced, power saving 52  
Remote control  
    programming 34–35  
RESET button 33

## S

S VIDEO jack, described 16, 18

(Continued)

SAT/CABLE (FUNCTION) buttons 32  
SAT/CABLE (POWER) button 33  
Satellite receiver  
    using with remote control 36  
Select Country 47  
Setting up Channels 31  
Setup menu 41, 50  
Sharpness, adjusting 42  
Show/Hide Channels 46  
Sleep 39  
SLEEP button 33  
Speaker  
    turning on/off 44  
    using external speakers 44  
SRS WOW, Effect setting 43  
Standard mode 42  
Standard, power saving 52  
Steady Sound  
    described 10  
    setting 43  
Stereo, MTS setting 43  
Swivel 14  
SYSTEM OFF button 33

## **T, U**

Tilt 14  
TIMER LED 15  
Treble, adjusting 43  
Troubleshooting 53–55  
Turning on/off the TV 15  
TV (FUNCTION) button 32  
TV/SAT,  button 32  
TV/VIDEO button 15, 33

## **V**

Variable, audio setting 44  
VCR  
    using with remote control 36  
    with cable, connecting 25  
VCR/DVD (FUNCTION) button 32  
VCR/DVD (POWER) button 33  
VESA adaptor 13  
VHF/UHF jack, described 18  
Video menu 40, 42

VIDEO/AUDIO (L/R) jacks,  
    described 16, 18  
Vivid mode 42  
VOL buttons 15, 32

<http://www.sony.net/>

Printed in Taiwan