

SAMSUNG

HC-R4245W

HC-R4745W

HC-R5245W

HC-R4355W

HC-R4755W

PROJECTION TELEVISION

▶ **Owner's
Instructions**

Register your product at www.samsung.com/global/register

Important Warranty Information Regarding Television Format Viewing

Standard screen format televisions (4:3, the aspect ratio of the screen width to height) are primarily designed to view standard format full-motion video. The images displayed on them should primarily be in the standard 4:3 ratio format and constantly moving. Displaying stationary graphics and images on screen, such as the dark top and bottom letterbox bars (wide screen pictures), should be limited to no more than 15% of the total television viewing per week.

Wide screen format televisions (16:9, the aspect ratio of the screen width to height) are primarily designed to view wide screen format full-motion video. The images displayed on them should primarily be in the wide screen 16:9 ratio format, or expanded to fill the screen if your model offers this feature, and constantly moving. Displaying stationary graphics and images on screen, such as the dark side-bars on non-expanded standard format television video and programming, should be limited to no more than 15% of the total television viewing per week.

Additionally, viewing other stationary images and text such as stock market reports, video game displays, station logos, web sites or computer graphics and patterns, should be limited as described above for all televisions. *Displaying any stationary images that exceed the above guidelines can cause uneven aging of picture tubes (CRTs) that leave subtle, but permanent burned-in ghost images in the television picture. To avoid this, vary the programming and images, and primarily display full screen moving images, not stationary patterns or dark bars.* On television models that offer picture sizing features, use these controls to view the different formats as a full screen picture.

Be careful in the selection and duration of television formats used for viewing. Uneven CRT aging as a result of format selection and use, as well as other burned-in images, is not covered by your Samsung limited warranty.

A Guide to Digital TV

What is Digital Television?

Digital television (DTV) is a new way of transmitting high quality video and audio to your TV set. Using DTV, broadcasters can transmit high definition TV (HDTV) images, Dolby digital surround audio, and new services such as multicasting (transmitting more than one program on the same TV channel) and datacasting (providing electronic program guides and interactive television). Several of these services can be combined into a single digital broadcast.

Digital Television Services

Digital Picture Quality

DTV programs are transmitted in two different formats. The first is Standard Definition Television (SDTV) and the second is High Definition Television (HDTV).

SDTV program formats include 480-line interlaced (480i) and 480-line progressive (480p) video. 480i programs are essentially a digital version of our current analog TV programs, while the 480p format offers improved image detail over 480i. Some 480p programs are broadcast in widescreen and are comparable to progressive-scan DVD movies in image quality.

HDTV program formats include 1080-line interlaced (1080i) and 720-line progressive (720p). Both HDTV formats are always broadcast in widescreen, and offer much higher picture quality than SDTV.

Dolby Surround Sound

With DTV, you can listen to a variety of Dolby digital audio formats from Dolby Surround 2.0 to Dolby Digital 5.1 surround, using your home audio system. Many HDTV programs are now broadcast with DD 5.1 soundtracks.

Interactive Communications and Datacasting

DTV will allow you to interact with your television; choosing programs from a detailed program guide, ordering products on-line while watching TV, and accessing ancillary data about a program.

How to View Digital Television

There are three ways to watch DTV. The first is to use an integrated digital TV; one with a built-in digital television tuner. The second is to connect an external DTV set-top receiver to a DTV-ready television or monitor. This type of TV or monitor will have wideband component video and stereo audio inputs. You can also watch DTV signals with personal computer (PC) tuner cards and computer monitors.

Integrated TVs versus DTV-ready TVs and monitors

The advantage of an integrated DTV set is that it can tune both analog and digital TV channels at the same time. All you'll need to do is add an external antenna and you are ready to watch DTV.

However, integrated DTV sets are not as common as DTV-ready TVs and monitors. If you already own a DTV-ready TV with component video inputs, you can enjoy DTV broadcasts by simply adding a low-cost DTV set-top receiver and antenna.

NOTE

This television receiver supports the copy protection system regulated by DTLA (Digital Transmission Licensing Administrator). It should be noted that copy protected content may not be viewable depending on your particular connections.

Q&A

1. Is the antenna I use for existing TV reception good enough for DTV?

Over-the-air (OTA) digital TV broadcasting uses the same channels as analog TV and works well with many existing TV antennas. However, DTV broadcast channel assignments are different than analog channels. You should find out whether your local DTV broadcasts are on VHF (channels 2-13) or UHF (channels 14-69) to see if you need a different antenna.

If your DTV channels are on UHF and you already get good UHF reception, your present antenna may work fine. The same holds true for VHF DTV reception. Note that in some markets, both VHF and UHF channels are used for DTV broadcasts.

You can find out the latest DTV channel assignments for your area by browsing selected Internet web sites such as www.titantv.com, and www.fcc.gov.

2. How difficult is it to receive DTV signals indoors?

This depends on whether your local DTV stations are running full power or not and how close your location is to the transmission tower. DTV receivers do not require as much signal as analog TV receivers to produce high-quality images and sound.

Once the DTV signal level exceeds a certain threshold at the receiver, the digital video and audio data is decoded at the same quality it was originally encoded for broadcast. This is a big advantage for DTV over analog TV - there is no noise, ghosting, static, or scratchy audio.

3. How can I connect an antenna in my townhouse, co-operative apartment, condominium, or apartment?

The Federal Communications Commission's OTARD Rule (part of the Telecommunications Act of 1996) allows residents of condominiums, townhouse, or members of neighborhood associations to put up outside antennas for reception of broadcast TV signals as long as those antennas are not located in common areas and are no more than 12' in height.

Residents of rental units (apartments, etc) are not covered by the OTARD rules and will have to use indoor antennas to receive DTV broadcasts. It is possible that the landlord of an apartment complex can provide broadcast DTV signals via a master TV antenna system to each apartment.

4. Can I connect my DTV set-top receiver to my cable TV service?

Cable TV systems use a different method for transmitting digital TV programs that is currently incompatible with broadcast DTV set-top receivers. So you will still need to use an outdoor or indoor antenna to receive OTA broadcast DTV programs.

The good news is that you won't have to pay a monthly or per-program charge to watch OTA DTV and HDTV programs. They're free, unlike subscription satellite TV or premium cable TV. All you need is an antenna and a DTV set-top receiver to enjoy clear, sharp widescreen images and high-quality audio.

Chapter 1: Your New TV

| | |
|--|----|
| List of Features..... | 8 |
| Accessories..... | 8 |
| Familiarizing Yourself with Your New TV..... | 9 |
| Control Buttons | 9 |
| Connection Jacks (Side) | 10 |
| Connection Jacks (Rear)..... | 11 |
| Remote Control | 12 |

Chapter 2: Installation

| | |
|---|----|
| Connecting VHF and UHF Antennas | 14 |
| Antennas with 300-ohm Flat Twin Leads | 14 |
| Antennas with 75-ohm Round Leads | 15 |
| Separate VHF and UHF Antennas..... | 15 |
| Connecting Cable TV..... | 16 |
| Cable without a Cable Box | 16 |
| Cable with a Cable Box that Descrambles All Channels | 16 |
| Connecting to a Cable Box that Descrambles Some Channels..... | 17 |
| Connecting a VCR | 18 |
| Connecting a Second VCR to Record from the TV | 19 |
| Connecting a Camcorder | 19 |
| Connecting a DVD Player or DTV Set-Top Box (480i, 480p, 720p, 1080i)..... | 20 |
| Connecting to Y, Pb, Pr | 20 |
| Connecting to Regular Audio and Video Jacks | 20 |
| Connecting a Digital TV Set-Top Box | 21 |
| Connecting to DVI (Digital Visual Interface) | 21 |
| Connecting a Digital Audio System | 22 |
| Connecting to an Analog Amplifier | 22 |
| Installing Batteries in the Remote Control | 23 |

Chapter 3: Operation

| | |
|--|----|
| Turning the TV On and Off | 24 |
| Plug & Play Feature | 24 |
| Adjusting the Screen Automatically (Self Focus)..... | 26 |
| Deactivating the Automatic Execution of the Self Focus | 27 |
| Removing the "Self Focus" Message from the Display | 27 |
| Adjusting Convergence Manually | 28 |
| Viewing the Menu and On-Screen Displays | 30 |
| Viewing the Menu..... | 30 |
| Viewing the Display | 30 |
| Selecting a Menu Language | 31 |
| Selecting the Antenna Input | 31 |
| Memorizing the Channels | 32 |
| Selecting the Video Signal Source | 32 |
| Storing Channels in Memory | 33 |
| Adding and Erasing Channels | 34 |
| Changing Channels | 35 |
| Using the Channel Buttons..... | 35 |
| Using the Number Buttons | 35 |
| Using the "-" Button | 35 |
| Using the Previous Channel | 35 |
| Selecting Your Favorite Channels | 36 |
| To Store Your Favorite Channels..... | 36 |
| To View Your Favorite Channels..... | 36 |
| Labeling the Channels | 37 |
| Viewing the Channel Lists | 38 |
| Editing the Channel Lists | 39 |
| Picture Control..... | 40 |
| Using Automatic Picture Settings | 40 |
| Customizing the Picture | 41 |
| Resetting the Picture Settings to the Factory Defaults | 42 |

Chapter 3: Operation (continued)

| | |
|---|----|
| Sound Control | 43 |
| Adjusting the Volume | 44 |
| Using the MUTE Button | 44 |
| Customizing the Sound | 44 |
| Using Automatic Sound Settings..... | 45 |
| Setting the Clock | 45 |
| Option 1: Setting the Clock Manually..... | 45 |
| Option 2: Setting the Clock Automatically | 46 |
| Viewing an External Signal Source | 47 |
| Setting the Signal Source | 47 |
| Assigning Names to External input mode | 48 |

Chapter 4: Special Features

| | |
|--|----|
| Fine Tuning Analog Channels | 49 |
| Checking the Digital-Signal Strength | 50 |
| Changing the Screen Size | 51 |
| BBE | 52 |
| Auto Volume | 53 |
| Choosing a Multi-Channel Sound (MTS) track - Digital | 54 |
| Choosing a Multi-Channel Sound (MTS) track - Analog..... | 55 |
| Choosing a Digital Sound Format | 56 |
| Setting the On/Off Melody | 57 |
| Setting the On/Off Timer | 58 |
| Setting the Sleep Timer | 59 |
| Using the V-Chip (USA) | 60 |
| How to Change Your Password..... | 60 |
| How to Enable/Disable the Rating Controls | 61 |
| How to Set up Restrictions Using the "TV Parental Guidelines" | 62 |
| How to Set up Restrictions using the Movie Ratings: | |
| G, PG, PG-13, R, NC-17, X | 63 |
| Important Notes About Parental Locks..... | 64 |
| Viewing Closed Captions (On-Screen Text Messages) - Analog..... | 65 |
| Viewing Closed Captions (On-Screen Text Messages) - Digital..... | 66 |
| Menu Translucency Level | 68 |
| Setting the Function Help | 69 |
| Electronic Program Guide | 70 |
| Viewing the Electronic Program Guide | 70 |
| Using the Electronic Program Guide..... | 71 |
| Viewing Information about a Single Channel | 72 |
| Viewing Information about Channels | 73 |
| Reminder List..... | 74 |
| Reminded Viewing List..... | 74 |
| To view the Reminder List | 75 |
| To remove the scheduled programs | 75 |
| Customizing Your Remote Control..... | 75 |
| Setting Up Your Remote Control to Operate Your VCR (Cable box or DVD player)..... | 76 |
| Remote Control Codes | 77 |

Chapter 5: Troubleshooting

| | |
|----------------------------|----|
| Identifying Problems | 78 |
|----------------------------|----|

Appendix

| | |
|--|----|
| Cleaning and Maintaining Your TV | 79 |
| Using Your TV in Another Country | 79 |
| Specifications..... | 79 |

Chapter One

YOUR NEW TV

List of Features

Your TV was designed with the latest technology. This TV is a high-performance unit that includes the following special features:

- Easy-to-use remote control
- Easy-to-use on-screen menu system
- Automatic timer to turn the TV on and off
- Adjustable picture and sound settings that can be stored in the TV's memory
- A special filter to reduce or eliminate reception problems
- Fine tuning control for the sharpest picture possible
- A built-in multi-channel sound decoder for stereo and bilingual listening
- Built-in, dual channel speakers
- A special sleep timer
- Component Video Input jacks to obtain a sharper image from external sources
- Adjusting the Screen Automatically (Self Focus)
- Digital Input (Digital Visual Interface) jack
- Digital Audio Output (COAXIAL/OPTICAL) jacks
- AV network system (Anynet) that enables you to easily control Samsung audio-video (AV) devices from this TV.

Accessories

Once you have unpacked your TV, check to make sure that you have all the parts shown here. If any piece is missing or broken, call your dealer.

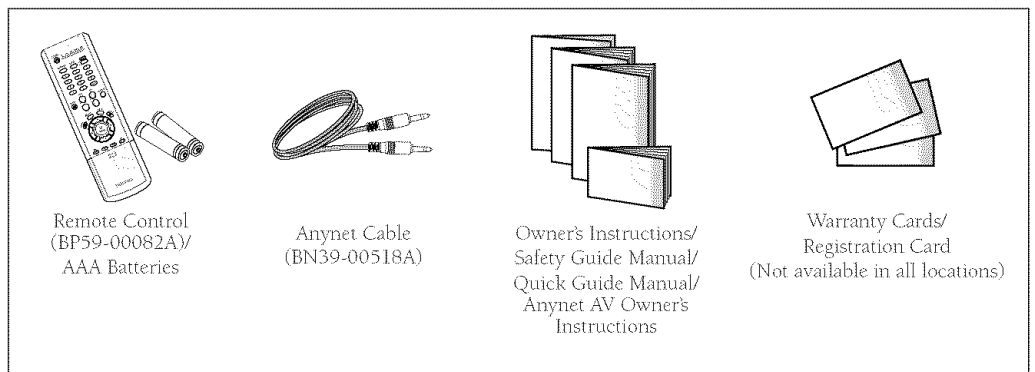

Familiarizing Yourself with Your New TV

Control Buttons

You can control your TV's basic features, including the on-screen menu. To use the more advanced features, you must use the remote control.

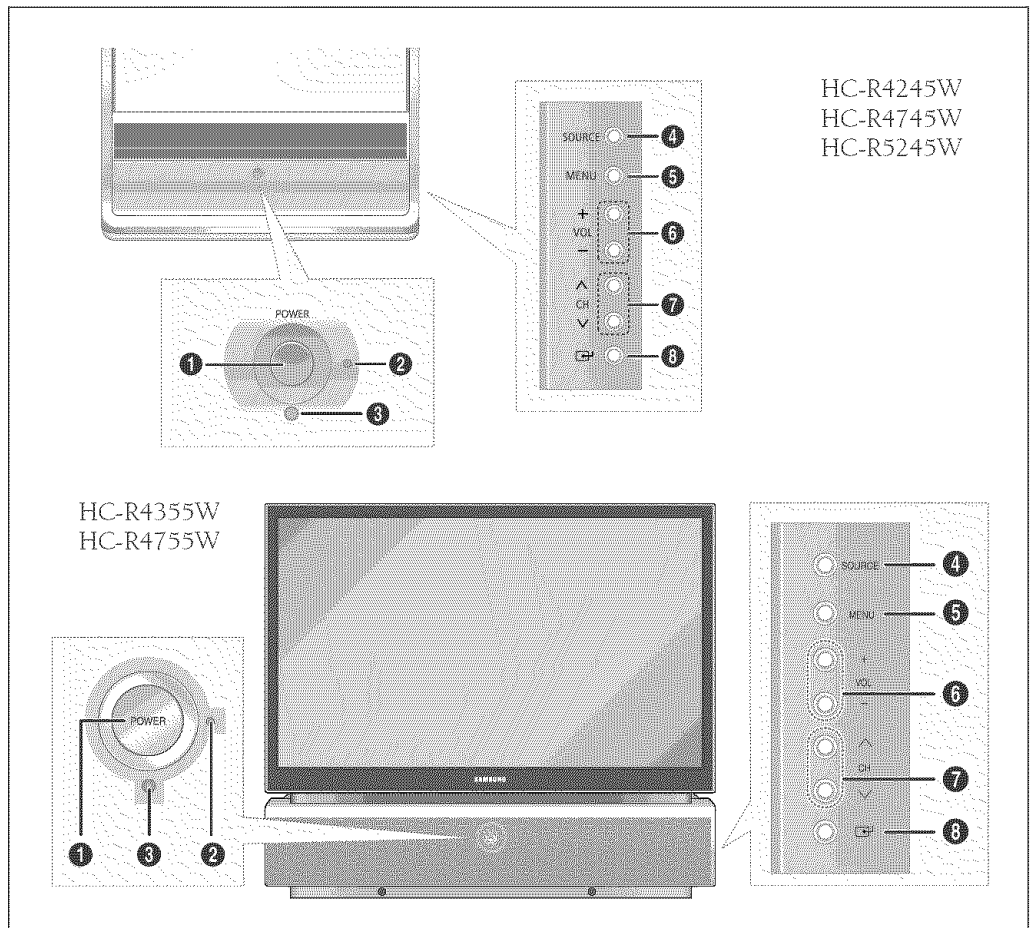

1 POWER

Press to turn the TV on and off.

2 Stand-By Indicator

Lights up when you turn the power off.

- Power Off ; Red
- Power On ; Off
- Timer On ; Green

3 Remote Control Sensor

Aim the remote control towards this spot on the TV.

4 SOURCE

Press to switch between viewing TV programs and signals from connected components.

5 MENU

Press to see an on-screen menu of your TV's features.

6 + VOL -

Press to lower or raise the volume and to select items when using the on-screen menu.

7 ^ CH v

Press to change channels and move between items on the on-screen menu.

8 [Enter]

While using the on-screen menus, press to activate (or change) a particular item.

Connection Jacks (Side)

You can connect an A/V component that is used only occasionally, such as a camcorder or video game. For information on connecting equipment, see page 19.

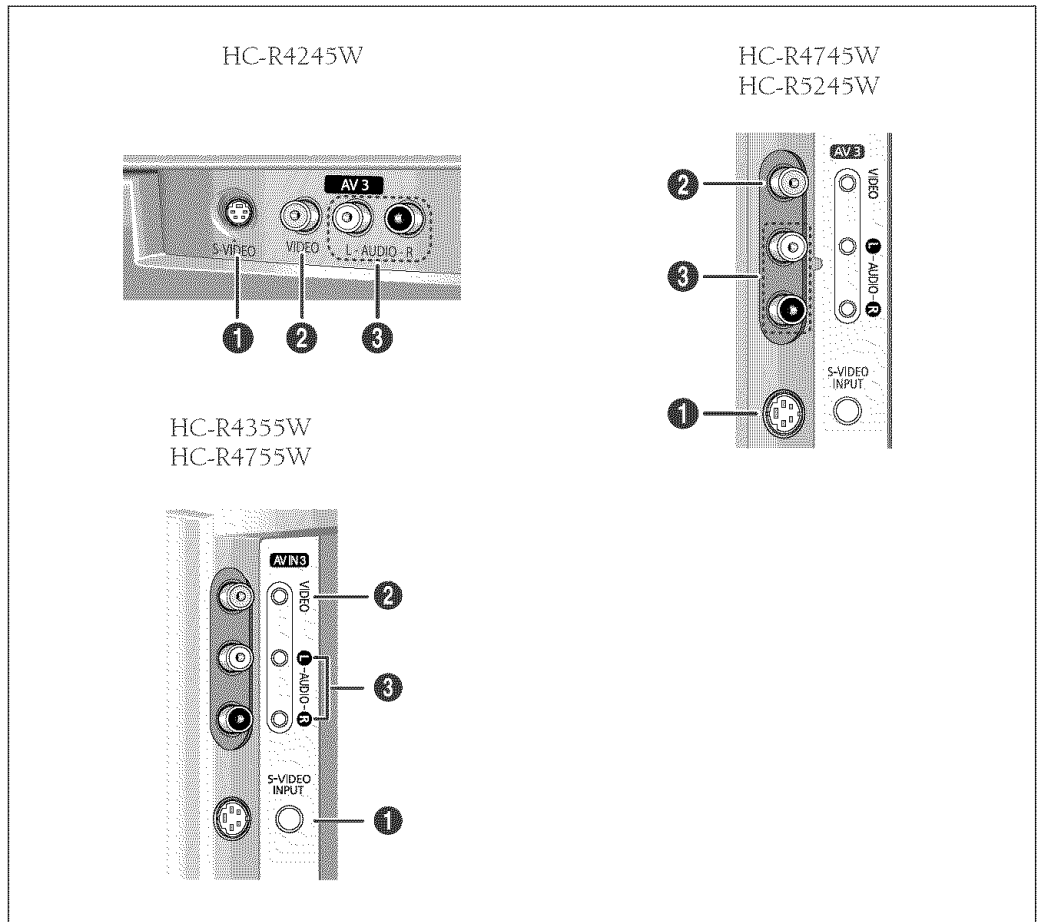

❶ S-VIDEO Input

Connect an S-Video signal from a camcorder or video game.

❷ VIDEO Input

Connect the video signal from a camcorder or video game.

❸ AUDIO Input

Connect the audio signals from a camcorder or video game.

Connection Jacks (Rear)

Use the rear panel jacks to connect an A/V component that will be connected continuously, such as a VCR or a DVD player. For more information on connecting equipment, see pages 14~22.

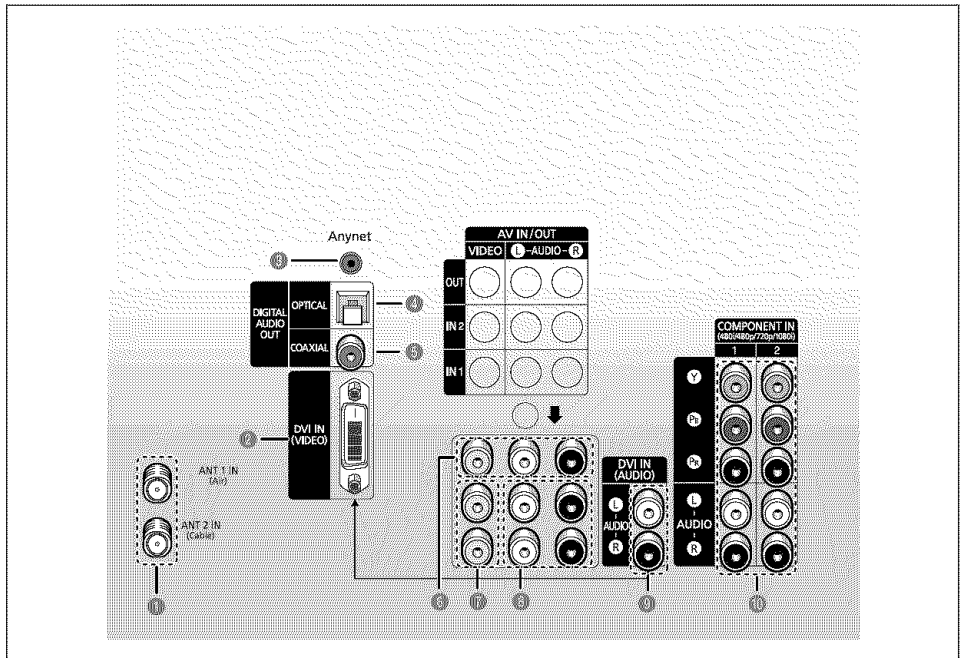

1 ANTENNA terminals

Two independent cables or antennas can be connected to these terminals. Use "ANT 1 IN (Air)" and "ANT 2 IN (Cable)" terminals to receive a signal from VHF/UHF antennas or your cable system.

2 DVI Video Input jack

(Digital Visual Interface)
Connect the DVI jack to a device with DVI output.

3 Anynet

Please refer to the Anynet Owner's Instructions.

4 OPTICAL Output jack

Connect to a Digital Audio component.

5 COAXIAL Output jack

Connect to a Digital Audio component.

6 Audio/Video Output jacks

Connect to the audio/video input jacks of a recording VCR.

7 Video Input jacks

Connect to the video output jacks of VCRs, DVD players and similar devices.

8 Audio Input jacks

Connect to the audio output jacks of VCRs, DVD players and similar devices.

9 DVI Audio Input jacks

Connect to the audio output jacks of a device with DVI.

10 COMPONENT Input jacks (Y, PB, PR, AUDIO-L/R)

Connect to the Component audio and video outputs of DVD or DTV Set-Top Box. 480i/480p/720p/1080i Y, PB and PR video signal inputs are available.

Remote Control

You can use the remote control up to about 23 feet from the TV. When using the remote, always point it directly at the TV.

You can also use your remote control to operate your VCR, DVD, Cable box and Samsung Set-top boxes. See pages 76~77 for details.

- 1 POWER**
Turns the TV on and off.
- 2 ANTENNA**
Press to select "Cable" or "Air".
- 3 GUIDE**
Press to display the on-screen Electronic Program Guide (EPG).
- 4 Number buttons**
Press to select channels directly on the TV.
- 5 -**
Press to select additional channels (digital and analog) being broadcast by the same station. For example, to select channel "54-3", press "54", then press "-" and "3".
- 6 VOL -, VOL +**
Press to decrease or increase the volume.
- 7 MUTE**
Press to temporarily cut off the sound.
- 8 Anynet**
Please refer to the Anynet Owner's Instructions.
- 9 MENU**
Displays the main on-screen menu.
- 10 ◀/▶/▼/▲**
Controls the cursor in the menu.
- 11 VCR/DVD Controls**
Controls VCR/DVD functions: Rewind, Stop, Play/Pause, Fast Forward.

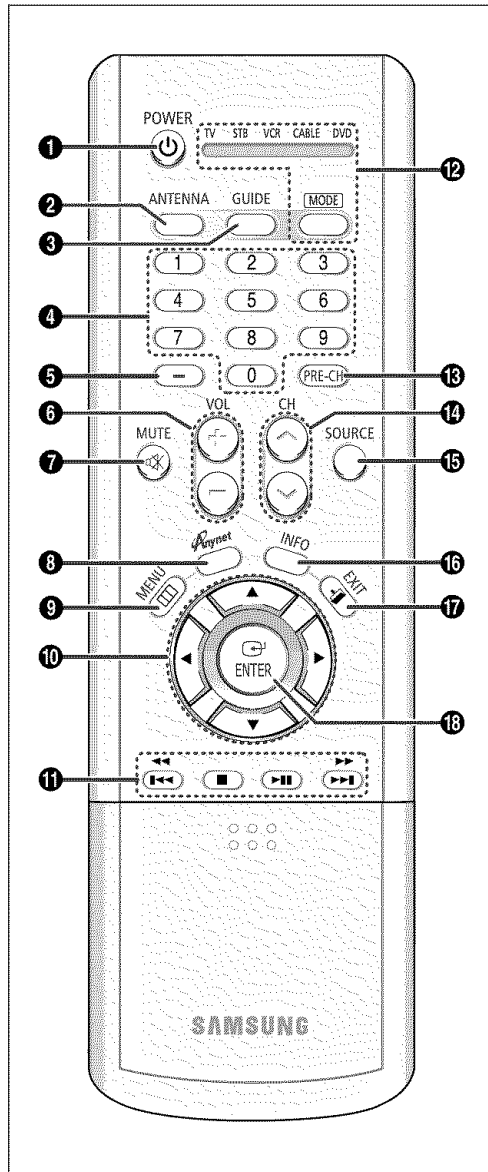

- 12 MODE**
Selects a target device to be controlled by this remote control (i.e., TV, Samsung STB, VCR, Cable box or DVD).
- 13 PRE-CH**
Tunes to the previous channel.
- 14 CH ^, CH v**
Press to change channels.
- 15 SOURCE**
Each time the button is pressed, all the inputs connected to the external component jacks will be shown in regular sequence.
- 16 INFO**
Press to display information on the TV screen.
- 17 EXIT**
Press to exit the menu.
- 18 ENTER**
While using the on-screen menus, press **ENTER** to activate (or change) a particular item.

Remote Control (continued)

- 19 CH. LIST**
Displays the channel list.
- 20 FAV. CH** (Favorite Channel)
Press to switch to your favorite channels.
- 21 P.MODE**
Adjust the TV picture by selecting one of the preset factory settings (or select your personal, customized picture settings).
- 22 P.SIZE**
Press to change the picture size.
- 23 S.MODE**
Adjust the TV sound by selecting one of the preset factory settings (or select your personal, customized sound settings).
- 24 SET**
Used during set up of this remote control, so that it will work compatibly with other devices (VCR, Samsung Set-Top box, Cable box, DVD, etc.)

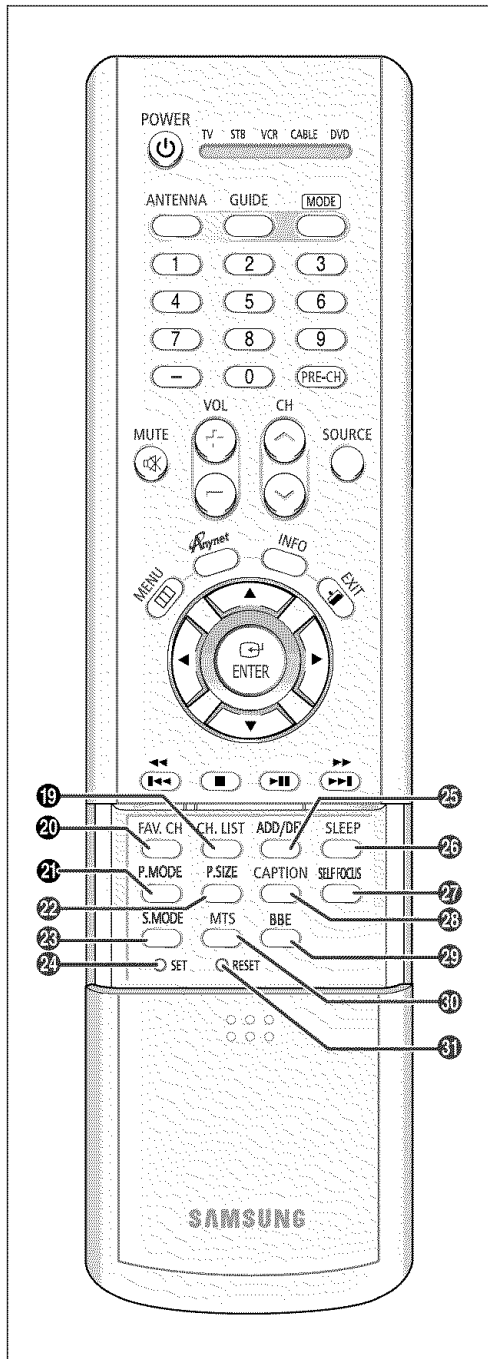

- 25 ADD/DEL**
Press to add or erase channels in the TV's memory. Use to memorize or erase the channel fine tuning.
- 26 SLEEP**
Press to select a preset time interval for automatic shut off.
- 27 SELF FOCUS**
Press to adjust for the optimum picture set in the factory.
- 28 CAPTION**
Press to view closed caption information.
- 29 BBE**
BBE is a built-in effect that adds clarity, punch and dynamics to the sound.
- 30 MTS** (Multichannel Television Sound)
Press to choose "Stereo", "Mono" or "SAP (Secondary Audio Program)".
- 31 RESET**
If your remote control is not functioning properly, take out the batteries and press the reset button for about 2-3 seconds. Re-insert the batteries and try using the remote control again.

Chapter Two

INSTALLATION

Connecting VHF and UHF Antennas

If your antenna has a set of leads that look like this, see “Antennas with 300-ohm Flat Twin Leads,” below.

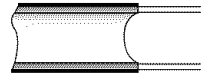

If your antenna has one lead that looks like this, see “Antennas with 75-ohm Round Leads,” on page 15.



If you have two antennas, see “Separate VHF and UHF Antennas,” on page 15.

Antennas with 300-ohm Flat Twin Leads

If you are using an off-air antenna (such as a roof antenna or “rabbit ears”) that has 300-ohm twin flat leads, follow the directions below.

1

Place the wires from the twin leads under the screws on the 300-75 ohm adaptor (not supplied). Use a screwdriver to tighten the screws.

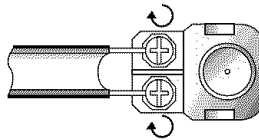

2

Plug the adaptor into the “ANT 1 IN (Air)” terminal on the rear panel.

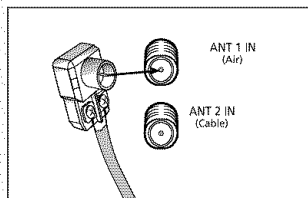

INSTALLATION

Antennas with 75-ohm Round Leads

Plug the antenna lead into the "ANT 1 IN (Air)" terminal on the rear panel.

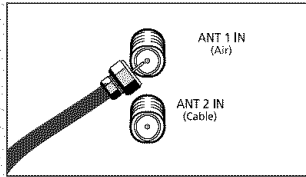

Separate VHF and UHF Antennas

If you have two separate antennas for your TV (one VHF and one UHF), you must combine the two antenna signals before connecting the antennas to the TV. This procedure requires an optional combiner-adaptor (available at most electronics shops).

1
Connect both antenna leads to the combiner.

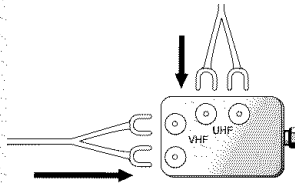

2
Plug the combiner into the "ANT 1 IN (Air)" terminal on the rear panel.

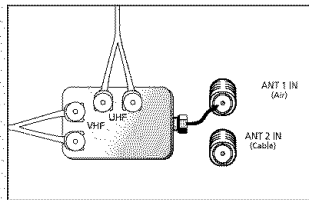

Connecting Cable TV

You can connect different cable systems to your TV, including cable without a cable box, and cable with a cable box that descrambles some or all channels.

Cable without a Cable Box

If you want to connect cable, and you do not need to use a cable box:

Plug the incoming cable into the "ANT 2 IN (Cable)" terminal on the rear panel.

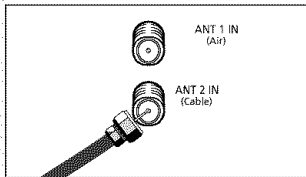

Cable with a Cable Box that Descrambles All Channels

1

Find the cable that is connected to the ANTENNA OUT terminal on your cable box.

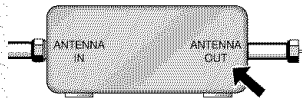

◀ This terminal might be labeled "ANT OUT", "VHF OUT", or simply "OUT".

2

Connect the other end of this cable to the "ANT 2 IN (Cable)" terminal on the rear panel.

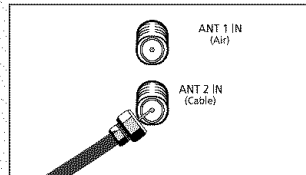

Connecting to a Cable Box that Descrambles Some Channels

If your cable box descrambles only some channels (such as premium channels), follow the instructions below. You will need a two-way splitter, an RF (A/B) switch, and four lengths of coaxial cable. (These items are available at most electronics stores.)

1

Find and disconnect the cable that is connected to the ANTENNA IN terminal on your cable box.

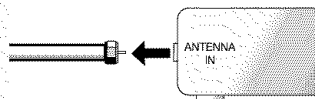

◀ This terminal might be labeled “ANT IN,” “VHF IN,” or simply, “IN.”

2

Connect this cable to a two-way splitter. Connect a coaxial cable between an OUTPUT terminal on the splitter and the IN terminal on the cable box.

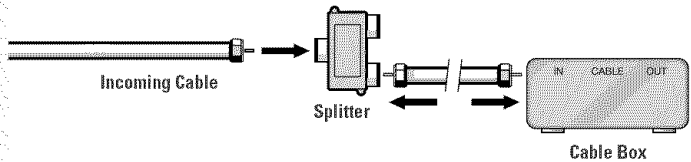

3

Connect a coaxial cable between the ANTENNA OUT terminal on the cable box and the B-IN terminal on the A/B switch.

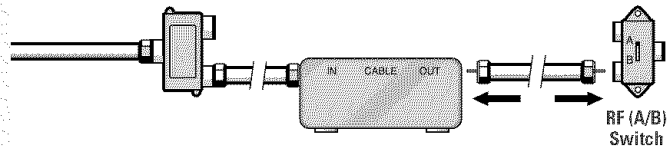

4

Connect another cable between the other OUTPUT terminal on the splitter and the A-IN terminal on the RF (A/B) switch.

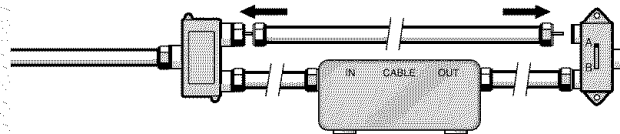

5

Connect the last coaxial cable between the OUT terminal on the RF (A/B) switch and the VHF/UHF terminal on the rear of the TV.

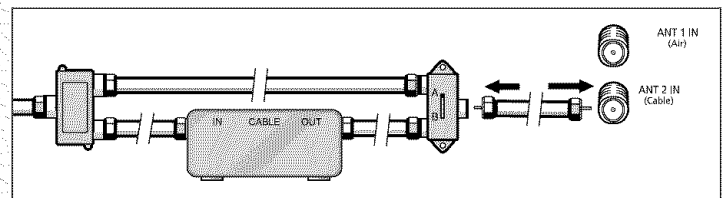

After you've made this connection, set the A/B switch to the “A” position for normal viewing. Set the A/B switch to the “B” position to view scrambled channels. (When you set the A/B switch to “B,” you will need to tune your TV to the cable box's output channel, which is usually channel 3 or 4.)

Connecting a VCR

These instructions assume that you have already connected your TV to an antenna or a cable TV system (according to the instructions on pages 14~17). Skip step **1** if you have not yet connected to an antenna or a cable system.

1

Connect a coaxial cable between the "ANT 1 IN (Air)" (or "ANT 2 IN (Cable)") terminal on the TV and the antenna out terminal on the VCR.

A coaxial cable is usually included with a VCR. (If not, check your local electronics store).

2

Connect a set of audio cables between the "AV IN 1 (L, R)" (or "AV IN 2 (L, R)") jacks on the TV and AUDIO OUT jacks on the VCR.

If you have a mono VCR, connect L(mono) to VCR audio out using only one audio cable.

3

Connect a video cable between the "AV IN 1 (VIDEO)" (or "AV IN 2 (VIDEO)") jack on the TV and the VIDEO OUT jack on the VCR.

Follow the instructions in "Viewing a VCR or Camcorder Tape" to view your VCR tape.

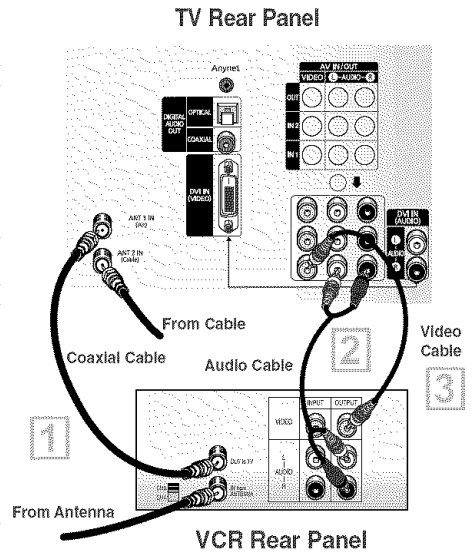

- Also, you can connect to "AV 3" on the side panel of TV.

Connecting a Second VCR to Record from the TV

Your TV can send out signals of its picture and sound to be recorded by a second VCR. To do this, connect your second VCR as follows:

1
Connect a set of audio cables between the "AV OUT (L, R)" jacks on the TV and the AUDIO IN jacks on the VCR.
(The VCR input jacks might be either on the front or rear of the VCR.)

2
Connect a video cable between the "AV OUT (VIDEO)" jack on the TV and the VIDEO IN jack on the VCR.

Refer to your VCR's instructions for more information about how to record using this kind of connection.

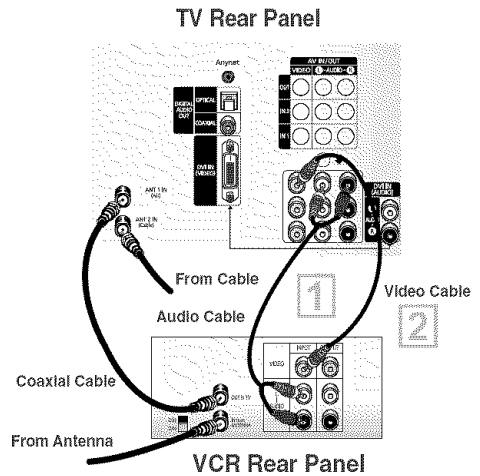

Connecting a Camcorder

The side panel jacks on your TV make it easy to connect a camcorder to your TV. They allow you to view the camcorder tapes without using a VCR. (Also see "Viewing an External Signal Source" on page 47.)

1
Locate the A/V output jacks on the camcorder. They are usually found on the side or rear of the camcorder.

2
Connect a set of audio cables between the "AV 3 (L, R)" jacks on the TV and the AUDIO OUT jacks on the camcorder. If you have mono camcorder, connect L (mono) to camcorder audio out using only one audio cable.

3
Connect a video cable between the "AV 3 (VIDEO)" (or "S-VIDEO") jack on the TV and the VIDEO OUT jacks on the camcorder.

The audio-video cables shown here are usually included with a Camcorder. (If not, check your local electronics store.) If your camcorder is stereo, you need to connect a set of two cables.

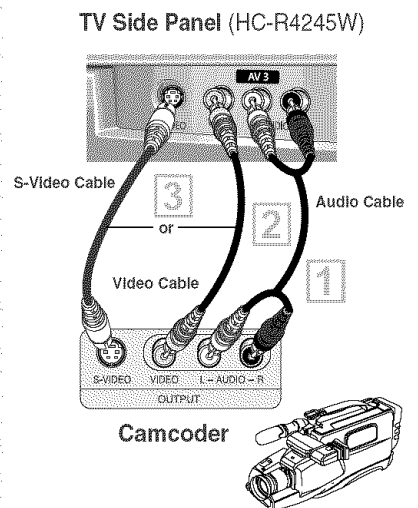

- This figure shows the Standard connector-jack panel. The actual configuration for your TV may be different.

Connecting a DVD Player or DTV Set-Top Box (480i, 480p, 720p, 1080i)

The rear panel jacks on your TV make it easy to connect a DVD player or DTV Set-Top Box to your TV.

Connecting to Y, Pb, Pr

1
Connect a set of audio cables between the “COMPONENT IN 1 (L, R)” (or “COMPONENT IN 2 (L, R)”) jacks on the TV and the AUDIO OUT jacks on the DVD player (or DTV Set-Top Box).

2
Connect a set of video cables between the “COMPONENT IN 1 (Y, Pb, Pr)” (or “COMPONENT IN 2 (Y, Pb, Pr)”) jacks on the TV and the VIDEO OUT (Y, Pb, Pr) jacks on the DVD player (or DTV Set-Top Box).

For an explanation of Component video, see your DVD player’s (or DTV Set-Top Box) owner’s instruction.

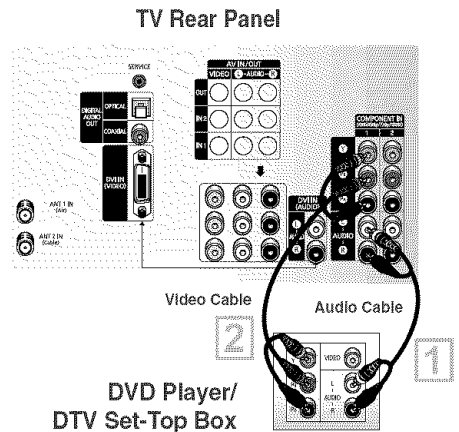

Connecting to Regular Audio and Video Jacks

1
Connect a set of audio cables between the “AV IN 1 (L, R)” (or “AV IN 2 (L, R)”) jacks on the TV and the AUDIO OUT jacks on the DVD player (or DTV Set-Top Box).

2
Connect a video cable between the “AV IN 1 (VIDEO)” (or “AV IN 2 (VIDEO)”) jack on the TV and the VIDEO OUT jack on the DVD player (or DTV Set-Top Box).

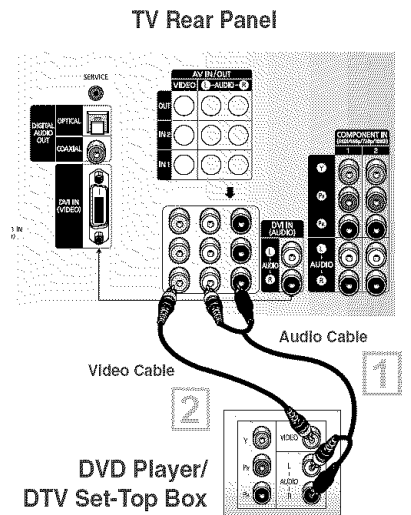

- Also, you can connect to “AV 3” on the side panel of TV.

Connecting a Digital TV Set-Top Box

Connecting to DVI (Digital Visual Interface)

By inputting a high-bandwidth Digital Content Protection high-definition picture source to the DVI INPUT jack on the TV, high-definition pictures can be displayed on the screen in their digital form.

1

Connect a set of audio cables between the "DVI IN (AUDIO) (L, R)" jacks on the TV and the AUDIO OUT jacks on the Set-Top Box.

2

Connect a video cable between the "DVI IN (VIDEO)" jack on the TV and the VIDEO OUT jack on the Set-Top Box.

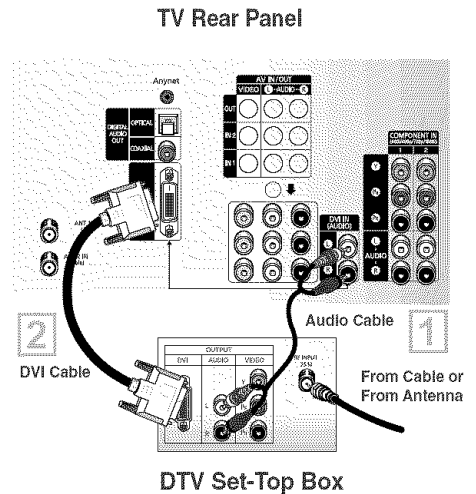

Notes

- The DVI INPUT jack is not compatible with the picture signal of a personal computer.
- Use a DVI 25-pin cable (commercially available) in order to digitally connect the TV with a DTV decoder.

Connecting a Digital Audio System

There are many types of digital audio systems on the market today.

A simplified illustration of an audio system is shown below. For more information, see your audio system owner's manual.

1

If your audio system has a coaxial digital audio input, connect to the "COAXIAL OUT" jack on the TV.

2

If your audio system has an optical digital audio input, connect to the "OPTICAL OUT" jack on the TV.

Be certain to remove the black cover from the optical output before inserting the cable.

3

If your system has both coaxial and optical digital audio inputs, SAMSUNG recommends you use the optical digital output on the TV.

Do not connect both optical and coaxial cables. This may damage your audio system.

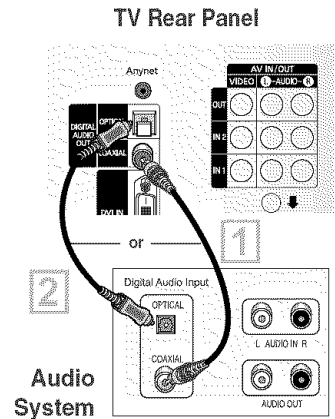

- **OPTICAL:** Converts the electric signal into an optical light signal, and transmits it through glass fibers. A transmission system of digital audio in the form of a light wave, S/PDIF format using a glass conductor.
- **COAXIAL:** The digital audio signal is received through a coaxial copper cable.

Connecting to an Analog Amplifier

1

The "AUDIO OUT" terminals cannot be used for external speakers. You must hook them up to an amplifier.

When an audio amplifier is connected to the "AUDIO OUT" terminals: Decrease the gain (volume) of the audio amplifier, and adjust the volume level with the volume control on the TV.

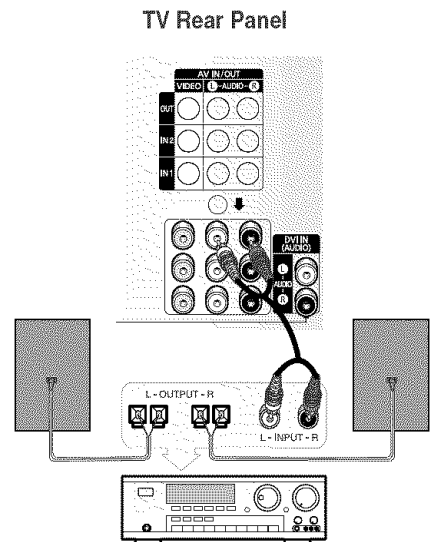

Installing Batteries in the Remote Control

1
Slide the back cover all the way out to open the battery compartment of the remote control.

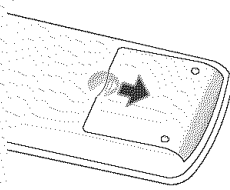

2
Install two AAA size batteries.

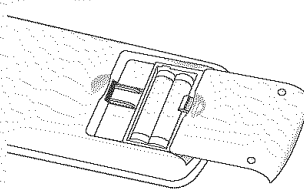

3
Replace the cover.

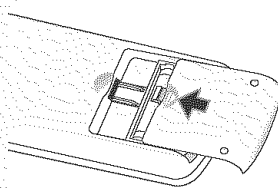

◀ Make sure to match the “+” and “-” ends of the batteries with the diagram inside the compartment.

◀ Do not mix battery types, i.e. alkaline and manganese.

◀ Remove the batteries and store them in a cool, dry place if you won't be using the remote control for a long time. (Assuming typical TV usage, the batteries last for about one year.)

The remote control can be used up to about 23 feet from the TV.

Chapter Three

OPERATION

Turning the TV On and Off

Press the **POWER** button.

You can also use the **POWER** button on the front panel.

Plug & Play Feature

When the TV is initially powered On, basic customer settings proceed automatically and subsequently: Setting the language, Antenna input check, Channel Memorize and Time Setting.

Note : The Plug & Play function operates after plugging in the TV for the first time.

1

Press the **POWER** button on the remote control.

The message "Menu language, channels and Time will be set." is displayed.

Press the **ENTER** button, then "Select the language of the OSD" is automatically displayed.



◀ Plug & Play feature doesn't work when in the AV mode.

2

Press the **ENTER** button to enter the language.

Press the **▲** or **▼** button to select language, then the **ENTER** button.

"Select the antennas to memorize." is automatically displayed.

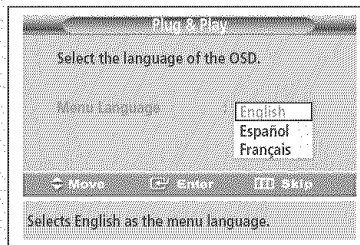

3

Press the **▲** or **▼** button to memorize the channels of the selected connection.

Press the **ENTER** button to select "Start".

When selecting Cable TV :

Press the **▲** or **▼** button to select "Cable", then press the **ENTER** button.

Press the **▲** or **▼** button to select "STD", "HRC", or "IRC", then press the **ENTER** button.

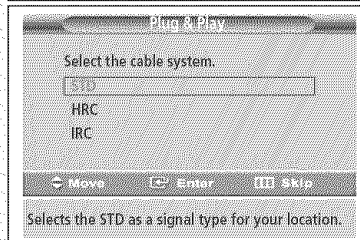
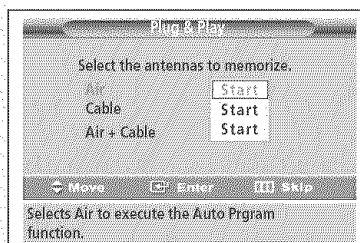

4

The TV will begin memorizing all of the available channels.

After all the available channels are stored, the "Auto Program" menu reappears. Press the **MENU** button when channel memorization is complete.

"Set to daylight savings time." is automatically displayed.

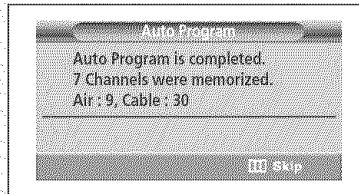
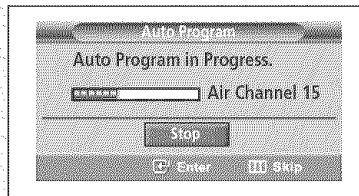

5

Press the **ENTER** button. Press the **▲** or **▼** button to select "Off" or "On", then the **ENTER** button.

"Select your time zone in which you live." is automatically displayed.

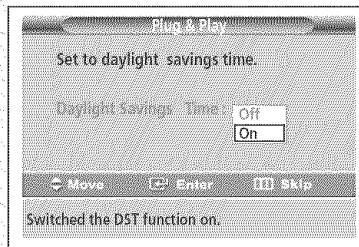

6

Press the **▲** or **▼** button to highlight the time zone for your local area (and to move the highlight to the appropriate time zone on the map of the United States). Press the **ENTER** button.

That's it. If you have received a digital signal, the time will be set automatically. If not, see page 46 to set the clock.

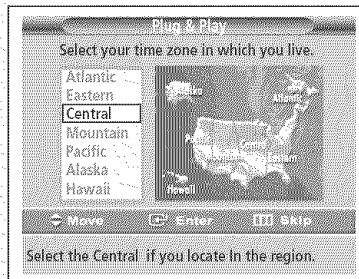

7

The message "Completed. Time will be updated automatically." is displayed. When you have finished, press the **ENTER** button.



Adjusting the Screen Automatically (Self Focus)

The “Self Focus” feature automatically sets the optimum picture quality when blurring, overlapping colors or incorrect focus occurs. These conditions may be caused by moving your TV.

1

Press the **MENU** button.

Press the **▲** or **▼** button to select “Picture”, then press the **ENTER** button.

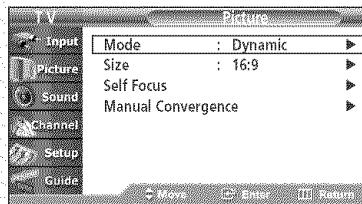

2

Press the **▲** or **▼** button to select “Self Focus”, then press the **ENTER** button. “Self Focus” is selected.

Press the **ENTER** button again.

The self focus process begins with the message “Self Focus” and horizontal bar displayed.

When it is finished, the displays will disappear and the optimum picture quality can be enjoyed.

Press the **EXIT** button to exit.

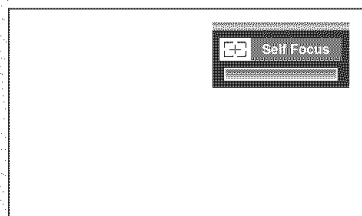
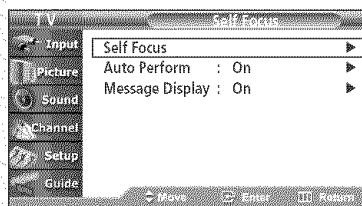

Alternate method:

Simply press the **SELF FOCUS** button on the remote control to enjoy the optimum picture quality.

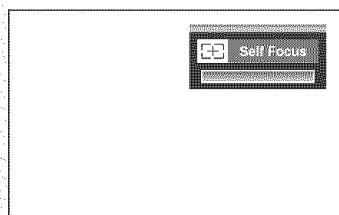

◀ During the process, minor distortions of the picture may occur. At this time, the colors may diffuse and a searching pattern will appear on the edges of the screen. This is a normal part of the adjustment.

- Changing channels and any other signal changes will pause the self focus until a stable signal has returned. It resumes after the signal has been stabilized. This feature will not work without a signal.
- Ambient light that is too bright may affect the self focus. If this occurs, darken the environment and try again.

Deactivating the Automatic Execution of the Self Focus

Once set, the “Self Focus” feature starts on default. It will automatically begin 10 minutes after switching on the power and the appearance of the screen image. To set the optimum picture quality, the “Self Focus” will automatically begin again after another 30 minutes, as the screen image is then fully stabilized.

1

Press the **MENU** button.

Press the **▲** or **▼** button to select “Picture”, then press the **ENTER** button.

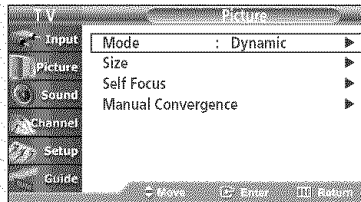

2

Press the **▲** or **▼** button to select “Self Focus”, then press the **ENTER** button.

Press the **▲** or **▼** button to select “Auto Perform”, then press the **ENTER** button.

To turn off the automatic execution of the self focus feature, select “Off” by pressing the **▲** or **▼** button, then press the **ENTER** button.

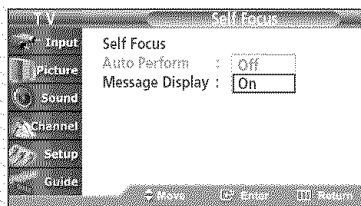

Removing the “Self Focus” Message from the Display

3

Press the **▲** or **▼** button to select “Message Display”, then press the **ENTER** button.

To remove the message “Self Focus” and horizontal bar on the screen during the self focus process, select “Off” by pressing the **▲** or **▼** button, then press the **ENTER** button.

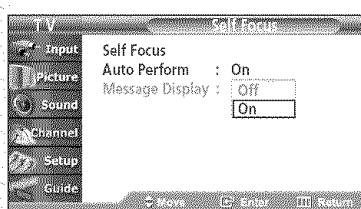

Adjusting Convergence Manually

If the color appears spread out or “smeared” on the screen, the convergence probably needs alignment. Be sure to use the remote control for the convergence adjustments.

First steps:

1

Press the **MENU** button.

Press the **▲** or **▼** button to select “Picture”, then press the **ENTER** button.

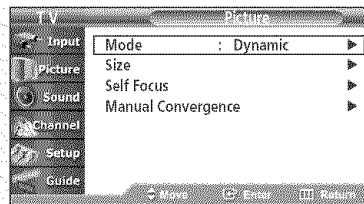

2

Press the **▲** or **▼** button to select “Manual Convergence”, then press the **ENTER** button.

Press the **▲** or **▼** button to select “Red” or “Blue”.

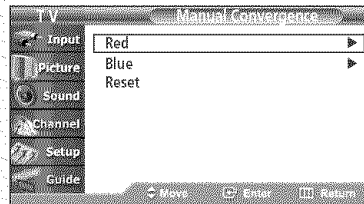
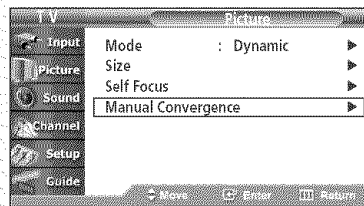

continued...

3

Press the **ENTER** button. A crosshatch pattern will appear on the screen. Move the cursor to the position you want to adjust by pressing the ▲/▼/◀/▶ buttons, then press the **ENTER** button. Adjust the convergence by pressing the ▲/▼/◀/▶ buttons, then press the **ENTER** button.

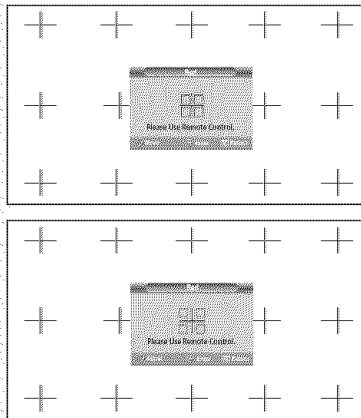

4

If a horizontal line is visible, use the ▲ or ▼ button to move the line so that it is superimposed on the horizontal center-line (i.e., make a single horizontal line that is as white as possible.).

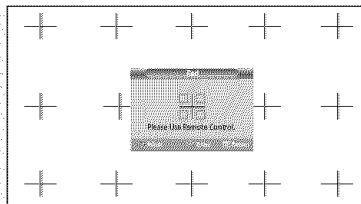

5

If a vertical line is visible, use the ◀ or ▶ button to move the line so that it is superimposed on the vertical-center line (i.e., make a single vertical line that is as white as possible.)

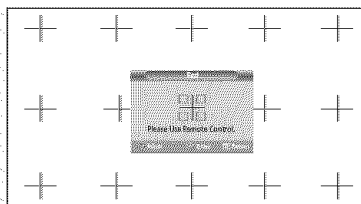

After the convergence is correctly adjusted, press the **MENU** button to exit.

6

To return to the factory defaults, select "Reset" by pressing the ▲ or ▼ button, then press the **ENTER** button. The previously adjusted convergence will be reset to the factory defaults.

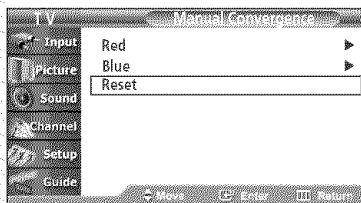

Viewing the Menus and On-Screen Displays

Viewing the Menus

1

With the power on, press the **MENU** button.

The "Input" menu appears on the screen. Its left side has six icons: Input, Picture, Sound, Channel, Setup and Guide.

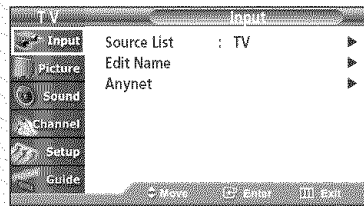

2

Press the **▲** or **▼** button to move to items in the menu (The icon is selected). Press the **◀** or **▶** button to display, change or use the selected items. Press the **ENTER** button to enter items in the menu.

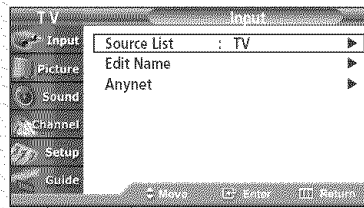

◀ You can also use the **MENU**, **CH▲/▼**, **VOL+/-**, and **ENTER** buttons on the control panel of the TV to make selections.

3

Press the **EXIT** button to exit.

Viewing the Display

The display identifies the current channel and the status of certain audio-video settings.

Press the **INFO** button on the remote control. The TV displays the current channel, the status of certain picture and sound settings and the current time.

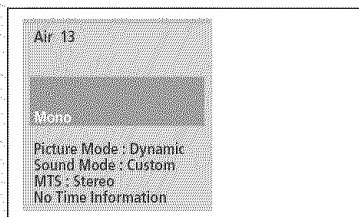

Selecting a Menu Language

1

Press the **MENU** button.

Press the **▲** or **▼** button to select "Setup", then press the **ENTER** button.

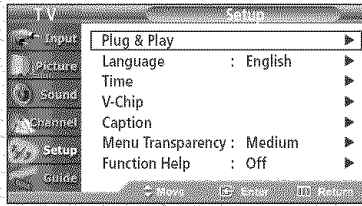

2

Press the **▲** or **▼** button to select "Language", then press the **ENTER** button.

Press the **▲** or **▼** button to select "English", "Spanish" or "French", then press the **ENTER** button.

Press the **EXIT** button to exit.

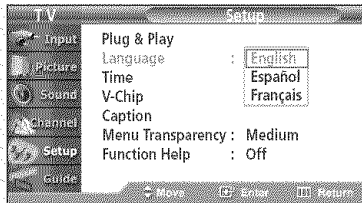

Selecting the Antenna Input

You can connect to two different signal sources by choosing the antenna input (Air or Cable).

Press the **ANTENNA** button repeatedly to select "Air" or "Cable".

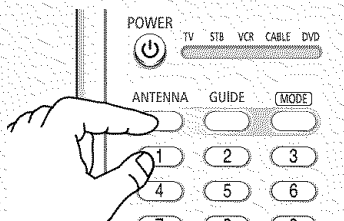

Memorizing the Channels

Your TV can memorize and store all of the available channels for both “off-air” (antenna) and cable channels. After the available channels are memorized, use the **CH**▲ and **CH**▼ buttons to scan through the channels. This eliminates the need to change channels by entering the channel digits. There are three steps for memorizing channels: selecting a broadcast source, memorizing the channels (automatic) and adding and deleting channels (manual).

Selecting the Video Signal Source

Before your television can begin memorizing the available channels, you must specify the type of signal source that is connected to the TV (i.e., an antenna or a cable system).

1

Press the **MENU** button.

Press the ▲ or ▼ button to select “Channel”, then press the **ENTER** button.



2

Press the **ENTER** button to select “Antenna”.

Press the ▲ or ▼ button to select “Air” or “Cable”, then press the **ENTER** button.

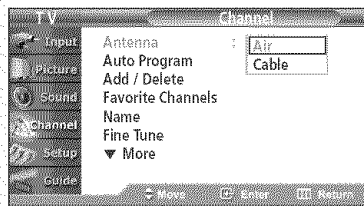

3

Press the ▲ or ▼ button to select “Auto Program”, then press the **ENTER** button.

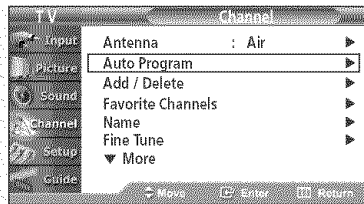

continued...

4

Press the ▲ or ▼ button to select the antenna connection, then press the **ENTER** button.

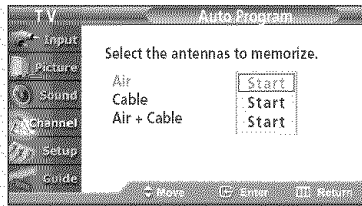

When selecting Cable TV system: Press the ▲ or ▼ button to select "Cable", then press the **ENTER** button. Press the ▲ or ▼ button to select "STD", "HRC" or "IRC", then press the **ENTER** button.

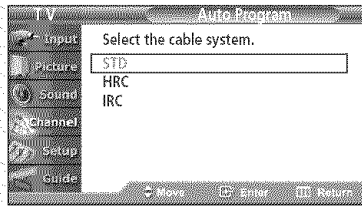
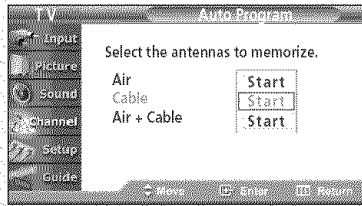

- ◀ Air : "Air" antenna signal
- Cable : "Cable" antenna signal
- Air+Cable : "Air" and "Cable" antenna signals

- ◀ STD, HRC and IRC identify various types of cable TV systems. Contact your local cable company to identify the type of cable system that exists in your particular area. At this point the signal source has been selected. Proceed to "Storing Channels in Memory".

Storing Channels in Memory

5

Press the ▲ or ▼ button to select the antennas to memorize. Press the **ENTER** button to select "Start".

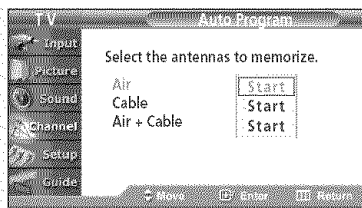

6

Press the **ENTER** button to start the auto program. The TV begins memorizing all available channels. Press the **ENTER** button at any time to interrupt the memorization process.

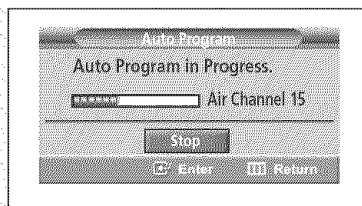

Press the **EXIT** button to exit.

- ◀ The TV must be connected to an antenna in order to receive digital TV signals. Even if a particular channel is deleted from memory, you can always tune to that channel directly by using the number buttons on the remote control.

- All available DTV and analog channels are automatically stored in memory when channels are selected by the direct tuning function.

Adding and Erasing Channels

To add channels that were not memorized (or to delete unwanted channels from memory):

1

Press the **MENU** button.

Press the **▲** or **▼** button to select "Channel", then press the **ENTER** button.



2

Press the **▲** or **▼** button to select "Add/Delete", then press the **ENTER** button.

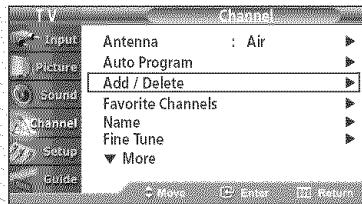

3

Repeatedly pressing the **ENTER** button will alternate between add channel and delete channel. Press the **CH▲** or **CH▼** button to switch to the appropriate channel, then repeat above.

Press the **EXIT** button to exit.



<Add channel>

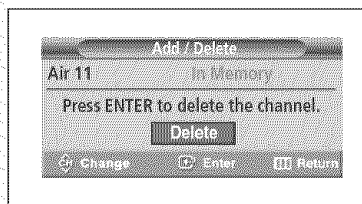

<Delete channel>

Alternate method:

Simply press the **ADD/DEL** and **ENTER** buttons on the remote control to add channels that were not memorized or to delete unwanted channels from memory.

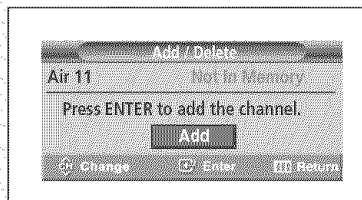

Changing Channels

Using the Channel Buttons

Press the **CH \wedge** or **CH \vee** button to change channels.

When you press the **CH \wedge** or **CH \vee** button, the TV changes channels in sequence. You will see all the channels that the TV has memorized. (The TV must have memorized at least three channels.) You will not see channels that were either erased or not memorized.

Using the Number Buttons

Use the number buttons to quickly tune to any channel.

Press the number buttons to go directly to a channel.

For example, to select channel 27, press “2,” then “7.”

The TV will change channels when you press the second number.

Using the “-” Button

The “-” button is used to select channels that broadcast both a digital and analog signal.

For example, for Channel 7 (digital), press “7”, then “-”, then “1” and you will see as left.

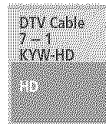

DTV Cable
7 - 1
KYW-HD
HD

For channel 7-2 (analog), press “7”, then “-”, then “2” and you will see as left.

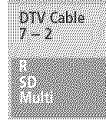

DTV Cable
7 - 2
R
SD
Multi

Note

- HD indicates the TV is receiving a digital High Definition signal. SD indicates the TV is receiving a analog Standard Definition signal.

Using the Previous Channel

Press the **PRE-CH** button.
The TV changes to the last channel you were watching.

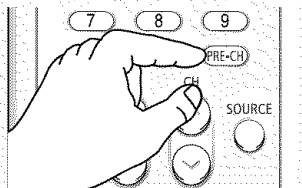

Selecting Your Favorite Channels

You can store of your favorite channels for each available input source (such as TV and CATV). Then, when you press the **FAV.CH** button on the remote control, the TV displays only the favorite channels you previously stored, allowing you to quickly and easily find frequently watched channels.

To Store Your Favorite Channels:

1

Press the **MENU** button.

Press the **▲** or **▼** button to select "Channel", then press the **ENTER** button.



2

Press the **▲** or **▼** button to select "Favorite Channels", then press the **ENTER** button.

Press the **▲** or **▼** button to select a channel as a favorite channel, then press the **ENTER** button. Press the **ENTER** button again to deselect the selected channel.

Press the **EXIT** button to exit.

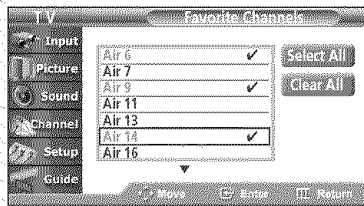

- ◀ Only memorized channels can be set as Favorite channels.
- ◀ Select All : Press to select all channels.
- Clear All : Press to clear all channels.

To View Your Favorite Channels:

Press the **FAV.CH** button on the remote control repeatedly to jump from one favorite channel to another.

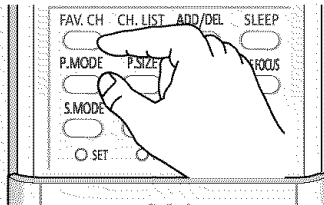

Labeling the Channels

Use this feature to assign an easy-to-remember label to any channel (i.e., “CBS”, “ESPN”, “PBS2”, CNN1”, etc.) A label consists of five fields, where each field is a letter, a number or a blank. When the INFO button is pressed, the channel label will appear next to the channel number.

1

Press the **MENU** button.

Press the ▲ or ▼ button to select “Channel”, then press the **ENTER** button.

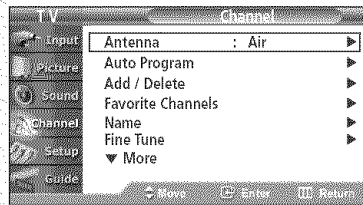

2

Press the ▲ or ▼ button to select “Name”, then press the **ENTER** button.

Press the ▲ or ▼ button to select the channel to be assigned to a new name, then press the **ENTER** button.

Press the ▲ or ▼ button to select a letter, a number or a blank. (Results in this sequence: A..Z, 0..9, +, -, *, /, blank).

Press the ► button to switch to the next field, which will be selected. Select a second letter or digit by pressing the ▲ or ▼ button, as above.

Repeat the process to select the last three digits. When you have finished, select “OK”, then press the **ENTER** button to assign the new name.

Press the **EXIT** button to exit.

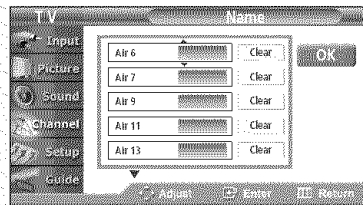
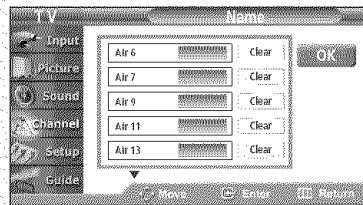
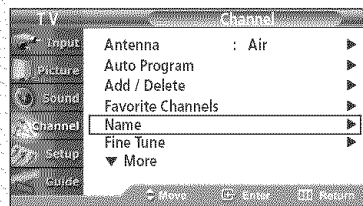

◀ If you add or delete the TV channel, the corresponding label information will also be added or deleted.

Viewing the Channel Lists

You can display a list of all channels or your favorite channels.

1

Press the **MENU** button.

Press the **▲** or **▼** button to select "Channel", then press the **ENTER** button.



2

Press the **▲** or **▼** button to select "Channel List", then press the **ENTER** button.



3

Press the **▲** or **▼** button to select "All" or "Favorite", then press the **ENTER** button.

To toggle between your favorite channels or all channels, use the yellow button.



Alternate method:

Press the **CH.LIST** button on the remote control to display a list of channels.

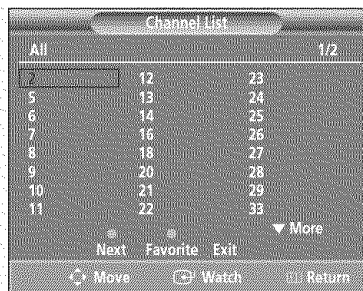

◀ **Red button:**
Press to display the previous channel list page.

Green button:
Press to display the next channel list page.

Yellow button:
Press to toggle between your favorite channels or all channels

Blue or EXIT button:
Press to exit.

Editing the Channel Lists

You can edit a list of your channels.

1

Press the **MENU** button.

Press the **▲** or **▼** button to select "Channel", then press the **ENTER** button.

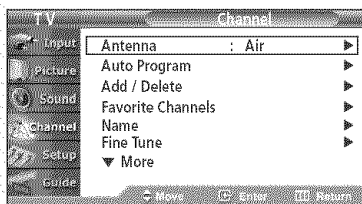

2

Press the **▲** or **▼** button to select "Channel List", then press the **ENTER** button.

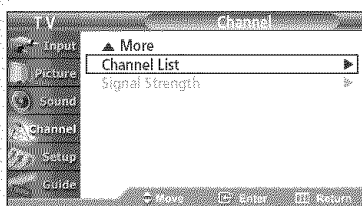

3

Press the **▲** or **▼** button to select "Edit", then press the **ENTER** button.

Press the **▲/▼/◀/▶** buttons to select a channel to be deleted or added, then press the **ENTER** button.

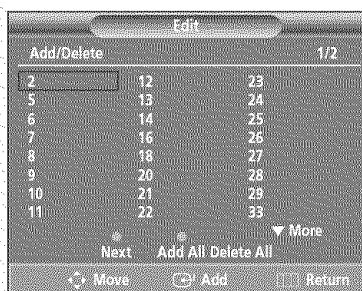
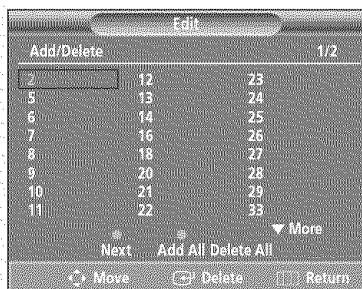

◀ **Red button:**
Press to display the previous channel list page.

Green button:
Press to display the next channel list page.

Yellow button:
Press to add all deleted channels back into the channel list.

Blue button:
Press to delete all channels.

Picture Control

You can select the type of picture which best corresponds to your viewing requirements.

Using Automatic Picture Settings

Your TV has automatic picture settings (“Dynamic”, “Standard”, and “Movie”) that are preset at the factory. You can activate either Dynamic, Standard, or Movie by making a selection from the menu. Or, you can select “Custom” which automatically recalls your personalized picture settings.

1

Press the **MENU** button.

Press the **▲** or **▼** button to select “Picture”, then press the **ENTER** button.

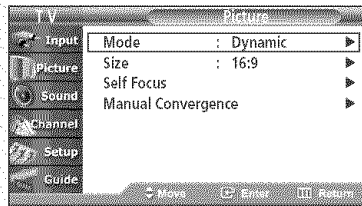

2

Press the **ENTER** button to select “Mode”.

Press the **ENTER** button again.

Press the **▲** or **▼** button to select a particular item, then press the **ENTER** button.

Press the **EXIT** button to exit.

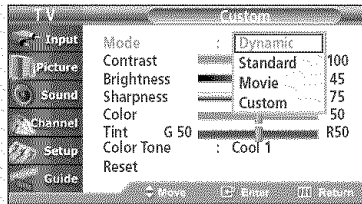

Alternate method:

Simply press the **P.MODE** button on the remote control repeatedly to select one of the standard picture settings.

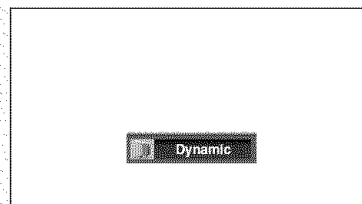

- Choose “Dynamic” for viewing the TV during the day or when there is bright light in the room.
- Choose “Standard” for the standard factory settings.
- Choose “Movie” when viewing the movie.
- Choose “Custom” if you want to adjust the settings according to personal preference.

Customizing the Picture

You can use the on-screen menus to change the “Contrast”, “Brightness”, “Sharpness”, “Color”, “Tint”, and “Color Tone” according to personal preference.

1

Press the **MENU** button.

Press the **▲** or **▼** button to select “Picture”, then press the **ENTER** button.

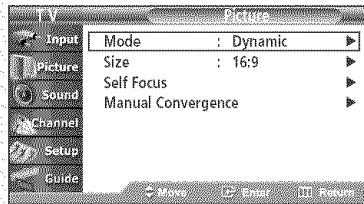

2

Press the **ENTER** button to select “Mode”.

Press the **ENTER** button again.

Press the **▲** or **▼** button to select a particular item (“Dynamic”, “Standard”, “Movie, or “Custom”), then press the **ENTER** button.

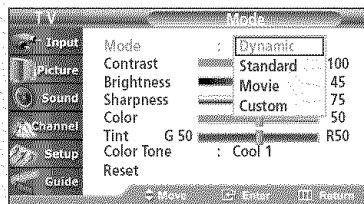

3

Press the **▲** or **▼** button to select a particular item (“Contrast”, “Brightness”, “Sharpness”, “Color”, or “Tint”), then press the **ENTER** button.

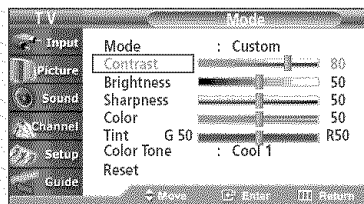

4

Press the **ENTER** button.

Press the **◀** or **▶** button to increase or decrease the value of a particular item.

Press the **▲** or **▼** button to select other items.

When you have finished, press the **ENTER** button.



continued...

5

Press the ▲ or ▼ button to select "Color Tone", then press the ENTER button.

Press the ◀ or ▶ button to increase or decrease the value of the color tone ("Warm 10~1", "Normal", and "Cool 1~10").

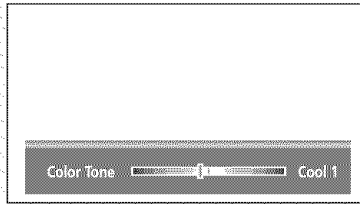

Resetting the Picture Settings to the Factory Defaults

6

Press the ▲ or ▼ button to select "Reset", then press the ENTER button.

The reset function is set for each mode ("Dynamic", "Standard", "Movie", or "Custom").

The previously adjusted settings will be reset to the factory defaults.

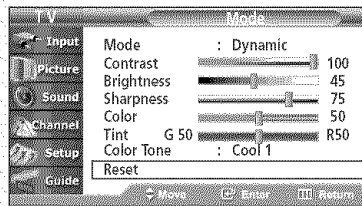

Sound Control

Adjusting the Volume

Press the **VOL +** or **VOL -** buttons to increase or decrease the volume.

Using the MUTE Button

At any time, you can temporarily cut off the sound using the MUTE button.

1

Press the **MUTE** button and the sound cuts off. "Mute" is displayed.

2

To turn mute off, press the **MUTE** button again, or press either the **VOL -** or **VOL +** button.

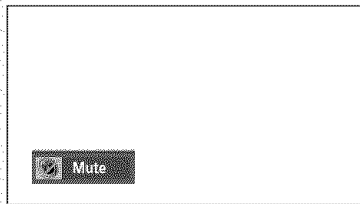

Customizing the Sound

The sound settings can be adjusted to suit your personal preferences. (Alternatively, you can use one of the "automatic" settings. See next page.)

1

Press the **MENU** button.

Press the **▲** or **▼** button to select "Sound", then press the **ENTER** button.

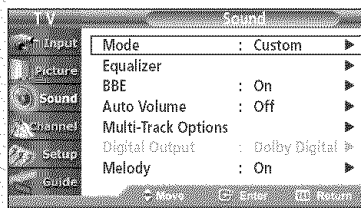

2

Press the **▲** or **▼** button to select "Equalizer", then press the **ENTER** button.

Press the **◀** or **▶** button to select a particular frequency to adjust.

Press the **▲** or **▼** button to increase or decrease the level of the particular frequency.

Press the **EXIT** button to exit.

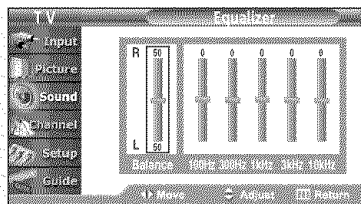

Using Automatic Sound Settings

Your TV has automatic sound settings (“Standard”, “Music”, “Movie”, and “Speech”) that are preset at the factory. You can activate either Standard, Music, Movie or Speech by making a selection from the menu. Or, you can select “Custom,” which automatically recalls your personalized sound settings.

1

Press the **MENU** button.

Press the **▲** or **▼** button to select “Sound”, then press the **ENTER** button.

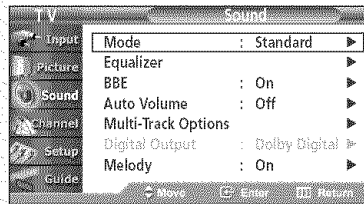

2

Press the **ENTER** button to select “Mode”.

Press the **▲** or **▼** button to select a particular item, then press the **ENTER** button.

Press the **EXIT** button to exit.

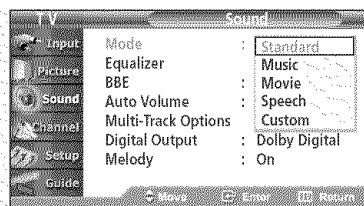

Alternate method:

Press the **S.MODE** button on the remote control repeatedly to select one of the standard sound settings.

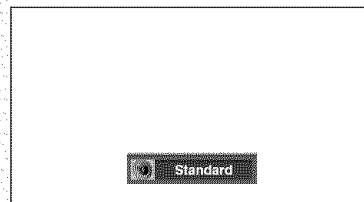

- Choose “Standard” for the standard factory settings.
- Choose “Music” when watching music videos or concerts.
- Choose “Movie” when watching movies.
- Choose “Speech” when watching a show that is mostly dialog (i.e., news).
- Choose “Custom” to recall your personalized settings.

Setting the Clock

Setting the clock is necessary in order to use the various timer features of the TV. Also, you can check the time while watching the TV. (Just press the **INFO** button.)

Option 1: Setting the Clock Manually

1

Press the **MENU** button.

Press the **▲** or **▼** button to select "Setup", then press the **ENTER** button.

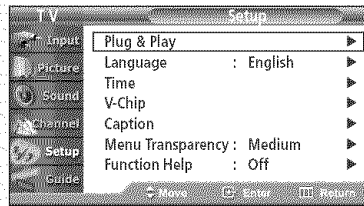

2

Press the **▲** or **▼** button to select "Time", then press the **ENTER** button.

Press the **ENTER** button to select "Clock".

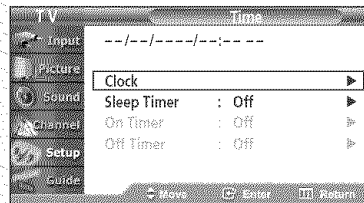

3

Press the **ENTER** button to select "Clock Mode".

Press the **▲** or **▼** button to select "Manual", then press the **ENTER** button.

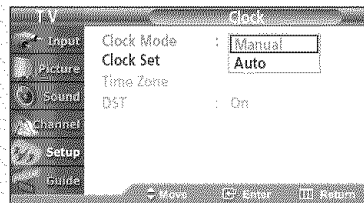

4

Press the **▲** or **▼** button to select "Clock Set", then press the **ENTER** button.

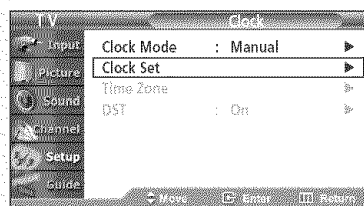

5

Press the **◀** or **▶** button to move to "Month", "Day", "Year", "Hour", "Minute", or "am/pm".

Set the date and time you want by pressing the **▲** or **▼** button, then press the **ENTER** button.

Press the **EXIT** button to exit.

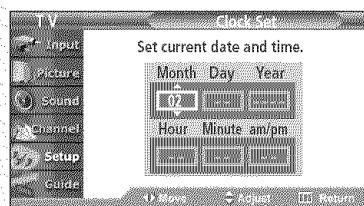

◀ The current time will appear every time you press the **INFO** button.

◀ You can set the Month, Day, Year, Hour, and Minute directly by pressing the number buttons on the remote control.

Option 2: Setting the Clock Automatically

The Clock can be set automatically if you are receiving a digital signal.

1
Press the **MENU** button.

Press the **▲** or **▼** button to select "Setup", then press the **ENTER** button.

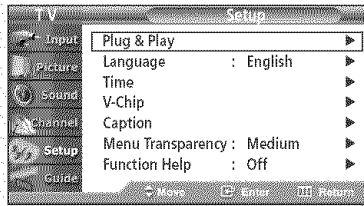

2
Press the **▲** or **▼** button to select "Time", then press the **ENTER** button.

Press the **ENTER** button to select "Clock".

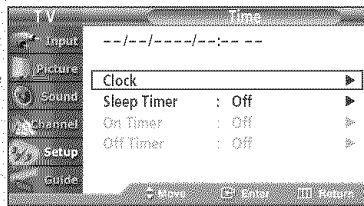

3
Press the **ENTER** button to select "Clock Mode".
Press the **▲** or **▼** button to select "Auto", then press the **ENTER** button.

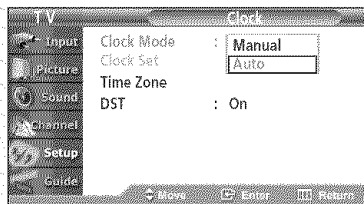

4
Press the **▲** or **▼** button to select "Time Zone", then press the **ENTER** button.

Press the **▲** or **▼** button to highlight the time zone for your local area (and to move the highlight to the appropriate time zone on the map of the United States), then press the **ENTER** button.

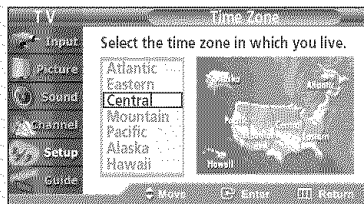

5
Press the **▲** or **▼** button to select "DST" (Daylight Saving Time), then press the **ENTER** button.
Press the **▲** or **▼** button to select "Off" or "On", then press the **ENTER** button.

Press the **EXIT** button to exit.

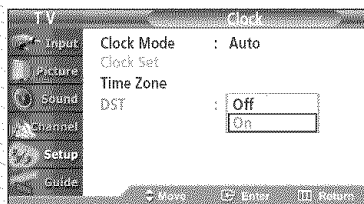

◀ The set time can be changed according to the broadcasting station and signal when you set up Auto Time. If there is a difference between the real time and set time, please set up manual time.

Viewing an External Signal Source

Use the remote control to switch between viewing signals from connected equipment, such as VCRs, DVD, Set-Top box, and the TV source (broadcast or cable).

Setting the Signal Source

1

Press the **MENU** button.

Press the **ENTER** button to select "Input".

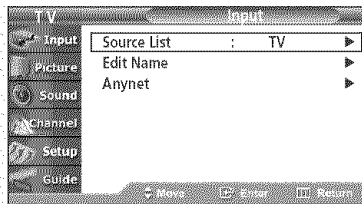

2

Press the **ENTER** button to select "Source List".

Press the **▲** or **▼** button to select signal source, then press the **ENTER** button

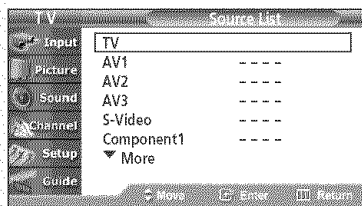

Alternate method:

Press the **SOURCE** button on the remote control repeatedly to select an external signal source.

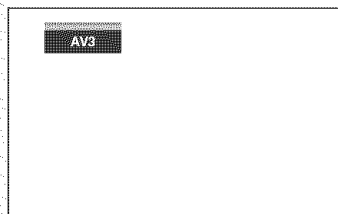

◀ When you connect equipment to the TV, you can choose between the following sets of jacks : AV1, AV2, Component1, Component2, or DVI on the TV's rear panel, and AV3 or S-Video on the TV's side panel.

Assigning Names to External input mode

1

Press the **MENU** button.

Press the **ENTER** button to select "Input".

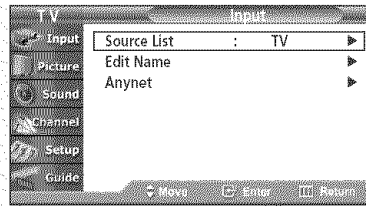

2

Press the **▲** or **▼** button to select "Edit Name", then press the **ENTER** button.

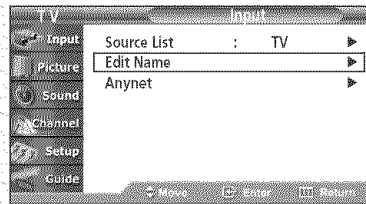

3

Press the **▲** or **▼** button to select the signal source to edit, then press the **ENTER** button.

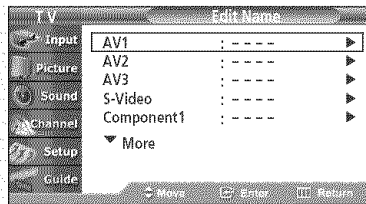

4

Press the **▲** or **▼** button to select the external device (VCR, DVD, D-VHS, Cable STB, HD STB, Satellite STB, PVR STB, AV Receiver, DVD Receiver, Game, Camcorder, DVD Combo, PC, VOD STB, TV). Press the **ENTER** button.

Set other signal sources (AV2, AV3, S-Video, Component1, Component2, DVI) using the same method as listed above.

Press the **EXIT** button to exit.

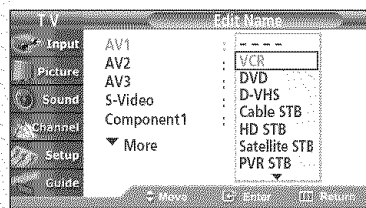

Chapter Four

SPECIAL FEATURES

Analog Fine Tuning Analog Channels

The Fine Tuning function lets you manually adjust the TV's tuner if you have difficulty tuning analog channels.

1

Press the **MENU** button.

Press the **▲** or **▼** button to select "Channel", then press the **ENTER** button.

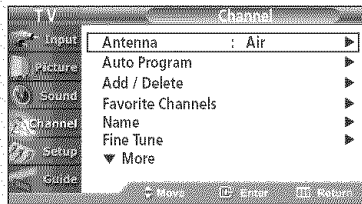

2

Press the **▲** or **▼** button to select "Fine Tune", then press the **ENTER** button.

Press the **◀** or **▶** button to adjust the fine tuning. To store the fine tuning setting in the TV's memory, press the **ENTER** button.

To reset the fine tuning to "0", press the **▲** or **▼** button to select "Reset", then press the **ENTER** button.

Press the **EXIT** button to exit.

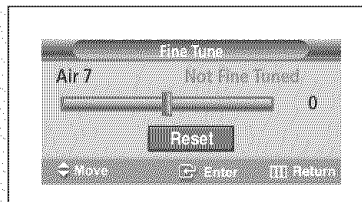
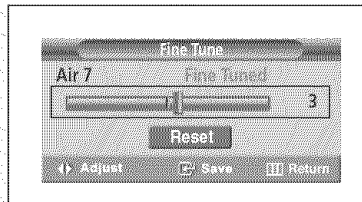

Note

- Only analog TV channels can be fine tuned.

Digital Checking the Digital-Signal Strength

Unlike analog channels, which can vary in reception quality from “snowy” to clear, digital (HDTV) channels have either perfect reception quality or you will not receive them at all. So, unlike analog channels, you cannot fine tune a digital channel.

You can, however, adjust your antenna to improve the reception of available digital channels.

1

Press the **MENU** button.

Press the **▲** or **▼** button to select “Channel”, then press the **ENTER** button.

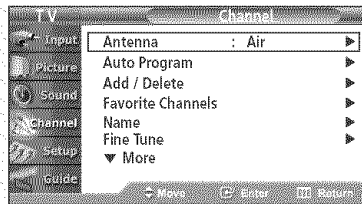

2

Press the **▲** or **▼** button to select “Signal Strength”, then press the **ENTER** button.

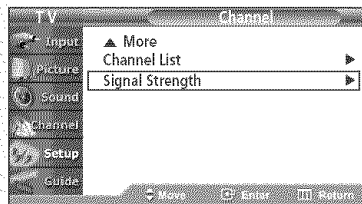

If the signal strength meter indicates that the signal is weak, physically adjust your antenna to increase the signal strength. Continue to adjust the antenna until you find the best position with the strongest signal.

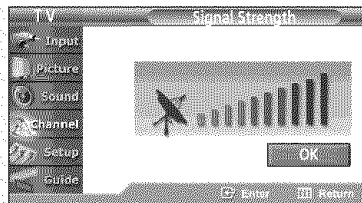

Press the **EXIT** button to exit.

Changing the Screen Size

1
Press the **MENU** button.

Press the **▲** or **▼** button to select "Picture", then press the **ENTER** button.

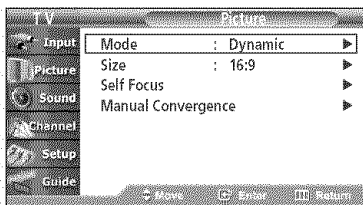

2
Press the **▲** or **▼** button to select "Size", then press the **ENTER** button.

Press the **◀** or **▶** button to select the screen format you want.

Press the **EXIT** button to exit.

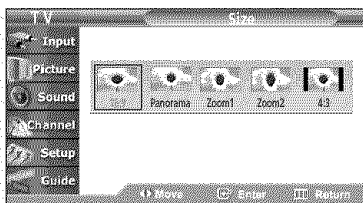

◀ In the "Zoom1" and "Zoom2" modes, lifting is available by pressing the **▲** or **▼** button.

◀ Changing the Screen Format feature availability depends on the current broadcasting signal format.

◀ The "16:9" and "4:3" modes are available in DTV mode.

Alternate method:

Press the **P.SIZE** button on the remote control repeatedly to select one of the screen format you want.

Viewing with a 4:3 signal (When a 4:3 signal is received)

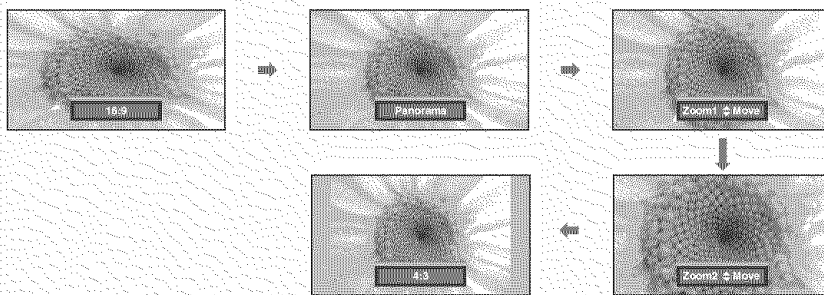

Viewing with a 16:9 signal (When a 16:9 signal is received)

The illustrations below show the change of picture while viewing a DVD title.

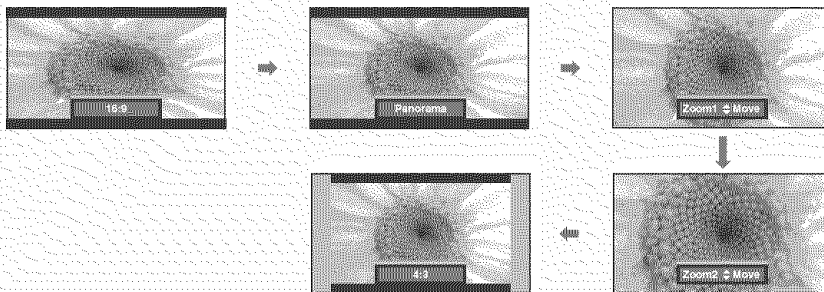

BBE

BBE is a built-in effect that adds clarity, punch and dynamics to the sound.

1

Press the **MENU** button.

Press the **▲** or **▼** button to select "Sound", then press the **ENTER** button.

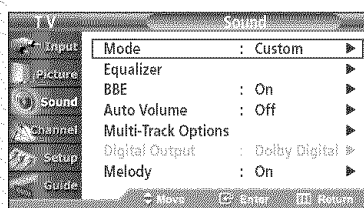

2

Press the **▲** or **▼** button to select "BBE", then press the **ENTER** button.

Press the **▲** or **▼** button to select "On" or "Off", then press the **ENTER** button.

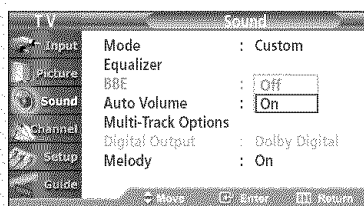

Press the **EXIT** button to exit.

Alternate method:

Press the **BBE** button on the remote control repeatedly to select "On" or "Off".

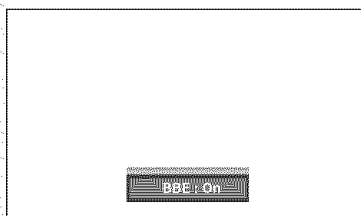

Auto Volume

Each broadcasting station has its own signal conditions, and it is inconvenient to adjust the volume every time the channel is changed. “Auto Volume” automatically adjusts the volume of the desired channel by lowering the sound output when the modulation signal is high or by raising the sound output when the modulation signal is low.

1

Press the **MENU** button.

Press the **▲** or **▼** button to select “Sound”, then press the **ENTER** button.

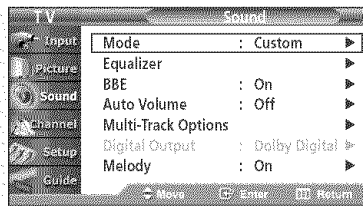

2

Press the **▲** or **▼** button to select “Auto Volume”, then press the **ENTER** button.

Press the **▲** or **▼** button to select “On” or “Off”, then press the **ENTER** button.

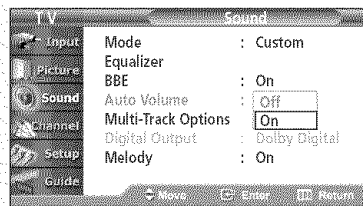

Press the **EXIT** button to exit.

Digital Choosing a Multi-Channel Sound (MTS) track

The digital-TV transmission system is capable of simultaneous transmission of many audio tracks (for example, simultaneous translations of the program into foreign languages). The availability of these additional “multitracks” depends upon the program.

1
Press the **MENU** button.

Press the **▲** or **▼** button to select “Sound”, then press the **ENTER** button.

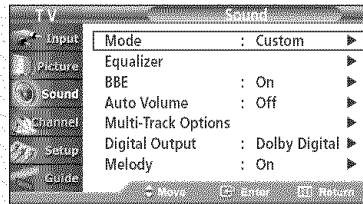

◀ Quick way to access the MTS menu: Just press the “MTS” button on the remote control. You can listen in a language other than the favorite language by pressing the MTS button.

2
Press the **▲** or **▼** button to select “Multi-Track Options”, then press the **ENTER** button.

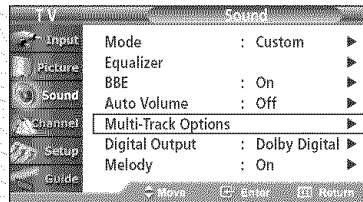

◀ The text at the bottom of the menu tells you if the incoming audio is Español, Français, or English.

3
Press the **ENTER** button to select “Preferred Language”.
Press the **▲** or **▼** button to select the language you want, then press the **ENTER** button.

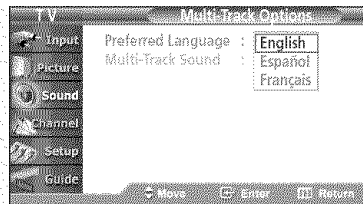

Press the **EXIT** button to exit.

Analog Choosing a Multi-Channel Sound (MTS) track

Depending on the particular program being broadcast, you can listen to Mono, Stereo, or a SAP.

1
Press the **MENU** button.

Press the **▲** or **▼** button to select "Sound", then press the **ENTER** button.

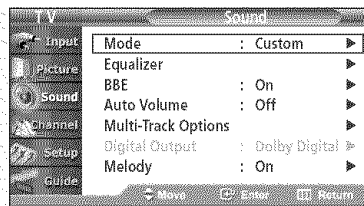

2
Press the **▲** or **▼** button to select "Multi-Track Options", then press the **ENTER** button.

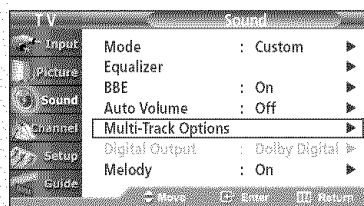

3
Press the **▲** or **▼** button to select "Multi-Track Sound", then press the **ENTER** button.
Press the **▲** or **▼** button to select a setting you want, then press the **ENTER** button.

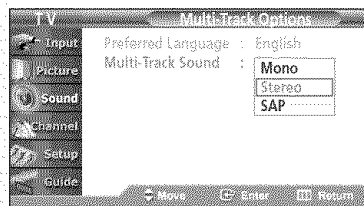

Press the **EXIT** button to exit.

Alternate method:

Press the **MTS** button on the remote control repeatedly to select one of the settings.

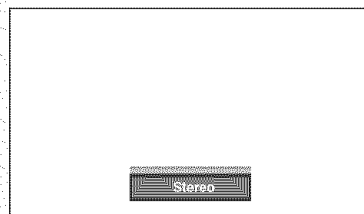

- Choose "Mono" for channels that are broadcasting in mono, or if you are having difficulty receiving a stereo signal.
- Choose "Stereo" for channels that are broadcasting in stereo.
- Choose "SAP" to listen to the Separate Audio Program, which is usually a foreign-language translation.

Digital Choosing a Digital Sound Format

Digital sound can be output from the rear-panel connectors on your TV. The digital sound is output from connectors labeled “Optical” and “Coaxial”. After connecting a digital-audio component, you must specify the transmission format (Dolby or PCM, as appropriate to your digital audio component. See your component’s owner’s manual for further details.).

1

Press the **MENU** button.
Press the **▲** or **▼** button to select “Sound”, then press the **ENTER** button.

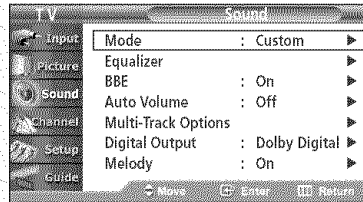

2

Press the **▲** or **▼** button to select “Digital Output”, then press the **ENTER** button.

Press the **▲** or **▼** button to select “Dolby Digital” or “PCM”, then press the **ENTER** button.

Press the **EXIT** button to exit.

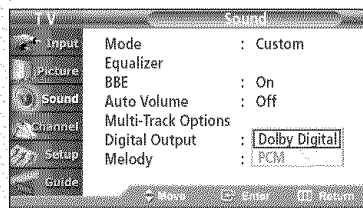

Manufactured under license from Dolby Laboratories.
“Dolby” and the double D-symbol are trademarks of Dolby Laboratories.

Setting the On/Off Melody

A melody sound can be set to come on when the TV is powered On or Off.

1

Press the **MENU** button.

Press the **▲** or **▼** button to select "Sound", then press the **ENTER** button.

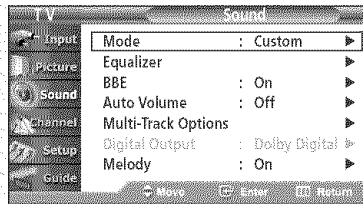

2

Press the **▲** or **▼** button to select "Melody", then press the **ENTER** button.

Press the **▲** or **▼** button to select "On" or "Off", then press the **ENTER** button.

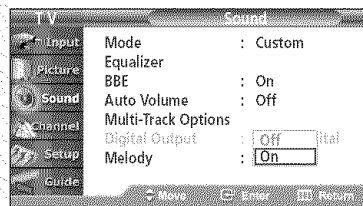

Press the **EXIT** button to exit.

Setting the On/Off Timer

1

Press the **MENU** button.

Press the **▲** or **▼** button to select "Setup", then press the **ENTER** button.

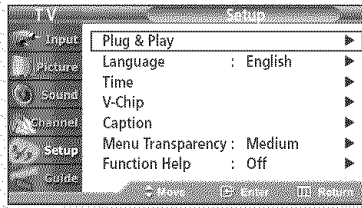

2

Press the **▲** or **▼** button to select "Time", then press the **ENTER** button.

Press the **▲** or **▼** button to select "On Timer", then press the **ENTER** button.

Press the **▲** or **▼** button to adjust "Hour", then press the **▶** button to move to the next step.

Set other items using the same method as above.

When finished, press the **MENU** button to return.

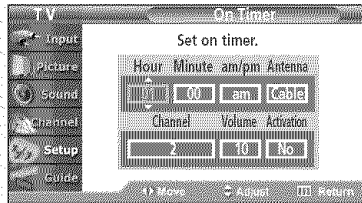
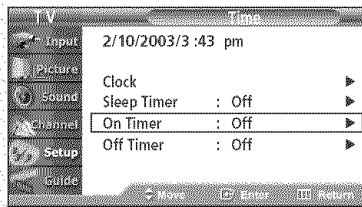

3

Press the **▲** or **▼** button to select "Off Timer", then press the **ENTER** button.

Press the **▲** or **▼** button to adjust "Hour", then press the **▶** button to move to the next step.

Set other items using the same method as above.

When finished, press the **ENTER** button.

Press the **EXIT** button to exit.

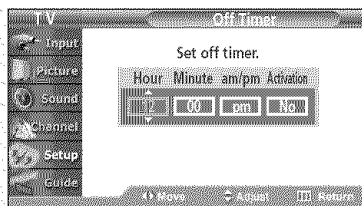

- ◀ The current time will appear every time you press the **INFO** button.
- ◀ You can set the Hour, Minute, Channel, and Volume directly by pressing the number buttons on the remote control.
- ◀ **Auto Power Off**
When you set the timer "On", the television will eventually turn off, if no controls are operated for 3 hours after the TV was turned on by timer. This function is only available in timer "On" mode and prevents overheating or leakages, which may occur if a TV is on for too long (on holiday, for example).

Setting the Sleep Timer

The sleep timer automatically shuts off the TV after a preset time (from 30 to 180 minutes).

1

Press the **MENU** button.

Press the **▲** or **▼** button to select "Setup", then press the **ENTER** button.

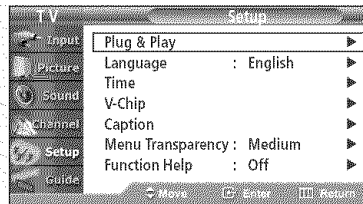

2

Press the **▲** or **▼** button to select "Time", then press the **ENTER** button.

Press the **▲** or **▼** button to select "Sleep Timer", then press the **ENTER** button.

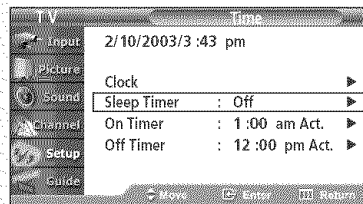

3

Press the **▲** or **▼** button to adjust "Minute".

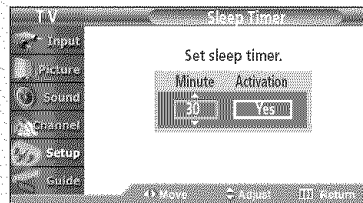

4

To cancel the set sleep timer;

Press the **▶** button to select "Activation".

Press the **▲** or **▼** button to select "No", then press the **ENTER** button.

Press the **EXIT** button to exit.

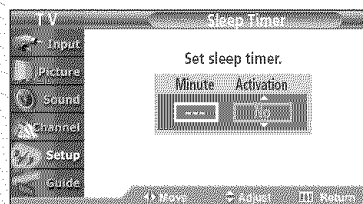

Alternate method:

Press the **SLEEP** button on the remote control repeatedly until the appropriate time interval appears (any of the preset values from "30 min" to "180 min").

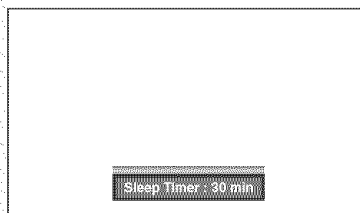

Using the V-Chip (USA)

Access to channels and programs is controlled by a password (i.e., a 4-digit secret code that is defined by the user). The on-screen menu will instruct you to assign a password (and you can change it later, if necessary).

How to Change Your Password

1
Press the **MENU** button.

Press the **▲** or **▼** button to select "Setup", then press the **ENTER** button.

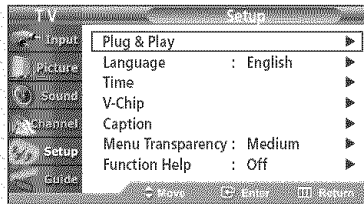

2
Press the **▲** or **▼** button to select "V-Chip", then press the **ENTER** button.

Press the number buttons to enter your current 4-digit pin number.

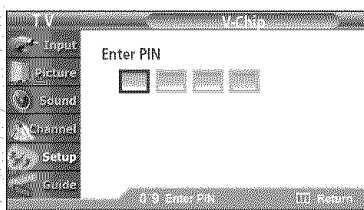

3
The "V-Chip" menu is displayed.

Press the **▲** or **▼** button to select "Change PIN", then press the **ENTER** button.

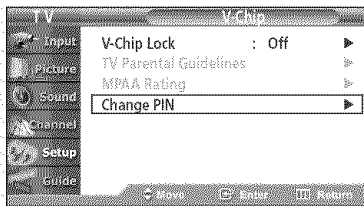

4
Press the number buttons (0 ~ 9) on the remote control to enter your current password.

Press the number buttons (0 ~ 9) to enter a new password.

Re-enter the new password to confirm.

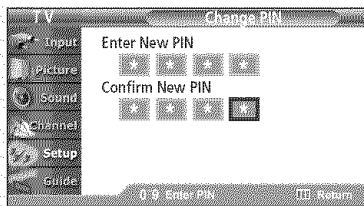
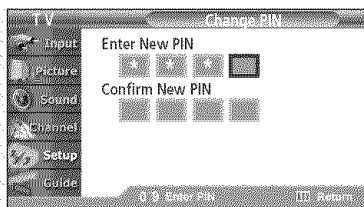

- ◀ The default pin number for a new TV set is "0 0 0 0".
- ◀ If you forget the pin number, press the remote control buttons in the following sequence, which resets the pin to 0-0-0-0: **POWER (Off)**, **MUTE**, **8**, **2**, **4**, **POWER (On)**.

How to Enable/Disable the Rating Controls

1
Press the **MENU** button.

Press the **▲** or **▼** button to select "Setup", then press the **ENTER** button.



2
Press the **▲** or **▼** button to select "V-Chip", then press the **ENTER** button.

Press the number buttons to enter your current 4-digit pin number.

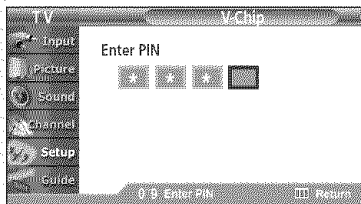

3
The "V-Chip" menu is displayed.

Press the **ENTER** button to select "V-Chip Lock".
Press the **▲** or **▼** button to select "On" or "Off", then press the **ENTER** button.

Press the **EXIT** button to exit.

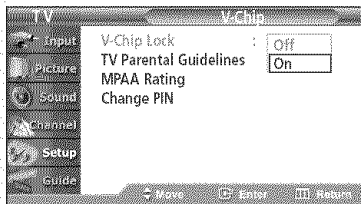

How to Set up Restrictions Using the “TV Parental Guidelines”

The parental restrictions can be set up using either of two methods: The “TV Parental Guidelines” or “MPAA Rating”.

1

Press the **MENU** button.

Press the **▲** or **▼** button to select “Setup”, then press the **ENTER** button.



2

Press the **▲** or **▼** button to select “V-Chip”, then press the **ENTER** button.

Press the number buttons to enter your current 4-digit pin number.

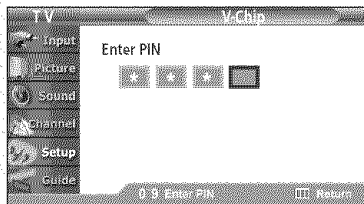

3

The “V-Chip” menu is displayed.

Press the **▲** or **▼** button to select “TV Parental Guidelines”, then press the **ENTER** button.

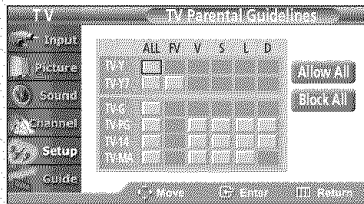

4

You can independently lock the TV ratings. The locked TV (FCC) ratings are indicated by the symbol “”.

Press the **▲/▼/◀/▶** buttons and the **ENTER** button to activate the appropriate restrictions for TV (FCC) rating system.

Press the **EXIT** button to exit.

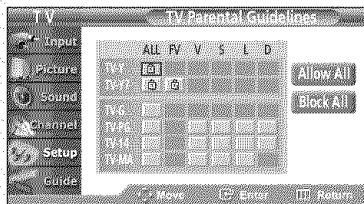

- ◀ **Allow All** : Press to unlock all TV ratings.
- Block All** : Press to lock all TV ratings.

- ◀ **TV-Y** : Young children
- TV-Y7** : Children 7 and over

-
- TV-G** : General audience
 - TV-PG** : Parent Guidance
 - TV-14** : Viewers 14 and over
 - TV-MA** : Mature Audience

- These categories consist of two separate groups: “TV-Y” and “TV-Y7” (young children through age 7), and “TV-G” through “TV-MA” (everybody else).
- The restrictions for these two groups work independently: If a household includes very young children as well as young adults, the TV parental guidelines must be set up separately for each age group. (See page 64)

How to Set up Restrictions using the Movie Ratings: G, PG, PG-13, R, NC-17, X

The Movie rating system uses the Motion Picture Association of America (MPAA) system, and its main application is for movies. When the Rating Control is on, the TV will automatically block any programs that are coded with objectionable ratings (either MPAA or TV-Ratings).

1
Press the **MENU** button.

Press the **▲** or **▼** button to select "Setup", then press the **ENTER** button.

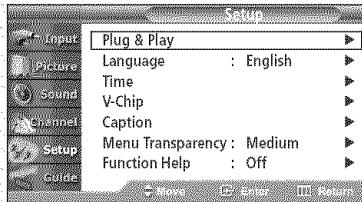

2
Press the **▲** or **▼** button to select "V-Chip", then press the **ENTER** button.

Press the number buttons to enter your current 4-digit pin number.

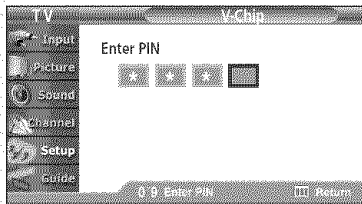

3
The "V-Chip" menu is displayed.

Press the **▲** or **▼** button to select "MPAA Rating", then press the **ENTER** button.

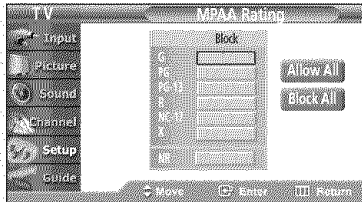

4
You can independently lock the movie ratings. The locked movie ratings are indicated by the symbol .

Press the **▲/▼/◀/▶** buttons and the **ENTER** button to activate the appropriate restrictions for movie rating system.

Press the **EXIT** button to exit.

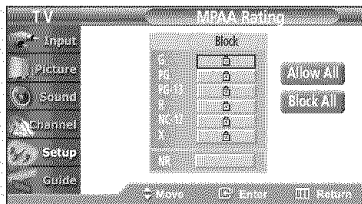

- ◀ **Allow All** : Press to unlock all movie ratings.
- Block All** : Press to lock all movie ratings.

Important Notes About Parental Locks

Explanation of the MPAA and TV (FCC) Rating Systems:

TV (FCC) Age-Based Ratings

TV-MA

Mature audiences only. This program may contain mature themes, profane language, graphic violence and explicit sexual content.

TV-14

Parents strongly cautioned. This program may contain sophisticated themes, sexual content, strong language and more intense violence.

TV-PG

Parental guidance suggested. The program may contain infrequent coarse language, limited violence, some suggestive sexual dialog and situations.

TV-G

General audience. It contains little or no violence, no strong language, and little or no sexual dialog or situations.

TV-Y7

Directed to older children. Themes and elements in this program may include mild physical or comedic violence, or may frighten children under the age of seven.

TV-Y

All children. The themes and elements in this program are specifically designed for a very young audience, including children from ages two – six.

TV (FCC) Content Category

- V** Violence.
- S** Sexual content.
- L** Offensive language.
- D** Dialog...sexual innuendo.
- FV** Fantasy or cartoon violence.

MPAA Rating System (Movies)

- G** General audience. No restriction.
- PG** Children under 13 should be accompanied by an adult.
- PG-13** Parental guidance suggested. Children under 13 should be accompanied by an adult.
- R** Restricted. Viewers should be 17 or older.
- NC-17** Not classified. Viewers should be 17 or older.
- X** Adults only.

- TV (FCC) ratings: The particular rating that you have selected will be locked (and indicated as a red “L” on a blue background). Also, all of the age-based ratings will be locked within the particular group (i.e., “group 1” or “group 2”).
Suppose that the TV-G rating and all of its contents (V, S, L, and D) are locked. In that case, more restrictive ratings (TV-PG, TV-14, and TV-MA) and all of their contents (V, S, L, and D) are automatically locked as well.
- MPAA ratings: The particular rating that you have selected will be locked. In addition, more restrictive ratings will be locked as well.
- Neither TV (FCC) ratings nor MPAA ratings apply to news programs.

Analog**Viewing Closed Captions
(On-Screen Text Messages)**

The Analog Caption function operates in either analog RF channel mode or external signal mode. (Depending on the broadcasting signal, the Analog Caption function may operate on digital channels.)

1

Press the **MENU** button.

Press the **▲** or **▼** button to select "Setup", then press the **ENTER** button.

**2**

Press the **▲** or **▼** button to select "Caption", then press the **ENTER** button.

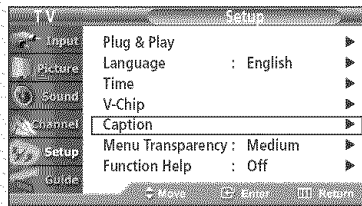
**3**

Press the **ENTER** button to select "Caption".

Press the **▲** or **▼** button to select "On", then press the **ENTER** button.

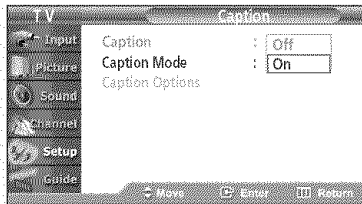
**4**

Press the **▲** or **▼** button to select "Caption Mode", then press the **ENTER** button.

Press the **▲** or **▼** button to select submenu (CC1~CC4 or Text1 ~ Text4) you want, then press the **ENTER** button.

Press the **EXIT** button to exit.

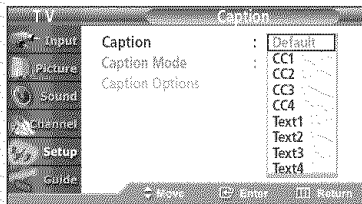

◀ The default is "CCI".

CC1 : The Primary Synchronous Caption Service. These are captions in the primary language that must be in sync with the sound, preferably matched to a specific frame.

CC2 : The Special Non-Synchronous Use Captions. This channel carries data that is intended to augment information carried in the program.

CC3 : Secondary Synchronous Caption Service. Alternate program-related caption data, typically second language captions.

CC4 : Special Non-Synchronous Use Captions. Similar to CC2.

Notes:

- The Caption feature doesn't work in DVI mode.
- The availability of captions depends on the program being broadcast.

Digital Viewing Closed Captions (On-Screen Text Messages)

The Digital Captions function operates on digital channels.

1
Press the **MENU** button.

Press the **▲** or **▼** button to select "Setup", then press the **ENTER** button.

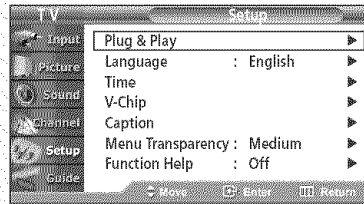

2
Press the **▲** or **▼** button to select "Caption", then press the **ENTER** button.

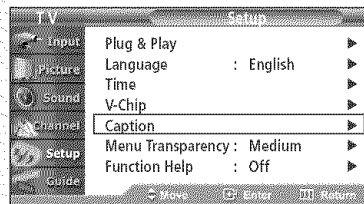

3
Press the **ENTER** button to select "Caption".

Press the **▲** or **▼** button to select "On", then press the **ENTER** button.

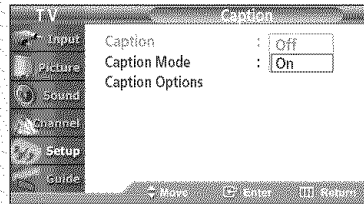

4
Press the **▲** or **▼** button to select "Caption Mode", then press the **ENTER** button.

Press the **▲** or **▼** button to select submenu (Service1~Service6, CC1~CC4 or Text1~Text4) you want, then press the **ENTER** button.

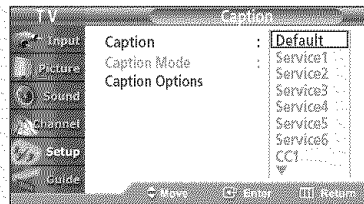

5
Press the **▲** or **▼** button to select "Caption Options", then press the **ENTER** button.

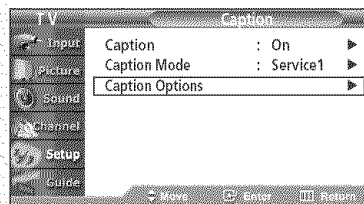

◀ "Caption Options" are available only when "Service1~Service6" can be selected in "Caption Mode".

continued...

6

Press the ▲ or ▼ button to select “Size”, then press the **ENTER** button.

Press the ▲ or ▼ button to select one you want, then press the **ENTER** button.

Set other listed options below using the same method as above.

Press the **EXIT** button to exit.

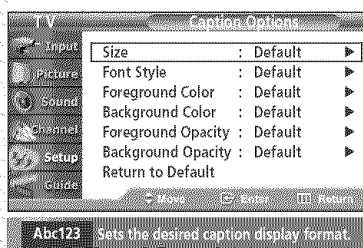

Notes:

- The availability of captions depends on the program being broadcast.
- The “default” means to follow the rule of broadcasting.

- ◀ Foreground Color and Background Color cannot be set to same color.
- ◀ Foreground Opacity and Background Opacity cannot be set to the same transparency value.

Size

This option consists of “Default”, “Small”, “Standard” and “Large”. The default is “Standard”.

Font Style

This option consists of “Default”, “Style0 ~ Style 7”. You can change the font you want. The default is “Style 0”.

Foreground Color

This option consists of “Default”, “White”, “Black”, “Red”, “Green”, “Blue”, “Yellow”, “Magenta” and “Cyan”. You can change the color of the letter. The default is “White”.

Background Color

This option consists of “Default”, “White”, “Black”, “Red”, “Green”, “Blue”, “Yellow”, “Magenta” and “Cyan”. You can change the background color of the caption. The default is “Black”.

Foreground Opacity

This option consists of “Default”, “Transparent”, “Translucent”, “Solid” and “Flashing”. You can change the opacity of the letter.

Background Opacity

This option consists of “Default”, “Transparent”, “Translucent”, “Solid” and “Flashing”. You can change the background opacity of the caption.

Return to Default

This option sets each of “Size”, “Font Style”, “Foreground Color”, “Background Color”, “Foreground Opacity”, and “Background Opacity” to its factory default.

Alternate method:

Press the **CAPTION** button on the remote control repeatedly to select “On” or “Off”.

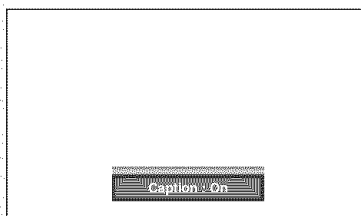

Menu Translucency Level

Adjusts the transparency of the menu screen.

1

Press the **MENU** button.

Press the **▲** or **▼** button to select "Setup", then press the **ENTER** button.

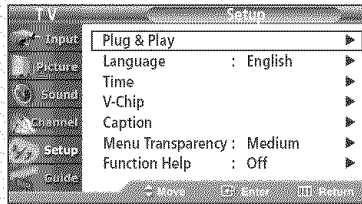

2

Press the **▲** or **▼** button to select "Menu Transparency", then press the **ENTER** button.

Press the **▲** or **▼** button to select level, then press the **ENTER** button.

Press the **EXIT** button to exit.

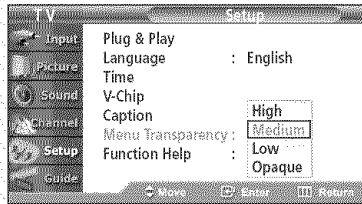

Setting the Function Help

Displays help on the menu functions.

1

Press the **MENU** button.

Press the **▲** or **▼** button to select "Setup", then press the **ENTER** button.

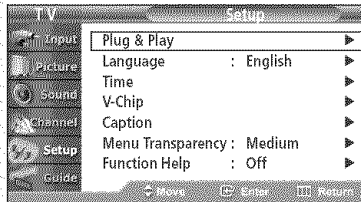

2

Press the **▲** or **▼** button to select "Function Help", then press the **ENTER** button.

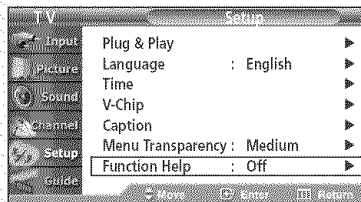

3

Press the **▲** or **▼** button to select "Off" or "On", then press the **ENTER** button.

Press the **EXIT** button to exit.

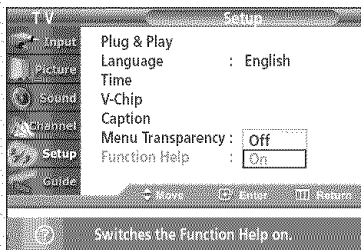

Electronic Program Guide

Your TV has an “Electronic Program Guide” to help you navigate through all the possible viewing options. The EPG supplies information, such as program lists, start and end times of all available channels.

In addition, detailed information about the program is often available in the EPG. (The availability and the amount of program details will vary depending on the broadcaster.)

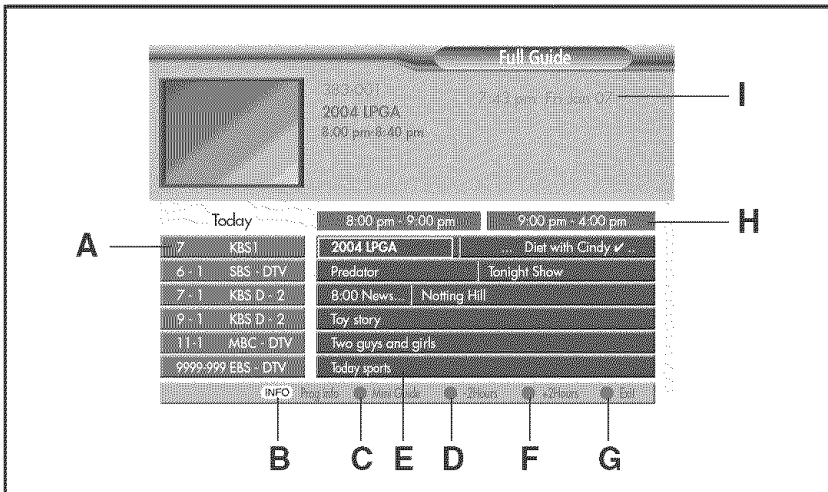

Viewing the Electronic Program Guide

- A** Displays which channel is currently selected to show program information in the Channel Guide.
- B** Press to view detailed information for the selected digital program.
- C** Switches to the mini program guide. The mini guide shows the titles of the available programs of one channel. Press the Red button on the remote control. The set default guide is Mini Guide.
- D** Scrolls backwards quickly (2 hours). Press the Green button on the remote control.
- E** Displays titles and other details about upcoming programs of particular channels. Highlight the program and press the **INFO** button to see additional and detailed information. (The availability of additional details depends on the broadcaster.) Use the **▲/▼/◀/▶** buttons to search information about another channel.
- F** Scrolls forward quickly (2 hours). Press the Yellow button on the remote control and repeatedly press the **ENTER** button the appropriate time is displayed.
- G** Exits from the Program Guide and returns to normal viewing mode. Press the Blue button on the remote control.
- H** Displays the program times (arranged in 1 hour time blocks)
- I** Displays the current time and date.

Note:

You can use the **GUIDE** button on the remote control to display the Electronic Program Guide. The EPG begins its list with the channel that is currently active. The EPG will only work when you are receiving digital channels.

Using the Electronic Program Guide

1

Press the **MENU** button.

Press the **▲** or **▼** button to select "Guide", then press the **ENTER** button.

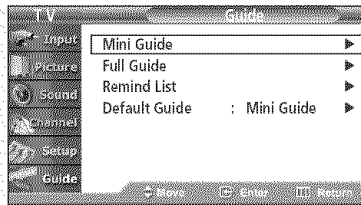

2

Press the **▲** or **▼** button to select "Default Guide", then press the **ENTER** button.

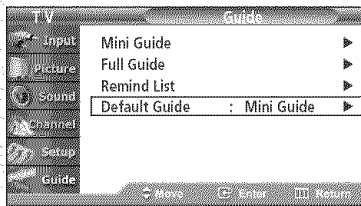

3

Press the **▲** or **▼** button to select "Mini Guide" or "Full Guide", then press the **ENTER** button.

Press the **EXIT** button to exit.

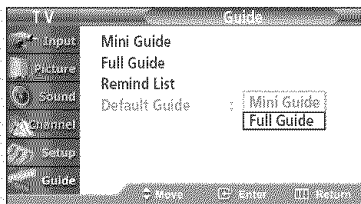

◀ **Mini Guide:**
Displays the guide for one channel.

Full Guide:
Displays the guide for all channels.

Viewing Information about a Single Channel

1

Press the **MENU** button.

Press the **▲** or **▼** button to select "Guide", then press the **ENTER** button.

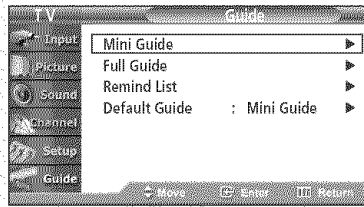

2

Press the **ENTER** button to select "Mini Guide".

Press the **▲** or **▼** buttons to view information about one channel by time.

You can switch between Full Guide mode and Mini Guide mode by pressing the Red button repeatedly.

Select the program you want by pressing the **▲** or **▼** buttons and press the **INFO** button on the remote control.

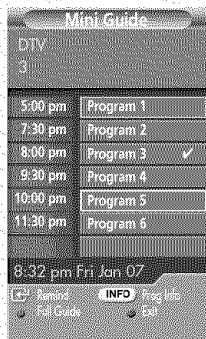

◀ **ENTER** button:
Press to watch the selected channel.

Red button:
Press to switch to the program guide for all channels.
Press again to switch to the program information for the selected channel.

Blue button:
Press to exit.

INFO button:
Press to view detailed information for the selected digital program.

3

Press the **Blue** button or **EXIT** button to exit.

Notes:

- You can also view information about a single channel by pressing the **GUIDE** button on the remote control. (The EPG should be pre-set in Mini Guide mode.)
- Press the **INFO** button on the remote control to view the program information for the current channel.
- However, this function is available only when the default program guide setting has been set to "Current Program Guide".

Viewing Information about Channels

Displays the program time and content for all channels.
This function is available only when the program is digital.

- 1 Press the **MENU** button.

Press the **▲** or **▼** button to select "Guide", then press the **ENTER** button.

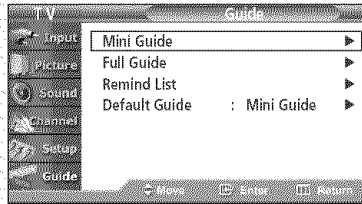

- 2 Press the **▲** or **▼** button to select "Full Guide", then press the **ENTER** button.

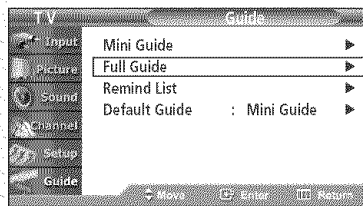

- 3 Press the green button to activate "-2 Hours" and the yellow button to activate "+2 Hours".

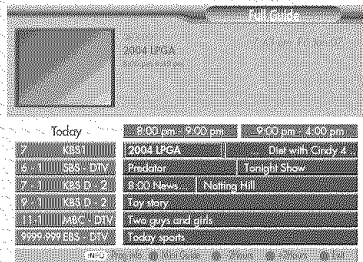

- 4 You may now:

- Jump to a channel directly: Use the **▲** or **▼** buttons to highlight the program in the column and press the **ENTER** button.
- Obtain additional program details: Highlight the title of a program using the **▲**, **▼**, **◀** or **▶** button and press the **INFO** button.
- Exit from the Program Guide and return to normal viewing mode: Press the blue button or the **EXIT** button.

Notes:

- Displays the program times in two hour segments.
- Displays the current date and time on the top right of the screen.
- The current time displayed on the program information is subject to the time information sent from the broadcasting station, so it may differ from the actual time.
- Press the **GUIDE** button on the remote control to view the program information for all channels. However, this function is available only when the default program guide setting is set to "All Program Guide".

- ◀ **INFO** button:
Displays detailed information for the selected digital program.
- ▲/▼/◀/▶** buttons:
Displays program information for each channel, based on the time. Select your desired program using the **▲/▼/◀/▶** buttons, and then press the **ENTER** button to view the program information for the selected program.

Red button:
Each press switches between program information for one channel and all channels.

Green button:
Press to view the program information from two hours ago.

Yellow button:
Press to view the program information for two hours from now.

Blue button:
Press to exit.

Remind List

Reminded Viewing List

If you have made a scheduled viewing list of programs you would like to see, the channel will be automatically switched to the scheduled program at the scheduled time even if you are watching another program.

1

Press the **MENU** button.

Press the **▲** or **▼** button to select "Guide", then press the **ENTER** button.

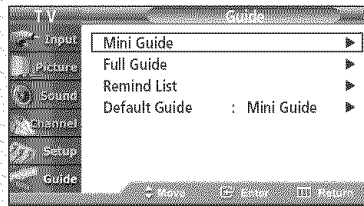

2

Press the **ENTER** button to select "Mini Guide".

Press the **▲** or **▼** button to select programs you would like to see, then press the **ENTER** button.

The symbol "✓" will be displayed.

Each press of the **ENTER** button will switch between "Remind" and "Del Remind".

Press the **EXIT** button to exit.

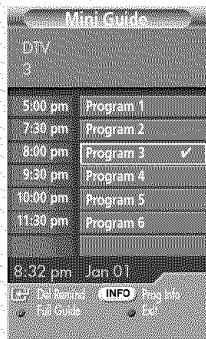

To view the Remind List

1
Press the **MENU** button.

Press the **▲** or **▼** button to select "Guide", then press the **ENTER** button.

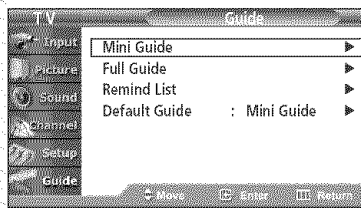

2
Press the **▲** or **▼** button to select "Remind List", then press the **ENTER** button.

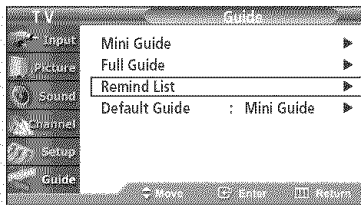

To remove the scheduled programs

Press the **▲** or **▼** button to select a program to be removed, then press the **ENTER** button.

To remove all programs, press the **▶** button to select "Cancel All", then press the **ENTER** button.

Press the **EXIT** button to exit.

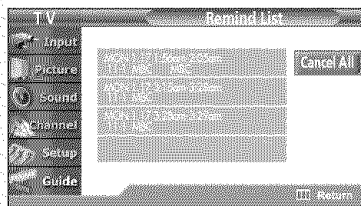
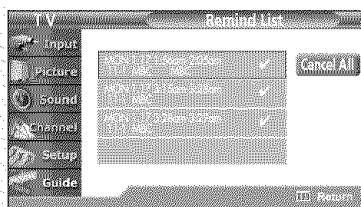

Customizing Your Remote Control

Your TV comes equipped with a universal remote control. In addition to controlling the TV, the universal remote control can also operate a VCR, Cable box, DVD and Set-Top Box (even if your VCR, Cable box and DVD are made by manufacturers other than Samsung).

- The remote control might not be compatible with all DVD players, VCRs, Cable boxes, and Set-Top Boxes.

Setting Up Your Remote Control to Operate Your VCR (Cable box or DVD player)

1

Turn off your VCR (Cable box or DVD player).

2

Press the **MODE** button to switch the remote control to the **VCR (CABLE or DVD)** mode.

◀ The remote control has five modes: **TV**, **STB**, **VCR**, **CABLE** and **DVD**.

3

On your Samsung remote control, press the **SET** button.

4

Enter 3 digits of the VCR (Cable box or DVD player) code listed on next page for your brand of VCR (Cable box or DVD player).

◀ Make sure you enter 3 digits of the code, even if the first digit is a "0". (If more than one code listed, try the first one.)

5

Press the **POWER** button on the remote control. Your VCR (Cable box or DVD player) should turn on. If your VCR (Cable box or DVD player) turns on, your remote control is now set correctly.

◀ If your VCR (Cable box or DVD player) does not turn on, repeat steps 2, 3, and 4, but try one of the other codes listed for the brand of your particular VCR (Cable box or DVD player).

6

Once your remote control is set up, press the **MODE** button any time you want to use the remote to operate your VCR (Cable box or DVD player).

- When your remote is in the **TV** mode, the VCR (or DVD player) control buttons (**REW**, **STOP**, **PLAY/PAUSE** and **FF**) will still operate your VCR (or DVD player).
- When your remote control is in the **STB**, **VCR**, **CABLE** or **DVD** mode, the volume buttons still control your TV's volume.

SPECIAL FEATURES

Remote Control Codes

VCR Codes

| | | | | | |
|------------------|---|------------------|---|-------------|---|
| Admiral | 015,088 | Hitachi | 014,024,044,045 | Quasar | 017,053 |
| Aiwa | 024 | Instant Replay | 017 | Radio Shack | 011,015,017,018,021,024,028,036,052,062 |
| Akai | 026,031,032 | JC Penny | 011,014,016,017,023,025,039,044,060,062 | RCA | 009,014,016,017,037,044,046,063,078 |
| Audio Dynamics | 022,025 | JCL | 011,017,023,025,039,055 | Realistic | 011,015,017,018,021,024,028,036,052,062 |
| Bell & Howell | 011 | Kenwood | 011,023,025,039,055 | Samsung | 000,016,022,031,041,051 |
| Broksonic | 019 | KLH | 082 | Sansui | 025 |
| Candle | 016,018,022,054,055,061 | LG(Goldstar) | 001,002,007,018,023,055,069 | Sanyo | 011,021 |
| Canon | 017,062 | Lloyd | 024 | Scott | 022,050,058,077 |
| Citizen | 016,018,022,054,055,061 | Logik | 040 | Sears | 011,014,018,021,027,028,044,052,057 |
| Colortyme | 023 | LXI | 024 | Sharp | 015,036,048,054 |
| Craig | 016,021 | Magnavox | 017,038,062,065 | Shintom | 026,035,040,064 |
| Curtis Mathes | 009,016,017,023,024,055,062,073,076 | Marantz | 011,017,023,025,038,039,055,070 | Signature | 024 |
| Daewoo | 003,004,005,006,007,008,022,054,085 | MTC | 016,024 | Sony | 026,035,047 |
| DB | 023,025 | Multitech | 016,024,040,041 | Sylvania | 017,024,038,062,065 |
| Dimensia | 009 | NEC | 011,023,025,039,055,070,073 | Symphonic | 024 |
| Dynatech | 024 | Optimus | 015 | Tandy | 011,024 |
| Electrohome | 036 | Panasonic | 017,062,084,086 | Tatung | 039 |
| Emerson | 017,018,019,022,024,029,032,036,043,050,051,056,058,066,071,074,076,077,079 | Pentax | 014,044 | Teac | 024,039,078 |
| Fisher | 011,021,027,028,052,057,067 | Pentax Research+ | 055 | Technics | 017 |
| Funai | 024 | Philco | 017,038,062,065 | Teknika | 017,018,024,030 |
| General Electric | 009,016,017,041,062 | Philips | 017,038 | TMK | 076 |
| Go Video | 016 | Pioneer | 014,025,042,059 | Toshiba | 014,022,028,057,058 |
| Harman Kardon | 023 | Portland | 053,054,061 | Toshiko | 018 |
| | | PROSCAN | 009 | Television | 016,018 |
| | | Quartz | 011 | | |

Cable Box Codes

| | | | | | |
|-----------------------|---|-----------|---|--------------|---|
| Anvision | 015,016 | Magnavox | 015,016,027,029,034,036,037,040,041,048,049 | Signature | 054 |
| Cable Star | 015,016 | Nawoo | 001 | Sprucer | 035 |
| DaeHan | 005 | NSC | 017 | Starcom | 054 |
| DeaRyung | 003 | Oak | 024,046 | Stargate2000 | 066 |
| DongKuk | 004 | Osk Sigma | 024 | Sylvania | 019,067 |
| Eagle | 015,016 | Panasonic | 011,035,047,069 | TaePyungYang | 002 |
| Eastern International | 020 | Philips | 015,016,027,029,034,036,037,040,041,048,049 | Texscan | 019,067 |
| General Instrument | 054 | Pioneer | 026,028,052 | Tocom | 025,029,057,058,063 |
| GI | 012,013,023,031,032,033,038,044,075,076,077 | Randtek | 015,016 | Unika | 039,040,049 |
| Hamlin | 011,012,020,021,042,056 | RCA | 008,035,074 | Universal | 059,060 |
| Hitachi | 045,051,054 | Regal | 011,020,021 | Viewstar | 015,016,027,029,034,036,037,040,041,048,049 |
| Jarrol | 012,013,023,031,032,033,038,044,054,070,073 | Regency | 010,041 | Warner Amex | 052 |
| LG(Goldstar) | 006 | Saewoo | 007 | Zenith | 022,050,065,069 |
| Macom | 045,051 | Samsung | 000,011,030,052,071,072 | | |

DVD Codes

| | | | | | |
|---------------|-----|---------|-----|---------|-----|
| Curtis Mathes | 009 | Philips | 007 | Sharp | 005 |
| JVC | 003 | PROSCAN | 008 | Sony | 004 |
| LG(Goldstar) | 001 | RCA | 008 | Toshiba | 002 |
| Panasonic | 006 | Samsung | 000 | | |

Chapter Five

TROUBLESHOOTING

If the TV seems to have a problem, first try this list of possible problems and solutions. If none of these troubleshooting tips apply, then call your nearest Samsung authorized service center.

Identifying Problems

| Problem | Possible Solution |
|---|--|
| Poor picture. | Try another channel. Adjust the antenna. Check all wire connections. |
| Poor sound quality. | Try another channel. Adjust the antenna. Make sure the MUTE button is off. |
| No picture or sound. | Try another channel. Press the SOURCE button. Make sure the TV is plugged in. Check the antenna connections. |
| No color, wrong colors or tints. | Make sure the program is broadcast in color. Adjust the picture settings. |
| Picture rolls vertically. | Adjust the antenna. Check all wire connections. If you are using a VCR, check the tracking. |
| The TV operates erratically. | Unplug the TV for 30 seconds, then try operating it again. |
| Your remote control does not operate your TV. | Press the MODE button to put your remote control in the "TV" mode. Make sure the remote has batteries. |
| The TV won't turn on. | Make sure the wall outlet is working. Make sure the TV is plugged in. Make sure the remote has batteries. |
| Digital broadcasting screen problem | Please check the digital signal strength and input antenna. |
| Color smudge on screen. | Please operate the Self Focus function. |

Note

If you watch a still image or the screen in the Normal (4:3) aspect ratio format for a long time, images may be burned onto the screen.

Cleaning and Maintaining Your TV

With proper care, your TV unit will give you many years of service. Please follow these guidelines to get the maximum performance from your TV.

Placement

- Do not place the TV near extremely hot, cold, humid or dusty places.
- Do not place the TV near appliances with electric motors that create magnetic fields, such as vacuum cleaners.
- Keep the ventilation openings clear; do not place the TV on a soft surface, such as cloth or paper.
- Place the TV in a vertical position only.

Liquids

- Do not handle liquids near or on the TV. Liquids that spill into it can cause serious damage.

Cabinet

- Never open the cabinet or touch the parts inside.
- Wipe your TV with a clean, dry cloth. Never use water, cleaning fluids, wax, or chemicals.
- Do not put heavy objects on top of the cabinet.

Temperature

- If your TV is suddenly moved from a cold to a warm place, unplug the power cord, and allow at least two hours for moisture that may have formed inside the unit to dry completely.

Using Your TV in Another Country

If you plan to take your TV with you to a foreign country, please be aware of the different television systems that are in use around the world. A TV designed for one system may not work properly with another system due to differences in the TV channel frequencies.

Specifications

| Model | HC-R4245W | HC-R4745W | HC-R5245W | HC-R4355W | HC-R4755W |
|------------------------|--|--|---|--|---|
| Voltage | AC 120V | AC 120V | AC 120V | AC 120V | AC 120V |
| Frequency of Operation | 60Hz | 60Hz | 60Hz | 60Hz | 60Hz |
| Power Consumption | 240 watts | 240 watts | 240 watts | 240 watts | 240 watts |
| Dimension (W x D x H) | 1004 x 500 x 967 mm 39.5 x 19.7 x 38.1 inches | 1126 x 621 x 984 mm 44.3 x 24.4 x 38.7 inches | 1226 x 598 x 1276 mm 48.3 x 23.5 x 50.2 inches | 1035 x 510 x 888 mm 40.7 x 20.0 x 34.9 inches | 1120 x 555 x 939 mm 44.0 x 21.8x 36.9 inches |
| Weight | 40.4 Kg / 89.1 lbs | 49.9 Kg / 110.0 lbs | 61.0 Kg / 134.4 lbs | 36.4 Kg / 80.2 lbs | 39.5 Kg / 87.0 lbs |



ELECTRONICS

1-800-SAMSUNG (1-800-726-7864)

Samsung Electronics America

Service Division

400 Valley Road, Suite 201

Mount Arlington, NJ 07856

www.samsung.com

Samsung Electronics Canada Inc.

Samsung Customer Care

55 Standish Court

Mississauga, Ontario

L5R 4B2

www.samsung.ca