

HOOVER[®] **concept one[™]** **Cleaner**

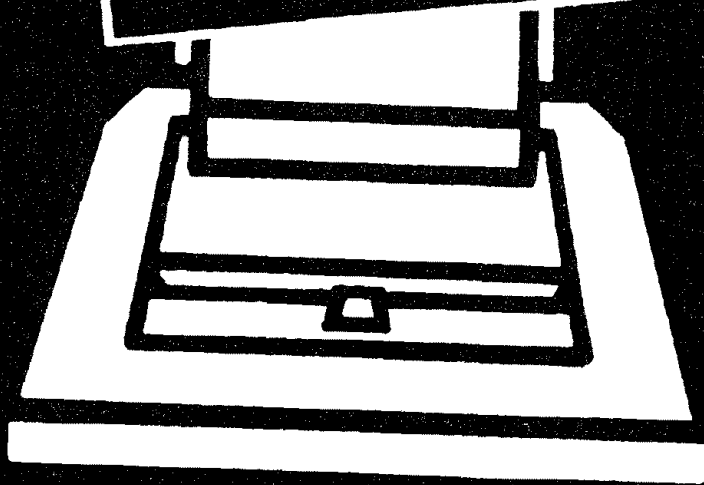

**Review
this manual
before
operating
cleaner**



Fill in and retain!

The HOOVER vacuum cleaner you have just purchased is a combination cleaner. It is used for carpet and rug cleaning and may be used with attachments for above the floor cleaning.

The model and serial number appear toward the rear of the bottom of the cleaner.

For your personal records, please enter these numbers in the spaces provided below and retain in a safe place.

Your cleaner is model _____

and has serial number _____

Save!

Index

Assembling Cleaner	5
Cleaner Description	3,4
How to Use	
Cleaning Tools	9-12
Special Features	7
Upright Cleaner	6-8
If You Have a Problem	21
Important Safeguards	2
Lubrication	22
Maintenance	
Authorized Hoover Service	21
Dirt Duct and Dirt Tube	18,19
Replacing Belts	15-18
Replacing Brushes	20,21
Replacing Headlight	14,15
Replacing Throw Away Bag	12-14

Important Safeguards!

- Read all instructions.
- **Warning:** Electric shock could occur if used outdoors or on wet surfaces.
- Close supervision is necessary when any appliance is used by or near children. Do not allow vacuum cleaner to be used as a toy or to run unattended at any time.
- Keep hands, feet, loose clothing, and hair away from rotating agitator. Do not operate cleaner in bare feet or when wearing open toe shoes or sandals.
- Don't run cleaner over cord. It may damage insulation.
- Do not use cleaner to pick up matches, or live ashes and cigarette butts.
- Never vacuum in the presence of flammable or combustible liquids or fumes.
- Avoid picking up hard, sharp objects with the cleaner. They may damage the cleaner and the bag.
- Do not allow cleaner to run in a stationary position on non-carpeted floors; damage could occur to these surfaces.
- Unplug cleaner when not in use. Turn machine off at switch before unplugging.
- Always disconnect cord from electrical outlet before servicing the cleaner.
- Change bag frequently when picking up very fine materials such as powder.
- Grasp the plug to disconnect from wall outlet to avoid damage to cord, plug, prongs, or receptacle.
- If cleaner has a cord reel, hold on to the plug while cord is being re-wound to prevent cord from whipping.
- The use of an extension cord is not recommended.
- If cleaner is in disrepair, do not attempt to operate.
- Have repairs made by the qualified personnel at Hoover Factory Service Centers or Authorized Hoover Warranty Service Dealers.
- Use vacuum cleaner only for its intended use as described in the instructions. Use only attachments recommended by the appliance manufacturer; others may cause hazards.

Save these instructions!



Unpacking

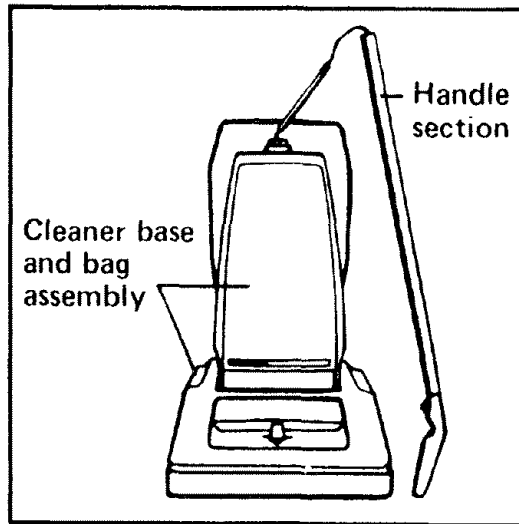

Unpack the cleaner from the carton and remove and dispose of cardboard packing.

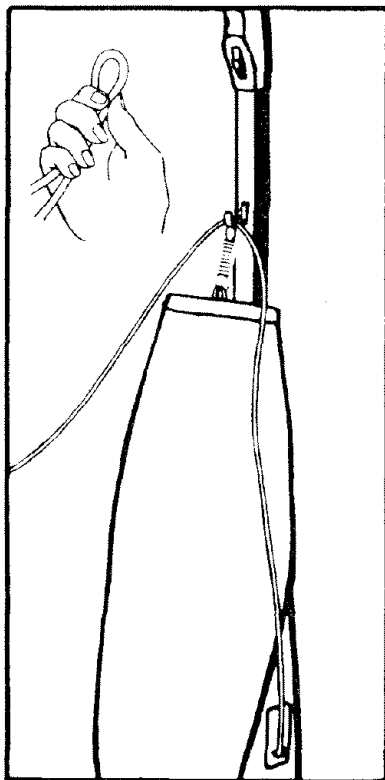

Make a small loop with cord and place it over the hook at the back of the handle. When operating, cord should be positioned as shown.

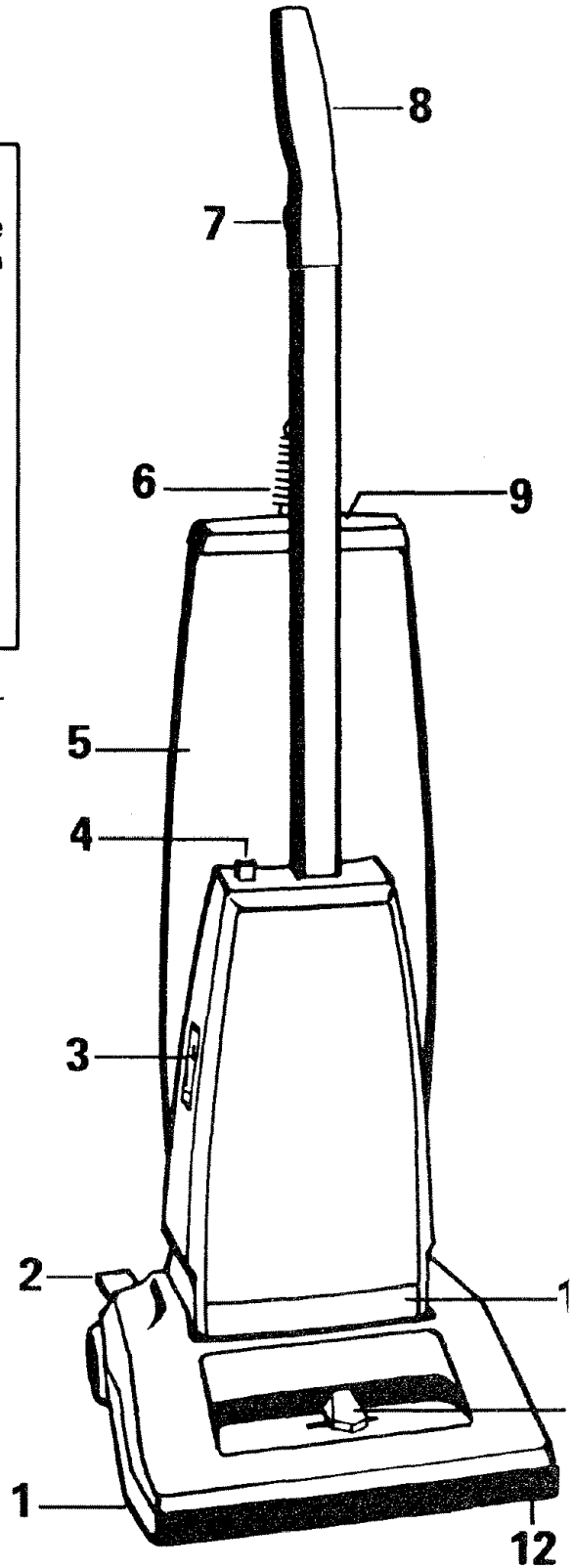

Before operating your cleaner, identify features and controls shown in the diagram, then, read the section on "How to use".

1. **Edge Cleaning:** Brushed edge cleaning is provided on the right side of the cleaner. Standard edge cleaning is provided on the left side.
2. **Handle Release Pedal:** step on pedal to lower handle to either operating or low position.
3. **Cord Reel:** to unwind cord, pull from cord reel to desired length.
4. **Cord Return Button:** depress to automatically rewind cord for storage. **Hold plug until cord is rewound.**
5. **Vinyl Bag Jacket:** covering for throw away bag.
6. **Bag Spring:** place spring ring over hook to support the bag.
7. **ON-OFF 'Power Surge' Switch**
8. **Handle Grip.**
9. **Air Freshener Dispenser:** designed to hold a fragrance tablet and release a pleasant scent during cleaning.
10. **Twin Headlight**
11. **Carpet Height Adjustment Lever:** choose "LOW/MED", "PLUSH", or "SHAG".
12. **Molded Furniture Guard**

Note: If using cleaner on new carpet, be sure to change bag frequently. See "Maintenance" section for bag replacement.

Operate cleaner only at voltage specified on data plate on bottom of cleaner.

How to assemble

Remove the tape holding the two handle attachment screws from the lower end of the handle. Set screws aside.

Align handle with ON-OFF switch to the rear of the cleaner and label to the front. Fold cord beside cord tube as shown. Push cord and tube completely up into handle.

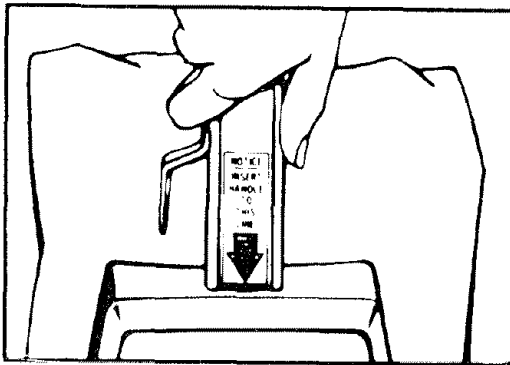
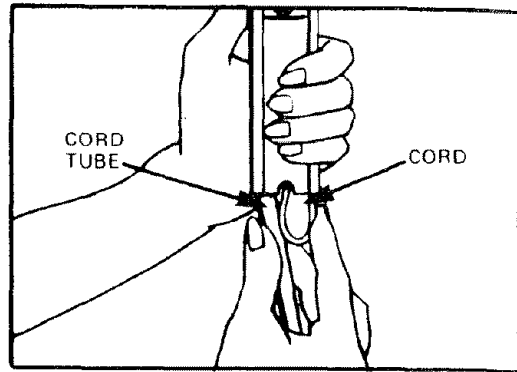

Insert handle into the cleaner to the line indicated on label. Insertion to the line is necessary for proper screw alignment.

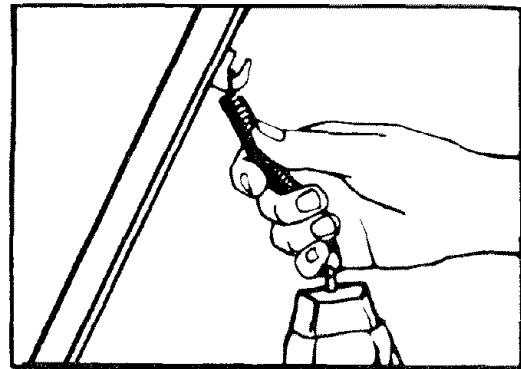

Lower handle to operating position and place spring bag ring over hook located on handle.

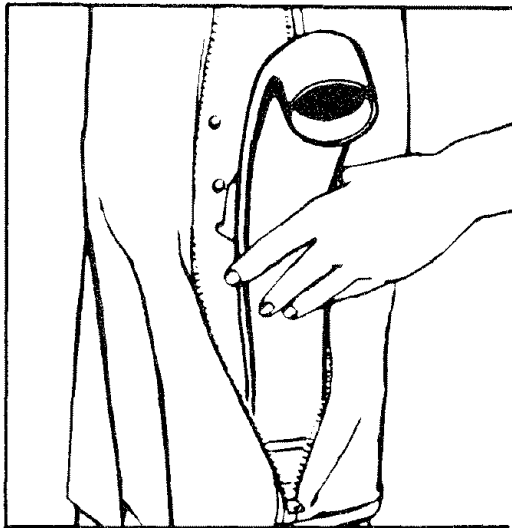

Remove paper bag from inside the vinyl jacket. Then remove dirt tube by pushing to either side to release retention clips. Lift tube up and out.

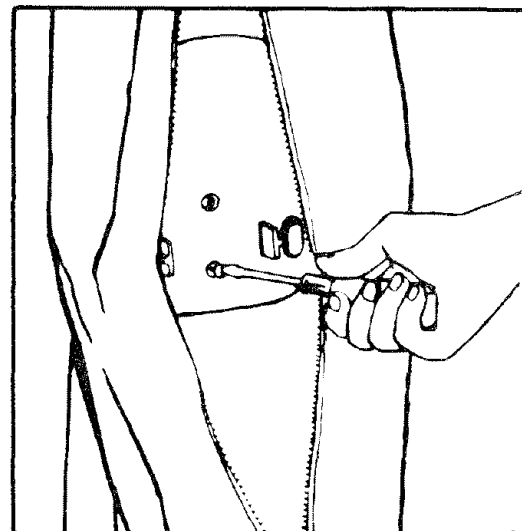

Insert the two screws into the holes provided inside the front housing.

Tighten with screwdriver. Snap dirt duct back into place. Replace **paper bag**. (Follow instructions on bag.)

Zip vinyl jacket.

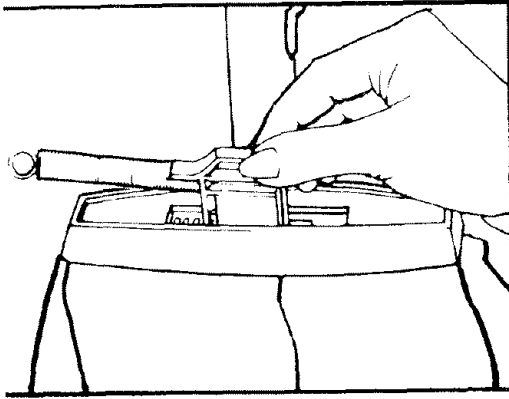

Check air freshener dispenser

The small drawer in the top of the bag cap should not be removed. If it should become detached, replace by unhooking the bag spring and tipping the bottom of the drawer to insert projections into back of cap opening. Push drawer down into position and hook bag spring.

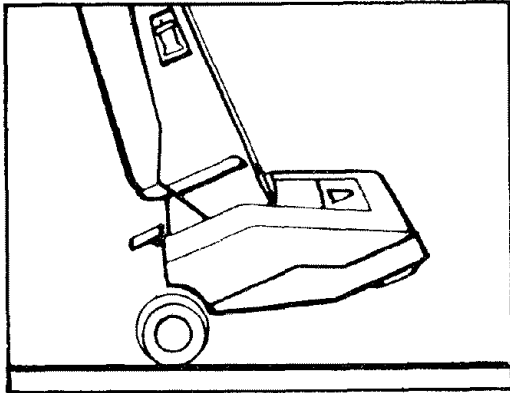

How to use To transport

To move your cleaner from room to room, put the handle in the upright position, tilt the cleaner back on the large rear wheels and push forward.

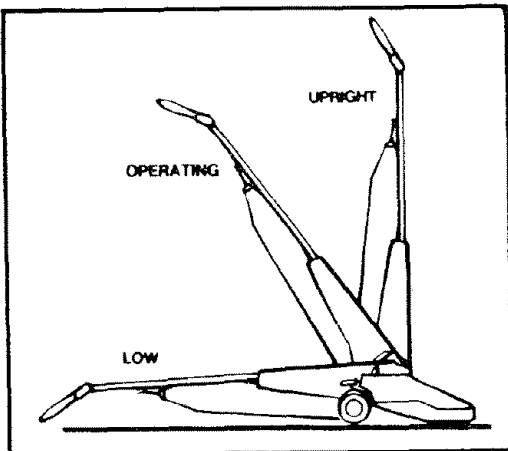

Handle adjustment

The handle of your cleaner has three positions: **Upright** for storage and when using attachments. **Operating** for general operation on carpet and floors. **Low** for reaching under low furniture. The handle can be lowered by stepping on the pedal at the rear of the cleaner.

ON-OFF 'Power Surge' switch

Operate your cleaner at normal speed by pushing the switch down one position. To turn cleaner off, push switch up.

Normal Speed is to be used for regular cleaning of carpet and rugs and when using cleaning tools.

Your cleaner is also equipped with a Power Surge switch. When the switch is pushed down as far as possible it is in the Power Surge speed.

'Power Surge' Speed is to be used for extra cleaning power on a heavily soiled area of carpet. Slide the switch down as far as possible and hold it in that position to engage the "POWER SURGE" speed. When the switch is released, it will return to the NORMAL speed position.

Note: When cleaning any floor covering, turn cleaner "OFF" when unattended, particularly on non-carpeted floors. The agitator cleans so thoroughly that operation while the cleaner is stationary may mar the floor covering.

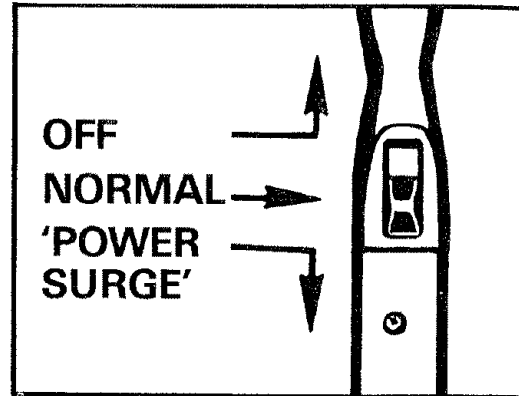

Special features Edge cleaning

Brushed edge cleaning is provided on the right side of the cleaner to remove imbedded dirt in carpet near baseboards and furniture. Guide the right side of the cleaner parallel to the edge of carpet or furniture for brushed edge cleaning.

Standard edge cleaning is provided on the left side of the cleaner. Standard edge cleaning removes surface dust and litter.

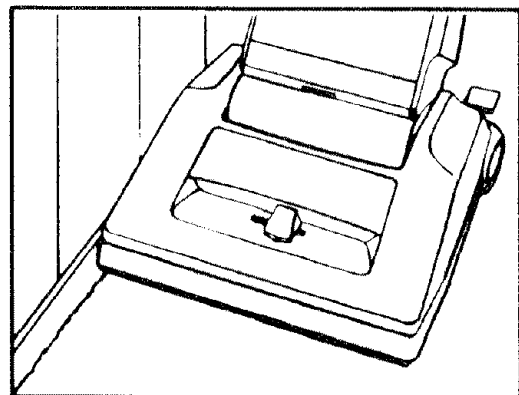

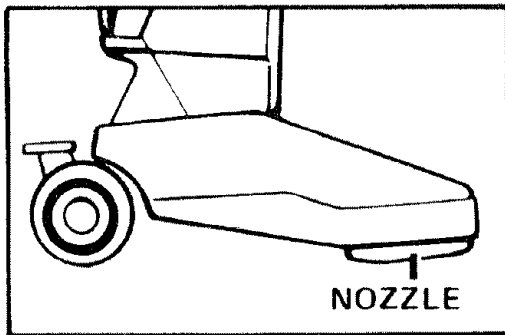

Adjustment for carpet pile height

The cleaning of carpet and rugs takes place at the nozzle. This is the opening at the bottom of the cleaner where the agitator is located.

It is necessary for the nozzle to be adjusted properly to the various carpet pile heights. The adjustment lever on the front of the cleaner may be set on three different self-adjusting ranges.

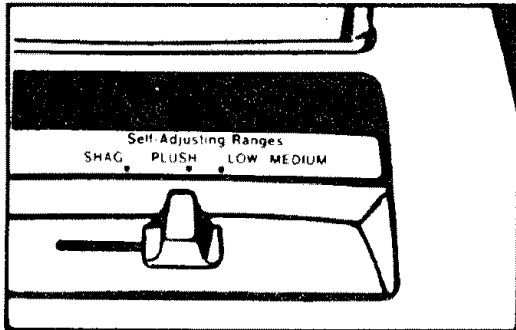

On very dense pile plush or shag carpet, some difficulty in pushing the cleaner may occur. In this case, position the adjustment lever on PLUSH or SHAG. When cleaning non-carpeted floors, set adjustment lever to LOW/MEDIUM and use Normal Speed. Because of the vigorous action of the agitator, **do not allow cleaner to run in a stationary position** on any floor covering, as marring may occur.

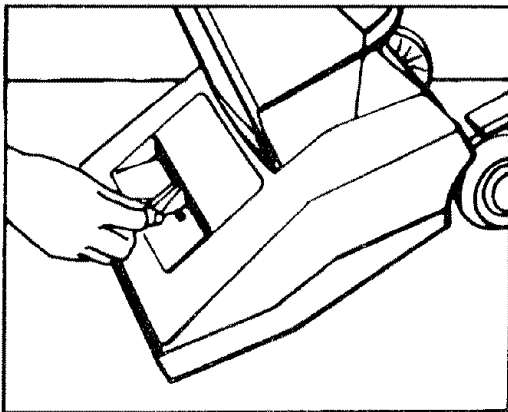

Disconnect cleaner from electrical outlet before making nozzle adjustment.

To change the nozzle adjustment grasp the handle and tilt the cleaner forward. Move the lever with your hand until it "clicks" into the desired position.

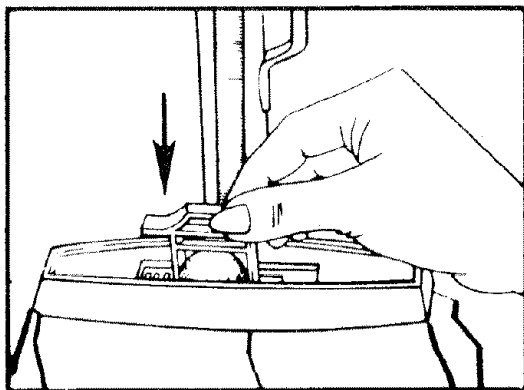

Air freshener dispenser

Lift drawer in the bag cap of your cleaner and insert the air freshener tablet that has been packed with your cleaner. Push drawer down into position.

The amount of fragrance released is regulated by sliding the control to one of three settings shown on top of the bag cap.

Air freshener tablets may be obtained from your local authorized Hoover dealer, a Hoover Factory Service Center, or by using the mail order form packed with your cleaner.

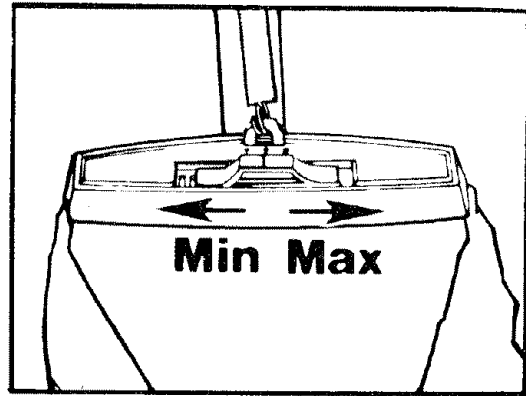

Cleaning Tools

This cleaner may be used with cleaning tool attachments. The Deluxe or Standard cleaning tool set may be purchased at additional cost from Hoover Dealers. The cleaning tools allow you to do above the floor cleaning and to clean hard to reach areas.

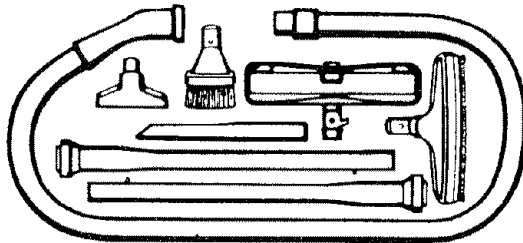

Deluxe cleaning tool set
U3901 includes vinyl hose, converter, wands, dusting brush, furniture nozzle, wall/floor brush and crevice tool.

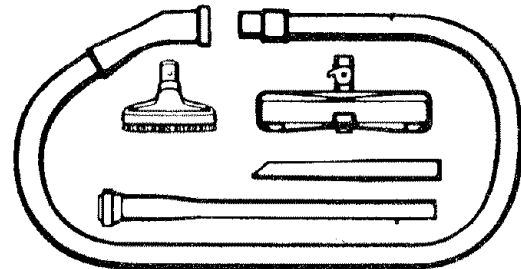

Standard cleaning tool set
U3903 includes lightweight hose, converter, wand, multi-purpose brush and crevice tool.

How to assemble hose and converter

By using this converter attachment, suction is channeled from the cleaner to the hose and cleaning tools.

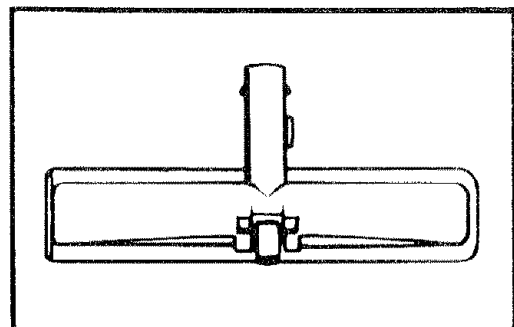

The converter must first be assembled to the hose by inserting the converter into the hose connector.

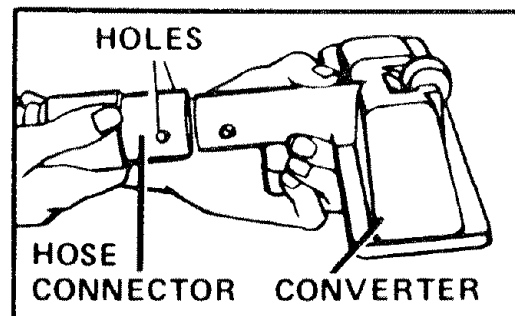

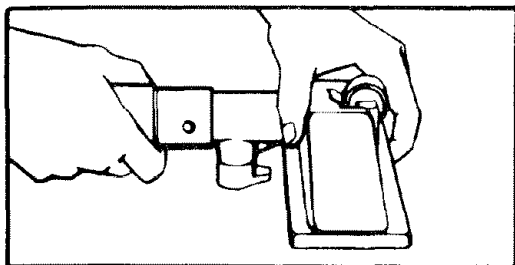

Push connector and converter together and twist until the projections on the converter fit into the holes on the hose connector. This unit should remain assembled for all future tool use.

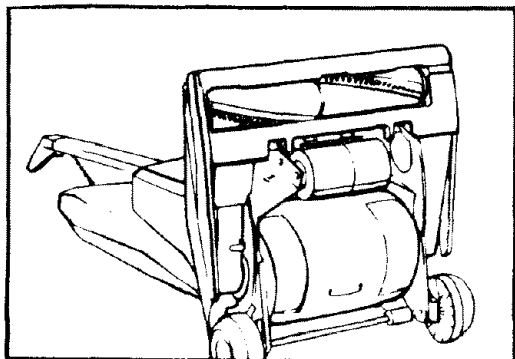

Using cleaning tools

A. Attach converter

Disconnect cleaner from electrical outlet. Cleaner must not be plugged in when positioning or removing converter.

With cleaner in upright position, grasp handle and lean cleaner backwards until bag is flat on the floor and underside is accessible.

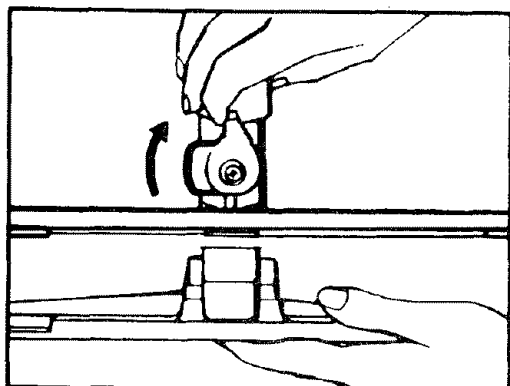

Turn lock on converter so that the serrated portion is in line with the hose.

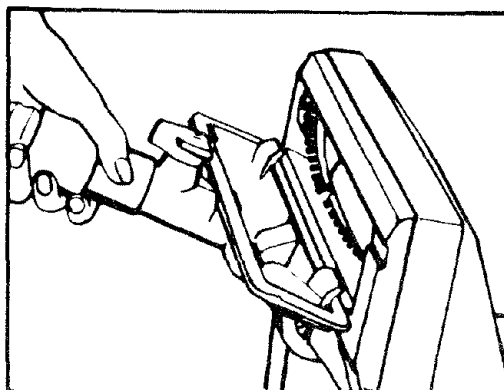

Place projections on converter onto rim on bottom plate of cleaner.

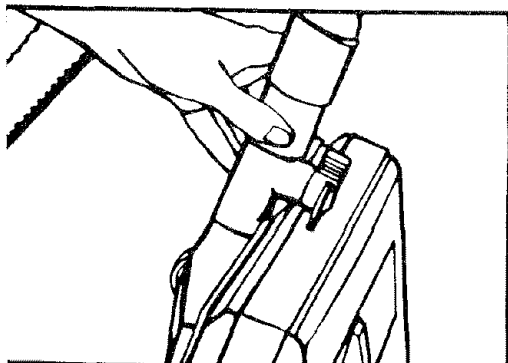

Pivot converter until it covers the opening.

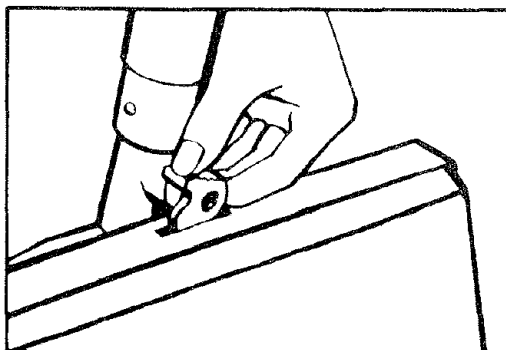

Place edge of lock in slot on cleaner and turn lock to secure converter.

Raise cleaner to upright position.

B. Select proper cleaning tool

The cleaning tools have many uses. Select the tool best suited for the cleaning task from the descriptions below.

1. Wall/floor brush* for walls and very irregular hard surface floors such as brick and slate.

2. Furniture nozzle* for upholstered furniture, draperies, tapestries, mattresses, clothing, automobile interiors and carpeted stairs.

3. Multi-purpose brush (standard set only) for dusting surfaces such as table tops, lamp shades, draperies as well as for cleaning upholstered furniture, stairs and automobile interiors.

4. Dusting brush* for carved furniture, table tops, books, lamps, lighting fixtures, venetian blinds, baseboards, shutters and registers.

5. Crevice tool for radiators, dresser drawers, spaces between kitchen appliances.

6. Wand(s*) used to give extra length to your hose. They are ideal to reach ceilings, the top of draperies, high shelves and cupboards. Use them with any of the above tools.

*Included in deluxe set only.

C. Attach tool

The outer plastic ring on the end of the hose grip has a slot.

Turn the ring until that slot aligns with the slot in the hose connector.

Insert the tool so that the button on the tool fits into the aligned slots.

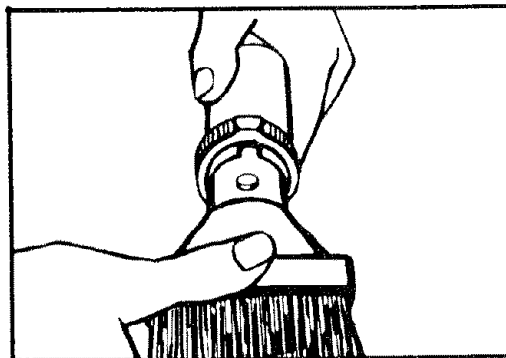
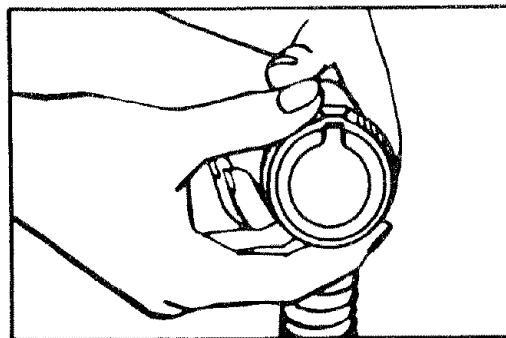
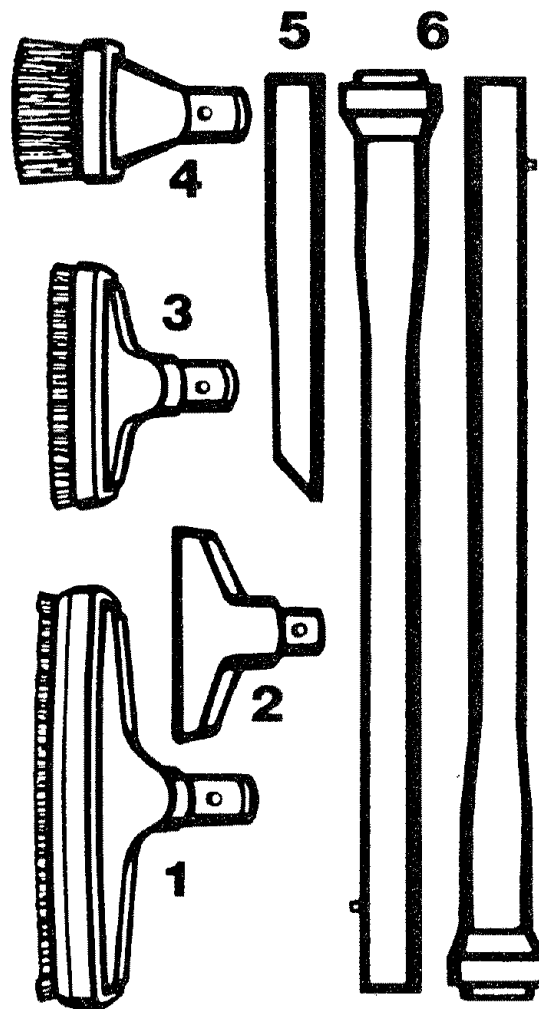

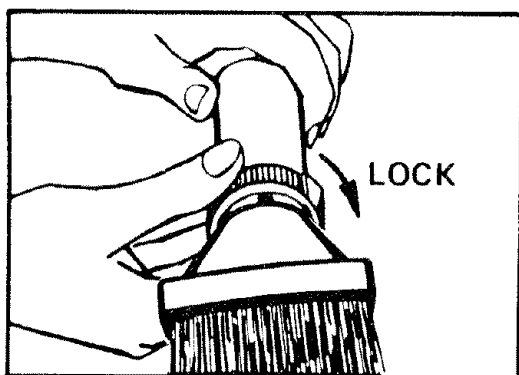

Turn the plastic ring as shown to lock the tool in place. To remove tools, reverse the procedure.

For additional length, attach wand to the hose using the same procedure as for attaching tools

Tools attach to the wand in the same manner.

D. Adjust switch and handle position

Plug cleaner into electrical outlet. Place handle in the **upright position**, and slide ON-OFF switch to Normal Speed.

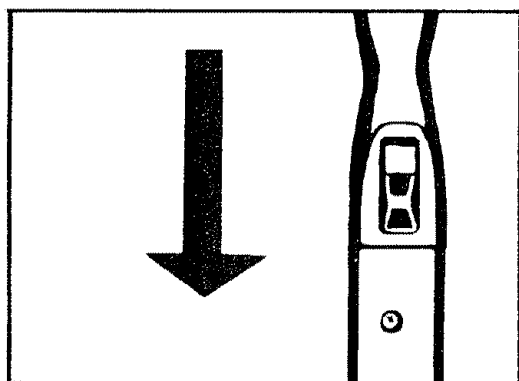

To clean attachments

To clean the hose wipe off dirt with a cloth dampened with a liquid detergent. Rinse with a damp cloth. Cleaning tools may be washed in warm water with a detergent. Rinse and let dry before using.

Maintenance

The following sections are concerned with proper maintenance of the cleaner. Familiarize yourself with these home maintenance tasks and keep this owner's manual in a convenient place where you can refer to it when needed. Proper use and care of your cleaner will assure continued cleaning effectiveness.

The bag

Your cleaner has a durable outer bag which covers the throw away bag. A light wiping with a damp cloth will keep this outer bag clean.

When to replace the throw away bag

Check the bag from time to time. It is recommended that you change the bag when the dirt reaches the dotted line on the throw away bag. If you let more dirt than this accumulate, your cleaner may not operate effectively. Change bag frequently when using cleaner on new carpet, due to rapid accumulation of carpet fluff. Also check dirt duct (see section following belt replacement) for fluff accumulation.

Where to buy bags

Bags may be purchased from your local Authorized Hoover Dealer or from a Hoover Factory Service Center. **When ordering bags, be sure to give the model number of your cleaner.**

What bags to buy

Use HOOVER bag type **A** with this cleaner.

To assure that your HOOVER cleaner operates at peak performance, it is imperative that you use only genuine HOOVER throw away bags made by The Hoover Company. HOOVER bags can be identified by the trademarks — —

Hoover®



How to change bag

Disconnect cleaner from electrical outlet.



1. To remove old bag, put fingers behind bag collar, pull off and remove.

Dispose of old bag.

Do not try to clean out used bag. Cleaner will not operate effectively.

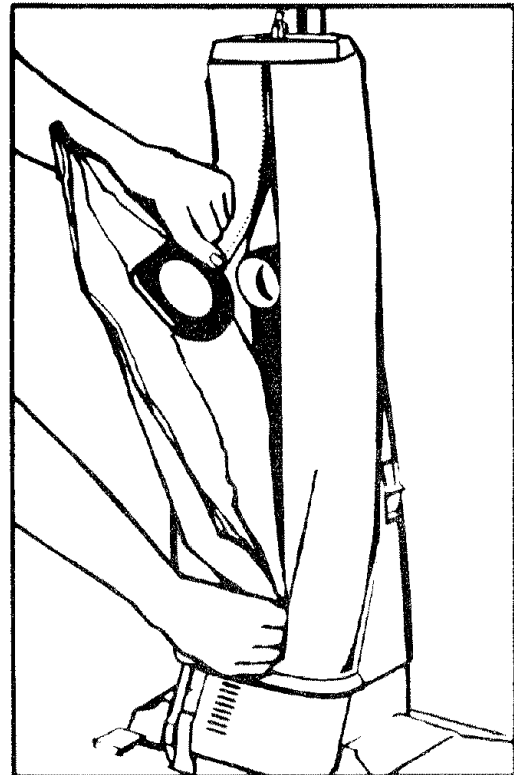

2. Tuck bottom of new paper bag in first.

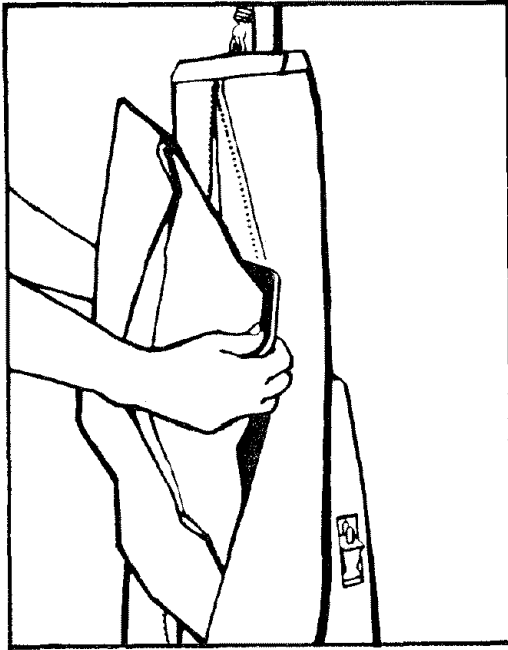

3. Push cardboard bag collar firmly onto fill tube by first, positioning bottom of collar, and then top, onto tube. Make sure the collar is pushed past the raised portion at the top and bottom and tightly in place on the tapered portion of the tube. This will insure a firmly sealed position.

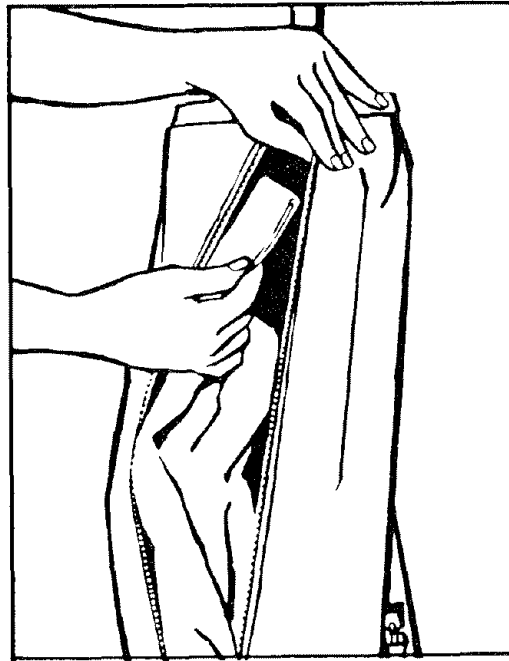

4. Tuck remainder of bag into outer jacket. Zip shut.

The headlight

Disconnect cleaner from electrical outlet.

This cleaner uses two 12 volt, wedge base type 912 bulbs.

1. Lower the handle until the cleaner is positioned with the bag flat on the floor.

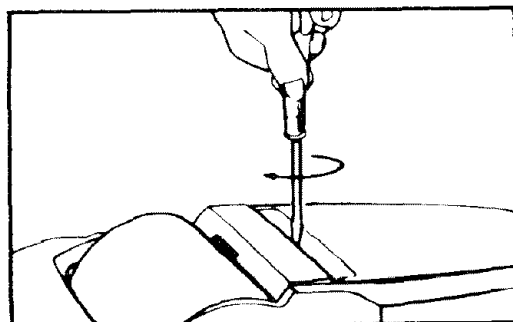
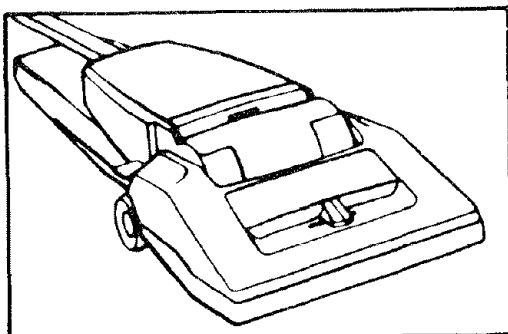

2. Use screwdriver to lift lens. Place screwdriver in the two slots provided at the top edge under ridge of lens as shown. Turn screwdriver to loosen lens.

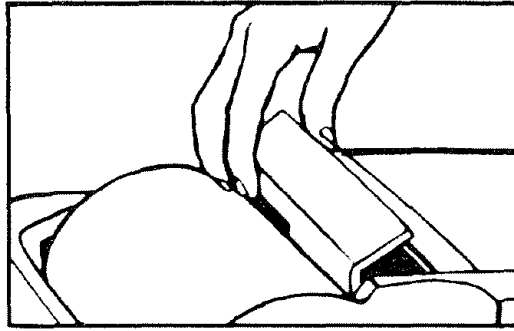

3. Lift out lens.

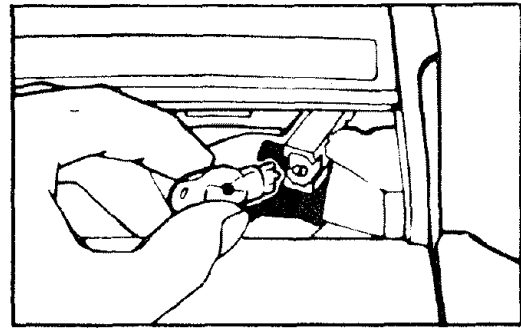

4. Remove bulbs by pulling straight out of sockets. Replace by pushing each bulb straight into the socket until it locks in place. (Excessive force is not required).

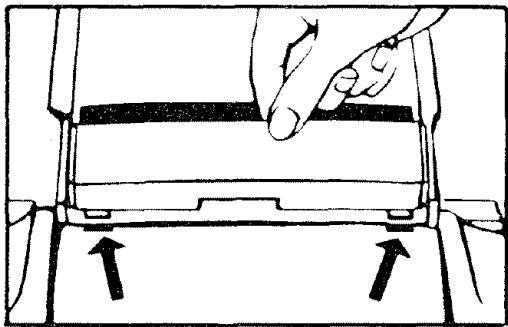

5. Replace lens by inserting plastic projections into openings in cleaner.

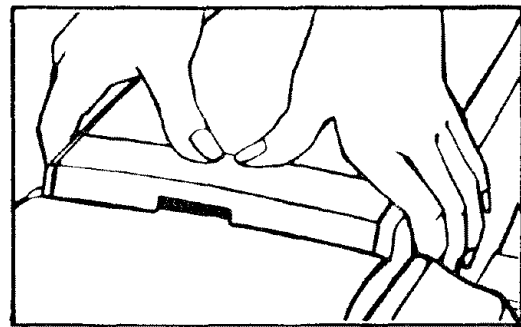

6. Press firmly at center and sides of lens to snap into place.

The belt

The belt drives the agitator and is important for the efficient operation of your cleaner. Because of this, when buying a new belt, you should always insist on a genuine HOOVER belt. Some other belts on the market, not manufactured under the Hoover design and quality controls, may not operate the agitator correctly and may damage your cleaner.

When to replace belt

Check from time to time to be sure the belt is in good condition. If it is stretched, cut, or broken, it should be replaced.

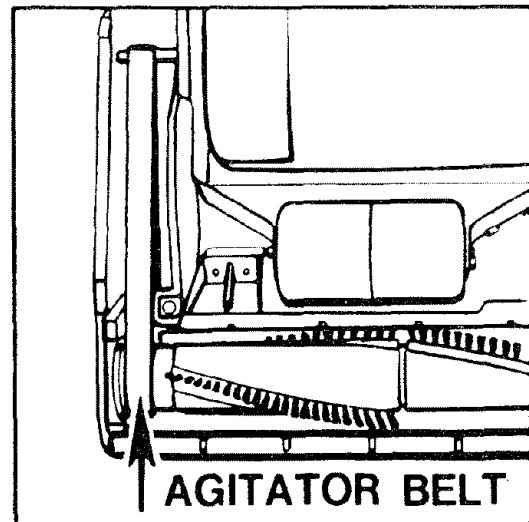

How to replace agitator belt

Disconnect cleaner from electrical outlet before replacing belt.

Place the cleaner on the floor. For ease in installation, follow the directions given below and position yourself to the **left, rear** of the cleaner.

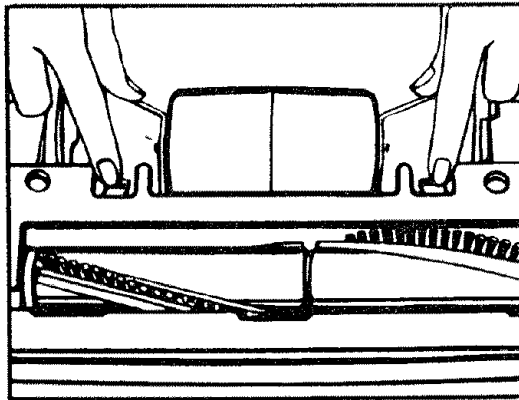

1. Turn cleaner over. Release handle to lowest position. Remove plate on bottom of cleaner by releasing clips. (See illustration)

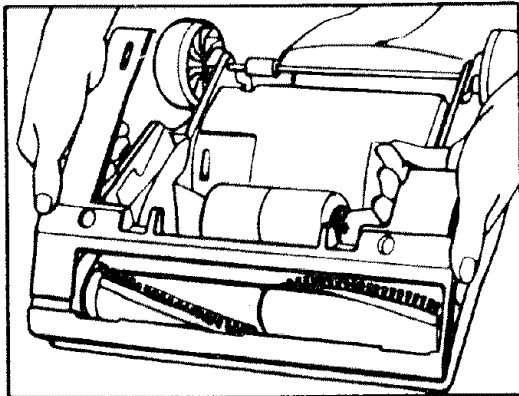

2. Remove bottom plate as shown.

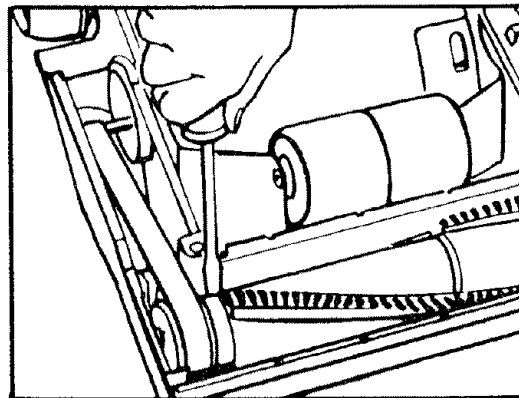

3. To remove the agitator, use a screwdriver placed as shown.

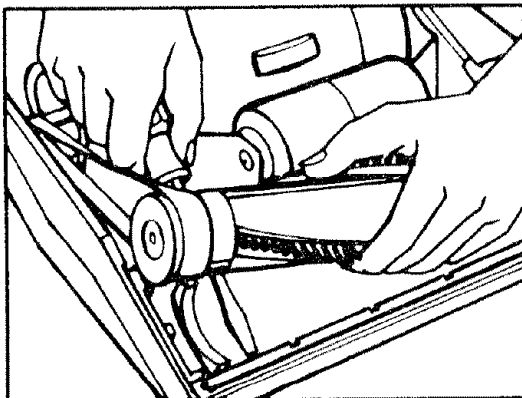

4. Use one hand to remove the agitator as you use leverage to lift the agitator with the end of the screwdriver. Remove old belt.

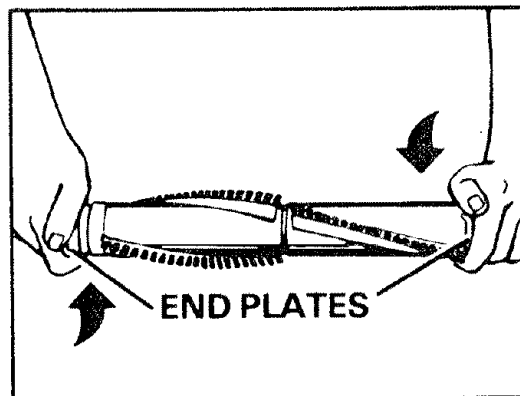

5. If the end plates have loosened, tighten them by turning in opposite directions.

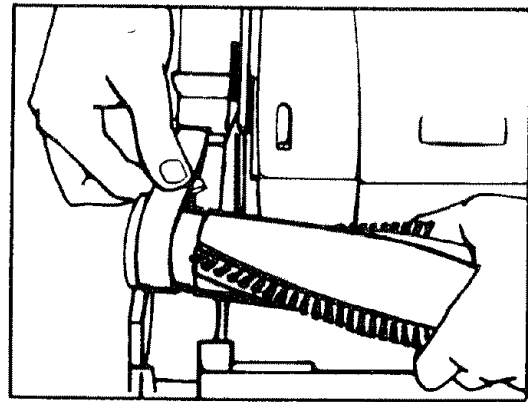
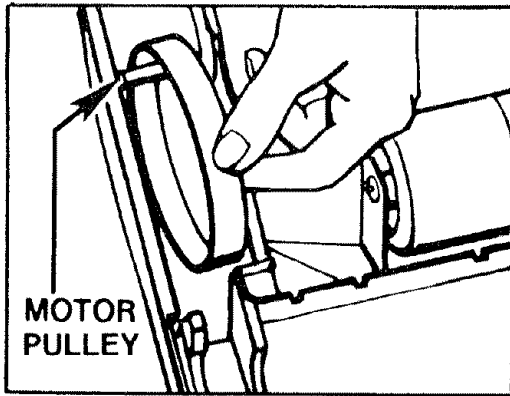

6. Place one end of the new belt over the metal motor pulley. Lettering on belt should be visible and not against pulleys. Slip the other end around the plastic pulley end of the agitator. (See illustration)

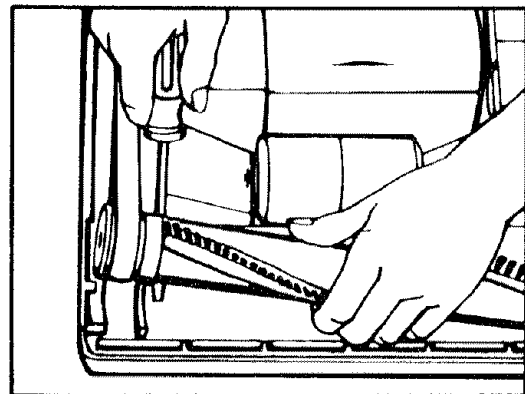
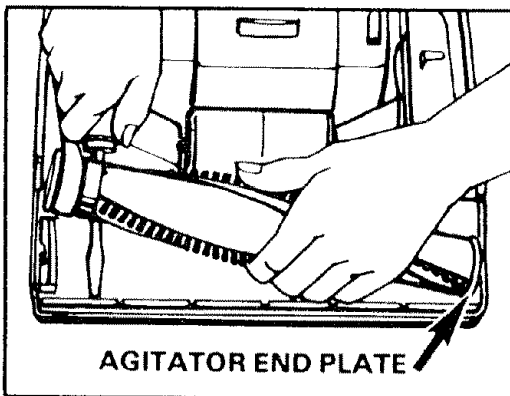

7. Grasp the agitator firmly with one hand. (Be sure you can see the agitator end plate.) Engage screwdriver as shown for leverage.

8. Lift and pull using screwdriver as a lever. Guide the end opposite the belt into position first.

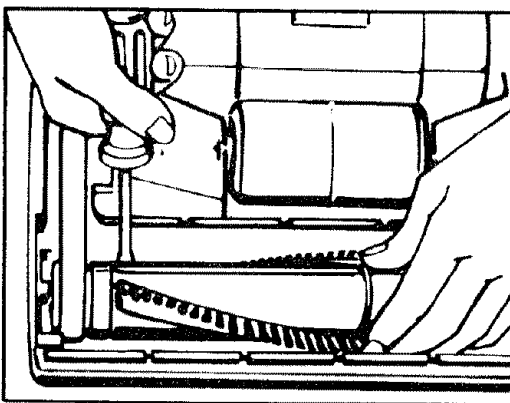

9. Quickly roll the other side of agitator into place.

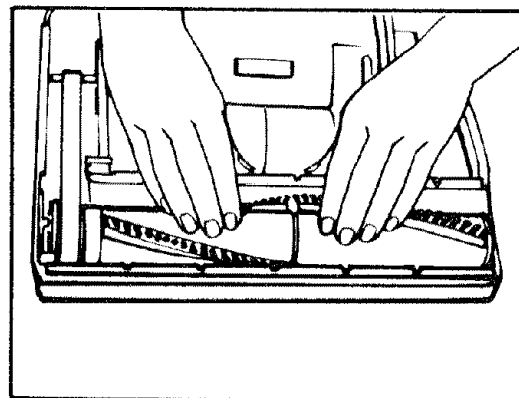

10. Press firmly to be sure agitator is securely in place.

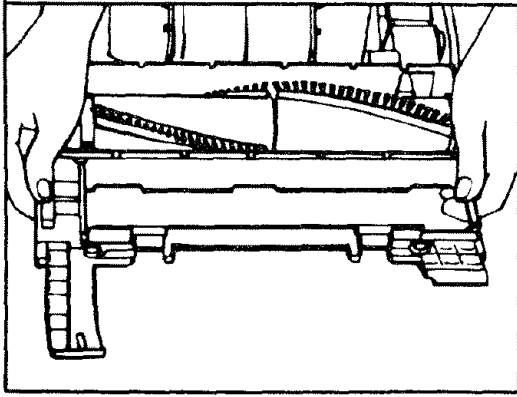

11. Bottom plate attaches in a hinge-like motion. Place the groove on the front of the bottom plate over the notched edge on the front of the cleaner.

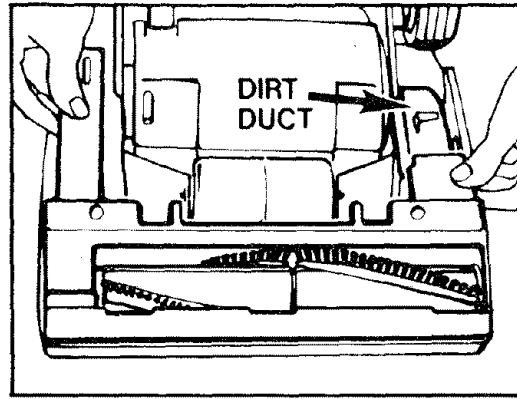

12. Maintaining front connection, rotate bottom plate to cover bottom of cleaner. Make sure dirt duct is in position under bottom plate. Press firmly.

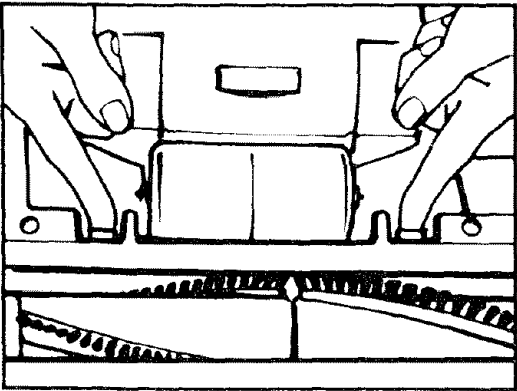

13. Lift and snap retaining clips into place.

Dirt duct and dirt tube

To maintain the strong suction and cleaning effectiveness of your cleaner, remove any large items from the carpet surface before vacuuming. However, if your cleaner picks up a larger object than can be exhausted in the bag, it can be caught in the dirt duct or dirt tube. These are easily cleaned out by the following methods.

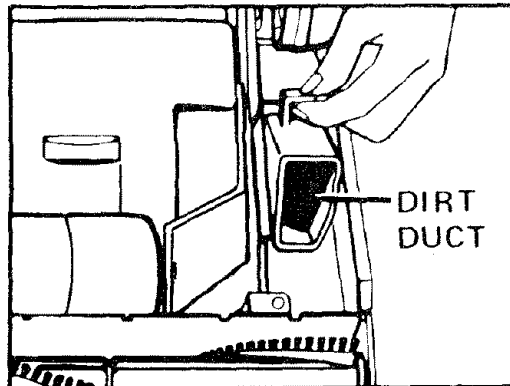

Disconnect cleaner from electrical outlet.

For access to the dirt duct, turn cleaner over to expose underside. Remove bottom plate. Lift dirt duct as shown and pull out any obstructions with your fingers. Reposition dirt duct by lowering to operating position and then replace bottom plate.

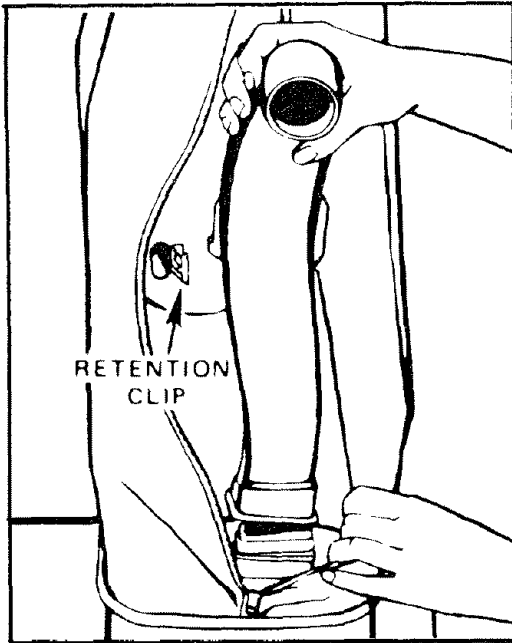

For access to the dirt tube, first remove disposable bag. Then remove dirt tube by pushing to either side to release clips. Lift dirt tube up and out.

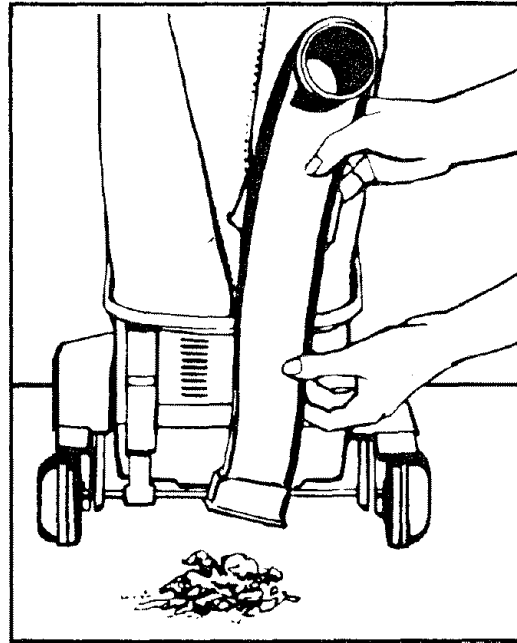

Clean out dirt tube.

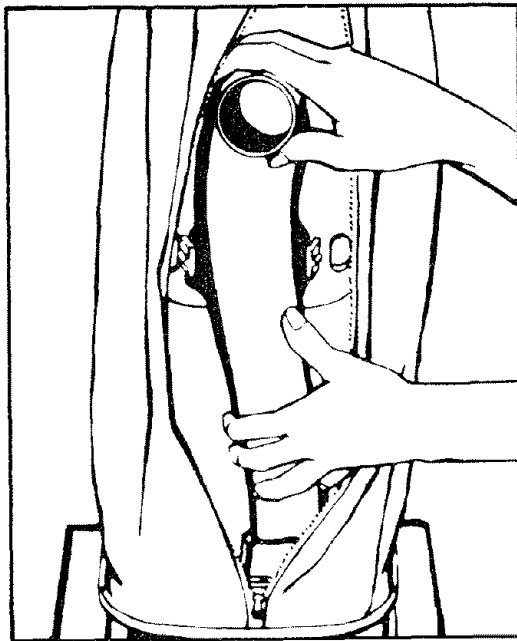

To replace dirt tube, position over lower seal and push down. Insert one side against retention clips. Push to snap other side into position.

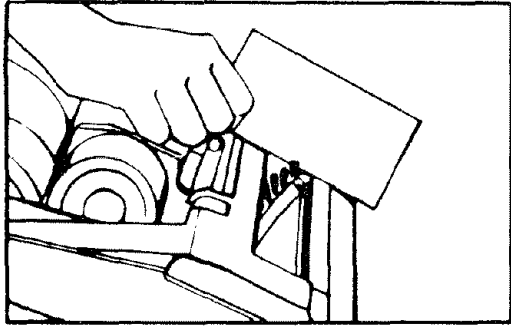

Agitator brushes

Disconnect cleaner from electrical outlet before checking brushes.

When brushes are worn and bristles do not touch the edge of a card held across the nozzle, they should be replaced. Always replace both brushes at the same time to maintain cleaning effectiveness.

To replace brushes

Disconnect cleaner from electrical outlet.

Remove bottom plate, belt and agitator following directions previously given.

1. Hold agitator as shown. Turn end plates in opposite directions until one end plate comes off.

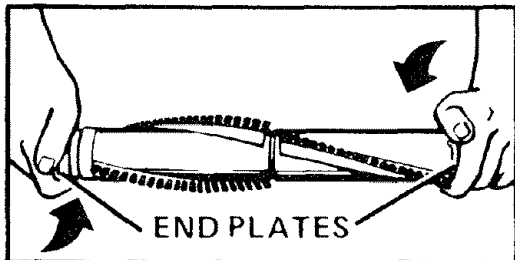

2. Pull or pry out end sections as shown in illustration.

Note: Pulley end should be removed by pulling straight out.

3. Note position of bar/brush assemblies to insure correct replacement.

Remove bar/brush assemblies by pulling them from agitator slots. Use pliers if necessary.

The word "BAR" is stamped near the slots on the agitator.

Match the bar side of the bar/brush assembly with the label on the agitator shell. Slide the new assemblies into the slots, while twisting the assemblies in a counterclockwise motion. Push in as far as possible, tapping the outer end lightly if necessary. Be sure brushes and bars are aligned for full length of agitator.

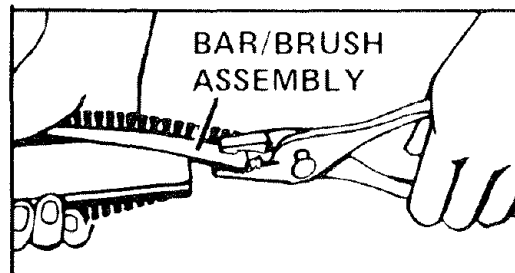
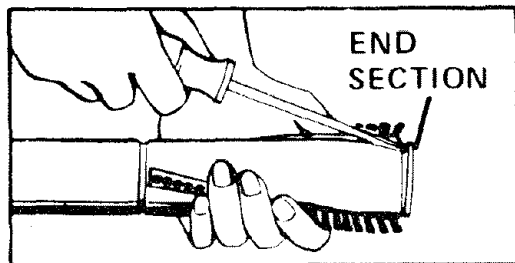

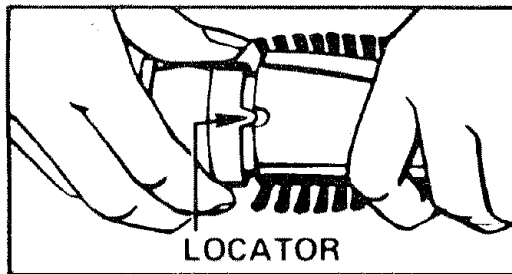

4. Reassemble agitator parts. Line up locator on end sections with slot on agitator. **Note:** Large locator on pulley end must align with large notch on agitator.

Screw on end plates and tighten.

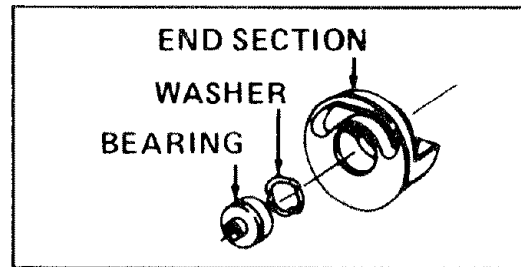

5. Should you accidentally displace the bearing during disassembly, reassemble as shown. Replace belt, agitator and bottom plate.

If you have a problem

This appliance was inspected thoroughly and was in good operating condition when it was shipped from the factory. If a minor problem develops, it usually can be remedied quite easily when the cause is identified. Accordingly, this check list is provided for your convenience.

Problem	Possible cause	Possible solution
Cleaner won't run	<ol style="list-style-type: none"> 1. Not firmly plugged in. 2. No voltage in wall plug. 3. Blown fuse/tripped breaker. 	<ol style="list-style-type: none"> 1. Plug unit in firmly. 2. Check fuse or breaker. 3. Replace fuse/reset breaker.
Cleaner won't pick up	<ol style="list-style-type: none"> 1. Broken or worn agitator belt. 2. Agitator brushes worn. 3. Bag full. 4. Obstruction in cleaner. 5. Bag not opening. 	<ol style="list-style-type: none"> 1. Replace belt. 2. Replace brushes. 3. Change throw away bag. 4. Clear pivoting dirt duct and/or dirt tube. 5. Check for firm bag connection.

If the problem persists, check the Yellow Pages of your telephone book under "Vacuum Cleaners - Household" for your nearest **Hoover Factory Service Center or Authorized Warranty Service Dealer** where approved HOOVER service and genuine HOOVER replacement parts may be obtained. The warranty provided with this product has a listing of the Hoover Factory Service Centers. If you are unable to obtain the information you need from the Yellow Pages, contact a Hoover Factory Service Center to find your nearest Authorized Warranty Service Dealer. For service under warranty, follow the instructions in the Warranty provided with this product.

Do not send your cleaner to The Hoover Company in North Canton for service as this will only result in delay.

Always identify your cleaner by model number when requesting information or ordering replacement parts. (The model number appears on the bottom of the cleaner.)

If further assistance is needed, contact **The Hoover Company Consumer Affairs Department, North Canton, Ohio 44720, 216-499-9200.**

Lubrication

The motor is equipped with one ball bearing and one needle roller bearing. These bearings contain sufficient lubrication for the life of the motor. The addition of lubricant could cause damage. **Therefore, do not add lubricant to either motor bearing.**

The agitator is equipped with two ball bearings that should be lubricated periodically. This should be done by a Hoover Factory Branch Service Center or an Authorized Hoover Warranty Service Dealer.

Energy saving tips

1. Replace throw away cleaner bag promptly, before overfilled, with a genuine HOOVER bag made for your cleaner model.
2. To maintain effective cleaning, replace agitator brushes and belt when necessary.
3. Turn off cleaner when not in use, such as when moving furniture.
4. Keep your cleaner operating at peak performance level - have inspection and service performed by a Hoover Factory Service Center or Authorized Hoover Service Dealer.

Consumer Information

This information has been compiled by the Vacuum Cleaner Manufacturers Association from Government and Private Sources concerned with product safety. These basic guidelines are for your protection and convenience.

TO AVOID ELECTRIC SHOCK

- Never vacuum damp or wet surfaces or liquids.
- Do not store machine outdoors.
- Replace worn or frayed power cord immediately.

TO AVOID ACCIDENTS

- Never vacuum live ashes or cigarette butts.
- Never run machine over or place sharp objects on the power cord.
- Never let children use machine as a toy.
- Use extra caution when cleaning on stairs.
- Except for hand-held cleaners, keep machine on floor – not on chairs, tables, etc.
- When machine is turned on, never allow fingers, eyes, hair, garments, etc. to come near intake suction ports or revolving brushes.
- Never leave machine running or cord plugged in when unattended.
- Turn machine off at switch before unplugging from wall outlet.
- When unplugging machine, grasp plug – not cord; guide cord and plug during wrapping or cord reel rewinding.
- The use of an extension cord is not recommended.
- Never vacuum in the presence of flammable or combustible liquids or fumes.
- Always unplug power cord from wall outlet before servicing machine or attaching accessories.
- Store machine promptly after each use to prevent accidents from tripping over power cord or machine.
- Use machine and accessories only in manner intended by manufacturers.

FOR BEST PERFORMANCE

Keep your machine and all accessories clean and in good operating condition.

Change or clean bags and/or filters as recommended by manufacturer to maintain optimum cleaning efficiency, after unplugging the power cord.

Periodically check revolving brush for build-up of lint, hair or other foreign material and remove as necessary, after unplugging the power cord.

Adjust or replace cleaning brushes when worn, after unplugging the power cord.

Have machine checked periodically by manufacturer's authorized service center.

Use only manufacturer's authorized service center for parts or service.

Store machine carefully in a dry area.

For optimum cleaning performance and safety, study and follow your Owner's Manual – keep it in a handy and safe place for future reference.

THE HOOVER COMPANY, NORTH CANTON, OHIO 44720