

**HOOVER®
Convertible
Vacuum
Cleaner**

**Top Pin
Models**

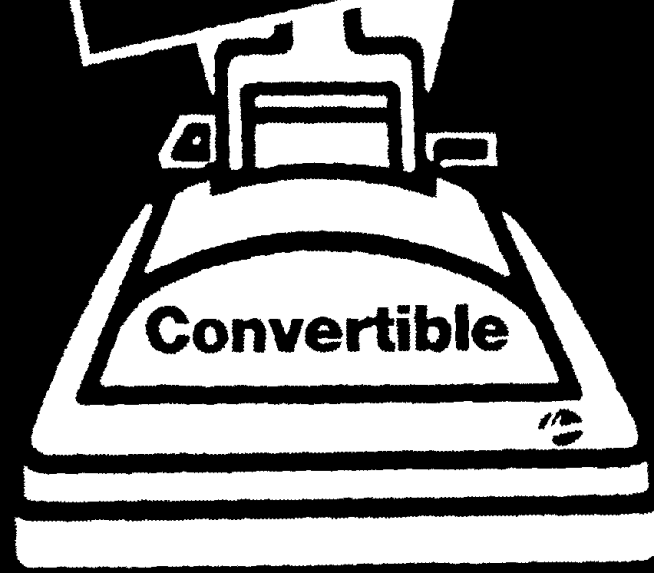

**Review
this manual
before
operating
cleaner**



Fill in and retain!

The HOOVER vacuum cleaner you have just purchased is a combination cleaner equipped with a two speed motor. One speed is utilized when the cleaner is being used on carpet and rugs, and a second higher speed is for use with attachments.

Your cleaner is a model * *

and has a serial number

For your personal records, please enter the model number and serial number in the spaces provided above and retain in a safe place.

The model number and serial number are on the bottom of the cleaner.

Save!

INDEX

Cleaner Description	3
Energy Saving Tips	2
How to Unpack and Assemble Cleaner	3-6
How to Use on Carpet and Floors	6-8
How to Use Cleaning Tools	9-13
Important Safeguards	2
Lubrication	18
Maintenance of 'Convertible' Cleaner	
Authorized Hoover Service	18
How to Replace Belt	15,16
How to Replace Brushes	16,17
How to Replace Headlight	14
Replacing the Bag	5,6,14
Second Speed	12
User Check List	18

Important safeguards!

- Read all instructions.
- Warning: Electric shock could occur if used outdoors or on wet surfaces.
- Close supervision is necessary when any appliance is used by or near children. Do not allow vacuum cleaner to be used as a toy or to run unattended at any time.
- Keep hands, feet, loose clothing, and hair away from rotating agitator.
- Don't run cleaner over cord. It may damage insulation.
- Do not use cleaner to pick up matches, or live ashes and cigarette butts.
- Avoid picking up hard, sharp objects with the cleaner. They may damage the cleaner and the bag.
- Unplug cleaner when not in use. Turn machine off at switch before unplugging.
- Always disconnect cord from electrical outlet before servicing the cleaner.
- Change bag frequently when picking up very fine materials such as powder.
- Grasp the plug to disconnect from wall outlet to avoid damage to cord, plug, prongs, or receptacle.
- The use of an extension cord is not recommended.
- If cleaner is in disrepair, do not attempt to operate.
- Have repairs made by the qualified personnel at Hoover Factory Service Centers or Authorized Hoover Warranty Service Dealers.
- Use vacuum cleaner only for its intended use as described in the instructions. The use of attachments not recommended by the appliance manufacturer may cause hazards.

Save these instructions!



ENERGY SAVING TIPS

1. Replace throw away cleaner bag promptly, before overfilled. Use a genuine HOOVER bag made for your model cleaner.
2. To maintain effective cleaning, replace agitator brushes and belt when necessary.
3. Turn off cleaner when not in use, such as when moving furniture.
4. Keep your cleaner operating at peak performance level - have inspection and service performed by a Hoover Factory Service Center or Authorized Hoover Service Dealer.

UNPACKING THE CLEANER

Unpack the cleaner from the carton and identify the parts shown in Fig. 1. Remove and dispose of the cardboard packing.

1. Upper handle section
2. Lower handle section
3. Cleaner base
4. Outer bag assembly
5. Disposable bag

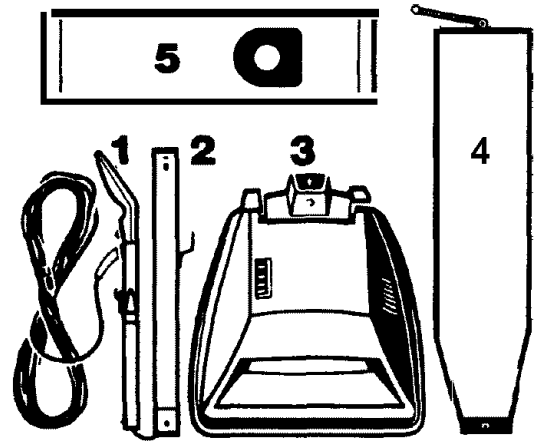
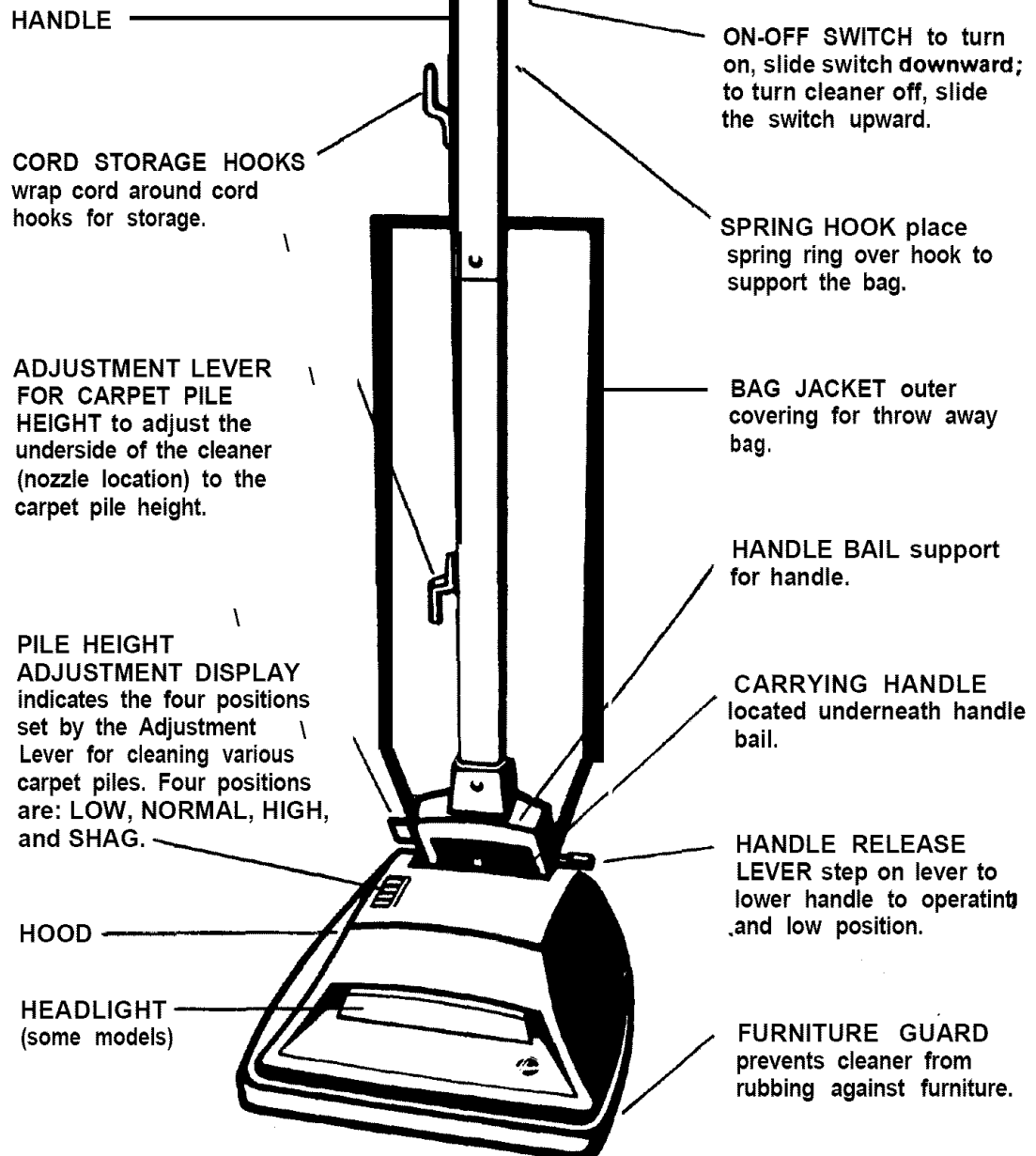
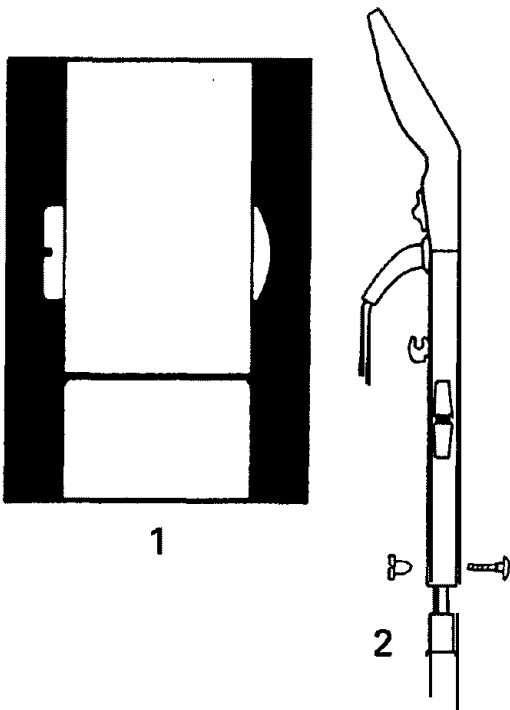

FIG. 1

The cleaner assembled will look like the drawing below.





HOW TO ASSEMBLE

A. Put handle together

Slide the two handle pieces together. Check to see that cord storage hooks are on the same side of handle. Insert bolt through small holes and secure with nut. Tighten nut with screwdriver. Fig. 1.

If the nut and bolt are not assembled as shown in the illustration, the holes in the handle are not lined up correctly. Fig. 2.

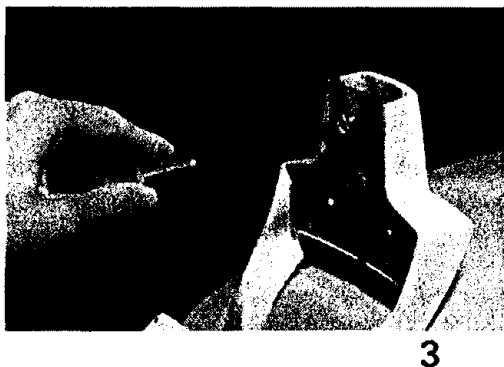

B. Attach handle to the cleaner

Unscrew nut and remove bolt from handle socket. Fig. 3.

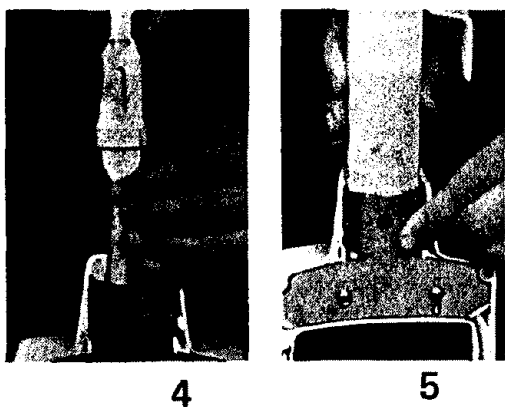

Connect electric plug on handle bail with the socket on the handle. Make sure plug assembly is positioned as shown in illustration. Fig. 4.

Push handle down into place in bail. The excess wire and electric connection is guided into the handle. Push down until handle is securely in place. Fig. 5.

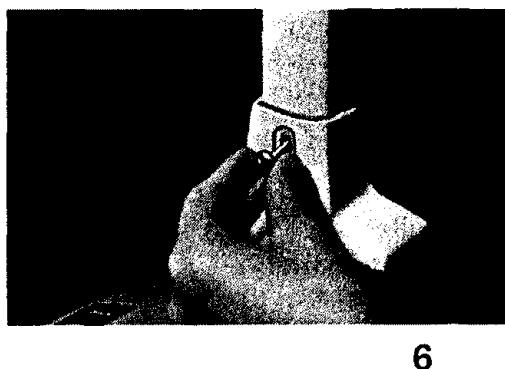

Insert second bolt through small holes of handle and secure with nut. Fig. 6. Tighten nut with screwdriver.

C. Attaching outer bag to cleaner

The outer bag is connected at the rear of the cleaner. There are two projections at the bottom of the outer bag assembly.

To attach outer bag to the cleaner, place the two projections at the bottom of the outer bag assembly inside the metal grooved plate. (You will find the grooved plate extending out from the bottom rear of the cleaner.) Fig. 1.

Just above the opening at the rear of the cleaner is the bag clip. Pull the bag clip to the left and fit bag against opening. When you release the bag clip, it should move to the right and fit completely over the bag lock. Fig. 2.

Attach the bag to the bag spring hook, which is located on the top section of the handle. Fig. 3.



D. Attach throw away bag to cleaner

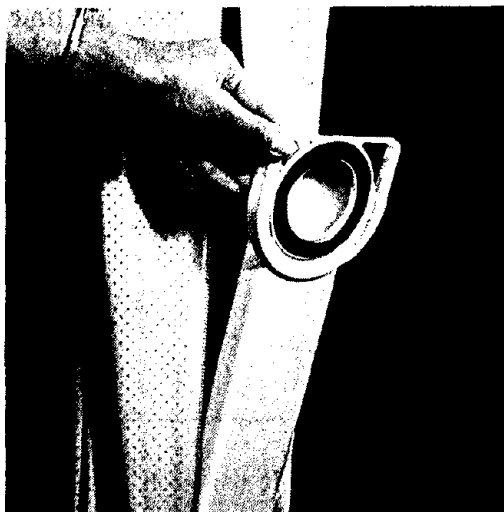

To attach throw away bag to cleaner, unzip outer bag. Pull out tube.

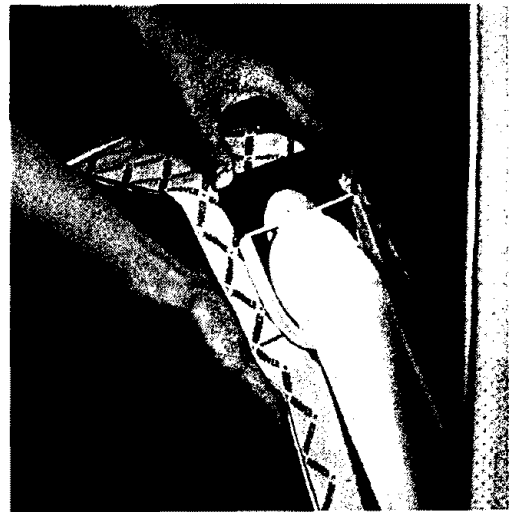

Insert curved collar of bag into holder. Slide collar of bag into slots of holder until it fits securely.



Pull out pleats of bag.

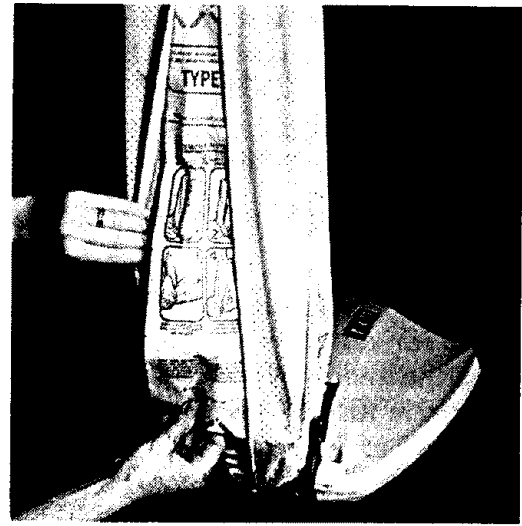

Tuck top of bag into outer bag; then bottom of bag into outer bag. Zip outer bag.

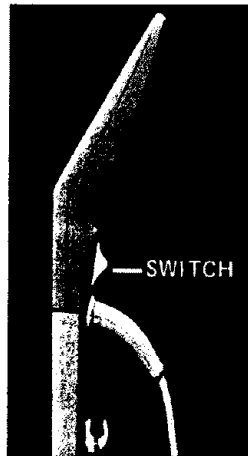

HOW TO USE THE CLEANER

How to operate

To turn cleaner on, push switch down.
To turn cleaner off, push the switch up.



Plug into electric outlet. Your cleaner is now ready to operate. Turn the cleaner on and push down on the handle until the front of the cleaner is free from the carpet. This insures that the throw away bag is inflated.

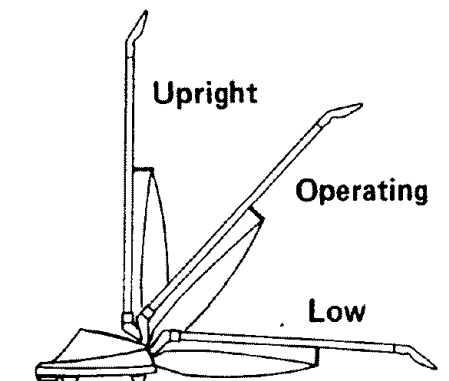

Handle adjustments

The handle of your cleaner has three positions: Upright for storage and when using attachments. Operating for general operation on carpet and floors. Low for reaching under low furniture.

Adjustment for carpet pile height

The cleaning of carpet and rugs takes place at the nozzle. This is the opening at the bottom of the cleaner where the agitator is located. Fig. 1.

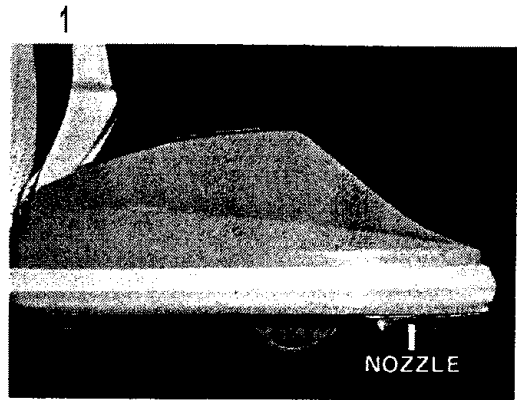

It is necessary to raise and lower the nozzle for various carpet pile heights. The adjustment lever raises and lowers the nozzle for various carpet pile and is located to the right of the bag near the bottom of the cleaner. The pile height adjustment displays in the window on top of the cleaner. Fig. 2.

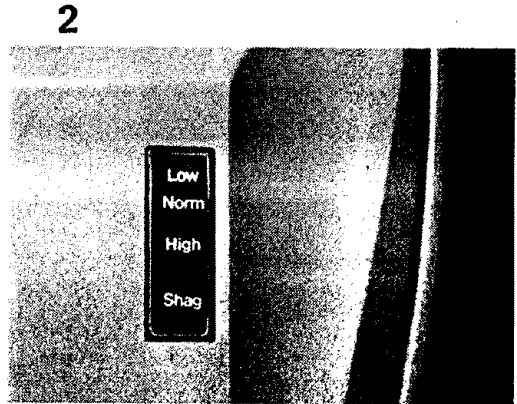

Select the desired nozzle adjustment by moving the lever with your toe until it “clicks” into the desired position. Fig. 3.

You can most easily make adjustments if you move the lever UPWARDS into the desired position. Therefore, when a downward adjustment is required, first press the lever all the way down into the SHAG position and then move upwards one position at a time. The nozzle adjustment display will indicate each pile height as you move the lever.

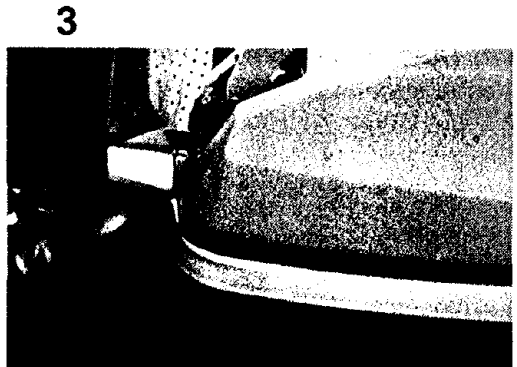

Select the adjustment for the carpet pile height according to the chart below.

.....
Low for low pile and kitchen carpet
.....

Normal for rugs with normal pile height and for removing loose dirt from hard surface floors
.....

High for rugs with normal pile height but thicker density; if the cleaner is difficult to push at “Normal”, move the lever to the “High” position
.....

Shag for very long or shag pile carpet
.....

Note: If the “Low” setting is used when cleaning normal or shag pile carpet, there is an increase in the belt load and pushing effort is greatly increased.



SPECIAL FEATURES

Carrying handle

Your cleaner has a convenient carrying handle located underneath the handle bail.

Edge cleaning

This feature improves the cleaning of carpet edges near baseboards and solid furniture. Dust and lint tend to collect along these edges. The cleaner bottom plate has been designed with a passageway for dirt to enter the nozzle from the side to increase cleaning ability of edges. From the right or left side, slowly guide the cleaner parallel to the edge of the carpet.

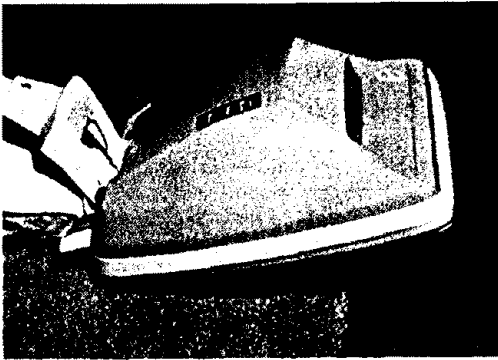

Cleaning lightweight flexible rugs

Lightweight flexible rugs used on hard surface floors in entrances, bathrooms, etc. should be cleaned by the following method.

Stand on one end of the rug and move the cleaner toward the other end or edge. Before reaching the other end, push down on the handle. This will lift up the nozzle (front of cleaner) and will prevent the rug from clinging to the cleaner. Continue to lift up the nozzle so that when you have reached the edge, it is completely off the rug. Move the cleaner back to start again and lower the nozzle, using only forward strokes.

CLEANING TOOL ATTACHMENTS

Cleaning tools are available for this cleaner at additional cost from Hoover Dealers. The cleaning tools allow you to do above the floor cleaning and to clean hard to reach areas.

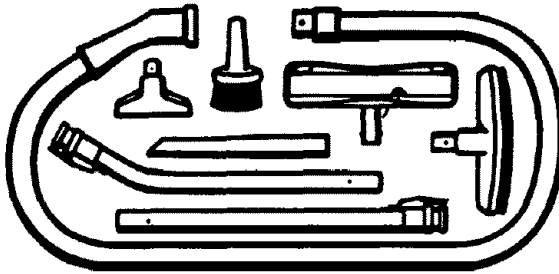

Deluxe cleaning set Includes vinyl hose, converter, curved wand, straight wand, dusting brush, furniture nozzle, wall/floor brush, crevice tool and a storage bag.

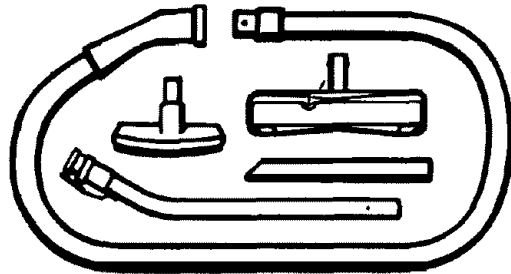

Standard cleaning set Includes vinyl hose, converter, curved wand, crevice tool and upholstery brush.

You can convert your cleaner for use with the attachments in a matter of seconds and you will find a tool for almost every cleaning job in your home. When using attachments, follow the simple steps discussed in this section:

- A. Attach the converter
- B. Select the desired tool
- C. Attach the tool
- D. Have cleaner in upright position when using cleaning tools.

USING CLEANING TOOLS

A. Attach converter

By using the converter attachment, Fig. 1, you can channel the suction from the cleaner to the hose and cleaning tools. The converter must first be attached to the vinyl hose; then the converter is attached to the bottom of the cleaner. Follow the steps detailed here for attaching the converter.

To attach the converter to the vinyl hose, insert converter into hose connector. Fig. 2.

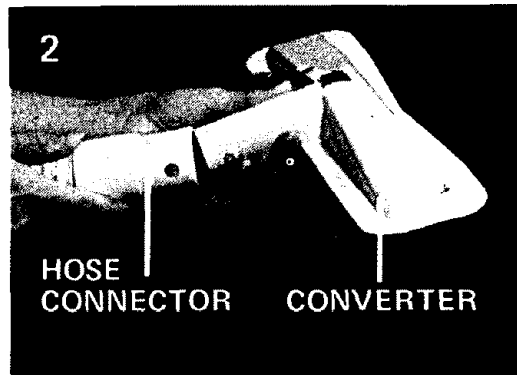
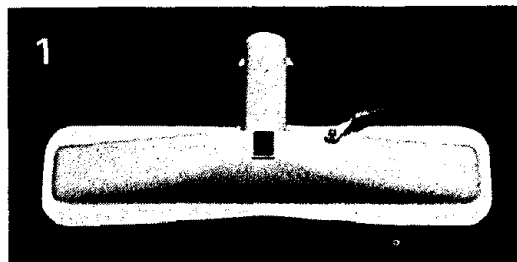

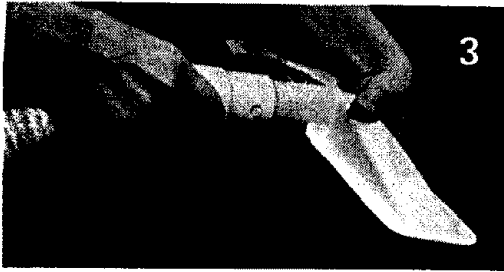

Push connector and converter together and twist.

The converter is locked into position when the projections on the converter fit into the holes on the hose connector. Fig. 3.

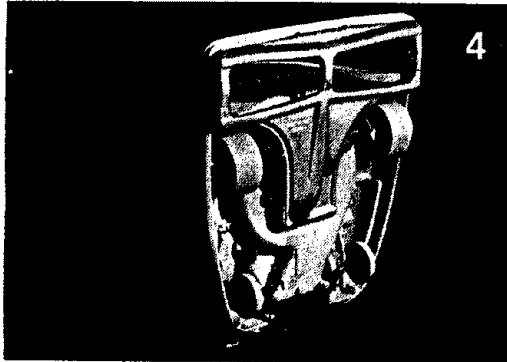

To attach the converter to the cleaner, first unplug cord. Warning: Cleaner must not be running when positioning or removing front converter.

Have cleaner in upright position. Grasp handle of cleaner and lean backwards so that bag is flat on the floor and the underside is visible. Fig. 4.

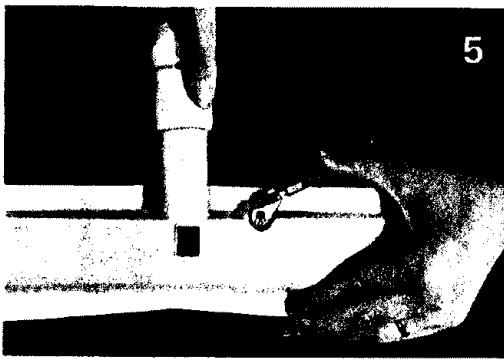

Grasp the converter; turn red converter lock away from the hose. Fig. 5.



Place plastic latches of converter onto metal rim of bottom plate. Fig. 6.

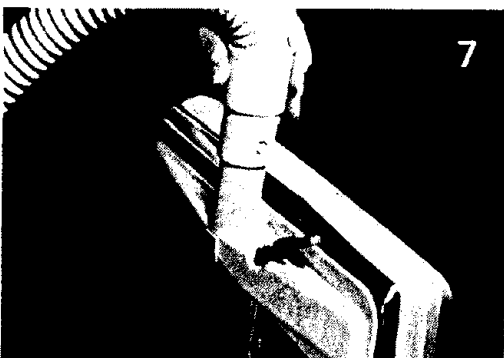

Bring converter up until it covers the opening. Fig. 7.

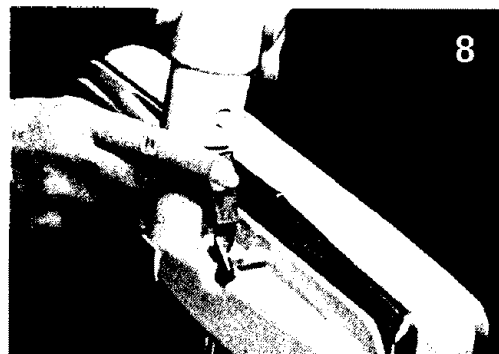

To lock in place, turn red converter lock toward the vinyl hose. Fig. 8

Raise cleaner to upright position.

B. Select the proper cleaning tool

The cleaning tools have many uses. Select the tool best suited for the cleaning task from the descriptions below.

Wall/floor brush For walls and very irregular hard surface floors such as brick and slate. Fig. 1.

Furniture nozzle For upholstered furniture, draperies, tapestries, mattresses, clothing, automobile interiors and carpeted stairs. Fig. 2.

Dusting brush For carved furniture, table tops, books, lamps, lighting fixtures, Venetian blinds, baseboards, shutters and registers. Fig. 3.

Crevice tool For radiators, dresser drawers, spaces between kitchen appliances. Fig. 4.

Straight* and curved wands Used to give extra length to your vinyl hose. They are ideal to reach ceilings, the top of draperies, high shelves and cupboards. Use the straight and curved wands with any of the above tools. Fig. 5.

*Available only in deluxe sets.

C. Attaching the tools

After having chosen the proper tool for your particular task, attach it to the end of the vinyl hose.

The outer plastic ring on the end of the hose has a slot which adjusts. Note the slot in the hose grip. Turn the outer ring until the slots align. Fig. 6.

Insert the tool so that the button on the tool fits into the slot in the end of the vinyl hose. Fig. 7.

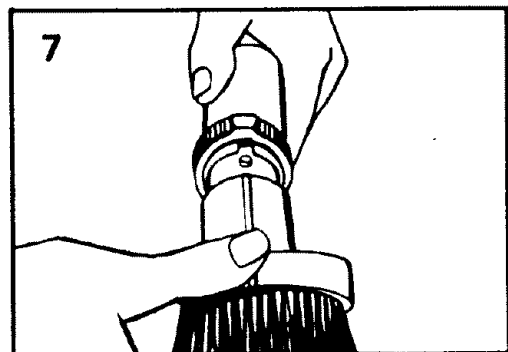
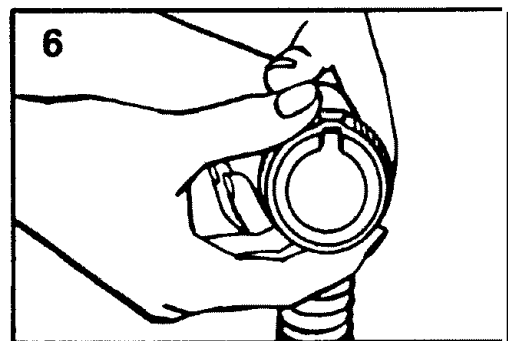
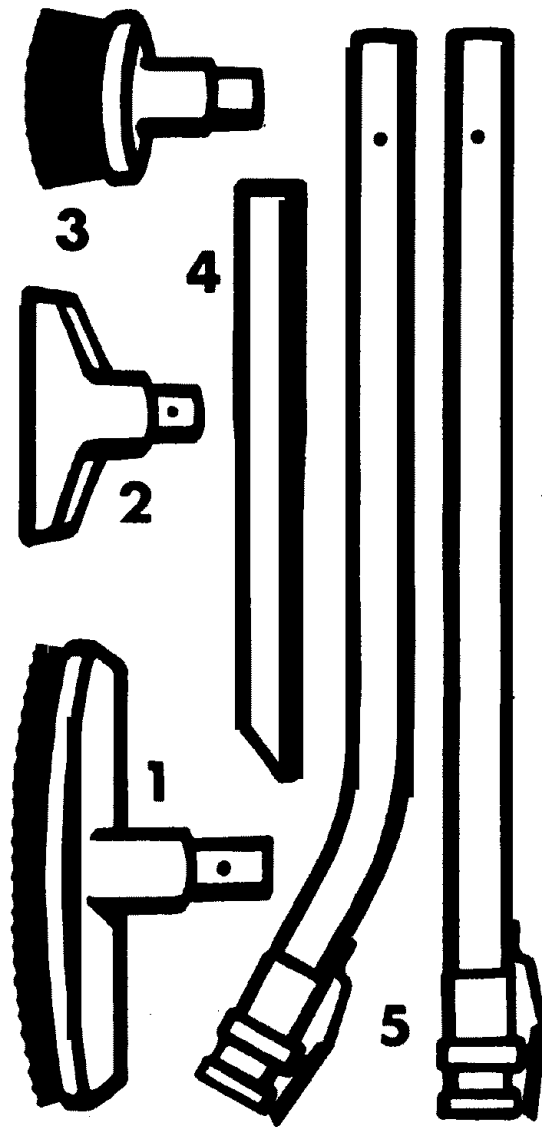

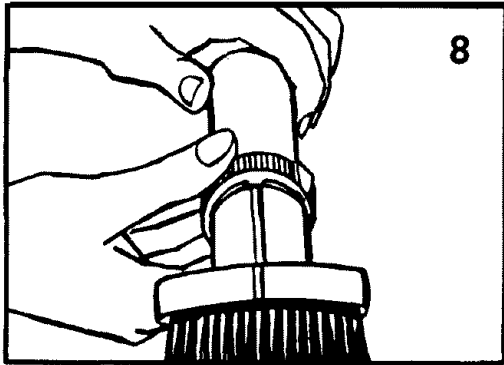

Turn the plastic ring counterclockwise to lock the tool in place. Fig. 8.

For additional length, attach one or both* wands to the vinyl hose as described in the preceding section.

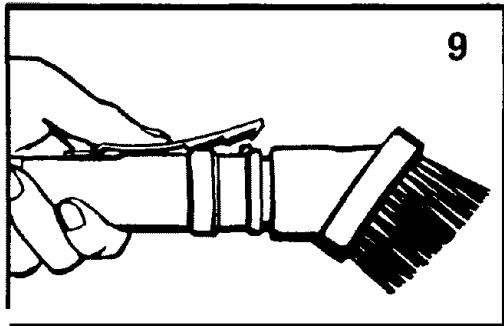

To attach the tools to the other end of the wand, press down firmly on the white plastic spring latch. Fig. 9. Fit the attachment into place and release plastic latch when it fits over button on tool. It is now locked in place.

*Available with deluxe sets only,

D. Engaging the higher speed for using attachments

Your cleaner is equipped with a two-speed motor. One speed is utilized when the cleaner is being used on carpet and rugs, and a second higher speed is for use with attachments.

Upon insertion of the converter and having the cleaner handle in the upright position, the motor automatically adjusts to the higher speed.

Therefore, for effective operation it is important to have your cleaner handle in the upright position when using the attachments.

When using the cleaning tools, the adjustment for carpet pile height should be set according to the surface on which the cleaner is standing. This will give added stability when using the attachments. Set the adjustment for pile height to LOW if using the cleaning tools in an area where there are bare floors and use SHAG in carpeted areas.

After having followed the steps detailed above you are ready to use your cleaning attachments. Simply turn the cleaner switch to the ON position and you are ready to clean above the floor and all those hard to reach areas in your home. The handle must be in the upright position for proper, effective use of tools.

Storing attachments

Your attachment set has been designed so that it will fit in a storage bag". The bag has two slots located near the top for use in hanging. Therefore, it can be attached to the cleaner on hung conveniently on a hook in the closet.

To clean attachments To clean the hose wipe off dirt with a cloth dampened with a liquid detergent. Rinse with a damp cloth. Cleaning tools may be washed in warm water with a detergent. Rinse and let dry before using.

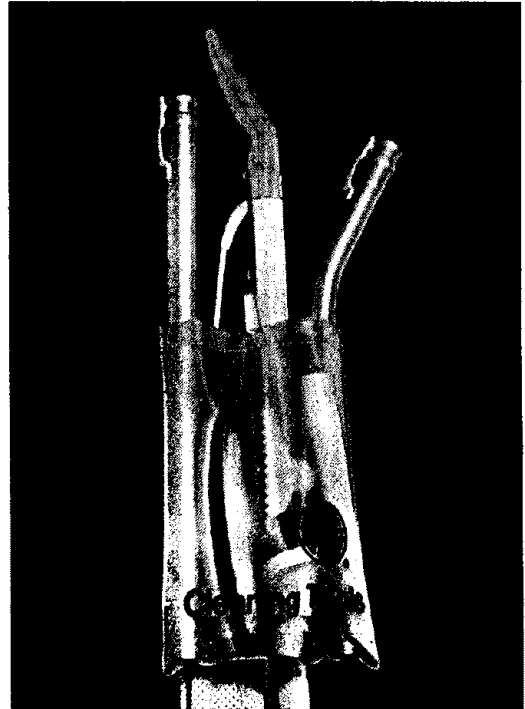

"Available with deluxe sets only.

MAINTENANCE

The following sections are concerned with proper maintenance of the cleaner. Familiarize yourself with these home maintenance tasks and keep this owner's manual in a convenient place where you can refer to it when needed. Proper use and care of your cleaner will insure continued cleaning effectiveness.

The bag

Your cleaner has a durable outer jacket which covers the throw away bag. A light wiping with a damp cloth will keep this outer jacket clean.

When to replace the throw away bag

Check the bag from time to time. It is recommended that you change the bag when the dirt reaches the dotted line on the throw away bag. If you let more dirt than this accumulate, your cleaner may not operate effectively.

Where to buy bags

Bags may be purchased from your local Authorized Hoover Dealer or from a Hoover Factory Service Center. When ordering bags, be sure to give the model number of your cleaner.

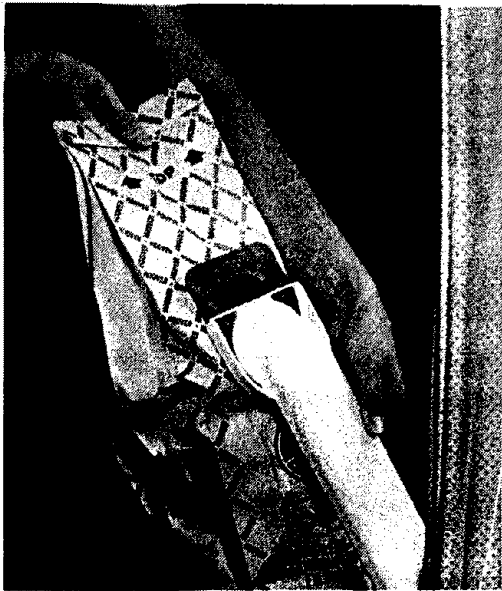

What bags to buy

Use HOOVER bag type A with this cleaner.

To assure that your cleaner operates at peak performance, it is imperative that you use only genuine HOOVER throw away bags made by The Hoover Company. HOOVER bags can be identified by the trademarks --

Hoover®



How to change bag

To change bag, unzip outer bag and gently pull top of throw away bag upward. See illustration.

Note: Do not clean out old bag and re-use. Discard used bag. To install new bag refer to pages 5 and 6.

How to replace the headlight (Available on deluxe models only.)

Disconnect the cleaner from electrical outlet.



1. Set adjustment lever for pile height to the "NORMAL" or "HIGH" position.

2. Turn cleaner over and remove the two screws indicated in the illustration. Place cleaner in the upright position. Slip hood up off of the cleaner casting.

3. Take off hood and check bulb type. Remove and replace bulb as directed.

Bayonette type bulb (Sylvania 15T7DG). Remove bulb by pressing in and turning in a counterclockwise direction. Replace by pressing bulb in and turning in a clockwise direction.

Wedge type bulb (GE 912 or equivalent) Remove bulb by pulling straight out of socket. Replace by pushing bulb straight into socket until it locks in place. (Excessive force is not required).

4. Replace hood. Position furniture guard onto casting of cleaner. Tighten screws.

The belt

The belt of your HOOVER cleaner controls the speed of the agitator and it is important for the effective operation of your cleaner. The belt is located under the bottom plate of the cleaner and should be checked from time to time to be sure it is in good condition.

When to replace the belt

To check the belt, remove the bottom plate (see following section). If the belt is stretched or cut; or if the agitator fails to rotate, replace the belt.

What belt to buy

To assure effective operation, use only genuine HOOVER belts with your HOOVER 'Convertible' cleaner. When purchasing a new belt ask for Hoover part No. 49258.

How to replace the belt Disconnect cleaner from electrical outlet.

1. Turn cleaner over. Remove metal plate on bottom of cleaner by pushing latches toward outside of cleaner.

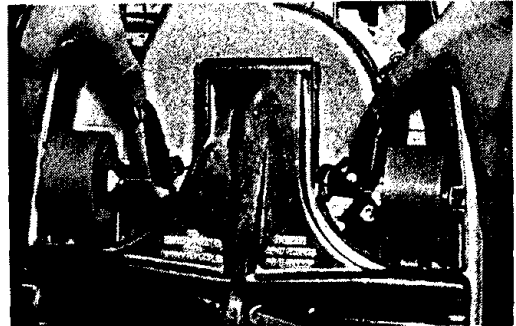

2. Release worn belt from pulley.

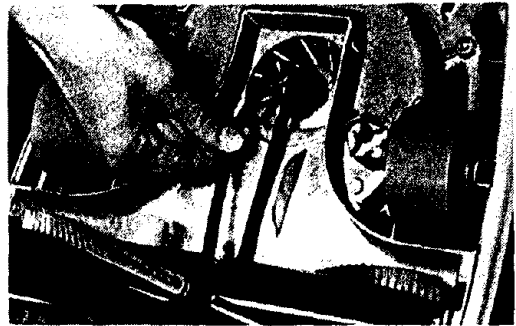

3. Lift out rug agitator, remove old belt and place new belt in groove of rug agitator.

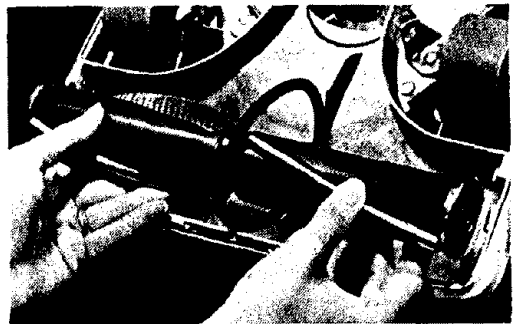

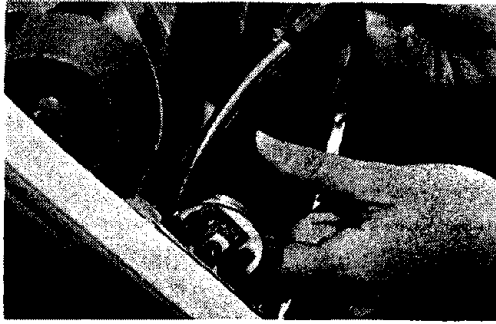

4. Replace agitator. On one end of the agitator roll there is a raised metal plate. Make sure that this end is placed in groove on side of cleaner.

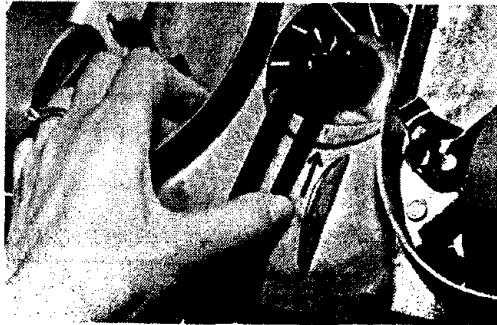

5. Place belt on pulley. Side of belt nearer cleaner should be in line with arrow on bottom of cleaner.

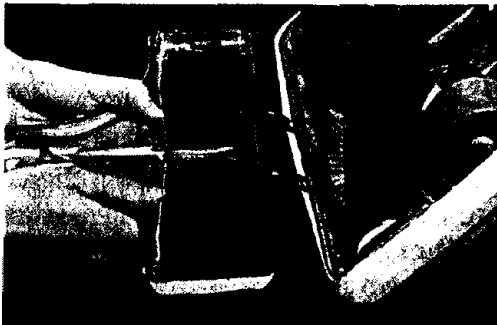

6. Replace metal plate. Place metal knobs on front end of plate in wire holders. Check to see that latches are pushed back and will not be covered by plate. Place plate in position and latch securely.

The brushes

When to replace brushes

When brushes are worn and bristles do not touch the edge of a card held across the bottom plate, they should be replaced. Always replace both brushes at the same time to maintain cleaning effectiveness.

What brushes to buy

When purchasing new brushes, ask for Hoover part No. 19799. They are designed to be used with your cleaner.



How to replace the brushes

Disconnect the deaner **from** electrical outlet.

1. To replace worn brushes, remove bottom plate, belt and agitator, following directions given on preceding pages.

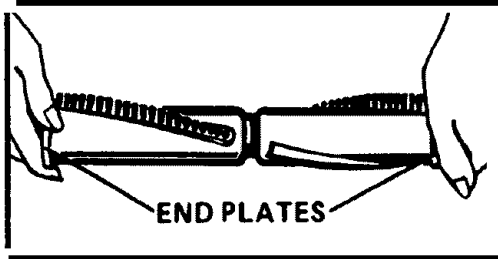

2. Turn end plates of agitator counterclockwise until one end plate comes off.

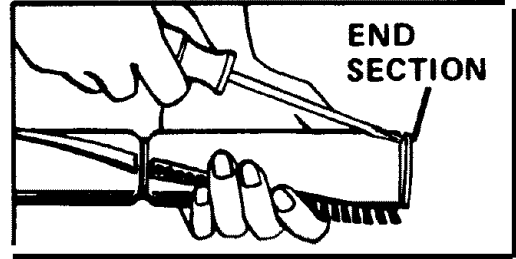

3. Then pry out end section as shown.

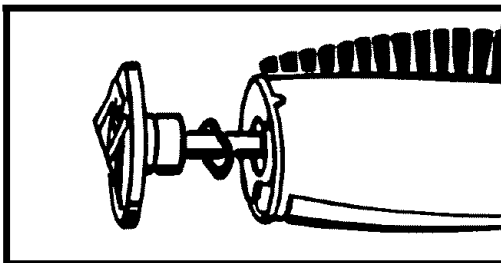

4. Remove opposite end plate and shaft by pulling straight out. Pry out remaining end section.

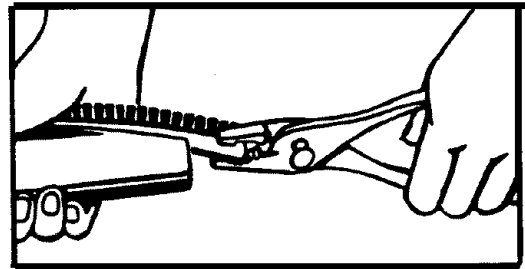

5. Remove brushes by pulling them from agitator. Use pliers if necessary. Slide new brushes into channels. Push them in as far as possible.

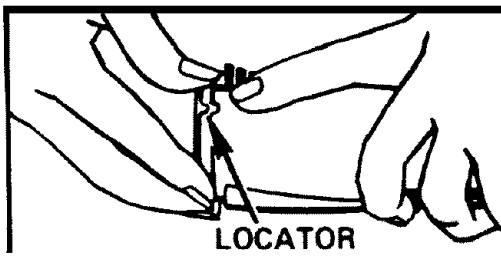

6. To reassemble, reverse procedure. Replace first, the last end section removed, then end plate and shaft. Replace remaining end section and end plate. Be sure end sections are assembled with locator lined up with slot in agitator.

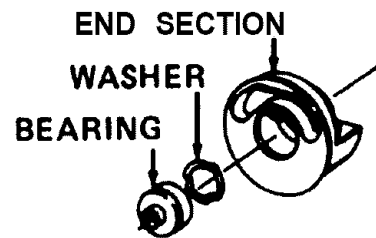

7. Should you accidentally displace the bearing during disassembly, reassemble as shown.

User check list

This appliance was inspected thoroughly and was in good operating condition when it was shipped from the factory. If a minor problem develops, it usually can be remedied quite easily when the cause is identified. Accordingly, this check list is provided for your convenience.

Problem	Possible cause	Possible solution
Cleaner won't run	1. Not firmly plugged in. 2. No voltage in wall plug. 3. Blown fuse/tripped breaker.	1. Plug unit in firmly. 2. Check fuse or breaker. 3. Replace fuse/reset breaker.
Cleaner won't pick up	1. Broken or worn belt. 2. Agitator brushes worn. 3. Bag full. 4. Incorrect carpet adjustment lever setting.	1. Replace belt. 2. Replace brushes. 3. Empty bag. 4. Set carpet adjustment lever for type carpet being cleaned.
Cleaner hard to push	1. Incorrect carpet adjustment lever setting. 2. Belt on backwards.	1. Set carpet adjustment lever for type carpet being cleaned. 2. Position belt correctly.

If the problem persists, check the Yellow Pages of your telephone book under "Vacuum Cleaners - Household" for your nearest Hoover Factory Service Center or Authorized Warranty Service Dealer where approved service and genuine HOOVER replacement parts may be obtained. The warranty provided with this product has a listing of the Hoover Factory Service Centers. If you are unable to obtain the information you need from the Yellow Pages, contact a Hoover Factory Service Center to find your nearest Authorized Warranty Service Dealer. For service under warranty, follow the instructions in the Warranty provided with this product.

Always identify your cleaner by model number when requesting information or ordering replacement parts. (The model number appears on the bottom of the cleaner.)

If further assistance is needed, contact the Hoover Company Consumer Affairs Department, North Canton, Ohio 44720, 216-499-9200.

Lubrication

The motor is equipped with one ball bearing and the agitator has two ball bearings. These bearings occasionally need attention.

Ball bearings should be checked annually and lubrication of all ball bearings should be performed by a Hoover Factory Branch Service Center or an Authorized Warranty Service Dealer.

Consumer Information

This information has been compiled by the Vacuum Cleaner Manufacturers Association from Governmental and Private Sources concerned with product safety. These basic guidelines are for your protection and convenience.

TO AVOID ELECTRIC SHOCK

- Never vacuum liquids.
- Never vacuum carpeting that is damp or wet.
- Do not store machine outdoors.
- Replace worn or frayed power cord immediately.

TO AVOID ACCIDENTS

- Never vacuum live ashes or cigarette butts.
- Never run machine over power cord or place sharp objects on it.
- Never let children use machine as a toy.
- Use extra caution when cleaning on stairs.
- Keep machine on floor — not on chairs, tables, etc.
- When machine is turned on, never allow fingers, hair or garments to come near intake suction ports or revolving brushes.
- Never leave machine running or cord plugged in when unattended.
- Turn machine off at switch before unplugging from wall outlet.
- When unplugging machine, grasp plug — not cord.
- Always unplug power cord from wall outlet before servicing machine or attaching accessories.
- Store machine promptly after each use to prevent accidents from tripping over power cord or machine.
- Use machine and accessories only in manner intended by manufacturer.

FOR BEST PERFORMANCE

- Keep your machine and all accessories clean and in good operating condition.
- Change or clean bags and/or filters as recommended by manufacturer to maintain optimum cleaning efficiency.
- Periodically check revolving brush for build-up of lint, hair or other foreign material and remove as necessary.
- Adjust or replace cleaning brushes when worn.
- Buy replacement parts from manufacturer's authorized service center.
- Have machine checked periodically by manufacturer's authorized service center.
- Store machine carefully — in dry area — never outdoors.
- For optimum cleaning performance and safety, study and follow your Owner's Manual — keep it in a handy and safe place for future reference.

THE HOOVER COMPANY, NORTH CANTON, OHIO 44720