

FLAT TV



SEE EVERY THING EXPERIENCE EVERY THING

PHILIPS

Return your Warranty Registration card today to ensure you receive all the benefits you're entitled to

Registering your model with PHILIPS makes you eligible for all of the valuable benefits listed below, so don't miss out. Complete and return your Product Registration Card at once to ensure:

* Proof of Purchase

Returning the enclosed card guarantees that your date of purchase will be on file, so no additional paperwork will be required from you to obtain warranty service.

* Product Safety Notification

By registering your product you'll receive notification - directly from the manufacturer - in the rare case of a product recall or safety defect.

* Additional Benefits of Product Ownership

Registering your product guarantees that you'll receive all of the privileges to which you're entitled, including special money-saving offers.

PHILIPS

Congratulations on your purchase, and welcome to the "family!"

Dear PHILIPS product owner:

Thank you for your confidence in PHILIPS. You've selected one of the best-built, best-backed products available today. We'll do everything in our power to keep you happy with your purchase for many years to come.

As a member of the PHILIPS "family," you're entitled to protection by one of the most comprehensive warranties and outstanding service networks in the industry.

What's more, your purchase guarantees you'll receive all the information and special offers for which you qualify, plus easy access to accessories from our convenient home shopping network.

Most importantly, you can count on our uncompromising commitment to your total satisfaction.

All of this is our way of saying welcome - and thanks for investing in a PHILIPS product.

P.S. To get the most from your PHILIPS purchase, be sure to complete and return your Product Registration Card at once.

Know these safety symbols



 This "bolt of lightning" indicates uninsulated material within your unit may cause an electrical shock. For the safety of everyone in your household, please do not remove product covering.

 The "exclamation point" calls attention to features for which you should read the enclosed literature closely to prevent operating and maintenance problems.

WARNING: To reduce the risk of fire or electric shock, this apparatus should not be exposed to rain or moisture and objects filled with liquids, such as vases, should not be placed on this apparatus.

CAUTION: To prevent electric shock, match wide blade of plug to wide slot, fully insert.

ATTENTION : Pour éviter les choc électriques, introduire la lame la plus large de la fiche dans la borne correspondante de la prise et pousser jusqu'au fond.

For Customer Use

Enter below the Serial No., which is located on the rear of the cabinet. Retain this information for future reference.

Model No. _____
Serial No. _____



PHILIPS

Visit our World Wide Web Site at <http://www.philips.com>

IMPORTANT SAFETY INSTRUCTIONS

Read before operating equipment

1. Read these instructions.
2. Keep these instructions.
3. Heed all warnings.
4. Follow all instructions.
5. Do not use this apparatus near water.
6. Clean only with a dry cloth.
7. Do not block any of the ventilation openings. Install in accordance with the manufacturers instructions.
8. Do not install near any heat sources such as radiators, heat registers, stoves, or other apparatus (including amplifiers) that produce heat.
9. Do not defeat the safety purpose of the polarized or grounding-type plug. A polarized plug has two blades with one wider than the other. A grounding type plug has two blades and third grounding prong. The wide blade or third prong are provided for your safety. When the provided plug does not fit into your outlet, consult an electrician for replacement of the obsolete outlet.
10. Protect the power cord from being walked on or pinched particularly at plugs, convenience receptacles, and the point where they exit from the apparatus.
11. Only use attachments/accessories specified by the manufacturer.
12.  Use only with a cart, stand, tripod, bracket, or table specified by the manufacturer, or sold with the apparatus. When a cart is used, use caution when moving the cart/apparatus combination to avoid injury from tip-over.
13. Unplug this apparatus during lightning storms or when unused for long periods of time.
14. Refer all servicing to qualified service personnel. Servicing is required when the apparatus has been damaged in any way, such as power-supply cord or plug is damaged, liquid has been spilled or objects have fallen into apparatus, the apparatus has been exposed to rain or moisture, does not operate normally, or has been dropped.
15. This product may contain lead or mercury. Disposal of these materials may be regulated due to environmental considerations. For disposal or recycling information, please contact your local authorities or the Electronic Industries Alliance: www.eiae.org.
16. **Damage Requiring Service** - The appliance should be serviced by qualified service personnel when:
 - A. The power supply cord or the plug has been damaged; or
 - B. Objects have fallen, or liquid has been spilled into the appliance; or
 - C. The appliance has been exposed to rain; or
 - D. The appliance does not appear to operate normally or exhibits a marked change in performance; or
 - E. The appliance has been dropped, or the enclosure damaged.
17. **Tilt/Stability** - All televisions must comply with recommended international global safety standards for tilt and stability properties of its cabinets design.
 - Do not compromise these design standards by applying excessive pull force to the front, or top, of the cabinet which could ultimately overturn the product.
 - Also, do not endanger yourself, or children, by placing electronic equipment/toys on the top of the cabinet. Such items could unsuspectingly fall from the top of the set and cause product damage and/or personal injury.
18. **Wall or Ceiling Mounting** - The appliance should be mounted to a wall or ceiling only as recommended by the manufacturer.
19. **Power Lines** - An outdoor antenna should be located away from power lines.
20. **Outdoor Antenna Grounding** - If an outside antenna is connected to the receiver, be sure the antenna system is grounded so as to provide some protection against voltage surges and built up static charges. Section 810 of the National Electric Code, ANSI/NFPA No. 70-1984, provides information with respect to proper grounding of the mats and supporting structure grounding of the lead-in wire to an antenna-discharge unit, size of grounding connectors, location of antenna-discharge unit, connection to grounding electrodes and requirements for the grounding electrode. See Figure below.
21. **Objects and Liquid Entry** - Care should be taken so that objects do not fall and liquids are not spilled into the enclosure through openings.
 - a) **Warning:** To reduce the risk of fire or electric shock, this apparatus should not be exposed to rain or moisture and objects filled with liquids, such as vases should not be placed on this apparatus.
22. **Battery Usage CAUTION** - To prevent battery leakage that may result in bodily injury, property damage, or damage to the unit:
 - Install all batteries correctly, with + and - alignment as marked on the unit.
 - Do not mix batteries (old and new or carbon and alkaline, etc.)
 - Remove batteries when the unit is not used for a long time.

EXAMPLE OF ANTENNA GROUNDING AS PER NATIONAL ELECTRICAL CODE (NEC)

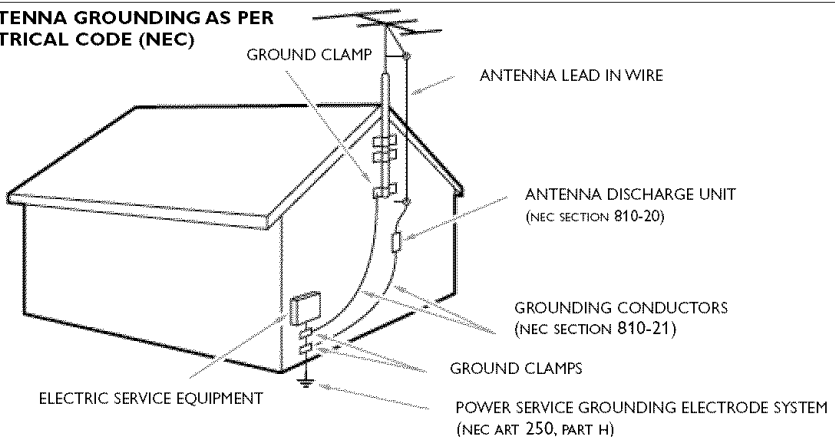

Note to the CATV system installer: this reminder is provided to call the CATV system installer's attention to Article 820-40 of the NEC that provides guidelines for proper grounding and, in particular, specifies that the cable ground shall be connected to the grounding system of the building, as close to the point of cable entry as practical.

Contents

Help?

If this instruction manual does not give an answer or if 'Before Calling Service' do not solve your TV problem, you can call your Local Philips Customer or Service Centre. See the supplied World-wide guarantee booklet. Please, have the Model and Product number which you can find at the back of your television set or on the packaging, ready, before calling the Philips helpline. (800-531-0039)

Model: 42/50PF9956/37
 Product No:

Care of the screen

See Tips, p. 26.



End of life directives

Philips is paying a lot of attention to producing environmentally-friendly in green focal areas. Your new TV contains materials which can be recycled and reused. At the end of its life specialized companies can dismantle the discarded TV to concentrate the reusable materials and to minimize the amount of materials to be disposed of. Please ensure you dispose of your old TV according to local regulations.

Preparation	2
Buttons on the right side of the TV	2
Use of the remote control RC4306	3
To use the menus	5
Installation	5
Select the menu language	5
Store TV channels	6
Settings menu	6
General	6
Clock	8
Source	9
Demo	9
TV menu	10
Picture menu	10
Active Control	11
Sound	12
Features menu	12
Channels menu	13
Connect Accessory Devices	16
Recorder (vcr-dvd+rw)	16
Recorder and other A/V devices	16
Recorder and Cable Box with RDF output	17
Satellite Receiver / Cable Box with AV outputs	17
Recorder and Satellite Receiver / Cable Box with AV outputs	17
DVD Player or other accessory digital source devices	18
HDMI (High Definition Multimedia Interface) connector	19
Multi channel Surround receiver	19
Connect extra subwoofer	20
Side connections	20
To select connected devices	20
Audio- and video equipment buttons	21
Record with your recorder	21
Setting the remote control to work accessory devices ..	22
Before Calling Service	25
Tips	26

Preparation

Do not insert the power plug in a wall socket before all connections are made.

1 Wall mounting instructions/Table stand

For the wall mounting instructions follow the illustrated steps printed on the separate template. Make sure that the wall mount is being fixed securely enough so that it meets safety standards.

The weight of the TV (excl. packaging) is about 77 Lbs (42PF9956); 127 Lbs (50PF9956).

How to mount the supplied stand, see the separate leaflet.

Note: other (not supplied) stands are optional accessories. Consult your dealer.

- 2 Place or hang the TV wherever you want, but make sure that air can circulate freely through the ventilation slots. Do not install the TV in a confined space such as a book case or a similar unit.

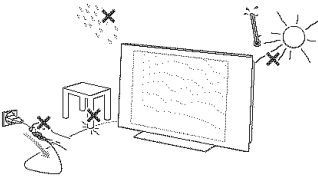

To prevent any unsafe situations, no naked flame sources, such as lighted candles, should be placed on or in the vicinity. Avoid heat, direct sunlight and exposure to rain or water. The equipment shall not be exposed to dripping or splashing and no objects filled with liquids, such as vases, shall be placed on it.

- 3 Insert the aerial plug firmly into the aerial socket  at the bottom of the TV.
- 4 To connect other accessory devices, see p. 16. In order to obtain the best result, please use only the supplied aerial cables between the TV and recorder, and between recorder and aerial connector.
- 5 Insert the power plug supplied into the mains at the bottom of the TV and in the wall socket. Refer to the back of the TV set for the correct operation voltage. Consult your local dealer if your AC power supply is different. To prevent damaging the power (AC) cord which could cause a fire or electric shock, do not place the TV on the cord.
- 6 **Remote control:** Insert the 2 batteries supplied (Type R6-1.5V).

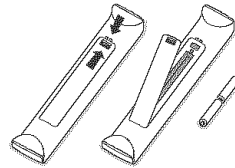

The batteries supplied do not contain the heavy metals mercury and cadmium. Please check on how to dispose of exhausted batteries according to local regulations.

- 7 **Turn the TV on :** Press the power button  at the right side of the TV. A blue LED and the screen light on.

The blue LED blinks every time you press a button on the remote control. When you turn on your set for the first time, the menu language automatically appears on the screen. Alternately the explanation appears in different languages.

Buttons on the right side of the TV

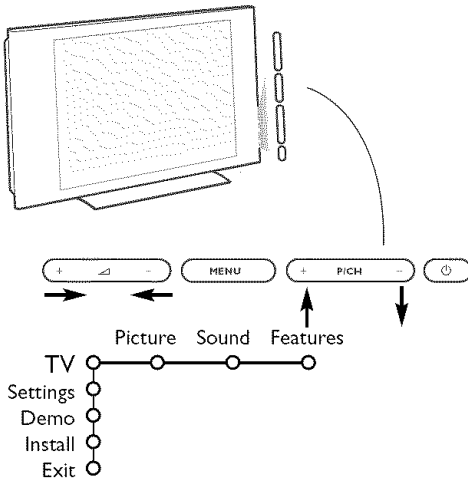

Should your remote be lost or broken you can still change some of the basic settings with the buttons on the right side of your TV.

Press:

- the +  - button to adjust the volume;
- the + **PICH** - button to select the TV channels or sources.

Press the **MENU** button to summon the main menu without the remote control.

Use:

- the +  - button and the + **PICH** - button to select menu items in the directions as shown;
- the **MENU** button to confirm your selection.

Note: When activated via the **MENU** button on the right side of the TV, only **Exit** lets you remove the menu. Navigate to **Exit** and press the **MENU** button.

Use of the remote control RC4306

Note: For most buttons pressing a button once will activate the function. Pressing a second time will de-activate it. When a button enables multiple options, a small list will be shown. Press repeatedly to select the next item in the list. The list will be removed automatically after 6 seconds or press **OK** to remove immediately.

DVD/R CBL TV VCR AUX

Press the **Select** button repeatedly to select one of the system modes in which the remote control can be used. If no action is being undertaken within 2 seconds, the remote control returns to TV mode. After an action in the selected system mode the remote control will remain in this mode for 60 seconds and will then return to TV mode.

INFO Display information

Press to display (when available) information about the selected TV channel and program.

Menu/Remote control info

When a menu is on screen, press the **INFO** button to display info on the selected menu item. While the menu info is displayed, press any button (except the **MENU** or digit buttons) to display remote control info. The normal function of the button is not executed.



Audio and Video equipment buttons. See p. 21.

TV For direct selection of antenna input e.g. to easily swap between the HD input and your TV channels.

CC Closed Caption

On/Off/On during mute

OK Press this button to activate your choice or to confirm when in the menus.

PIP no function

VOL Volume

Press + or - to adjust the volume.

MUTE Interrupt the sound or restore it.

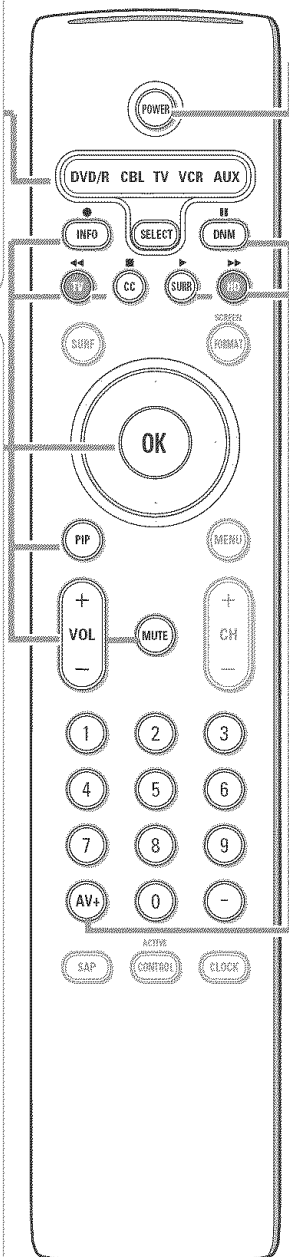

POWER

Press to turn on/off the TV from or to standby mode.
The TV is never powered off completely unless it is physically unplugged.

DNM

Digital Natural Motion on/off

In the right part of the screen Digital natural motion is turned on. Keep the button pressed a bit longer to set the different modes for flicker reduction, motion compensation and resolution enhancement.

SURR Sound mode

Incredible surround

With stereo transmission, and when Incredible surround is selected, it seems as though the loudspeakers are spread further apart from one another.

Virtual Dolby Surround

Optimal with Dolby Surround signals. Enables you to experience the effect of Dolby Surround Pro Logic, reproducing a rear sound effect. See Sound menu, 3D Surround effect, p. 12.

Note: You can make the same selection in the Sound menu, Sound mode, p. 12.

HD Press this button to use the remote control directly in the HD mode for HD devices (eg. Set Top box).

0/9 Digit buttons

To select a TV channel. For a two digit program number, enter the second digit before the dash disappears. To switch immediately to a selected one digit TV channel, keep the digit button pressed a bit longer.

AV+ Keep this button pressed and then press repeatedly to select **AV1**, **AV2**, **AV3 (HDMI)**, **SIDE** or **TV channels** when in TV mode, according to where you connected the accessory devices (p. 20).

- To type the dot (.) for digital channels.

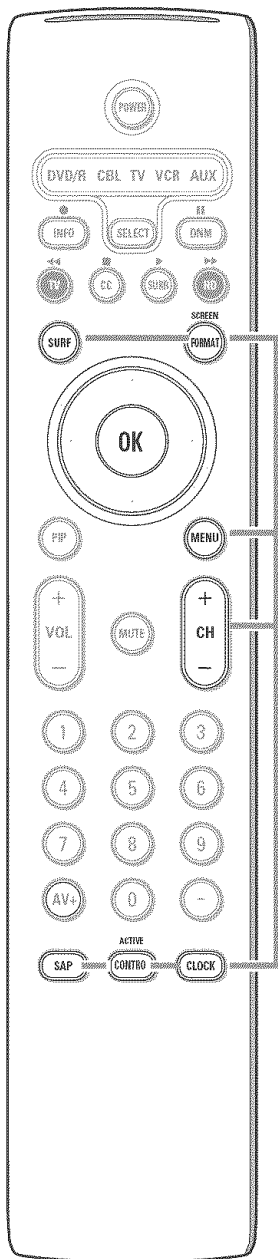

SURF

With this feature you can easily switch between different TV channels/sources that currently interest you. In the menu system, you can set surf to two- or nine-channel. (See Settings, General, Surf, p. 6.)

Press this button to select the previously viewed TV channel or source in case of a Two channel surf, or to select the surf ring in case of a Nine channel surf.

In case of a Nine channel surf, a list appears at the right side of the screen. On top, the most recently channel is displayed. The puck is on the channel number or source currently viewed.

Press the **SURF** button to turn to the next channel or source in the list or press cursor up/down to immediately select the desired TV channel or source of the list.

To add a new channel or source to the 9 channels list: tune to the channel or source you wish to add.

Press the **SURF** button. Press the cursor right to add.

If there are already nine channels/sources in the list, the one at the bottom of the list will be removed.

To remove a channel or source: select the channel number you want to remove.

Press the **SURF** button. Press the cursor right to remove.

Press the **OK** button or wait for the time out to dismiss the Surf display.

SCREEN FORMAT

Press this button to summon a list of available display formats for showing video images in the traditional 4:3 proportions.

Press this button repeatedly or press the cursor up/down to select another picture format: Automatic, Super zoom, 4:3, Movie expand 14:9, Movie expand 16:9, 16:9 subtitle or Wide screen.

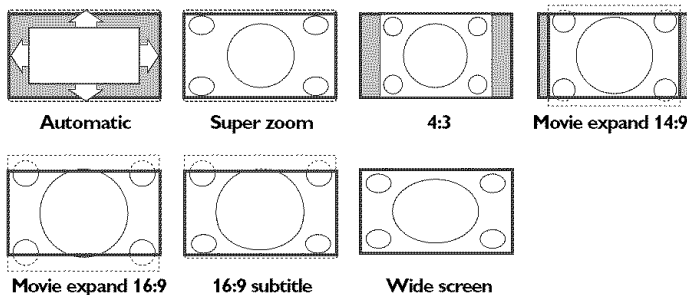

Automatic makes the picture fill the screen as much as possible.

Super zoom removes the black bars on the sides of 4:3 programs with minimal distortion.

When in Movie expand 14:9, Movie expand 16:9 or Super zoom picture format, you can make subtitles visible with the cursor up/down.

*Note: in HDMI mode press the **SCREEN FORMAT** button to switch between a 4:3, 16:9 or a Wide screen picture format.*

MENU Main menu on/off. See p. 5.

CH Channel selection

To browse through the TV channels or sources stored.

SAP When you tune a channels where SAP (Second Audio Program) is available, you can toggle between Main and sap. If not available only Main can be selected.

ACTIVE CONTROL See p. 11.

CLOCK Time display

To use the menus

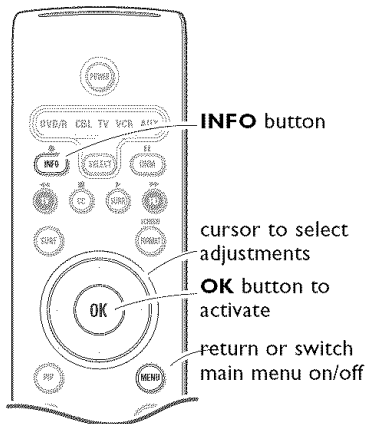

Press the **INFO** button to get information about the selected menu item.

- 1 Press the **MENU** button on the remote control to summon the main menu. At any moment you can exit the menu by pressing the **MENU** button again.

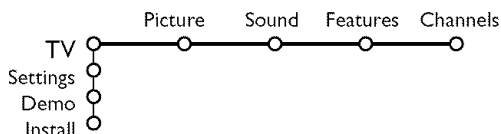

- 2 Use the cursor in the up/down direction to select the **TV**, **Settings**, **Demo** or **Install** menu. Use the cursor left/right to select **Picture**, **Sound**, **Features** or **Channels**.
Note: Sometimes not all the menu items are visible on the screen (indicated by a cluster of blue balls). Use the cursor down or right to reveal all items.
- 3 Use the cursor in the left/right direction to select the menu item.
- 4 Use the cursor up/down again to select the control you want to select or to adjust.

Note: Items temporary not available or not relevant are displayed in a light grey colour and cannot be selected.

Installation

The installation menu contains the following items:

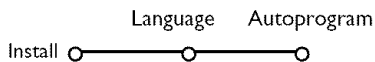

Select the menu language



- 1 Press the **MENU** button on the remote control.
- 2 Use the cursor down to select **Install**.
- 3 Use the cursor right to select **Language**. Follow the instructions on screen.
- 4 Use the cursor up/down to select your preferred language and press the **OK** button to confirm your selection.
- 5 Proceed with the **Install** menu.

Store TV channels

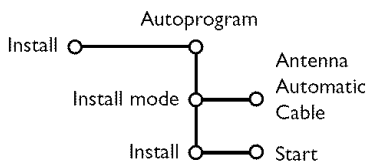

- ❶ Select **Autoprogram** in the Install menu.
- ❷ Press the cursor down to select **Install mode**.
- ❸ Press the cursor right.

*Note: It is recommended to keep the predefined **Automatic** way of autoprogramming. In case of difficulties in autoprogramming with the automatic method, choose for **Antenna** or **Cable** whether antenna or cable signals are present.*

When **Automatic** is selected, the TV will automatically detect whether or not cable signal input is present.

When **Antenna** is selected, the TV will detect antenna signals and will search for all antenna TV channels available in your local area.

When **Cable** is selected, the TV will detect cable signals and will search for all cable TV channels available in your local area.

- ❹ Press the cursor down to select **Install**.
Note: All channels must be unlocked in order to autoprogram. If requested, enter your PIN code to unlock all channels. (See Channels in the TV menu, p. 12.)
- ❺ Press the cursor right.
- ❻ The message **Searching** appears and the progress of autoprogramming is displayed. When Autoprogramming is complete, the puck navigates to **Stop**. A message appears confirming the completion together with the total number of channels found.
Note: when you navigate to Stop before autoprogramming is complete, you are given the option to continue.

Available channels:

- with cable: max. from 1 to 125
- off air: max. from 2 to 69

Note: In case a particular channel is too weak for the autoprogramming to identify, after installation is complete, you should tune to that channel by using the digit buttons on the remote control. If the channel is not acquired, a message will appear that the channel is not available.

Settings menu

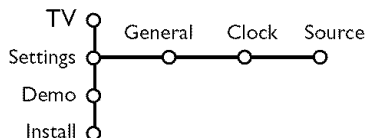

The **General** menu allows you to change settings that will typically be accessed only occasionally.

The **Clock** menu allows you to use your TV as a clock.

For the correct working of On timer and lock after features, helps you select the correct option.

The **Source** menu allows you to select a source.

General

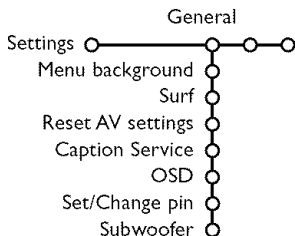

Menu background

- ❶ Select **Menu Background** with the cursor down and press the cursor right.
- ❷ Select **On** or **Off** to turn the menu background on or off.

Surf

- ❶ Select **Surf**.
- ❷ With the cursor left/right, select
 - **2 channels** if you want the **SURF** button to toggle between the current and the previously selected channel,
 - **9 channels** if you want the **SURF** button to summon a list of up to 9 channels which can be selected.

To add/remove a channel or source to the 9 channels list:

Tune to the channel or source you wish to add or remove. Press the **SURF** button and press the cursor right to add or remove.

Note: If there are already 9 channels/sources in the list, the one at the bottom of the list will be removed.

Reset AV settings

This function allows you to reset most of the picture and sound settings to their predefined factory states.

- 1 Select **Reset AV settings** with the cursor down.
- 2 Press **OK** to erase settings and reset them to their default values.

Caption Service

Closed Captioning allows you to read the voice content of television programs on the TV screen. Designed to help the hearing impaired, this feature uses on-screen 'text boxes' to show dialogue and conversations while the TV program is in progress. Captions will appear on the screen during captioned broadcasts.

Note: The captions do not always use correct spelling and grammar. Not all TV programs and product commercials are made for broadcast with Closed Caption information included. Refer to your area's TV program listings for the TV channels and times of Closed Caption shows. The captioned programs are usually noted in the TV listings with service marks such as 'CC'.

- 1 Select **Caption service** with the cursor down.
- 2 Press the cursor right.
- 3 Select the desired **Caption Service**:

• **CC 1, 2, 3 or 4**

Dialogue (and descriptions) for the action on the captioned TV program shows on screen. Usually CC 1 is the most used. CC 2 may be used for alternate languages if they are being transmitted.

• **T 1, 2, 3 or 4**

Often used for channel guide, schedules, bulletin board information for Closed Caption programs, news, weather informations or stock market reports.

Not all Caption Services are necessarily being used by a TV channel during the transmission of a Closed Caption program.

- 4 See Closed Captions in the TV, Features menu, see p. 12, to turn the **Caption service On** or **Off**.

Note: This television provides display of television closed captioning conforming with the EIA-608 standard and in accordance with Sections 15.119 of the FCC rules.

OSD (On Screen Display)

- 1 Select **OSD** with the cursor down.
- 2 Press the cursor right to select **Normal** or **Minimum**.
Normal to activate the continuous display of the channel number and extended display of TV channel and channel information on screen.
Minimum to activate the display of reduced channel information.
See Use of the Remote Control, p. 3, Display information.

Note: When Closed Captions is switched on, see Features, p. 12, continuous display of the channel number is not possible

Set/Change PIN

- 1 Select **Set** or **Change PIN** with the cursor down.
- 2 If no PIN-code exists yet, the menu item is set to **Set PIN**. Follow the instructions on screen. If a PIN-code has previously been entered, the menu item is set to **Change PIN**. Follow the instructions on screen.
All number combinations from 0000 to 9999 are valid numbers.
- 3 The General menu reappears with a message confirming that the PIN has been created.

Important: You have forgotten your PIN !

- 1 Select **Change PIN** in the General menu and press **OK**.
- 2 Press the cursor right to enter the overriding PIN-code 0-7-1-1.
- 3 Press the cursor again and enter a new personal 4-digit PIN code. The previous code is erased and the new PIN-code is stored.

Subwoofer

Select **Yes** if you installed an external subwoofer. See Connect Peripheral Equipment, Connect extra subwoofer, p. 20.

Clock

Most of the TV channels are not transmitting clock information. There are few cable channels but they are at the end of the channel ring. There is no clock transmission in antenna channels. In such cases either clock extraction is taking a long time or there is no clock

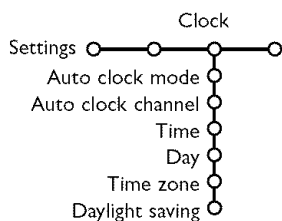

Auto clock mode

- 1 Select **Clock** with the cursor right.
- 2 Press the cursor down to select the **Auto clock mode**.
- 3 Press the cursor right to instruct the TV to get the time automatically or manually.

Auto clock channel

With the cursor buttons, select the channel number where time can be found by the TV. Typically time can be found on PBS as well as some other channels.

*Note: If **Manual** has been selected in the Auto clock mode, the Auto clock channel menu item can not be selected;*

Time - Day

With the cursor buttons, select and enter the correct time and day.

Though the Auto clock mode is automatic, you can enter the time and day which, together with the selected channel, will be overwritten once the clock information has been found.

If **Auto clock mode Manual** has been selected, and no clock search has been done, the system will keep the entered time and day.

Time zone *(only available when Auto clock mode is set to Automatic)*

This function allows you to select your local time zone.

Broadcasted time information will correct the clock display for your local time.

- 1 Select **Time zone** with the cursor down.
- 2 Press the cursor right to select your local time zone.

Daylight saving *(only available when Auto clock mode is set to Automatic)*

Daylight saving time is automatically set by specially broadcasted signals. This menu item allows you to disable the automatic setting of daylight saving time. This is useful if you live in an area or state where daylight saving is not applied, but you receive channels from other areas where daylight saving signals are broadcasted.

- 1 Select **Daylight saving** with the cursor down.
- 2 Press the cursor right to select **Automatic** for automatic clock correction for daylight saving time, based on specially broadcasted signals.
- 3 Select **Off** to disable automatic clock correction based on the specially broadcasted signals.

Source

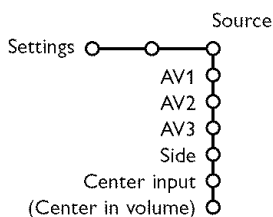

- ❶ Select **Source** with the cursor right.
- ❷ Press the cursor down to select one of the external AV inputs.
- ❸ Press the cursor right to enter the list of types of devices attached to the selected input.
- ❹ Select the accessory device with the cursor up/down. Once you have named the source, e.g.VCR, this source will automatically be selected when your remote control is in VCR mode, see p. 5, and when you press the **AV+** button on the remote control.
- ❺ Press the **MENU** button on the remote control to turn off all menus on screen.
- ❻ Press the **AV+** button on the remote control. The Source Select menu appears in which you may select a source or peripheral connected to be displayed on screen.

Center input - Center in volume

When you have connected a multichannel surround receiver to the TV, the loudspeakers of the monitor can act as center speaker, making a separate center speaker unnecessary; Select **Center input On**.

When having selected **On** you can adjust the **Center in volume** with the cursor left/right to correct volume level differences of the external audio receiver and speakers.

Demo

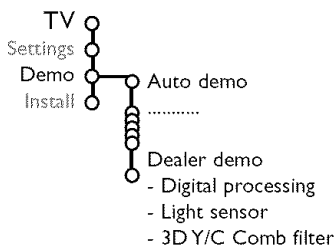

- ❶ Select **Demo** in the Main menu with the cursor down.
- ❷ Select **Auto demo** or one of the features with the cursor right and press the **OK** button on the remote control.

If **Auto demo** has been selected the demo will automatically present all the features sequentially in a loop. Press one of the cursor buttons to stop the Auto demo.

If one of the features has been selected, this particular feature demo will run one time only, until activated again, and the Demo menu will reappear.

Digital processing, Light sensor and 3DY/C Comb filter On or Off

Select **Digital processing, Light sensor and 3DY/C Comb filter On or Off** to really see the difference in picture quality.

In Dealer Demo mode it is possible to change channels with **- CH +** and to adjust the volume.

Note: the Dealer Demo is not part of the automatic sequence and can only be activated separately.

TV menu

Press the **MENU** button on the remote control to summon the main menu.

Note: Dependent on the input signal, one or more menu items may not be selectable.

Picture menu

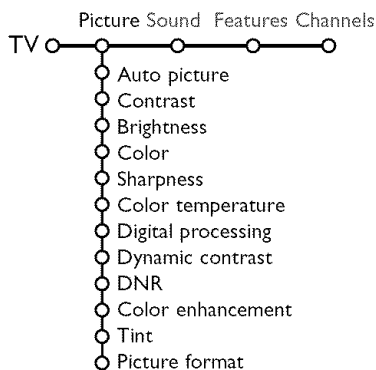

Note: Sharpness, Digital natural motion, Dynamic Contrast, DNR, Color enhancement, Tint and Picture format are not available for HD sources.

Press the INFO button on the remote control to get information about the selected menu item.

- 1 Press the cursor right to select **Picture**.
- 2 Select the menu items in the Picture menu with the cursor up/down.
- 3 Adjust the settings with the cursor left/right or enter the list of submenu items with the cursor right. Select a submenu item with the cursor up/down.

Note: To remove the menu background before adjusting the picture settings, see Select TV Settings, General, p. 6.

Auto picture

Select **Auto picture** to display a list of predefined picture settings, each corresponding with specific factory settings. **Personal** refers to the personal preference settings of picture in the picture menu.

*Note: this Philips Flat TV has been set at the factory to look best in bright store environments which typically use florescent lighting. As your home will likely not be as well lit as a store, we recommend that you cycle through the various Auto Picture modes to find the one that best suits your own viewing conditions. Most consumers will find that **Natural** is the correct choice.*

Digital processing

- **Standard:** line doubling eliminates line flicker.
- **Dig. natural motion:** For everyday viewing, **Dig. natural motion** is the most ideal setting, as it fully processes the image to make every single pixel the best it can be, improving contrast, sharpness, picture depth, and color reproduction and brilliance from every source, including High Definition. For the most optimum motion reproduction of all source materials, select the **Movie Plus** setting. **Standard** Mode is recommended only for very noisy or poorly mastered sources or for those who find the smoothness of Digital natural motion (which eliminates jitter in the picture) unsettling.

Dynamic contrast

Automatically makes the contrast in the darker and the brighter picture areas more noticeable as the image on the screen changes.

Normally, select **Medium**. It may be preferred to select **Minimum**, **Maximum** or **Off**.

- 1 Press the cursor right to enter the list.
- 2 Select one of the settings with the cursor up/down.
- 3 Press the cursor left to return to the picture menu.

DNR (Digital Noise Reduction)

Automatically filters out and reduces the image noise and improves picture quality when receiving weak video signals.

- 1 Press the cursor right to enter the list.
- 2 Select **Off**, **Minimum**, **Medium** or **Maximum** according to the image noise.
- 3 Press the cursor left to return to the picture menu.

Color enhancement

When activated, this feature automatically controls green enhancement and blue stretch. It makes the colors more vivid.

- 1 Press the cursor right.
- 2 Select **On** or **Off** in order to activate/de-activate Color enhancement with the cursor right.

Tint

Allows you to select the color mix (hue) of the picture.

Picture format

This menu item performs the same as the **SCREEN FORMAT** button on the Remote Control. See Use of the Remote Control, p. 4.

Active Control

The TV continuously measures and corrects all incoming signals in order to provide the best picture possible.

- 1 Press the **ACTIVE CONTROL** button on the remote control.

Note: Turn off all menus on screen.

- 2 The Active Control menu appears.
- 3 Press the cursor up/down to select the Active Control values **Off**, **Minimum**, **Medium** (recommended) or **Maximum**. The picture settings are being optimized continuously and automatically which is displayed by bars. Those menu items can not be selected.
- 4 Press the cursor right to select **Auto Picture**.
- 5 Press the cursor up/down to select one of the predefined picture settings.
- 6 Press the cursor right to select **Active Display**.

- 7 Press the cursor up/down to select **Show bars**, one of the Dual screen demos or **Off**. When you select Dynamic contrast, Digital Noise Reduction or Digital processing, the TV screen is divided into two parts: in the left part the selected picture quality setting is switched off; in the right part it is switched on.

Note: Dependent on the input signal, one or more Dual screen demos may not be selectable.

- 8 Press the **ACTIVE CONTROL** button again to switch off the Active Control menu.

Note: Active Control is not available for digital signals via HDMI.

Sound

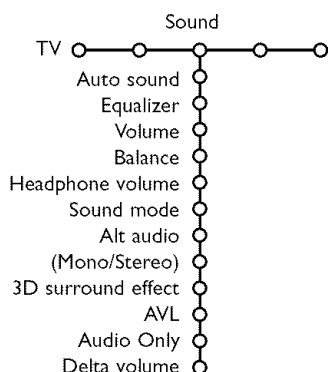

Press the **INFO** button on the remote control to get information about the selected menu item.

- 1 Press the cursor right to select **Sound**.
- 2 Select the menu items in the Sound menu with the cursor up/down and adjust the settings with the cursor left/right. Remember, control settings are at normal mid-range levels when the bar scale is centered.

Auto sound

Select **Auto sound** to display a list of predefined sound settings, each corresponding with specific factory settings of Treble and Bass.

Press the cursor right to enter the list.

Press the cursor up/down to select a predefined sound setting.

Personal refers to the personal preference settings of sound in the Sound menu.

Note: the moment you are in a predefined Auto sound setting and you modify a setting in the Sound menu, all values of the menu will overwrite the previously made personal setting.

Features menu

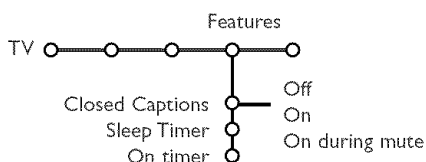

Press the **INFO** button on the remote control to get information about the selected menu item.

- 1 Press the cursor right to select **Features**.
- 2 Select the menu items with the cursor up/down and adjust the settings with the cursor left/right.

Closed Captions

See also Caption Service, Settings menu, General, p. 7.

- 1 Select **Closed Captions** with the cursor down.
- 2 Press the cursor right.
- 3 Select **On**, **Off** or **On during mute**
When **On** is selected, the TV will display the currently display Caption Service, assuming that the service is available in the broadcast.
When **Off** is selected, the TV will not display Closed Captions information;
When **On during Mute** is selected, the TV will display the currently selected Caption Service when the mute function is active.
When the mute function is not active, the TV will not display Closed Captions informations.

Sleep Timer

With the Sleep timer function you can set a time period after which the TV will turn itself off.

- 1 Select **Sleep Timer** with the cursor down.
- 2 Press the cursor right to set the time
The cursor runs from 0 up to 180 mins (in 5-min increments).
When set to 0, the sleep timer is turned off. One minute before the sleep timer expires, a message appears that the TV will turn off in 60 seconds or you may cancel the sleep timer by pressing the **OK** button. You can always turn off your TV earlier or change the set time.

On timer

Note: The On timer function is only available if time information is available via the local PBS channel.

- 1 Select **On timer** with the cursor down.
- 2 Press the cursor right and select **On** or **Off** to set the On timer On or Off.
- 3 When you have selected **On** press the cursor right.
- 4 Select the TV channel or external source you want the On timer to activate with the cursor up/down.
- 5 Press the cursor right to select the day you would like the On timer to become active. Select **Daily** to set the On timer for daily operation on the selected TV channel or source.
- 6 Press the cursor right to select **AM** or **PM**.
- 7 Press the cursor right to enter the time with the digit buttons or with the cursor up/down, left/right.
- 8 Press the **OK** button to confirm.
- 9 Press the **MENU** button to turn off all menus on screen.

Channels menu

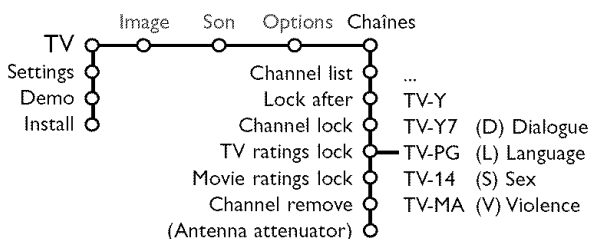

Press the INFO button on the remote control to get information about the selected menu item.

- 1 Press the cursor right to select **Channels**.
- 2 Select the menu items with the cursor up/down and adjust the settings with the cursor left/right.

Note: Lock after is only selectable if time and date are known. See Settings, Clock, p. 8.

TV Ratings Lock

Your TV is equipped with a V-chip. This allows you to control access to individual programs based on their movie and TV ratings. All settings apply to all AV inputs, except HDMI. The program content advisory data are sent by the broadcaster or program provider.

- ❶ Select **TV ratings lock** with the cursor down. A list appears, showing the age-based TV ratings and a corresponding content-based ratings list.
- ❷ Press the cursor right to enter the list.
- ❸ Select an age-based TV rating with the cursor up/down, and enter, if present, the list with content-based ratings with the cursor right, and select one content-based rating.
- ❹ Press **OK** to activate/de-activate the selected rating. You are asked to enter your PIN. (See Set/Change PIN, p. 7). If the code is correct, the TV ratings lock menu reappears.
- ❺ Select another content-based rating if you like and press **OK** again.
You need only enter your PIN-code once while the menu is active. You can lock/unlock any number of ratings on the list without re-entering your code.

Age-based Rating	Content-based Rating
All	none
None	none
TV-Y	none
TV-Y7	(FV) Fantasy Violence
TV-G	none
TV-PG	(D) Dialog (L) Language (S) Sex (V) Violence
TV-14	(D) Dialog (L) Language (S) Sex (V) Violence
TV-MA	(L) Language (S) Sex (V) Violence

Each ratings item has a box-graphic in front of it to indicate whether or not programs carrying that rating are currently locked:

- a yellow-colored box: all items in the contents-based list are locked as well;
- a blue-colored box: the item is unselected;
- a half blue, half yellow-colored box: some content-based ratings are selected/unselected.

When **All** has been selected, all items in the age-based and in the contents-based lists are locked. If, while **All** is selected, any other item, either an age-based or content-based item, is unselected, then **All** is automatically unselected.

None is the selection for items that either have no rating information or have a rating of None. Both will be locked.

When an item on the age-based list is selected, all items below that item of the same group are locked as well.

When you select a content-based rating, all identical content-based ratings in the younger age-based categories are also selected.

- TV-Y** appropriate for children of all ages with themes and elements suitable for children aged 2-6
- TV-Y7** programs designed for children age 7 and older
- TV-Y7-FV** programs include fantasy violence more intense than other programs in the TV-Y7 category
- TV-G** programs suitable for all ages. These programs contain little or no violence, no strong language and little or no sexual dialogue or situations
- TV-PG** programs contain elements that some parents may find unsuitable for younger children and which may need parental guidance.
The program may contain moderate violence, sexual dialogue and/or situations and some strong language.
- TV-14** programs contain elements that may not be suitable for children under 14 years of age. These programs include one or more of the following: intense violence, intense sexual situations, suggestive dialogue and strong language.
- TV-MA** programs are designed to be viewed by adults and may be unsuitable for children under the age of 17. These programs may contain graphic violence, explicit sexual activity and/or crude or indecent language.

Movie Ratings Lock

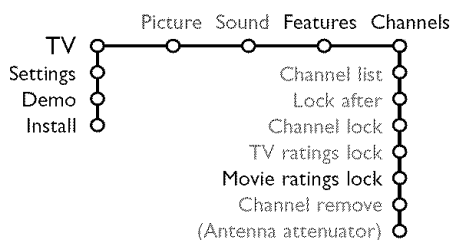

This function allows you to control access to individual movies based on their MPAA ratings (Motion Picture Association of America).

- 1 Select **Movie ratings** lock with the cursor down. A list appears, showing all valid MPAA content ratings.
- 2 Press the cursor right to enter the list.
- 3 Select a movie rating with the cursor up/down.
- 4 Press **OK** to activate/de-activate the selected rating. You are asked to enter your code. (See Set/Change PIN, p. 7.) If the code is correct, the Movie ratings lock menu reappears.

Each rating item has a box-graphic in front of it to indicate whether or not programs carrying that rating are currently locked:

- a yellow-colored box: movies with this rating are locked;
- a blue-colored box: movies with this rating are unlocked.

When **All** has been selected, all items on the movie ratings list become selected. (All movies are locked.)

If, while **All** is selected, any other item is unselected, then **All** is automatically unselected. When **NR** has been selected, no other item is selected.

When any other item has been selected, all ratings below are selected as well, thus all movies with those ratings will be locked.

- NR** not rated
- G** movies with a mild content, suitable for all ages
- PG** movies for which parental guidance is recommended. They may contain a few racy or violent scenes or maybe some bad language
- PG-13** movies for which parental guidance may be recommended if under age 13
- R** restricted. The movies usually contain offensive sex or bad language and may be unsuitable for children under the age of 17. Parental guidance or permission needed.
- NC-17** even with parental permission, forbidden under age 17. More offensive sex, violence or bad language.
- X** movies which generally focus on sex, violence and/or bad language. Also known as pornography.

Channel remove

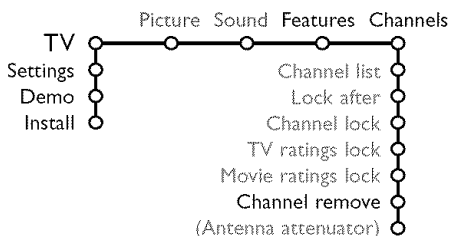

This feature provides the ability to remove a channel number from the channel list.

- 1 Select **Channel remove** with the cursor down.
- 2 Press the cursor right to enter a list with all stored channel numbers.
- 3 Select the channel you want to remove with the cursor down.
- 4 Press **OK**.
- 5 Repeat to remove other channels.

Connect Accessory Devices

There is a wide range of audio and video devices that can be connected to your TV. The following connection diagrams show you how to connect them to the TV.

AV1 can handle YPbPr, Y/C and CVBS; **AV2** YPbPr (RGB), CVBS and Y/C; **AV3 (HDMI)**; **Side**: CVBS and Y/C.

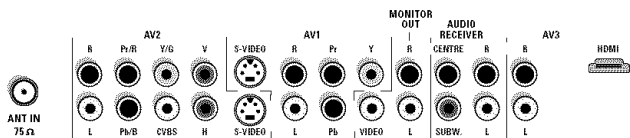

Recorder (VCR-DVD+RW)

Note: Do not place your recorder too close to the screen as some recorders may be susceptible for signals from the display. Keep a minimum distance of 20" from the screen.

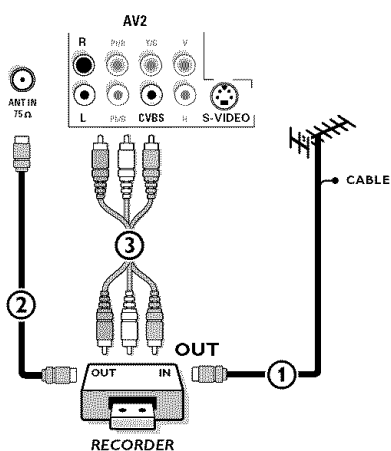

- 1 Connect the RF Antenna or Cable TV cable (eventually via an optional two-way signal splitter and/or Cable TV converter box) ① to the **RF IN** socket of your recorder.
- 2 Connect another RF cable ② from the output **OUT** of your recorder to the TV's input 75 Ω **T** jack.
- 3 Better playback quality can be obtained if you also connect the Video, Audio Left and Right (only for stereo devices) AV cables ③ to the **CVBS**, **AUDIO L** and **R** input jacks of **AV2**.

If your recorder has an S-VHS video jack:

For improved picture quality, connect an S-video cable with the **S-VIDEO** input instead of connecting the recorder to the **CVBS** jack of **AV2**.

S-Video does not provide audio, so audio cables must still be connected to provide sound.

Recorder and other A/V devices

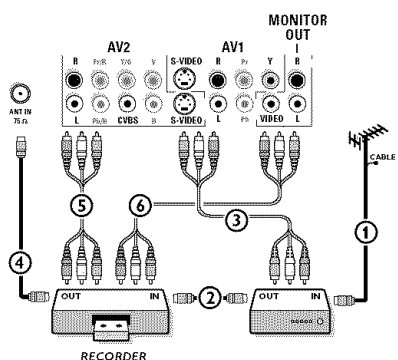

- 1 Connect the RF antenna cable ① of the **RF IN** socket of your other AV device.
- 2 Connect the RF output of the AV device to the RF input of the recorder ②.
- 3 Connect another RF cable ④ from the output **OUT** of your recorder to the TV's input 75 Ohm **T** jack.
- 4 To obtain better picture quality, also connect the Video, Audio left and Audio right cables of both devices to **AV1** (**Y** or **S-VIDEO**, **AUDIO L** and **R**) ③ and to **AV2** (**CVBS** or **S-VIDEO**, **AUDIO L** and **R**) ⑤.

Note: in case of mono equipment, only the left loudspeaker reproduces sound. Use a mono to stereo adapter (not supplied) for sound reproduction via all internal loudspeakers.

The **MONITOR OUT** connector can be used for a daisy chaining or to record programs from your TV ⑥. Only when a recorder is connected to **MONITOR OUT** it is possible to record a program from other devices connected to the TV.

See Record with your recorder, p. 21.

Recorder and Cable Box with RDF output

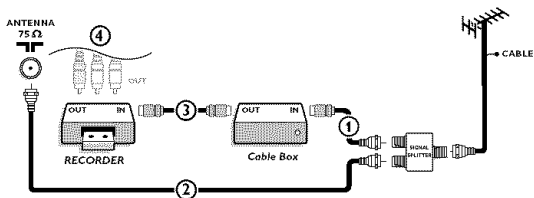

- ❶ Use an optional signal splitter.
- ❷ Connect one of the cable TV signal splitter outputs ❶ to the cable box's **IN** jack.
- ❸ Connect the other cable TV signal splitter output ❷ to the 75 Ω  plug on the bottom of the TV.
- ❹ Connect the cable box's **OUT** jack ❸ to the recorder's **RF IN** socket.
- ❺ Connect the Video, Audio Left and Right (only for stereo sound) AV cables ❹ to the **CVBS**, audio **L** and **R** input **AV2** jacks on the TV.

Satellite Receiver / Cable Box with AV outputs

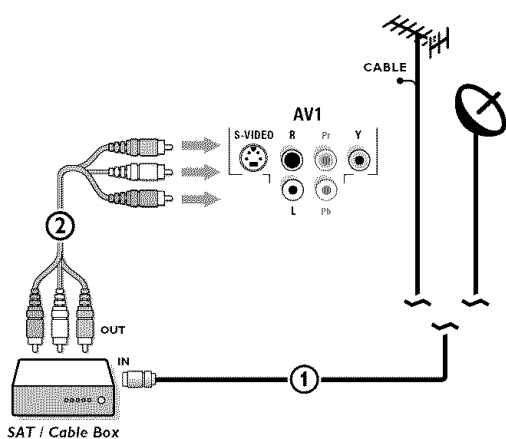

- ❶ Connect the satellite antenna cable or the Cable TV cable ❶ to the satellite receiver's or cable box's **IN** jack.
- ❷ Connect the Video, Audio left and right AV cables ❷ to the **Y**, **L** audio and **RAUDIO** input jacks of **AV1**.

If your satellite receiver or cable box has an S-Video jack:

For improved picture quality, connect an S-Video cable to the **S-VIDEO** input **instead** of connecting the satellite receiver or cable box to the **Y** jack.

Connect the audio cables to the device's **AUDIO L** and **R** jacks and to the **L** and **R** audio **AV1** jacks on the TV.

Recorder and Satellite Receiver / Cable Box with AV outputs

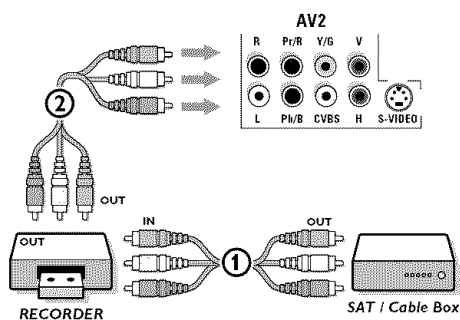

- ❶ Connect the RF Antenna or Cable TV cable as described above.
- ❷ Connect the AV cables ❶ to the satellite receiver's or cable box's **AV OUT** jacks and to the recorder's **AV IN** jacks.
- ❸ Connect the recorder's **AV OUT** jacks ❷ to the TV's **AV2** jacks as described above.

DVD Player or other accessory digital source devices

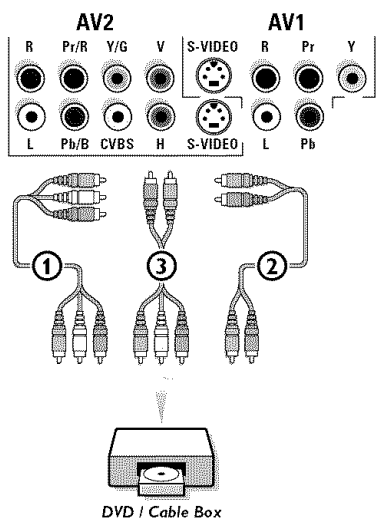

Devices with Component Video Output Connectors (YPbPr)

- 1 Connect the three separate component video cables ① to the device having component video outputs (YPbPr), such as DVD-players, laser-disc players, videogame players, satellite receivers or other equipment, and to the **Y, Pb** and **Pr** jacks of **AV1** or **AV2** on the TV.
- 2 Connect the audio cable to device's **AUDIO L** and **R** ② jacks and to the **L** and **R** audio **YPbPr** jacks of **AV1** or **AV2**.

Devices with RGB output

- 1 Connect the device with RGB output with separate Horizontal and Vertical sync to the **Pr/R Pb/BY/G** input jacks and to the **H** and **V** jacks of **AV2** ③.
- 2 Connect the audio cables to the **L** and **R AUDIO** jacks of **AV2**.

Devices with an S-Video connector

- 1 Connect an S-Video cable to the **AV1** or **AV2 S-VIDEO** input.
Note: When using the S-VIDEO connector do not connect any device to the AV2 CVBS input.
- 2 Connect the audio cables to the device's **AUDIO L** and **R** jacks and to the **L** and **R** audio **AV1** or **AV2** jacks on the TV.

Notes

- The labels for the component video sockets may differ depending on the DVD player or the device connected. Although the abbreviations may vary, the letters B and R stand for the blue and red component signals, respectively, and Y indicates the luminance signal. Refer to the DVD player's or device's instructions for use for definitions and connection details.
- This television is designed to accept high definition signal standards 480p, 720p (not with 42PF9956), 1080i and 1152i as specified by the Electronic Industries Association standard EIA770.3. Digital devices from different manufacturers have the possibility of differing output standards which may cause difficulties for the television to properly display.

Warning: in case you notice scrolling images, wrong colors or no colour, no picture, or even combinations of these on your screen, check if the connections are done in the correct way or move your digital device further away from your TV.

HDMI (High Definition Multimedia Interface) connector

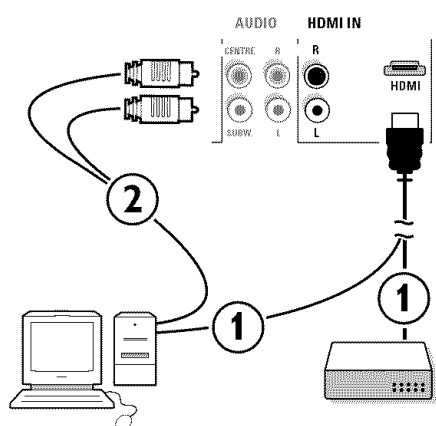

HDMI is the leading new standard for Digital High Definition video and audio interconnection. Eg. with a Digital Set top box, with HDMI-equipped devices like a PC, DVD-R, AV receiver...

Note: the HDMI connector is compatible with DVI-devices and a HDMI to DVI conversion cable is included. (Then also connect the audio cables.)

The **HDMI IN** connector allows

- the following TV and monitor display modes:

EDTV	640/720 x 480p	
HDTV	1920 x 1080i	
	1280 x 720p	(only with 50PF9956)
VGA	640 x 480	60 Hz
SVGA	800 x 600	60 Hz
XGA	1024 x 768	60 Hz (only with 50PF9956)

- uncompressed HD content
- encrypted or non encrypted signals.

- ❶ Connect the digital HDMI output of your HD device (e.g. PC, DVD player, Set Top Box..) to the **HDMI** connector of your TV.
- ❷ In case a HD-DVI device (and if audio is present) is connected also connect the audio cable to the **AUDIO** outputs of your HD device and to the **AUDIO RECEIVER R** (right) and **L** (left) **HDMI (AV3)** inputs of the panel of the TV.

Notes:

- Proper working is only guaranteed with HDMI compliant consumer products.
- Digital devices from different manufacturers have the possibility of differing output standards which may cause difficulties for the television to properly display;
- If the set is cold, there may be a small "flicker" when the set is turned on. This is normal, there is nothing wrong with the set.
- In case no signal is detected from your HDMI device, turn off the HDMI device and then on again.
To get an optimal viewing, it is advised to switch your DVD player to one of the following TV display standards: 720x480p, 720x480i, 1280x720p or 1920x1080i.

Multi channel Surround receiver

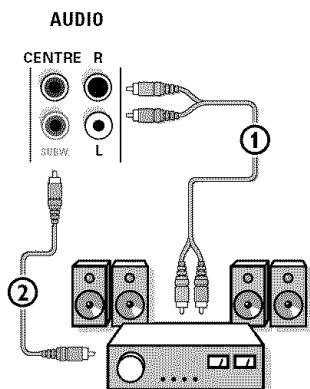

- ❶ Connect the audio cable to the multi channel Surround receiver and to **AUDIO RECEIVER L** and **R** next to the **CENTRE** connector of your TV.

Note: turn off the TV and your surround receiver before connecting them. Set the Surround receiver's volume to minimum.

- ❷ If you want the loudspeakers of your TV to act as center speaker, also connect an audiocable to the multi channel Surround receiver and to the **CENTRE** connector of your TV.
- ❸ Select **Center Input On** in the Source menu. See p. 9.

The loudspeakers of the TV will now only produce center sound, the loudspeakers connected to the audio receiver will produce Surround Sound. The volume has to be controlled via the multi channel Surround receiver.

Note: No sound will be heard when a TV channel or external source is blocked via the Channel Lock menu (see p. 13).

Connect extra subwoofer

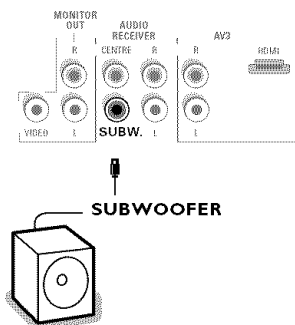

To enhance the sound reproduction of your TV you can connect an externally powered subwoofer (between 20 and 250 Hz).

- ❶ Connect the audio cable of the external subwoofer to the **SUBWOOFER** socket at the bottom of your TV.
- ❷ Select **Subwoofer** in the Settings, General menu, p. 8.
- ❸ Adjust the frequency of the external subwoofer to 100-120 Hz (according to your personal preference) if present on the subwoofer.
- ❹ Adjust the volume level of the external subwoofer, presumed this control is present on the subwoofer. See also the instruction manual of the external subwoofer.

Side connections

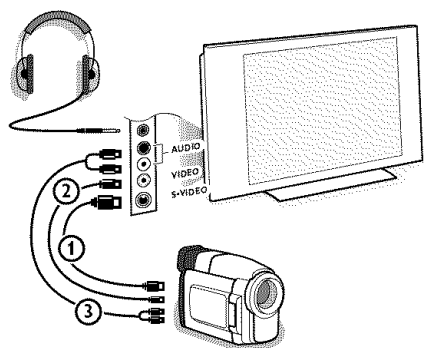



Camera, Camcorder or Game

- ❶ Connect your camera, camcorder or game as shown.
- ❷ Connect to **VIDEO** ❷ and **AUDIO L** ❸ for mono equipment. For stereo equipment also connect **AUDIO R** ❸.

S-VHS quality with an S-VHS camcorder is obtained by connecting the S-VHS cables with the **S-VIDEO** input ❶ and **AUDIO** inputs ❸.

Do not connect cable ❶ and ❷ at the same time. This may cause picture distortion !

Headphone

- ❶ Insert the plug into the headphone socket  as shown.
- ❷ Press  on the remote control to switch off the internal loudspeakers of the TV.

The headphone impedance must be between 8 and 4000 Ohm. The headphone socket has a 3.5 mm jack.

In the Sound menu select **Headphone volume** to adjust the headphone volume.

To select connected devices

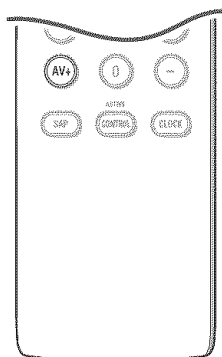

- ❶ Press the **AV+** button repeatedly or select **Source** in the Settings menu (see p. 9) to select **AV1, AV2, AV3 (HDMI), Side** or **TV channels**, according to where you connected your devices.
- ❷ Press the cursor up/down.
- ❸ Press **OK**.

Remark: Most equipment (decoder, recorder) carries out the switching itself. This is however never the case with a computer connected to the HDMI input.

Audio- and video equipment buttons

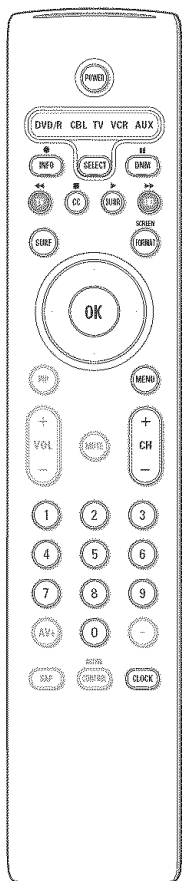

Most of the audio and video equipment from our range of products can be operated with the remote control of your TV.

Press one of the buttons after you pressed the **Select** button repeatedly according to the equipment you want to operate with this remote control. See Use of the remote control, p. 3.

- POWER** to switch to standby (VCR)
- II** for pause,
- for record,
- ◀◀** for rewind (VCR, CD); search down (DVD, AMP)
- for stop,
- ▶** for play,
- ▶▶** for fast forward (VCR, CD); search up (DVD/AMP)
- INFO** display information
- MENU** to switch the menu on or off
- **CH +** for chapter, channel, track selection
- 0 to 9 digit entry,
- tape index (VCR), select a DVD chapter; select a frequency (AMP)
- CLOCK** VCR timer
- SURRE** surround on/off (AMP, CD)
- cursor up/down to select the next or the previous disc (CD)
- cursor left/right to select the previous or following track (CD)

Notes:

- If no action is being undertaken within 60 seconds, the remote control returns to TV mode.
- After an action in the selected system mode, the remote control will remain in this mode for 60 seconds and will then return to TV mode or press the **Select** button to return to TV mode immediately.

Record with your recorder

To record S-VHS quality, connect an S-VHS peripheral directly to the recorder.

Record a TV program

You can record a TV program using your recorder's tuner without affecting your TV.

- 1 Select the channel number on your recorder.
- 2 Set your recorder to record. See the handbook for your recorder.

Switching channel numbers on your TV does not disturb recording !

Record a recorder from MONITOR OUT

You can record a program on your recorder from the TV tuner via **MONITOR OUT**.

- 1 Switch on the device.
- 2 Select the correct channel on your TV and the correct input on your recorder.
- 3 Set your recorder to record. You record the tuner channel of the TV, even when you switch to an AV input using the **AV+** button on the remote control.

*Do not switch channels or turn off your TV when you are recording through **MONITOR OUT**.*

Note: When a TV channel or AV source is blocked because of a rating set via the Channels menu (see p. 13), also the record output picture and sound are muted.

Setting the remote control to work accessory devices

Your remote control is set to work your TV and many infrared remote (IR) control VCRs, Cable TV Converter Boxes, DVD players, Satellite Receivers, etc.

Press the **Select** button repeatedly to select **DVD/R**, **CBL**, **VCR** or **AUX** according to the accessory device you want to operate with this remote control. See Use of the Remote control, p. 3. Press the **POWER** button.

If the function buttons on the remote control also work the selected accessory device, then the remote is ready and no further steps are needed.

If the function buttons do not work with the selected accessory device, according to the device(s) you own, you may make your remote control ready for them by a direct entry code. Proceed as following.

Code setup

- 1 Press the **Select** and **POWER** buttons at the same time, then release.
- 2 **NOTE:** When inputting the digits as described below, you must not allow more than 20 seconds to pass between the input of each digit or you will need to return to step 1 and begin the programming process again. Input the appropriate digit provided below for the type of accessory device you want to operate:
1 DVD/R
2 CBL (HD-STB)
3 CBL-SAT
4 VCR
5 AUX (AMP, CD).
- 3 Input the 4-digit code for the type and brand of accessory device. The codes are listed on pages 23-24.
- 4 The green light behind the **POWER** button will blink for 3 seconds to show that a valid code was input. If a valid code was not entered, the light will stay on continuously for 3 seconds. If that occurs, go back to step 1 and begin the programming process again.
- 5 Now you will try to use the TV remote with the accessory device. Press the **Select** button on the remote to cycle across the accessory mode dial. Stop pressing the button when the mode you desire is lighted. The light will stay on for 2 seconds and then begin blinking. The blinking means that the remote is in the accessory mode you have selected.

- 6 Within 60 seconds from the time the blinking starts, point the remote toward the accessory device and press the **POWER** button. If the device does not respond to the **POWER** command, follow the steps for programming the remote again using a different setup code for the type and brand of accessory device you wish to operate. Refer again to the code list on pages 23-24. If no more codes are listed for the type and brand of accessory device, the remote likely will not operate your particular model of accessory device.

Notes:

- Your TV remote is not necessarily capable of being programmed to operate all models of the brands of accessory devices listed on pages 23-24. You may want to try the programming process again. Try using the number(s) that are listed for your type and brand of device to be sure you did not make a mistake in inputting the digits during your first attempt at programming.
- If the remote control is in one of the accessory modes (a mode light is flashing) — DVD/R, CBL, SAT, VCR or AUX — and you don't press any of the remote buttons for sixty seconds, a "time-out" occurs, returning the remote to TV mode.

Remote Control Direct Entry Codes for Accessory Devices

Amplifier

Carver0296
 Curtis Mathes0327
 GE0105
 JVC0358
 Linn0296
 Magnavox0296
 Marantz0296
 Optimus0422, 0327
 Philips0296
 Pioneer0327
 Polk Audio0296
 RCA0327
 Realistic0422
 Sony0716, 0247
 Soundesign0105
 Victor0358
 Wards0105
 Yamaha0381

Cable Box

ABC0030, 0034, 0035
 Allegro0180, 0342
 Americast0926
 Archer0180, 0824
 BellSouth0926
 Century0180
 Citizen0180, 0342
 Comtronics0067
 Contec0046
 Emerson0824
 Everquest0042, 0067
 Focus0427
 Garrard0180
 Gemini0042
 General Instrument0503, 0837
 GoldStar0067, 0171
 Goodmind0824
 Hamlin0047, 0036, 0286, 0061
 Hytex0034
 Jasco0042, 0180, 0342
 Jerrold0030, 0039, 0503, 0042, 0837
 Memorex0027
 Motorola1133
 Movie Time0090
 NSC0090
 Oak0046, 0034
 Optimus0048
 Panasonic0048, 0134, 0027
 Paragon0027
 Philips0180, 0332, 0344
 Pioneer0171, 0560, 0904
 Popular Mechanics0427
 Pulsar0027
 Quasar0027
 RCA0048
 Radio Shack0042, 0910, 0342, 0824
 Recoton0427
 Regal0047, 0286
 Runco0027
 SL Marx0067
 Samsung0067, 0171
 Scientific Atlanta0035, 0504, 0904
 Signal0042, 0067
 Sprucer0048
 Starcom0030, 0042
 Stargate0067, 0042, 0824
 Starquest0042
 TV860090

Television0067
 Tocom0039
 Toshiba0027
 Tusa0042
 Unika0180
 United Artists0034
 Universal0180, 0218
 Viewstar0090
 Zenith0027, 0552, 0926
 Zentek0427

Surround Sound Receiver

ADC0558
 Aiwa0148
 Capetronic0558
 Carver0069, 1116, 1216
 Casio0222
 Clarinette0222
 Denon1187, 1131
 Fisher0069
 Garrard0490
 Harman/Kardon0137
 JVC0101
 Kenwood1054, 0069, 0213, 1340, 1596, 1597
 Lloyd's0222
 MCS0066
 Magnavox0418, 1116, 0558, 1216
 Marantz1116, 1216, 0066
 Modulair0222
 Nakamichi0124
 Onkyo0162
 Optimus1050, 0213, 0558, 0069
 Panasonic0066, 1545
 Penney0222
 Philips1116, 1216, 1296, 0418
 Pioneer0177, 0558, 1050
 Proscan1281
 Quasar0066
 RCA1281, 0558, 1050
 Realistic0222
 Sansui1116
 Sharp0213
 Sherwood0529
 Sony1185, 1085, 1285
 Sunfire1340
 Teac0490
 Technics0066, 1335, 1545, 1336
 Thorens1216
 Victor0101
 Yamaha0203, 0213, 1203
 Yorx0222

Satellite Receiver

AlphaStar0799
 EchoStar1032, 0802
 ExpressVu0802
 GE0593
 General Instrument0388, 0896, 0654
 HTS0802
 Hitachi0846
 Hughes Network Systems0776
 JVC0802
 Jerrold0388, 0654
 Magnavox0749, 0751
 Memorex0751
 Next Level0896
 Panasonic0728
 Philips1103, 0749, 0751

Primestar0654, 0388
 RCA0593, 0170, 0419, 0882
 Radio Shack0896
 Samsung1136
 Sony0666
 Star Choice0896
 Toshiba0776, 0817
 Uniden0751, 0749
 Zenith0883

VCR

Admiral0075, 0236
 Adventura0027
 Aiko0305
 Aiwa0027, 0064
 Akai0068
 America Action0305
 American High0062
 Asha0267
 Audiovox0064
 Beaumark0267
 Bell & Howell0131
 Brooksonic 0148, 0211, 0029, 0236, 0506
 CCE0099, 0305
 Calix0064
 Canon0062
 Carver0108
 Cinerall0305
 Citizen0305, 0064
 Colt0099
 Craig0064, 0099, 0074, 0267, 0298
 Curtis Mathes0062, 0068, 0087, 0189, 0787
 Cybernex0267
 Daewoo0305, 0072
 Denon0069
 Dynatech0027
 Electrohome0064
 ElectroPhonic0064
 Emerex0059
 Emerson0211, 0029, 0236, 0305, 0148, 0506, 0027, 0064, 0070
 Fisher0074, 0131
 Fuji0062
 Funai0027
 GE0062, 0087, 0075, 0267, 0787
 Garrard0027
 Go Video0459, 0553
 GoldStar0064, 0065
 Gradiente0027
 HI-Q0074
 Harley Davidson0027
 Harman/Kardon0065, 0108
 Harwood0099
 Hitachi0069, 0027, 0068
 Hughes Network Systems0069
 JVC0094, 0068
 Jensen0068
 KEC0064, 0305
 KLH0099
 Kenwood0068, 0094, 0065
 Kodak0062, 0064
 LXI0064
 Lloyd's0027
 Logik0099
 MEI0062
 MGA0070, 0267
 MGN Technology0267

Remote Control Direct Entry Codes for Accessory Devices

VCR (continued)

MTC0027, 0267
Magnasonic0305
Magnavox0062, 0108, 0027, 0066, 0176
Magnin0267
Marantz0108, 0062
Marta0064
Matsushita0062, 0189
Memorex0131, 0074, 0506, 0027
0064, 0075, 0062, 0267
0066, 0189, 0236, 1189
Minolta0069
Mitsubishi0070, 0075, 0094
Motorola0062, 0075
Multitech0027, 0099
NEC0065, 0068, 0094, 0131
Nikko0064
Noblex0267
Olympus0062
Optimus0189, 1189, 0075, 0064,
0131, 0459
Orion0506, 0029, 0211, 0236
Panasonic0062, 0189, 1189, 0643
Penney0062, 0267, 0064, 0069, 0065
Pentax0069
Philco0062, 0236, 0506
Philips0108, 0062, 0645
Pilot0064
Pioneer0094
Polk Audio0108
Profitronic0267
Proscan0087, 0787
Protec0099
Pulsar0066
Quasar0062, 0189, 1189
RCA0087, 0176, 0069, 0062,
0075, 0267, 0787
Radio Shack0027
Radix0064
Randex0064

Realistic0027, 0131, 0074, 0075,
0064, 0062
ReplayTV0641, 0643
Runco0066
STS0069
Samsung0072, 0267
Sanky0066, 0075
Sansui0068, 0506, 0027, 0094, 0236, 0298
Sanyo0074, 0131, 0267
Scott0211, 0148, 0070, 0072
Sears0064, 0069, 0027, 0062,
0074, 0131
Semp0072
Sharp0075
Shintom0099
Shogun0267
Singer0099
Sony0059, 0027, 0062, 0063
Sylvania0062, 0108, 0027, 0070
Symphonic0027
TMK0267
Tatung0068
Teac0027, 0068
Technics0062, 0189
Teknika0027, 0062, 0064
Thomas0027
Tivo0645, 0663
Toshiba0072, 0070
Totevision0064, 0267
Unitech0267
Vector0072
Vector Research0065
Video Concepts0072
Videosonic0267
Wards0062, 0087, 0027, 0074,
0267, 0069, 0075, 0099
0108, 0176, 0787
White Westinghouse0099, 0305, 0236
XR-10000099, 0027, 0062
Yamaha0065
Zenith0066, 0027, 0236, 0506

Digital Video Disc (DVD)

Apex0699
Denon0517
Fisher0697
GE0549
Hitachi0691
Hitek0699
JVC0650, 0585
Kenwood0709, 0561
Konka0746, 0738, 0747, 0748
Magnavox0530, 0702
Marantz0566
Mitsubishi0548
Onkyo0530
Optimus0598
Oritron0678
Panasonic0517, 0659
Philips0566, 0530
Pioneer0598, 0552, 0659
Proscan0549
RCA0549, 0598
Samsung0600
Sharp0657
Sony0560
Technics0517
Theta Digita0598
Toshiba0530
Yamaha0517, 0572
Zenith0618, 0530

Regulatory Notices - Federal Communications Commission Notice

This equipment has been tested and found to comply with the limits for a Class B digital device, pursuant to part 15 of the FCC Rules. These limits are designed to provide reasonable protection against harmful interference in a residential installation. This equipment generates, uses, and can radiate radio frequency energy and, if not installed and used in accordance with the instructions, may cause harmful interference to radio communications. However, there is no guarantee that interference will not occur in a particular installation. If this equipment does cause harmful interference to radio or television reception, which can be determined by turning the equipment off and on, the user is encouraged to try to correct the interference by one or more of the following measures:

- Reorient or relocate the receiving antenna.
- Increase the separation between the equipment and the receiver.
- Connect the equipment into an outlet on a circuit different from that to which the receiver is connected.
- Consult the dealer or an experienced radio or television technician for help.

Modifications -

The FCC requires the user to be notified that any changes or modifications made to this device that are not expressly approved by Philips Consumer Electronics may void the user's authority to operate the equipment.

Cables -

Connections to this device must be made with shielded cables with metallic RF/EMI connector hoods to maintain compliance with FCC Rules and Regulations.

Canadian notice -

This Class B digital apparatus meets all requirements of the Canadian Interference-Causing Equipment Regulations.

Avis Canadien -

Cet appareil numérique de la classe B respecte toutes les exigences du Règlement sur le matériel brouilleur du Canada.

Before Calling Service

Symptoms	Items to Check and Actions to follow
“Ghost” or double images	<ul style="list-style-type: none"> This may be caused by obstruction to the antenna due to high rise buildings or hills. Using a highly directional antenna may improve the picture.
No power	<ul style="list-style-type: none"> Check that the TV's AC power cord is plugged into the mains socket. Unplug the television, wait for 60 seconds. The re-insert plug into the mains socket and turn on the television again.
No picture	<ul style="list-style-type: none"> Check antenna connections at the bottom of the TV to see if it properly connected to the TV. Possible broadcast station trouble. Try another channel. Adjust the contrast and brightness settings. Try another auto picture setting. Check the Closed Captions control. Some TEXT modes could block the screen. Switch your HDMI-source to a correct display mode.
No picture and power switched on	<ul style="list-style-type: none"> Your TV has a protective mode in case there is too much heat build-up. Check the clearance around the vents of the device to be certain there are no blocking walls or cabinets which would limit the air flow.
No sound	<ul style="list-style-type: none"> Increase the VOLUME. Check that the TV is not muted, press the MUTE button on the remote control. When no signal is detected, the TV automatically switches off the sound. This is proper operation and does not indicate a malfunction.
Good sound but poor color or no picture	<ul style="list-style-type: none"> Adjust the contrast, color, tint and brightness setting. Try another auto picture setting.
Poor picture	<ul style="list-style-type: none"> Check the HDMI connection.
Snowish picture and noise	<ul style="list-style-type: none"> Check the antenna connection.
Television not responding to remote control	<ul style="list-style-type: none"> Check whether the batteries are working. Replace if necessary. Clean the remote control sensor lens on the TV. Operating range between TV and the remote control should not be > 240”. You can still use the buttons on the right side of your TV. Check if the remote control is in the correct mode.
Control of accessory devices	<ul style="list-style-type: none"> The infrared signals of the screen may influence the reception sensibility of other peripherals. Solution: replace the batteries of the remote control of other devices. E.g. keep away a wireless headphone from within a radius of 50”.
No stable or not synchronized VGA picture	Check if you have selected the correct VGA mode in your PC.

Standby	Your TV consumes energy in the standby mode. Energy consumption contributes to air and water pollution. Power consumption: 2 W.
Miscellaneous	See Extras, Specifications on this CD.

If your problem is not solved

Turn your TV off and then on again once.

Never attempt to repair a defective TV yourself.

Check with your dealer or call a TV technician.

Telephone number Philips Customer
Care Center: 800-531-0039

Tips

Care of the screen

Do not touch, push or rub or strike the screen with anything hard as this may scratch, mar or damage the screen permanently. And please do not rub with dust clothes with chemical treatment.

Do not touch the surface with bare hands or greasy cloth (some cosmetics are detrimental to the screen). Unplug the TV before cleaning the screen.

When the surface becomes dusty, please wipe gently with absorbent cotton or other soft materials like chamois soaks.

Do not use acetone, toluene and alcohol because they cause chemical damage. Do not use liquid cleaners or aerosol cleaners. Wipe off saliva or water drops as soon as possible. Their long time contact with the screen causes deformations and colour fading.

How to dispose of batteries?

The batteries supplied do not contain the heavy metals mercury and cadmium. Nevertheless in many areas batteries may not be disposed of with your household waste. Please ensure you dispose of batteries according to local regulations.

Warning concerning stationary images on the TV screen

A characteristic of Plasma Display Panels is that displaying the same image for a long time can cause a permanent after-image to remain on the screen. This is called phosphor burn in.

Normal use of the TV should involve the showing of pictures that contain constantly moving and changing images that fill the screen.

Examples of stationary images (this is not an all-inclusive list, you may encounter others in your viewing):

- **TV menus;**
- **Black bars:** when black bars appear at the left and right side of the screen, it is recommended to change to a picture format so that the picture fills the entire screen;
- **TV channel logo:** present a problem if they are bright and stationary. Moving or low-contrast graphics are less likely to cause uneven aging of the screen;
- **Stock market stickers:** presented at the bottom of the TV screen;
- **Shopping channel logos and pricing displays:** bright and shown constantly or repeatedly in the same location on the TV screen.

Examples of still pictures also include logos, computer images, time display, teletext and images displayed in 4:3 mode, static images or characters, etc.

Notes:

- reduce contrast and brightness when viewing

- **once burn-in occurs it will never disappear completely.**

LIMITED WARRANTY

One Year Free Labor

One Year Free Service on Parts

WHO IS COVERED?

You must have proof of purchase to receive warranty service. A sales receipt or other document showing that you purchased the product is considered proof of purchase.

WHAT IS COVERED?

Warranty coverage begins the day you buy your product. For one year thereafter, all parts will be repaired or replaced and labor is free. After one year from the day of purchase, you pay for the replacement or repair of all parts, and for all labor charges.

All parts, including repaired and replaced parts, are covered only for the original warranty period. When the warranty on the product expires, the warranty on all replaced and repaired parts also expires.

WHAT IS EXCLUDED?

Your warranty does not cover:

- labor charges for installation or setup of the product, adjustment of customer controls on the product, and installation or repair of antenna systems outside of the product.
- product repair and/or part replacement because of misuse, accident, unauthorized repair or other cause not within the control of Philips Consumer Electronics Company.
- reception problems caused by signal conditions or cable or antenna systems outside the unit.
- a product that requires modification or adaptation to enable it to operate in any country other than the country for which it was designed, manufactured, approved and/or authorized, or repair of products damaged by these modifications.
- incidental or consequential damages resulting from the product. (Some states do not allow the exclusion of incidental or consequential damages, so the above exclusion may not apply to you. This includes, but is not limited to, prerecorded material, whether copyrighted or not copyrighted.)
- a product used for commercial or institutional purposes.

WHERE IS SERVICE AVAILABLE?

Warranty service is available in all countries where the product is officially distributed by Philips Consumer Electronics Company. In countries where Philips Consumer Electronics Company does not distribute the product, the local Philips service organization will attempt to provide service (although there may be a delay

if the appropriate spare parts and technical manual(s) are not readily available).

MAKE SURE YOU KEEP ...

Please keep your sales receipt or other document showing proof of purchase. Attach it to this owner's manual and keep both nearby. Also keep the original box and packing material in case you need to return your product. Please check your owner's manual before requesting service. Adjustments of the controls discussed there may save you a service call.

TO GET WARRANTY SERVICE....

Repair must be performed by an authorized service center or a factory service center. If you do not live near a factory service center, contact your dealer. If your dealer is an authorized service center, he will arrange repair. If your dealer is not an authorized service center he will direct you to the authorized service center engaged by him to service the products he sells.

(In U.S.A., Puerto Rico and U.S. Virgin Islands, all implied warranties, including implied warranties of merchantability and fitness for a particular purpose, are limited in duration to the duration of this express warranty. But, because some states do not allow limitations on how long an implied warranty may last, this limitation may not apply to you.)

(In Canada, this warranty is given in lieu of all other warranties. No other warranties are expressed or implied, including any implied warranties of merchantability or fitness for a particular purpose. Philips is not liable under any circumstances for any direct, indirect, special, incidental or consequential damages, howsoever incurred, even if notified of the possibility of such damages.)

IF YOU HAVE QUESTIONS IN CANADA

Please contact Philips at:
1-800-661-6162 (French speaking)
1-800-363-7278 (English speaking)

REMEMBER...

Please record the model and serial numbers found on the product below. Also, please fill out and mail your warranty registration card promptly. It will be easier for us to notify you if necessary.

MODEL #
SERIAL #

This warranty gives you specific legal rights. You may have other rights which vary from state/province to state/province.

Philips Consumer Electronics Company, P.O. Box 520890, Miami, FL 33152, (402) 536-4171

FACTORY SERVICE LOCATIONS

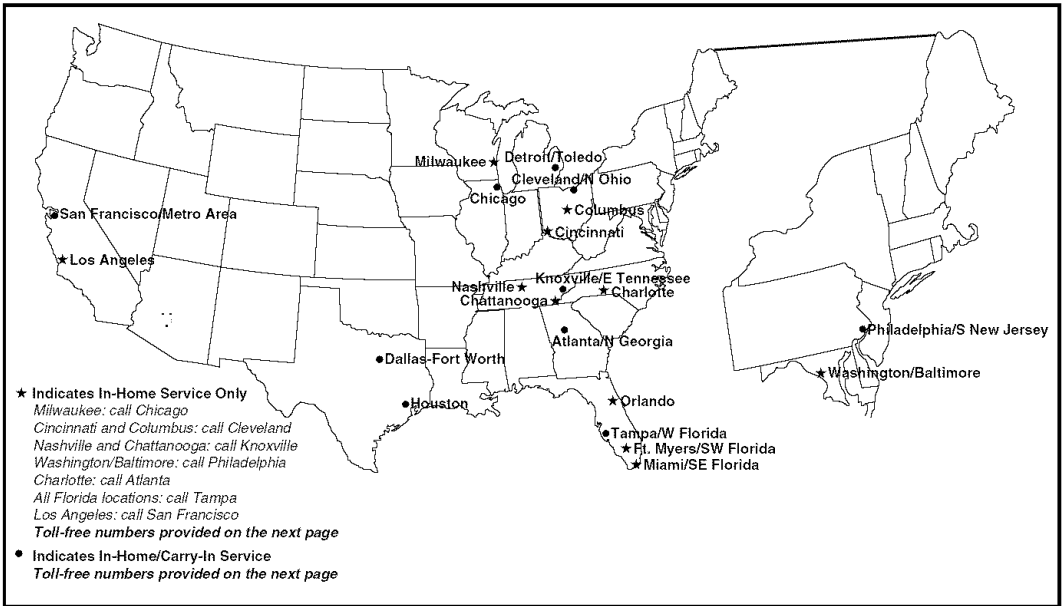

Note: If you reside in one of our Philips Factory Service Branch areas (see directory on back), you can contact the nearest Service Branch to obtain efficient and expedient repair for your product. If your product is In-Warranty, you should have proof-of-purchase to ensure No Charge Service. For Out-of-Warranty service, call the location nearest you.

Nota: Si vous résidez dans une des régions desservies par une succursale de service après vente du fabricant Philips (voir liste ci-dessous), vous pourrez contacter la branche de service après vente la plus près de chez vous pour obtenir un service après vente rapide et efficace. Si le produit est sous garantie, il suffira de présenter une preuve d'achat pour bénéficier d'un service sans frais. Pour les produits non couverts par la garantie, contactez le center le plus près de chez vous.

Nota: Si Ud. reside en una de nuestras zonas para sucursales Philips de servicio al de fábrica (ver directorio más abajo), Ud. puede comunicarse con la sucursal de servicio más cercana para obtener una reparación oportuna y eficaz de su producto. Si su producto está todavía bajo garantía, Ud. debe presentar comprobante de compra para no ocasionar ningunos cargos por servicio. Para servicio después del vencimiento de la garantía, llame al lugar más cercano de los abajo indicados.

In Canada

How you can obtain efficient and expedient carry-in, mail-in, or in-home service for your product
 Please contact Philips at 1-800-661-6162 (French speaking)
 1-800-531-0039 (English or Spanish speaking)

Au Canada

Comment obtenir le service après-vente pour les produits apportés ou envoyés par la poste à notre center de service ou le service à domicile
 Veuillez contacter philips à: 1-800-661-6162 (Francophone)
 1-800-531-0039 (Anglais ou Espagnol)

En el Canadá

Cómo recibir servicio eficiente para su producto, en persona, por correo o a domicilio
 Favor de comunicarse con Philips al: 1-800-661-6162 (Francés)
 1-800-531-0039 (Inglés o Español)

FACTORY SERVICE LOCATIONS

Quality service is as close as your telephone! Simply look over the list below for the number of a Factory Service Center near you.

Your product will receive efficient and expedient carry-in, mail-in, or in-home service, and you will receive peace of mind, knowing your product is being given the expert attention of Philips' Factory Service.

Comment obtenir notre service après vente rapide et efficace soit par courrier, à domicile, ou en se présentant à un centre de service Philips. Plus de 600 centres de réception de produits à réparer à travers le pays: contacter le centre de service aux consommateurs le plus proche pour savoir l'emplacement de ces dépôts dans un rayon de 50 à 75 miles (80 km à 120 km) du centre de service local.

Cómo obtener un servicio oportuno y eficiente por correo, en casa o en persona para su producto a través de un centro Philips de servicio. Mas de 600 sitios por todo el país para la recepción de productos necesitados de reparaciones: comunicarse con el centro de servicio de fabrica mas cercano para estos lugares dentro de un radio de 80 a 120 km (50 a 75 millas) del centro de servicio local.

ATLANTA

Philips Factory Service
550 Franklin Road., Suite F
Marietta, GA 30067
800-273-1501

TAMPA

Philips Factory Service
1911 US Highway 301 North
Tampa, FL 33619
800-442-2027

SAN FRANCISCO

Philips Factory Service
681 East Brokaw Rd.
San Jose, CA 95112
800-300-9103

HOUSTON

Philips Factory Service
1110 N. Post Oak Rd., Suite
100
Houston, TX 77055
800-952-3254

CLEVELAND

Philips Factory Service
950 Keynote Circle
Brooklyn Heights, OH 44131
800-331-7037

DETROIT

Philips Factory
25173 Dequindre
Madison Heights, MI 48071
800-438-1398

DALLAS-FORT WORTH

Philips Factory Service
415 N. Main Street, #107
Euless, TX 76040
800-952-3254

CHICAGO

Philips Factory Service
1279 W. Hamilton Pkwy.
Itasca, IL 60143
800-531-2922

KNOXVILLE

Philips Factory Service
6700 D Papermill Rd.
Knoxville, TN 37919
800-821-1767

PHILADELPHIA

Philips Factory Service
352 Dunks Ferry Rd.
Bensalem, PA 19020
800-847-9320

