

FEATURES

- **181 Channel Selection-** All VHF/UHF channels plus up to 125 cable channels.
- **PLL Frequency Synthesized Tuning-** Provides free and easy channel selection and lets you tune directly to any channel using the channel number buttons on the remote control.
- **Sleep Timer**
- **Closed Caption Decoder**
- **Auto Shut Off Function-** If there is no signal input from the antenna terminal and no user operation for 15 minutes, the TV will turn itself off automatically.
- **V-CHIP-** Enables parents to prevent their children from watching inappropriate material on TV.
- **Tinted, Bright Black Matrix Picture Tube**
- **Full-Function Remote Control**
- **On-Screen Function Display**
- **Front / Rear AV Input**
- **MTS / SAP Tuner**
- **Resume Function-** If the power fails or is disconnected while the TV is on, the TV will turn on automatically when the power resumes.

PRECAUTIONS

- Place your TV in a room with adequate ventilation.
- Keep your TV set away from sources of direct heat, such as heat registers or direct sunlight.
- Do not place your TV on soft surfaces, such as rugs or blankets.
- Leave enough room for air to circulate around the bottom, top and back of the set.

The serial number of this product may be found on the back of the TV. No others have the same serial number as yours. You should record the number and other vital information here and retain this book as a permanent record of your purchase to aid identification in case of theft.

Date of Purchase	Dealer Phone No.	
Dealer Purchase from	Model No.	
Dealer Address	Serial No.	

IF YOU NEED ADDITIONAL ASSISTANCE WITH SET-UP OR OPERATING AFTER READING OWNER'S MANUAL, PLEASE CALL TOLL FREE 1-800-968-3429 OR VISIT OUR WEB SITE AT <http://www.SylvaniaConsumerElectronics.com>

IMPORTANT SAFEGUARDS

WARNING:

TO REDUCE THE RISK OF FIRE OR ELECTRIC SHOCK, DO NOT EXPOSE THIS APPLIANCE TO RAIN OR MOISTURE.

CAUTION
RISK OF ELECTRIC SHOCK
DO NOT OPEN

CAUTION: TO REDUCE THE RISK OF ELECTRIC SHOCK, DO NOT REMOVE COVER (OR BACK) NO USER SERVICEABLE PARTS INSIDE. REFER SERVICING TO QUALIFIED SERVICE PERSONNEL.

The important note is located on the rear of the cabinet.

THIS SYMBOL INDICATES THAT DANGEROUS VOLTAGE CONSTITUTING A RISK OF ELECTRIC SHOCK IS PRESENT WITHIN THIS UNIT.

THIS SYMBOL INDICATES THAT THERE ARE IMPORTANT OPERATING AND MAINTENANCE INSTRUCTIONS IN THE LITERATURE ACCOMPANYING THE APPLIANCE.

1. **READ INSTRUCTIONS** - All the safety and operating instructions should be read before the appliance is operated.
2. **RETAIN INSTRUCTIONS** - The safety and operating instructions should be retained for future reference.
3. **HEED WARNINGS** - All warnings on the appliance and in the operating instructions should be adhered to.
4. **FOLLOW INSTRUCTIONS** - All operating and use instructions should be followed.
5. **CLEANING** - Unplug TV from the wall outlet before cleaning. Do not use liquid cleaners or aerosol cleaners. Use a damp cloth for cleaning.
EXCEPTION: A product that is meant for uninterrupted service and, that for some specific reason, such as the possibility of the loss of an authorization code for a CATV converter, is not intended to be unplugged by the user for cleaning or any other purpose, may exclude the reference to unplugging the appliance in the cleaning description otherwise required in item 5.
6. **ATTACHMENTS** - Do not use attachments not recommended by the TV manufacturer as they may cause hazards.
7. **WATER AND MOISTURE** - Do not use this TV near water, for example, near a bath tub, wash bowl, kitchen sink, or laundry tub, in a wet basement, or near a swimming pool, and the like.
8. **ACCESSORIES** - Do not place this TV on an unstable cart, stand, tripod, bracket, or table. The TV may fall, causing serious injury to someone, and serious damage to the appliance. Use only with a cart, stand, tripod, bracket, or table recommended by the manufacturer, or sold with the TV. Any mounting of the appliance should follow the manufacturer's instructions and should use a mounting accessory recommended by the manufacturer. An appliance and cart combination should be moved with care. Quick stops, excessive force, and uneven surfaces may cause the appliance and cart combination to overturn.

AMEUBLES - Cet appareil ne doit être placé que sur un meuble (avec ou sans roulettes) recommandé par le fabricant. Si vous l'installez sur un meuble à roulettes, déplacez les deux ensembles avec précaution. Un arrêt brusque, l'utilisation d'une force excessive et des surfaces irrégulières risquent de déstabiliser l'ensemble et de le renverser.

9. **VENTILATION** - Slots and openings in the cabinet and the back or bottom are provided for ventilation and to ensure reliable operation of the TV and to protect it from overheating, these openings must not be blocked or covered. The openings should never be blocked by placing the TV on a bed, sofa, rug, or other similar surface. This TV should never be placed near or over a radiator or heat register. This TV should not be placed in a built-in installation such as a bookcase or rack unless proper ventilation is provided or the manufacturer's instructions have been adhered to.
10. **POWER SOURCES** - This TV should be operated only from the type of power source indicated on the marking label. If you are not sure of the type of power supply to your home, consult your appliance dealer or local power company. For TVs intended to operate from battery power, or other sources, refer to the operating instructions.
11. **GROUNDING OR POLARIZATION** - This TV is equipped with a polarized alternating-current line plug (a plug having one blade wider than the other). This plug will fit into the power outlet only one way. This is a safety feature. If you are unable to insert the plug fully into the outlet, try reversing the plug. If the plug should still fail to fit, contact your electrician to replace your obsolete outlet. Do not defeat the safety purpose of the polarized plug.
12. **POWER-CORD PROTECTION** - Power-supply cords should be routed so that they are not likely to be walked on or pinched by items placed upon or against them, paying particular attention to cords at plugs, convenience receptacles, and the point where they exit from the appliance.



13. **OUTDOOR ANTENNA GROUNDING** - If an outside antenna or cable system is connected to the TV, be sure the antenna or cable system is grounded so as to provide some protection against voltage surges and built-up static charges. Article 810 of the National Electrical Code, ANSI/NFPA No. 70, provides information with respect to proper grounding of the mast and supporting structure, grounding of the lead-in wire to an antenna discharge unit, size of grounding conductors, location of antenna-discharge unit, connection to grounding electrodes, and requirements for the grounding electrode. (Fig. A)
14. **LIGHTNING** - For added protection for this TV receiver during a lightning storm, or when it is left unattended and unused for long periods of time, unplug it from the wall outlet and disconnect the antenna or cable system. This will prevent damage to the TV due to lightning and power-line surges.
15. **POWER LINES** - An outside antenna system should not be located in the vicinity of overhead power lines or other electric light or power circuits, or where it can fall into such power lines or circuits. When installing an outside antenna system, extreme care should be taken to keep from touching such power lines or circuits as contact with them might be fatal.
16. **OVERLOADING** - Do not overload wall outlets and extension cords as this can result in a risk of fire or electric shock.
17. **OBJECT AND LIQUID ENTRY** - Never push objects of any kind into this TV through openings as they may touch dangerous voltage points or short out parts that could result in a fire or electric shock. Never spill liquid of any kind on the TV.
18. **SERVICING** - Do not attempt to service this TV yourself as opening or removing covers may expose you to dangerous voltage or other hazards. Refer all servicing to qualified service personnel.
19. **DAMAGE REQUIRING SERVICE** - Unplug this TV from the wall outlet and refer servicing to qualified service personnel under the following conditions:
 - a. When the power supply cord or plug is damaged or frayed.
 - b. If liquid has been spilled, or objects have fallen into the TV.
 - c. If the TV has been exposed to rain or water.
 - d. If the TV does not operate normally by following the operating instructions. Adjust only those controls that are covered by the operating instructions, as improper adjustment of other controls may result in damage and will often require extensive work by a qualified technician to restore the TV to its normal operation.
 - e. If the TV has been dropped or damaged in any way.
 - f. When the TV exhibits a distinct change in performance, this indicates a need for service.
20. **REPLACEMENT PARTS** - When replacement parts are required, be sure the service technician uses replacement parts specified by the manufacturer that have the same characteristics as the original part. Unauthorized substitutions may result in fire, electric shock, injury to persons or other hazards.
21. **SAFETY CHECK** - Upon completion of any service or repairs to this TV, ask the service technician to perform routine safety checks to determine that the TV is in proper operating condition.
22. **HEAT** - This TV product should be situated away from heat sources such as radiators, heat registers, stoves, or other products (including amplifiers) that produce heat.

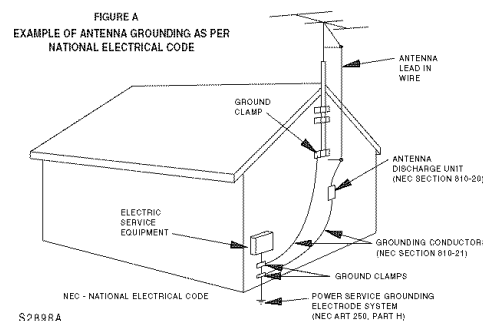

FCC WARNING - This equipment may generate or use radio frequency energy. Changes or modifications to this equipment may cause harmful interference unless the modifications are expressly approved in the instruction manual. The user could lose the authority to operate this equipment if an unauthorized change or modification is made.

Note to CATV system installer:

This reminder is provided to call the CATV system installer's attention to Article 820-40 of the NEC that provides guidelines for proper grounding and, in particular, specifies that the cable ground shall be connected to the grounding system of the building as close to the point of cable entry as practical.

PREPARATION FOR USE

CONNECTIONS

Cables used here are available on the market.

[ANTENNA CONNECTION]

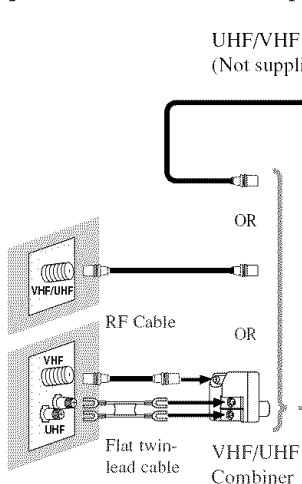

[CATV/SATELLITE CONNECTION]

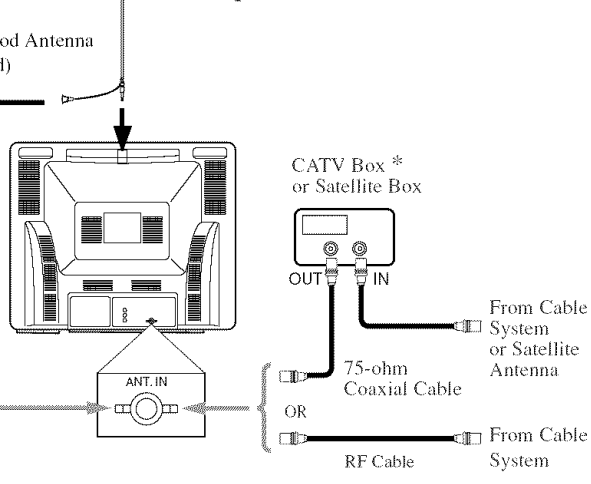

*Some cable TV systems use scrambled signals and require a special converter to receive these channels. Consult your local cable company.

CAUTION: TO PREVENT ELECTRIC SHOCK, MATCH WIDE BLADE OF PLUG TO WIDE SLOT, FULLY INSERT.

ATTENTION: POUR ÉVITER LES CHOC ÉLECTRIQUES, INTRODUIRE LA LAME LA PLUS LARGE DE LA FICHE DANS LA BORNE CORRESPONDANTE DE LA PRISE ET POUSSER JUSQU'AU FOND.

Note:

- For your safety and to avoid damages to the unit, unplug the antenna cable from the ANT. IN jack before moving the unit.

[EXTERNAL CONNECTION]

VIDEO input (rear)

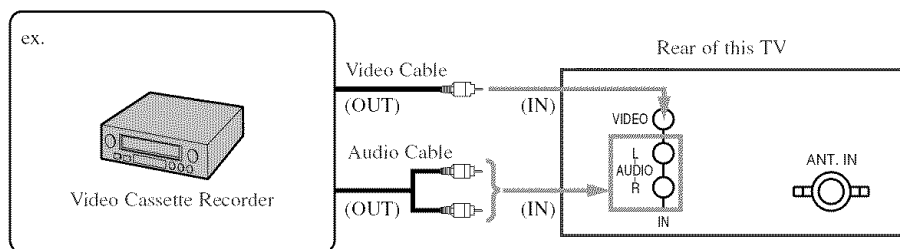

Note:

- The AUDIO L jack is for mono input. The sound is heard from both speakers. Use this jack for connecting monaural audio equipment.

VIDEO input (front)

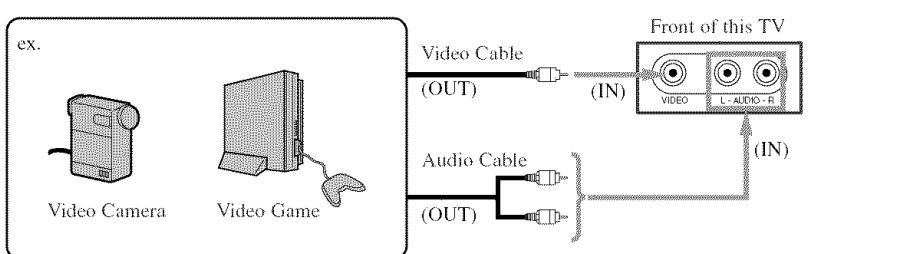

Note:

- When both rear and front input jacks are connected simultaneously, priority is given to the front jacks. When using rear input jacks, disconnect the cables from the front jacks.

SELECTING AUDIO/VIDEO INPUT

You can select external input jacks by hitting **[GAME]** on the remote control.

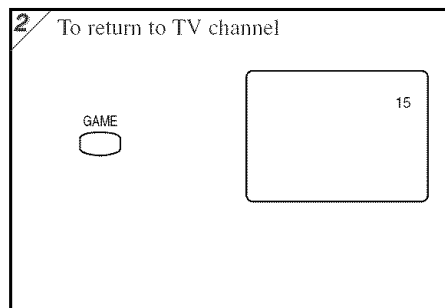
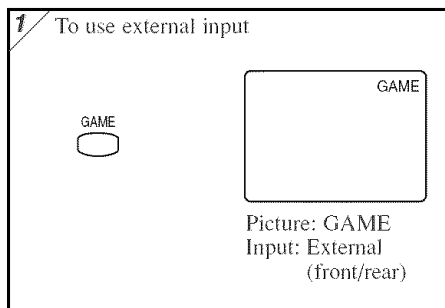

In the Game mode, you can use front or rear input jacks with suitable picture adjustments for video games.

Notes:

- If you hit **[GAME]** when the TV is off, the TV turns on and enters in Game mode.
- If you adjust another picture control while in Game mode, this mode will automatically be canceled.

You can enter into Video mode from Game mode by adjusting a Picture control.

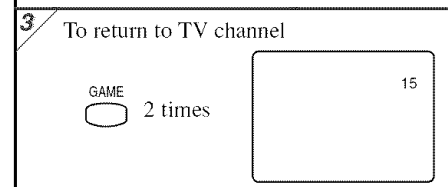
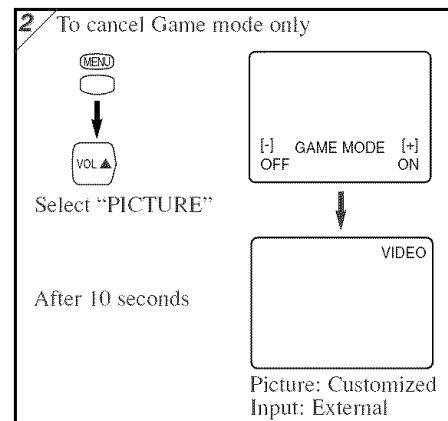
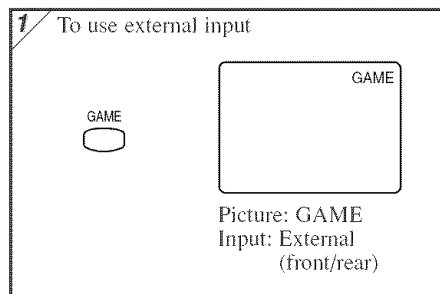

INSTALLING THE BATTERIES

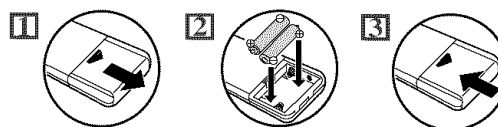

Install two AA batteries (supplied) matching the polarity indicated inside battery compartment of the remote control.

[BATTERY PRECAUTIONS]

- Be sure to follow the correct polarity as indicated in the battery compartment. Reversed batteries may cause damage to the device.
- Do not mix different types of batteries together (e.g. Alkaline and Carbon-Zinc) or old batteries with fresh ones.
- If the device is not to be used for a long period of time, remove the batteries to prevent damage or injury from possible battery leakage.
- Do not try to recharge batteries not intended to be recharged; they can overheat and rupture.

OPERATIONS

REMOTE CONTROL AND FRONT PANEL FUNCTION

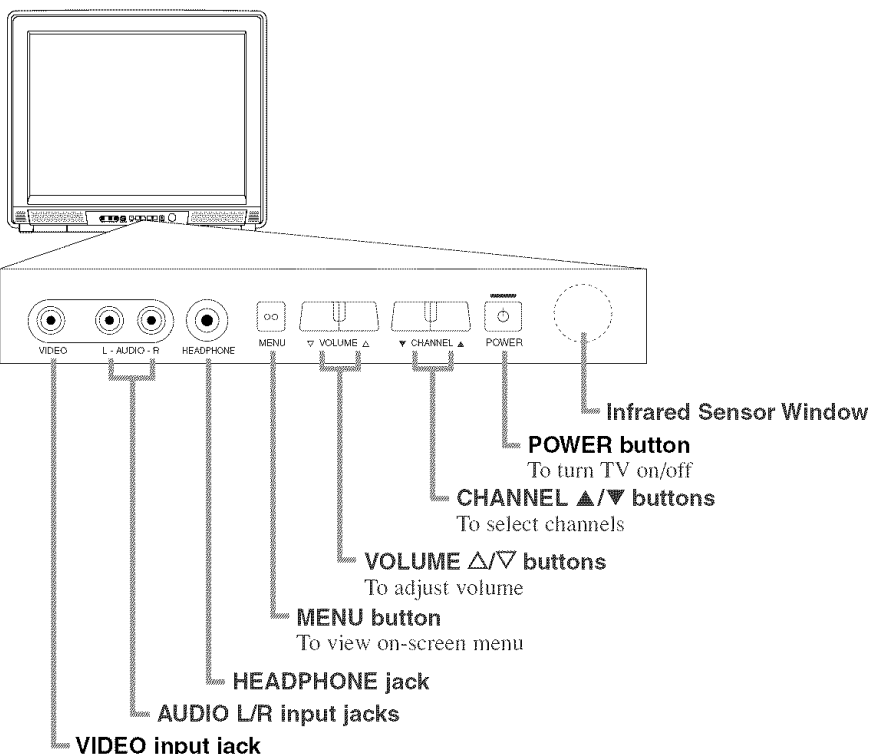
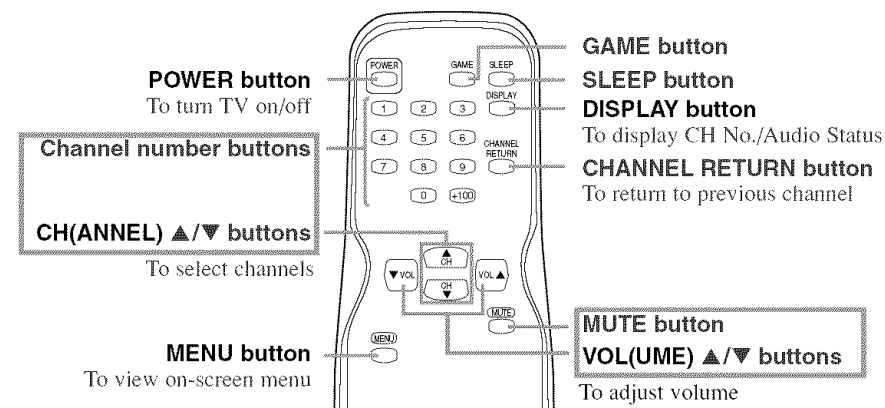

Note:

- If some digits appear in the corner of the screen when the unit is turned on for the first time, hit **[POWER]** without unplugging the power cord.

OPERATIONS (Continued)

CHANNEL SETTING

[AUTO PRESET CHANNELS]

As the initial setting, this TV has memorized all channels, including the ones not available in your area. This feature automatically puts only available channels into the memory.

- Select "CHANNEL SET"**

PICTURE
 CHANNEL SET
 [ENG] / [ESP] / [FRA]
 V-CHIP SET UP
 CAPTION [OFF]
 TV SOUND [MAIN]
- Select "AUTO PRESET CH"**

ADD/DELETE
 AUTO PRESET CH

The tuner scans and memorizes all available channels in your area.
- When the scanning is completed, the lowest memorized channel appears on the TV screen.

- Notes:**
- The TV distinguishes between standard TV channels and cable (CATV) channels.
 - The TV may recognize TV channels as CATV channels if reception condition is poor. If this happens, check the antenna connections and try steps **2** to **3** again when reception conditions are better.
 - If there is no TV signal input, "NO TV SIGNALS" will appear on the display after the completion of channel scanning.
- 

[ADDING/DELETING CHANNELS]

You can add or delete channels manually.

- Select "CHANNEL SET"**

PICTURE
 CHANNEL SET
 [ENG] / [ESP] / [FRA]
 V-CHIP SET UP
 CAPTION [OFF]
 TV SOUND [MAIN]
- Select "ADD/DELETE"**

ADD/DELETE
 AUTO PRESET CH
- Select the channel you wish**
- Add or delete the channel**

ADD/DELETE

Add: light blue
 Delete: light red

Note:

- The menu will disappear automatically after about 10 seconds.

PICTURE ADJUSTMENT

- Select "PICTURE"**

PICTURE
 CHANNEL SET
 [ENG] / [ESP] / [FRA]
 V-CHIP SET UP
 CAPTION [OFF]
 TV SOUND [MAIN]
- Select an item to adjust**

[GAME MODE] ↔ [BRIGHT] ↔ [CONTRAST]
 [SHARPNESS] ↔ [TINT] ↔ [COLOR]
- Adjust the setting**

[+] BRIGHT [-]
 0000000000

- Notes:**
- The display will disappear automatically after 10 seconds unless you press any buttons.
 - Magnetism from nearby appliances and speakers might affect the color of the TV picture. If this happens, hit [POWER] to turn off the TV and turn it on again after about 30 minutes.

GAME MODE

Set to the most suitable position for video games.
 [-] : OFF [+] : ON

BRIGHT

Adjust until the darkest parts of the picture are as bright as you prefer.
 [-] : decrease brightness
 [+] : increase brightness

CONTRAST

Adjust to increase or decrease contrast.
 [-] : decrease contrast
 [+] : increase contrast

COLOR

Adjust to be brilliant or pale color.
 [-] : be pale color [+] : be brilliant color

TINT

Adjust to obtain natural skin tones.
 [-] : add red [+] : add green

SHARPNESS

Adjusts the detail of the picture.
 [-] : make soft [+] : make clear

CLOSED CAPTION

You may view specially labeled (cc) TV programs, movies, news and prerecorded tapes, etc. with either a dialogue caption or text display added to the program.

- Select "CAPTION"**

PICTURE
 CHANNEL SET
 [ENG] / [ESP] / [FRA]
 V-CHIP SET UP
 CAPTION [OFF]
 TV SOUND [MAIN]

- Select the desired caption mode**

[OFF] ↔ [C1] ↔ [C2]
 [T2] ↔ [T1]
- To exit the menu**

[CAPTION MODE (C1, C2)]

- CAPTION1 (C1)**
 displays standard closed captions (what a character is saying).
- CAPTION2 (C2)**
 displays foreign language closed captions (foreign language words showing what a character is saying).
- There are three ways of displaying according to programs:
 - Paint-on mode:** Displays input characters on the screen immediately.
 - Pop-on mode:** Once characters are stored in memory, they are displayed all at once.
 - Roll-up mode:** Displays the characters continuously by scrolling (max. 4 lines).

Notes:

- If closed captioning is not broadcasted, you cannot receive it and nothing is displayed.
- When your TV receives a special effects playback signal (i.e., Search, Slow and Still) from a VCR's video output channel (CH3 or CH4), the TV may not display the correct caption or text.
- Captions and texts may not match the TV voice exactly.
- Interference may cause the closed caption system not to function properly.
- The caption or text characters will not be displayed while the menu display or functions display is shown.
- If a black box appears on the screen, this means that the TV is set to TEXT mode. To clear screen, select CAPTION [C1], [C2] or [OFF].

[TEXT MODE (T1, T2)]

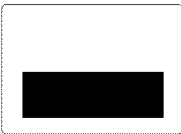
- TEXT1 (T1) and TEXT2 (T2) display half-screen text by scrolling (such as a channel guide, schedule or announcement).
- 

SLEEP TIMER SETTING

- SLEEP**

SLEEP 0
- SLEEP** repeatedly

SLEEP 10

The time increases by 10 minutes up to 90.

Notes:

- When you disconnect the unit from the AC outlet or when you have a power failure, the sleep time will be lost.
- To cancel the sleep timer, hit [SLEEP] repeatedly until "SLEEP 0" is displayed.
- The Sleep Timer Setting display will disappear automatically after 10 seconds of the operation.

MULTI-CHANNEL TELEVISION SOUND (MTS)

- Select "TV SOUND"**

PICTURE
 CHANNEL SET
 [ENG] / [ESP] / [FRA]
 V-CHIP SET UP
 CAPTION [OFF]
 TV SOUND [MAIN]
- Select the desired sound mode

[MAIN] ↔ [MONO] ↔ [SAP]
- To exit the menu

Menu Selection Type of broadcast	MAIN	MONO	SAP*
Regular	-None-	-None-	-None-
Stereo broadcast	STEREO	MONO	STEREO
SAP	MAIN	MAIN	SAP

*Second Audio Program (SAP) :

Your program can also be received in a second language or sometimes a radio station.

Note:

- If you select [SAP] when second audio is not available, the TV will receive normal audio.

OPTIONAL SETTINGS

LANGUAGE SELECTION

- Select [ENG]**

PICTURE
 CHANNEL SET
 [ENG] / [ESP] / [FRA]
 V-CHIP SET UP
 CAPTION [OFF]
 TV SOUND [MAIN]

- Select the desired language**

[ENG(lish)] ↔ [ESP(añol)]
 [FRA(nçais)]
- To exit the menu

OPTIONAL SETTINGS (Continued)

V-CHIP SET UP

This enables parents to prevent their children from watching inappropriate material on TV.

- The limitation is not available for news, sports programs, unedited movies on premium cable channels and Emergency Broadcast System signals.
- When you try to access to a program which is blocked, "PROTECTED PROGRAM by ..." message appears on the TV screen.
- Programming may be rated by the Motion Picture Association of America (MPAA) or according to the Television Parental Guidelines. In order to block any inappropriate programming, set your limits in both MPAA RATING and TV RATING.

1 Select "V-CHIP SET UP"

PICTURE CHANNEL SET [ENG] / ESP / FRA
 V-CHIP SET UP
 CAPTION [OFF]
 TV SOUND [MAIN]

2 Enter 4-digit code

ACCESS CODE
 [] [] [] []

If you have not set up your personal access code, enter 0000 (default access code).

3 Select a feature to set up

TV RATING [A]
 MPAA RATING [B]
 CHANGE CODE [C]

A [TV RATING SET UP]

4 Select a rating

TV-Y [VIEW]
 TV-Y7 () [VIEW]
 TV-G [VIEW]
 TV-PG () [VIEW]
 TV-14 () [VIEW]
 TV-MA () [VIEW]

<Selection> <Rating Category Explanations>

- TV-Y: Appropriate for all children
- TV-Y7: Appropriate for children seven and older
- TV-G: General Audience
- TV-PG: Parental Guidance suggested
- TV-14: Unsuitable for children under 14
- TV-MA: Mature audience only

5-1 * Rating with no sub categories
 Set to [BLOCK] or [VIEW]

TV-Y [VIEW]
 TV-Y7 () [VIEW]
 TV-G [BLOCK]
 TV-PG (DLSV) [BLOCK]
 TV-14 (DLSV) [BLOCK]
 TV-MA (LSV) [BLOCK]

5-2 * Rating with sub categories

TV-Y [VIEW]
 TV-Y7 () [VIEW]
 TV-G [VIEW]
 TV-PG () [VIEW]
 TV-14 () [VIEW]
 TV-MA () [VIEW]

Sub categories

TV-PG [BLOCK]
 D [BLOCK]
 L [BLOCK]
 S [BLOCK]
 V [BLOCK]

Set to [BLOCK] or [VIEW]

TV-PG [BLOCK]
 D [VIEW]
 L [BLOCK]
 S [BLOCK]
 V [BLOCK]

<Selection> <Rating Category Explanations>

- TV-Y7: Fantasy Violence
- TV-PG / TV-14 / TV-MA: Suggestive Dialog (TV-PG, TV-14 only)
- L: Coarse Language
- S: Sexual Situation
- V: Violence

B [MPAA RATING SET UP]

4 Select a rating

G [VIEW]
 PG [VIEW]
 PG-13 [VIEW]
 R [VIEW]
 NC-17 [VIEW]
 X [VIEW]

<Selection> <Rating Category Explanations>

- G: General Audience
- PG: Parental Guidance suggested
- PG-13: Unsuitable for children under 13
- R: Restricted; under 17 requires accompanying parent or adult guardian
- NC-17: No one under 17 admitted
- X: Mature audience only

6 To exit the menu

Notes (for TV RATING and MPAA RATING):

- You cannot access the setup menu when the "PROTECTED PROGRAM by ..." message appears. Move to an unblocked channel before you hit [MENU].
- When you select a rating and set it to [BLOCK], the higher ratings will be blocked automatically. The lower ratings will be available for viewing.
- When you set the lowest rating to [VIEW], all other ratings will automatically be available for viewing.

C [CHANGING THE ACCESS CODE]

4 Enter 4-digit code

NEW CODE [] [] [] []
 CONFIRM CODE [] [] [] []

5 To exit the menu

Notes:

- Make sure you enter exactly the same new code in the "CONFIRM CODE" space as one in the "NEW CODE" space. If they are different, the "NEW CODE" space is cleared for redoing.
- Your personal access code will be erased and will return to the default (0000) when a power failure occurs or when you turn off the power using a wall switch. If you have forgotten the code, unplug the power cord for 10 seconds to restore the access code to 0000.

TROUBLESHOOTING GUIDE

Sometimes a performance problem can be easily solved by checking seemingly apparent but often overlooked possibilities. Before arranging for service, check these items. It could save your time and money.

QUICK SERVICE CHECK LIST	PROBLEM													
	Remote Control Doesn't Work	Bars On Screen	Picture Distorted	Picture Rolls Vertically	No Color	Poor Reception on Some Channels	Weak Picture	Lines or Streaks in Picture	Ghosts in picture	Picture Blurred	Sound OK, Picture Poor	Picture OK, Sound Poor	No Picture or Sound	Different color marks on screen
Try a new channel, if OK, then possible station trouble.			X	X	X	X	X	X	X	X	X	X	X	X
Is TV plugged in?	X													X
Power at outlet?		X												X
Is TV's power on?														X
Is antenna or cable connected to terminal on the back of the set?					X	X	X	X	X	X	X	X	X	X
If outside antenna is being used, check for broken wire or loose connection.		X	X	X	X	X	X	X	X	X	X	X	X	X
Check for local interference.		X	X	X	X	X	X	X	X	X	X	X	X	X
Turn off the TV and then turn it on after about a minute.														X
Adjust COLOR control.					X									
Adjust CONTRAST & BRIGHT control.						X				X				
Check batteries in remote control.	X													
Move the TV away from the nearby appliances which generate a magnetic field.														X
Turn off using [POWER], then turn it on again 30 minutes later or so.														X

Closed Caption Problem	Possible Remedy
Misspelled captions are shown.	Spelling errors may pass through uncorrected by the closed captioning production company in a live broadcast.
Text is not shown in its entirety or there is a delay of what is being said.	Captions that are delayed a few seconds behind the actual dialogue are common for live broadcasts. Most captioning production companies can display a dialogue to a maximum of 220 words per minute. If a dialogue exceeds that rate, selective editing is used to insure that the captions remain up-to-date with the current TV screen dialogue.
Captions are scrambled with white boxes on the TV screen.	Interference caused by building, power lines, thunderstorms, etc. may cause scrambled or incomplete captions to appear.
No captions are displayed in a program which must contain closed caption.	Broadcasters may a time compression process to the actual program so that additional advertising time can be given. In this case, captions will be lost since the decoder cannot read the compressed information.
No captions are displayed when playing a prerecorded videotape with closed caption.	The videotape may be either an illegal copy or the tape duplicating company may accidentally have left out the captioning signals during the copying process.
The TV screen shows a black box.	You are in TEXT mode. Select CAPTION [C1], [C2] or [OFF].

MAINTENANCE

CABINET CLEANING

- Wipe the front panel and other exterior surfaces of the TV with a soft cloth immersed in lukewarm water and wrung dry.
- Never use a solvent or alcohol. Do not spray insecticide liquid near the TV. Such chemicals may cause damage and discoloration to the exposed surfaces.

PICTURE TUBE CLEANING

Wipe the picture tube of the TV with a soft cloth. Before cleaning the picture tube, disconnect the power cord.

SUPPLIED ACCESSORIES

- Owner's Manual (1EMN20416)
- Remote control unit (NE121UD)
- Batteries ("AA" x 2)

SPECIFICATIONS

GENERAL SPECIFICATIONS

Television system: NTSC-M
 TV Standard

Closed Caption System: §15.119/FCC

Channel coverage: VHF: 2 - 13
 UHF: 14 - 69
 CATV: 2 - 13, A - W, W+1 - W+84, A-5 - A-1, 5A

Tuning System: 181 channel frequency synthesized tuning system

Channel access: Direct access keyboard, programmable scan and up/down

Terminals: Antenna input: VHF/UHF/CATV
 75 ohm unbalanced (F-type)

Video input: RCA connector x 2 (1 x Front / 1 x Rear)

Audio input: RCA connector x 4 (2 (L/R) x Front / 2 (L/R) x Rear)

Headphone: 1/8" stereo (3.5mm)

Stereo Sound System 2 speakers

ELECTRICAL SPECIFICATIONS

Sound output: 1W, 8 ohm x 2

OTHER SPECIFICATIONS

Remote control: Digital encoded infrared light system

Operating temperature: 5°C to 40°C (41°F-104°F)

Power requirements: AC120V, 60Hz

Power consumption (Maximum): 110W

Picture tube: 27"

Dimensions: H: 22-1/16" (560mm)
 W: 26" (660mm)
 D: 19-11/16" (500mm)

Weight: 77.2 lbs. (35kg)

• Designs and specifications are subject to change without notice and without our legal obligation.
 • If there is a discrepancy between languages, the default language will be English.

SYLVANIA LIMITED WARRANTY

FUNAI CORP. will repair this SYLVANIA product, free of charge in the USA in the event of defect in materials or workmanship as follows:

DURATION:

PARTS:

FUNAI CORP. will provide parts to replace defective parts without charge for one (1) year from the date of original retail purchase. Two (2) years for Picture Tube. Certain parts are excluded from this warranty.

LABOR:

FUNAI CORP. will provide the labor without charge for a period of ninety (90) days from the date of original retail purchase.

LIMITS AND EXCLUSIONS:

THIS WARRANTY IS EXTENDED ONLY TO THE ORIGINAL RETAIL PURCHASER. A PURCHASE RECEIPT OR OTHER PROOF OF ORIGINAL RETAIL PURCHASE WILL BE REQUIRED TOGETHER WITH THE PRODUCT TO OBTAIN SERVICE UNDER THIS WARRANTY.

This warranty shall not be extended to any other person or transferee.

This warranty is void and of no effect if any serial numbers on the product are altered, replaced, defaced, missing or if service was attempted by an unauthorized service center. This SYLVANIA Limited warranty does not apply to any product not purchased and used in the United States.

This warranty only covers failures due to defects in material or workmanship which occurs during normal use. It does not cover damage which occurs in shipment, failures which are caused by repairs, alterations or product not supplied by FUNAI CORP., or damage which results from accident, misuse, abuse, mishandling, misapplication, alteration, faulty installation, improper maintenance, commercial use such as hotel, rental or office use of this product or damage which results from fire, flood, lightning or other acts of God.

THIS WARRANTY DOES NOT COVER PACKING MATERIALS, ANY ACCESSORIES (EXCEPT REMOTE CONTROL), ANY COSMETIC PARTS, COMPLETE ASSEMBLY PARTS, DEMO OR FLOOR MODELS.

FUNAI CORP. AND ITS REPRESENTATIVES OR AGENTS SHALL IN NO EVENT BE LIABLE FOR ANY GENERAL, INDIRECT OR CONSEQUENTIAL DAMAGES ARISING OUT OF OR OCCASIONED BY THE USE OF OR THE INABILITY TO USE THIS PRODUCT. THIS WARRANTY IS MADE IN LIEU OF ALL OTHER WARRANTIES, EXPRESS OR IMPLIED, AND OF ALL OTHER LIABILITIES ON THE PART OF FUNAI. ALL OTHER WARRANTIES INCLUDING THE WARRANTY OF MERCHANTABILITY AND FITNESS FOR A PARTICULAR PURPOSE, ARE HEREBY DISCLAIMED BY FUNAI AND ITS REPRESENTATIVES IN THE UNITED STATES.

ALL WARRANTY INSPECTIONS AND REPAIRS MUST BE PERFORMED BY A FUNAI AUTHORIZED SERVICE CENTER. THIS WARRANTY IS ONLY VALID WHEN THE UNIT IS CARRIED-IN TO A FUNAI AUTHORIZED SERVICE FACILITY.

THE PRODUCT MUST BE ACCOMPANIED BY A COPY OF THE ORIGINAL RETAIL PURCHASE RECEIPT. IF NO PROOF OF PURCHASE IS ATTACHED, THE WARRANTY WILL NOT BE HONORED AND REPAIRS COSTS WILL BE CHARGED.

IMPORTANT:

THIS LIMITED WARRANTY GIVES YOU SPECIFIC LEGAL RIGHTS. YOU MAY HAVE OTHER RIGHTS THAT VARY FROM STATE TO STATE. IF, AT ANY TIME DURING THE WARRANTY PERIOD, YOU ARE UNABLE TO OBTAIN SATISFACTION WITH THE REPAIR OF THIS PRODUCT, PLEASE CONTACT FUNAI CORP.

ATTENTION:

FUNAI CORP. RESERVES THE RIGHT TO MODIFY ANY DESIGN OF THIS PRODUCT WITHOUT PRIOR NOTICE.

To locate your nearest SYLVANIA Authorized Service Center or general service inquiries, please call or write to the following:

FUNAI CORPORATION, INC.
SERVICE CENTER
19900 Van Ness Avenue, Torrance, CA 90501
Tel :1-800-968-3429
<http://www.SylvaniaConsumerElectronics.com>
Head Office: 100 North Street, Teterboro, NJ 07608

PLEASE DO NOT SHIP YOUR UNIT TO THE TETERBORO ADDRESS.