

Gas Range Guide



Table of Contents

For Future Assistance	1
Safety Instructions	1-4
Controls at a Glance	5-7
Surface Cooking	8-10
Surface Controls	8-9
Cooktop	10
Panel Light	10
Oven Operation	11-17
Oven Controls	11
Oven Vent @ Light	12
Baking Chart	12
Oven Racks	13
Broiling	14
Clock Controlled	
Oven Cooking	15
Drying (select models)	16-17
Care and Cleaning	18-22
Self-Clean Oven	18-19
Cleaning Chart	20-22
Cleaning Products	22
Maintenance	23-24
Before You Call for Service	25-26
Warranty	27



1 For Future Assistance

Congratulations on your choice of a Jenn-Air gas range. Your complete satisfaction is very important to us.

Read this user's guide carefully. It is intended to help you operate and maintain your new range.

In addition, you will find a booklet entitled "*Cooking Made Simple*." It contains information on selecting cookware and provides baking, roasting and broiling tips.

Save time and money. Check the "Before You Call" section of this guide. It lists causes of minor operating problems that you can correct yourself.

However, should you need service, it is helpful to have the model and serial numbers available. This information can be found on the data plate located on the storage drawer frame.

These numbers are also on the Product Registration card that came with your appliance. Before sending in this card, record these numbers along with the purchase date below.

Model Number -----
Serial Number -----
Date of Purchase _____

IMPORTANT: *Keep this guide and the sales receipt in a safe place for future reference. Proof of original purchase date is needed for warranty service.*

If you have questions, write us (include your model number and phone number) or call:

Jenn-Air Customer Service
Attn: CAIRSM Center
P.O. Box 2370
Cleveland, TN 37320-2370
1-800-688-1100 (USA and CANADA)
1-800-688-2080 (U.S. TTY for deaf, hearing impaired or speech impaired)
(Mon. - Fri., 8 am-8 pm Eastern Time)
Internet: <http://www.jennair.com>

For service information, see page 26.

NOTE: *In our continuing effort to improve the quality and performance of our cooking products, it may be necessary to make changes to the appliance without revising this guide.*

IMPORTANT SAFETY INSTRUCTIONS

Read and follow all instructions before using this appliance to prevent the potential risk of fire, electric shock, personal injury or damage to the appliance as a result of improper usage of the appliance.

WARNING: If the information in this manual is not followed exactly, a fire or explosion may result causing property damage, personal injury or death.

- **Do not store or use gasoline or other flammable vapors and liquids in the vicinity of this or any appliance.**
- **WHAT TO DO IF YOU SMELL GAS:**
 - **Do not try to light any appliance.**
 - **Do not touch any electrical switch**
 - **Do not use any phone in your building.**
 - **Immediately call your gas supplier from a neighbor's phone. Follow the gas supplier's instructions.**
 - **If you cannot reach your gas supplier, call the fire department.**
- **Installation and service must be performed by a qualified installer, service agency or the gas supplier.**

To ensure proper and safe operation: Appliance must be properly installed and grounded by a qualified installer. Have the installer show you the location of the gas shut off valve and how to shut it off in an emergency.

Always disconnect power to appliance before servicing.

To ensure proper operation and avoid possible injury or damage to unit do not attempt to adjust, repair, service, or replace any part of your appliance unless it is specifically recommended in this guide. All other servicing should be referred to a qualified servicer.

Important Safety Instructions 2

General Instructions

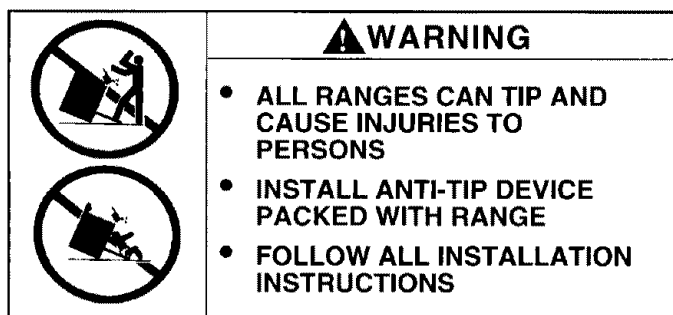

WARNING: To reduce risk of tipping of the appliance from abnormal usage or by excessive loading of the oven door, the appliance must be secure by a properly installed anti-tip device.

To check if device is properly installed, remove storage drawer and look underneath range to make sure one of the rear leveling legs is properly engaged in the bracket slot. The anti-tip device secures the rear leveling leg to the floor when properly engaged. You should check this **anytime** the range has been moved.

To Prevent Fire or Smoke Damage

Be sure all packing materials are removed from the appliance before operating it.

Keep area around appliance clear and free from combustible materials, gasoline, and other flammable vapors and materials.

If appliance is installed near a window, proper precautions should be taken to prevent curtains from blowing over burners.

NEVER leave any items on the cooktop. The hot air from the vent may ignite flammable items and may increase pressure in closed containers which may cause them to burst.

Many aerosol-type spray cans are **EXPLOSIVE** when exposed to heat and may be highly flammable. Avoid their use or storage near an appliance.

Many plastics are vulnerable to heat. Keep plastics away from parts of the appliance that may become warm or hot. Do not leave plastic items on the cooktop as they may melt or soften if left too close to the vent or a lighted surface burner.

To eliminate the hazard of reaching over hot surface burners, cabinet storage should not be provided directly above a unit. If storage is provided, it should be limited to items which are used infrequently and which are safely stored in an area subjected to heat from an appliance. Temperatures may be unsafe for some items, such as volatile liquids, cleaners or aerosol sprays.

In Case of Fire

Turn off appliance and ventilating hood to avoid spreading the flame. Extinguish flame then turn on hood to remove smoke and odor.



Use dry chemical or foam-type extinguisher or baking soda to smother fire or flame. Never use water on a grease fire.

If fire is in the oven or broiler pan, smother by closing oven door.

If fire is in a pan on the surface burner, cover pan. Never attempt to pick up or move a flaming pan.

Child Safety

NEVER leave children alone or unsupervised near the appliance when it is in use or is still hot. **NEVER** allow children to sit or stand on any part of the appliance.

Children must be taught that the appliance and utensils in it can be hot. Let hot utensils cool in a safe place, out of reach of small children. Children should be taught that an appliance is not a toy. Children should not be allowed to play with controls or other parts of the unit.

CAUTION: NEVER store items of interest to children in cabinets above an appliance or on backguard of a range. Children climbing on the appliance door to reach items could be seriously injured.

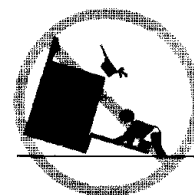

3 Safety Instructions

About Your Appliance

NEVER use appliance as a space heater to heat or warm a room to prevent potential hazard to the user and damage to the appliance. Also, do not use the cooktop or oven as a storage area for food or cooking utensils.

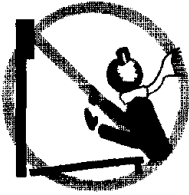

Do not obstruct the flow of combustion and ventilation air by blocking the oven vent or air intakes. Restriction of air flow to the burner prevents proper performance and increases carbon monoxide emission to unsafe levels.

Avoid touching oven vent area while oven is on and for several minutes after oven is turned off. Some parts of the vent and surrounding area become hot enough to cause burns. After oven is turned off, do not touch the oven vent or surrounding areas until they have had sufficient time to cool.

WARNING: NEVER use appliance door, or drawer, if equipped, as a step stool or seat as this may result in possible tipping of the appliance, damage to the appliance, and serious injuries.



Do not touch a hot oven light bulb with a damp cloth as the bulb could break. Should the bulb break, disconnect power to the appliance before removing bulb to avoid electrical shock.

Cooking Safety

Always place a pan on a surface burner before turning it on. Be sure you know which knob controls which surface burner. Make sure the correct burner is turned on and that the burner has ignited. When cooking is completed, turn burner off before removing pan to prevent exposure to burner flame.

Always adjust surface burner flame so that it does not extend beyond the bottom edge of the pan. An excessive flame is hazardous, wastes energy and may damage the appliance, pan or cabinets above the appliance.

NEVER leave a surface cooking operation unattended especially when using a high heat setting or when deep fat frying. Boilovers cause smoking and greasy spillovers may ignite. Clean up greasy spills as soon as possible. Do not use high heat for extended cooking operations.

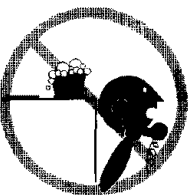

NEVER heat an unopened container on the surface burner or in the oven. Pressure build-up may cause container to burst resulting in serious personal injury or damage to the appliance.

Use dry, sturdy pot holders. Damp pot holders may cause burns from steam. Dishtowels or other substitutes should never be used as pot holders because they can trail across hot surface burners and ignite or get caught on appliance parts.

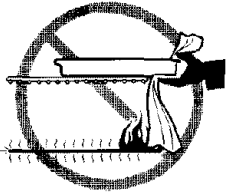

Always let quantities of hot fat used for deep fat frying cool before attempting to move or handle.

Do not let cooking grease or other flammable materials accumulate in or near the appliance, hood or vent fan. Clean hood frequently to prevent grease from accumulating on hood or filter. When flaming foods under the hood turn the fan on.

NEVER wear garments made of flammable material or loose fitting or long-sleeved apparel while cooking. Clothing may ignite or catch utensil handles.



Always place oven racks in the desired positions while oven is cool. Slide oven rack out to add or remove food, using dry, sturdy pot holders. Always avoid reaching into the oven to add or remove food. If a rack must be moved while hot, use a dry pot holder. Always turn the oven off at the end of cooking.

Use care when opening the oven door. Let hot air or steam escape before moving or replacing food.



PREPARED FOOD WARNING: Follow food manufacturer's instructions. If a plastic frozen food container and/or its cover distorts, warps, or is otherwise damaged during cooking, immediately discard the food and its container. The food could be contaminated.

Utensil Safety

Use pans with flat bottoms and handles that are easily grasped and stay cool. Avoid using unstable, warped, easily tipped or loose-handled pans. Also avoid using pans, especially small pans, with heavy handles as they could be unstable and easily tip. Pans that are heavy to move when filled with food may also be hazardous.

Safety Instructions 4

Be sure utensil is large enough to properly contain food and avoid boilovers. Pan size is particularly important in deep fat frying. Be sure pan will accommodate the volume of food that is to be added as well as the bubble action of fat.

To minimize burns, ignition of flammable materials and spillage due to unintentional contact with the utensil, do not extend handles over adjacent surface burners. Always turn pan handles toward the side or back of the appliance, not out into the room where they are easily hit or reached by small children.



Never let a pan boil dry as this could damage the utensil and the appliance.

Follow the manufacturer's directions when using oven cooking bags.

Only certain types of glass, glass/ceramic, ceramic or glazed utensils are suitable for cooktop or oven usage without breaking due to the sudden change in temperature.

This appliance has been tested for safe performance using conventional cookware. Do not use any devices or accessories that are not specifically recommended in this guide. Do not use eyelid covers for the surface units, stovetop grills, or add-on oven convection systems. The use of devices or accessories that are not expressly recommended in this manual can create serious safety hazards, result in performance problems, and reduce the life of the components of the appliance.

Cleaning Safety

Turn off all controls and wait for appliance parts to cool before touching or cleaning them. Do not touch the burner grates or surrounding areas until they have had sufficient time to cool.

Clean appliance with caution. Use care to avoid steam burns if a wet sponge or cloth is used to wipe spills on a hot surface. Some cleaners can produce noxious fumes if applied to a hot surface.

Self-Clean Oven

Clean only parts listed in this guide. Do not clean door gasket. The door gasket is essential for a good seal. Care should be taken not to rub, damage, or move the gasket. Do not use oven cleaners of any kind in or around any part of the self-clean oven.

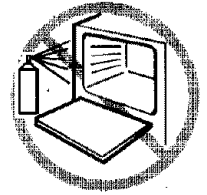

Before self-cleaning the oven, remove broiler pan, oven racks and other utensils and wipe up excessive spillovers to prevent excessive smoke or flare-ups. **CAUTION:** Do not leave food or cooking utensils, etc. in the oven during the self-clean cycle.

It is normal for the cooktop of the range to become hot during a self-clean cycle. Therefore, touching the cooktop during a clean cycle should be avoided.

Important Safety Notice and Warning

The California Safe Drinking Water and Toxic Enforcement Act of 1986 (Proposition 65) requires the Governor of California to publish a list of substances known to the State of California to cause cancer or reproductive harm, and requires businesses to warn customers of potential exposures to such substances.

Users of this appliance are hereby warned that the burning of gas can result in low-level exposure to some of the listed substances, including benzene, formaldehyde and soot, due primarily to the incomplete combustion of natural gas or liquid petroleum (LP) fuels. Properly adjusted burners will minimize incomplete combustion. Exposure to these substances can also be minimized by properly venting the burners to the outdoors.

SAVE THESE INSTRUCTIONS FOR FUTURE REFERENCE

5 Controls at a Glance

The control panel is designed for ease in programming. The display window on the electronic control shows time of day, timer and oven functions. Indicator words flash to prompt your programming steps.

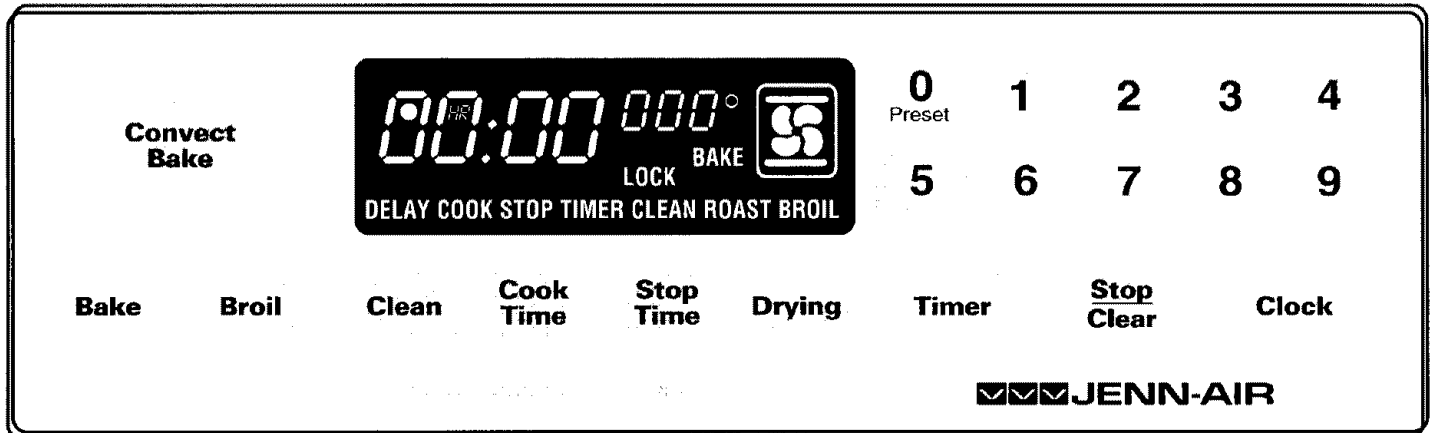

NOTE: Styling and features may differ slightly depending on the model. Control panel shown includes convection bake and drying functions.

Function Pads

- ◆ Press the desired pad.
- ◆ Press the appropriate number pads to enter time or temperature.
- ◆ A beep will sound when any pad is touched.
- ◆ A double beep will sound if a programming error occurs.

NOTE: Four seconds after entering the number, the time or temperature will automatically be entered. *If more than 30 seconds elapse between touching a function pad and the number pads, the function will be cancelled and the display will return to the previous display.*

Number Pads

Use to set time or temperature.

Stop/Clear

Use to cancel all programming except Clock and Timer functions.

Bake

Use for conventional baking or roasting.

1. Press **Bake** pad.
2. Press **Preset (0)** pad for 350°F or the appropriate number pads for desired temperature.

See page 11 for additional information.

Broil

Use for top browning and broiling.

1. Press **Broil** pad.
2. Press **Preset (0)** pad for HI broil, press again for LO broil, or press the appropriate number pads to set desired broil temperature.

See page 14 for additional information.

Clean

Use to set self-clean cycle.

1. Press **Clean** pad.
2. Press **Preset (0)** pad for “3:00” hours of cleaning time.
3. If more or less cleaning is desired, press the appropriate number pads. Cleaning time may be set between 2 and 4 hours.

See page 18-19 for additional information.

Convect Bake (select models)

Use for convection baking or roasting.

1. Press **Convect Bake** pad.
2. Press **Preset (0)** pad for 325°F or the appropriate number pads for desired temperature.

See page 11 for additional information.

Stop Time/Cook Time

Use to program the oven to start and stop automatically.

1. Press **Bake** or **Convect Bake** pad. Press the appropriate number pads for desired temperature.
2. Press **Cook Time** pad. Press the appropriate number pads to enter cooking time in hours and minutes.
3. To delay the start of cooking, press **Stop Time** pad. Press the appropriate number pads to enter the time you want the oven to stop.

See page 15-16 for additional information.

Drying (select models)

Use to dry or dehydrate foods such as fruits, vegetables and herbs.

1. Press **Drying** pad.
2. Press **Preset (0)** pad for 140°F or the appropriate number pads for the drying temperature desired.

See page 16-17 for additional information.

Setting the Clock

1. Press **Clock** pad.
 - ◆ The indicator word **TIME** will flash in the display.
2. Press the appropriate number pads until the correct time of day appears in the display.

When electrical power is supplied or after a power interruption, the last clock time, before power was interrupted, will flash.

To recall the time of day when another time function is showing, press the **Clock** pad.

Clock time cannot be changed when the oven has been programmed for clock controlled cooking, self-clean or delayed self-clean.

Setting the Timer

Use to set and then signal the completion of a time period up to 99 hours and 59 minutes.

The timer can be used independently of any other oven activity and can be set while another oven function is operating. *The timer does not control the oven.*

1. Press **Timer** pad.
 - ◆ The indicator word **TIMER** will flash and “0Hr:00” appears in the display.
2. Press the appropriate number pads until the desired number of minutes or hours and minutes appear in the display.

Example: To set the Timer for 5 minutes, press the **Timer** pad and the number 5 pad. The control will begin countdown after a four second delay.



Example: To set the Timer for 1 hour and 30 minutes, press the **Timer** pad and the numbers 1,3,0 pads. The control will begin countdown after a four second delay.



3. The last minute of the countdown will be displayed as seconds.
4. At the end of the time set, the timer will beep and “End” will appear in the display. To change the number of timer beeps and add reminder beeps, see page 7.

To cancel:

1. Press and hold **Timer** pad for three seconds. The time of day will reappear.

OR

2. Press the **Timer** pad and the “0” number pad. After a slight delay the time of day will reappear.

NOTE: Pressing **Stop/Clear** pad to cancel the timer will cancel ALL selected oven functions except the timer.

7 Controls at a Glance

Control Options

Control Lockout Option

The control touchpads can be locked to prevent unwanted use. They will not function when locked.

If an oven function is currently being used, the controls cannot be locked.

The current time of day will remain in the display when this feature is activated.

Setting Control Lockout

1. Press and hold the **Stop Time** and the **Stop/Clear** pads at the same time for three seconds.

◆ The indicator word OFF will appear in the display for 15 seconds. OFF will reappear for 15 seconds if any pad is pressed.

To Cancel: Press and hold the **Stop Time** and the **Stop/Clear** pads at the same time for three seconds. The indicator word OFF will disappear in the display.

Timer Beep Options

◆ **Option 1:** One long beep at the end of the timer operation, then, one short beep every 30 seconds for the next five minutes or until the **Stop/Clear** pad is pressed.

◆ **Option 2:** One long beep at the end of the timer operation, then, one short beep every minute for the next 12 hours or until the **Stop/Clear** pad is pressed.

◆ **Option 3 (default option):** One beep at the end of the timer operation, then, no other beeps.

Setting the Timer Beeps

1. Press the **Timer** and **Stop/Clear** pads at the same time and hold for three seconds.

◆ A single beep will sound.

◆ Display will show the indicator word TIMER and the current option.

2. Press the appropriate number pad (1, 2, or 3) to select the option you wish. The current time of day will reappear in the display after four seconds.

Clock Controlled Oven Cooking Beep Options

◆ **Option 1 (default option):** Four beeps at the end of cooking, then, one beep every 30 seconds for the next five minutes or until the **Stop/Clear** pad is pressed.

◆ **Option 2:** Four beeps at the end of cooking, then, one beep every minute for the next 12 hours or until the **Stop/Clear** pad is pressed.

◆ **Option 3:** Four beeps at the end of cooking, then, no other beeps.

Setting Clock Controlled Oven Cooking Beeps

1. Press **Cook Time** and **Stop/Clear** pads at the same time and hold for three seconds.

◆ A single beep will sound.

◆ Display will show the indicator word COOK and the current option.

2. Press the appropriate number pad (1, 2, or 3) to select the option you wish. The current time of day will reappear in the display after four seconds.

Cancel Clock Display Option

If you prefer that the time of day not be displayed:

1. Press **Clock** and **Stop/Clear** pads at the same time and hold for three seconds.

2. Press **Clock** pad to briefly recall the time of day, if desired.

To restore: Press the **Clock** and **Stop/Clear** pads at the same time and hold for three seconds. The time of day will reappear in the display.

Surface Controls

Automatic Oven Turn Off Option

The oven will automatically turn off after 12 hours, if you accidentally leave it on. You can deactivate this feature, if desired.

To Eliminate 12 Hour Turn Off

1. Press the **Clock** pad and hold for three seconds or until "12" appears in the display. The indicator word TIME will flash in the display.
2. Press any number pad until 8888 appears in the display. Current time of day will reappear in the display after four seconds.

To restore: Press the **Clock** pad and hold for three seconds or until 8888 appears. Press "1" number pad. "12" will appear briefly in the display followed by the current time of day.

Oven Temperature Adjustment Option

If you think the oven should be hotter or cooler, you can adjust it yourself. To decide how much to change the thermostat, set the oven temperature 25°F higher or lower than the temperature in your recipe, then bake. The results of the "test" should give you an idea of how much to adjust the thermostat.

To adjust the thermostat:

1. Press the **Bake** pad.
2. Enter 550° by pressing the number pads "5, 5, 0".
3. Press and hold the **Bake** pad for several seconds until 0° appears in the display.
4. Press any number pad to change the temperature. Each time a pad is pressed, the temperature changes by 5°F.
 - ◆ Press repeatedly to reach +35°F. Continue pressing to reduce the temperature up to -35°F.
5. When you have made the adjustment, press the **Stop/Clear** pad and the time of day will reappear in the display. The oven will now bake at the adjusted temperature.

It is not necessary to readjust the oven temperature if there is a power interruption. This adjustment will not affect broil or clean temperatures.

CAUTIONS:

- ◆ If flame should go out during a cooking operation, turn the burner off. If a strong gas odor is detected, open a window and wait five minutes before relighting the burner.
- ◆ Be sure all surface controls are set in the OFF position prior to supplying gas to the range.

Pilotless Ignition

Pilotless ignition eliminates the need for a constant standing pilot light. Each surface burner has a spark ignitor. When cleaning around the surface burner use care. If cleaning cloth should catch the ignitor, it could damage it preventing ignition.

If the surface burner does not light, check if ignitor is broken, soiled or wet. If clogged, clean the small port beneath the ignitor using straight pin.

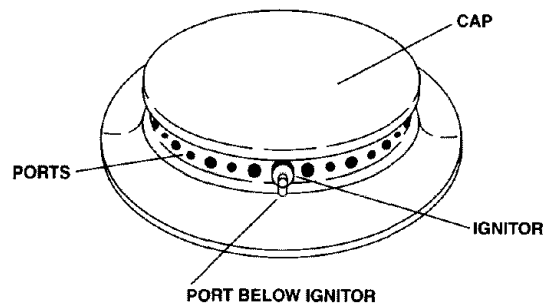

Surface Control Knobs

Use to turn on the surface burners. An infinite choice of heat settings is available from **Lo** to **Hi**. At the **Hi** setting a detent or notch may be felt. The knobs can be set on or between any of the settings.

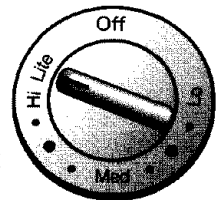

Graphics to the left of the knob identify which burner the knob controls. For example, the graphic below shows the right rear burner location.







9 Surface Cooking

Setting the Controls

- Place a pan on the burner grate.
 - The burner flame may lift off or appear separated from the port if a pan is not placed on the grate.
- Push in and turn the knob counterclockwise to the **Lite** setting.
 - A clicking (spark) sound will be heard and the burner will light. (All four ignitors will spark when any surface burner knob is turned to the **Lite** position.)
- After the burner lights, turn the knob to the desired flame size.
 - The ignitor will continue to spark until the knob is turned past the **Lite** position.

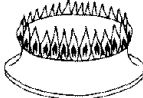
Suggested Heat Settings

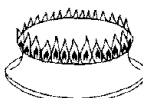
The size and type of cookware will affect the flame setting. For information on cookware and other factors affecting flame settings, refer to “Cooking Made Simple” booklet.

Setting	Uses		
Hi	Use to bring liquid to a boil, blanch, or reach pressure in a pressure cooker. Always reduce setting to a lower heat when liquids begin to boil or foods begin to cook.		
Med. Hi	Use to brown meat, saute or fry. Maintain fast boil for large amounts of liquids.		
Med.	Use to maintain moderate to slow boil for large amounts of liquids and for most frying operations.		
Med. Lo	Use to continue cooking covered foods and to maintain pressure in most pressure cookers and stew or steam operations.		
Lo	Use to keep foods warm and melt chocolate or butter.		

Notes . . .

- A properly adjusted burner with clean ports will light within a few seconds. If using natural gas the flame will be blue with a deeper blue inner cone.

If the burner flame is yellow or is noisy the air/gas mixture may be incorrect. Contact a service technician to adjust. (Adjustments are not covered by the warranty.)

With LP gas, some yellow tips on the flames are acceptable. This is normal and adjustment is not necessary.
- With some types of gas, you may hear a “popping” sound when the surface burner is turned off. This is a normal operating sound of the burner.
- If the control knob is turned very quickly from HI to LO, the flame may go out, particularly if the burner is cold. If this occurs, turn the knob to the OFF position, wait several seconds and relight the burner.

- Refer to page 24 to adjust the Lo setting, if needed.
- The flame should be adjusted so it does not extend beyond the edge of the pan.



Operating During a Power Failure

- Hold a lighted match to the desired surface burner head.
- Push in and turn the control knob slowly to **Lite**.
- Adjust the flame to the desired level.

CAUTION: When lighting the surface burners, be sure all of the controls are in the **OFF** position. Strike the match first and hold it in position before turning the knob to **Lite**.

Cooktop

To prevent the cooktop from discoloring or staining:

- ◆ Clean cooktop after each use.
- ◆ Wipe acid or sugar spills as soon as the cooktop has cooled as these spills may discolor or etch the porcelain.

The cooktop is designed with two contoured wells with removable porcelain covered drip pans to contain spills. (See page 20 for cleaning directions.)



Drip Pan

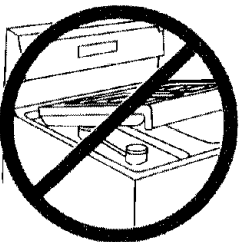

Unlike a range with standard gas burners, this cooktop does not lift-up nor is it removable. **Do not attempt to lift the cooktop for any reason.**

Burner Grates

The grates must be properly positioned before cooking. When installing the grates, place the tab ends toward the center, matching the straight bars. Improper installation of the grates may result in chipping of the cooktop.

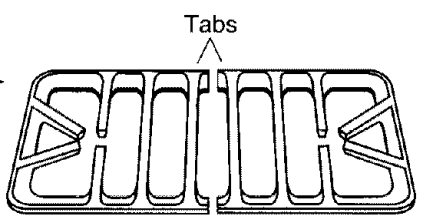

Do not operate the burners without a pan on the grate. The grate's porcelain finish may chip without a pan to absorb the heat from the burner flame.

Although the burner grates are durable, they will gradually lose their shine and/or discolor, due to the high temperatures of the gas flame.

Sealed Burners

The sealed burners of your range are secured to the cooktop and are not designed to be removed. Since the burners are sealed into the cooktop, boilovers or spills will not seep underneath the cooktop.

However, the burner caps should be cleaned after each use. The cap portion of the burner has a removable cover that is easily removed for cleaning. (See page 20 for cleaning directions.)

The burner will operate effectively with or without the burner cap cover.

High Performance Burners (12,000 BTU*)

There are two high speed burners on your range located in the left rear and right front positions. These offer higher speed cooking that can be used to quickly bring water to a boil and for large-quantity cooking.



* BTU ratings will vary when using LP gas.

Panel Light

The panel light is turned on by pushing the rocker switch on the control panel and holding it until the light comes on. It may be turned off by pushing the other side of the switch.

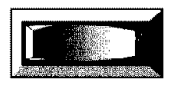

Panel

11 Oven Operation

Setting the Controls for Baking, Roasting and Convection Baking and Roasting*

* Convection cooking available on select models only.

1. Place oven racks on proper rack positions. (See page 13.)

2. Press **Bake** or **Convect Bake** pad.

- ◆ The indicator word **BAKE** will flash.
- ◆ 000 and the oven icon  will appear.



- ◆ When convection cooking is selected, a fan icon  will also appear.

3. Press the **Preset (0)** pad to set 350°F automatically. When convection cooking, 325°F will be automatically set when **Preset (0)** is pressed. Or press the appropriate number pads for the desired oven temperature.

- ◆ The temperature can be set from 100° to 550° F.
- ◆ After four seconds the oven will begin to heat.
 - the bake icon (top and bottom bars) will light;
 - a red preheat indicator will light;
 - and 100° or the actual oven temperature, whichever is higher, will appear in the display.
 - when convection cooking the fan icon will begin to rotate.



- ◆ The temperature in the display will increase in 5° increments until the oven reaches the preset temperature.
- ◆ When the oven is preheated, the oven will beep and the preheat indicator light will go off in the display. Allow 7–14 minutes for the oven to preheat.



4. At the end of cooking, turn the oven off by pressing the **Stop/Clear** pad. Remove food from oven. The oven will continue operating until the **Stop/Clear** pad is pressed.

Notes . . .

- ◆ If more than 30 seconds elapse between pressing a function pad and pressing a number pad, the display will return to the previous display.
- ◆ To recall the set temperature during preheat, press the appropriate **Bake** or **Convect Bake** pad. The set temperature will be displayed briefly and then return to the ongoing program.
- ◆ To change the oven temperature during cooking, press the appropriate **Bake** or **Convect Bake** pad and the appropriate number pads for the desired oven temperature.
- ◆ You may find that the cooking times and temperatures vary slightly from your old oven. This is normal. Every oven has its own characteristics.
- ◆ During some extended oven cooking operations, you may hear a “popping” sound when the oven burner cycles. This is normal.
- ◆ **As a general rule, when convection baking, set the oven temperature 25° F. lower than the conventional recipe or prepared mix directions. Baking time will be the same or a few minutes less than the directions. (See Baking Chart, page 12.)**
- ◆ **When convection roasting, roasting times are generally 25–30% less. (Maintain conventional roasting temperatures.)**
- ◆ The convection fan turns on five minutes after setting the controls. This is normal.
- ◆ See roasting chart in “**Cooking Made Simple**” booklet for recommended roasting temperature and times.
- ◆ For additional baking, roasting and convection cooking tips, see “**Cooking Made Simple**” booklet.

Convection Cooking of Convenience Foods (select models)

- ◆ Preheating the oven is **not** necessary.
- ◆ Follow package recommendations for oven temperature, foil covering and the use of cookie sheets. Cooking times will be similar. (See chart below for some exceptions.)
- ◆ Most foods are cooked on rack position #3.
- ◆ For multiple rack cooking with convection, use racks #2 and 4 or #1, 3 and 5. Pizzas should be placed on cookie sheets.

Cooking Chart for Convenience Foods			
		Convect Bake Oven Not Preheated	
Frozen Convenience Foods	Rack Position	Temp. °F	Minutes *
Fish Sticks	3	400°	13-18
French Fries	3	450°	15-25
Pizza	3	400°	13-18

* The times given are based on specific brands of foods. Actual times will depend on the ones you cook.

Oven Vent

When the oven is in use, never block the vent opening.

It is located at the base of the backguard. When the oven is in use, this area may feel warm or hot to the touch. Do not place plastics near the vent opening as heat from the vent could distort or melt the plastic.

Oven Light

The oven light automatically comes on whenever the oven door is opened. When the door is closed, press the rocker switch on the backguard labeled "Oven".

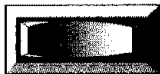

Oven

Baking Chart

Product & Type	Rack Position	Convection Bake (select models)		Conventional Bake	
		Preheated (°F)**	Min.*	Preheated (°F)	Min.*
Cake					
Layer - 9", 2 Pans	3	325°	20-25	350°	28-33
Sheet - 9x13"	3	325°	26-30	350°	30-40
Angel Food - Tube	2	350°	28-40	375°	30-42
Pie					
Two Crust, - 9" Fruit, Fresh	3	350°-400°	45-60	375°-425°	45-60
One Crust - 9" Custard, Fresh	1	325°-375°	35-45	350°-400°	45-60
Cookies					
Chocolate Chip	3	325°-350°	6-10	350°-375°	8-12
Sugar	3	325°-375°	4-8	350°-400°	7-11
Brownies - 9x13"	3	325°	20-26	350°	25-35
Breads - Yeast					
Loaf - 9x5"	2	350°	17-23	375°	20-30
Rolls	3	350°-375°	7-12	375°-400°	9-16
Breads - Quick					
Loaf - 8x4"	2	325°-350°	35-50	350°-375°	50-60
Biscuits	3	375°-400°	7-11	400°-425°	8-15
Muffins	3	350°-400°	15-20	375°-425°	15-25

* The times given are based on specific brands of mixes or recipes used. Actual times will depend on the ones you bake.

** The Convect Bake temperature is 25°F lower than recommended on package mix or recipe.

13 Oven Operation

Oven Racks

CAUTION: Do not attempt to change the rack position when the oven is hot.

The oven racks are designed with a lock-stop edge. Convection models have three racks. Conventional bake models have two racks.

To remove: Pull rack straight out until it stops at the lock-stop position; lift up on the front of the rack and pull out.

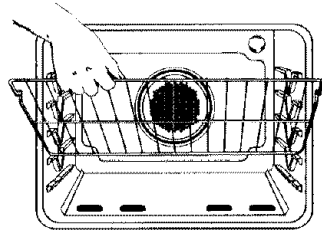

To replace: Place rack on the rack support in the oven; tilt the front end up slightly; slide rack back until it clears the lock-stop position; lower front and slide back into the oven.

Do not cover an entire rack with aluminum foil or place foil on the oven bottom. Baking results will be affected and damage may occur to the oven bottom.

Rack Positions

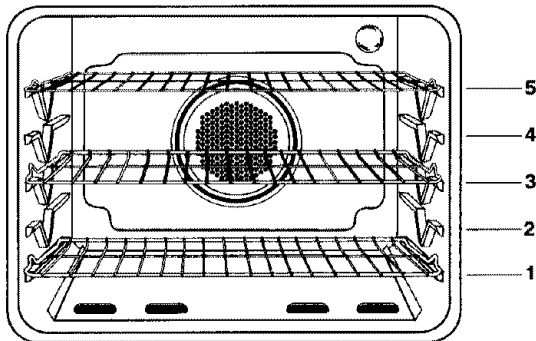

Three rack convection baking (select models).

RACK 5 (highest position):

Used for toasting bread or broiling thin, non-fatty foods.

RACK 4:

Used for most broiling.

RACK 3:

Used for most baked goods on a cookie sheet or jelly roll pan, layer cakes, fruit pies, or frozen convenience foods.

RACK 2:

Used for roasting small cuts of meat, casseroles, baking loaves of bread, bundt cakes or custard pies.

RACK 1:

Used for roasting large cuts of meat and poultry, frozen pies, dessert souffles or angel food cake.

MULTIPLE RACK COOKING:

Two rack (conventional or convection baking, select models): Use rack positions 2 and 4, or 1 and 4.

Three rack (convection baking, select models): Use rack positions 1, 3 and 5. (See illustration left column.)

Half Rack (select models)

To install in oven:

1. Always install half rack when oven is cool.
2. To install, grasp top center of the half rack. Align the side arm support between the top fourth and fifth oven rack guides. Insert the two tabs on the back frame of the half rack into the slots on the upper left rear of the oven wall.
3. Push firmly on the top surface of the half rack until the tabs slide into the slots and the half rack side arm support rests on the fourth oven rack guide.
4. Check for proper installation by placing your hand on the top surface of the half rack and pressing down firmly.

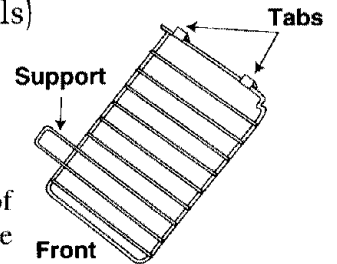

To remove from the oven:

When the oven is cool, grasp the top center of the half rack and pull upward until the back tabs on the rack slide out of the oven back slots.

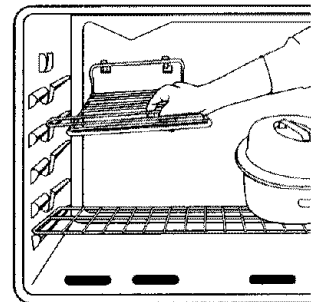

Notes . . .

- ◆ Do not use cookware that extends beyond edge of rack.
- ◆ For best results, allow two inches between the pan placed on the rack and the oven side wall.
- ◆ When opening the oven door, allow steam and hot air to escape before reaching into the oven to remove food.
- ◆ Use caution when removing items from the half rack to avoid burns.
- ◆ Carefully remove items from the lower rack to avoid disturbing the half rack.
- ◆ "HALFRACKIC" Accessory Kit available from your dealer when not included with range.

Broiling

Broil in the oven cavity. For best results, use a pan designed for broiling.

For additional broiling tips, refer to the "Cooking Made Simple" booklet.

Setting the Controls for Broiling

- Place the oven rack on the proper rack position. (See following chart.) **Close the oven door.**
- Press the **Broil** pad.

- The indicator word **BROIL** will flash. 000 and the oven icon  will appear.



- Press the **Preset (0)** pad to enter **HI** broil. Press again to set **LO** broil.
 - The oven has a variable broil feature which means a specific broil temperature can be selected. To select a specific temperature, press the appropriate number pads for the temperature desired after 000 appears in the display.
 - Four seconds after entering **HI**, **LO**, or a temperature, the broil icon will come on and the indicator word **BROIL** will remain in the display.

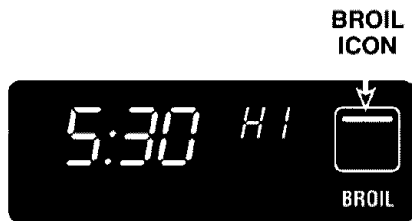

- Cook food according to the following broiling chart.
- Press the **Stop/Clear** pad to turn off oven when food is cooked.

Broiling Chart				
Foods	Rack Position	Broil Setting	Approx. (Min./Side)	
			1st Side	2nd Side
Beef				
Steak (1")				
Medium	4	HI	8-9	6-8
Well	3	HI	10-12	9-10
Hamburgers (4oz.)				
Well	4	HI	7-8	4-6
Pork				
Chops (1")	4	LO	11-12	10-12
Ham Slice (1/2")	4	HI	3-4	1-2
Poultry				
Breast Halves (Bone-in)	3	LO	16-18	9-10
Seafood				
Fish Steaks, Buttered (1")	4	LO	6-7	5-6

Note: This chart is a suggested guide. The times may vary with food being cooked.

Notes . . .

- If more than 30 seconds elapse between pressing the **Broil** pad and number pad, the oven is not set and the display will return to the previous display.
- HI** broil is used for most broiling. Use a lower broil temperature when broiling longer cooking foods or thin pieces of food. The lower temperature allows food to cook to the well done stage without excessive browning.

15 Oven Operation

Clock Controlled Oven Cooking

The clock controlled oven cooking feature is used to turn the oven off at a preset time of day or delay the start and then turn off the oven.

The clock must be functioning and set at the correct time of day for this feature to operate correctly.



The feature can be used with either oven cooking or self-cleaning. See page 19 for instructions on delaying the start of a clean cycle.

Notes . . .

- ◆ If more than 30 seconds elapse between pressing a function pad and pressing the appropriate number pads, the oven is NOT set and display will return to the previous display.
- ◆ Highly perishable foods such as dairy products, pork, poultry or seafood are not recommended for delayed cook operations.
- ◆ Clock controlled baking is not recommended for baked items that require a preheated oven, such as cakes, cookies, pies and breads.
- ◆ Cook time can be set for up to 11 hours and 59 minutes (11:59).

Setting the Controls

To Start Immediately and Turn Off Automatically:

1. Press the **Bake** or **Convect Bake*** pad.
 - ◆ The indicator word **BAKE** will flash.
 - ◆ 000 and the oven icon  will appear.
 - ◆ When convection cooking is selected, a fan icon  will also appear.
- * Convection cooking available on select models only.
2. Press the **Preset (0)** pad to set 350°F. (When convection cooking, 325°F will be automatically set.) Or press the appropriate number pads for the desired oven temperature.

3. Press the **Cook Time** pad. The indicator words **COOK TIME** will flash and the display will show "0HR:00".
4. Press appropriate number pads to enter cooking hours and minutes.

Example: If cooking time selected for baking is 2 hours and 30 minutes, the display will show:



5. At the end of the programmed Cook Time, the oven will shut off automatically, "End" will appear in the display and a beep will be heard four times. Press the **Stop/Clear** pad.

If the program is not cancelled, there will be one beep every 30 seconds for five minutes. (If you wish to change the beeps at the end of clock controlled cooking, see page 7.)

To Delay the Start and Turn Off Automatically:

- 1-4. Follow preceding steps 1-4.
5. Press the **Stop Time** pad. Indicator words **STOP** and **TIME** will flash. Display will show the calculated stop time based on the current time of day and the cook time that you entered previously.
6. Press the appropriate pads to enter the time you wish the oven to stop. A stop time can only be accepted for later in the day.

Example: If at 10:00 you set the oven for 350°F. and 2 hours and 30 minutes of cooking time, the calculated stop time would be "12:30".

If you want the stop time to be 1:00, press the number pads "1,0,0". Four seconds later, the display will show 1:00 along with the indicator words **DELAY**, **STOP TIME**.



7. At the end of the delayed period, the DELAY indicator word will go off and the oven will begin to heat.
8. At the end of the clock controlled Cook Time, the oven will shut off automatically, "End" will appear in the display and a beep will be heard four times. Press the **Stop/Clear** pad.

If the program is not cancelled, there will be one beep every 30 seconds for five minutes. (If you wish to change the beeps at the end of clock controlled cooking, see page 7.)

Drying (select models)

For best results, use the drying rack provided with your range. It allows air to circulate evenly around the food.

The convection fan will operate during the drying procedure.

Setting the Controls for Drying

1. Press the **Drying** pad.
 - ◆ 000, the oven icon and convection fan icon  will appear.
2. Press the **Preset (0)** pad for 140°F. or press the appropriate number pads for the desired drying temperature.
 - ◆ The temperature may be set between 100°-200°F.
 - ◆ If the temperature is set for under 100°F or over 200°F, the control will beep twice and default to 100°F or 200°F respectively.
3. The oven door needs to be opened slightly to allow moisture to escape from the oven during the drying process.
 - ◆ Open the oven door slightly.
 - ◆ Rotate the metal spacer at the upper right corner of the oven frame upward to hold the door in position.
 - ◆ While holding the spacer up, gently close the oven door until it rests against the spacer.
 - ◆ **Follow the drying guide on page 17 for drying times.** Cool foods to room temperature before testing for doneness.

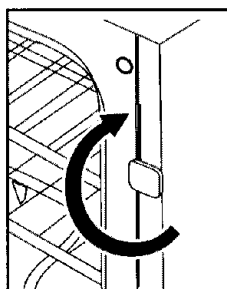

- ◆ When the door is opened, the spacer will rotate downward and rest flush against the range side panel. Reset the spacer if you need to continue the drying process.
4. When drying is complete, turn the oven off by pressing the **Stop/Clear** pad.

Notes . . .

- ◆ If more than 30 seconds elapse between pressing the **Drying** pad and number pad, the oven is not set and the display will return to the previous display.
- ◆ Most fruits and vegetables dry well and retain their color when dried at 140°F. For optimal flavor, dry herbs at 100°F, however, at this lower temperature expect extended drying times of up to 8 hours.
- ◆ The length of drying times vary due to the following: water and sugar content of food, size of food pieces, amount of food being dried, humidity in the air.
- ◆ Check foods at the minimum drying time. Dry longer if necessary.
- ◆ Fruits that turn brown when exposed to air should be treated with an antioxidant. Try one of the following methods:
 1. Dip fruit in a mixture of two parts bottled lemon juice to one part cool water.
 2. Soak fruit in a solution of 1 tsp. ascorbic acid or commercial antioxidant to 1 quart of cold water.
- ◆ Foods may drip during the drying process. After drying high acid or sugary foods, clean the oven bottom with soap and water. The porcelain oven finish may discolor if acid or sugary food soils are not wiped up prior to high heat or a self-cleaning cycle.
- ◆ More than one rack of food may be dried at the same time. However, additional drying time is needed.
- ◆ To clean the drying rack, wash in sink with warm, soapy water. Rinse and dry completely. Do not use abrasive cleaning agents.

If the rack is washed in a dishwasher, use heated dry cycle to insure complete drying.
- ◆ To purchase additional drying racks, contact your Jenn-Air dealer for the "DRYINGRACK" Accessory Kit.
- ◆ Refer to other resources at your local library or call your local County Extension service for additional information.

17 Oven Operation

Drying Guide

Fruits	Varieties Best for Drying	Preparation	Approx. Drying Time at 140°F **	Test for Doneness
Apples*	Firm Varieties: Graven Stein, Granny Smith, Jonathan, Winesap, Rome Beauty, Newton.	Wash, peel if desired, core and slice into 1/8" slices.	4-8 hours	Pliable to crisp. Dried apples store best when they are slightly crisp.
Apricots*	Blenheim/Royal most common. Tilton also good.	Wash, halve, and remove pits.	18-24 hours	Soft, pliable.
Bananas*	Firm Varieties	Peel and cut into 1/4" slices.	17-24 hours.	Pliable to crisp.
Cherries	Lambert, Royal Ann, Napoleon, Van or Bing.	Wash and remove stems. Halve and remove pits.	18-24 hours.	Pliable and leathery.
Nectarines and Peaches*	Freestone Varieties.	Halve and remove pits. Peeling is optional but results in better-looking dried fruit.	24-36 hours	Pliable and leathery.
Pears*	Bartlett	Peel, halve and core.	24-36 hours	Soft and pliable.
Pineapple	Fresh or canned.	Wash, peel and remove thorny eyes. Slice length wise and remove the small core. Cut crosswise into 1/2" slices.	Canned: 14-18 hours Fresh: 12-16 hours	Soft and pliable.
Orange and Lemon Peel	Select rough-skinned fruit. Do not dry the peel of fruit marked "color added".	Wash well. Thinly peel the outer 1/16 to 1/8" of the peel. Do not use the white bitter pith under the peel.	1-2 hours	Tough to brittle.
Vegetables				
Tomatoes	Plum, Roma	Halve, remove seeds. Place tomatoes skin side up on rack. Prick skins.	12-18 hours	Tough to crisp.
Carrots	Danvers Half Long, Emperor, Red Cored Chantenay	Do not use carrots with woody fiber or pithy core. Wash, trim tops and peel if desired. Slice crosswise or diagonally in 1/4" slices. Steam blanch for 3 min.	4-8 hours	Tough to brittle.
Hot Peppers	Ancho, Anaheim	Wash, halve and seed. Prick skin several times.	4-6 hours	Pods should appear shriveled, dark red and crisp.
Herbs				
Parsley, Mint, Cilantro, Sage, Oregano		Rinse in cold water. Leave stems on until leaves are dry, then discard.	1-3 hours	Brittle and crumbly.
Basil		Cut leaves 3 to 4" from top of plant just as buds appear. Rinse leaves in cold water.	2-5 hours	Brittle and crumbly.

* Fruits requiring an antioxidant to prevent discoloration and loss of nutrients. Refer to the notes on page 16 for specific methods.

**Automatic Oven Turn Off will not occur during drying functions.

Self-Clean Oven

Self-Clean CAUTIONS:

- ◆ It is normal for parts of the range to become hot during a clean cycle.
- ◆ Avoid touching cooktop, door, window, or oven vent area during a clean cycle.
- ◆ To prevent damage to oven door, do not attempt to open the door when the LOCK indicator word is displayed.
- ◆ *Do not use commercial oven cleaners on the self-clean oven finish or around any part of the oven as they will damage the finish or parts.*

The self-clean cycle uses above normal cooking temperatures to automatically clean the entire oven interior.

It is normal for flare-ups, smoking or flaming to occur during cleaning if the oven is heavily soiled.

It is better to clean the oven regularly rather than to wait until there is a heavy build-up of soil in the oven.

During the cleaning process, the kitchen should be well ventilated to help eliminate normal odors associated with cleaning.

Before Self-Cleaning

Turn off the oven light before cleaning as the light may burn out during the clean cycle.

Remove broiler pan, all pans and the oven racks from the oven. *The oven racks will discolor and may not slide easily after a self-clean cycle.*

Clean oven frame, door frame (area outside the door gasket) and around the opening in the door gasket with a nonabrasive cleaning agent such as Bon Ami or detergent and water. These areas are not exposed to cleaning temperatures and should be cleaned to prevent soil from baking on during the clean cycle.

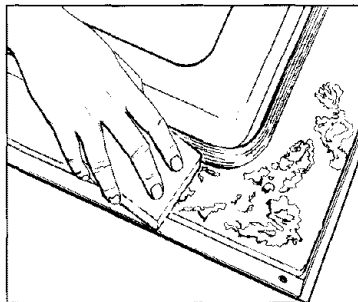

To prevent damage, do not clean or rub the gasket around the oven door. The gasket is designed to seal in heat during the clean cycle.

Wipe up excess grease or spillovers from the oven bottom to prevent excessive smoking, flare-ups or flaming during the clean cycle.

Wipe up sugary and acid spillovers such as sweet potatoes, tomato or milk-based sauces. Porcelain enamel is acid resistant, not acid proof. *The porcelain finish may discolor if acid spills are not wiped up prior to a self-clean cycle.*

Setting the Controls for a Self-Clean Cycle

1. Close the oven door.
2. Press the Clean pad.
 - ◆ The indicator word CLEAN will flash. The display will show "-- : --" along with the oven icon .
 - ◆ If the door has not been closed, the display will show "door".
3. Press **Preset (0)** pad for "3:00" hours of cleaning time for an average soiled oven.
 - ◆ The cleaning time can be varied depending on the amount of soil. Press the appropriate number pads to set any amount of time between 2 and 4 hours. "2:00" hours of cleaning for light soil, up to "4:00" hours of cleaning for heavy soil.
 - ◆ Four seconds after entering the cleaning time, the oven door will automatically lock. The indicator word LOCK will appear in the display along with the clean icon (top and bottom bars).



4. When the cleaning time has been completed, the indicator word CLEAN will turn off. The indicator word LOCK will remain on until the oven has cooled. When the oven has cooled, the indicator word LOCK will turn off and the door will automatically unlock.



**Automatic lock is still engaged.
Door cannot be opened until
LOCK is no longer displayed.**

19 Care and Cleaning

After Self-Cleaning

About one hour after the end of the clean cycle, the lock will disengage and the LOCK indicator word will turn off. At this point, the door can be opened.

Some soil may leave a light gray, powdery ash which can be removed with a damp cloth. If soil remains, it indicates that the clean cycle was not long enough. The soil will be removed during the next clean cycle.

If the oven racks were left in the oven and do not slide smoothly after a clean cycle, wipe racks and embossed rack supports with a small amount of vegetable oil to restore ease of movement.

A white discoloration may appear after cleaning if acid or sugary foods were not wiped up before the clean cycle. This discoloration is normal and will NOT affect performance.

To Delay the Start of a Clean Cycle

1-3. Follow steps 1-3 on page 18.

4. Press the **Stop Time** pad. Indicator words STOP TIME will flash in the display and the calculated stop time will also appear in the display.

5. Press the appropriate number pads to enter the stop time you desire. (A stop time can only be accepted for later in the day.)

Example: If at 9:00 you set the oven to clean for three hours, the calculated stop time would be "12:00". The display will show:



If you want the stop time to be 1:00, press the number pads "1,0,0". Four seconds later the display will show 1:00 and the indicator word DELAY.



6. When the oven begins to clean, the clean icon (top and bottom bars) will come on. The indicator word DELAY will go off.

7. When the clean time has been completed, the indicator word CLEAN will turn off. The indicator word LOCK will remain on until the oven has cooled. When the oven has cooled, the indicator word LOCK will turn off and the door will automatically unlock.

To Cancel Self-Clean

1. Press the **Stop/Clear** pad. The door will be locked while the LOCK indicator word remains in the display.

Depending on the length of time the oven had been cleaning, it may take up to an hour for the oven to cool down. When the oven is cool, the door will automatically unlock and it can be opened.

Notes . . .

- ◆ Clean oven regularly rather than allowing soil to build up.
- ◆ Do not use oven cleaners in, on, or around any part of the range as they will damage the finish or parts.
- ◆ If the oven door is left open, "door" will flash in the display and a signal will beep until the door is closed and the **Clean** pad is pressed again.
- ◆ The first few times the oven is cleaned, some smoke and odor may be detected. This is normal and will lessen or disappear with use. If the oven is heavily soiled, or if the broiler pan was accidentally left in the oven, excessive smoke and odor may occur.
- ◆ As the oven heats and cools, you may hear sounds of metal parts expanding and contracting. This is normal and will not damage your appliance.
- ◆ Fine lines may appear in the porcelain resulting from the heating and cooling of the finish. This is normal and will not affect performance.

▲ Cleaning CAUTIONS:

- ◆ Be sure appliance is off and all parts are cool before handling or cleaning. This is to avoid damage and possible burns.
- ◆ To prevent staining or discoloration, clean appliance after each use.
- ◆ If a part is removed, be sure it is correctly replaced.

Cleaning Chart

Parts	Cleaning Procedure
Broiler Pan and Insert	<p><i>Never cover insert with aluminum foil as this prevents the fat from draining to the pan below.</i></p> <ul style="list-style-type: none"> ◆ Place soapy cloth over insert and pan; let soak to loosen soil. ◆ Wash in warm soapy water. Use soap filled scouring pad to remove stubborn soil. ◆ Broiler pan and insert can be cleaned in dishwasher.
Burner Caps and Sealed Gas Burners	<ul style="list-style-type: none"> ◆ Allow burner to cool. Remove burner cap and wash in soapy water with a plastic scouring pad or in the dishwasher. For stubborn soils, clean with a soap-filled, nonabrasive pad or Cooktop Cleaning Creme (Part #20000001) and a sponge. ◆ For burned on soil, place burner cap on newspapers and spray with commercial oven cleaner. Follow manufacturer's directions. ◆ Clean gas ports with a straight pin especially the port below the ignitor. Do not enlarge or distort holes. ◆ Be careful not to get water into burner ports. ◆ When cleaning, use care to prevent damage to the ignitor. If the ignitor is soiled, wet or damaged the surface burner will not light.
Burner Grates (porcelain on cast iron)	<ul style="list-style-type: none"> ◆ Wash grates with warm, soapy water and a nonabrasive, plastic scrubbing pad. ◆ For stubborn soils, clean with a soap-filled, nonabrasive pad or Cooktop Cleaning Creme (Part #20000001) and a sponge. If soil remains, reapply Cooktop Cleaning Creme, cover with a damp paper towel and soak for 30 minutes. Scrub again, rinse and dry. ◆ For burned on soils, remove grates, place on newspapers and carefully spray with commercial oven cleaner. (Do not spray surrounding surfaces.) Place in plastic bags for several hours or overnight. Wearing rubber gloves, remove from bags. Wash, rinse, dry and replace on cooktop.
Clock and Control Pad Area	<ul style="list-style-type: none"> ◆ To activate "Control Lockout" for cleaning, see page 7. ◆ Wipe with a damp cloth and dry. ◆ Glass cleaners may be used if sprayed on a cloth first. DO NOT spray directly on control pad and display area.
Control Knobs	<ul style="list-style-type: none"> ◆ Remove knobs in the OFF position by pulling forward. ◆ Wash, rinse and dry. Do not use abrasive cleaning agents as they may scratch the finish. ◆ Turn on each element to be sure the knobs have been correctly replaced.
Cooktop & Backguard, porcelain enamel	<p>Porcelain enamel is glass fused on metal and may crack or chip with misuse. It is acid resistant, not acid proof. All spillovers, especially acid or sugar spillovers, should be wiped up immediately with a dry cloth.</p> <ul style="list-style-type: none"> ◆ When cool, wash with soapy water, rinse and dry. ◆ Never wipe off a warm or hot surface with a damp cloth. This may cause cracking or chipping. ◆ Never use oven cleaners, abrasive or caustic cleaning agents on exterior finish of range.

21 Care and Cleaning

Cleaning Chart -- continued

Parts	Cleaning Procedure
Drip Pans, porcelain	<p>Porcelain may discolor or craze if overheated. This is normal and will not affect cooking performance.</p> <ul style="list-style-type: none"> ◆ When cool, wash after each use, rinse and dry to prevent staining or discoloration. May be washed in the dishwasher. ◆ To clean heavy soil, soak in hot sudsy water, then use mild abrasive cleaner such as Soft Scrub and a plastic scouring pad. ◆ For burned on soil, remove from range, place on newspapers and carefully spray with commercial oven cleaner. (<i>Do not spray surrounding surfaces.</i>) Place in plastic bag and allow to soak several hours. Wearing rubber gloves, remove from bag, wash, rinse and dry.
Enamel, painted - Side panels - Storage drawer or lower panel	<ul style="list-style-type: none"> ◆ When cool, wash with warm soapy water, rinse and dry. Never wipe a warm or hot surface with a damp cloth as this may damage the surface and may cause a steam burn. ◆ For stubborn soil, use mildly abrasive cleaning agents such as baking soda paste or Bon Ami. Do not use abrasive, caustic or harsh cleaning agents such as steel wool pads or oven cleaners. These products will scratch or permanently damage the surface. <p><i>NOTE: Use dry towel or cloth to wipe up spills, especially acid or sugary spills. Surface may discolor or dull if soil is not immediately removed. This is especially important for white surfaces.</i></p>
Glass - Oven window - Oven door	<ul style="list-style-type: none"> ◆ Avoid using excessive amounts of water which may seep under or behind glass. ◆ Wash with soap and water or glass cleaner. Remove stubborn soil with a nonabrasive cleaner such as Bon Ami and water. Rinse with clear water and dry. ◆ Do not use abrasive materials such as scouring pads, steel wool or powdered cleaning agents. They will damage glass.
Metal Finishes - Trim parts	<ul style="list-style-type: none"> ◆ Wash with soap and water, a glass cleaner, or mild liquid sprays. ◆ To prevent scratching or dulling of the finish, do not use mildly abrasive, abrasive, harsh or caustic cleaners such as oven cleaners.
Oven Interior	<ul style="list-style-type: none"> ◆ Follow instructions on pages 18-19 for Self-Cleaning Oven.
Oven Racks	<ul style="list-style-type: none"> ◆ Clean with soapy water. ◆ Remove stubborn soil with cleansing powder or soap-filled scouring pad. Rinse and dry. <p>Racks will permanently discolor and may not slide smoothly if left in the oven during a self-clean operation. If this occurs, wipe the rack and embossed rack supports with a small amount of vegetable oil to restore ease of movement, then wipe off excess oil.</p>
Plastic Finishes - Door handles - Backguard trim - End caps	<ul style="list-style-type: none"> ◆ When cool, clean with soap and water, rinse and dry. ◆ Use a glass cleaner and a soft cloth. <p><i>NOTE: Never use oven cleaners, abrasive or caustic liquid or powdered cleansers on plastic finishes. These cleaning agents will scratch or mar finish.</i></p> <p><i>NOTE: To prevent staining or discoloration, wipe up fat, grease or acid (tomato, lemon, vinegar, milk, fruit juice, marinade) immediately with a dry paper towel or cloth.</i></p>

Cleaning Chart -- continued

Parts	Cleaning Procedure
Stainless Steel (select models)	<ul style="list-style-type: none"> ◆ DO NOT USE ANY CLEANING PRODUCT CONTAINING CHLORINE BLEACH. ◆ ALWAYS WIPE WITH THE GRAIN WHEN CLEANING. ◆ Daily Cleaning/Light Soil — wipe with one of the following - soapy water, white vinegar/water solution, Formula 409 Glass and Surface Cleaner or a similar multi-surface cleaner - using a sponge or soft cloth. Rinse and dry. To polish and help prevent fingerprints, follow with Stainless Steel Magic Spray (Jenn-Air Model A912, Part No. 20000008). ◆ Moderate/Heavy Soil — wipe with one of the following - Bon Ami, Smart Cleanser, or Soft Scrub - using a damp sponge or soft cloth. Rinse and dry. Stubborn soils may be removed with a damp Scotch-Brite pad; rub evenly with the grain. Rinse and Dry. To restore luster and remove streaks, follow with Stainless Steel Magic Spray (Jenn-Air Model A912, Part No. 20000008). ◆ Discoloration: using a damp sponge or soft cloth, wipe with Cameo Stainless Steel Cleaner. Rinse immediately and dry. To remove streaks and restore luster, follow with Stainless Steel Magic Spray (Jenn-Air Model A912, Part No. 20000008).

Cleaning Products

Because of the many new cleaning products introduced in the marketplace each year, it is not possible to list all products that can be safely used to clean this appliance. Listed below are just a few examples of recommended products.

ALWAYS READ THE MANUFACTURER'S INSTRUCTIONS to be sure the cleaner can be safely used on this appliance.

To determine if a cleaning product is safe, test a small inconspicuous area using a very light pressure to see if the surface may scratch or discolor. This is particularly important for porcelain enamel, highly polished, shiny, painted, or plastic surfaces.

The following brands may help you to make an appropriate selection:

- ◆ **Glass Cleaners** - Cinch, Glass Plus, Windex.
- ◆ **Dishwashing Liquid Detergents** - Dawn, Ivory, Joy.
- ◆ **Mild Liquid Spray Cleaners** - Fantastik, Formula 409.

- ◆ **Multi-Surface Cleaners** - Formula 409 Glass & Surface, Windex Glass & Surface.

- ◆ **Nonabrasive Cleaners** - Bon Ami, paste of baking soda and water.

- ◆ **Mildly Abrasive Powder or Liquid Cleaners** - Ajax, Barkeepers Friend, Cameo, Soft Scrub, Smart Cleanser. (Note: If the cleaner is recommended for use on plastic, glass, or porcelain finishes, it can be used on the same type of appliance finish.)

- ◆ **Nonabrasive or Scratchless Plastic or Nylon Scouring Pads or Sponges** - Chore Boy Plastic Cleaning Puff, Scrungo Scrub Sponges, Scotch-Brite No Scratch Pads.

- ◆ **Abrasive Scouring Pads** - S.O.S., Brillo Steel Wool Soap, Scotch-Brite Wool Soap Pads.

(Brand names for the above cleaning products are registered trademarks of the respective manufacturers.)

23 Maintenance

Maintenance

Oven Door

CAUTIONS:

- ◆ Do not place excessive weight on or stand on an open oven door. This could cause the range to tip over, break the door, or injure the user.
- ◆ Do not attempt to open or close door or operate oven until door is properly replaced.
- ◆ Never place fingers between hinge and front oven frame. Hinge arms are spring mounted. If accidentally hit, the hinge will slam shut against oven frame and could injure your fingers.

To remove:

1. When cool, open the oven door to the first stop position (opened about four inches).
2. Grasp door at each side. Do not use the door handle to lift door.
3. Lift up evenly until door clears hinge arms.

To replace:

1. Grasp door at each side.
2. Align slots in the door with the hinge arms on the range.
3. Slide the door down onto the hinge arms until the door is completely seated on the hinges. Push down on the top corners of the door to completely seat door on hinges. Door should not appear crooked.

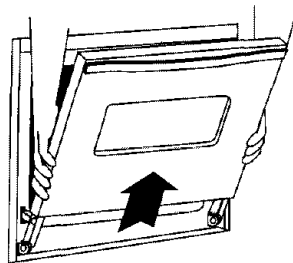

NOTE: The oven door on a new range may feel “spongy” when it is closed. This is normal and will decrease with use.

Panel Light

To replace panel light bulb:

Grasp the top trim of the back panel with your thumbs under the front edge and pull outward while lifting the trim. Remove the bulb and replace it with an 18 watt fluorescent tube. Snap the top trim back into place and restore the power. Reset the clock.

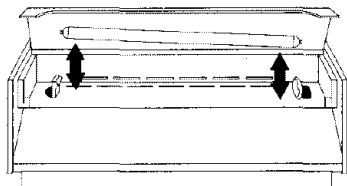

Oven Light

CAUTIONS:

- ◆ Disconnect power to range before replacing light bulb.
- ◆ Use a dry pot holder to prevent possible harm to hands when replacing bulb.
- ◆ Be sure bulb is cool before touching bulb.
- ◆ Do not touch hot bulb with a damp cloth as this may cause the bulb to break.

To replace oven light bulb:

1. When oven is cool, hold bulb cover in place, then slide wire retainer off cover.
2. Remove bulb cover and light bulb.
3. Replace with a 40 watt appliance bulb.
4. Replace bulb cover and secure with wire retainer.
5. Reconnect power to range. Reset clock.

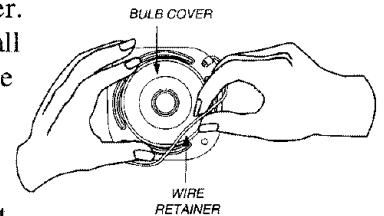

Storage Drawer

CAUTION:

- ◆ Do not store plastic, paper products, food or flammable materials in this drawer. The drawer may become too warm for these items when the oven is in use.

The storage drawer can be removed to allow you to clean under the range.

To remove:

1. Empty drawer and pull out to the first stop position.
2. Lift up the front of the drawer.
3. Pull out to the second stop position.
4. Grasp sides and lift drawer up and out.

To replace:

1. Fit the ends of the drawer glides into the rails in the range.
2. Lift up front of drawer and gently push in to the first stop position.
3. Lift drawer up again and push until drawer is closed.

Leveling Legs

CAUTION:

- ◆ Be sure the anti-tip bracket secures one of the rear leveling legs to the floor. This bracket prevents the range from accidentally tipping.

The range should be leveled when installed. If the range is not level, turn the plastic leveling legs, located at each corner of the range, until range is level.

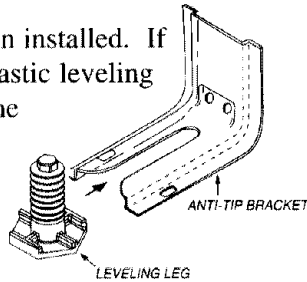

Oven Bottom

Protect oven bottom against spillovers, especially acid or sugary spills, as they may discolor the porcelain enamel. Use the correct pan size to avoid spillovers and boilovers. **Do not place aluminum foil directly on the oven bottom.**

The oven bottom on a conventional bake range may be removed for easier cleaning. **NOTE:** The oven bottom on convection models is not removable.

To remove: When cool, remove the oven racks. Slide the two catches, located at each rear corner of the oven bottom, toward the front of the oven.

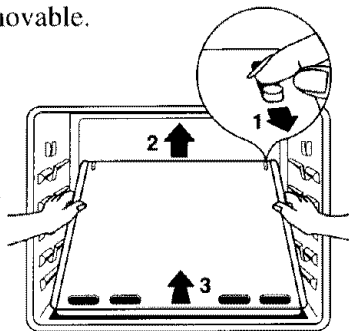

Lift the rear edge of the oven bottom slightly, then slide it back until the front edge of the oven bottom clears the oven front frame. Remove oven bottom from oven.

To replace: Fit the front edge of the oven bottom into the oven front frame. Lower the rear of the oven bottom and slide the two catches back to lock the oven bottom in place.

Electrical Connection

Appliances which require electrical power are equipped with a three-prong grounding plug which must be plugged directly into a properly grounded three-hole 120 volt electrical outlet.

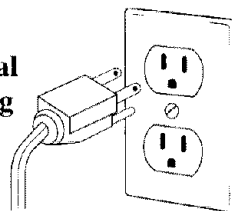

Always disconnect power to appliance before servicing.

The three-prong grounding plug offers protection against shock hazards. **DO NOT CUT OR REMOVE THE THIRD GROUNDING PRONG FROM THE POWER CORD PLUG.**

If an ungrounded, two-hole or other type electrical outlet is encountered, it is the personal responsibility of the appliance owner to have the outlet replaced with a properly grounded three-hole electrical outlet.

How to Remove Range for Cleaning and Servicing

Follow these procedures to remove appliance for cleaning or servicing:

1. Shut off gas supply to appliance.
2. Disconnect electrical supply to appliance, if equipped.
3. Disconnect gas supply tubing to appliance.
4. Slide range forward to disengage range from the anti-tip bracket. (See Installation Instructions for location of bracket.)
5. Reverse procedure to reinstall. If gas line has been disconnected, check for gas leaks after reconnection. **NOTE:** A qualified servicer should disconnect and reconnect the gas supply.
6. To prevent range from accidentally tipping, range must be secured to the floor by sliding rear leveling leg into the anti-tip bracket.

Proportional Valve Adjustment for Surface Burners

The Lo setting should produce a stable flame when turning the knob from Hi to Lo. The flame should be 1/8 inch or lower and must be stable on all ports on Lo setting.

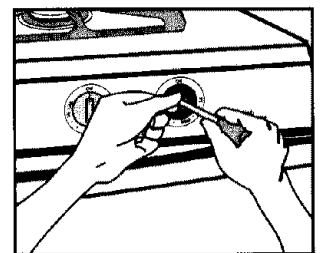

To adjust: Operate burner on Hi for about five minutes to preheat burner cap. Turn knob back to Lo; remove knob, and insert a small screwdriver into the center of the valve stem. Adjust the flame size by turning adjustment screw in either direction, while holding the stem.

Flame must be of sufficient size to be stable on all burner ports. If flame adjustment is needed, adjust **ONLY** on the Lo setting. Never adjust flame size on a higher setting.

NOTE: All gas adjustments should be done by a qualified servicer only.

25 Before You Call For Service

Check the following list to be sure a service call is necessary.

Part or all of the appliance does not work.

- ◆ Check to be sure plug is securely inserted into receptacle.
- ◆ Check or re-set circuit breaker. Check or replace fuse.
- ◆ Check power supply.
- ◆ Check if surface and/or oven controls have been properly set. See pages 8 and 11.
- ◆ Check if oven door is unlocked after a self-clean cycle. See pages 18-19.
- ◆ Check if oven is set for a delayed cook or clean program. See page 15.

Surface burner fails to light.

- ◆ Check to be sure unit is properly connected to power supply.
- ◆ Check for a blown circuit fuse or a tripped main circuit breaker.
- ◆ Check to be sure burner ports or ignition ports are not clogged. See page 8.
- ◆ Check to be sure igniter is dry and clicking. Burner will not light if igniter is damaged, soiled or wet. If ignitor doesn't click, turn control knob OFF.

The flame is uneven.

- ◆ Burner ports may be clogged.
- ◆ Flame setting may need to be adjusted.

Surface burner flame lifts off ports.

- ◆ Check to be sure a pan is sitting on the grate above.

Baking results are not what you expected.

- ◆ Check the oven temperature selected. Make sure oven is preheated when recipe or directions recommend preheat.
- ◆ Check rack positions. See page 13.
- ◆ Use correct pan. Dark pans produce dark browning. Shiny pans produce light browning. See **“Cooking Made Simple”** booklet for more information on bakeware.
- ◆ Check the use of foil in the oven. Never use foil to cover an entire oven rack. Place a small piece of foil on the rack below the pan to catch spillovers.
- ◆ Check pan placement. Stagger pans when using two racks. Allow 1–2 inches between pans and oven walls.
- ◆ Make sure the oven vent has not been blocked. See page 12 for location.
- ◆ Check to make sure range is level.

Baking results differ from previous oven.

- ◆ Temperatures often vary between a new oven and an old one. As ovens age, the oven temperature often “drifts” and may become hotter or cooler. See page 8 for instructions on adjusting the oven temperature.

NOTE: It is not recommended to adjust the temperature if only one or two recipes are in question.

Food not broiling properly.

- ◆ Check oven setting. See page 14.
- ◆ Check oven rack positions. See page 14.
- ◆ Aluminum foil was incorrectly used. Never line the broiler pan insert with foil.

Oven smokes excessively during broiling.

- ◆ Food too close to flame. See page 14 for more information.
- ◆ Broiler insert covered with aluminum foil.
- ◆ Excess fat not trimmed from meat prior to broiling.
- ◆ A soiled broiler pan was used.

Oven will not self-clean.

- ◆ Check to make sure controls are set properly.
- ◆ Check to make sure the cycle is not set for a delayed start.
- ◆ Check if door is closed.

Oven did not clean properly.

- ◆ Longer cleaning time may be needed.
- ◆ Excessive spillovers, especially sugary and or acid foods, were not removed prior to the self-clean cycle.

Oven door will not open after self-clean cycle.

- ◆ Oven interior is still hot. Allow about one hour for the oven to cool after the completion of a self-clean cycle. The door can be opened when the LOCK indicator word is not displayed.

Moisture condensation on oven window.

- ◆ This is normal when cooking food high in moisture.
- ◆ Excessive moisture was used when cleaning the window.

Strong odor or light smoke when oven is turned on.

- ◆ This is normal for a new range and will disappear after a few uses. Initiating a clean cycle will "burn off" the smells more quickly.
- ◆ Turning on a ventilation fan will help remove the smoke and/or odor.
- ◆ Excessive food soils on the oven bottom. Use a self-clean cycle.

"F" plus a number appears in display.

- ◆ This is called a fault code. If a fault code appears in the display and beeps sound, press the **Stop/Clear** pad. If the fault code and beeps continue, disconnect power to the appliance and call an authorized servicer.

If You Need Service:

- ◆ Call the dealer from whom your appliance was purchased or call Maytag Appliances Sales Company, Jenn-Air Customer Assistance at 1-800-688-1100, USA and Ontario, or 1-423-472-3333 to locate an authorized service company.
- ◆ Be sure to retain proof of purchase to verify warranty status. Refer to WARRANTY (next page) for further information of owner's responsibilities for warranty service.
- ◆ If the dealer or service company cannot resolve the problem, write to Maytag Appliances Sales Company, Attn: CAIR Center, P.O. Box 2370, Cleveland, TN 37320-2370, or call 1-800-688-1100 or 1-423-472-3333.

U.S. customers using TTY for deaf, hearing impaired or speech impaired, call 1-800-688-2080.

NOTE: When writing or calling about a service problem, please include the following information:

- Your name, address and telephone number;
- Model number and serial number;
- Name and address of your dealer or servicer;
- A clear description of the problem you are having;
- Proof of purchase (sales receipt).

- ◆ User's guides, service manuals and parts catalogs are available from Maytag Appliances Sales Company, Jenn-Air Customer Assistance.

27 Warranty

Full One Year Warranty - Parts and Labor

For **one (1) year** from the original retail purchase date, any part which fails in normal home use will be repaired or replaced free of charge.

Limited Warranties - Parts Only

Second Year - After the first year from the original purchase date, parts which fail in normal home use will be repaired or replaced free of charge for the part itself, with the owner paying all other costs, including labor, mileage and transportation.

Third Through Fifth Year - From the original purchase date, parts listed below which fail in normal home use will be repaired or replaced free of charge for the part itself, with the owner paying all other costs, including labor, mileage and transportation.

- **Electronic Controls**
- **Glass-ceramic Cooktop:** due to thermal breakage.
- **Electric Heating Elements:** surface, broil and bake elements on electric cooking appliances.

Third Through Tenth Year - From the original purchase date, parts listed below which fail in normal home use will be repaired or replaced free of charge for the part itself, with the owner paying all other costs, including labor, mileage and transportation.

- **Sealed Gas Burners**

Canadian Residents

The above warranties only cover an appliance installed in Canada that has been certified or listed by appropriate test agencies for compliance to a National Standard of Canada unless the appliance was brought into Canada due to transfer of residence from the United States to Canada.

Limited Warranty Outside the United States and Canada - Parts Only

For two (2) years from the date of original retail purchase, any part which fails in normal home use will be repaired or replaced free of charge for the part itself, with the owner paying all other costs, including labor, mileage and transportation.

*The specific warranties expressed above are the **ONLY** warranties provided by the manufacturer. These warranties give you specific legal rights, and you may also have other rights which vary from state to state.*

What is Not Covered By These Warranties:

1. Conditions and damages resulting from any of the following:
 - a. Improper installation, delivery, or maintenance.
 - b. Any repair, modification, alteration, or adjustment not authorized by the manufacturer or an authorized servicer.
 - c. Misuse, abuse, accidents, or unreasonable use.
 - d. Incorrect electric current, voltage, or supply.
 - e. Improper setting of any control.
2. Warranties are void if the original serial numbers have been removed, altered, or cannot be readily determined.
3. Light bulbs.
4. Products purchased for commercial or industrial use.
5. The cost of service or service call to:
 - a. Correct installation errors.
 - b. Instruct the user on the proper use of the product.
 - c. Transport the appliance to the servicer.
6. Consequential or incidental damages sustained by any person as a result of any breach of these warranties.

Some states do not allow the exclusion or limitation of consequential or incidental damages, so the above exclusion may not apply.



403 WEST FOURTH STREET NORTH • PO BOX 39 • NEWTON, IA 50208