

PLASMA TELEVISION

Operating Guide for 42HDF52

IMPORTANT SAFETY INSTRUCTIONS 1-6
FIRST TIME USE 7-23
THE REMOTE CONTROL 24-27
ON-SCREEN DISPLAY..... 28-34
DTV USE 35-39
USEFUL INFORMATION 40-49

As an ENERGY STAR® Partner, Hitachi, Ltd. has determined that this product meets the ENERGY STAR® guidelines for energy efficiency.









IMPORTANT SAFETY INSTRUCTIONS

SAFETY POINTS YOU SHOULD KNOW ABOUT YOUR HITACHI PLASMA TELEVISION

Our reputation has been built on the quality, performance, and ease of service of HITACHI Plasma Televisions. Safety is also foremost in our minds in the design of these units. To help you operate these products properly, this section illustrates safety tips which will be of benefit to you. Please read it carefully and apply the knowledge you obtain from it to the proper operation of your HITACHI Plasma Television.

Please fill out your warranty card and mail it to HITACHI. This will enable HITACHI to notify you promptly in the improbable event that a safety problem should be discovered in your product model.

Follow all warnings and instructions marked on this plasma television.

 <div style="border: 1px solid black; padding: 5px; text-align: center;"> CAUTION RISK OF ELECTRIC SHOCK DO NOT OPEN </div>  <p>WARNING: TO REDUCE THE RISK OF FIRE OR ELECTRIC SHOCK, DO NOT EXPOSE THIS APPARATUS TO RAIN OR MOISTURE. CAUTION: NO USER SERVICEABLE PARTS INSIDE. REFER SERVICING TO QUALIFIED SERVICE PERSONNEL.</p>	 <p>The lightning flash with arrowhead symbol, within an equilateral triangle, is intended to alert the user to the presence of uninsulated "dangerous voltage" within the product's enclosure that may be of a sufficient magnitude to constitute a risk of electric shock to persons.</p>  <p>The exclamation point within an equilateral triangle, is intended to alert the user to the presence of important operating and maintenance (servicing) instructions in the literature accompanying the appliance.</p>
------------------------------------------------------------------------------------------------------------------------------------------------------------------------------------------------------------------------------------------------------------------------------------------------------------------------------------------------------------------------------------------------------------------------------------------------------------------------------------------------------------------------------------------------------------------	-----------------------------------------------------------------------------------------------------------------------------------------------------------------------------------------------------------------------------------------------------------------------------------------------------------------------------------------------------------------------------------------------------------------------------------------------------------------------------------------------------------------------------------------------------------------------------------------------------------------------------------------------------------------------------------------

WARNING:

- TO PREVENT FIRE OR SHOCK HAZARD, DO NOT EXPOSE THIS PLASMA TELEVISION TO RAIN OR MOISTURE.
- THE PLASMA TELEVISION SHOULD NOT BE EXPOSED TO DRIPPING OR SPLASHING AND OBJECTS FILLED WITH LIQUIDS, SUCH AS VASES, SHOULD NOT BE PLACED ON THE TELEVISION.

NOTE: • Model and serial numbers are indicated on back side of the Plasma Television.

CAUTION: Adjust only those controls that are covered in the instructions, as improper changes or modifications not expressly approved by HITACHI could void the user's authority to operate the Plasma Television.



MODIFICATIONS: The FCC requires the user to be notified that any changes or modifications made to this device that are not expressly approved by Hitachi America, Ltd. Home Electronics Division may void the user's authority to operate the equipment.

POWER SOURCE
 THIS PLASMA TELEVISION IS DESIGNED TO OPERATE ON 120 VOLTS 60Hz, AC CURRENT. INSERT THE PLASMA TELEVISION POWER CORD INTO A 120 VOLT 60Hz OUTLET.

TO PREVENT ELECTRIC SHOCK, DO NOT USE THE PLASMA TELEVISION'S (POLARIZED) PLUG WITH AN EXTENSION CORD, RECEPTACLE, OR OTHER OUTLET UNLESS THE BLADES AND GROUND TERMINAL CAN BE FULLY INSERTED TO PREVENT BLADE EXPOSURE.

NEVER CONNECT THE PLASMA TELEVISION TO 50Hz, DIRECT CURRENT, OR ANYTHING OTHER THAN THE SPECIFIED VOLTAGE.

Apparatus shall not be exposed to dripping or splashing and no objects filled with liquids, such as vases, shall be placed on the apparatus.

NOTE: This Plasma Television will display television closed captioning, ( or ), in accordance with paragraph 15.119 of the FCC rules.

 **CAUTION:** Never remove the back cover of the Plasma Television as this can expose you to very high voltages and other hazards. If the television does not operate properly, unplug the Plasma Television and call your authorized dealer or service center.

English

IMPORTANT SAFETY INSTRUCTIONS



Read before operating equipment

Follow all warnings and instructions marked on this television.

1. Read these instructions.
2. Keep these instructions.
3. Heed all warnings.
4. Follow all instructions.
5. Do not use this apparatus near water.
6. Clean only with a dry cloth.
7. Do not block any ventilation openings. Install in accordance with the manufacturer's instructions.
8. Do not install near any heat sources such as radiators, heat registers, stoves, or other apparatus (including amplifiers) that produce heat.
9. Do not defeat the safety purpose of the polarized or grounding-type plug. A polarized plug has two blades with one wider than the other. A grounding type plug has two blades and a third grounding prong. The wide blade or the third prong are provided for your safety. If the provided plug does not fit into your outlet, consult an electrician for replacement of the obsolete outlet.
10. Protect the power cord from being walked on or pinched particularly at plugs, convenience receptacles, and the point where they exit from the apparatus.
11. Only use the attachments/accessories specified by the manufacturer.

12.  Use only with the cart, stand, tripod, bracket, or table specified by the manufacturer, or sold with the apparatus. When a cart is used, use caution when moving the cart/apparatus combination to avoid injury from tip-over.

13. Unplug this apparatus during lightning storms or when unused for long periods of time.
14. Refer all servicing to qualified service personnel. Servicing is required when the apparatus has been damaged in any way, such as power-supply cord or plug is damaged, liquid has been spilled or objects have fallen into apparatus, the apparatus has been exposed to rain or moisture, does not operate normally, or has been dropped.

15. Televisions are designed to comply with the recommended safety standards for tilt and stability.

Do not apply excessive pulling force to the front, or top, of the cabinet which could cause the product to overturn resulting in product damage and/or personal injury.

16. Follow instructions for wall, shelf or ceiling mounting as recommended by the manufacturer.
17. An outdoor antenna should not be located in the vicinity of overhead power lines or other electrical circuits.
18. If an outside antenna is connected to the receiver be sure the antenna system is grounded so as to provide some protection against voltage surges and built up static charges. Section 810 of the National Electric Code, ANSI/NFPA No. 70-1984, provides information with respect to proper grounding for the mast and supporting structure, grounding of the lead-in wire to an antenna discharge unit, size of grounding connectors, location of antenna-discharge unit, connection to grounding electrodes and requirements for the grounding electrode.

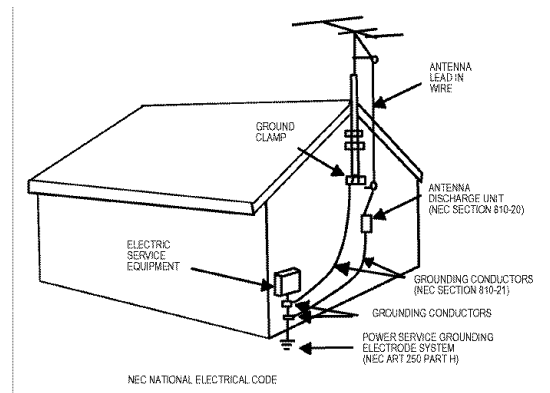

Note to the CATV system installer: This reminder is provided to call the CATV system installer's attention to Article 820-40 of the NEC that provides guidelines for proper grounding and, in particular, specifies that the cable ground shall be connected to the grounding system of the building, as close to the point of cable entry as practical.

This product contains lead. Dispose of this product in accordance with applicable environmental laws. For product recycling and disposal information, contact your local government agency or the Electronic Industries Alliance at www.eiae.org (in the US) or the Electronic Product Stewardship Canada at www.epsc.ca (in Canada). For more information, call "1-800-HITACHI."

Do not place any objects on the top of the television which may fall or cause a child to climb to retrieve the objects.

PREVENTION OF SCREEN BURN

Continuous on-screen displays such as video games, stock market quotations, computer generated graphics, and other fixed (nonmoving) patterns can cause permanent damage to television receivers. Such "SCREEN BURNS" constitute misuse and are **NOT COVERED** by your HITACHI Factory Warranty.

PUBLIC VIEWING OF COPYRIGHTED MATERIAL

Public viewing of programs broadcast by TV stations and cable companies, as well as programs from other sources, may require prior authorization from the broadcaster or owner of the video program material.

- This digital television is capable of receiving analog basic, digital basic and digital premium cable television programming by direct connection to a cable system providing such programming. A CableCARD provided by your cable operator is required to view encrypted digital programming. Certain advanced and interactive digital cable services such as video-on-demand, a cable operator's enhanced program guide and data-enhanced television services may require the use of a set-top box. For more information call your local cable company.
- This product incorporates copyright protection technology that is protected by U.S. patents and other intellectual property rights. Use of this copyright protection technology must be authorized by Macrovision Corporation, and is intended for home and other limited consumer uses only unless otherwise authorized by Macrovision. Reverse engineering or disassembly is prohibited.

SAFETY INSTRUCTIONS

This PDP TV has been designed and manufactured to meet international safety standards, but like any electrical equipment, care must be taken if you are to obtain the best results and safety is to be assured.

Before using this product, please read and understand the Safety Instructions thoroughly to ensure correct usage, and follow all the instructions.

About the Symbols

Various symbols are used in this manual, the user's manual and on the product itself to ensure correct usage, to prevent danger to the user and others, and to prevent property damage. The meanings of these symbols are described below. It is important that you read these descriptions thoroughly and fully understand the contents.



This symbol indicates information that, if ignored, could possibly result in personal injury or even death due to incorrect handling.



This symbol indicates information that, if ignored, could result possibly in personal injury or physical damage due to incorrect handling.

Typical Symbols



This symbol indicates an additional warning (including cautions). An illustration is provided to clarify the contents.



This symbol indicates a prohibited action. The contents will be clearly indicated in an illustration or nearby (the symbol to the left indicates that disassembly is prohibited).



This symbol indicates a compulsory action. The contents will be clearly indicated in an illustration or nearby (the symbol to the left indicates that the power plug should be disconnected from the power outlet).

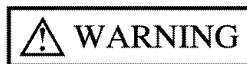

Never use the Plasma Television if a problem should occur.

Abnormal operations such as smoke, strange odor, no image, no sound, excessive sound, damaged casing, elements, cables, penetration of liquids or foreign matter, etc. can cause a fire or electrical shock.

In such case, immediately turn off the power switch and then disconnect the power plug from the power outlet. After making sure that the smoke or odor has stopped, contact your dealer. Never attempt to make repairs yourself because this could be dangerous.



Disconnect the plug from the power outlet.

Do not insert liquids or foreign objects.

Penetration of liquids or foreign objects could result in fire or electrical shock. Use special caution in households where children are present. If liquids or foreign objects should enter the projector, immediately turn off the power switch, disconnect the power plug from the power outlet and contact your dealer.

- Do not place the PDP TV in a bathroom.
- Do not expose the PDP TV to rain or moisture.
- Do not place flower vases, pots, cups, cosmetics, liquids such as water, etc on or around the PDP TV.
- Do not place metals, combustibles, etc on or around the PDP TV.



Do not disassemble.

Never disassemble or modify the Plasma Television.

The PDP TV contains high voltage components. Modification could result in fire or electrical shock.

- Never remove any fixed cover.

Do not give the Plasma Television any shock or impact.

If the PDP TV should be shocked and/or broken, it could result in an injury, and continued use could result in fire or electrical shock.

If the glass panel is broken or damaged, immediately turn off the power switch, disconnect the power plug from the power outlet and contact your dealer.



Do not place the Plasma Television on an unstable surface.

If the PDP TV should be dropped and/or broken, it could result in an injury, and continued use could result in fire or electrical shock.

- Do not place the monitor on an unstable, slant or vibrant surface such as a wobbly or inclined stand.

Do not obstruct the ventilation of the Plasma Television.

If the ventilation is obstructed during the operation of the monitor or just after switching off the power, it could result in damage and shorten the lifespan of your PDP TV due to overheating. Make sure there is ample ventilation.

- Keep a space of 100mm (10cm) or more between the sides, rear and top of the PDP TV and other objects such as walls.
- Do not place anything around ventilation openings of the PDP TV.
- Never block ventilation openings.
- Do not put the plasma screen side up.
- Do not cover the PDP TV with a tablecloth, etc.
- Do not place the PDP TV on a carpet or bedding, or near a curtain.



Use only the correct power outlet.

Incorrect power supply could result in fire or electrical shock. Use only the correct power outlet depending on the indication on the PDP TV and the safety standard.

- The enclosed power cord must be used depending on the power outlet to be used.



SAFETY INSTRUCTIONS(continued)



Be cautious of the power cord connection.

Incorrect connection of the power cord could result in fire or electrical shock.

- Do not touch the power cord with a wet hand.
- Check that the connecting portion of the power cord is clean (with no dust), before using. Use a soft and dry cloth to clean the power plug.
- Insert the power plug into a power outlet firmly. Avoid using a loose, unsound outlet or contact failure.
- Do not cut off the fitted power plug, the removal of which could lead to impaired performance. If you wish to extend the lead, obtain an appropriate extension lead or consult your dealer.
- Should you require replacing the fuse in the molded plug with a new fuse, then please replace with new one of the same value, type and approval as the original. Ensure the fuse cover is returned to its original position.



Be sure to keep safety ground connection.

Connect the ground terminal of AC inlet of this PDP TV with the ground terminal provided at the power outlet using the enclosed power cord. If the provided plug does not fit your outlet, consult an electrician for replacement of the obsolete outlet.



Surely connect the ground wire.

Be careful in handling the power cord and external connection cables.

If you keep using a damaged the power cord or cables, it can cause a fire or electrical shock. Do not apply too much heat, pressure or tension to the power cord and cables.

If the power cord or cables are damaged (exposed or broken core wires, etc.), contact your dealer.

- Do not place the monitor or heavy objects on the power cord and cables. Also, do not place a spread, cover, etc. over them because this could result in the inadvertent placing of heavy objects on the concealed power cord or cables.
- Do not pull the power cord and cables. When connecting and disconnecting the power cord or cables, do it with your hand holding the plug or connector.
- Do not place the cord near the heater.
- Do not touch the power plug just after disconnecting it from the power outlet to prevent electric shock.
- Do not touch the power plug when lightening is close to you.
- Avoid coiling the power cord and bending it sharply.
- Protect the power cord from being walked on, pinched particularly at plugs, conveniences receptacles, and the point where they exit from the apparatus.
- Do not modify the power cord.



Be careful in handling the battery of the remote control.

Incorrect handling of the battery could result in fire or personal injury. The battery may explode if not handled properly.

- Keep the battery away from children and pets. If swallowed consult a physician immediately for emergency treatment.
- Do not allow the battery to be exposed to fire or water.
- Avoid fire or high-temperature environment.
- Do not hold the battery with metallic tweezers.
- Keep the battery in a dark, cool and dry place.
- Do not short circuit the battery.
- Do not recharge, disassemble or solder the battery.
- Do not physically impact the battery.
- Use only the battery specified in the manual of this monitor.
- Make sure the plus and minus terminals are correctly aligned when loading the battery.
- If you observe a leakage of the battery, wipe out the liquid and then replace the battery. If the liquid adheres your body or clothes, rinse well with water.
- Obey the local laws on disposing the battery.



SAFETY INSTRUCTIONS(continued)

WARNING

Be careful in moving the Plasma Television.

Neglect could result in an injury or damage.

- Do not move the PDP TV during use. Before moving, disconnect the power plug and all external connections.
- You are advised to move the PDP TV with two persons.
- Avoid any impact or shock to the PDP TV; particularly take care of glass screen.

Do not put anything on top of the Plasma Television.

Placing anything on the PDP TV could result in loss of balance or falling, and cause an injury or damage. Use special caution in households where children are present.

Avoid a humid or dusty place.

Placing the PDP TV in a smoke, a highly humid, dusty place, oily soot or corrosive gas could result in fire or electrical shock.

- Do not place near the kitchen, a humidifier or other place where there is oil, smoke or humidity.

Avoid a high temperature environment.

The heat could have adverse influence on the PDP TV and other parts, and could result in transformation, melting or fire.

- Do not place the PDP TV, the remote control and other parts in direct sunlight or near a hot object such as heater, etc.
- Do not put the PDP TV in a place where the temperature is widely changing.

Remove the power cord for complete separation.

- For safety purposes, disconnect the power cord if the PDP TV is not to be used for prolonged periods of time.
- Before cleaning, turn off and unplug the PDP TV. Neglect could result in fire or electrical shock.



Disconnect the plug from the power outlet.

English

PRECAUTIONS

• Installation environment

Do not obstruct a ventilation hole.

Do not put the PDP TV on carpet or blanket, or near a curtain which has a possibility of obstructing a ventilation hole of the PDP TV.

Do not put the PDP TV in the following places.

- Hot places such as near heater, place exposed to the direct rays of the sun.
- A place where the temperature is widely changing.
- Places with soot, dust or high humidity.
- Poor air ventilation place.
- Place near fire.
- A wet place such as bathroom, or shower room.
- Place where you can trip over it.
- Always vibrating or strongly vibrating places.
- Distorted or unstable places.

• How to view the Plasma Television.

If you use the monitor in too dark a room, your eyes may become tired.

Please use it in a reasonably bright room.

Avoid direct rays of the sun to the screen in order to prevent eye fatigue.

Your eyes will get fatigued after viewing the PDP TV for long period of time.

Relax your eyes by viewing away from the PDP TV from time to time.

Please watch the PDP TV in downward direction.

• Note on image retention

The plasma PDP TV illuminates phosphor to display images. The phosphor has a finite illumination life. After extended periods of illumination, the brightness of the phosphor will be degraded to such extent that stationary images would burn-in that part of the screen as grayed-out images.

Tips to prevent such image retention are:

- Do not display images having sharp brightness differences or high-contrast images, such as monochrome characters and graphic patterns, for long.
- Do not leave stationary images appearing for long, but try to refresh them at appropriate intervals of time, or try to move them using screen saver function.
- Turn down the contrast and brightness controls.

• How to clean the plasma screen panel of the Plasma Television.

Before cleaning the PDP TV, turn off the monitor and disconnect the power plug from the power outlet.

To prevent scratching or damaging the plasma screen face, do not knock or rub the surface with sharp or hard objects. Clean the screen with a soft cloth moistened with warm water and dry with a soft cloth. If it is not enough, then use a cloth with mild detergent. Do not use harsh or abrasive cleaners.

• How to clean the cabinet of the Plasma Television.

Use a soft cloth to clean the cabinet and control panel of the PDP TV. When excessively soiled dilute a neutral detergent in water, wet and wring out the soft cloth and afterward wipe with a dry soft cloth.

Never use acid/alkaline detergent, alcoholic detergent, abrasive cleaner, powder soap, OA cleaner, car wax, glass cleaner, etc. especially because they would cause discoloration, scratches or cracks.

SAFETY INSTRUCTIONS(continued)

• Prevention of an obstacle to Radio receivers

This PDP TV has been designed pursuant to the international EMI standards. This is to prevent a problem to Radio receivers.

- Keep the PDP TV away from Radio.
- Adjust Radio antennas in order for the monitor not to receive interference.
- The antenna cable of Radio should be kept away from the PDP TV.
- Use a coaxial cable for antenna.

You can check if this PDP TV influences Radio receivers by turning off all other equipment other than the monitor.

If you find a problem receiving Radio when using the PDP TV, check the instructions mentioned above.

• Precautions for the cable connection

- Do ensure that all connections, (including the power plug, extension leads and interconnections between the pieces of equipment), are properly made and in accordance with the manufacturers instructions. Switch off and withdraw the power plug before making or changing connections.
- Confirm the connector is fixed tightly when the signal cable is connected.
Also confirm the screws on the connector are tightened.
- Plug the power cord of the PDP TV into a different socket from that for other equipment, such as Radio etc..
- Use a plug with ground terminal and make sure that it connects to the ground.

• Precaution during transportation

Please pay attention when you transport this PDP TV because it is heavy.

Furthermore, use the original carton box and its packaging materials when the PDP TV is transported.

Failure to transport the monitor in any carton except the original carton may result in damage to the PDP TV.

Save the original carton box and all packing material.

Do not physically impact the remote control.

A physical impact could cause damage or malfunction of the remote control.

- Take care not to drop the remote control.
- Do not place heavy objects on the remote control.

Avoid strong rays.

Any strong rays (such as direct sun rays or room lighting) onto the remote control sensors could invalidate the remote control.

Avoid radio interference.

Any interfering radiation could cause distorted images or noises.

- Avoid radio generator such as a mobile telephone, transceiver, etc. around the PDP TV.

Set the sound volume at a suitable level.

It is better to keep the volume level low and close the windows at night to protect the neighborhood environment.

• Precautions for the installation

- Do not use makeshift stands and NEVER fix legs with wood screws - to ensure complete safety, always fit the manufacturers approved stand or legs with the fixings provided according to the instructions.
- Use only with the cart, stand, tripod, bracket, or table specified by the manufacturer, or sold with the apparatus. When a cart is used, use caution when moving the cart/apparatus combination to avoid injury from tip-over.
- This product is designed to comply with the recommended safety standards for tilt and stability. Do not apply excessive pulling force to the front, or top, of the cabinet that could cause the product to overturn resulting in product damage and/or personal injury.
- Follow instructions for wall, shelf or ceiling mounting as recommended by the manufacturer.
- Only use the attachments/accessories specified by the manufacturer.
- Consult your dealer if you are in any doubt about installation, operation or safety of your equipment.

• Other precautions

- Do not leave equipment switched on when it is unattended unless it is specifically stated that it is designed for unattended operation or has a stand-by mode. Switch off using the switch on the equipment and show your family how to do this. Make special arrangements for infirm or handicapped people.
- Disposal of this product may require specific instructions pertaining to your resident region.
- Never guess or take any chances with electrical equipment of any kind - it is better to be safe than sorry!

ACCESSORIES

Check to make sure you have the following accessories before disposing of the packing material.

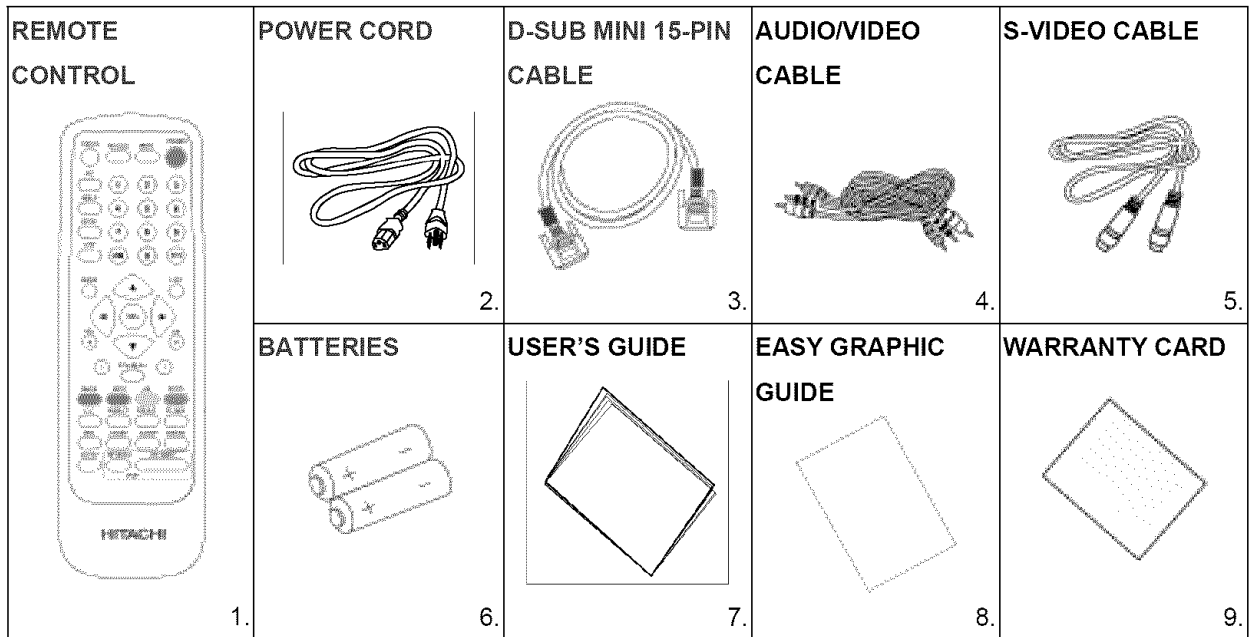

CAUTION: Ceiling mounting is not recommended. Mounting the panel on the ceiling does not provide adequate ventilation for the electronics or proper support for the front glass panel. This plasma television product is designed for a maximum tilting angle of 45 degrees from vertical.

- | | |
|----------------------------|-----------------------------------|
| 1. Remote Control Unit | 6. Two "AAA" size, 1.5V batteries |
| 2. Power Cord | 7. User's Guide |
| 3. D-SUB Mini 15-Pin Cable | 8. Easy Graphic Guide |
| 4. Audio/Video Cable | 9. Warranty Card |
| 5. S-Video Cables | |

REMOTE CONTROL BATTERY INSTALLATION AND REPLACEMENT

1. Open the battery cover of the remote control by pressing the notched part of the cover with your fingers and pulling the cover off.
2. Insert two new "AAA" size batteries for the remote control. When replacing old batteries, push them towards the springs and lift them out.
3. Match the batteries to the (+) and (-) marks in the battery compartment.
4. Replace the cover.

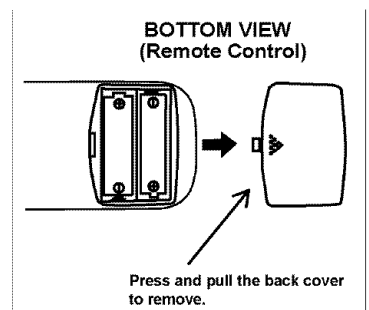

CAUTION: Danger of explosion if battery is incorrectly replaced. Replace with the same or equivalent type.

HOW TO SETUP YOUR NEW HITACHI PLASMA TELEVISION

To take measures to prevent the Plasma Television from tipping over and prevent possible injury it is important to mount the unit in a stable place.

Securing to a wall

*Keep the Plasma Television four inches away from the wall except those hung to the wall mount bracket.

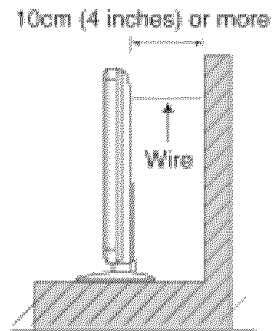

- NOTES:** 1. Do not block the ventilation holes of the Plasma Television. Blocking the ventilation holes might cause fire or defect.
2. If you purchased the wall mount bracket option, please ask for professional installer. Do not install by yourself.

Caution when moving the main unit

As this product is heavy, whenever it is moved, two people are required to transport it safely. Whenever the unit is moved it should be lifted forward using the top and base on both sides for stability. When moving the Plasma Television, lift the top and the bottom frame as shown below.

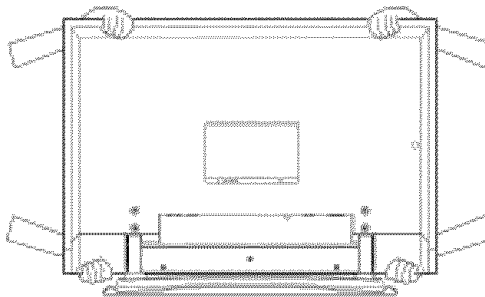

ANTENNA

Unless your Plasma Television is connected to a cable TV system or to a centralized antenna system, a good outdoor color TV antenna is recommended for best performance. However, if you are located in an exceptionally good signal area that is free from interference and multiple image ghosts, an indoor antenna may be sufficient.

LOCATION

Select an area where sunlight or bright indoor illumination will not fall directly on the picture screen. Also, be sure that the location selected allows a free flow of air to and from the perforated back cover of the set.

To avoid cabinet warping, cabinet color changes, and increased chance of set failure, do not place the TV where temperatures can become excessively hot, for example, in direct sunlight or near a heating appliance, etc.

HOW TO SETUP YOUR NEW HITACHI PLASMA TELEVISION

VIEWING

The major benefit of the HITACHI Plasma Television is its large viewing screen. To see this large screen at its best, test various locations in the room to find the optimum spot for viewing. The best picture is seen by sitting directly in front of the TV and about 8 to 18 feet from the screen.

During daylight hours, reflections from outside light may appear on the screen. If so, drapes or screens can be used to reduce the reflection or the TV can be located in a different section of the room.

If the TV's audio output will be connected to a Hi-Fi system's external speakers, the best audio performance will be obtained by placing the speakers equidistant from each side of the receiver cabinet and as close as possible to the height of the picture screen center. For best stereo separation, place the external speakers at least four feet from the side of the TV, place the surround speakers to the side or behind the viewing area. Differences in room sizes and acoustical environments will require some experimentation with speaker placement for best performance.

IMPORTANT NOTES

No.	Items	Notes
1	Arching sound from plasma television panel.	A buzzing sound might be heard when the plasma television is turned on in a very quiet room. This is due to the plasma display panel drive circuit when it is functioning. This arching sound is normal and it is not a malfunction.
2	Interference for infrared equipment.	Some infrared rays are emitted from the plasma television's panel that might affect other infrared controlling equipment.
3	Bright and dark spots	High-precision technology is used to manufacture the plasma display panel; But in some cases, there are minor defects in some parts of the screen. Points that do not light, points with brightness different from that of the periphery, points with color different from that of the periphery, etc. Some pixels will always be on or always off. Please note that this is not a malfunction.
4	Picture Image (Spectrum)	When receiving still picture signals, (e.g. channel number indication or clock indication) for a while, you can see image-like when the picture varied. This is not a defect.
5	Display panel surface temperature is too high	The plasma display panel is lighting the phosphors by the discharge of internal radiation. In some cases, this may cause the temperature of the panel surface to increase. Please note that this is not a malfunction. The Plasma TV surface temperature is higher than a Cathode-ray-tube.
6	Plasma Surface	The plasma display panel is made from glass. Heavy shock on the front panel might damage it.
7	Transportation	When the plasma television is transported horizontally, the glass panel has the possibility of being broken or increasing the picture defects. At the time of transportation, horizontal style is prohibited. More-over, please treat the plasma panel with great care because of a precision apparatus. Please instruct transporters so that it should be put into the packing box at the time of shipment. (There is a possibility that breakage of the panel or defects will increase.) Rough transportation might cause damage to the panel and pixel failure.
8	Image retention	The plasma monitor illuminates phosphor to display images. The phosphor has a finite illumination life. After extended periods of illumination, the brightness of the phosphor will be degraded to such extent that stationary images would burn-in that part of the screen as grayed-out images. Tips to prevent such image retention are: - Do not display images having sharp brightness differences or hi-contrast images, such as monochrome characters and graphic patterns, for long. - Do not leave stationary images appearing for long, but try to refresh them at appropriate intervals of time, or try to move them using screen saver function. - Turn down the contrast and brightness controls.
9	Luminosity and contrast	Plasma television has luminosity and low contrast compared with CRT television.
10	Granular spots	When a screen is seen at point-blank range, a random fine grain may be visible to a dark part.
11	Disturbance to video apparatus	If an apparatus (VCR, etc.) antenna line is arranged near the monitor, the image may shake, or disturbance may be received.
12	Lip Sync	There is some time lag between the picture and the sound. You can see lip motion that is delayed compared to the sound.
13	About the use environment of plasma television (temperature)	Electric discharge/luminescence characteristic of the plasma display panel also changes with peripheral temperature. Moreover, since there is also high power consumption value, a specified temperature environment is required.
14	Caution on prolonged storage	Storing the plasma television for a period of more than 2 to 3 months without use might cause an unstable picture when the set is turned on.
15	Operating	Operating altitude: 800 to 1,114hPa (6,194ft to -2,484ft). Operating temperature: 41°F to 95°F.
16	Storage	Storage Altitude: 300 to 1,114hPa (31,912ft to -2,484ft). Storage temperature: 5°F to 140°F.
17	Power ON or OFF	Frequent use of the Power ON or OFF might trigger the power protection circuit. If the TV does not turn ON, please wait a little before turning ON again.

HOOKUP CABLES

Most video/audio connections between components can be made with shielded video and audio cables that have phono connectors. For best performance, video cables should use 75-Ohm coaxial shielded wire. Cables can be purchased from most stores that sell audio/video products. Below are illustrations and names of common connectors. Before purchasing any cables, be sure of the output and input connector types required by the various components and the length of each cable.

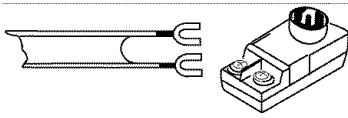

300-Ohm Twin Lead Connector
This outdoor antenna cable must be connected to an antenna adapter (300-Ohm to 75-Ohm).

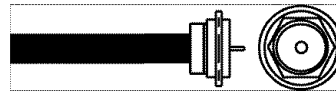

"F" Type 75-Ohm Coaxial Antenna Connector
For connecting RF signals (antenna or cable TV) to the antenna jack on the television.

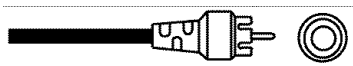

Phono Connector (Provided)
Used on all standard video and audio cables which connect to inputs and outputs located on the rear jack panel.

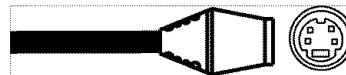

S-Video (Super Video) Connector (Provided)
This connector is used on camcorders, VCRs and laserdisc players with an S-Video feature in place of the standard video cable to produce a high quality picture.

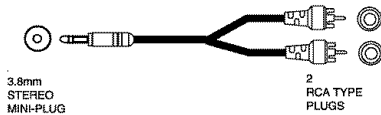

Stereo Cable
This cable is used to connect from external audio out to the audio input of the Plasma TV (ex. ANALOG RGB/DVI Audio Input).

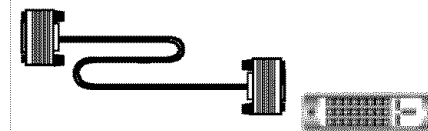

DVI Cable
This cable is stands for Digital Visual Interface. Use for high quality PC Display.

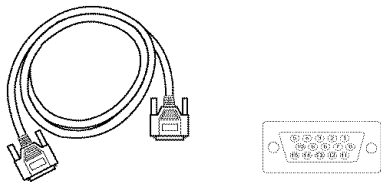

D-SUB MINI 15-Pin Cable (Provided)
This cable is used to connect a computer output to the D-SUB input located on the rear panel of the Plasma TV. The resolution should be set correctly to display the signal on the Plasma TV.

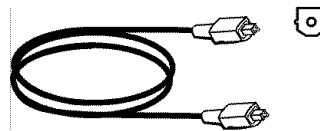

Optical Cable
This cable is used to connect to an audio amplifier with an Optical Audio In jack. Use this cable for the best sound quality.

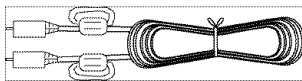

Subwoofer Cable
This cable is used to connect an external audio component input to the subwoofer output of the Plasma TV.

ANTENNA CONNECTIONS TO REAR PANEL JACKS

VHF (75-Ohm) antenna/CATV (Cable TV)

When using a 75-Ohm coaxial cable system, connect the outdoor antenna or CATV coaxial cable to the ANALOG RF terminal (75-Ohm) and/or DIGITAL RF terminal (75-Ohm).

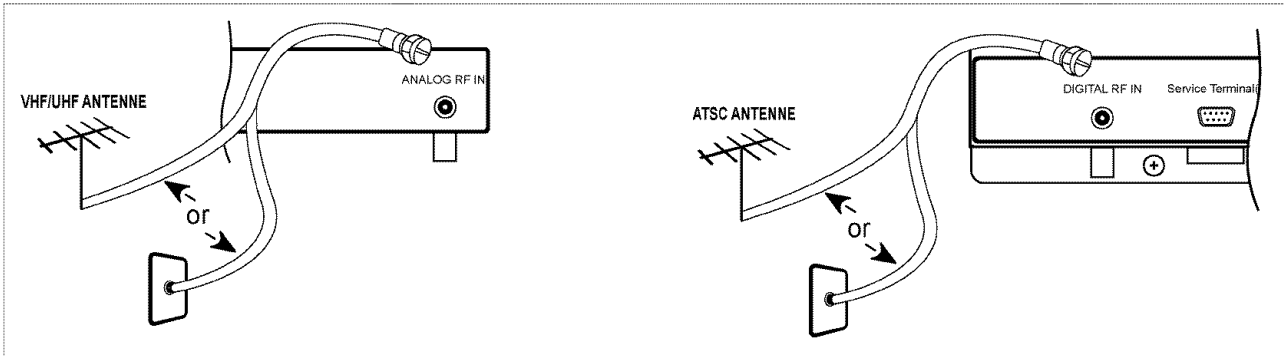

English

VHF (300-Ohm) antenna/UHF antenna

When using a 300-Ohm twin lead from an outdoor antenna, connect the VHF or UHF antenna leads to screws of the VHF or UHF adapter. Plug the adapter into the antenna terminal on the TV. To outdoor VHF

When both VHF and UHF antennas are connected

Attach an optional antenna cable mixer to the TV antenna terminal, and connect the cables to the antenna mixer. Consult your dealer or service store for the antenna mixer.

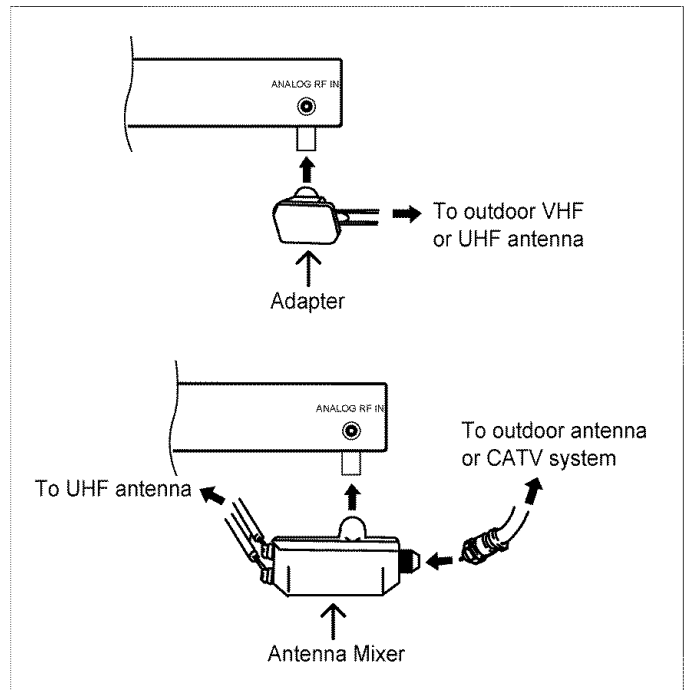

FRONT PANEL CONTROLS

FRONT VIEW

42" PLASMA TV

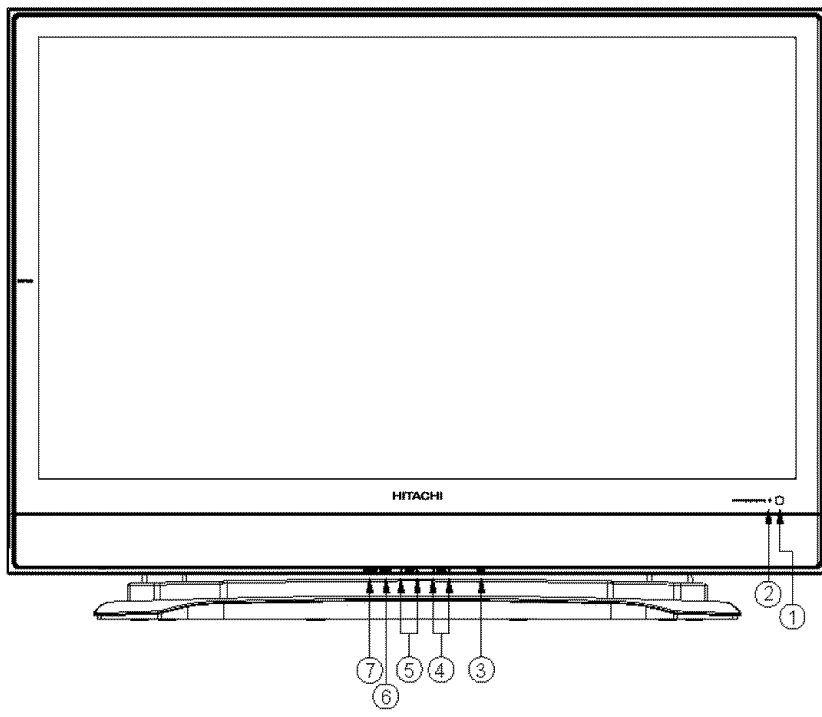

REMOTE CONTROL sensor

Point your remote at this area when selecting channels, adjusting volume, etc.

POWER light indicator

To turn the PDP TV ON, press the main power button located on the BACK left side of the TV. A red stand-by indicator lamp located on the lower right corner of the front bezel will illuminate. The PDP TV is now ready for remote on/off operation.

Indicating Lamp	Power Status	Operating
Off	Off	When the MAIN POWER is set OFF.
Lights Red	Off (Stand-by)	When the MAIN POWER is set ON and the Front Key or Remote Control POWER is OFF.
Lights Orange	Off (Power Saving)	1. When the MAIN POWER is set ON. 2. No signal input (no sync. signal).
Lights Green	On	When the POWER is ON.

POWER button

This power button is for power on the plasma television or change to standby mode.

CHANNEL selector

Press these buttons until the desired channel appears in the top right corner of the TV screen. These buttons also serve as the cursor down (•) and up (•) buttons when in MENU mode.

VOLUME level

Press these buttons to adjust the sound level. The volume level will be displayed on the TV screen. These buttons also serve as the cursor left (◀) and right (▶) buttons when in MENU mode.

INPUT/EXIT button

Press this button to select the desired input: NTSC, DTV, Composite-VIDEO, S-VIDEO, YC_BCR, YP_BPR, Analog RGB or DVI source. This button also serves as the EXIT button when in MENU mode.

MENU/SELECT button

This button allows you to enter the MENU, making it possible to set TV features to your preference without using the remote. This button also serves as the SELECT button when in MENU mode.

REAR PANEL MAIN POWER SWITCH & JACKS

REAR VIEW

42" PLASMA TV

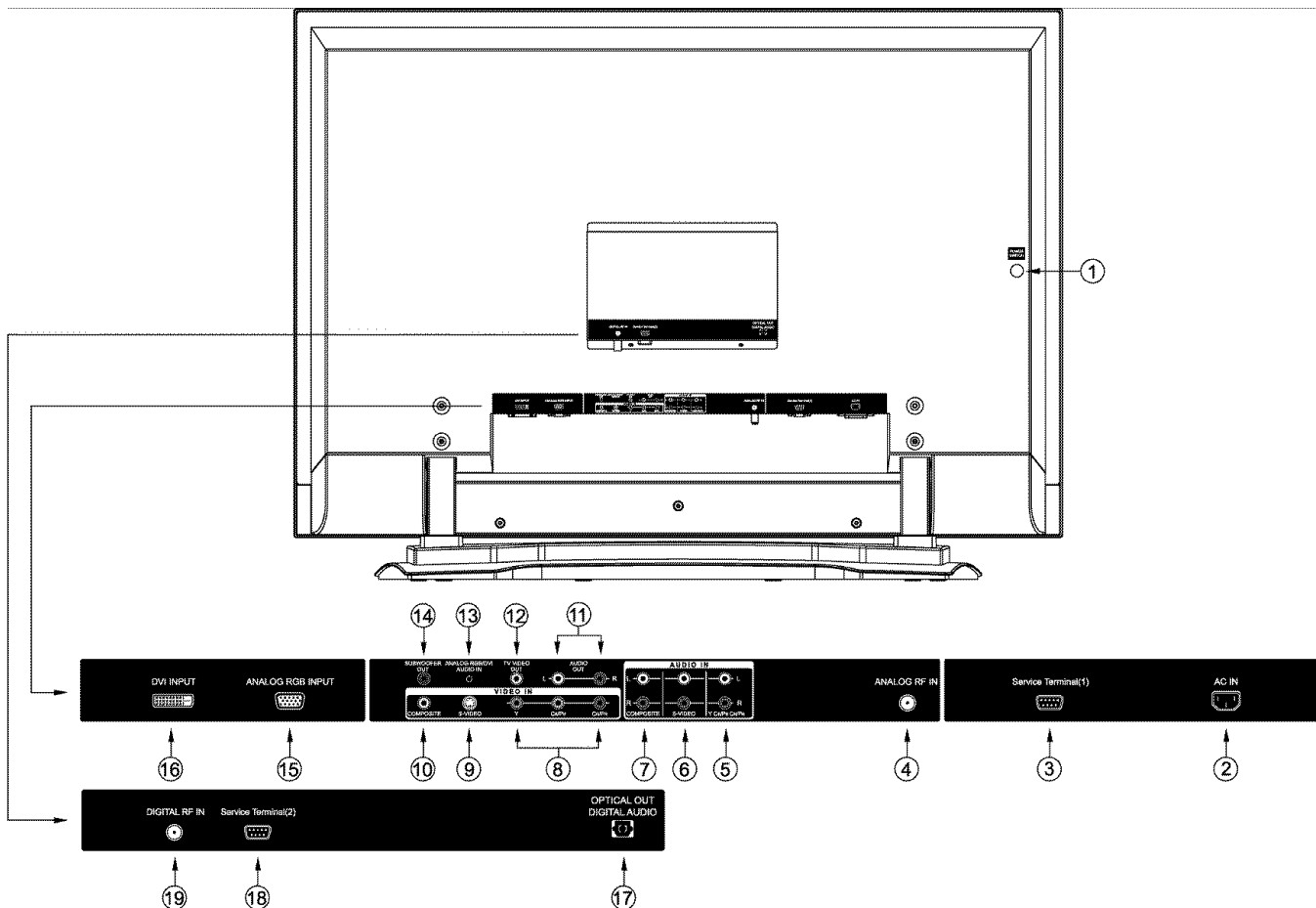

English



- MAIN POWER button**
 This power button is for the complete system, and must be turned ON/OFF manually. It is recommended to leave the "MAIN POWER" to ON condition (lights red) for stand-by mode.
- AC IN input**
 This TV is designed to operate on 120VOLTS 60Hz AC current. Insert the TV power cord into a 120VOLTS 60Hz outlet.
- Service Terminal (1) Input**
 For factory adjustment and service, please DO NOT connect here.
- ANALOG RF Input**
 RF input that connects to the antenna, cable box, or CATV cable. Supports NTSC TV system.
- Y-PBPR / Y-CBCR - Audio Input**
 Connect audio for Component input (if you have mono sound, insert the audio cable into the left(L) audio jack).
- S-VIDEO - Audio Input**
 Connect audio for S-Video input (if you have mono sound, insert the audio cable into the left(L) audio jack).
- COMPOSIT - Audio Input**
 Connect audio for Composite input (if you have mono sound, insert the audio cable into the left(L) audio jack).
- Y-PBPR / Y-CBCR Inputs**
 Provide Y-PBPR / Y-CBCR jacks for connecting equipment with this capability, such as a DVD player or Set Top Box.

REAR PANEL JACKS

⌞ S-VIDEO Inputs

Provide S-VIDEO (Super Video) jacks for connecting equipment with S-VIDEO output capability.

⌞ COMPOSITE VIDEO Input

By using the VIDEO button of the remote control, you can select Composite video source. Use the audio and video inputs to connect external devices, such as VCRs, camcorders, laserdisc players, DVD players etc. (if you have mono sound, insert the audio cable into the left(L) audio jack).

⌞ AUDIO Output

These jacks provide fixed audio signal which are used for recording.

⌞ TV VIDEO Output

This jack provides video signals (NTSC, DTV) which are used for recording. Composite VIDEO, S-VIDEO, Component signal, Analog RGB and DVI inputs do not have TV VIDEO output.

⌞ ANALOG RGB/DVI Audio Input

Connect audio for ANALOG RGB or DVI input.

⌞ SUBWOOFER Output

Connect this SUB WOOFER OUT output to the external audio component input.

⌞ ANALOG RGB Input

Use this 15-pin D-Sub input for your external devices with RGB output using the D-Sub Mini 15-pin cable provided.

⌞ DVI Input

Stand for Digital Visual Interface. Use for high quality PC display.

⌞ OPTICAL OUT (Digital Audio)

This jack provides Digital Audio Output for your audio device that is Dolby® Digital and PCM compatible, such as an audio amplifier.



Manufactured under license from Dolby Laboratories.

“Dolby” and the double-D symbol are trademarks of Dolby Laboratories.

⌞ Service Terminal (2) Input

For factory adjustment and service, please DO NOT connect here.

⌞ DIGITAL RF Input

RF input that connects to the antenna, cable box, or CATV cable. Support ATSC TV system.

CONNECTING EXTERNAL SOURCES

The exact arrangement you use to connect the PC, VCR, camcorder, laserdisc player, DVD player, or HDTV Set Top Box to your Plasma TV is dependent on the model and features of each component. Check the owner's manual of each component for the location of video and audio inputs and outputs.

The following connection diagrams are offered as suggestions. However, you may need to modify them to accommodate your particular assortment of components and features. For best performance, video and audio cables should be made from coaxial shielded wire.

CONNECTING AN DIGITAL TV ANTENNAS

1. Attach an ATSC antenna cable to the Digital RF terminal.
2. Connect the outdoor antenna cable lead-in to the terminal marked Digital RF IN on the rear of the TV set.
3. Connect all power sources before activating the PDP TV.
4. Turn on the PDP TV.
5. Press DTV on the remote.

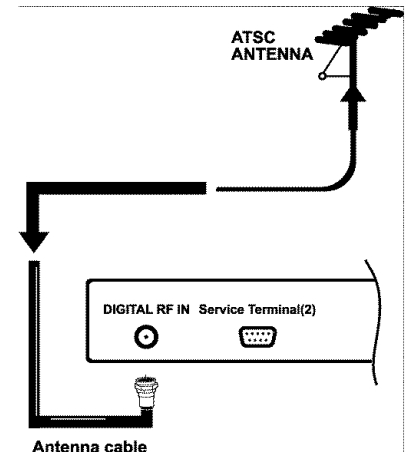

NOTES: Refer to the owner's manual of the external equipment to be connected. When connecting external equipment, do not connect the AC power cords to wall outlets until all other connections are completed.

CONNECTING AN ANALOG TV CABLE OR AN ANALOG ANTENNA WITHOUT A TV CABLE BOX

1. Use one of the following two diagrams if you connect to an outdoor antenna.
 - A: Using a VHF/UHF combination outdoor antenna.
 - B: Using separate VHF and/or UHF outdoor antennas.
2. Connect all power sources before activating the PDP TV.
3. Turn on the PDP TV.
4. To use the TV, press NTSC on the remote.

A

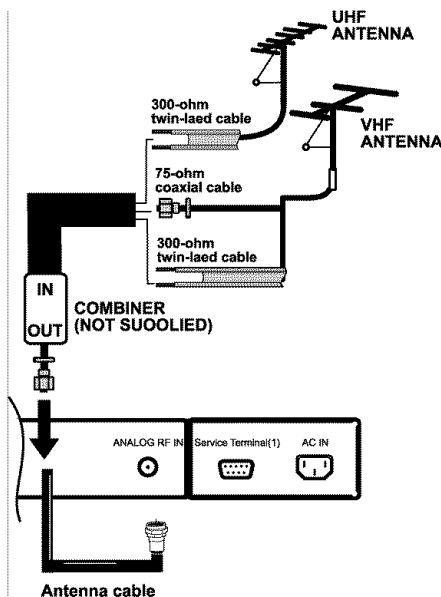

B

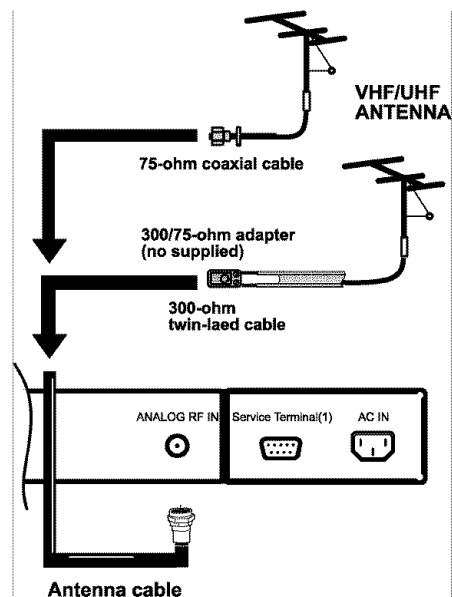

NOTES: Ensure that the power cord is inserted correctly to avoid connector damage.

CONNECTING EXTERNAL SOURCES

CONNECTING HDTV SOURCES

HDTV input sources, such as a digital cable box, digital satellite receiver, or digital terrestrial receiver box, can be connected as desired, using the appropriate cable system.

1. Connect the HDTV source device using the appropriate cable pair, in the following order of preference:

DVI cable and audio cable OR Component cable and audio cable

2. Connect all power sources before activating the PDP TV.

3. Turn on the PDP TV.

4. Press the button corresponding to the appropriate signal source (DVI, or Component Video-YC_BC_R/YP_BP_R)

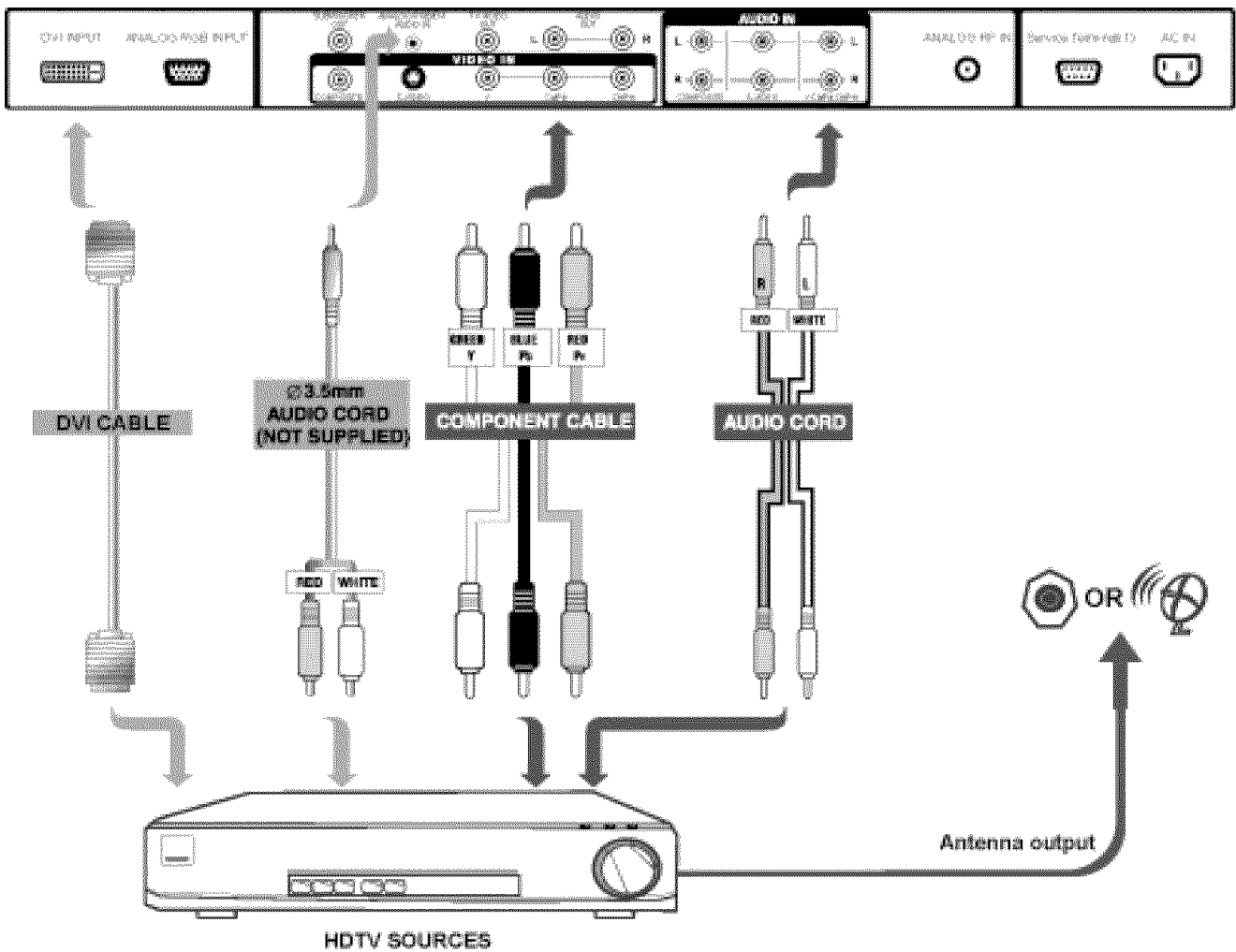

CONNECTING EXTERNAL SOURCES

CONNECTING A TV CABLE BOX OR SATELLITE RECEIVER

1. Connect the TV Cable Box or Satellite Receiver device using:

Component cable and Audio cable OR

S-Video cable and Audio cable OR

Composite cable and Audio cable.

2. Connect all power sources before activating the PDP TV.

3. Turn on the PDP TV.

4. Press the button corresponding to the appropriate signal source (Component Video- YCbCr/YPrPb, S-Video or Composite Video)

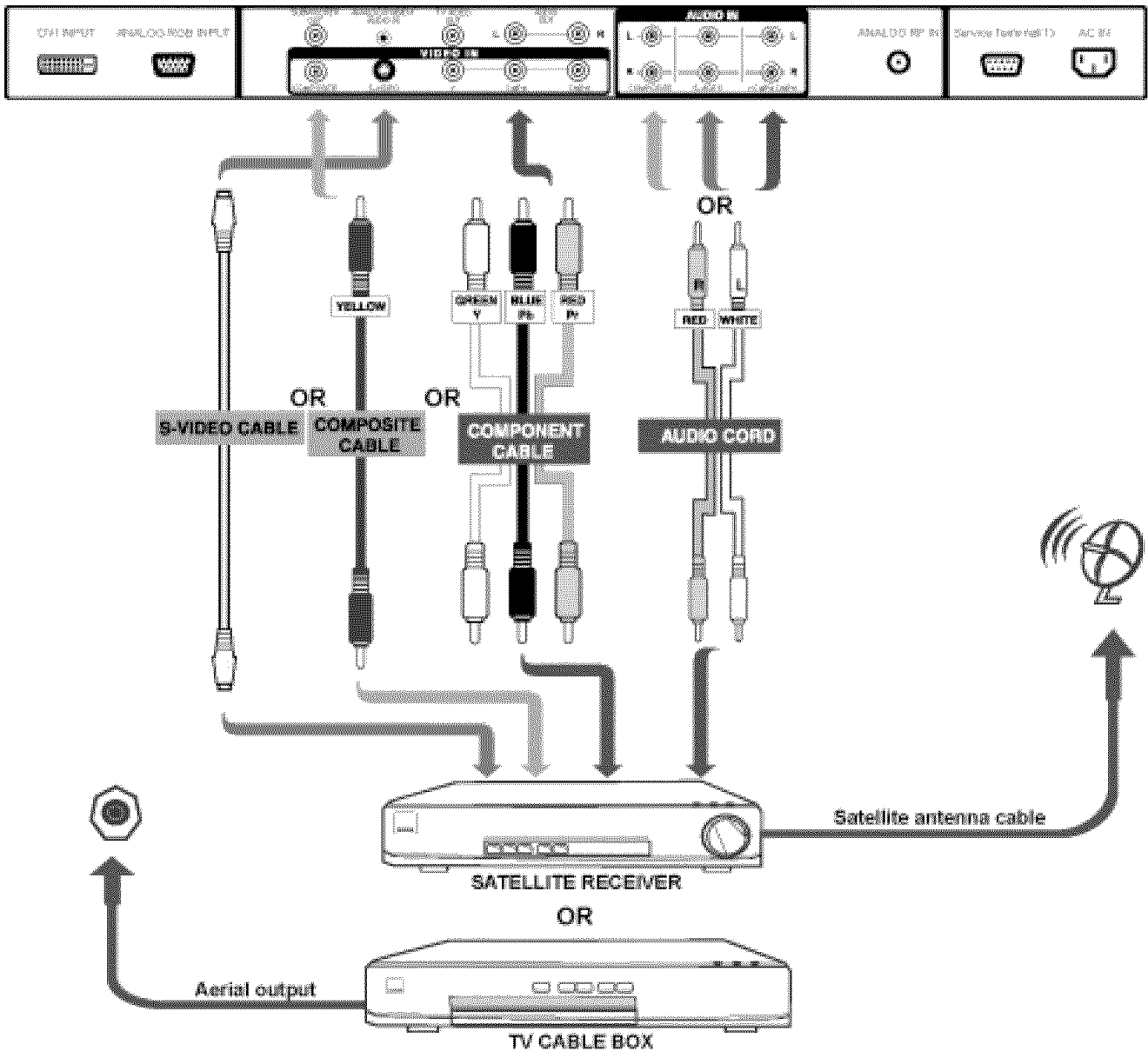

CONNECTING EXTERNAL SOURCES

CONNECTING A DVD PLAYER

1. Connect the DVD player using:
Component cable and Audio cable OR
S-Video cable and Audio cable OR
Composite cable and Audio cable.
2. Connect all power sources before activating the PDP TV.
3. Turn on the PDP TV.
4. Press the button corresponding to the appropriate signal source (Component Video- YC_BCr/YP_BP_R, S-Video or Composite Video)

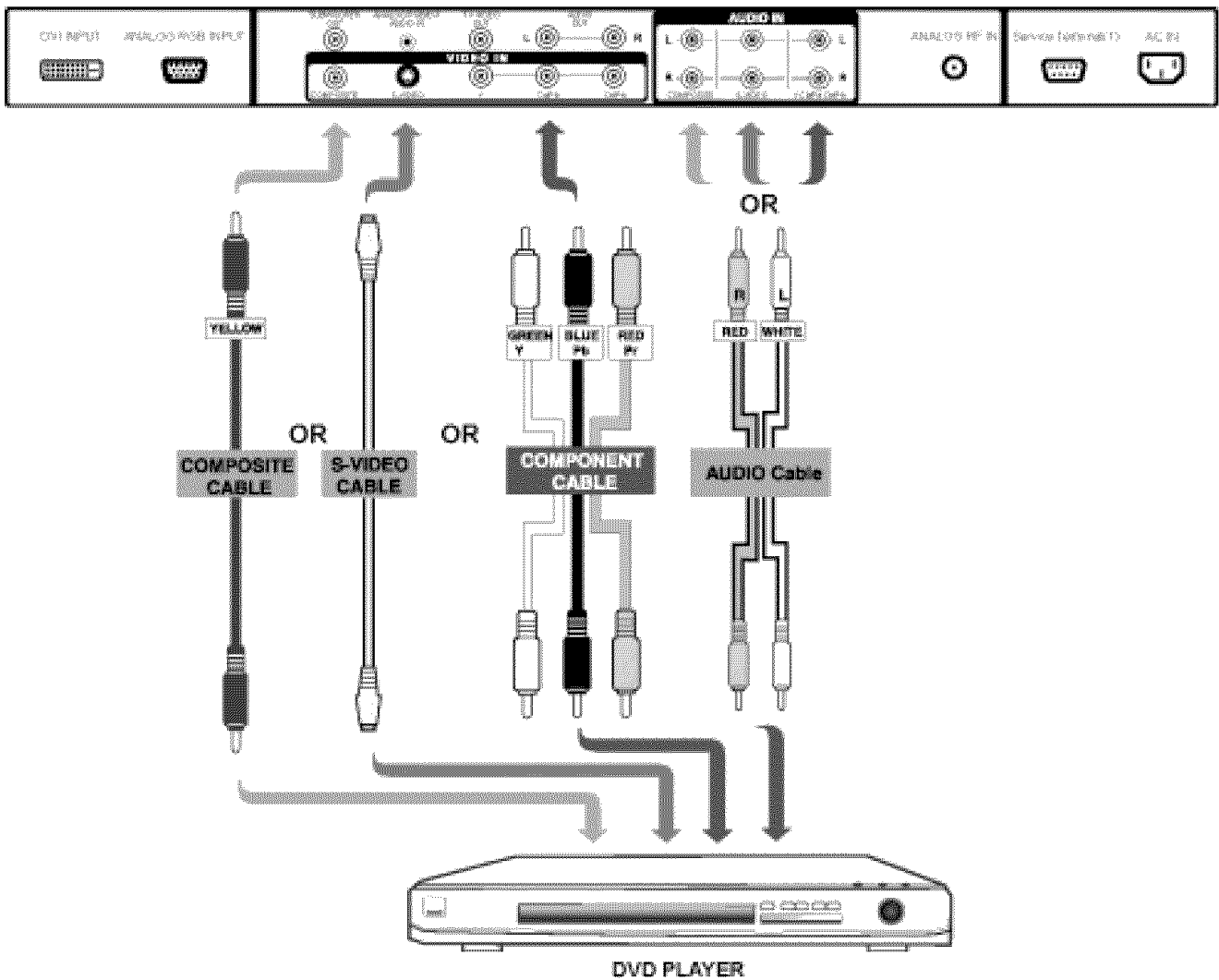

CONNECTING EXTERNAL SOURCES

CONNECTING A VCR

1. Connect the VCR player using:
S-Video cable and Audio cable OR
Composite cable and Audio cable.
2. Connect all power sources before activating the PDP TV.
3. Turn on the PDP TV.
4. Press the button corresponding to the appropriate signal source (S-Video or Composite Video)

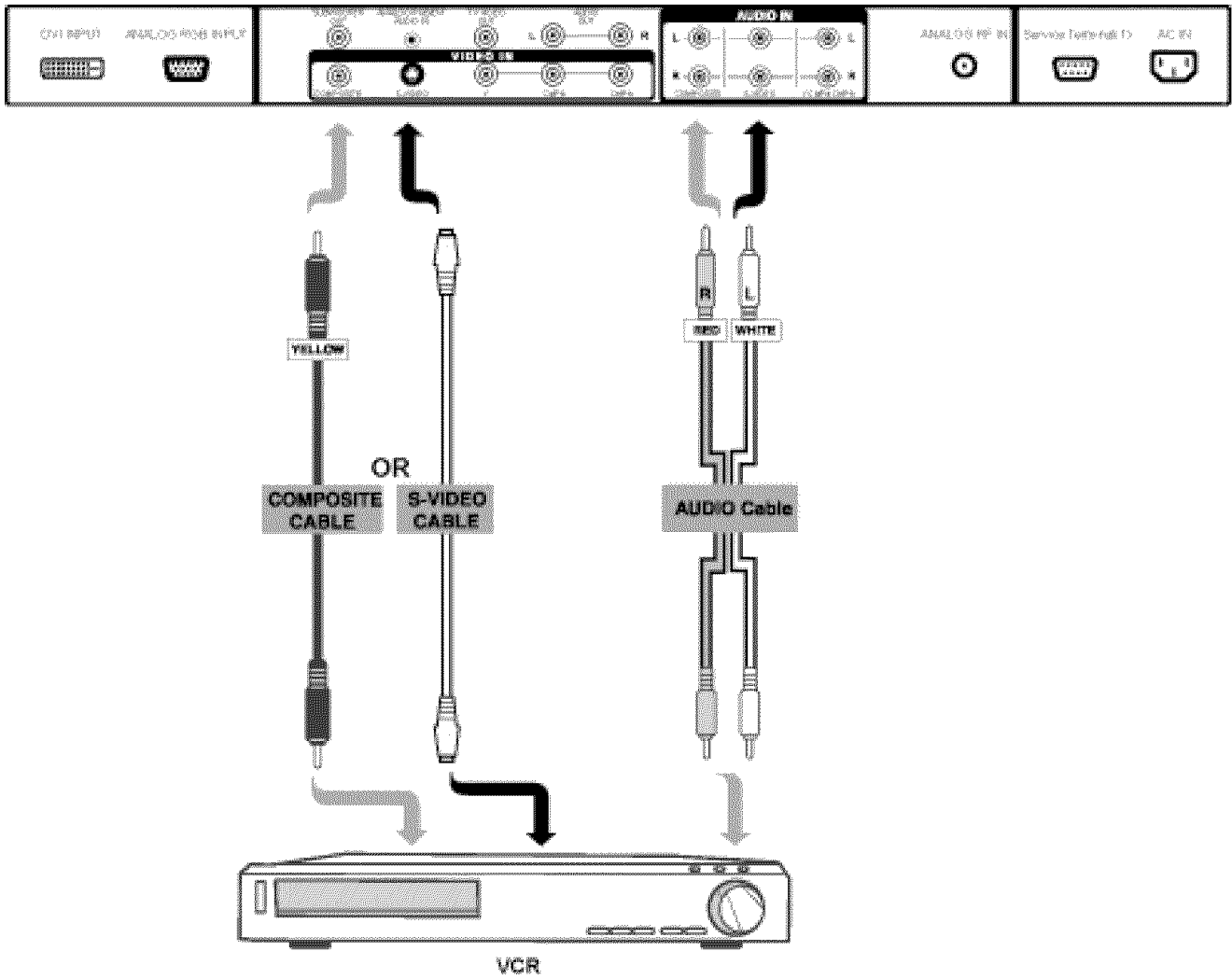

CONNECTING EXTERNAL SOURCES

CONNECTING A AUDIO RECEIVER

For improved sound quality, you may want to play the audio of the PDP through your stereo system.

1. Use an audio cable to connect the PDP's audio output jacks to the line input jacks on the A/V receiver.
2. Connect all power sources before activating the PDP TV.
3. Turn on the PDP TV.
4. Press the MENU to display the menu, then press • • • to select Audio.
5. Press SEL, then press ◀ ▶ to select subwoofer and press ◀ ▶ to select On/Off.

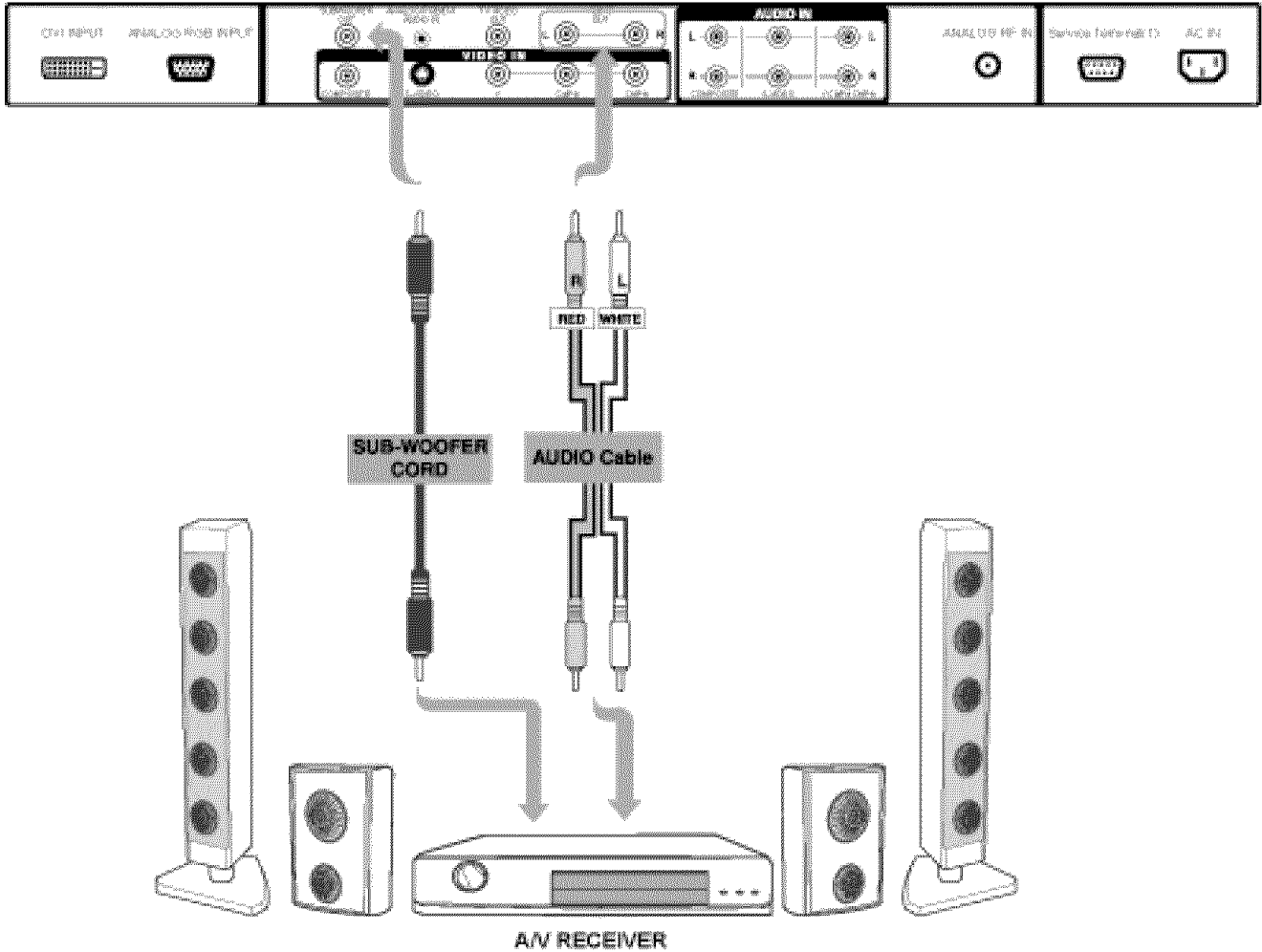

CONNECTING EXTERNAL SOURCES

CONNECTING PC

1. Connect the PC using:
D-Sub cable and 35mm Audio cable OR
DVI cable and 35mm Audio cable
2. Connect all power sources before activating the PDP TV.
3. Turn on the PDP TV.
4. Press the button corresponding to the appropriate signal source (Analog RGB or DVI)

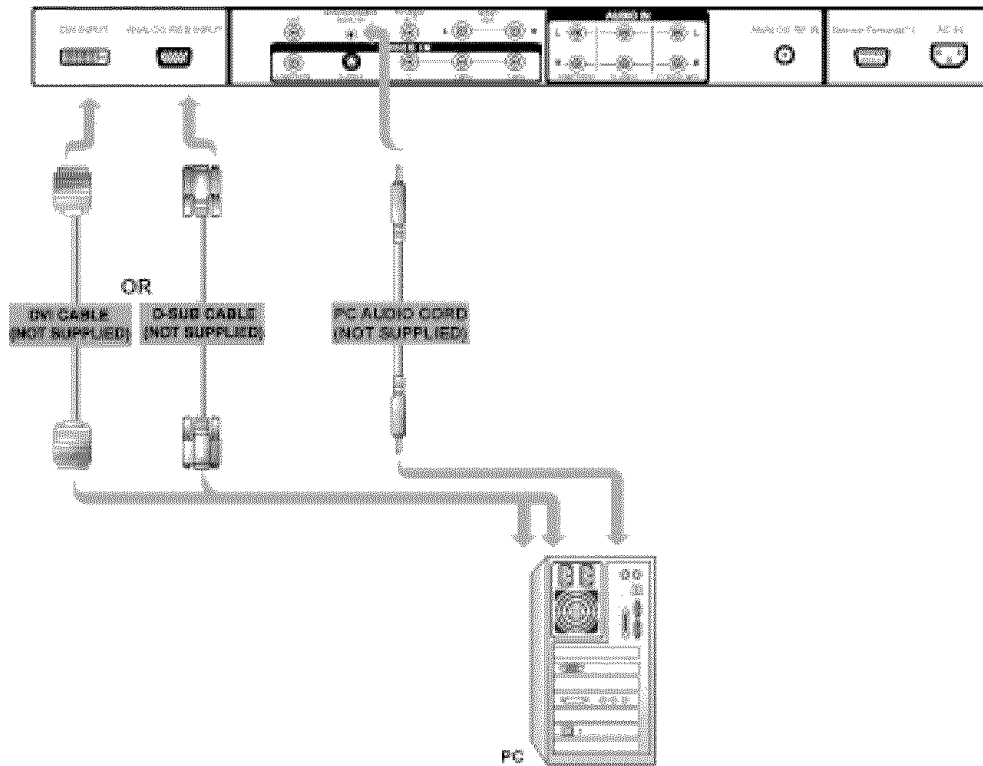

This Plasma Television can automatically detect and display the signal format below.

Recommended Signal List

No.	Signal Mode			
	Signal Name	Resolution	Vertical Frequency (Hz)	Horizontal Frequency (kHz)
1	VESA	640 x 400	70.09	31.47
2	VGA	640 x 480	59.94	31.47
3	VESA	640 x 480	72.81	37.86
4		640 x 480	75.00	37.50
5		800 x 600	56.25	35.16
6		800 x 600	60.32	37.88
7		800 x 600	72.19	48.08
8		800 x 600	75.00	46.88
9		1024 x 768	60.00	48.36
10		1024 x 768	70.07	56.48
11		1024 x 768	75.03	60.02
12		1280 x 1024	60.02	63.98
13	1280 x 1024	75.03	79.98	
14	1080i	1080	59.94	33.72
15	720p	720	59.94	44.96
16	480p	480	59.94	31.47

CONNECTING EXTERNAL SOURCES

CONNECTING EXTERNAL AUDIO AMPLIFIER

For monitor the audio level of the PDP TV to an external audio amplifier, connect the system as below:

1. Use a digital audio cable to connect the PDP's digital audio output jacks to the input jacks on the volume of the amplifier.
2. Connect all power sources before activating the PDP TV.
3. Turn on the PDP TV.

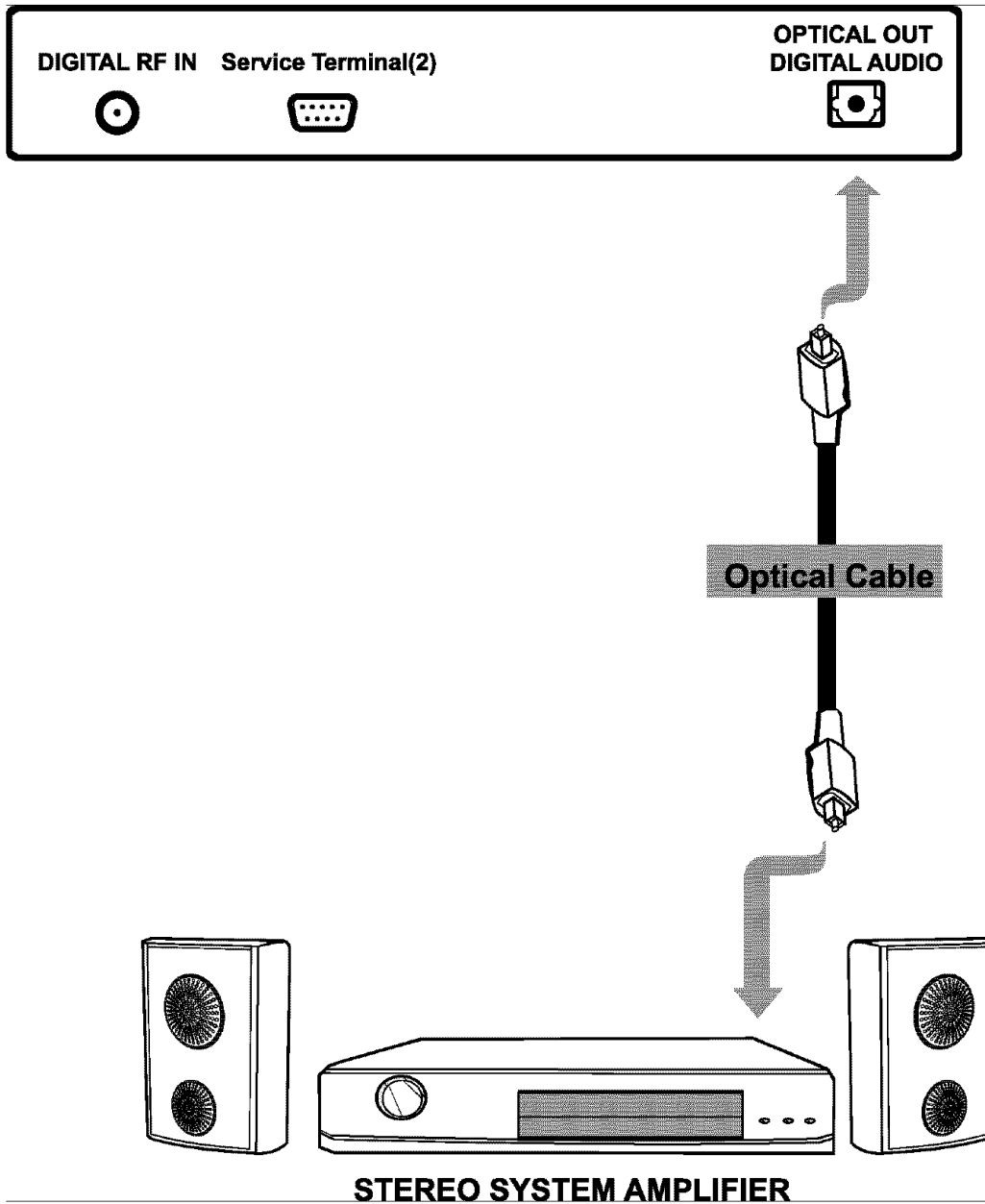

TIPS ON REAR PANEL CONNECTIONS

- S-VIDEO or Y-P_BP_R connections are provided for high performance laserdisc players etc. that have this feature. Use these connections in place of the standard video connection if your device has this feature.
- If your device has only one audio output (mono sound), connect it to the left(L) audio jack on the TV.
- Refer to the operating guide of your other electronic equipment for additional information on connecting your hook-up cables.
- Connect only 1 component (VCR, DVD player, camcorder, etc.) to each input jack.
- COMPONENT: Y-P_BP_R connections are provided for high performance components, such as DVD players and set-top-boxes. Use these connections in place of the standard video connection if your device has this feature.
- Your component outputs may be labeled Y, B-Y, and R-Y. In this case, connect the components B-Y output to the TV's PB input and the components R-Y output to the TV's PR input.
- Your component outputs may be labeled Y- C_BC_R. In this case, connect the components CB output to the TV's PB input and the components CR output to the TV's PR input.
- It may be necessary to adjust TINT to obtain optimum picture quality when using the Y-P_BP_R inputs.
- To ensure no copyright infringement, the TV VIDEO OUT output will be abnormal, when using the Y-P_BP_R, RGB and DVI input jacks.
- When using a DVI input from a Set-Top-Box, it is recommended to use a 1080i or 720p input signal.

HOW TO USE THE REMOTE TO CONTROL YOUR PLASMA TV

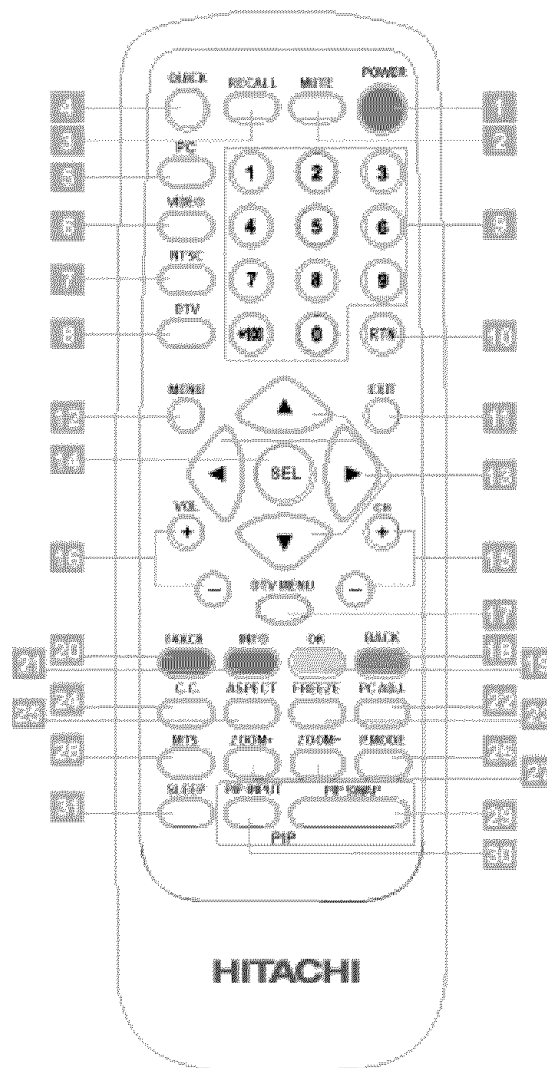

1. POWER button

Press this button to turn the TV set on or standby.

2. MUTE button

Press to mute the volume. Press again to restore the volume.

3. RECALL button

Press to display source input signal on the display. When the PIP function is working, press to display audio source. Then press • • • buttons to select between the sound of your main picture or PIP.

4. QUICK buttons

Shortcut to access the Brightness, Contrast, Volume, Treble, Bass, and Balance adjustment. Press repeatedly to circle through the selections.

5. PC button

Press to switch directly to PC mode. Press again to change between Analog RGB and DVI mode.

6. VIDEO button

Shortcut to access the composite video, S-video, Y/C_B/C_R and Y/P_B/P_R mode. Press repeatedly to circle through the selections.

7. NTSC button

Press to switch directly to the NTSC mode. Also can press CH+/- buttons to switch to NTSC mode.

HOW TO USE THE REMOTE TO CONTROL YOUR PLASMA TV

8. DTV button

Press to switch directly to DTV mode.

9. NUMBER buttons

Use Number buttons to choose specific channel. For example when choose channel 27, first press 2 and then press 7. When choose 101, first press +100 and 0, then press 1.

10. RETURN button

Press this button to toggle between the current and last channel viewed and press jump back to last page of OSD.

11. EXIT button

This button will exit all On-Screen Displays.

12. MENU button

The MENU button will start the OSD.

13. • • • ◀ ▶ buttons

Press Up/Down/Left/Right buttons to adjust the options under OSD menu.

14. SEL button

Press SELECT button to select the functions under OSD menu.

15. CHANNEL+/- buttons

Press Channel +/ Channel - buttons to change channels under TV mode.

16. VOLUME+/- buttons

Press Vol+ / Vol- buttons to increase and decrease the volume.

17. DTV MENU button

Press to access DTV OSD menu for features adjustment.

18. BACK button (for DTV mode only)

In viewing mode or in the Channel Banner, toggles between the current and previous channel within the same channel list. In the menu, returns to the previous screen.

19. OK button (for DTV mode only)

In viewing mode, brings up the current Channel List and the Channel Banner. In the menu, selects the currently highlighted menu item or confirms your choices.

20. FAV CHANNEL button (for DTV mode only)

Press to switch directly to your favorite channel.

21. INFO button (for DTV mode only)

Switch between Viewing mode, Channel Banner, and Channel Banner with Extended Info.

22. PC ADJ. button (not available for 480p/720p/1080i signals)

When the image is not even or not in the center of the screen under PC mode, press this button for auto adjustment.

23. FREEZE button

Freeze button allows user to temporarily pause current image. Press to freeze the image. Press again to restore the picture.

24. C.C button

Press to switch directly to open close caption function.

HOW TO USE THE REMOTE TO CONTROL YOUR PLASMA TV

25. ASPECT button

Press repeatedly to change image to different aspects. Aspects include 4:3 STANDARD, 4:3 EXPANDED, 4:3 ZOOM1, 4:3 ZOOM2, 16:9 STANDARD, 16:9 ZOOM.

Depending on the input signal format received, the picture format ratio allows you to adjust the images through the following options.

4:3 STANDARD	Use this aspect mode to display conventional (4:3) images. Side panels (gray areas) are placed to the left and right of the image to preserve the original aspect ratio of the source. Note: Use this mode for only 15% of your total viewing time to prevent uneven aging of the phosphors. Phosphors in the lighted area of the picture will age more rapidly than the gray areas.
4:3 EXPANDED	Use this aspect mode to display conventional (4:3) sources by linearly increasing image expansion from the center towards the edges of the display area in order to fill it.
4:3 Zoom1/Zoom2	Use these aspect modes to zoom in on conventional (4:3) sources.
16:9 STANDARD	Use this aspect mode to display 16:9 sources like HDTV and DVD's preserving the original 16:9 aspect ratio.
16:9 Zoom	Use this aspect to Zoom-in once while in 16:9 aspect.

(1) NTSC/480i/480P Input

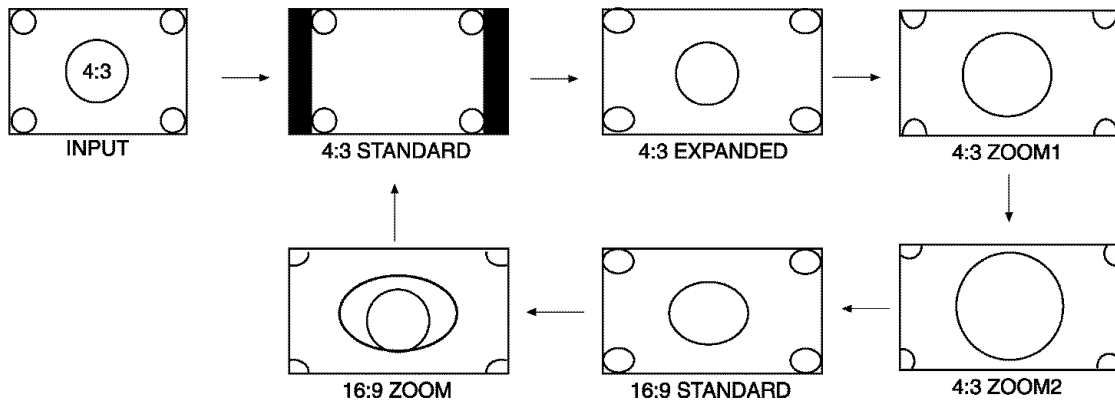

(2) 480i/480P Input

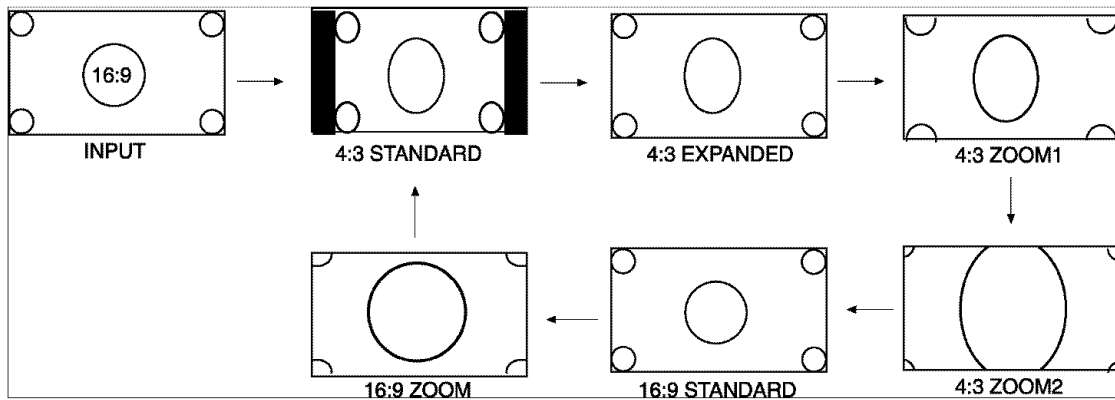

(3) 720P/1080i Input

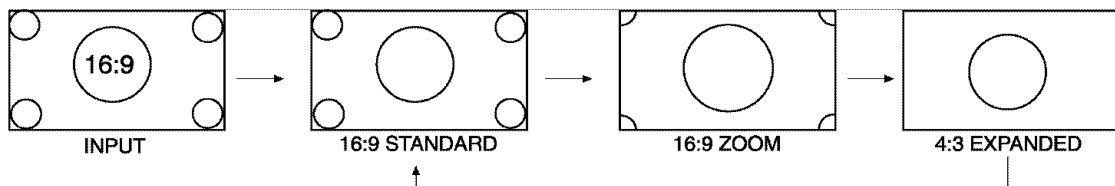

(4) RGB Input

Auto adjust to full size. (Aspect ratio is not changeable.)

HOW TO USE THE REMOTE TO CONTROL YOUR PLASMA TV

26. P. MODE button

Press to select standard, movie and dynamic picture mode. Press repeatedly to circle through the selections.

27. ZOOM +/- buttons

Zoom in on the image by pressing Zoom + button and press Zoom – button to zoom out.

28. MTS button (for DTV: Multi Language mode)

Press MTS button to select Mono, Stereo, and SAP (Second Audio Program) under TV mode.

29. PIP SWAP button

Press to exchange the main video signal source with PIP video signal source.

30. PIP INPUT button

Activate PIP by pressing PIP Input button to select desired video input. To turn off PIP by keep pressing PIP Input button until the PIP window disappear. PIP source cannot be the same with main video source. (PC & Component are not accessible to PIP)

Main \ Sub	NTSC	DTV	Composite & S-Video	Component (480i)	DVI	Analog RGB
NTSC		○	○	○	○	○
DTV	○		○	○	○	○
Composite & S-Video	○	○		○	○	○
Component(480i)	×	×	×		×	×
DVI	×	×	×	×		×
Analog RGB	×	×	×	×	×	

NOTES - For changing TV channel under PIP function

- One TV source (NTSC or DTV) in main picture or sub picture:
Press directly channel+/-, number and return buttons on remote control to change the channel.
- NTSC and DTV sources in main picture and sub picture:
Press recall button to display the audio source info. After select the audio source to the mode you want to change, press channel+/-, number and return buttons on remote control to change the channel.

31. SLEEP button

Press the sleep button repeatedly to set the sleep timer to 30, 60, 90, and 120 minutes.

OSD (On-Screen Display)

USING THE ON-SCREEN DISPLAY (OSD) CONTROLS

1. Press MENU on the remote control to display the different features on your HITACHI Plasma TV.
2. Use the **• • ◀ ▶** to navigate to different menu item.
3. Use the **◀ ▶** to adjust functions.
4. Press SEL on the remote control to select functions.
5. Press EXIT on the remote control to quickly exit from a menu.

THERE ARE TWO DIFFERENT MODES FOR THE OSD ARE THE FOLLOWING:

Audio/Video Mode: Displays when the TV, Composite, S-video, Y-C_BC_R or Y-P_BP_R is selected.

PC Mode: Displays when the Analog RGB or DVI input is selected.

Audio/Video Mode

Video	Picture Mode
	Brightness
	Contrast
	Color
	Tint
	Sharpness
	Color Temperature
	Reset
Image	Aspect
	Border Color Setting
	Noise Reduction
	3:2 Pull Down
Audio	Mute
	Volume
	Treble
	Bass
	Balance
	SRS WOW
	Subwoofer
Language	Language
System	Signal Format
	Advanced
	PIP Set
	V-Chip
	Closed Caption
	TV Channel Setup
	System Reset

PC Mode

Video	Brightness
	Contrast
	H Position
	V Position
	Color Temperature
	Reset
Image	Auto Adjust
	Clock Phase
	Horizontal Clock
Audio	Mute
	Volume
	Treble
	Bass
	Balance
	SRS WOW
	Subwoofer
Language	Language
System	Signal Format
	PIP Set
	Advanced
	Power Save
	System Reset

OSD (On-Screen Display)

Video

Adjusts the picture mode, brightness, contrast, color, tint, sharpness, color temperature and position of your display.

Audio/Video Mode

Video	Function	Options
Picture Mode	Select a preset customized picture setting.	- Natural - Cinema - Dynamic
Brightness	Adjusts the darkness and lightness of the display.	0 to 100
Contrast	Adjusts the color brightness of the display.	0 to 100
Color	Adjusts the saturation level of color.	0 to 100
Tint	Adjusts the color properties.	0 to 100
Sharpness	Adjusts the clarity of images.	0 to 31
Color Temperature	Adjusts the level of the color temperature.	- Cool - Natural - Warm - Black & White - User
Reset	Puts all of your display settings back to their default.	

PC Mode

Video	Function	Options
Brightness	Adjusts the darkness and lightness of the display.	0 to 100
Contrast	Adjusts the color brightness of the display. (Not available for DVI/480p/720p/1080i signals)	0 to 100
H Position	Moves image to the left or right. (Not available for DVI/480p/720p/1080i signals)	0 to 100
V Position	Moves image up or down. (Not available for DVI/480p/720p/1080i signals)	0 to 100
Sharpness	Adjusts the clarity of images. (Available for 480p/720p/1080i signals)	0 to 31
Color Temperature	Adjusts the level of the color temperature.	- Cool - Natural - Warm - Black & White - User
Reset	Puts all of your display settings back to their default.	

OSD (On-Screen Display)

Image

Adjust scaling, auto adjust, border color set, noise reduction, 3:2 pull down, clock phase and horizontal clock.

Audio/Video Mode

Image	Function	Options
Scaling (Please see "ASPECT" on page 23 for more information.)	Select the screen sizes.	- 4:3 standard - 4:3 expanded - 4:3 Zoom1 - 4:3 Zoom2 - 16:9 standard - 16:9 zoom
	Select the screen sizes. (Available for 720p/1080i signals.)	- 4:3 expanded - 16:9 standard - 16:9 zoom
Border Color Setting	Select the border color when display 4:3 video.	- Black - Gray
Noise Reduction	Provide 3 models for reducing video noise. (Not available for YP _B PR/DTV signals)	- Off - Level 1 - Level 2 - Level 3
3:2 Pull Down	Improve the picture quality. (Not available for YP _B PR/ATSC signals)	- Disable - Enable

PC Mode (not available for DVI signal)

Image	Function	Options
Auto Adjust	Automatically detects video format. (not available for 480p/720p/1080i signals)	Auto
Clock Phase	Video timing adjustment.	0 to 31
Horizontal Clock	Moves image left and right.	0 to 100

OSD (On-Screen Display)

Audio

Adjusts the mute, volume, treble, bass, balance, SRS WOW and Subwoofer of your sound.

Audio	Function	Options
Mute	Turns off the sound.	Enable or disable
Volume	Increases and decreases the level of sound.	0 to 63
Treble	Increases and decreases the level of treble.	-16 to +16
Bass	Increases and decreases the level of bass.	-16 to +16
Balance	Adjusts the left and right sound level.	-16 to +16
SRS WOW	Turns SRS WOW function on and off.	On or Off
Subwoofer	Turns Subwoofer function on and off.	On or Off



SRS WOW is an audio enhancement technology from SRS Labs that provides deep, rich bass on any speaker system without the need for a subwoofer or additional extra physical components. For systems with a subwoofer, SRS WOW complements and enhances the bass performance. This feature can be set to On or Off.

NOTES: WOW, SRS and the  symbol are trademarks of SRS Labs, Inc. SRS WOW technology is incorporated under license from SRS Labs, Inc.

English



Language

Adjusts the language and shades of red, green and blue.

Language	Function	Options
Language	Set the language for the OSD.	- English - French - Spanish

OSD (On-Screen Display)

System

Adjusts the screen format, and PIP settings.

Audio/Video Mode

System	Function	Options
Signal Format	Displays video signal information.	
Advanced	Adjusts the gamma and move screen function.	- Gamma: 0.8, 1.0, 1.2, or 1.4 - Move Screen Mode: Off, Mode 1 or Mode 2 - Move Screen Time: 5~255 sec
PIP Set	Adjust the PIP source, position, audio source, and display.	- Size: Off, Small, Medium, Large - Source: AV, SV, TV, DTV - Position: Nine different positions. - Audio Source: Select between the sound of your main picture or PIP. - PIP Display: Adjust the brightness, contrast and color. - Swap: Switches your main picture and PIP. - V-Chip: See "Setting up the V-chip" on page 30.
V-Chip	Requires a password to be entered to view movies and TV programs with unsuitable ratings for some viewers who share the TV.	See "Setting up the V-chip" on page 30.
Closed Caption	Displays text.	See "Setting up the Closed Caption" on page 31.
TV Channel Setup	Choose a TV source, performs an automatic channel search, add and delete channels.	TV Source: Air or CATV Channel Auto Search: Scans channels 1 to 125 for a signal and Add or erase channel. See "Setting Up The TV Channels" on page 31.
System Reset	Sets OSD back to default settings.	

PC Mode

System	Function	Options
Signal Format	Displays RGB signal information.	
PIP Set	Adjust the PIP source, position, audio source, and display.	- Size: Off, Small, Medium, Large - Source: AV, SV, TV, DTV - Position: Nine different positions. - Audio Source: Select between the sound of your main picture or PIP. - PIP Display: Adjust the brightness, contrast and saturation.
Advanced	Adjusts the white pattern and gamma.	- Gamma: 0.8, 1.0, 1.2, or 1.4 - Move Screen Mode: Off, Mode 1 or Mode 2 - Move Screen Time: 5~255 sec
Power Save	Turns Display Power Management System on and off.	On or Off
System Reset	Sets OSD back to default settings.	

SETTING UP THE V-CHIP

V-Chip

The V-chip feature requires a password to be entered to view movies and TV programs with unsuitable ratings for some viewers who share the TV.

Follow these steps to lock movies and TV programs:

1. Press the MENU button on the remote control to bring up the OSD menu.
2. Continue to press the ▼ button until the System icon is highlighted and press the SEL button to show the system functions.
3. Use the ▲▼ buttons to highlight V-chip, and then press the SEL button.
4. Enter 1, 1, 1, 1, 1, 1 as the default password to gain access.
5. Use the following table to set up your V-chip.

V-chip	Function	Options
TV Guidelines Blocking	Blocks selected TV-rating and all ratings below it.	TV-Y, TV-Y7, TV-G, TV-PG, TV-14, TV-MA, TV-Rating
MPAA Rating	Blocks selected MPAA rating and all ratings above it.	G, PG, PG-13, R, NC-17, X, NR
Change Password Number	Enter a new password.	

English



TV Guidelines Blocking

Ratings	Age-defined	Contents of TV Guidelines						
		Show	Block					
TV-Y	Young children	Show	Block					
TV-Y7	Children 7 and over	Show	Block	*FV				
TV-G	General audience	Show	Block					
TV-PG	Parental guidance suggested	Show	Block		*V	*S	*L	*D
TV-14	Viewers 14 and over	Show	Block		*V	*S	*L	*D
TV-MA	Mature audience only	Show	Block		*V	*S	*L	
TV-Rating	Rating Off	Select this function, all ratings change to show						

*FV: Fantasy or cartoon violence

V: Violence

S: Sexual content

L: Offensive language

D: Dialogue (sexual innuendo)

MPAA Rating

Ratings	Age-defined
G	General audience (no restrictions)
PG	Parental guidance suggested
PG13	Parents strongly cautioned
R	Restricted. Children under 17 should be accompanied by an adult
NC-17	No Children under 17
X	Adults only
NR	NOT RATED (NR). Contains no rating. Not Rated (NR) and Not Applicable (NA) programs.

Change Password Number

To change password, enter the Change Password Number option in the V-Chip function, press SEL button to change password. Enter six digital password in enter new password number. And then confirm the password by entering the same password again.

NOTE: If you forget the password, enter 1, 6, 8, 1, 6, 8 to erase the password.

SETTING UP THE CLOSED CAPTION

Closed Caption

For some TV programs, PDP has the de-coding and "Close Caption" functions. This caption is usually served for the deaf or the foreign language translation. All VCRs can record Close Caption signals from TV programs, so videos will also show the "Close Caption" function.

Follow these steps to use closed caption function:

1. Press the MENU button on the remote control to bring up the OSD menu.
2. Continue to press the ▼ button until the System icon is highlighted and press the SEL button to show the system functions.
3. Use the ▲▼ buttons to highlight Closed Caption, and then press the SEL button.
4. Use the following table to set up your Closed Caption.

Closed Caption	Function	Options
Closed Caption	Select the CC mode or close the CC function.	Off, CC1, CC2, TT1, TT2
CC Background	Select the CC background color when display.	Transparent, Black

SETTING UP THE TV CHANNELS

TV Channel Setup

Use the TV Channel Setup feature to set up your channels. The Channel Auto Search scans channels 1 to 125 and adds the channels that return a signal. You also can use the Channel Edit feature to add and remove channels that fit your preference.

Use the following steps to set up your TV channels:

1. Press the MENU button on the remote control to bring up the OSD menu.
2. Continue to press the ▼ button until the last icon System is highlighted and press the SEL button to show the system functions.
3. Use the ▲▼ buttons to highlight the TV Channel Setup function, and then press the SEL button to view the options.
4. Select first icon TV Source to choose Air or CATV as your input source.
5. Press the ▼ button once to highlight Channel Auto Search, and then press the SEL button to begin the search. Channels 1 to 125 are scanned and the channels that return a signal are added to your channel list.
6. Press the EXIT button on your remote control to return to your TV display.

Use the following steps to add and remove channels:

1. Press the MENU button on the remote control to bring up the OSD menu.
2. Continue to press the ▼ button until the last icon System is highlighted and press the SEL button to show the system functions.
3. Use the ▲▼ buttons to highlight the TV Channel Setup function, and then press the SEL button to view the options.
4. Press the ▼ button until Channel Edit is highlighted.
5. Use the number buttons to select a channel to add or erase.
6. Use the ◀▶ buttons to highlight Add or Erase. Press the SEL button to add or erase the current channel.
7. Press the EXIT button on your remote control to return to your TV display.

TV Channel Setup	Function	Options
TV Source	Select your TV input source.	Air, CATV
Channel Auto Search	Automatically search scan TV channel from 1 to 125	Auto
Channel Program	Memorize channel	
Channel Edit	To add or erase the channel	Erase, Add

ATSC(Advanced Television System Committee) INTRODUCTION

Terrestrial broadcast is a traditional way of watching TV programs, simply by installing an outdoor YAGI antenna or an indoor rabbit ear antenna, plugging it into the TV set's tuner, tuning channel, then you can enjoy watching the programs. However, they are all so called "analog TV".

In recent years, "digital TV" arises and most countries' governments have begun to mandate a TV Transition from the old analog TV broadcast system to digital TV broadcast system. Digital TV brings viewer greater entertainment in terms of a noise free High Definition picture quality and Dolby AC-3 sound effect. 16:9 video format gives a wider view of the same program compared with traditional 4:3 format. In the near future terrestrial data broadcast will create a complete digitized world in every family. Many terrestrial TV broadcaster at this moment are delivering digital TV programs, when the time of government mandated transition deadline comes, all the analog TV transmissions have to give way to digital, which makes the ZAT series digital terrestrial HDTV receivers a wise investment now.

Digital TV programs are broadcasted on both VHF and UHF radio frequency bands. Traditional analog TV transmission uses one radio frequency channel for carrying one TV station's programs, in the digital TV transmission one radio frequency channel can carry up to four more TV station's programs. For instance, the original analog channel CBS you used to watch now may have become 2-1,2-2,2-3,2-4 when it's broadcasted in digital, here we call 2 as the major channel and -1, -2, -3 and -4 are sub-channels. These four sub-channels usually come from the same TV station and show four different programs at the same time.

Digital TV signals are transmitted in either Free-to-Air (FTA) mode or Pay-per-View (PPV) mode. FTA signals can be received free by anyone with MPEG 2-ATSC compliant digital terrestrial receiver, such as the ZAT series, whereas the PPV programs can only be received by paying an access fee to the broadcaster and using a Digital receiver incorporating compatible conditional access system. The receiver allows you to watch HDTV, EDTV and SDTV digital TV programs.

*HDTV stands for High Definition Television; its common video formats are "1920 x 1080 interlaced" or "1280 x 720 progressive".

*EDTV stands for Enhanced Definition Television; its common video format is "720 x 480 progressive".

*SDTV stands for Standard Definition Television; its common video format is "720 x 480 interlaced".

ATSC RECEIVER FUNCTIONS

The Digital Terrestrial HDTV Receiver opens up a new world of free-to-air terrestrial HDTV and SDTV programming. The receiver can receive channels from both VHF band and UHF band TV station's signals. All the major terrestrial free-to-air station numbers currently available in your area are listed in the on-screen menu. To watch the channel simply by selecting the channel number and you will be accessing a wide range of local high quality digital programming.

The receiver is fully ATSC / MPEG-2 (digital video broadcast-terrestrial) compliant, delivering High Definition crystal-sharp video and Dolby AC-3 sound. It supports a radio signal range from 50-860 MHz, so can be easily programmed for all the channels within the VHF and UHF frequency bands. It can receive major and sub-channels containing both video and audio programs.

These receivers have the capability of receiving hundreds of channels simply by selecting alternate TV channel frequencies in your area. To find out the specific digital TV services available to you, please contact your local service provider or log onto the website "<http://www.antennaweb.org>". With the wide range of features and terrestrial HDTV programming opened up to you by ZAT series digital terrestrial receivers, prepare yourself for a new era in home theater entertainment.

SETTING UP YOUR DTV

1. Make sure the physical connection is properly connected.
2. Switch on the TV.
3. Select the appropriate external video input on your TV by using the TV remote control.
4. If the PDP is moved to a different location. You should reset the receiver and do the channel scanning all over again.

USING THE DTV ON-SCREEN DISPLAY (OSD) CONTROLS

1. Press DTV MENU on the remote control to display the MENU banner.
2. Use the ▲▼◀▶ to navigate to different menu item.
3. Use the ◀▶ to adjust functions.
4. Press OK on the remote control to select functions. Press BACK to jump back the last page of menu.
5. Press EXIT on the remote control to quickly exit from menu.

Channel	Enter Password	Edit, Auto Scan, Manual Scan
Caption	Font Size	Default, Small, Middle, Large
	Font Style	Default, Style0~7
	Font Color	Background, Foreground
	Font Opacity	Background, Foreground
	Edge Style	Default, None, Raised, Depressed, Uniform, Drop_Shadow(L), Drop_Shadow(R)
	Edge Color	Default, Gray, Blue, Red, Green, Cyan, Yellow, Dark
Setup	Sound	PCM/ Dolby Digital
	Opacity	0%~100% adjustment
	I-Plate	Display Time
	Time Zone	Time Format, Time Adjustment
	About	HW & SW version
Lock	Enter Password	Rating, Password, Reset Default

Channel

Before you can use any of the channel buttons (CH +/–, FAV. CH, Numbers), the available channels must first be scanned and memorized.

Auto Scan



Initial Screen –

The first time the receiver is powered on. You will see a message block of “Press (Menu) key and then select Channel to run Auto / Manual Scan”.



1. Press the DTV MENU button to display the MENU banner.
2. Use the arrow keys ◀ or ▶ to move highlight CHANNEL and enter default password “0000” to show three sub-menus

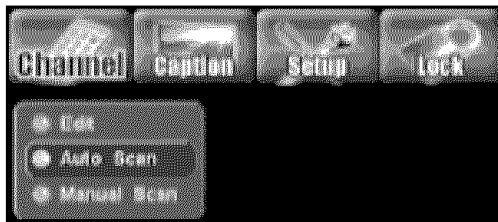

3. Press ▲ or ▼ buttons to highlight the AUTO SCAN, and then press OK to launch the auto scan. An AUTO-SCAN window will show the SCAN status.

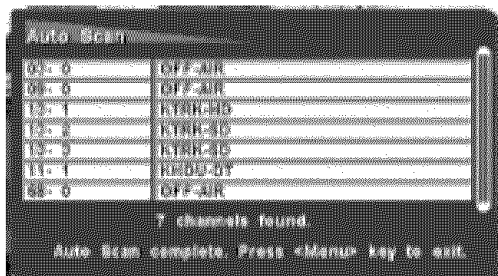

4. Once the digital TV signal is scanned, the channel number and program name will be shown on the “Scan List”.
5. Scanning will end up on channel 69, when it is complete (even in processing) you can press EXIT key to leave this window and enjoy watching DTV programs.

SETTING UP YOUR DTV

Manual Scan

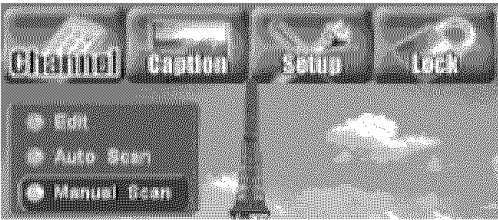

1. On the Channel menu page, select the third item MANUAL SCAN.

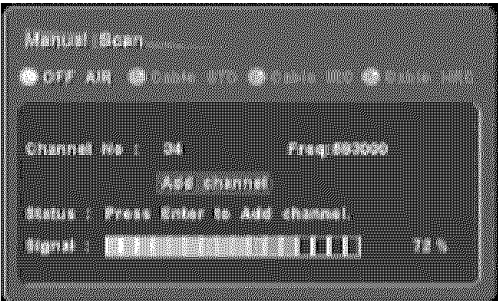

2. Press ◀ or ▶ to highlight the input column. Then press numeric buttons to input the channel number. The channel frequency will be automatically showing on right side of the input column.

3. Press OK button when the message “Add channel” and “press Enter to add channel” has shown.

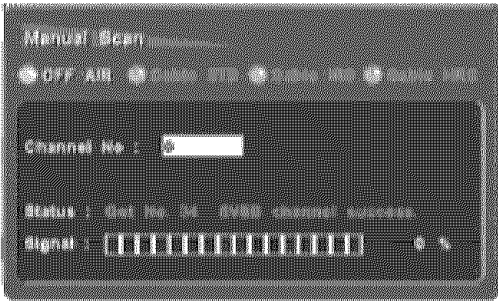

4. If the ATSC signal is found and locked, the Status will show message “Get No. XX 8VSB channel success”. Then you can press EXIT to leave the menu page and watch the program, or go ahead scanning the other channels.

5. If the signal is not locked, the status will show “Got No Channel”. You can scan the signal again or refer to the signal level bar “Signal” for aligning the direction of the antenna to get the signal.

6. When the signal is locked and the receiver is on the channel, you can enter into this page to check the signal level.

Note: It's suggested that you to contact the antenna Installer when you have to trouble of locking the signal.

Edit

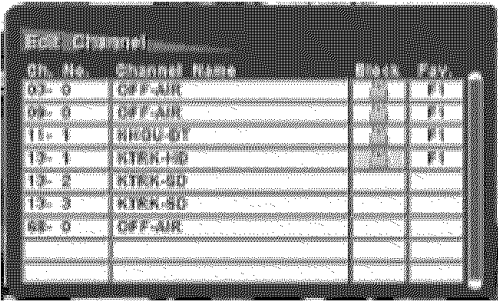

1. On the Channel menu page, select the first item EDIT.

2. Press ▲▼ and ◀▶ buttons to highlight the channel's BLOCK or FAV control column and press OK to block channel or copy channel into the favorite channel list “F1”.



3. After the edit setting, press the EXIT button, then will pop up a confirmation window: choose “NO” to cancel the edit change; choose “YES” to save the edit settings.

Note: When the blocked channel has selected, the program can not be showed, and you will get the message “Channel is blocked” from TV

SETTING UP YOUR DTV

Caption

Adjust the font size, style, color and opacity of Closed Caption.

Caption	Function	Options
Font Size	Adjust the font size of Closed Caption	Default, Small, Middle, Large
Font Style	Adjust the font style of Closed Caption	Default, Style0~7
Font Color	Adjust the background and foreground color of Closed Caption	Background, Foreground
Font Opacity	Adjust the background and foreground opacity of Closed Caption	Background, Foreground
Edge Style	Adjust the edge style of Closed Caption	Default, None, Raised, Depressed, Uniform, Drop_Shadow(L), Drop_Shadow(R)
Edge Color	Adjust the edge color of Closed Caption	Default, Gray, Blue, Red, Green, Cyan, Yellow, Dark

Setup

Select the sound, opacity, I-Plate, time zone mode and check the hardware and software version.

Setup	Function	Options
Sound	Change the sound mode	PCM/ Dolby Digital
Opacity	Change the percentage of the OSD's transparency	0%~100% adjustment
I-Plate	Change the Information-Plate display time	2 secs, 4 secs, 6 secs, Off
Time Zone	Change time display format and adjust the time zone	Time Format, Time Adjustment
About	Check the hardware and software version	

Lock

Requires a password to be entered to view movies and TV programs with unsuitable ratings for some viewers who share the TV.

Rating

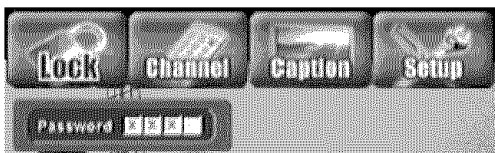

1. Press the DTV MENU button to display the MENU banner.

2. Use the arrow keys ◀ or ▶ to move highlight LOCK and enter default password "0000" to show three sub-menus

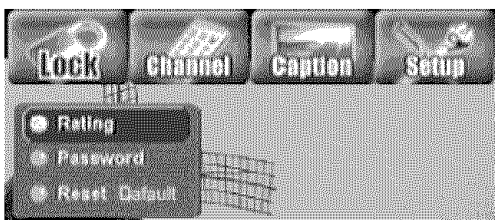

3. Press ▲ ▼ buttons to highlight the "Rating", and then press OK to into the rating control menu.

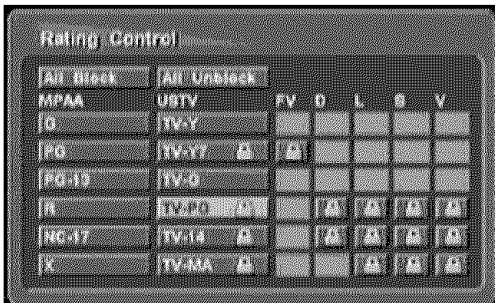

4. This menu lists both MPAA and USTV (FCC) Parental ratings. You can independently lock the MPAA and TV ratings. The locked ratings are indicated by the lock symbol.

5. Press ▲ ▼ and ◀ ▶ buttons and the OK button to activate the appropriate restrictions for either MPAA rating system or USTV(FCC) rating system.

6. When it is complete (even in processing) you can press EXIT key to leave this window and enjoy watching DTV programs.

- NOTES:**
1. When the rating locked channel has selected, the program cannot be showed and you will get the message "**Program is rating blocked**" from TV screen.
 2. Explanation of the MPAA and TV (FCC) Rating Systems, please check "TV Guidelines Blocking" and "MPAA Rating" on page 30.

SETTING UP YOUR DTV

Change Password

To change password, enter the Change Password Number option in CHANGE PASSWORD function, press OK button to change password. Enter four digital password in enter new password number. And then confirm the password by entering the same password again.

- NOTES:**
1. Before you change the password, uses the default password "0000" to enter the Menu item which requires the password.
 2. If you forget the password, please use the password "1688" to enter.
 3. To enter the new password, and follow the instruction.

Reset Default

This function allows to reset receiver back to factory default status.



1. Press ▲▼ buttons to highlight the "Reset Default", and then press OK to into the rating control menu.
2. There will pop up the RESET confirmation message "Press Yes will reset default to default value". Press OK on "Yes" to process. Press OK on "NO" to cancel the setting.

CLOSED CAPTION

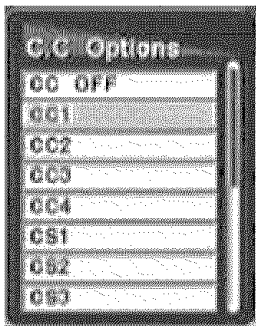

1. When you learn from the I-PLATE that there is Closed Caption data on the current channel, you can press CC button on the remote control to display C.C. Option list it on the TV screen.
2. Use ▲ and ▼ keys to highlight the desired CC signal and press OK button.
3. After the type of Closed Caption has selected, press EXIT or CC key to cancel the CC Option list, then you can watch this Digital TV program with Closed Caption.

FAVORITE CHANNEL LIST

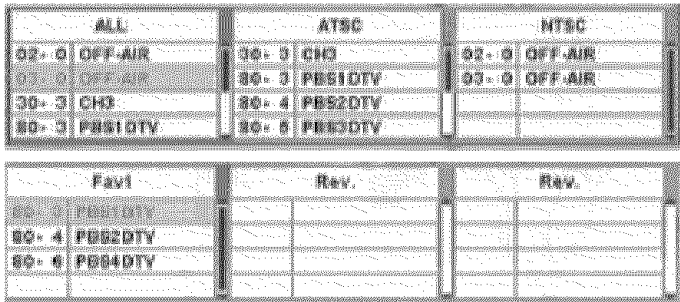

1. When you are watching terrestrial or cable TV channels, you can press "FAV" button on the remote control to call up the Favorite List.
2. Use ◀ and ▶ keys to navigate "ALL", "ATSC", "NTSC" and "FAV" program lists.
3. Use ▲ and ▼ keys to browse through the selected program lists and highlight the program you like to watch, then press OK button.

- NOTE: Press Numeric Key to Select Digital Channel**
- For the digital channel number is different with the traditional NTSC channel number. Please follow below indication to select the digital channel if you prefer to use numeric key to do the channel selection.
- Example: digital channel number: 10 - 2
1. press numeric key "1" and "0"
 2. press "▶" buttons
 3. press numeric key "2"

CARE OF YOUR HITACHI PLASMA TELEVISION AND YOUR REMOTE CONTROL

DO

Dust the screen and frame with a cleaning cloth from the accessories pack.

Clean the screen and frame with a soft cloth moistened in warm water and dry with a soft cloth. A mild soap may be used if the screen is extremely dirty.

Place your Plasma Television away from extreme heat, humidity, and extremely dusty places.

Remove the plug from the wall outlet if your Plasma Television will not be used for a long period of time, for instance, when you go on vacation.

DO NOT

Do not clean your screen with strong cleaners, polishes or a chemically treated cloth.

Do not place rubber or vinyl products or cellophane tape on your Plasma Television.

Avoid repeatedly touching the screen.







Do not subject the remote control to shocks such as dropping it on the floor, etc. This may cause physical damage to the precision parts.

Avoid placing the remote control in a high humidity place or getting it wet. Do not leave it on or near a heater. Excessive heat or moisture may cause the remote control unit to fail.

When the batteries run down, remote control operation will become erratic or become unresponsive. Replace the old batteries with two new "AAA" size batteries. Do not use an old battery with a new battery.

Exposing the screen to direct sunlight for a long period of time or heat may cause damage to the plasma screen.

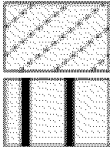
RECEPTION PROBLEMS

	<p>• IGNITION NOISE: Black spots or horizontal streaks may appear, picture may flutter or drift. Usually caused by interference from automobile ignition systems, neon lamps, electrical drills, and other electrical appliances.</p>
	<p>• GHOSTS: Ghosts are caused by the television signal following two paths. One is the direct path and the other is reflected from tall buildings, hills or some other objects. Changing the direction or position of the antenna may improve reception. Ghosting may also be caused by defects in the antenna system such as unshielded leads or connecting several sets to the same antenna without using multiple antenna couplers.</p>
	<p>• SNOW: If your receiver is located in the fringe area of a television station where the signal is weak, your picture may be marred by the appearance of small dots. When the signal is extremely weak, it may be necessary to install a special antenna to improve the picture.</p>
	<p>• RADIO FREQUENCY INTERFERENCE: The interference produces moving ripples or diagonal streaks, and in some cases, causes loss of contrast in the picture.</p> <p>• PREVENTION OF AN OBSTACLE TO RADIO RECEIVERS This monitor has been designed pursuant to the FCC class B Rules. This is to prevent a problem to Radio receivers. If this monitor causes a problem to Radio receivers, then take the following steps: - Keep the monitor away from Radio. - Adjust Radio antennas in order for the monitor not to receive interference. - The antenna cable of Radio should be kept away from the monitor. - Use a coaxial cable for antenna.</p> <p>You can check if this monitor influences Radio receivers by turning off all other equipment other than the monitor. If you find a problem receiving Radio when using the monitor, check the instructions mentioned above.</p>
<p>• The display image appears scrolling diagonal. • Text displayed across the screen appears vertically streaked, with the characters in vertical columns blurred.</p> 	<p>• Adjust the horizontal clock and clock phase. (Adjust the horizontal clock first, the clock phase next.) (RGB input)</p>
<p>• Text displayed across the screen appears blurred. • A fine pattern flickers when displayed on the screen.</p> 	<p>• Adjust the clock phase for the clearest viewing. (RGB input)</p>
<p>• Vertical stripes appear, depending on the screen contents.</p>	<p>• The plasma display panel is lighting the phosphors by the discharge of internal radiation. Depending on the screen contents, in rare cases this may cause vertical stripes to appear because of failure to light. Please note that this is not a malfunction.</p>
<p>• Coarse horizontal stripes appear in FULL display.</p>	<p>• Adjusting the clock phase will reduce the horizontal stripes. (RGB input)</p>
<p>• The display dims to make the picture invisible during special playback of a VCR (FF, REW).</p>	<p>• This condition may occur when the unit is connected to a VCR with component output, such as 480i, but it is not a failure. But when it occurs, switch to composite output.</p>

USEFUL INFO

SYMPTOMS	CHECK THESE ITEMS AND TRY THESE ADJUSTMENTS											
	Be sure external connection is correct	Be sure power cord is plugged in	Be sure TV is switched "ON"	Try another channel (station trouble)	Check antenna connections (back of TV)	Check antenna for broken lead-in wire	Check outside antenna	Adjust Contrast control	Adjust Brightness control	Adjust Color control	Adjust Tint control	Adjust Volume control
No Picture, no sound	●	●	●	●	●	●	●					
Sound OK, picture poor	●			●	●	●	●	●	●			
Picture OK, sound poor	●			●	●	●	●	●				●
Picture blurred	●			●	●	●	●	●				
Lines or streaks in picture				●	●	●	●	●				
Poor reception on some channels				●	●	●	●	●				
Picture rolls vertically				●				●				
No color	●			●	●	●	●			●		
Poor color	●			●	●	●	●			●	●	

PLUG and PLAY



This Plasma Television complies with VESA DDC2B specifications, Plug & Play is a system with computer, peripherals (including monitors) and operating system. It works when the monitor is connected to a DDC ready computer that is running an operating system software that is capable for the plug & play. When a Plug and Play PC is powered on, it sends a command to the Monitor requesting identification. The Monitor sends back a string of data including its characteristics.

TRADEMARK ACKNOWLEDGMENT

DDC™ is a trademark of Video Electronics Standard Association.
IBM PC/AT and VGA are registered trademarks of International Business Machines Corporation of the U.S.A.
Apple and Macintosh are registered trademarks of Apple Computer, Inc.
VESA is a trademark of a nonprofit organization, Video Electronics Standard Association.

This Class B digital apparatus meets all requirements of the Canadian Interference-Causing Equipment Regulations.
This Class B digital apparatus complies with Canadian ICES-003.
Cet appareil numérique de la classe B est conforme à la norme NMB-003 du Canada.

Cable Compatible Television Apparatus- Télévision câblocompatible, Canada.

NOTE: This Plasma Television will display television closed captioning, ( or ), in accordance with paragraph 15.119 of the FCC rules.

USEFUL INFO

AGENCY REGULATORY INFORMATION

Federal Communications Commission Notice

This equipment has been tested and found to comply with the limits for a Class B digital device, pursuant to Part 15 of the FCC Rules. These limits are designed to provide reasonable protection against harmful interference in a residential installation. This equipment generates, uses and can radiate radio frequency energy and if not installed and used in accordance with the instructions, may cause harmful interference to radio communications. However, there is no guarantee that interference will not occur in a particular installation. If this equipment does cause harmful interference to radio or television reception, which can be determined by turning the equipment off and on, the user is encouraged to try to correct the interference by one or more of the following measures:

- Reorient or relocate the receiving antenna.
- Increase the separation between the equipment and the receiver.
- Connect the equipment into an outlet on a circuit different from that to which the receiver is connected.
- Consult the dealer or an experienced radio/television technician for help.

Modifications

The FCC requires the user to be notified that any changes or modifications made to this device that are not expressly approved by Hitachi Home Electronics (America), Inc. may void the user's warranty.

Cables

Connections to this device must be made with shielded cables with metallic RFI/EMI connector hoods to maintain compliance with FCC Rules and Regulations.

Any cables that are supplied with the system must be replaced with identical cables in order to assure compliance with FCC rules. Order Hitachi spares as replacement cables.

Declaration of Conformity

This device complies with Part 15 of the FCC Rules. Operation is subject to the following two conditions: (1) this device may not cause harmful interference and (2) this device must accept any interference received, including interference that may cause undesired operation.

For questions regarding this declaration, contact:

Hitachi America, LTD.
Home Electronics Division
900 Hitachi Way
Chula Vista, CA 91914-3556
Tel. 1-800-448-2244 (1-800-HITACHI)
ATTN: CUSTOMER RELATIONS

USEFUL INFO

Features:

- New Easy-to-Use On-Screen Menu Control (3 Language)
- FilmMode Processing with 3:2 & 2:2 pull down
- Integrated ATSC Tuner
- Adjustable Color Temperature
- PIP
- Picture Enhancement
- Input Signal Identification
- Noise Reduction

Video:

- 1024 x 1024 Display Resolution
- High-Contrast Pure-Color Glass Shield
- Wide Viewing Angle: More than 160°
- 4 Color Temperature Presets: Cool, Natural, Warm, Black&White and User.
- Multiple Screen Fill Modes (4:3 Standard, 4:3 Expanded, 4:3 Zoom1, 4:3 Zoom2, 16:9 Standard, 16:9 Zoom)
- 3D Y/C Comb Filter
- Picture Modes (Natural, Cinema and Dynamic)
- Computer Display: VGA, (SVGA, XGA)

Inputs:

- Power Input AC 120V, 60Hz
- Antenna input impedance 75 Ohm
- Channel coverage 191ch.
 - VHF-Band 2 ~ 13
 - UHF-Band 14 ~ 69
 - CATV Mid Band A-5 ~ A-1
 - A-I
 - Super Band J-W
 - Hyper Band W+1 - W+28
 - Ultra Band W+29 - W+94
- Video 1.0Vp-p, 75 Ohm
- S-Video
 - Luminance (Y) 1.0Vp-p, 75 Ohm
 - Chrominance (C) 0.286Vp-p, 75 Ohm
- Component Video
 - Luminance (Y) 1.0Vp-p, 75 Ohm
 - Chrominance (PB/PR) 0.7Vp-p, 75 Ohm
- Audio input Impedance 47k Ohm
- Average input level 470mVrms
- RGB 0.7Vp-p, 75 Ohm
- DVI-D (24 PIN)

Outputs:

- Video 1.0Vp-p, 75 Ohm
- Audio 470mVrms, 1k Ohm
- Optical Out (Digital Audio) 1 Optical Connector

Audio:

- Mono / Stereo / SAP
- SRS / Dolby Digital
- 10W+10W
- Mute

Supplied Accessories:

- Remote Control
- Batteries
- D-Sub Cable
- S-Video Cable
- AV Cable
- Power Cable
- User's Guide
- Easy Graphic Guide
- Warranty Card

Optional Accessories:

- Wallmount

INPUTS/OUTPUTS

- Component Y, P_B, P_R 1
- RGB: Analog Input 1
- DVI: Digital Input 1
- Composite Video 1
- S-Video 1
- Antenna (RF) Inputs 2
 - NTSC
 - ATSC
- Audio Input 4
- Audio Output 1
- TV Video Output 1
- Subwoofer Output 1
- Optical Out Digital Audio 1

SPECIFICATIONS

- Multi-Scanning: 32-70kHz (h), 50-85Hz (v)
- Pixel Pitch 0.90(horiz.) x 0.51(vert.) mm
- FCC class: B for Consumer Use
- Power Requirements: AC 108~132V, 60Hz
- Power Consumption: 350W
 - at standby <1W

DIMENSIONS

- Width: 1036 mm
- Height: 771 mm (with stand); 713 mm (without stand)
- Depth: 300 mm (with stand); 121 mm (without stand)
- Weight: 46Kg (with stand); 41.5Kg (without stand)

Screen mode availability varies by input format

HDTV Monitors display HDTV when combined with an HDTV Tuner and Source.

All specifications, weights, and dimensions are subject to change without prior notice. Please access www.hitachi.com/tv for detailed specifications and dimensions for custom installations.

UltraVision Digital is a registered trademark of Hitachi Home Electronics (America), Inc.

WOW, SRS and the  symbol are trademarks of SRS Labs, Inc. WOW technology is incorporated under license from SRS Labs, Inc.

USEFUL INFO

HITACHI



To locate an authorized
HITACHI service facility
in the continental U.S.A.
and Canada,

DIAL TOLL FREE

7 days a week, 24 hours a day

800 HITACHI

(1-800-448-2244)

Hitachi America, LTD. Home Electronics Division

Hitachi has made every effort to assure you hours of trouble free operation from your unit. However, should you require service, a network of Hitachi Authorized Service Facilities has been established in all 50 states and Puerto Rico. Each facility will provide you with convenient and expedient assistance. Our service hotline operator will direct you to the Hitachi Authorized Service Facility nearest you. Just present proof of purchase and/or delivery receipts to the Hitachi Authorized Service Facility, and service will be rendered in accordance with the terms of the limited warranty as stated on your warranty card or operating guide.

Should you have any questions regarding warranty, service, operation, or technical assistance, please contact:

Hitachi America, LTD.
Home Electronics Division
900 Hitachi Way
Chula Vista, CA 91914-3556

USEFUL INFO

Hitachi Canada, LTD. Digital Media Division

Should you have any questions regarding warranty, service, operation, or technical assistance, please contact:

**In Canada:
1-800-HITACHI
(1-800-448-2244)**

**Monday - Friday EST 9:00am - 7:00pm
Saturday EST 9:00am - 5:00pm**

Look for your French Manual on the outside of the box.

If the manual is missing, call

**1-800-HITACHI
(1-800-448-2244)**

for a copy.

Pour de plus amples renseignements sur le service durant la période couverte par la garantie, sur le fonctionnement ou pour de l'assistance technique communiquez avec:

**Au Canada:
1-800-HITACHI
(1-800-448-2244)**

**Lundi - Vendredi L'EST 9:00am - 7:00pm
Samedi L'EST 9:00am - 5:00pm**

La version française de votre manuel se trouve à l'extérieur de la boîte.

Si le manuel est manquant, coposez le

**1-800-HITACHI
(1-800-448-2244)**

pour obtenir votre copie.

**HITACHI CANADA, LTD.
2495 Meadowpine Blvd.
Mississauga, ON L5N 6C3**

END USER LICENSE AGREEMENT FOR HITACHI DTV SOFTWARE

IMPORTANT – READ CAREFULLY: This License Agreement is a legal agreement between you and Hitachi America, Ltd., Home Electronics Division ("HAL-HED"). By using this Hitachi digital television (the "DTV") and its software (the "Software"), you agree to be bound by the terms of this License Agreement. IF YOU DO NOT AGREE TO BE BOUND BY THIS LICENSE AGREEMENT, DO NOT USE THIS DTV AND ITS SOFTWARE.

The Software is protected by copyright laws and international copyright treaties, as well as other intellectual property laws and treaties. The Software is licensed, not sold.

1. LICENSE GRANT. Subject to all of the terms, conditions and restrictions of this License Agreement, HAL-HED grants to you a limited, revocable, non-exclusive right to use one copy of the Software only on one Hitachi labeled DTV owned by you.

2. RIGHTS AND LIMITATIONS. Software Not for Resale. You may not resell or otherwise transfer for value the Software, except that you may transfer the Software as part of a resale of the entire DTV product only.

Prohibition on Reverse Engineering, Decompilation, Disassembly and/or Modification. You may not reverse engineer, decompile, disassemble or modify the Software.

Separation of Components. The Software is licensed as single product. Its component parts may not be separated for use on more than one DTV.

No Transfers. You may not transfer, assign, rent, lease, lend or in any way sublicense the Software.

Trademarks. This License Agreement does not grant you any rights to any trademarks.

Third Party Software. You shall not use the Software in combination with any third party software.

3. VIOLATIONS; INDEMNITY. You understand that any use, copying or transfer of the Software, except as permitted pursuant to this License Agreement, constitutes a violation of legal rights and may subject you to damages and an award to HAL-HED of attorneys' fees in connection with any violation of this License. You further understand that you may be held legally responsible for any copyright infringement or other violation of intellectual property rights that is caused or encouraged by your failure to abide by the terms of this License Agreement. You agree to defend, indemnify and hold HAL-HED and its parent and affiliate companies harmless from and against any and all liability resulting from any breach by you of this License Agreement and/or any use by you of the Software in combination with third party software.

4. COPYRIGHT. All title and intellectual property rights in and to the Software (including but not limited to any images, photographs, animation, video, audio, music, text, and "applets" incorporated into the Software), and any accompanying printed materials are owned by HAL-HED. All title and intellectual property rights in and to the content which may be accessed through use of the Software is the property of the respective content owner and may be protected by applicable copyright or other intellectual property laws and treaties. This License Agreement grants you no rights to use such content. All rights not expressly granted are reserved by HAL-HED. This provision applies to U.S. Government end-users, who are granted only those rights expressly set forth herein.

5. EXPORT RESTRICTIONS. HAL-HED is licensing the Software for use within the United States only. You agree that you will not export or re-export the Software. You specifically agree not to export or re-export the Software: (i) to any country to which the U.S. has embargoed or restricted the export of goods or services, which currently include, but are not necessarily limited to Cuba, Iran, Iraq, Libya, North Korea, Sudan, and Syria, or to any national of any such country, wherever located, who intends to transmit or transport the Software back to such country; (ii) to any person or entity who you know or have reason to know will utilize the Software in the design, development, or production of nuclear, chemical, or biological weapons; or (iii) to any person or entity who has been prohibited from participating in U.S. export transactions by any federal agency of the U.S. government. You warrant and represent that neither the Bureau of Export Administration (BXA) nor any other U.S. Federal Agency has suspended, revoked, or denied your export privileges.

6. NO WARRANTIES. THE SOFTWARE IS PROVIDED "AS-IS, WHERE-IS." HAL-HED MAKES NO WARRANTIES OF ANY KIND WHATSOEVER REGARDING THE SOFTWARE AND, TO THE MAXIMUM EXTENT PERMITTED BY LAW, HEREBY EXPRESSLY DISCLAIMS ALL WARRANTIES OF ANY KIND WHATSOEVER, EXPRESS OR IMPLIED, WITH RESPECT TO THE SOFTWARE. ALL IMPLIED WARRANTIES, INCLUDING WITHOUT LIMITATION, THE IMPLIED WARRANTIES OF NON-INFRINGEMENT, MERCHANTABILITY AND FITNESS FOR A PARTICULAR PURPOSE ARE HEREBY EXPRESSLY DISCLAIMED TO THE MAXIMUM EXTENT PERMITTED BY LAW.

END USER LICENSE AGREEMENT FOR HITACHI DTV SOFTWARE

7. LIMITATION OF LIABILITY. IN NO EVENT SHALL HAL-HED OR ANY OF ITS PARENT OR AFFILIATE COMPANIES BE LIABLE TO YOU OR ANY THIRD PARTY FOR ANY DIRECT, INDIRECT, INCIDENTAL, SPECIAL, EXEMPLARY, OR CONSEQUENTIAL DAMAGES (INCLUDING, BUT NOT LIMITED TO, PROCUREMENT OF SUBSTITUTE GOODS OR SERVICES; LOSS OF USE, DATA, OR PROFITS; LOSS OF GOODWILL, EXPENDITURES MADE OR COMMITTED FOR IN RELIANCE ON THE CONTINUATION OF THIS LICENSE AGREEMENT OR BUSINESS INTERRUPTION) HOWEVER CAUSED AND ON ANY THEORY OF LIABILITY, WHETHER IN CONTRACT, STRICT LIABILITY, OR TORT (INCLUDING NEGLIGENCE OR OTHERWISE) ARISING IN ANY WAY OUT OF THE USE OF THE SOFTWARE, EVEN IF ADVISED OF THE POSSIBILITY OF SUCH DAMAGE.

8. NO FAILURE OF ESSENTIAL PURPOSE. YOU AGREE THAT NO FAILURE TO REPAIR A DEFECT, ERROR OR BUG IN THE SOFTWARE SHALL CONSTITUTE A FAILURE OF THE ESSENTIAL PURPOSE OF THIS LICENSE AGREEMENT.

9. CRYPTOGRAPHIC SOFTWARE. THIS PRODUCT CONTAINS SOFTWARE DEVELOPED BY THE OpenSSL PROJECT INCLUDING CRYPTOGRAPHIC SOFTWARE WRITTEN BY ERIC YOUNG (THE "CRYPTOGRAPHIC SOFTWARE"). THE CRYPTOGRAPHIC SOFTWARE IS PROVIDED BY THE OpenSSL PROJECT "AS IS" AND ANY EXPRESSED OR IMPLIED WARRANTIES, INCLUDING BUT NOT LIMITED TO, THE IMPLIED WARRANTIES OF MERCHANTABILITY AND FITNESS FOR A PARTICULAR PURPOSE ARE HEREBY EXPRESSLY DISCLAIMED TO THE MAXIMUM EXTENT PERMITTED BY LAW. IN NO EVENT SHALL THE OpenSSL PROJECT, ITS CONTRIBUTORS, HAL-HED OR ANY OF ITS PARENT OR AFFILIATE COMPANIES BE LIABLE FOR ANY DIRECT, INDIRECT, INCIDENTAL, SPECIAL, EXEMPLARY, OR CONSEQUENTIAL DAMAGES (INCLUDING, BUT NOT LIMITED TO, PROCUREMENT OF SUBSTITUTE GOODS OR SERVICES; LOSS OF USE, DATA, OR PROFITS; OR BUSINESS INTERRUPTION) HOWEVER CAUSED AND ON ANY THEORY OF LIABILITY, WHETHER IN CONTRACT, STRICT LIABILITY, OR TORT (INCLUDING NEGLIGENCE OR OTHERWISE) ARISING IN ANY WAY OUT OF THE USE OF THE SOFTWARE OR THE CRYPTOGRAPHIC SOFTWARE, EVEN IF ADVISED OF THE POSSIBILITY OF SUCH DAMAGE.

10. TERMINATION. This License Agreement may be terminated at any time by HAL-HED effective immediately upon notice to you.

11. GOVERNING LAW; SEVERABILITY. This Agreement shall be governed and construed in accordance with the laws of the State of California, without regard to its conflict of laws rules, and any disputes hereunder shall be subject to the exclusive jurisdiction and venue of the U.S. Federal Courts in the Southern District of California. If any part of this License Agreement is unenforceable, the remainder shall be valid and binding to the maximum extent permitted by applicable law.