

CD/DVD Player

Operating Instructions

For customers in the U.S.A

Owner's Record

The model and serial numbers are located at the rear of the unit. Record the serial number in the space provided below. Refer to them whenever you call upon your Sony dealer regarding this product.

Model No. DVP-CX985V

Serial No. _____

For Customers in Canada

If this product is not working properly, please call 1-877-602-2008 for **Peace of Mind Warranty Replacement service.**

For other product related questions please contact our **Customer Information Service Centre** at 1-877-899-7669 or write to us at: Customer Information Service 115 Gordon Baker Road, Toronto, Ontario, M2H 3R6



DVP-CX985V

WARNING

To prevent fire or shock hazard, do not expose the unit to rain or moisture. To avoid electrical shock, do not open the cabinet. Refer servicing to qualified personnel only.

CAUTION

The use of optical instruments with this product will increase eye hazard.

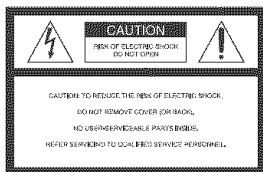

This symbol is intended to alert the user to the presence of uninsulated "dangerous voltage"

within the product's enclosure that may be of sufficient magnitude to constitute a risk of electric shock to persons.



This symbol is intended to alert the user to the presence of important operating and maintenance (servicing) instructions in the literature accompanying the appliance.

CAUTION

You are cautioned that any change or modifications not expressly approved in this manual could void your authority to operate this equipment.

WARNING

This equipment has been tested and found to comply with the limits for a Class B digital device, pursuant to Part 15 of the FCC Rules. These limits are designed to provide reasonable protection against harmful interference in a residential installation. This equipment generates, uses, and can radiate radio frequency energy and, if not installed and used in accordance with the instructions, may cause harmful interference to radio communications. However, there is no guarantee that interference will not occur in a particular installation. If this equipment does cause harmful interference to radio or television reception, which can be determined by turning the equipment off and on, the user is encouraged to try to correct the interference by one or more of the following measures:

- Reorient or relocate the receiving antenna.
- Increase the separation between the equipment and receiver.
- Connect the equipment into an outlet on a circuit different from that to which the receiver is connected.
- Consult the dealer or an experienced radio/TV technician for help.

CAUTION

TO PREVENT ELECTRIC SHOCK, MATCH WIDE BLADE OF PLUG TO WIDE SLOT, FULLY INSERT.

Welcome!

Thank you for purchasing this Sony CD/DVD Player. Before operating this player, please read this manual thoroughly and retain it for future reference.

Precautions

On safety

- Caution – The use of optical instruments with this product will increase eye hazard.
- To prevent fire or shock hazard, do not place objects filled with liquids, such as vases, on the apparatus.
- Should any solid object or liquid fall into the cabinet, unplug the player and have it checked by qualified personnel before operating it any further.

On power sources

- The player is not disconnected from the AC power source as long as it is connected to the wall outlet, even if the player itself has been turned off.
- If you are not going to use the player for a long time, be sure to disconnect the player from the wall outlet. To disconnect the AC power cord, grasp the plug itself; never pull the cord.
- Should the AC power cord need to be changed, have it done at a qualified service shop only.

On placement

- Place the player in a location with adequate ventilation to prevent heat build-up in the player.
- Do not place the player on a soft surface such as a rug that might block the ventilation holes.
- Do not place the player in a location near heat sources, or in a place subject to direct sunlight, excessive dust, or mechanical shock.
- Do not install the player in an inclined position. It is designed to be operated in a horizontal position only.
- Keep the player away from equipment with strong magnets, such as microwave ovens, or large loudspeakers.
- Do not place heavy objects on the player.

On operation

- If the player is brought directly from a cold to a warm location, or is placed in a very damp room, moisture may condense on the lenses inside the player. Should this occur, the player may not operate properly. In this

case, remove the disc and leave the player turned on for about half an hour until the moisture evaporates.

- When you move the player, take out any discs. If you don't, the disc may be damaged.

On adjusting volume

Do not turn up the volume while listening to a section with very low level inputs or no audio signals. If you do, the speakers may be damaged when a peak level section is played.

On cleaning

Clean the cabinet, panel, and controls with a soft cloth slightly moistened with a mild detergent solution. Do not use any type of abrasive pad, scouring powder or solvent such as alcohol or benzene.

On cleaning discs

Do not use a commercially available cleaning disc. It may cause a malfunction.

IMPORTANT NOTICE

Caution: This player is capable of holding a still video image or on-screen display image on your television screen indefinitely. If you leave the still video image or on-screen display image displayed on your TV for an extended period of time you risk permanent damage to your television screen. Plasma Display Panel televisions and projection televisions are especially susceptible to this.

On transporting the player

Before transporting the player, follow the procedure below to return the internal mechanisms to their original positions.

- 1 Remove all the discs from the disc slots.
- 2 Press OPEN/CLOSE to close the front cover.
Make sure that "NO DISC" appears on the front panel display.
- 3 Wait for 10 seconds, then press  to turn off the player.
The player enters standby mode.
- 4 Disconnect the AC power cord.

If you have any questions or problems concerning your player, please consult your nearest Sony dealer.







Table of Contents

WARNING	2
Welcome!	2
Precautions	3
About This Manual	6
This Player Can Play the Following Discs	6
Notes About the Discs	8
Index to Parts and Controls	9
Guide to the Control Menu Display	14
<hr/>	
Hookups	17
Hooking Up the Player	17
Step 1: Unpacking	17
Step 2: Preparing the Remote	17
Step 3: Connecting the Video Cords	19
Step 4: Connecting the Audio Cords	21
Step 5: Connecting the Power Cord	28
Step 6: Quick Setup	28
<hr/>	
Playing Discs	32
Inserting Discs	32
Playing Discs	33
Resuming Playback From the Point Where You Stopped the Disc (Resume Play)	36
Using the DVD's Menu	37
Selecting "ORIGINAL" or "PLAY LIST" on a DVD-RW	38
Selecting a Playback Area for a Super Audio CD	39
Playing VIDEO CDs With PBC Functions (PBC Playback)	40
Selecting and Playing an MP3 Audio Track	41
Various Play Mode Functions (Program Play, Shuffle Play, Repeat Play, A-B Repeat Play)	43
<hr/>	
Searching for and Managing Discs (Disc Explorer)	49
Displaying the Disc Information	49
Filing Discs in the Folder (File Mode)	52
Labeling Discs and Folders (Edit Mode)	54
Sorting Discs (Sort Mode)	57
<hr/>	
Searching for a Scene	59
Searching for a Particular Point on a Disc (Search, Scan, Slow-motion Play, Freeze Frame)	59
Searching for a Title/Chapter/Track/Scene, etc.	60
Searching by Scene (PICTURE NAVIGATION)	62
<hr/>	
Viewing Information About the Disc	64
Checking the Playing Time and Remaining Time	64
Checking the Play Information	66

Sound Adjustments	68
Changing the Sound	68
SURROUND Mode Settings	69
Enjoying Movies	73
Changing the Angles	73
Displaying the Subtitles	73
Adjusting the Picture Quality (BNR)	74
Adjusting the Playback Picture (CUSTOM PICTURE MODE)	75
Enhancing the Playback Picture (DIGITAL VIDEO ENHANCER)	77
Using Various Additional Functions	78
Locking Discs (CUSTOM PARENTAL CONTROL, PARENTAL CONTROL)	78
Controlling Your TV or AV Amplifier (Receiver) With the Supplied Remote	82
Settings and Adjustments	85
Using the Setup Display	85
Setting the Display or Sound Track Language (LANGUAGE SETUP)	86
Settings for the Display (SCREEN SETUP)	87
Custom Settings (CUSTOM SETUP)	89
Settings for the Sound (AUDIO SETUP)	90
Settings for the Speakers (SPEAKER SETUP)	92
Additional Information	95
Troubleshooting	95
Self-diagnosis Function (When letters/numbers appear in the display)	97
Glossary	98
Specifications	101
Language Code List	102
Index	103





About This Manual

- Instructions in this manual describe the controls on the remote. You can also use the controls on the player if they have the same or similar names as those on the remote.
- “DVD” may be used as a general term for DVD VIDEOS, DVD-Rs, DVD-RWs, DVD+Rs, and DVD+RWs.
- The meaning of the icons used in this manual is described below:

Icons	Meanings
	Functions available for DVD VIDEOS or DVD-Rs/DVD-RWs in video mode or DVD+Rs/DVD+RWs
	Functions available for DVD-RWs in VR (Video Recording) mode
	Functions available for VIDEO CDs, Super VCDs, or CD-Rs/CD-RWs in video CD format or Super VCD format
	Functions are available for Super Audio CDs
	Functions available for DATA CDs (CD-ROMs/CD-Rs/CD-RWs containing MP3* audio tracks)
	Functions available for music CDs or CD-Rs/CD-RWs in music CD format

* MP3 (MPEG1 Audio Layer 3) is a standard format defined by ISO (International Standards Organization)/MPEG which compresses audio data.

This Player Can Play the Following Discs

Format of discs	
DVD VIDEO (page 98)	
DVD-RW (page 98)	
Super Audio CD (page 98)	
VIDEO CD	
Music CD	

“DVD VIDEO” and “DVD-RW” are trademarks.

Region code

Your player has a region code printed on the back of the unit and will only play DVD VIDEOS (playback only) labeled with identical region codes. This system is used to protect copyrights.

DVD VIDEOS labeled  will also play on this player.

If you try to play any other DVD VIDEO, the message “Playback prohibited by area limitations.” will appear on the TV screen. Depending on the DVD VIDEO, no region code indication may be labeled even though playing the DVD VIDEO is prohibited by area restrictions.

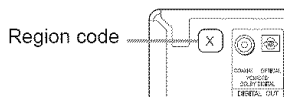

Example of discs that the player cannot play

The player cannot play the following discs:

- All CD-ROMs (including PHOTO CDs)/CD-Rs/CD-RWs other than those recorded in the following formats:
 - music CD format
 - video CD format
 - MP3 format that conforms to ISO9660* Level 1/Level 2, or its extended format, Joliet
- Data part of CD-Extras
- DVD-ROMs
- DVD Audios
- * A logical format of files and folders on CD-ROMs defined by ISO (International Standards Organization).

Also, the player cannot play the following discs:

- A DVD VIDEO with a different region code.
- A disc recorded in a color system other than NTSC, such as PAL or SECAM (this player conforms to the NTSC color system).
- A disc that has a non-standard shape (e.g., card, heart).
- A disc with paper or stickers on it.
- A disc that has the adhesive of cellophane tape or a sticker still left on it.

Notes

- **Note about DVD-RWs/DVD-Rs, DVD+RWs/DVD+Rs, or CD-Rs/CD-RWs.**
Some DVD-RWs/DVD-Rs, DVD+RWs/DVD+Rs, or CD-Rs/CD-RWs cannot be played on this player due to the recording quality or physical condition of the disc, or the characteristics of the recording device and authoring software. Also, images in DVD-RWs with CPRM* protection may not be played if they contain a copy protection signal. “Copyright lock” appears on the screen. For more information, see the operating instructions for the recording device.
Note that discs created in the Packet Write format cannot be played.
- * CPRM (Content Protection for Recordable Media) is a coding technology that protects copyright for images.

- **Music discs encoded with copyright protection technologies**

This product is designed to playback discs that conform to the Compact Disc (CD) standard. Recently, various music discs encoded with copyright protection technologies are marketed by some record companies. Please be aware that among those discs, there are some that do not conform to the CD standard and may not be playable by this product.

Note on playback operations of DVDs and VIDEO CDs

Some playback operations of DVDs and VIDEO CDs may be intentionally set by software producers. Since this player plays DVDs and VIDEO CDs according to the disc contents the software producers designed, some playback features may not be available. Also, refer to the instructions supplied with the DVDs or VIDEO CDs.

Copyrights

This product incorporates copyright protection technology that is protected by U.S. patents and other intellectual property rights. Use of this copyright protection technology must be authorized by Macrovision, and is intended for home and other limited viewing uses only unless otherwise authorized by Macrovision. Reverse engineering or disassembly is prohibited.

Notes About the Discs

- To keep the disc clean, handle the disc by its edge. Do not touch the surface.



- Do not expose the disc to direct sunlight or heat sources such as hot air ducts, or leave it in a car parked in direct sunlight as the temperature may rise considerably inside the car.
- After playing, store the disc in its case.

To ensure stable operation

- If the front cover automatically opens and “C32” appears in the front panel display (page 97), it may be because burrs remain on the outer edge of the disc, particularly CDs. In order to ensure stable operation, remove the burrs by rubbing the edge of the disc with the side of a pen or pencil. Check the discs in the two slots to the left and right of the center slot, including the center slot.

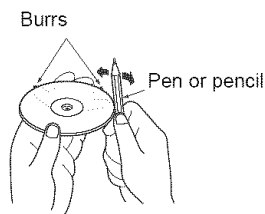

- Clean the disc with a cleaning cloth. Wipe the disc from the center out.



- Do not use solvents such as benzine, thinner, commercially available cleaners, or anti-static spray intended for vinyl LPs.

Index to Parts and Controls

For more information, see the pages in parentheses.

Front panel

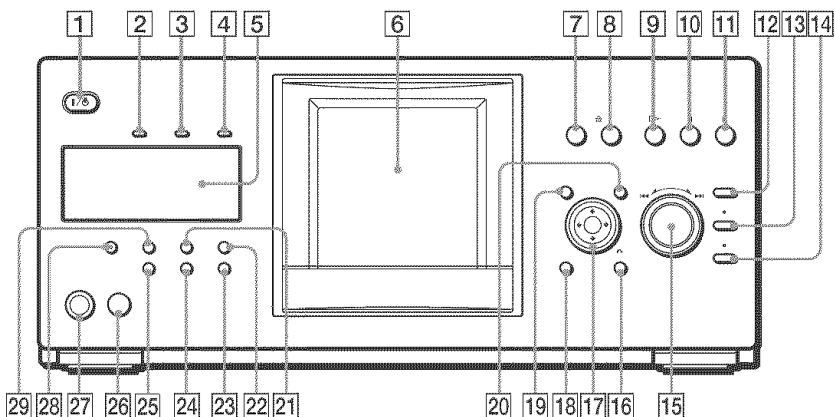

- | | |
|--|---|
| 1 I/⏻ (on/standby) button (32) | 14 DIRECT SEARCH button/indicator (34) |
| 2 PROGRESSIVE indicator (87)
Lights up when the player outputs progressive signals. | 15 ◀◀-/+▶▶/ENTER (previous/next/enter) dial (34) |
| 3 SACD (Super Audio CD) indicator
Lights up when:
— playing a Super Audio CD.
— no disc is inserted. | 16 ↻ RETURN button (35) |
| 4 MULTI CHANNEL indicator
Lights up when:
— Playing a track or chapter that contains three or more audio signal channels.
— no disc is inserted. | 17 ◀/▶/⏸/ENTER buttons (37) |
| 5 Front panel display (10) | 18 DISPLAY button (14) |
| 6 Front cover (32) | 19 TOP MENU button (37) |
| 7 OPEN/CLOSE button (32) | 20 MENU button (37) |
| 8 ≡ DISC EJECT button (33) | 21 PICTURE MODE button (75) |
| 9 ▷ (play) button (33) | 22 SURROUND button (69) |
| 10 (pause) button (34) | 23 ONE/ALL DISCS button (43) |
| 11 ■ (stop) button (34) | 24 FOLDER button (49) |
| 12 +100 button (34) | 25 LOAD button (49) |
| 13 DISC CHANGE button/indicator (32) (33) (34) (50) | 26 ■ (remote sensor) (17) |
| | 27 KEYBOARD jack (55) |
| | 28 FL OFF button/indicator (10) |
| | 29 TIME/TEXT button (64) |

Front panel display

When playing back a DVD VIDEO/DVD-RW

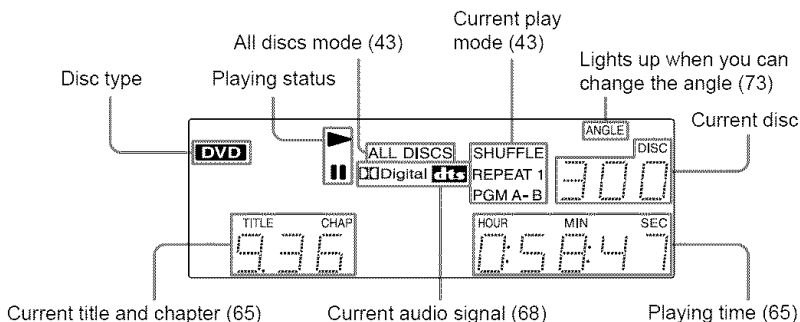

When playing back a VIDEO CD with Playback Control (PBC) (40)

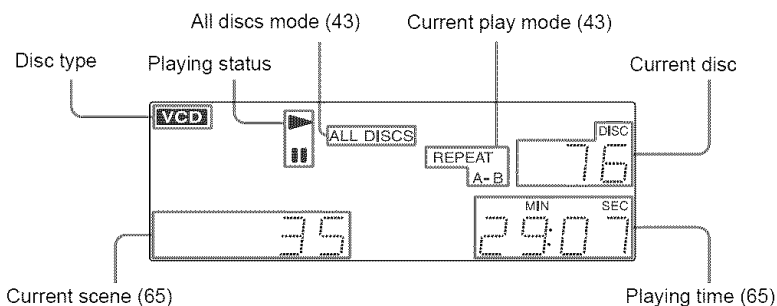

When playing back a CD, Super audio CD, DATA CD (MP3 audio), or VIDEO CD (without PBC)

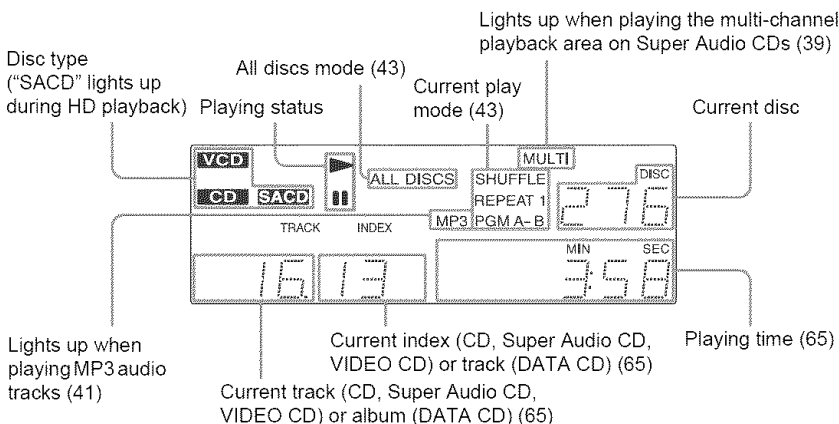

To turn off the front panel display

Press FL OFF on the player. The front panel display turns off, and the FL OFF indicator on the player lights up.

Hint

You can adjust the lighting of the front panel display by setting "DIMMER" in "CUSTOM SETUP" (page 89).

Rear panel

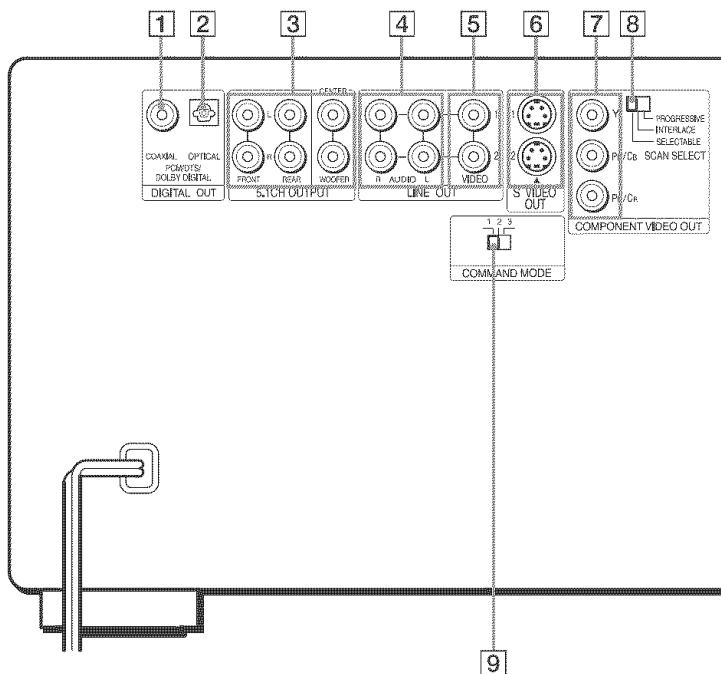

- 1** DIGITAL OUT (COAXIAL) jack (24) (25) (26)
- 2** DIGITAL OUT (OPTICAL) jack (24) (25) (26)
- 3** 5.1CH OUTPUT jacks (26)
- 4** LINE OUT AUDIO L/R 1/2 jacks (23) (24) (25)
- 5** LINE OUT VIDEO 1/2 jacks (19)
- 6** S VIDEO OUT 1/2 jacks (19)
- 7** COMPONENT VIDEO OUT (Y, Pb/Cb, Pr/Cr) jacks (19)
- 8** COMPONENT VIDEO OUT/SCAN SELECT switch (87)
- 9** COMMAND MODE switch (18)

Remote

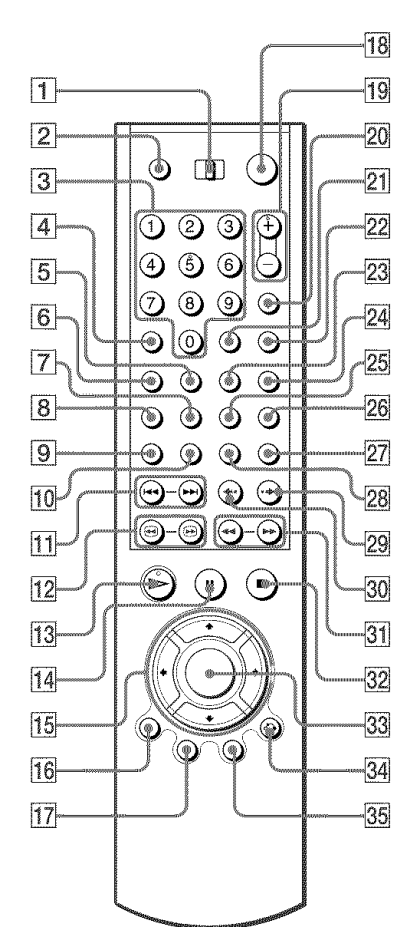

- 12** ◀▶/◀▶▶▶ SEARCH/STEP buttons (59)
- 13** ▷ PLAY button (33)
The ▷ button has a tactile dot.*
- 14** || PAUSE button (34)
- 15** ←/↑/↓/→ buttons (37)
- 16** DISPLAY/FILE button (14)(52)
- 17** TOP MENU/EDIT button (37)(54)
- 18** |/⏻ (on/standby) button (32)
- 19** VOL (volume) +/- buttons (82)
The + button has a tactile dot.*
- 20** TV/VIDEO/DISC SKIP + button (34)(82)
- 21** ENTER button (82)
- 22** WIDE MODE/DISC SKIP - button (34)(82)
- 23** FOLDER button (49)
- 24** PICTURE MEMORY button (51)
- 25** ANGLE button (73)
- 26** TIME/TEXT button (64)
- 27** SACD/CD (Super Audio CD/CD) button (39)
- 28** SACD MULTI/2CH (Super Audio CD multi/2 channel) button (39)
- 29** ●→ INSTANT SEARCH button (34)
- 30** ←● INSTANT REPLAY button (34)
- 31** ◀◀▶▶▶▶ SCAN/SLOW buttons (59)
- 32** ■ STOP button (34)
- 33** ENTER button (37)
- 34** ↶ RETURN button (35) (40) (50)
- 35** MENU/SORT button (37) (41) (57)

* Use the tactile dot as a reference when operating the player.

- 1** TV/DISC EXPLORER/DVD switch (50)(82)
- 2** OPEN/CLOSE button (34)
- 3** Number buttons (37)
The number 5 button has a tactile dot.*
- 4** CLEAR button (44)
- 5** SUR (surround) button (69)
- 6** PICTURE MODE button (75)
- 7** SUBTITLE button (73)
- 8** AUDIO button (68)
- 9** PICTURE NAVI (picture navigation) button (62)
- 10** REPEAT button (46)
- 11** ◀◀/▶▶ PREVIOUS/next) buttons (34)

Guide to the Control Menu Display

Use the Control Menu to select a function and to view related information. After sliding the TV/DISC EXPLORER/DVD switch to DVD, press DISPLAY/FILE repeatedly to turn on or change the Control Menu display as follows:

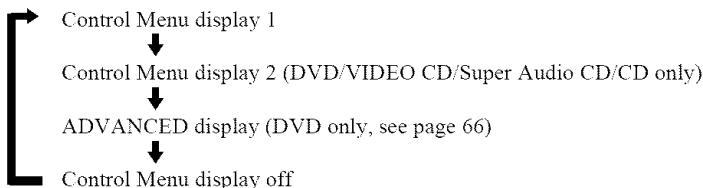

Hint

You can skip the ADVANCED display by setting "OFF" under "ADVANCED" in the Control Menu (page 66).

Control Menu

The Control Menu display 1 and 2 will show different items depending on the disc type. For details, see the pages in parentheses.

Example: Control Menu display 1 when playing a DVD VIDEO

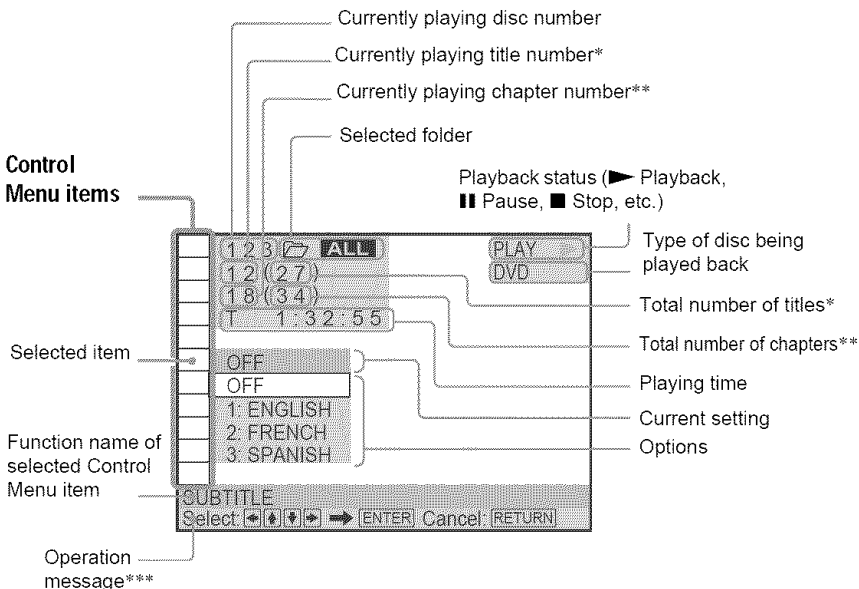



























* Displays the scene number for VIDEO CDs (PBC is on), track number for VIDEO CDs/Super Audio CDs/CDs, album number for DATA CDs.

** Displays the index number for VIDEO CDs/Super Audio CDs/CDs, MP3 audio track number for DATA CDs.



*** Displays the DISC MEMO or CD Text when the disc contains title information.

List of Control Menu items

Item	Item Name, Function, Relevant Disc Type
	DISC (page 60) Selects the disc to be played. DVD-V DVD-RW VCD SA-CD CD DATA CD
	TITLE (page 60)/SCENE (page 60)/TRACK (page 60) Selects the title, scene, or track to be played. DVD-V DVD-RW VCD
	CHAPTER (page 60)/INDEX (page 60) Selects the chapter or index to be played. DVD-V DVD-RW VCD
	ALBUM (page 60) Selects the album to be played. DATA CD
	TRACK (page 60) Selects the track to be played. SA-CD CD DATA CD
	INDEX (page 60) Selects the index to be played. SA-CD CD
	ORIGINAL/PLAY LIST (page 38) Selects the type of titles (DVD-RW) to be played, the ORIGINAL one, or an edited PLAY LIST. DVD-RW
	TIME/MEMO (page 60) Checks the elapsed time and the remaining playback time. Use to input the time code when searching for a scene or music. Displays the Disc Memo you entered in the edit mode of the Disc Explorer function (page 65). DVD-V VCD CD
	TIME/TEXT (page 60) Checks the elapsed time and the remaining playback time. Use to input the time code when searching for a scene or music. Displays the DVD/Super Audio CD/CD text or the DATA CD's track name (page 65). DVD-V DVD-RW SA-CD VCD CD DATA CD
	MULTI/2CH (page 39) Selects the playback area on Super Audio CDs when available. SA-CD
	AUDIO (page 68) Changes the audio setting. DVD-V DVD-RW VCD CD DATA CD
	SUBTITLE (page 73) Displays the subtitles. Changes the subtitle language. DVD-V DVD-RW
	ANGLE (page 73) Changes the angle. DVD-V
	SURROUND (page 69) Selects the surround functions. DVD-V DVD-RW VCD CD DATA CD
	ADVANCED (page 66) Displays the information (bit rate or layer) of the disc currently playing. DVD-V DVD-RW
	PARENTAL CONTROL (page 78) Set to prohibit playback on this player. DVD-V SA-CD VCD CD

	<p>SETUP (page 85) QUICK Setup Use Quick Setup to choose the desired language of the on-screen display, the aspect ratio of the TV, and the audio output signal, and the size of the speakers you are using.</p> <p>CUSTOM Setup In addition to the Quick Setup setting, you can adjust various other settings.</p> <p>RESET Returns the settings in “SETUP” to the default setting.</p> <p style="text-align: right;">DVD-V DVD-RW SA-CD VCD CD DATA CD</p>
 	<p>ALL DISCS/ONE DISC (page 43) Selects All Discs or One Disc mode.</p> <p style="text-align: right;">DVD-V DVD-RW SA-CD VCD CD DATA CD</p>
	<p>PROGRAM (page 44) Selects the disc, title, chapter, or track to play in the order you want.</p> <p style="text-align: right;">DVD-V SA-CD VCD CD</p>
	<p>SHUFFLE (page 46) Plays the disc, title, chapter, or track in random order.</p> <p style="text-align: right;">DVD-V DVD-RW SA-CD VCD CD DATA CD</p>
	<p>REPEAT (page 46) Plays the entire disc (all titles/all tracks/all albums) repeatedly or one title/chapter/track/album repeatedly.</p> <p style="text-align: right;">DVD-V DVD-RW SA-CD VCD CD DATA CD</p>
	<p>A-B REPEAT (page 47) Specifies the parts you want to play repeatedly.</p> <p style="text-align: right;">DVD-V DVD-RW SA-CD VCD CD</p>
	<p>BNR (page 74) Adjusts the picture quality by reducing the “block noise” or mosaic like patterns that appear on your TV screen.</p> <p style="text-align: right;">DVD-V DVD-RW VCD</p>
	<p>CUSTOM PICTURE MODE (page 75) Adjusts the video signal from the player. You can select the picture quality that best suits the program you are watching.</p> <p style="text-align: right;">DVD-V DVD-RW VCD</p>
	<p>DIGITAL VIDEO ENHANCER (page 77) Exaggerates the outline of the image to produce a sharper picture.</p> <p style="text-align: right;">DVD-V DVD-RW VCD</p>
	<p>PICTURE NAVIGATION (page 62) Divides the screen into 9 subscreens to help you find the scene you want quickly.</p> <p style="text-align: right;">DVD-V VCD</p>

 **Hint**

The Control Menu icon indicator lights up in green  →  when you select any item except “OFF,” (“SURROUND,” “PROGRAM,” “SHUFFLE,” “REPEAT,” “A-B REPEAT,” “BNR,” and “DIGITAL VIDEO ENHANCER” only). The “ANGLE” indicator lights up in green only when the angles can be changed. The “CUSTOM PICTURE MODE” indicator lights up in green when any setting other than “STANDARD” is selected.

Hooking Up the Player

Follow steps 1 to 6 to hook up and adjust the settings of the player.

Notes

- Plug cords securely to prevent unwanted noise.
- Refer to the instructions supplied with the components to be connected.
- You cannot connect this player to a TV that does not have a video input jack.
- Be sure to disconnect the power of each component before connecting.

Step 1: Unpacking

Check that you have the following items:

- Audio/video cord (pinplug × 3 ↔ pinplug × 3) (1)
- Remote commander (remote) (1)
- Size AA (R6) batteries (2)

Step 2: Preparing the Remote

You can control the player using the supplied remote. Insert two Size AA (R6) batteries by matching the ⊕ and ⊖ ends on the batteries to the markings inside the compartment. When using the remote, point it at the remote sensor  on the player.

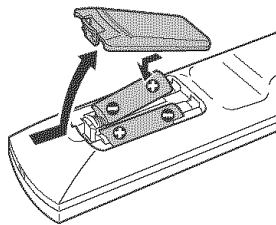

Notes

- Do not leave the remote in an extremely hot or humid place.
- Do not drop any foreign object into the remote casing, particularly when replacing the batteries.
- Do not expose the remote sensor to direct sunlight or lighting apparatus. Doing so may cause a malfunction.
- If you do not use the remote for an extended period of time, remove the batteries to avoid possible damage from battery leakage and corrosion.

When you have more than one Sony DVD player

If the supplied remote interferes with your other Sony DVD player, set the command mode for this player and the supplied remote to one that differs from the other Sony DVD player. The default command mode setting for this player and the supplied remote is DVD1.

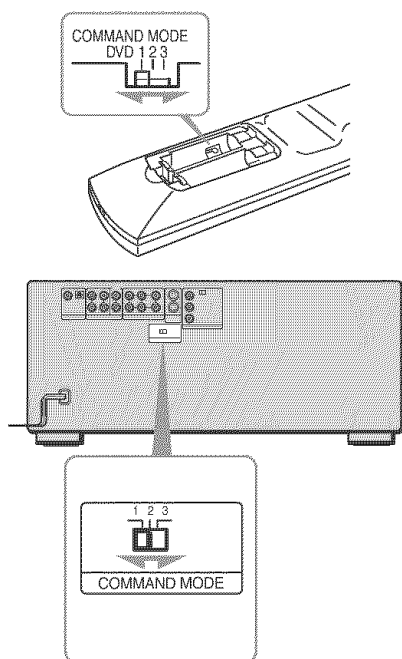

- 1** Slide the **COMMAND MODE** switch on the remote to select the command mode (DVD 1, DVD 2, or DVD 3) so that the setting for the remote differs from the other DVD players.

For example, if other DVD players respond to the default command mode setting for the supplied remote (DVD 1), set the remote to DVD 2 or DVD 3.

- 2** Slide the **COMMAND MODE** switch on the rear of the player so it matches that of the supplied remote.

Step 3: Connecting the Video Cords

Connect this player to your TV monitor, projector, or AV amplifier (receiver) using a video cord. Select one of the patterns **A** through **C**, according to the input jack on your TV monitor, projector, or AV amplifier (receiver). In order to view progressive signal pictures with a compatible TV, projector, or monitor, you must use pattern **C**.

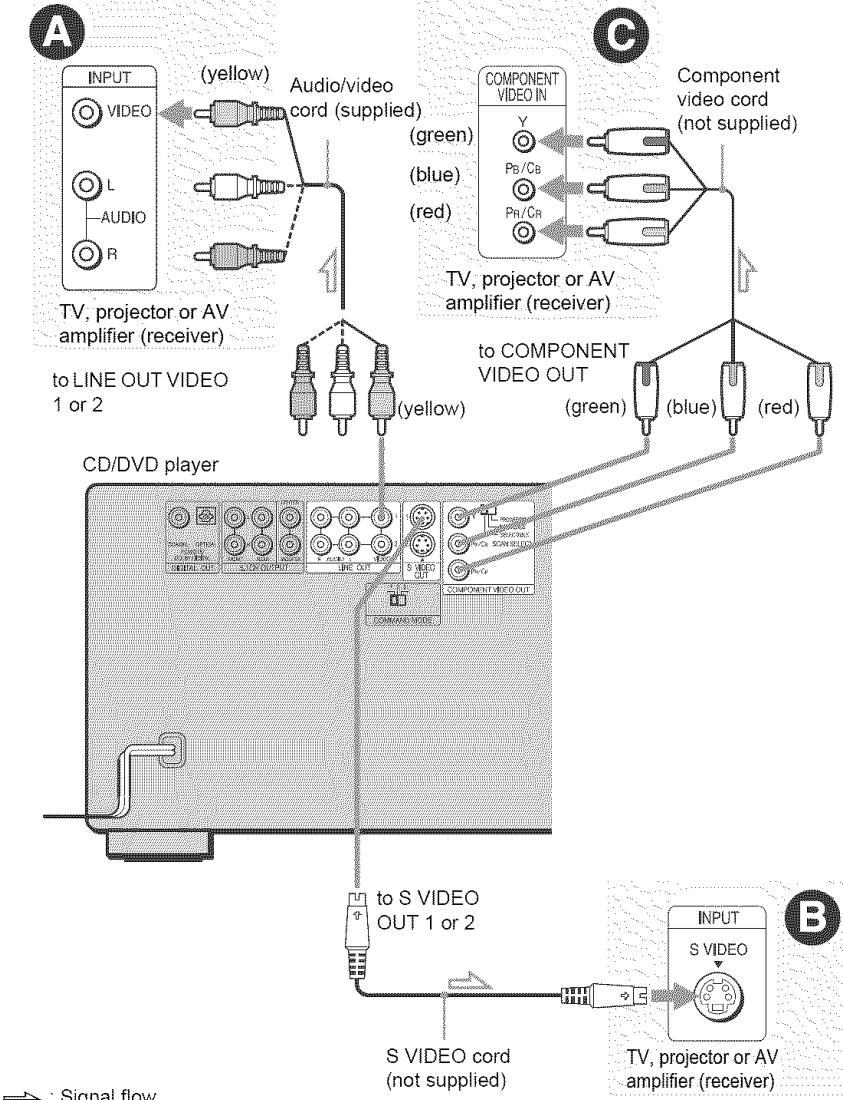

A If you are connecting to a video input jack

Connect the yellow plug of the audio/video cord (supplied) to the yellow (video) jacks. You will enjoy standard quality images.



Use the red and white plugs to connect to the audio input jacks (page 23). (Do this if you are connecting to a TV only.)

B If you are connecting to an S VIDEO input jack

Connect an S VIDEO cord (not supplied). You will enjoy high quality images.



C If you are connecting to a monitor, projector, or AV amplifier (receiver) having component video input jacks (Y/P_B/P_R)

Connect the component via the COMPONENT VIDEO OUT jacks using a component video cord (not supplied) or three video cords (not supplied) of the same kind and length. You will enjoy accurate color reproduction and high quality images. If your TV accepts progressive 480p format signals, you must use this connection and set "COMPONENT OUT" in "SCREEN SETUP" to "PROGRESSIVE" (page 87).



To change the aspect ratio for the connected TV

Depending on the disc and the TV type (standard 4:3 screen TV or wide screen TV), the image may not fit the TV screen. If this happens, change the aspect ratio (page 87).

Notes

- Connect the player directly to the TV. If you pass the player signals via the VCR, you may not receive a clear image on the TV screen.

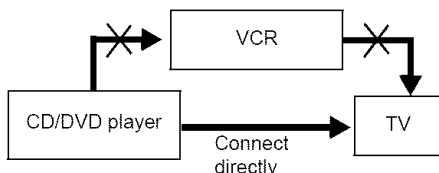

- Consumers should note that not all high definition television sets are fully compatible with this product and may cause artifacts to be displayed in the picture. In case of 480 progressive scan picture problems, it is recommended that the user switch the connection to the 'standard definition' output. If there are questions regarding our TV set compatibility with this model 480p DVD player, please contact our customer service center.

Step 4: Connecting the Audio Cords

Refer to the chart below to select the connection that best suits your system. Be sure to also read the instructions for the components you wish to connect.

Select a connection

Select one of the following connections, **A** through **D**.

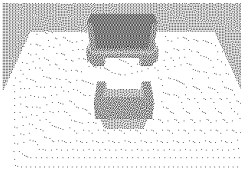
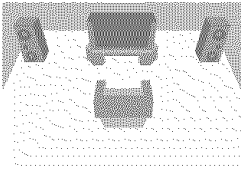
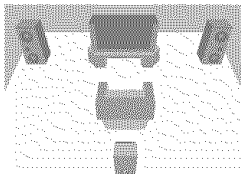
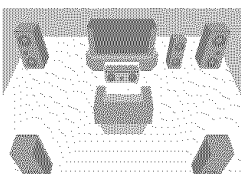
Components to be connected	Connection	Your setup (example)
TV • Surround effects: TVS DYNAMIC (page 70), TVS WIDE (page 70)	A (page 23)	
Stereo amplifier (receiver) and two speakers • Surround effects: TVS STANDARD (page 70) or MD deck/DAT deck • Surround effects: None	B (page 24)	
AV amplifier (receiver) having a Dolby* Surround (Pro Logic) decoder and 3 to 6 speakers • Surround effects: Dolby Surround (Pro Logic) (page 91)	C (page 25)	
AV amplifier (receiver) with 5.1 ch input jacks and 4 to 6 speakers • Surround effects: – Dolby Digital (5.1 ch) (page 98) – DTS (5.1 ch) (page 98) – Super Audio CD Multi channel (page 98) or AV amplifier (receiver) with digital input jacks having a Dolby or DTS** decoder and 6 speakers • Surround effects: – Dolby Digital (5.1 ch) (page 98) – DTS (5.1 ch) (page 98)	D (page 26)	

 **Hint**

If you have an AV amplifier that conforms to the 96 kHz sampling frequency, use connection .

* Manufactured under license from Dolby Laboratories. “Dolby,” “Pro Logic,” and the double-D symbol are trademarks of Dolby Laboratories.

**“DTS” and “DTS Digital Surround” are registered trademarks of Digital Theater Systems, Inc.

A Connecting to your TV

This connection will use your TV's speakers for sound.

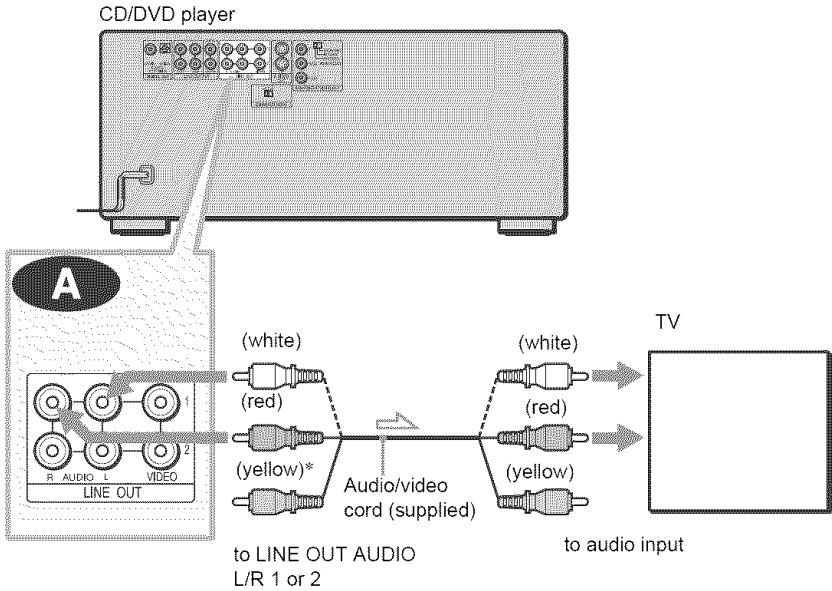

→ : Signal flow

* The yellow plug is used for video signals (page 19).

💡 Hint

When connecting to a monaural TV, use a stereo-mono conversion cord (not supplied). Connect the LINE OUT AUDIO L/R 1 or 2 jacks to the TV's audio input jack.

B Connecting to a stereo amplifier (receiver) and 2 speakers/Connecting to an MD deck or DAT deck

If the stereo amplifier (receiver) has audio input jacks L and R only, use **B-1**. If the amplifier (receiver) has a digital input jack, or when connecting to an MD deck or DAT deck, use **B-2**. In this case, you can also connect the player directly to the MD deck or DAT deck without using your stereo amplifier (receiver).

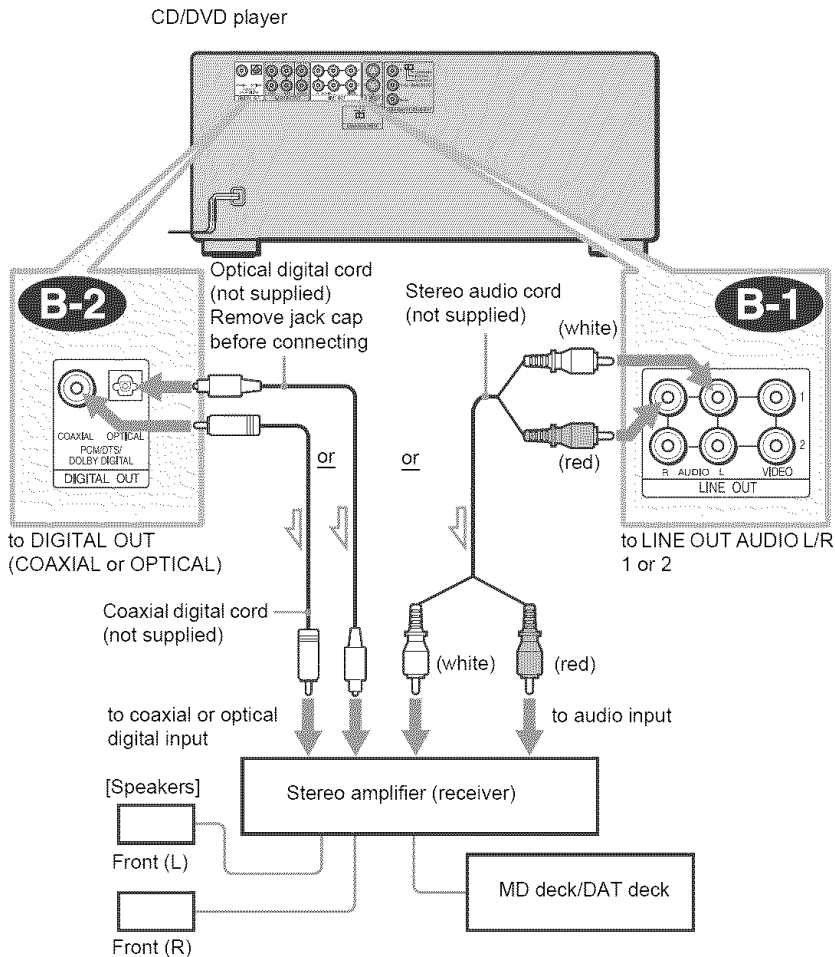

⇒: Signal flow

Hint

To realize better surround sound effects, make sure that your listening position is in between your speakers.

Note

Super Audio CD audio signals are not output from the digital jack.

C Connecting to an AV amplifier (receiver) having a Dolby Surround (Pro Logic) decoder and 3 to 6 speakers

You can enjoy the Dolby Surround effects only when playing Dolby Surround audio or multi-channel audio (Dolby Digital) discs.

If your amplifier (receiver) has L and R audio input jacks only, use **C-1**. If your amplifier (receiver) has a digital input jack, use **C-2**.

CD/DVD player

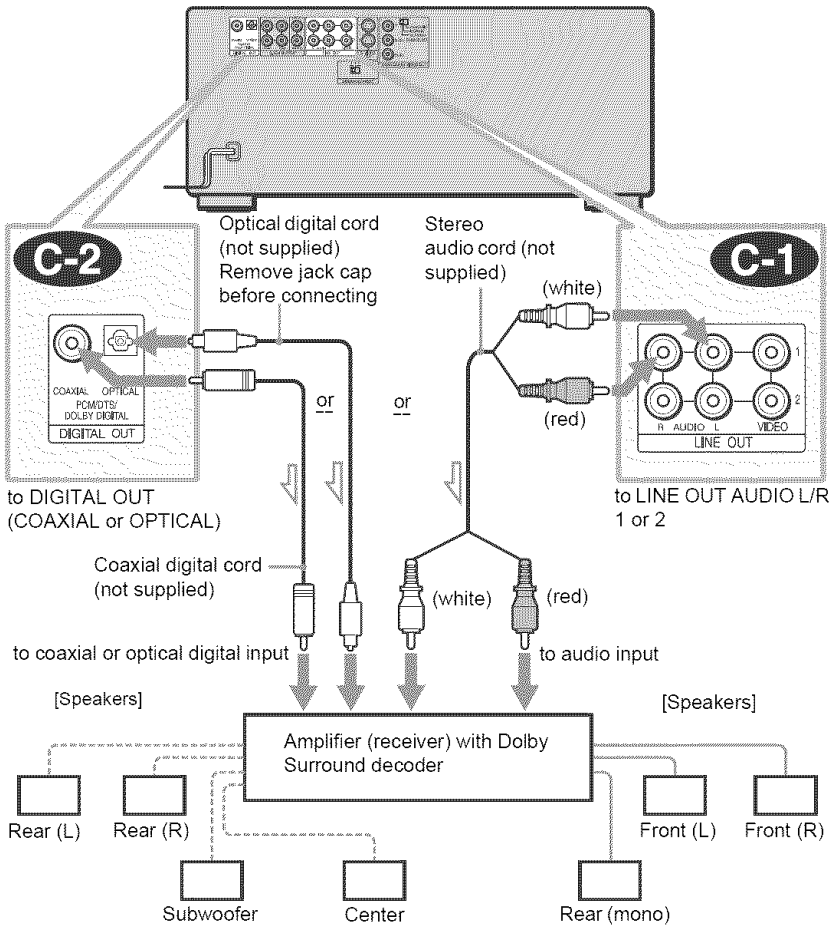

⇒: Signal flow

Hint

For correct speaker location, refer to the operating instructions of the amplifier (receiver).

Notes

- When connecting 6 speakers, replace the monaural rear speaker with a center speaker, 2 rear speakers and a subwoofer.
- Super Audio CD audio signals are not output from the digital jack.

→ continued

D Connecting to an AV amplifier (receiver) with 5.1 ch input jacks and/or a digital input jack and 4 to 6 speakers

If your AV amplifier (receiver) has 5.1 channel inputs, use **D-1**.

If you want to use the Dolby Digital, or DTS decoder function on your AV amplifier (receiver), connect to its digital jack using **D-2**. With the following connections, you can enjoy a more realistic audio presence in the comfort of your own home.

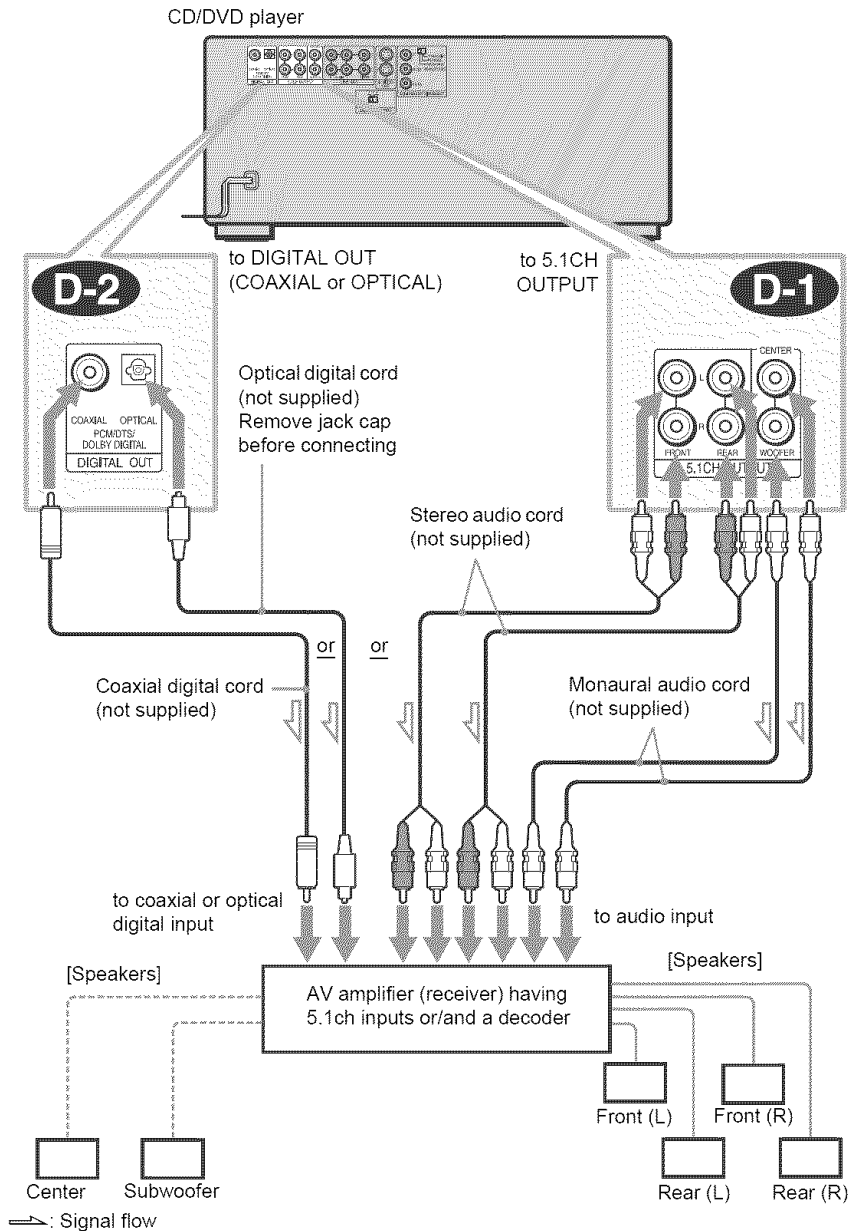

D-1 : Connecting to the 5.1ch input jacks

You can enjoy 5.1ch surround sound using the internal Dolby Digital, DTS, or Super Audio CD Multi decoder of this player.

(when 6 speakers are connected, set “SURROUND” to “OFF.”)

You can also enjoy Dolby Surround (Pro Logic) sound, or surround sounds using various “SURROUND” modes (page 69).

D-2 : Connecting to a digital jack

This connection will allow you to use the Dolby Digital, or DTS decoder function of your AV amplifier (receiver). You are not able to enjoy the surround sound effects of this player.

💡 Hints

- For correct speaker placement, refer to the instructions of the connected components.
- To enhance the sound performance:
 - Use high-performance speakers.
 - Use front, rear, and center speakers of the same size and performance.
 - Place the subwoofer between the left and right front speakers.
- Use connection **D-2** when connecting to 7 or more speakers (6.1ch or more).

Notes**For connection **D-2****

- After you have completed the connection, be sure to set “DOLBY DIGITAL” to “DOLBY DIGITAL” and “DTS” to “DTS” in Quick Setup (page 28).
- When you connect an amplifier (receiver) that conforms to the 96kHz sampling frequency, set “48kHz/96kHz PCM” in “AUDIO SETUP” to “96kHz/24bit” (page 91).
- Super Audio CD audio signals are not output from the digital jack.

Step 5: Connecting the Power Cord

Plug the power cords of the player and TV into an AC outlet.

Step 6: Quick Setup

Follow the steps below to make the minimum number of basic adjustments for using the player. To skip an adjustment, press **▶▶**. To return to the previous adjustment, press **◀◀**.

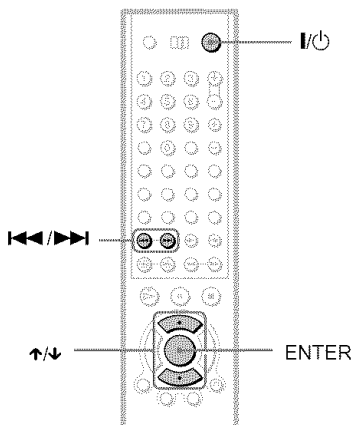

1 Turn on the TV.

2 Press I/O.

3 Switch the input selector on your TV so that the signal from the player appears on the TV screen.

“Press [ENTER] to run QUICK SETUP” appears at the bottom of the screen. If this message does not appear, select “QUICK” under “SETUP” in the Control Menu to run Quick Setup (page 86).

4 Press ENTER before inserting a disc.

The Setup Display for selecting the language used in the on-screen display appears.

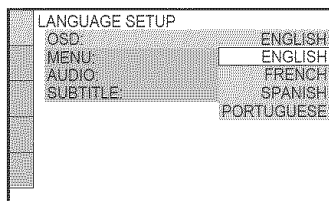

5 Press **↑/↓** to select a language.

The player uses the language selected here to display the menu and subtitles as well.

6 Press ENTER.

The Setup Display for selecting the aspect ratio of the TV to be connected appears.

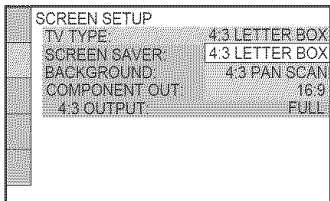

7 Press \uparrow/\downarrow to select the setting that matches your TV type.

- ◆ If you have a 4:3 standard TV
 - 4:3 LETTER BOX or 4:3 PAN SCAN (page 87)
- ◆ If you have a wide-screen TV or a 4:3 standard TV with a wide-screen mode
 - 16:9 (page 87)

8 Press ENTER.

The Setup Display for selecting the type of video signal appears.

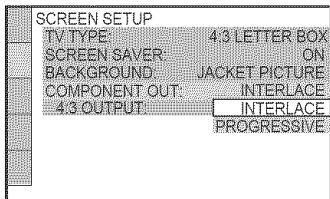

9 Press \uparrow/\downarrow to select the type of signals you wish to output to your TV.

Select "PROGRESSIVE" only if you have made video connection **C** (page 19) and wish to view progressive video signals.

- ◆ Interlace format TV (standard TV)
 - INTERLACE (page 87)
- ◆ Progressive format TV
 - PROGRESSIVE (page 87)

10 Press ENTER.

The Setup Display for selecting the type of jack used to connect your amplifier (receiver) appears.

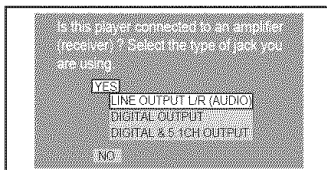

11 Press \uparrow/\downarrow to select the type of jack (if any) you are using to connect to an amplifier (receiver), then press ENTER.

Choose the item that matches the audio connection you selected on pages 23 to 26 (**A** through **D**).

- A**
 - If you connect just a TV and nothing else, select "NO." Quick Setup is finished and connections are complete.
- B-1 C-1**
 - Select "LINE OUTPUT L/R (AUDIO)." Quick Setup is finished and connections are complete.
- B-2 C-2 D-2**
 - Select "DIGITAL OUTPUT." The Setup Display for "DOLBY DIGITAL" appears.
- D-1 or both D-1 and D-2**
 - Select "DIGITAL&5.1CH OUTPUT." The display for "DOLBY DIGITAL" appears.

12 Press \uparrow/\downarrow to select the type of Dolby Digital signal you wish to send to your amplifier (receiver).

Choose the signal that matches the audio connection you selected on pages 24 to 26 (**B** through **D**).

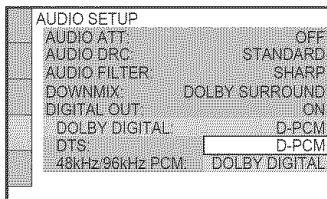

- B-2 C-2**
 - D-PCM (page 91)

D-2

- DOLBY DIGITAL (only if the amplifier (receiver) has a Dolby Digital decoder) (page 91)

13 Press ENTER.

“DTS” is selected.

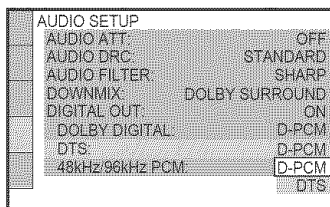
**14** Press \uparrow/\downarrow to select the type of DTS signal sent to your amplifier (receiver).

Choose the item that matches the audio connection you selected on pages 24 to 26 (**B** through **D**).

B-2 **C-2**

- D-PCM (page 91)

D-2

- DTS (only if the amplifier (receiver) has a DTS decoder) (page 91)

15 Press ENTER.

- ◆ When “DIGITAL OUT” is selected in step 11

- Quick Setup is finished and connections are complete.

- ◆ When “DIGITAL & 5.1CH OUTPUT” is selected in step 11

- The Setup Display for “SPEAKER SETUP” appears.

16 Press \uparrow/\downarrow to select the size of the center speaker.

If no center speaker is connected, select “NONE” (page 92).

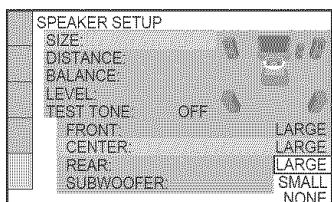
**17** Press ENTER.

“REAR” is selected.

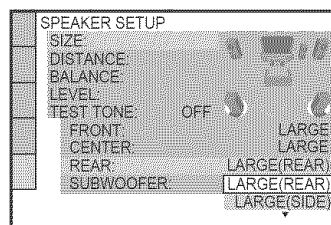
**18** Press \uparrow/\downarrow to select the size of the rear speakers.

If no rear speaker is connected, select “NONE.”

19 Press ENTER.

“SUBWOOFER” is selected.

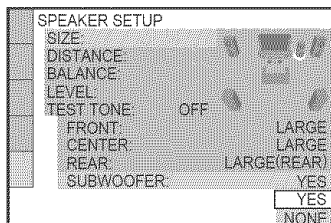
**20** Press \uparrow/\downarrow to select whether or not you have connected a subwoofer.**21** Press ENTER.

Quick Setup is finished. All connections and setup operations are complete.

Enjoying the surround sound effects

To enjoy the surround sound effects of this player or your amplifier (receiver), set the following items as described below for the audio connection you selected on pages 24 to 26 (**B** through **D**). Each of these is the default setting and does not need to be adjusted when you first connect the player. See page 85 for using the Setup Display.

Audio connection (pages 23 to 26)

A

- No additional settings are needed.

B-1 C-1

- Set “DOWNMIX” to “DOLBY SURROUND” (page 91).

B-2 C-2 D-2

- Set “DOWNMIX” to “DOLBY SURROUND” (page 91).
- Set “DIGITAL OUT” to “ON” (page 91).

D-1

- Set “DISTANCE,” “BALANCE,” and “LEVEL” according to the connected speakers (page 92).

💡 Hints

- **For connections B-1 C-1 D-1**
If the sound distorts even when the volume is turned down, set “AUDIO ATT” to “ON” (page 90).
- **For connections B-2 C-2 D-2**
Set “48kHz/96kHz PCM” to “96kHz/24bit” only if you connect an amplifier (receiver) that conforms to the 96 kHz sampling frequency (page 91).

Inserting Discs **DVD-V**

DVD-RW **SA-CD** **VCD** **CD**

DATA CD

You can insert up to 400 discs into this player.

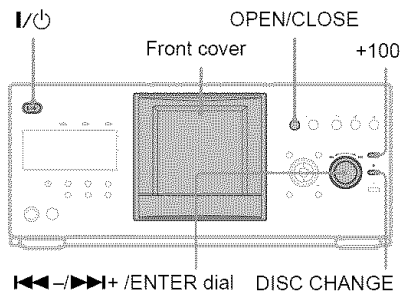

1 Press I/O.

The player turns on.

2 Press OPEN/CLOSE.

The front cover opens.

3 Press DISC CHANGE.

The DISC CHANGE indicator lights up.

4 While checking the disc slot number indicated on the front panel display or by the slot, turn the **◀◀-/▶▶+ / ENTER dial** until you find the disc slot where you want to insert a disc.

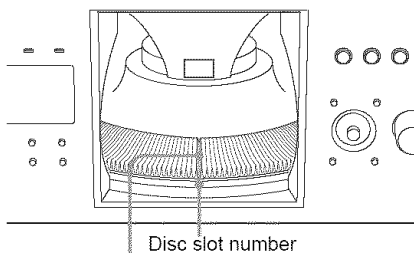

5 Insert a disc.

Gently place the disc all the way into the slot and do not release the disc until it is completely seated. Make sure you have

inserted the disc into each slot at a right angle to the rotary table. If the disc is not put in straight, it may damage the player or the disc.

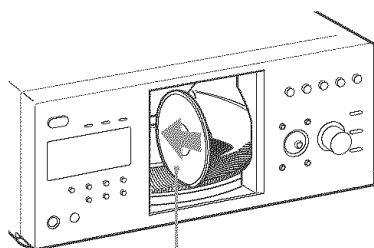

With the playback side facing left

6 Repeat steps 4 and 5 to insert more discs.

7 Press OPEN/CLOSE.

The front cover closes. The rotary table turns and the disc slot selected in step 4 is set to the playing position.

Hint

In step 4, you can select a disc slot number by skipping 10 slots. After sliding the TV/DISC EXPLORER/DVD switch to DISC EXPLORER or DVD, press DISC SKIP +/- on the remote. 10 disc slots before or after the current disc slot number will be skipped. To skip 100 slots, press +100 on the player.

Notes

- Do not turn the turntable by hand.
- Do not reach inside of the turntable compartment. Always follow the correct steps for inserting and removing discs.
- When transporting the player, remove all discs from the player. Failure to remove the discs may cause damage to the player.
- When closing the front cover, be careful not to let anything get caught between the door and the player.

To remove discs

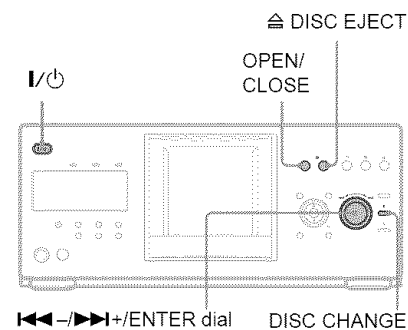

- 1 Press OPEN/CLOSE.
- 2 Press DISC CHANGE.
- 3 While checking the disc slot number indicated on the front panel display or by the slot, turn the ◀▶+/ENTER dial until you find the disc you want to remove.
- 4 Press ≡ DISC EJECT.
The loading guide rises so that you can remove the disc easily.

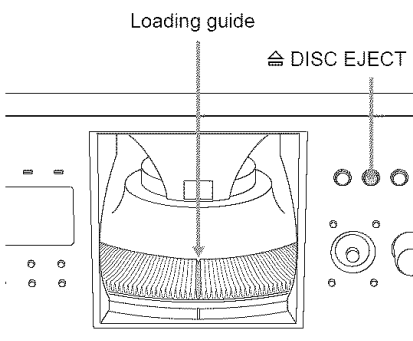

- 5 Remove the disc.
- 6 Repeat steps 3 to 5 to remove other discs.
- 7 Press OPEN/CLOSE.
The front cover closes.

Hint

You can remove the current disc by directly pressing ≡ DISC EJECT on the player.

Playing Discs **DVD-V**

DVD-RW SA-CD VCD CD

DATA CD

Depending on the disc, some operations may be different or restricted.

Refer to the operating instructions supplied with your disc.

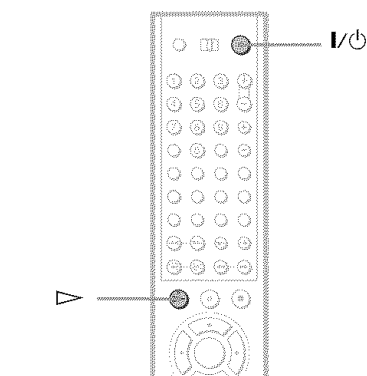
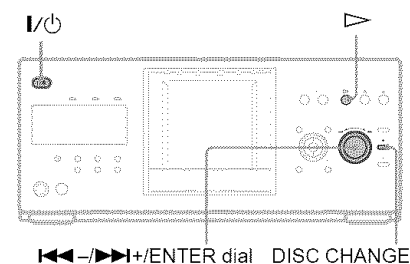

- 1 Turn on your TV.
- 2 Press I/⏻.
The player turns on.
- 3 Switch the input selector on your TV so that the signal from the player appears on the TV screen.



- ◆ When using an amplifier (receiver)
Turn on the amplifier (receiver) and select the appropriate channel so that you can hear sound from the player.



4 Press .

The player starts playing the selected disc. Adjust the volume on the TV or the amplifier (receiver).

Depending on the disc, a menu may appear on the TV screen. For DVD VIDEOS, see page 37. For VIDEO CDs, see page 40.

To change the disc

Press DISC CHANGE to turn the indicator on. Then turn the -+ / ENTER dial until the desired disc number appears on the front panel display.

Press the -+ / ENTER dial to start playback.

To turn off the player

Press . The player enters standby mode.

Hints





- You can have the player turn off automatically whenever you leave it in stop mode for more than 30 minutes. To turn on this function, set "AUTO POWER OFF" in "CUSTOM SETUP" to "ON" (page 89).
- For details on the types of MP3 audio tracks that you can play on this player, or on their playback order, see "Selecting and Playing an MP3 Audio Track" on page 41.
- You can select to play a disc from a list of all the discs inserted in the player. For details, see "Displaying the Disc Information" (page 49).

Note

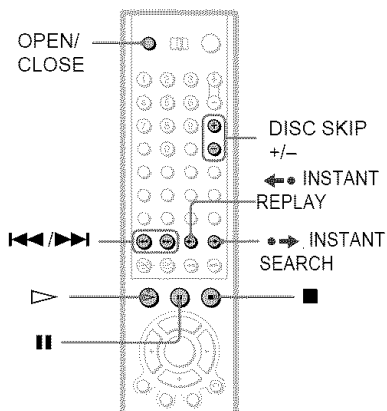
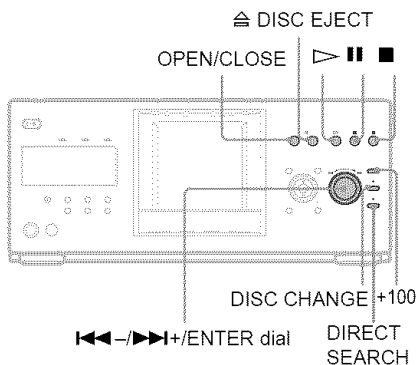
Super Audio CD audio signals are not output from the digital output jack.

Additional operations



To	Operation
Select a disc	<p>On the player: Press DISC CHANGE to turn the indicator on. Then turn the -+ / ENTER dial until the desired disc number appears on the front panel display. Press the -+ / ENTER dial to start playback.</p> <p>On the remote: Press DISC SKIP +/- until the desired disc number appears in the front panel display.</p>

To	Operation
Skip disc slots	On the player: To skip 100 disc slots ahead, press +100. Press ENTER to start playback. On the remote: After sliding the TV/ DISC EXPLORER/ DVD switch to DISC EXPLORER or DVD, press DISC SKIP +/-.
Stop	Press ■.
Pause	Press II.
Resume play after pause	Press II or ▷.
Go to the next chapter, track, or scene in continuous play mode	On the player: Press DIRECT SEARCH to turn the indicator on. Then turn the ◀◀-▶▶+/-/ ENTER dial clockwise. On the remote: Press ▶▶.
Go back to the previous chapter, track, or scene in continuous play mode	On the player: Press DIRECT SEARCH to turn the indicator on. Then turn the ◀◀-▶▶+/-/ ENTER dial counterclockwise. On the remote: Press ◀◀ twice.
Stop play and remove the disc	On the player: Press ⏏ DISC EJECT. On the remote: Press OPEN/CLOSE.
Replay the previous scene*	Press ◀• INSTANT REPLAY.
Briefly fast forward the current scene**	Press •▶ INSTANT SEARCH.

* DVD VIDEO/DVD-RW/DVD-R only

** DVD VIDEO/DVD-RW/DVD-R/DVD+RW only

💡 Hints

- The Instant Replay function is useful when you want to review a scene or dialog that you missed.
- The Instant Search function is useful when you want to pass over a scene that you don't want to watch.

Notes

- You may not be able to use the Instant Replay or Instant Search function with some scenes.
- The Instant Replay function does not work with DVD+RWs.

Locking the front cover (Child Lock)

You can lock the front cover to prevent children from opening it.

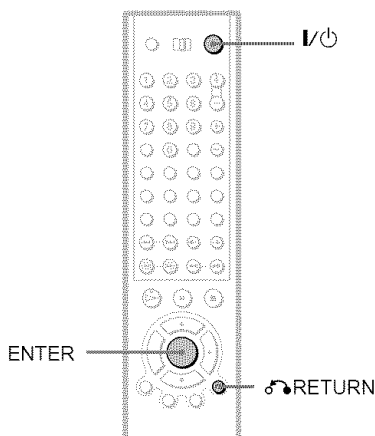

When the player is in standby mode, press ⏏ RETURN, ENTER, and then I/⏻ on the remote.

The player turns on and “LOCKED” appears on the front panel display.

The OPEN/CLOSE button on the player and the remote do not work while the Child Lock is set.

To unlock the front cover

When the player is in standby mode, press ⏏ RETURN, ENTER, and then I/⏻ again.

Note

Even if you select “RESET” under “SETUP” in the Control Menu (page 86), the front cover remains locked.

Resuming Playback From the Point Where You Stopped the Disc (Resume

Play) **DVD-V** **DVD-RW** **SA-CD** **VCD**

CD **DATA CD**

The player remembers the point where you stopped the disc, even if you press **I/⏏** and the player enters standby mode.

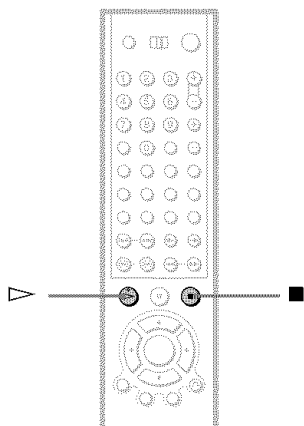

1 While playing a disc, press **■** to stop playback.

“RESUME” appears on the front panel display.

2 Press **▷**.

The player starts playback from the point where you stopped the disc in step 1.

Hint

To play from the beginning of the disc, press **■** twice, then press **▷**.

Notes

- The point where you stopped playing is cleared when:
 - you change the play mode.
 - you open the front cover.
 - you change the slot.
 - you disconnect the power cord.

- When playing a DATA CD, the point where you stopped playing is cleared when the player enters standby mode.
- This function is not available for Program Play or Shuffle Play.
- This function may not work with some discs.

Using the DVD's Menu

DVD-V

A DVD is divided into long sections of a picture or a music feature called "titles." When you play a DVD which contains several titles, you can select the title you want using the TOP MENU/EDIT button. When you play DVDs that allow you to select items such as the language for the subtitles and the language for the sound, select these items using the MENU/SORT button.

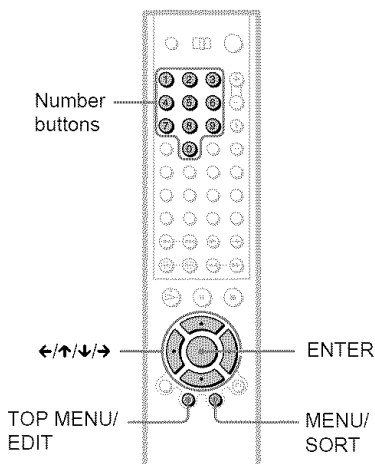

4 Press ENTER.

Hint

You can also display the disc's menu by pressing TOP MENU or MENU on the player.

- 1 Select a disc (page 34).
- 2 Press TOP MENU/EDIT or MENU/SORT.
The disc's menu appears on the TV screen. The contents of the menu vary from disc to disc.
- 3 Press ←/↑/↓/→ or the number buttons to select the item you want to play or change.

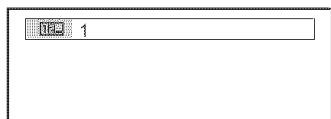

Selecting "ORIGINAL" or "PLAY LIST" on a DVD-RW

Some DVD-RWs in VR (Video Recording) mode have two types of titles for playback: originally recorded titles (ORIGINAL) and edited titles created on recordable DVD players (PLAY LIST). You can select the type of titles to be played.

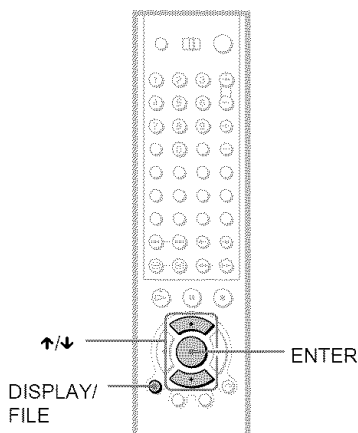

1 Select a disc (page 34).

2 Press DISPLAY/FILE while the player is in stop mode.

The Control Menu appears.

3 Press ↑/↓ to select  (ORIGINAL/PLAY LIST), then press ENTER.

The options for "ORIGINAL/PLAY LIST" appear.

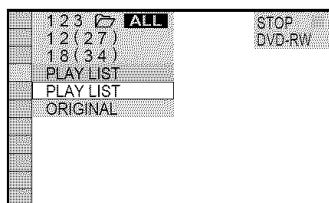

4 Press ↑/↓ to select the setting.

- PLAY LIST: plays the titles created from "ORIGINAL."
- ORIGINAL: plays the titles originally recorded.

5 Press ENTER.

To turn off the Control Menu

Press DISPLAY/FILE repeatedly until the Control Menu is turned off.

Note

Repeat Play and A-B Repeat Play do not work across "ORIGINAL" and "PLAY LIST" titles.

Selecting a Playback Area for a Super Audio CD

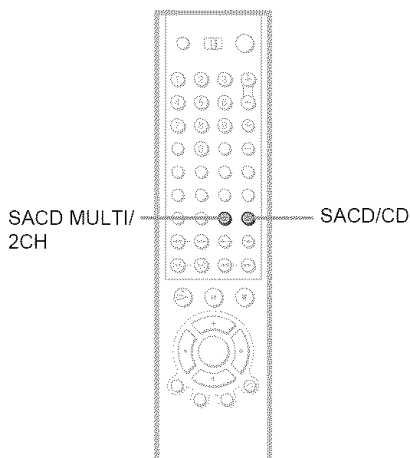

Hint

You can also select “MULTI/2CH” from the Control Menu (page 15).

Selecting the playback layer of hybrid Super Audio CDs

Some Super Audio CDs consist of an HD layer and a CD layer. You can select the playback layer you want to listen to.

1 Press SACD/CD while the player is in stop mode.

Each time you press the button, an HD layer or a CD layer is alternately selected. When playing a CD layer, the “CD” indicator in the front panel display lights up.

Notes

- For details about Super Audio CDs, see page 98.
- Each play mode function works only within the selected layer or playback area (page 43).

Selecting a playback area on a 2 channel + Multi-channel Super Audio CD

Some Super Audio CDs consist of a 2 channel playback area and a multi-channel playback area. You can select the playback area you want to listen to.

1 Press SACD MULTI/2CH while the player is in stop mode.

The following display appears.

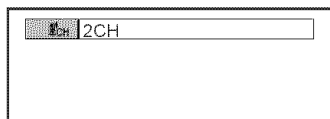

2 Press SACD MULTI/2CH repeatedly to select an item.

- MULTI: Plays a multi-channel playback area.
 - 2CH: Plays a 2 channel playback area.
- The “MULTI” indicator in the front panel display lights up when playing a multi-channel playback area.

Playing VIDEO CDs With PBC Functions (PBC Playback)

VCD

PBC (Playback Control) allows you to play VIDEO CDs interactively by following the menu on the TV screen.

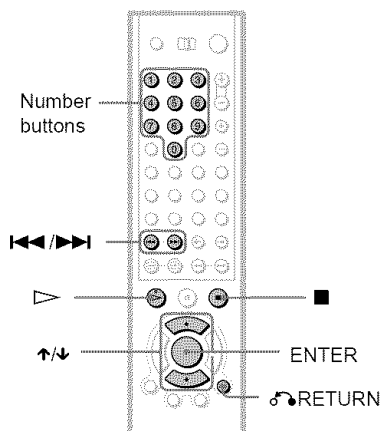

1 Start playing a VIDEO CD with PBC functions.

A menu appears.

2 Select the item number and track you want using \uparrow/\downarrow or the number buttons.

3 Press ENTER.

4 Follow the instructions in the menu for interactive operations.

Refer to the instructions supplied with the disc, as the operating procedure may differ depending on the VIDEO CD.

Hint

To play without using PBC, press \lll/\ggg while the player is stopped to select a track, then press \triangleright or ENTER.

“Play without PBC.” appears on the TV screen and the player starts continuous play. You cannot play still pictures such as a menu.

To return to PBC playback, press \blacksquare twice then press \triangleright .

Note

Depending on the VIDEO CD, “Press ENTER” in step 3 may appear as “Press SELECT” in the instructions supplied with the disc. In this case, press \triangleright .

To return to the menu

Press \curvearrowright RETURN.

Selecting and Playing an MP3 Audio Track **DATA CD**

You can play selected tracks on DATA CDs (CD-ROMs/CD-Rs/CD-RWs) recorded in MP3 (MPEG1 Audio Layer 3) format.

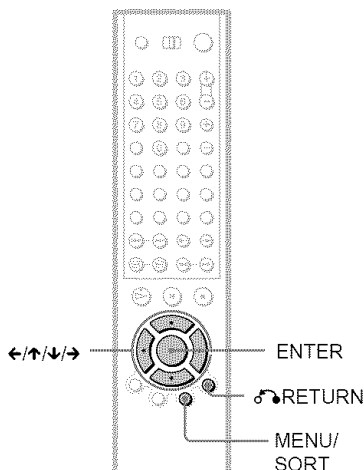

1 Select a disc (page 34).

2 Press MENU/SORT.

The list of MP3 albums recorded on the DATA CD appears.

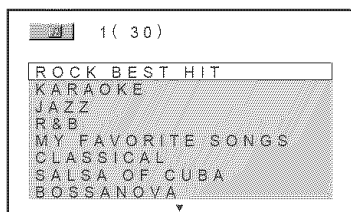

3 Press \uparrow/\downarrow to select an album, then press ENTER.

The list of tracks contained in the album appears.

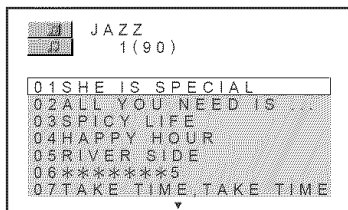

4 Press \uparrow/\downarrow to select a track, then press ENTER.

The selected track starts playing.

When a track or album is being played, its title is shaded.

To go to the next or previous page

Press \rightarrow or \leftarrow .

To return to the previous display

Press \curvearrowright RETURN.

To turn off the display

Press MENU/SORT.

Hint

You can also display the lists with the MENU button on the player.

Notes

About playback

- This player can play MP3 audio tracks recorded in the following sampling frequencies: 32 kHz, 44.1 kHz, 48 kHz.
- The player cannot play audio tracks in MP3PRO format.
- If you add the extension “.MP3” to data not in MP3 format, the player cannot recognize the data properly and will generate a loud noise which could damage your speaker system.
- The playback order may be different from the edited order. See “The playback order of MP3 audio tracks” (page 42) for details.

About the list display

- Only the letters in the alphabet and numbers can be used for album or track names. Anything else is displayed as “*”.
- ID3 tags cannot be displayed.

About MP3 audio tracks

You can play MP3 audio tracks on CD-ROMs, CD-Rs, or CD-RWs. However, the discs must be recorded according to ISO9660 level 1, level 2, or Joliet format for the player to recognize the tracks.

You can also play discs recorded in Multi Session.

Refer to the instructions of the CD-R/RW device or recording software (not supplied) for details on the recording format.

To play a Multi Session CD

This player can play Multi Session CDs when an MP3 audio track is located in the first session. Any subsequent MP3 audio tracks, recorded in the later sessions, can also be played back.

When audio tracks and images in music CD format or Video CD format are recorded in the first session, only the first session will be played back.

The playback order of MP3 audio tracks

The playback order of albums and tracks recorded on a DATA CD is as follows.

◆ Structure of disc contents

Tree 1 Tree 2 Tree 3 Tree 4 Tree 5

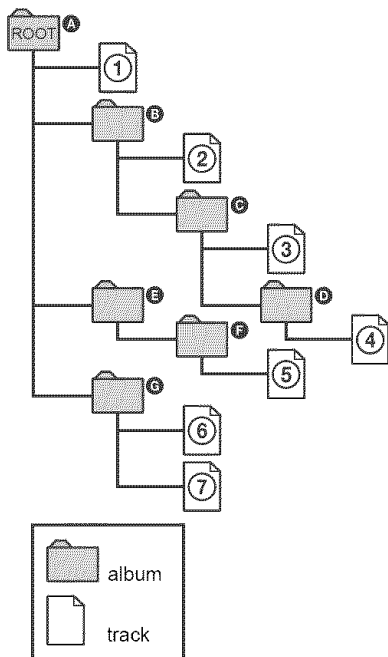

When you play a DATA CD from its beginning (page 33), the numbered tracks are played sequentially, from ① through ⑦. Any sub-albums/tracks contained within a currently selected album take priority over the next album in the same tree. (Example: C contains D so ④ is played before ⑤.) When you press MENU and the list of MP3 albums appears (page 41), the albums are arranged in the following order: A → B → C → D → F → G. Albums that do not contain tracks (such as album E) do not appear in the list.

💡 Hints

- If you add numbers (01, 02, 03, etc.) to the front of the track names, the tracks will be played in that order.
- Since a disc with many trees takes longer to start playback, it is recommended that you create albums of no more than two trees.

Notes

- Depending on the software you use to create the DATA CD, the playback order may differ from the illustration above.
- The playback order above may not be applicable if there are more than a total of 999 albums and tracks in the DATA CD.
- The player can recognize up to 499 albums (the player will count just albums, including albums that do not contain MP3 audio tracks). The player will not play any albums beyond the first 499 albums. Of the first 499 albums, the player will play no more than a combined total of 999 albums and tracks.

Various Play Mode Functions (Program Play, Shuffle Play, Repeat Play, A-B Repeat Play)

You can set the following play modes:

- Program Play (page 44)
- Shuffle Play (page 46)
- Repeat Play (page 46)
- A-B Repeat Play (page 47)

Notes

- The play mode is canceled when:
 - you open the front cover.
 - you press **⏏** and the player enters standby mode.
- Before setting a play mode for Super Audio CDs, select the playback layer or area you want to listen to (page 39). Each play mode function works only within the selected layer or playback area.

Selecting the disc mode (One Disc or All Discs) **DVD-V** **DVD-RW**

SA-CD **VCD** **CD** **DATA CD**

You can play one disc or all of the discs in the player. Before setting Program Play, Shuffle Play, or Repeat Play, you must select whether to apply these play modes to one disc or to all of the discs.

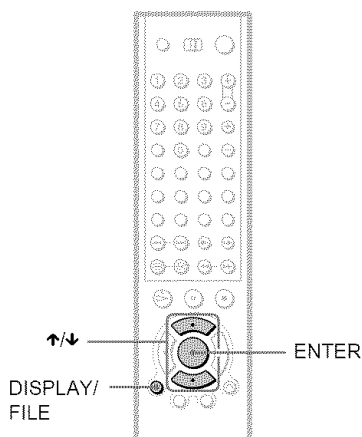

- 1 Press DISPLAY/FILE twice (once for DATA CDs) during playback.**
The Control Menu appears.

→ continued

- 2** Press \uparrow/\downarrow to select  or  (ONE/ALL DISCS) and press ENTER.

The options for “ONE DISC/ALL DISCS” appear.

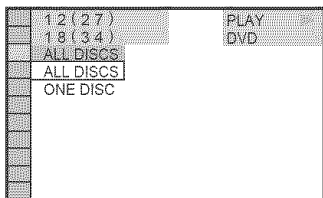

- 3** Press \uparrow/\downarrow to select an item.
- ALL DISCS: Continuously plays all of the discs.
 - ONE DISC: Plays the selected disc.

- 4** Press ENTER.

Hint

You can also select “ONE DISC/ALL DISCS” by pressing ONE/ALL DISCS on the player.

Creating your own program (Program Play) **DVD-V** **SA-CD** **VCD**

CD

You can play the contents of a disc in the order you want by arranging the order of the titles, chapters, or tracks on the disc to create your own program.

You can program up to 99 items. By selecting All Discs mode (page 43), you can create a program for all of the discs in the player.

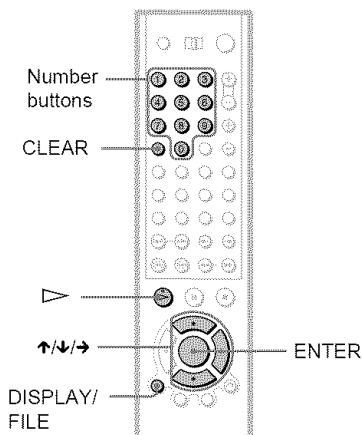

- 1** Press DISPLAY/FILE twice. The Control Menu appears.

- 2** Press \uparrow/\downarrow to select  (PROGRAM), then press ENTER. The options for “PROGRAM” appear.

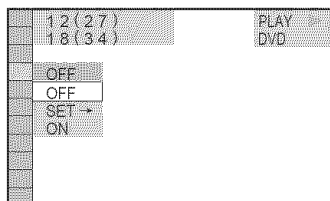

- 3** Press \uparrow/\downarrow to select “SET ->” then press ENTER. The display for programming appears.

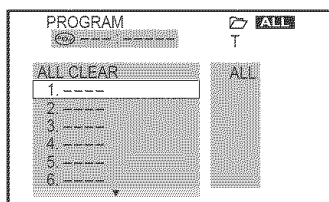

- 4** Press \rightarrow . The player is ready to program the first disc.

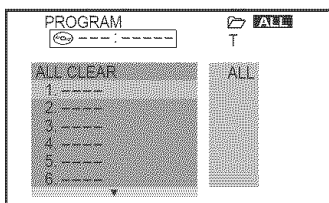

- 5** Select the disc you want to program using the number buttons or \uparrow/\downarrow , then press ENTER.

The cursor moves to the title or track row “T” (in this case, “01”).

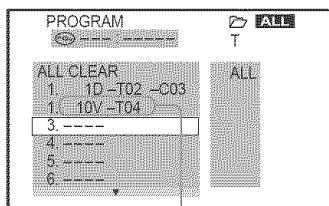
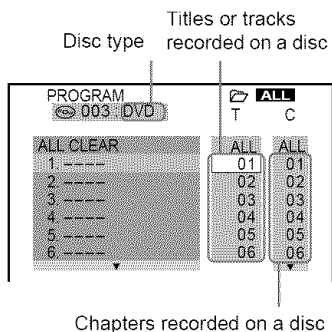

"?" appears when the player has not loaded the disc information in the memory. If an empty slot is loaded, the disc type does not appear.

6 Select the title, chapter, or track you want to program.

◆ When playing a DVD VIDEO

For example, select chapter "03" of title "02."

Press \uparrow/\downarrow or the number buttons to select "02" under "T," then press ENTER.

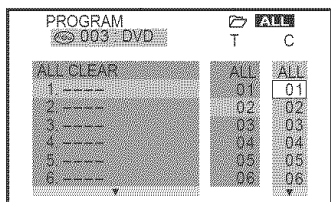

Next, press \uparrow/\downarrow or the number buttons to select "03" under "C," then press ENTER.

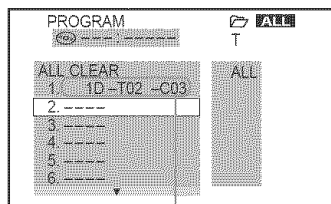

◆ When playing a VIDEO CD, Super Audio CD or CD

For example, select track "04."
Press \uparrow/\downarrow or the number buttons to select "04" under "T," then press ENTER.

7 To program other discs, titles, chapters, or tracks, repeat steps 4 to 6.

The programmed discs, titles, chapters, and tracks are displayed in the selected order.

8 Press \triangleright to start Program Play.

Program Play begins.

When the program ends, you can restart the same program again by pressing \triangleright .

To return to normal playback

Press CLEAR, or select "OFF" in step 3.

To turn off the display

Press DISPLAY/FILE repeatedly until the display is turned off.

To cancel or change a program

1 Follow steps 1 to 3 of "Creating your own program (Program Play)."

2 Select the program number of the disc, title, chapter, or track you want to cancel or change using \uparrow/\downarrow .

3 Perform the following.

◆ To cancel the program

Press CLEAR.

◆ To change the program

Press \rightarrow and follow step 5 for new programming.

To cancel all of the discs, titles, chapters, or tracks in the program

1 Follow steps 1 to 3 of "Creating your own program (Program Play)."

2 Press \uparrow and select "ALL CLEAR."

3 Press ENTER.

Hint

You can set Repeat Play or Shuffle Play for the programmed titles, chapters, or tracks. During Program Play, follow the steps of “Repeat Play” (page 46) or “Shuffle Play” (page 46).

Note

Program Play will not start if you select One Disc mode and the program does not include anything from the current disc.

Playing in random order (Shuffle Play)

DVD-V DVD-RW SA-CD VCD CD

You can have the player “shuffle” titles, chapters, or tracks. Subsequent “shuffling” may produce a different playing order. By selecting All Discs mode (page 43), you can shuffle all of the discs in the player.

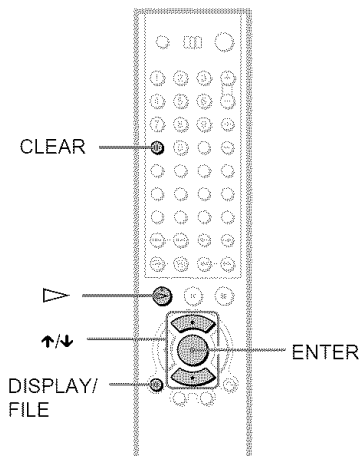

1 Press DISPLAY/FILE twice during playback.

The Control Menu appears.

2 Press to select (SHUFFLE), then press ENTER.

The options for “SHUFFLE” appear.

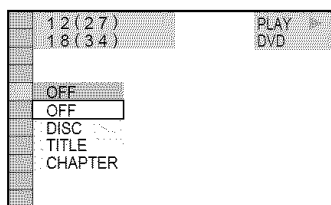

3 Press to select the item to be shuffled.

◆ When playing a DVD VIDEO

- DISC*
- TITLE
- CHAPTER

◆ When playing a Super Audio CD, VIDEO CD, or CD

- DISC*
- TRACK

◆ When playing a DVD-RW, or DATA CD

- DISC*

◆ When Program Play is activated

- ON: shuffles titles, chapters, or tracks selected in Program Play.

4 Press ENTER.

* You can select “DISC” in All Discs mode only.

To return to normal play

Press CLEAR, or select “OFF” in step 3.

Hints

- You can set Shuffle Play while the player is stopped. After selecting the “SHUFFLE” option, press . Shuffle Play starts.
- Up to 96 chapters in a disc can be played in random order when “CHAPTER” is selected.

Playing repeatedly (Repeat Play)

DVD-V DVD-RW SA-CD VCD CD DATA CD

You can play all of the titles, albums or tracks on a disc or a single title, chapter, album, or track repeatedly.

You can use a combination of Shuffle or Program Play modes. By selecting All Discs mode (page 43), you can repeat all of the discs in the player.

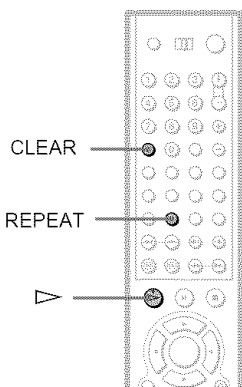

1 Press REPEAT during playback.
The following display appears.

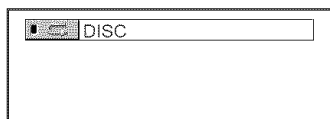

2 Press REPEAT repeatedly to select the item to be repeated.

◆ **When playing a DVD VIDEO**

- DISC: repeats all of the titles on the current disc in One Disc mode, or all of the discs in All Discs mode.
- TITLE: repeats the current title on a disc.
- CHAPTER: repeats the current chapter.

◆ **When playing a DVD-RW**

- DISC: repeats all of the titles on the selected type in One Disc mode, or all of the discs in All Discs mode.
- TITLE: repeats the current title on a disc.
- CHAPTER: repeats the current chapter.

◆ **When playing a Super Audio CD, VIDEO CD, or CD**

- DISC: repeats all of the tracks on the current disc in One Disc mode, or all of the discs in All Discs mode.
- TRACK: repeats the current track.

◆ **When playing a DATA CD (MP3 audio)**

- DISC: repeats all of the albums on the current disc in One Disc mode, or all of the discs in All Discs mode.
- ALBUM: repeats the current album.

- TRACK: repeats the current track.
- ◆ **When Program Play or Shuffle Play is activated**
- ON: repeats Program Play or Shuffle Play.

To return to normal play

Press CLEAR, or select "OFF" in step 2.

Hints

- You can set Repeat Play while the player is stopped. After selecting the "REPEAT" option, press . Repeat Play starts.
- You can also select "REPEAT" from the Control Menu (page 14).

Repeating a specific portion (A-B Repeat Play)

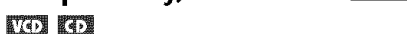

You can play a specific portion of a title, chapter or track repeatedly. (This function is useful when you want to memorize lyrics, etc.)

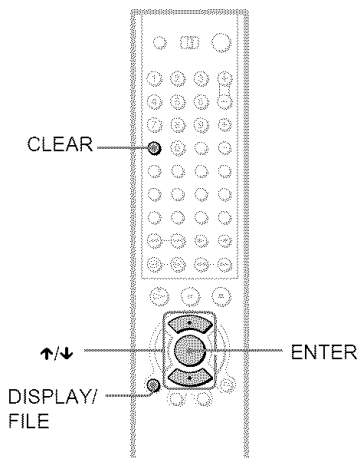

1 Press DISPLAY/FILE twice during playback.
The Control Menu appears.

2 Press to select (A-B REPEAT), then press ENTER.
The options for "A-B REPEAT" appear.

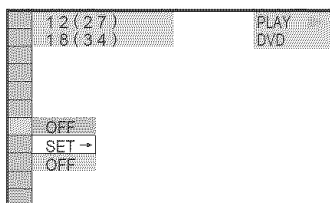

3 Press **↑/↓** to select “SET →,” then press **ENTER**.

The “A-B REPEAT” setting display appears.

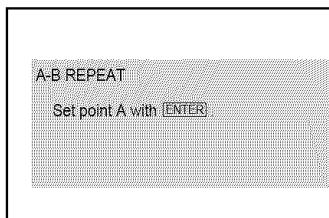

4 During playback, when you find the starting point (point A) of the portion to be played repeatedly, press **ENTER**.

The starting point (point A) is set.

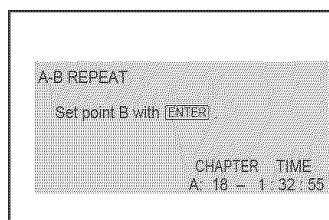

5 When you reach the ending point (point B), press **ENTER** again.

The set points are displayed and the player starts repeating this specific portion.

To return to normal play

Press **CLEAR**, or select “OFF” in step 2.

To turn off the Control Menu

Press **DISPLAY/FILE** repeatedly until the Control Menu is turned off.

Notes

- When you set A-B Repeat Play, the settings for Shuffle Play, Repeat Play, and Program Play are canceled.
- A-B Repeat Play does not work for titles containing still pictures on a DVD-RW in VR mode.
- A-B Repeat Play does not work across multiple titles (“ORIGINAL” or “PLAY LIST”) on a DVD-RW in VR mode.

Searching for and Managing Discs (Disc Explorer)

Displaying the Disc Information

DVD-V DVD-RW

SA-CD VCD CD DATA CD

You can search for a disc by checking the contents of all the discs loaded in the player on your TV screen.

Loading the disc information

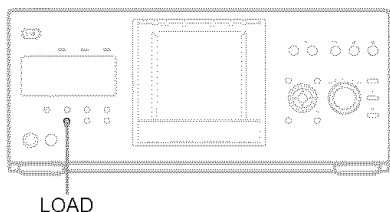

Press **LOAD** when the player is in stop or standby mode.

The player reads the disc information of all the discs and loads it into memory so that the disc type, titles and other text information can be displayed.

To cancel loading

Press **■**.

Hint

The player can load the disc information even when the power is in standby mode. Press **LOAD** before turning on the player.

Viewing information about the loaded discs

You can view the loaded discs using the Disc Explorer.

The player has 7 folders (“ALL,” “DVD,” “CD,” “A” to “D”) and can display the contents of each folder.

All of the discs in the player are filed in the “ALL” folder. At the same time, DVDs are automatically filed in the “DVD” folder, and Super Audio CDs, CDs, VIDEO CDs, DATA

CDs are filed in the “CD” folder. You can file your discs as you like in the “A” to “D” folders (page 52).

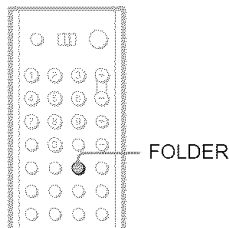

Press **FOLDER**.

The Disc Explorer displays the “ALL” folder.

Disc Explorer display

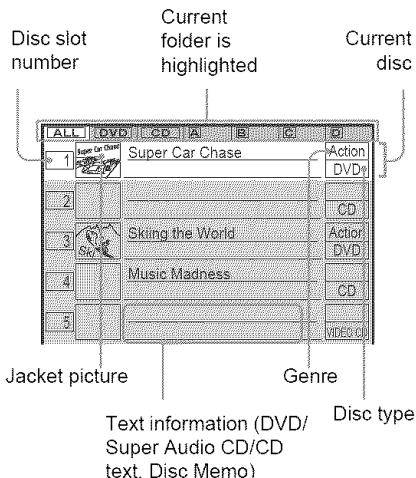

◆ Jacket picture

The jacket picture recorded on the disc appears automatically. If there is no picture, you can capture one from the disc (page 51). If there is no jacket picture and you have not captured one, the genre picture in the player’s memory is displayed if you select a genre.

◆ Text information (DVD/Super Audio CD/CD text or Disc Memo)

The text information (DVD/Super Audio CD/CD text) recorded on the disc appears automatically. If no text information is recorded, you can store the text information (Disc Memo) yourself for DVDs or CDs (page 54).

◆ Genre

You can select the genre of the disc yourself (page 56).

◆ Disc type

The disc type, such as DVD, appears automatically. If the slot does not contain a disc, the disc type row is blank. “?” appears when the player has not loaded the disc information in its memory.

Notes

- Even if you have removed a disc from the player, the disc’s information remains in the Disc Explorer until you load new disc information again by pressing LOAD or place a new disc in the same slot and play it.
- If you press FOLDER during playback of the CD layer of a Super Audio CD, the disc type appears as a CD.

Searching for a disc on the Disc Explorer

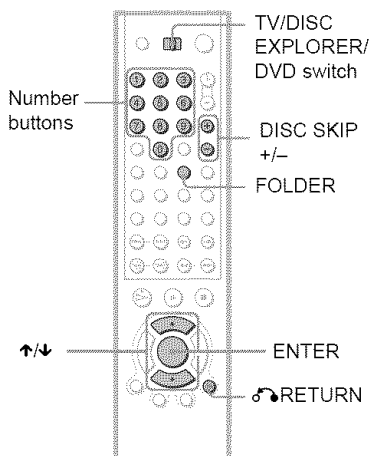
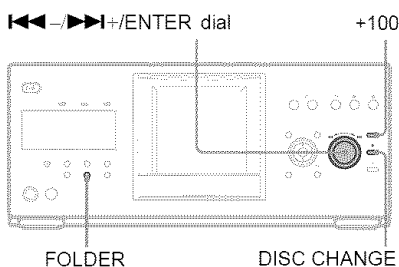

1 Press FOLDER repeatedly to select the folder with the disc you want to play.

With each press, the folder indication in the Disc Explorer display changes as follows:

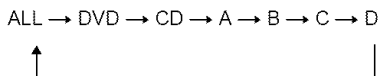

2 Select the disc by one of the following operations.

- press ↑/↓
- after sliding the TV/DISC EXPLORER/DVD switch to DISC EXPLORER or DVD, press the number buttons and ENTER
- after sliding the TV/DISC EXPLORER/DVD switch to DISC EXPLORER or DVD, press DISC SKIP +/- . To skip 100 disc slots ahead, press +100 on the player. Press ENTER to start playback.
- press DISC CHANGE on the player to turn the indicator on, followed by turning the I◀▶+ / ENTER dial on the player and then pressing it.

3 Press ENTER.

The Disc Explorer disappears and playback starts.

To turn off the Disc Explorer

Press RETURN.

Hint

When you select the disc with the number buttons in step 2, you can use the numbers to jump through the Disc Explorer display.

For example, you can press number button 6 and then press ENTER to view the Disc Explorer for disc slot numbers 6 to 10, then press 11 and ENTER to view the Disc Explorer for the next five disc slots (numbers 11 to 15).

Notes

- If you press FOLDER during playback, playback stops and the Disc Explorer appears. In this case, Resume Play is not available.
- If you load or try to play an empty slot, it appears as a blank in the Disc Explorer. You cannot select this slot.
- Even if the disc has a jacket picture recorded on it, the jacket picture may not appear on the Disc Explorer.

Capturing a scene for a jacket picture **DVD-V** **VCD**

You can capture your favorite scene in a disc to create a personal jacket picture. A personalized jacket picture will make spotting the disc in the Disc Explorer easier. This function is available only if the disc does not contain a pre-recorded jacket picture.

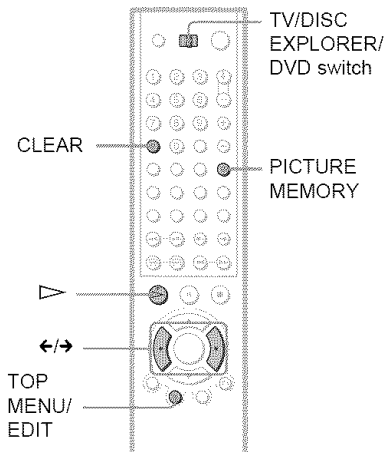

- 1 Select a disc and play it (page 33, 34).
- 2 Slide the TV/DISC EXPLORER/DVD switch to DISC EXPLORER.
- 3 Press PICTURE MEMORY at your favorite scene.

The scene is captured as a still image, and is set as the jacket picture for the Disc Explorer.

To erase a stored jacket picture

- 1 Perform steps 1 and 2 in “Searching for a disc on the Disc Explorer” and select the disc you want to edit (page 50).

- 2 After sliding the TV/DISC EXPLORER/DVD switch to DISC EXPLORER, press TOP MENU/EDIT. **EDIT** appears in the bottom right corner.
- 3 Press ←/→ to highlight the disc number.

Highlight the disc number.

	ALL	DVD	CD	A	B	C	D
1		Super Car Chase	Action	DVD			
2			Classical	CD			
3		Skiing the World	Action	DVD			
4		Music Madness		CD			
5							VIDEO CD

- 4 Press CLEAR. The stored jacket picture is deleted.

To cancel the edit mode

Press ⏪ RETURN until **EDIT** disappears from the Disc Explorer.

If you press ⏩ RETURN again, the Disc Explorer turns off.

Filing Discs in the Folder

(File Mode)

You can file your discs in four individual folders, "A" to "D." Even if you file discs from folders "ALL," "DVD," or "CD" to folders "A" to "D," those discs are not deleted from the "ALL," "DVD," or "CD" folders. You can file up to 400 discs in one folder, and the same disc in different folders. Note that you can set Program Play, Shuffle Play and Repeat Play for discs within a single folder.

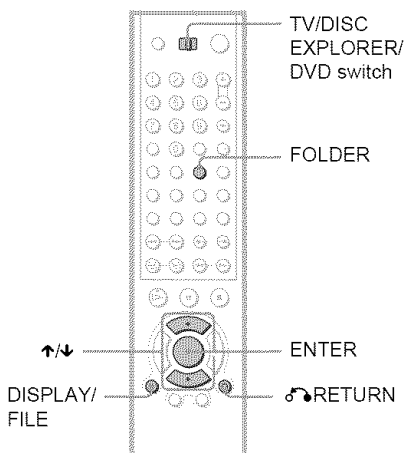

For example, to file DVDs in the no.1 and no.3 slots to the "A" folder:

1 Press FOLDER.

The Disc Explorer appears.

2 Slide the TV/DISC EXPLORER/DVD switch to DISC EXPLORER, then press DISPLAY/FILE.

FILE appears in the bottom right corner.

3 Press \uparrow/\downarrow to select the disc (in this case, the disc in slot no.1).

4 Press ENTER.

The disc to be filed (in this case, the disc in slot no.1) is selected.

To file more than one disc, repeat steps 3 and 4.

Selected disc

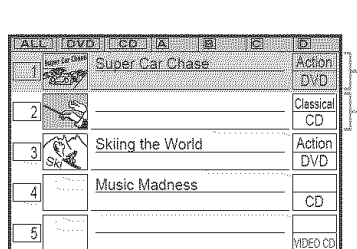

Cursor moves to the next disc.

5 Press FOLDER repeatedly to select the "A" folder.

6 Press DISPLAY/FILE.

FILE disappears from the Disc Explorer. Then the Disc Explorer for the "A" folder containing the selected discs appears.

Filed disc

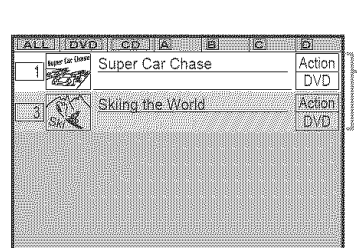

To cancel the file mode

Press \rightarrow RETURN.

To turn off the Disc Explorer, press \rightarrow RETURN again.

Hint

The discs are listed first by slot number in the Disc Explorer. You can then sort the discs by desired genre or text information and then store them (page 57).

Deleting discs from a folder

You can delete unnecessary discs from folders "A" to "D." You cannot delete discs from folders "ALL," "DVD," or "CD" unless you remove the disc from the player.

- 1 Press **FOLDER** repeatedly to select the folder containing the disc you want to delete.

The Disc Explorer for the selected folder appears.

- 2 Slide the **TV/DISC EXPLORER/DVD** switch to **DISC EXPLORER**, then press **DISPLAY/FILE**.

FILE appears in the bottom right corner.

- 3 Press **↑/↓** to select the disc.

- 4 Press **ENTER**.

The disc to be deleted is selected.
To delete other discs, repeat steps 3 and 4.

Selected disc

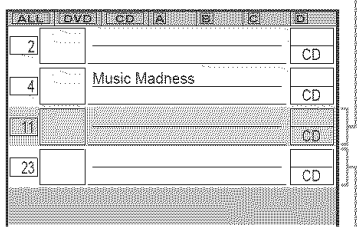

Cursor moves to the next disc.

- 5 Press **CLEAR**.

The disc disappears from the folder and **FILE** disappears from the Disc Explorer.

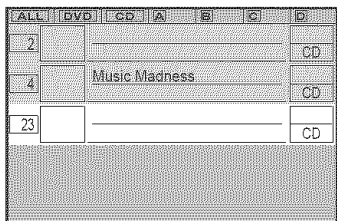

Labeling Discs and Folders (Edit Mode)

You can label the disc with a personal title of 16 characters (Disc Memo) (when DVD/CD text is not recorded on the disc), you can also label the folders "A" to "D" with a title of 3 characters.

The Disc Memo can be anything you like, such as a title, musician's name, category or date of purchase.

You can also assign a genre label to the disc. This will help you keep your discs organized.

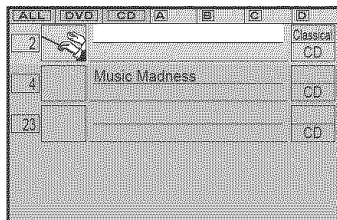
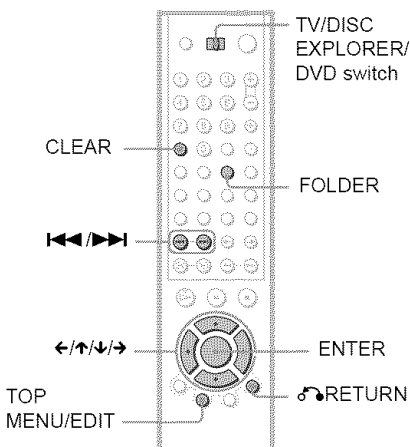

◆ To label a folder

Press FOLDER. After sliding the TV/DISC EXPLORER/DVD switch to DISC EXPLORER, press TOP MENU/EDIT. Then, press \uparrow . Select the folder you want to label by pressing $\leftarrow/\uparrow/\downarrow/\rightarrow$.

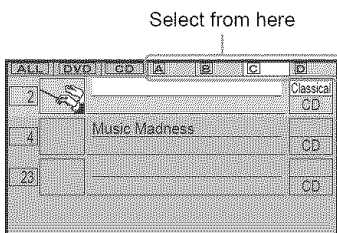

2 Press ENTER.

The "DISC MEMO INPUT" display appears when you have selected a disc. The "FOLDER NAME INPUT" display appears when you have selected a folder.

Labeling a disc or folder

DVD-V VCD CD

1 Select the disc or folder you want to label.

◆ To label a disc

Select the disc on the Disc Explorer (for details, see steps 1 and 2 of "Searching for a disc on the Disc Explorer" on page 50). After sliding the TV/DISC EXPLORER/DVD switch to DISC EXPLORER, press TOP MENU/EDIT. The selected disc's text only is highlighted and **EDIT** appears in the bottom right corner.

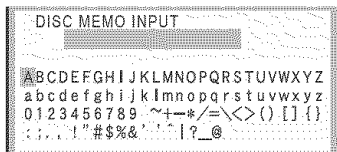

3 Press $\leftarrow/\uparrow/\downarrow/\rightarrow$ to select a character.

The selected character changes color.

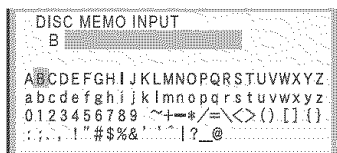

4 Press ENTER.

The selected character is input.

5 Repeat steps 3 and 4 to input other characters.

6 When you have entered all of the characters for the Disc Memo or folder name, press TOP MENU/EDIT.

The “DISC MEMO INPUT” display or the “FOLDER NAME INPUT” display disappears and the Disc Memo or folder name is stored.

The entered Disc Memo



To cancel the edit mode

Press **↵** RETURN until **EDIT** disappears from the Disc Explorer.

If you press **↵** RETURN again, the Disc Explorer turns off.

To erase a character

1 In step 3 of “Labeling a disc or folder” (page 54), press **⏪** or **⏩** to move the cursor to the character you want to erase.

2 Press **CLEAR**.

To insert or overwrite a character

1 In step 3 of “Labeling a disc or folder” (page 54), press **⏪** or **⏩** to move the cursor to the insertion point or the character you want to correct.

2 Press **←/↑/↓/→** to select the correct character.

3 Perform the following.

◆ **To insert the character**

Press **ENTER**.

◆ **To overwrite the character**

Press **⏩** or **⏪** and move the cursor.

💡 Hint

To display disc information on a hybrid Super Audio CD (page 98), play the disc once and press **FOLDER**.

Notes

- You can label up to 400 discs. When you store the 401st disc in memory, the data for the 1st disc is erased.
- You cannot enter Disc Memo on Super Audio CDs (including hybrid discs). However, HD layers on most Super Audio CDs contain text information that you can display using the Disc Explorer. See the hint above.

Labeling a disc or folder using a keyboard

DVD-V **VCD** **CD**

To label the disc or folder, you can use a USA model IBM compatible PC keyboard* (not supplied).

* Power consumption must be 120mA or less.

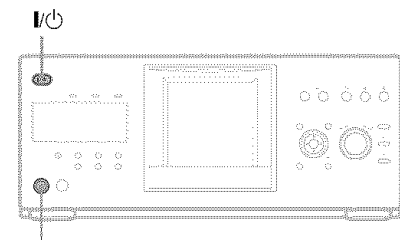

KEYBOARD jack

- 1** Connect a keyboard to the **KEYBOARD** jack on the front panel when the player is in standby mode.
- 2** Press **I/O** to turn on the player.
- 3** Perform steps 1 and 2 of “Labeling a disc or folder” (page 54).
- 4** Input the characters on the keyboard.
- 5** Press **ENTER** on the keyboard to store the Disc Memo or folder name.
The Disc Memo or folder name is stored.

To turn off the Disc Explorer

Press **↵** RETURN.

Notes

- If the cursor keys do not work correctly and you cannot complete the task using the keyboard, disconnect the keyboard. Then, reconnect it to the player and try again.
- If the keyboard is not a USA model, the characters may be input differently from those on the keys. The USA keyboard layout is shown below.



Selecting a genre

DVD-V DVD-RW SA-CD VCD CD DATA CD

You can assign a genre to your disc.

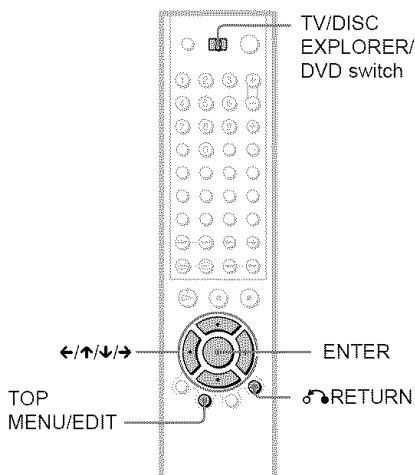

1 Select the disc on the Disc Explorer (steps 1 and 2 of "Searching for a disc on the Disc Explorer" (page 50)).

2 Slide the TV/DISC EXPLORER/DVD switch to DISC EXPLORER, then press TOP MENU/EDIT.

The selected disc's text only is highlighted and **EDIT** appears in the bottom right corner.

3 Press **→** to highlight the genre row, then press **ENTER**.

The "GENRE SELECTION" display appears.

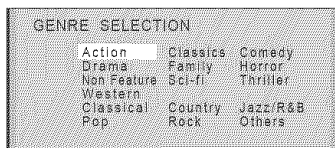

4 Press **←/↑/↓/→** to select the genre, then press **ENTER**.

The genre for the selected disc is stored in memory. If no jacket picture is recorded in the disc, or if you do not have a scene captured from that disc as a jacket picture (page 51), the genre picture in the memory of the player is displayed.

Selected genre

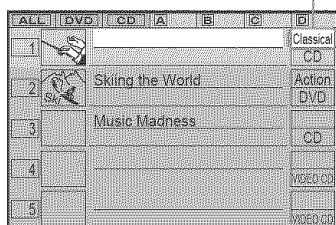

To cancel the edit mode

Press **↵** RETURN until **EDIT** disappears from the Disc Explorer.

If you press **↵** RETURN again, the Disc Explorer turns off.

Notes

- The genre setting remains in the player's memory even after the disc in the slot is changed. To reassign a new genre setting, repeat the steps above.
- The genre setting is cleared when the disc is removed and the slot becomes empty.

Sorting Discs (Sort Mode)

DVD-V DVD-RW SA-CD VCD CD

DATA CD

You can sort the discs in the folder by the disc slot number, text information (DVD/Super Audio CD/CD TEXT or Disc Memo) or genre.

The text information is sorted alphabetically.

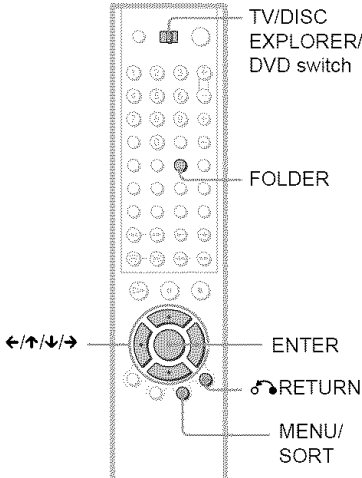

1 Press FOLDER repeatedly to select the folder you want to sort.

The Disc Explorer for the selected folder appears.

2 If you want to sort by text information or genre, select the disc which has the desired text information or genre by pressing \uparrow/\downarrow .

3 Slide the TV/DISC EXPLORER/DVD switch to DISC EXPLORER, then press MENU/SORT.

The selected disc only is highlighted and **SORT** appears in the bottom right corner.

Selected disc

	ALL	DVD	CD	A	B	C	D
1		Super Car Chase MONACO	Action DVD				
2		BRAHMS SYMPHONY4	Classical CD				
3		Skiing the World	Action DVD				
4		Music Madness					CD
5							VIDEO CD

Sorting item indicator (green)

4 Press \leftarrow/\rightarrow to select the item you want to sort.

You can select the disc number, text information or genre. You can also sort the text information by the text in the second line.

Select the sorting item from among here.





	ALL	DVD	CD	A	B	C	D
1		Super Car Chase MONACO	Action DVD				
2		BRAHMS SYMPHONY4	Classical CD				
3		Skiing the World	Action DVD				
4		Music Madness					CD
5							VIDEO CD

Sorting item indicator position when you sort by genre

5 Press ENTER.

SORT disappears from the Disc Explorer.

Then the discs are sorted and re-displayed. The sorted order is saved even if the power of the player is turned off.

ALL	DVD	CD	A	B	C	D
1		Super Car Chase MONACO				Action DVD
3		Skiing the World				Action DVD
188		Highway Touring				Action DVD
2		BRAHMS SYMPHONY4				Classical CD
4		Music Madness				CD

To cancel the sort mode

Press  RETURN. **SORT** disappears from the Disc Explorer.

If you press  RETURN again, the Disc Explorer turns off.

Hint

The discs in the same genre are sorted by numeral order according to the disc slot number.

Searching for a Particular Point on a Disc (Search, Scan, Slow-motion Play, Freeze Frame)

You can quickly locate a particular point on a disc by monitoring the picture or playing back slowly.

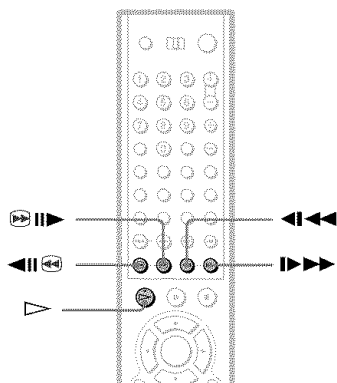

Note

Depending on the DVD/VIDEO CD, you may not be able to do some of the operations described.

Locating a point quickly (Search)

DVD-V DVD-RW SA-CD VCD CD DATA CD

During playback, keep pressing **▶▶▶▶** to locate a point in the playback direction or keep pressing **◀◀◀◀** to locate a point in the opposite direction. When you find the point you want, release the button to return to normal playback speed.

Locating a point quickly by playing a disc in fast forward or fast reverse (Scan)

DVD-V DVD-RW

SA-CD VCD CD DATA CD

Press **◀◀◀◀** or **▶▶▶▶** while playing a disc. When you find the point you want, press **▷** to return to normal speed.

Each time you press **◀◀◀◀** or **▶▶▶▶** during scan, the playback speed changes. With each press the indication changes as shown below. Actual speeds may differ with some discs.

Playback direction

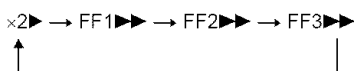

FF3▶▶▶▶▶▶▶▶ (DVD VIDEO/DVD-RW/VIDEO CD only)

×2▶▶ (DVD VIDEO/Super Audio CD/CD only)

Opposite direction

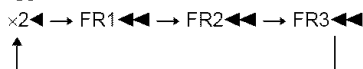

FR3◀◀◀◀◀◀◀◀ (DVD VIDEO/DVD-RW/VIDEO CD only)

×2◀◀ (DVD VIDEO only)

The “**×2▶▶**”/“**×2◀◀**” playback speed is about twice the normal speed. The “**FF3▶▶▶▶▶▶▶▶**”/“**FR3◀◀◀◀◀◀◀◀**” playback speed is faster than “**FF2▶▶▶▶▶▶▶▶**”/“**FR2◀◀◀◀◀◀◀◀**,” and the “**FF2▶▶▶▶▶▶▶▶**”/“**FR2◀◀◀◀◀◀◀◀**” playback speed is faster than “**FF1▶▶▶▶▶▶▶▶**”/“**FR1◀◀◀◀◀◀◀◀**.”

Watching frame by frame (Slow-motion play)

DVD-V DVD-RW VCD

Press **◀◀◀◀** or **▶▶▶▶** when the player is in pause mode. To return to the normal speed, press **▷**.

Each time you press **◀◀◀◀** or **▶▶▶▶** during Slow-motion play, the playback speed changes. Two speeds are available. With each press the indication changes as follows:

Playback direction

SLOW2 ►► ↔ SLOW1 ►►

Opposite direction (DVD only)

SLOW2 ◀◀ ↔ SLOW1 ◀◀

The “SLOW2 ►►”/“SLOW2 ◀◀” playback speed is slower than “SLOW1 ►►”/“SLOW1 ◀◀.”

Playing one frame at a time (Freeze Frame)

DVD-V **DVD-RW** **VCD**

When the player is in the pause mode, press ►►|| to go to the next frame. Press ◀◀||◀◀ to go to the preceding frame (DVD only). If you hold the button down, you can view the frames in succession. To return to normal playback, press ▷.

Searching for a Title/ Chapter/Track/Scene, etc.

DVD-V **DVD-RW** **SA-CD**

VCD **CD** **DATA CD**

You can search a DVD by title or by chapter, and you can search a VIDEO CD/Super Audio CD/CD by track, index, or scene. As titles and tracks are assigned unique numbers on the disc, you can select the desired one by entering its number. Or, you can search for a scene using the time code.

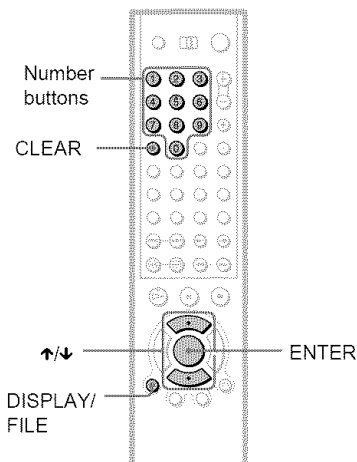

1 Select a disc (page 34).

2 Press DISPLAY/FILE during playback.

The Control Menu appears.

3 Press ↑/↓ to select the search method.

◆ When playing a DVD VIDEO/DVD-RW

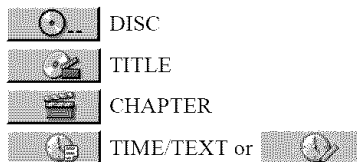

TIME/MEMO

Select "TIME/TEXT" to search for a starting point by inputting the time code.

◆ When playing a VIDEO CD without PBC Playback



◆ When playing a VIDEO CD with PBC Playback

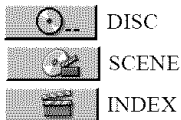

◆ When playing a Super Audio CD/CD

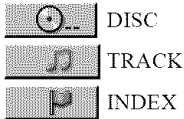

◆ When playing a DATA CD (MP3 audio)

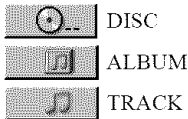

Example: when you select  (CHAPTER)

"** (**)" is selected (** refers to a number).

The number in parentheses indicates the total number of titles, tracks, indexes, scenes, etc. of the disc.

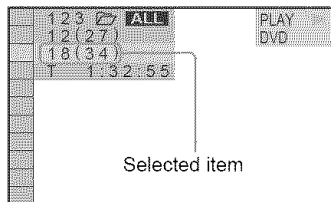

4 Press ENTER.

"** (**)" changes to "-- (**)."

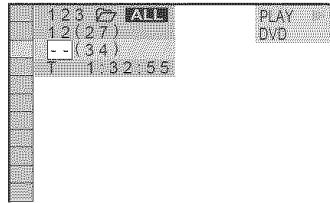

5 Press ↑/↓ or the number buttons to select the title, chapter, track, index, or scene number you want to search.

If you make a mistake

Cancel the number by pressing CLEAR, then select another number.

6 Press ENTER.

The player starts playback from the selected number.

To search for a scene using the time code (DVD VIDEO/DVD-RW only)

- 1 In step 2, select  TIME/TEXT. "T ***:***:" (playing time of the current title) is selected.
- 2 Press ENTER. "T ***:***:" changes to "T --:--:--."
- 3 Input the time code using the number buttons, then press ENTER. For example, to find the scene at 2 hours, 10 minutes, and 20 seconds after the beginning, just enter "2:10:20."

To turn off the display

Press DISPLAY/FILE repeatedly until the display is turned off.

💡 Hints

- You can display the first scene of titles, chapters or tracks recorded on the disc on a screen divided into 9 sections. You can start playback directly by selecting one of the scenes. For details, see "Searching by Scene (PICTURE NAVIGATION)" (page 62).

- You can search for a chapter (DVD VIDEO/DVD-RW only) or track (Super Audio CD/CD/DATA CD only) by pressing the number buttons and ENTER.

Notes

- You cannot search for a still picture on a DVD-RW in VR mode.
- You cannot search for a scene on a DVD+RW using the time code.
- The title, chapter or track number displayed is the same number recorded on the disc.

Searching by Scene

(PICTURE NAVIGATION) DVD-V VCD

You can divide the screen into 9 subscreens and quickly find a desired scene.

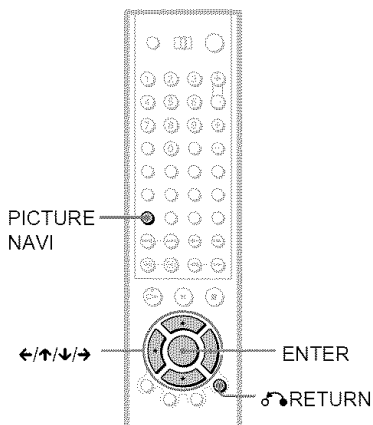

1 Press PICTURE NAVI during playback.

The following display appears.

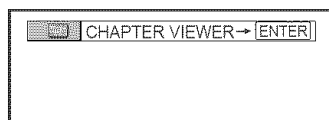

2 Press PICTURE NAVI repeatedly to select an item.

- CHAPTER VIEWER (DVD VIDEO only)
- TITLE VIEWER (DVD VIDEO only)
- TRACK VIEWER (VIDEO CD only)

3 Press ENTER.

The following display appears.

1	2	3	▼
4	5	6	
7	8	9	

4 Press ←/↑/↓/→ to select a title, chapter, or track, and press ENTER.

Playback starts.

To return to normal play

Press ⏪ RETURN.

💡 Hints

- If there are more than 9 titles, chapters, or tracks, ▼ is displayed at the bottom right of the screen. To display the additional titles, chapters, or tracks, select the bottom right scene (located at box 9) and press ↓. To return to the previous scene, select the top left scene (located at box 1) and press ↑.
- You can also select "PICTURE NAVIGATION" from the Control Menu (page 14).

Notes

- Depending on the disc, you may not be able to select some items.
- The sound is muted when using this function.

Checking the Playing Time and Remaining Time

DVD-V DVD-RW SA-CD

VCD CD DATA CD

You can check the playing time and remaining time of the current title, chapter, or track. Also, you can check the DVD/Super Audio CD/CD text or track name (MP3 audio) recorded on the disc.

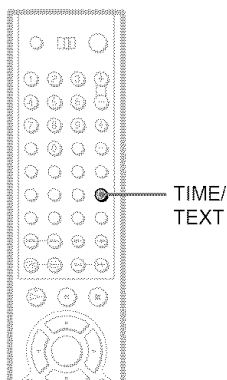

1 Press TIME/TEXT during playback.

The following display appears.

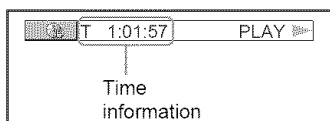

2 Press TIME/TEXT repeatedly to change the time information.

The available time information depends upon the type of disc you are playing.

◆ When playing a DVD VIDEO or DVD-RW

- T *:*: (hours: minutes: seconds)
Playing time of the current title
- T-*:*:
Remaining time of the current title
- C *:*:
Playing time of the current chapter
- C-*:*:
Remaining time of the current chapter

◆ When playing a VIDEO CD (with PBC functions)

- *:* (minutes: seconds)
Playing time of the current scene

◆ When playing a VIDEO CD (without PBC functions), Super Audio CD, or CD

- T *:* (minutes: seconds)
Playing time of the current track
- T-*:*
Remaining time of the current track
- D *:*
Playing time of the current disc
- D-*:*
Remaining time of the current disc

◆ When playing a DATA CD (MP3 audio)

- T *:* (minutes: seconds)
Playing time of the current track

To check the DISC MEMO, DVD/Super Audio CD/CD text, or track/album names (MP3 audio)

Press TIME/TEXT repeatedly in step 2 to display the Disc MEMO or text recorded on the DVD VIDEO/Super Audio CD/CD/ DATA CD.

The DVD/Super Audio CD/CD text appears only when text is recorded in the disc. You cannot change the text. If the disc does not contain text, "NO TEXT" appears. In this case, you can label the disc if it is a DVD or CD (page 54).

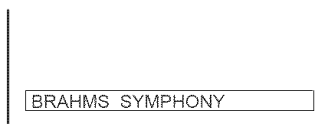

For DATA CDs, the track and album names of the MP3 audio track appears (page 67).

💡 Hint

You can also check the DVD/Super Audio CD/CD text using the Disc Explorer (page 49).

Checking the information on the front panel display

You can view the time information and text on the front panel display as well as on the TV screen. The information on the front panel display changes as follows when you change the time information on your TV screen.

When playing a DVD VIDEO or DVD-RW

Title playing time and current disc, title and chapter number

TITLE		CHAP	HOUR		MIN	SEC	DISC
3	6		0	2	7	5	1
			237				

Remaining time of the current title

TITLE		CHAP	HOUR		MIN	SEC	DISC
3	6		-	1	0	5	2
			237				

Playing time and number of the current chapter

CHAP		HOUR		MIN	SEC	DISC
6		0	0	9	5	1
		237				

Remaining time of the current chapter

CHAP		HOUR		MIN	SEC	DISC
6		-	0	1	6	4
		237				

Text

		HOUR		MIN	SEC	DISC
		2	3	7		
SONY HITS/5						

When playing a VIDEO CD (without PBC functions), Super Audio CD, or CD

Track playing time and current disc, track and index number

TRACK		INDEX	MIN		SEC	DISC
16	13		3	5	8	17
			17			

Remaining time of the current track

TRACK		INDEX	MIN		SEC	DISC
16	13		-	0	2	5
			17			

Playing time of the disc

		HOUR		MIN	SEC	DISC
		7	1	5	2	17
		17				

Remaining time of the disc

		HOUR		MIN	SEC	DISC
		-	0	0	8	17
		17				

Text

		HOUR		MIN	SEC	DISC
		2	3	7		
SONY HITS/5						

When playing a DATA CD (MP3 audio)

Track playing time and current disc, album and track number

		HOUR		MIN	SEC	DISC
		10	2	1	2	2
		276				

Track name

		HOUR		MIN	SEC	DISC
		2	7	6		
SONY HITS/5						

Hints

- When playing VIDEO CDs with PBC functions, the disc number, scene number and the playing time are displayed.
- Long text that does not fit in a single line will scroll across the front panel display.
- You can also check the time information and text by pressing the TIME/TEXT button on the player.
- You can also check the time information and text using the Control Menu (page 15).

Notes



- Depending on the type of disc being played, the DVD/Super Audio CD/CD text or track name may not be displayed.
- The player can only display the first level of the DVD/Super Audio CD/CD text, such as the disc name or title.
- Playing time of MP3 audio tracks may not be displayed correctly.

Checking the Play Information

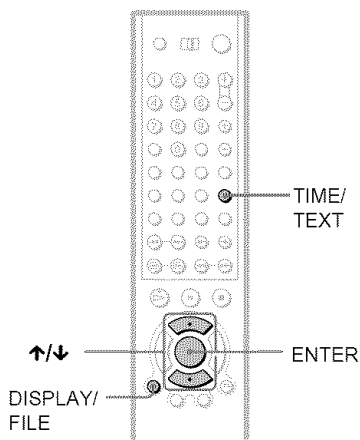
You can check information during playback, such as the current bit rate or the disc layer.



Checking the play information of a DVD (ADVANCED)

- 1** Press DISPLAY/FILE during playback. The Control Menu appears.
- 2** Press  to select  (ADVANCED), then press ENTER. The options for “ADVANCED” appear.

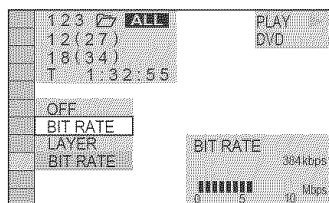

- 3** Press  to select an item. For details on each item, see “Displays of each item” below.
 - BIT RATE: displays the bit rate.
 - LAYER: displays the layer and the pick-up point.
- 4** Press ENTER.

To close the ADVANCED display

Select "OFF" in step 3.

To turn off the Control Menu

Press DISPLAY/FILE repeatedly until the Control Menu is turned off.

Displays of each item

By pressing DISPLAY/FILE repeatedly, you can display either "BIT RATE" or "LAYER," whichever was selected in "ADVANCED."

◆BIT RATE

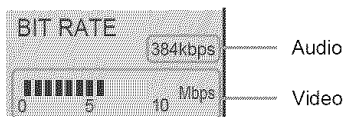

Bit rate refers to the amount of video/audio data per second in a disc. While playing a disc, an approximate bit rate of the playback picture is displayed as Mbps (Mega bit per second) and the audio as kbps (kilo bit per second). The higher the bit rate, the larger the amount of data. However, this does not always mean that you can get higher quality pictures or sounds.

◆LAYER

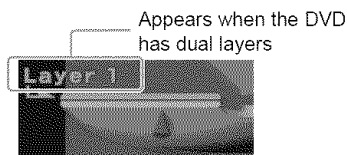

Indicates the approximate point where the disc is playing.

If it is a dual-layer DVD, the player indicates which layer is being read ("Layer 0" or "Layer 1").

For details on the layers, see page 98 (DVD VIDEO).

Checking the play information of a DATA CD DATA CD

By pressing TIME/TEXT while playing an MP3 audio track on a DATA CD, you can display the audio bit rate (the amount of data per second of the current audio) on your TV screen.

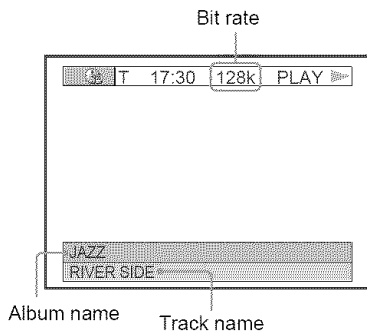

Changing the Sound

DVD-V DVD-RW VCD CD

DATA CD

When playing a DVD recorded in multiple audio formats (PCM, Dolby Digital, or DTS), you can change the audio format. If the DVD is recorded with multilingual tracks, you can also change the language.

With CDs, DATA CDs, or VIDEO CDs, you can select the sound from the right or left channel and listen to the sound of the selected channel through both the right and left speakers. For example, when playing a disc containing a song with the vocals on the right channel and the instruments on the left channel, you can hear the instruments from both speakers by selecting the left channel.

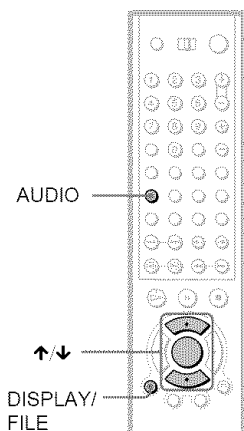

1 Press AUDIO during playback.

The following display appears.

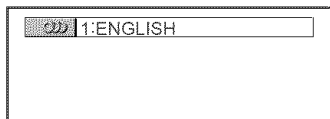

2 Press AUDIO repeatedly to select the desired audio signal.

◆ When playing a DVD VIDEO

Depending on the DVD VIDEO, the choice of language varies.

When 4 digits are displayed, they indicate a language code. See “Language Code List” for the language the code represents (page 102). When the same language is displayed two or more times, the DVD VIDEO is recorded in multiple audio formats.

◆ When playing a DVD-RW

The types of sound tracks recorded on a disc are displayed. The default setting is underlined.

Example:

- 1: MAIN (main sound)
- 1: SUB (sub sound)
- 1: MAIN+SUB (main and sub sound)

◆ When playing a VIDEO CD, CD, or DATA CD (MP3 audio)

The default setting is underlined.

- STEREO: The standard stereo sound
- 1/L: The sound of the left channel (monaural)
- 2/R: The sound of the right channel (monaural)

💡 Hints

You can also select “AUDIO” from the Control Menu (page 15).

Notes

- You cannot change the sound for Super Audio CDs.
- Some DVDs prohibit changing sounds during playback. In this case, change the sounds using the disc’s menu (page 37).

Displaying the disc’s audio information **DVD-V**

Press DISPLAY/FILE during playback to display the Control Menu. Select “AUDIO” using \uparrow/\downarrow . The channels being played are displayed on the screen.

For example, in Dolby Digital format, multiple signals ranging from monaural to 5.1 channel signals can be recorded on a DVD VIDEO. Depending on the DVD VIDEO, the number of the recorded channels may differ.

Current audio format*

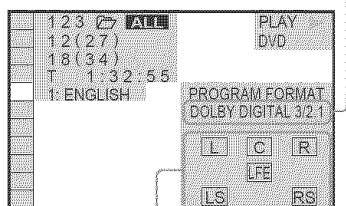

Currently playing program format**

SURROUND Mode

Settings **DVD-V** **DVD-RW** **VCD**

CD **DATA CD**

You can enjoy surround sounds while playing discs, including Dolby Digital and DTS DVDs, even if you have only 2 or 4 speakers. Select the surround mode that best suits your speaker setup.

* "PCM," "DTS," or "DOLBY DIGITAL" is displayed.

The channels in the currently selected track are displayed by numbers as follows:

For Dolby Digital 5.1 ch:

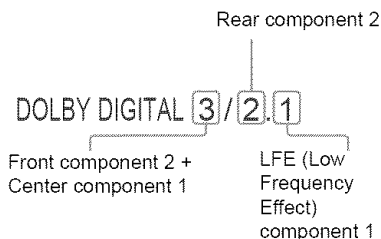

**The letters in the program format display indicate the following sound components:

- L: Front (left)
- R: Front (right)
- C: Center
- LS: Rear (left)
- RS: Rear (right)
- S: Rear (monaural): The rear component of the Dolby Surround processed signal and the Dolby Digital signal
- LFE: Low Frequency Effect signal

Hint

When playing Dolby Digital and DTS sound tracks, "LFE" is enclosed in a dotted line when the LFE signal is not being output.

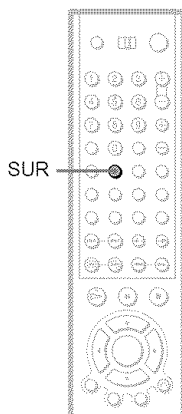

1 Press SUR during playback.

The following display appears.

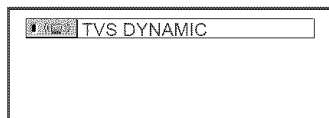

2 Press SUR repeatedly to select one of the surround modes.

See the following explanations given for each item.

◆ For 2 speaker setups

- TVS DYNAMIC
- TVS WIDE
- TVS NIGHT
- TVS STANDARD

◆ For 4 to 6 speaker setups

(If you select “NONE” in the setting of “REAR” in “SPEAKER SETUP” (page 92), you cannot select these modes.)

- NORMAL SURROUND
- ENHANCED SURROUND
- VIRTUAL REAR SHIFT
- VIRTUAL MULTI REAR
- VIRTUAL MULTI DIMENSION

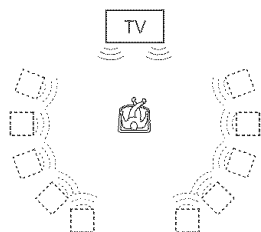

To cancel the setting

Select “OFF” in step 2.

For 2 speaker setups

When you connect a stereo TV or 2 front speakers, TVS (TV Virtual Surround) lets you enjoy surround sound effects by using sound imaging to create virtual rear speakers from the sound of the front speakers (L: left, R: right) without using actual rear speakers. TVS was developed by Sony to produce surround sound for home use using just a stereo TV.

If the player is set up to output the signal from the DIGITAL OUT (OPTICAL or COAXIAL) jack, the surround effect will be heard only when “DOLBY DIGITAL” and “DTS” are set to “D-PCM” in “AUDIO SETUP” (page 91)

◆ TVS DYNAMIC

Creates one set of virtual rear speakers from the sound of the actual front speakers (L, R) as shown below.

This mode is effective when the distance between the front L and R speakers is short, such as with built-in speakers on a stereo TV.

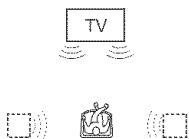

◆ TVS WIDE

Creates five sets of virtual rear speakers from the sound of the actual front speakers (L, R) as shown below.

This mode is effective when the distance between the front L and R speakers is short, such as with built-in speakers on a stereo TV.

◆ TVS NIGHT

Large sounds, such as explosions, are suppressed, but quieter sounds are unaffected. This feature is useful when you want to hear the dialog and enjoy the surround sound effects of “TVS WIDE” at low volume.

◆ TVS STANDARD

Creates three sets of virtual rear speakers from the sound of the actual front speakers (L, R) as shown below. This mode is effective when you use 2 separate front speakers.

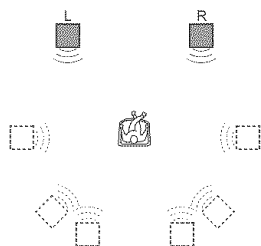

L : Front speaker (left)
R : Front speaker (right)
□ : Virtual speaker

For 4 to 6 speaker setups

You can enjoy the following surround effects by using the 2 front speakers and 2 rear speakers.

Connect the player to the amplifier (receiver) with the **D-1** connection (page 26).

You can experience Dolby Surround (Pro Logic) sounds or Digital Cinema Sound (DCS). DCS uses sound imaging to shift the sound of the rear speakers away from the actual speaker position or create entire sets of virtual rear speakers from one set of actual rear speakers. “VIRTUAL REAR SHIFT,” “VIRTUAL MULTI REAR,” and “VIRTUAL MULTI DIMENSION” make use of this technology.

◆NORMAL SURROUND

Software with 2 channel audio signals is decoded with the Dolby Surround (Pro Logic) decoder to create surround effects. The rear speakers will emit identical monaural sounds. If you are using a center speaker, the appropriate sounds for the center speaker will be delivered.

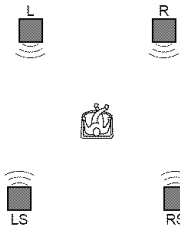

◆ENHANCED SURROUND

Provides a greater sense of presence from a Dolby Surround (Pro Logic) source with a monaural rear channel signal. Produces a stereo like effect in the rear channels.

◆VIRTUAL REAR SHIFT

Shifts the sound of the rear speakers away from the actual speaker position. The shift position differs according to "REAR" or "SIDE" setting of the rear speakers (page 92).

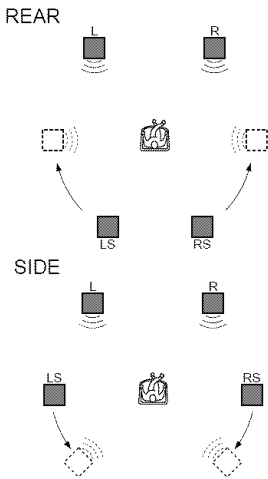

◆VIRTUAL MULTI REAR

Creates an array of virtual rear speakers from a single set of actual rear speakers.

The position of the virtual rear speakers differs according to "REAR" or "SIDE" setting of the rear speakers (page 92).

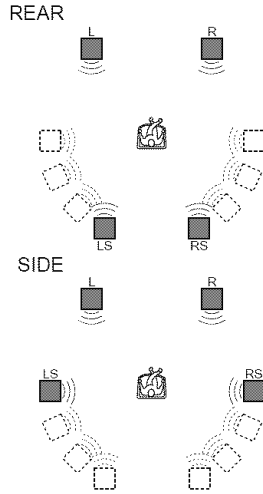

◆VIRTUAL MULTI DIMENSION

Creates an array of virtual rear speaker positions higher than the listener from a single set of actual rear speakers.

This mode creates five sets of virtual speakers surrounding the listener at approximately 30° of elevation. The effect differs according to "REAR" or "SIDE" setting of the rear speakers (page 92).

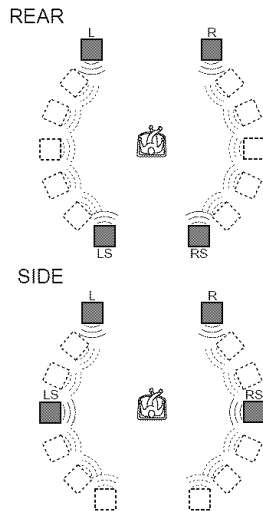

L : Front speaker (left)
R : Front speaker (right)
LS: Rear speaker (left)
RS: Rear speaker (right)
□ : Virtual speaker

Hints

- You can select “SURROUND” by pressing the SURROUND button on the player.
- You can also select “SURROUND” from the Control Menu (page 15).

Notes

- To enjoy the multichannel audio through the 5.1CH OUTPUT jacks, correctly set each speaker position and distance (page 92).
- When the playing signal does not contain a signal for the rear speakers, it may be difficult to hear the surround effect.
- When you select one of the TVS modes, the player does not output the sound of center speaker.
- When you select one of the surround modes, turn off the surround setting of the connected TV or amplifier (receiver)
- Make sure that your listening position is between and at an equal distance from your speakers, and that the speakers are located in similar surroundings.
- Not all discs will respond to the “TVS NIGHT” function in the same way.
- If you use the DIGITAL OUT (OPTICAL or COAXIAL) jack and set “DOLBY DIGITAL” to “DOLBY DIGITAL” and “DTS” to “DTS” in “AUDIO SETUP,” sound will come from your speakers but it will not have the SURROUND effect.
- If the player is set up to output the signal from the DIGITAL OUT (OPTICAL or COAXIAL) jack, the TVS effect will not be heard when you play a CD.
- “TVS NIGHT” can only be used for Dolby digital discs.

Changing the Angles

DVD-V

If various angles (multi-angles) for a scene are recorded on the DVD VIDEO, "ANGLE" appears in the front panel display. This means that you can change the viewing angle.

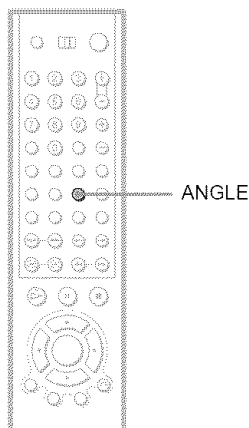

1 Press ANGLE during playback.

The number of the angle appears on the display.

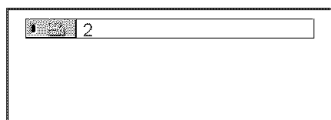

2 Press ANGLE repeatedly to select the angle number.

The scene changes to the selected angle.

Hint

You can also select "ANGLE" from the Control Memm (page 15).

Note

Depending on the DVD VIDEO, you may not be able to change the angles even if multi-angles are recorded on the disc.

Displaying the Subtitles

DVD-V DVD-RW

If subtitles are recorded on the discs, you can change the subtitles or turn them on and off whenever you want while playing a DVD.

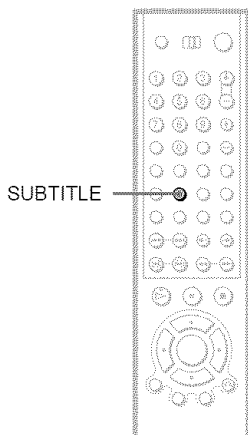

1 Press SUBTITLE during playback.

The following display appears.

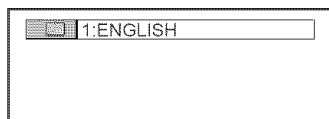

2 Press SUBTITLE repeatedly to select the language.

◆ **When playing a DVD VIDEO**
Select the language.

Depending on the DVD VIDEO, the choice of language varies.

When 4 digits are displayed, they indicate a language code. See "Language Code List" for the language the code represents (page 102).

◆ **When playing a DVD-RW**
Select "ON."

To turn off the subtitles

Select "OFF" in step 2.

Hint

You can also select "SUBTITLE" from the Control Menu (page 15).

Note

Depending on the DVD VIDEO, you may not be able to change the subtitles even if multilingual subtitles are recorded on it. You also may not be able to turn them off.

Adjusting the Picture Quality

(BNR) **DVD-V** **DVD-RW**

VCD

The Block Noise Reduction (BNR) function adjusts the picture quality by reducing the "block noise" or mosaic like patterns that appear on your TV screen.

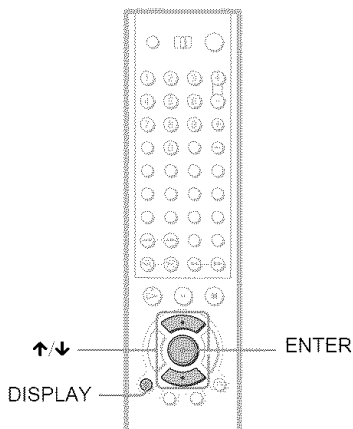

1 Press DISPLAY twice during playback.

The Control Menu appear.

2 Press ↑/↓ to select (BNR), then press ENTER.

The options for "BNR" appears.

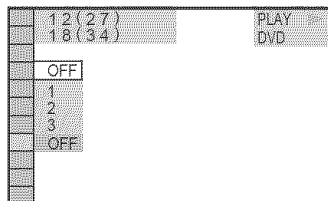

3 Press ↑/↓ to select a level.

- 1: reduces the "block noise."
- 2: reduces the "block noise" more than 1.
- 3: reduces the "block noise" more than 2.

4 Press ENTER.

The disc plays with the setting you selected.

To cancel the "BNR" setting

Select "OFF" in step 3.

To turn off the Control Menu

Press DISPLAY repeatedly until the Control Menu is turned off.

Notes

- If the outlines of the images on your screen become blurred, set "BNR" to "OFF."
- Depending on the disc or the scene being played, the "BNR" effect may be hard to discern.

Adjusting the Playback Picture (CUSTOM PICTURE MODE)

DVD-V DVD-RW VCD

You can adjust the video signal of a DVD or VIDEO CD from the player to obtain the picture quality you want. Choose the setting that best suits the program you are watching. When you select "MEMORY," you can make further adjustments to each element of the picture (color, brightness, etc.).

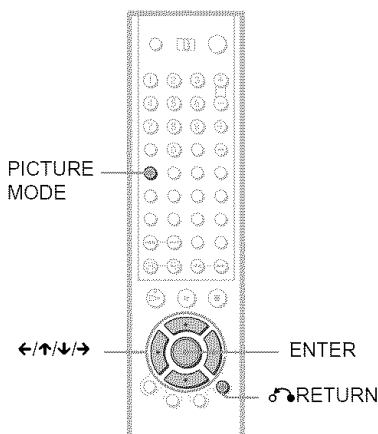

1 Press PICTURE MODE during playback.

The following display appears.

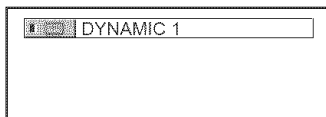

2 Press PICTURE MODE repeatedly to select the setting you want.

The default setting is underlined.

- STANDARD: displays a standard picture.
- DYNAMIC 1: produces a bold dynamic picture by increasing the picture contrast and the color intensity.
- DYNAMIC 2: produces a more dynamic picture than DYNAMIC 1 by further increasing the picture contrast and the color intensity.
- CINEMA 1: enhances details in dark areas by increasing the black level.
- CINEMA 2: white colors become brighter and black colors become richer, and the color contrast is increased.
- MEMORY: adjusts the picture in greater detail.

Hints

- When you watch a movie, "CINEMA 1" or "CINEMA 2" is recommended.
- The picture can be adjusted by pressing the PICTURE MODE button on the player as well.
- You can also select the "CUSTOM PICTURE MODE" from the Control Menu (page 15).

Adjusting the picture items in "MEMORY"

You can adjust each element of the picture individually.

- PICTURE: changes the contrast
- BRIGHTNESS: changes the overall brightness
- COLOR: makes the colors deeper or lighter
- HUE: changes the color balance

1 Press PICTURE MODE repeatedly to select "MEMORY" and press ENTER.

The "PICTURE" adjustment bar appears.

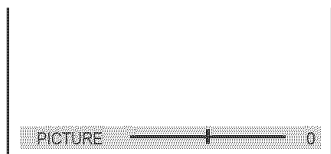

2 Press ←/→ to adjust the picture contrast, then press ENTER.

The adjustment is saved, and "BRIGHTNESS" adjustment bar appears.

3 Repeat step 2 to adjust "BRIGHTNESS," "COLOR," and "HUE."

The Custom Picture Mode display appears. You can check each adjustment.

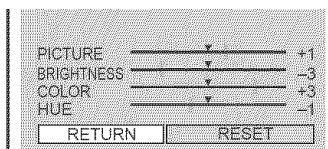

To turn off the display

Press  RETURN, or select "RETURN" in step 3 and press ENTER.

Hints

- To reset the picture items to the default values, press → after step 3 to select "RESET" and press ENTER.
- When "PLAYBACK MEMORY" in "CUSTOM SETUP" is set to "ON," the player will save a single setting for up to 400 individual discs. (This does not apply to DVD-RWs in VR mode.)
- You can skip the adjustment without saving by pressing  in step 2.

Enhancing the Playback Picture (DIGITAL VIDEO ENHANCER)

DVD-V DVD-RW VCD

The Digital Video Enhancer (DVE) function makes the picture appear clear and crisp by enhancing the outlines of images on your TV screen. Also, this function can soften the images on the screen.

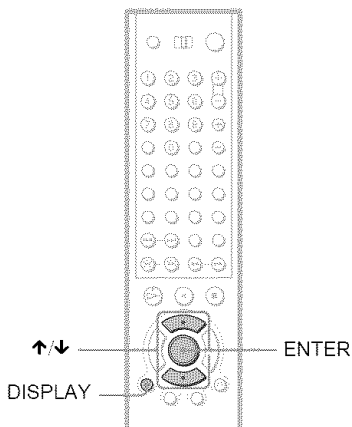

1 Press DISPLAY twice during playback.

The Control Menu appears.

2 Press \uparrow/\downarrow to select **DIGITAL VIDEO ENHANCER**, then press ENTER.

The options for "DIGITAL VIDEO ENHANCER" appear.

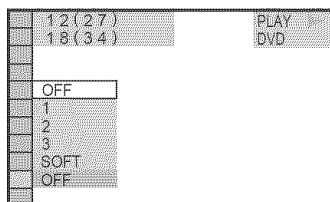

3 Press \uparrow/\downarrow to select a level.

- 1: enhances the outline.
- 2: enhances the outline more than 1.
- 3: enhances the outline more than 2.
- SOFT: softens the image (DVD VIDEO/DVD-RW only)

4 Press ENTER.

The disc plays with the setting you selected.

To cancel the "DIGITAL VIDEO ENHANCER" setting

Select "OFF" in step 3.

To turn off the Control Menu

Press DISPLAY repeatedly until the Control Menu is turned off.

Note

Depending on the disc or the scene being played, noise found in the disc may become more apparent. If this happens, it is recommended that you use the BNR function (page 74) with the DVE function. If the condition still does not improve, reduce the Digital Video Enhancer level, or select "SOFT" (DVD VIDEO/DVD-RW only) in step 3.

Locking Discs (CUSTOM PARENTAL CONTROL, PARENTAL CONTROL)

You can set two kinds of playback restrictions for the desired disc.

- Custom Parental Control

You can set playback restrictions so that the player will not play inappropriate discs.

- Parental Control

Playback of some DVD VIDEOS can be limited according to a predetermined level such as the age of the users. Scenes may be blocked or replaced with different scenes.

The same password is used for both Parental Control and Custom Parental Control.

Custom Parental Control

DVD-V SA-CD VCD CD

You can set the same Custom Parental Control password for up to 400 discs. When you set the 401st disc, the first disc is canceled.

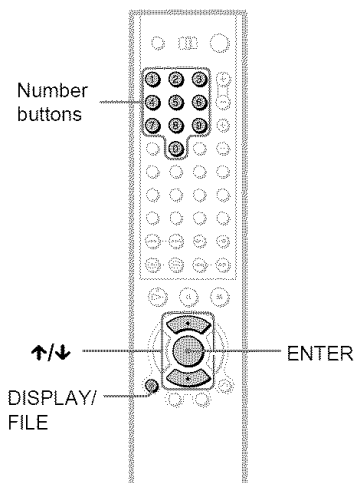

1 Select a disc you want to lock (page 34).

If the disc is playing, press ■ to stop playback.

2 Press DISPLAY/FILE while the player is in stop mode.

The Control Menu appears.

3 Press ↑/↓ to select (PARENTAL CONTROL), then press ENTER.

The options for "PARENTAL CONTROL" appear.

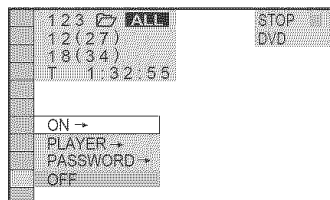

4 Press ↑/↓ to select "ON →," then press ENTER.

◆ If you have not entered a password
The display for registering a new password appears.



Enter a 4-digit password using the number buttons, then press ENTER.
The display for confirming the password appears.

◆ When you have already registered a password

The display for entering the password appears.

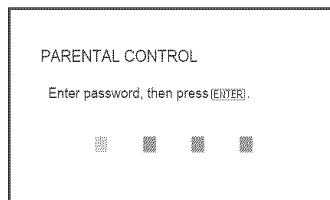

- 5 Enter or re-enter your 4-digit password using the number buttons, then press ENTER.

“Custom parental control is set.” appears and the screen returns to the Control Menu.

To turn off the Custom Parental Control function

- 1 Follow steps 1 to 3 of “Custom Parental Control.”
- 2 Press \uparrow/\downarrow to select “OFF \rightarrow ,” then press ENTER.
- 3 Enter your 4-digit password using the number buttons, then press ENTER.

To play a disc for which Custom Parental Control is set

- 1 Select the disc for which Custom Parental Control is set. The “CUSTOM PARENTAL CONTROL” display appears.

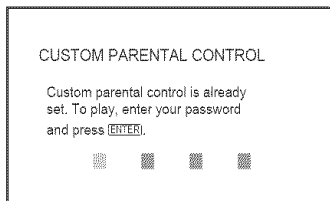

- 2 Enter your 4-digit password using the number buttons, then press ENTER. The player is ready for playback.

Hint

If you forget your password, enter the 6-digit number “199703” using the number buttons when the “CUSTOM PARENTAL CONTROL” display asks you for your password, then press ENTER. The display will ask you to enter a new 4-digit password.

Note

Once you set Custom Parental Control with a recorded disc such as a DVD-RW, the display for entering the password may appear again when you insert a different recorded disc.

Parental Control (limited playback)

Playback of some DVD VIDEOS can be limited according to a predetermined level such as the age of the users. The “PARENTAL CONTROL” function allows you to set a playback limitation level.

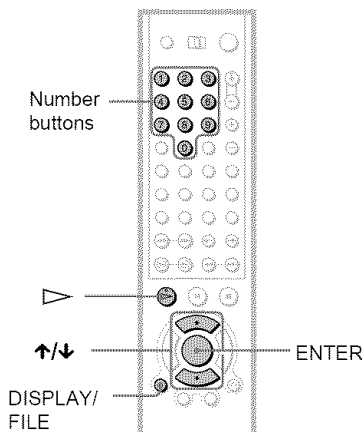

- 1 Press DISPLAY/FILE while the player is in stop mode. The Control Menu appears.
- 2 Press \uparrow/\downarrow to select (PARENTAL CONTROL), then press ENTER. The options for “PARENTAL CONTROL” appear.

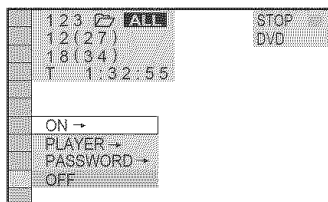

- 3** Press \uparrow/\downarrow to select "PLAYER \rightarrow ," then press ENTER.

◆ **If you have not entered a password**

The display for registering a new password appears.

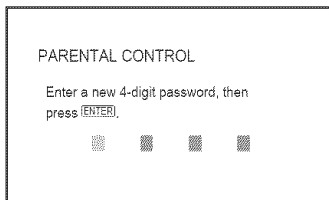

Enter a 4-digit password using the number buttons, then press ENTER.

The display for confirming the password appears.

◆ **When you have already registered a password**

The display for entering the password appears.

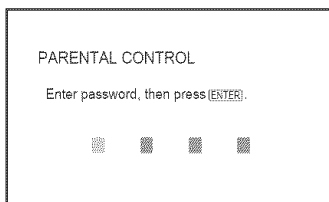

- 4** Enter or re-enter your 4-digit password using the number buttons, then press ENTER.

The display for setting the playback limitation level appears.

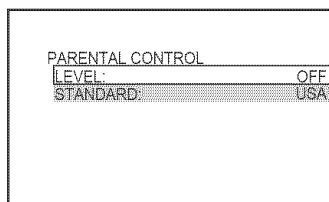

- 5** Press \uparrow/\downarrow to select "STANDARD," then press ENTER.

The selection items for "STANDARD" are displayed.

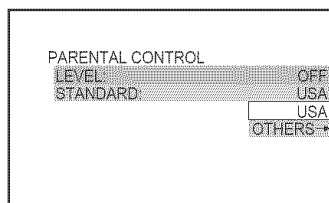

- 6** Press \uparrow/\downarrow to select a geographic area as the playback limitation level, then press ENTER.

The area is selected.

When you select "OTHERS \rightarrow ," select and enter a standard code in the table on page 81.

- 7** Press \uparrow/\downarrow to select "LEVEL," then press ENTER.

The selection items for "LEVEL" are displayed.

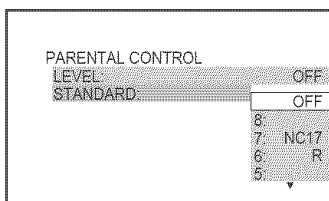

- 8** Select the level you want using \uparrow/\downarrow , then press ENTER.

Parental Control setting is complete.

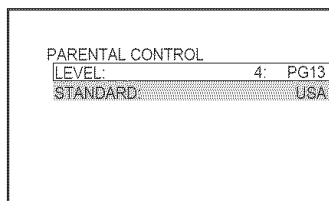

The lower the value, the stricter the limitation.

To turn off the Parental Control function
Set "LEVEL" to "OFF" in step 8.

To play a disc for which Parental Control is set

- 1 Select the disc and press .
The display for entering your password appears.
- 2 Enter your 4-digit password using the number buttons, then press ENTER.
The player starts playback.

Hint

If you forget your password, press OPEN/CLOSE to open the front cover and repeat steps 1 to 3 of “Parental Control (limited playback).” When you are asked to enter your password, enter “199703” using the number buttons, then press ENTER. The display will ask you to enter a new 4-digit password. After you enter a new 4-digit password, press OPEN/CLOSE to close the front cover and press . When the display for entering your password appears, enter your new password.



Notes

- When you play discs which do not have the Parental Control function, playback cannot be limited on this player.
- Depending on the disc, you may be asked to change the parental control level while playing the disc. In this case, enter your password, then change the level. If the Resume Play mode is canceled, the level returns to the previous level.

Area Code

Standard	Code number	Standard	Code number
Argentina	2044	Malaysia	2363
Australia	2047	Mexico	2362
Austria	2046	Netherlands	2376
Belgium	2057	New Zealand	2390
Brazil	2070	Norway	2379
Canada	2079	Pakistan	2427
Chile	2090	Philippines	2424
China	2092	Portugal	2436
Denmark	2115	Russia	2489
Finland	2165	Singapore	2501
France	2174	Spain	2149
Germany	2109	Sweden	2499
India	2248	Switzerland	2086
Indonesia	2238	Thailand	2528
Italy	2254	United Kingdom	2184
Japan	2276		
Korea	2304		

Changing the password

- 1 Press DISPLAY/FILE while the player is in stop mode.
The Control Menu appears.
- 2 Press  to select  (PARENTAL CONTROL), then press ENTER.
The options for “PARENTAL CONTROL” appear.
- 3 Press  to select “PASSWORD →,” then press ENTER.
The display for entering the password appears.
- 4 Enter your 4-digit password using the number buttons, then press ENTER.
- 5 Enter a new 4-digit password using the number buttons, then press ENTER.
- 6 To confirm your password, re-enter it using the number buttons, then press ENTER.

If you make a mistake entering your password

Press **←** before you press ENTER and input the correct number.

If you make a mistake

Press **↶** RETURN.

To turn off the display

Press DISPLAY/FILE repeatedly until the display is turned off.

Controlling Your TV or AV Amplifier (Receiver) With the Supplied Remote

By adjusting the remote signal, you can control your TV with the supplied remote. If you connect the player to an AV amplifier (receiver), you can control the volume with the supplied remote.

Notes

- Depending on the unit being connected, you may not be able to control your TV using some of the buttons below.
- If you enter a new code number, the code number previously entered will be erased.
- When you replace the remote's batteries, the code number you have set may be reset to the default setting. Set the appropriate code number again.

Controlling TVs with the remote

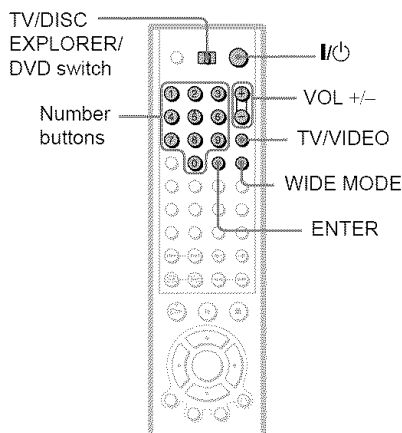

- 1** Slide the TV/DISC EXPLORER/DVD switch to TV.
- 2** Hold down **I/Power**, and enter the manufacturer's code for your TV using the number buttons (see "Code numbers of controllable TVs" below).
- 3** Release **I/Power**.

When the TV/DISC EXPLORER/DVD switch is set to TV, the remote performs the following:

	Turns the TV on or off
VOL +/-	Adjusts the volume of the TV
Number buttons and ENTER	Selects the channel of the TV
WIDE MODE	Switches to or from the wide mode of a Sony wide TV
TV/VIDEO	Switches the TV's input source between the TV and other input sources The button works even if the TV/DISC EXPLORER/DVD switch is set to DVD

Code numbers of controllable TVs

If more than one code number is listed, try entering them one at a time until you find the one that works with your TV.

Manufacturer	Code number
Sony	01 (default)
Akai	04
AOC	04
Centurion	12
Coronado	03
Curtis-Mathes	12
Daytron	12
Emerson	03,04,14
Fisher	11
General Electric	06,10
Gold Star	03,04,17
Hitachi	02,03
J.C.Penney	04,12
JVC	09
KMC	03
Magnavox	03,08,12
Marantz	04,13
MGA/Mitsubishi	04,12,13,17
NEC	04,12
Panasonic	06,19
Phileo	03,04

Manufacturer	Code number
Philips	08,21
Pioneer	16
Portland	03
Proscan	10
Quasar	06,18
Radio Shack	05,14
RCA	04,10
Sampo	12
Samsung	03,12,20
Sanyo	11,14
Scott	12
Sears	07,10,11
Sharp	03,05,18
Sylvania	08,12
Teknika	03,08,14
Toshiba	07
Wards	03,04,12
Yorx	12
Zenith	15

Controlling the volume of your AV amplifier (receiver) with the remote

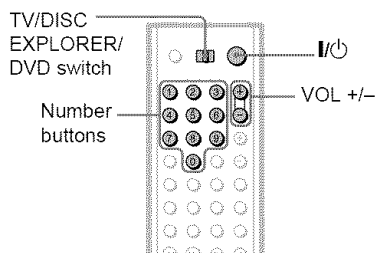

- 1 Slide the TV/DISC EXPLORER/DVD switch to DVD.

2 Hold down **I/⏻**, and enter the manufacturer's code for your AV amplifier (receiver) using the number buttons (see "Code numbers of controllable AV amplifiers (receiver)" below).

3 Release **I/⏻**.

The VOL +/- buttons control the AV amplifier's volume.

◆ **If you want to control the TV volume**

Slide the TV/DISC EXPLORER/DVD switch to TV.

Code numbers of controllable AV amplifiers (receivers)

If more than one code number is listed, try entering them one at a time until you find the one that works with your AV amplifier (receiver).

Manufacturer	Code number
Sony*	80, 88, 89, 91
Denon	84, 85, 86
Kenwood	92, 93
Onkyo	81, 82, 83
Pioneer	99
Sansui	87
Technics	97, 98
Yamaha	94, 95, 96

* If you cannot control the volume of your Sony AV amplifier (receiver) with the remote, try entering the code number 91, and change the command mode of your amplifier (receiver) to "COMMAND MODE [AV1]" (not all amplifiers have this option).

Refer to the instructions supplied with your amplifier (receiver) to change the command mode.

 **Hint**

If you want to control the TV's volume even when the TV/DISC EXPLORER/DVD switch is set to DVD, repeat steps 1 and 2 and enter the code number 90 (default).

Using the Setup Display

By using the Setup Display, you can make various adjustments to items such as picture and sound. You can also set a language for the subtitles and the Setup Display, among other things. For details on each Setup Display item, see pages 86 to 94.

Note

Playback settings stored in the disc take priority over the Setup Display settings and not all of the functions described may work.

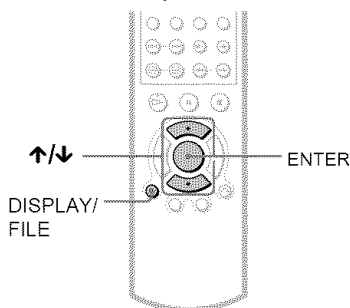

1 Press DISPLAY/FILE when the player is in stop mode.

The Control Menu appears.

2 Press UP/DOWN to select (SETUP), then press ENTER.

The options for "SETUP" appear.

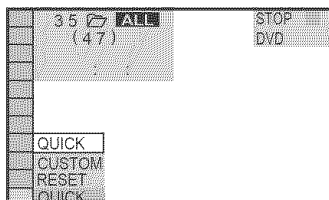

3 Press UP/DOWN to select "CUSTOM," then press ENTER.

The Setup Display appears.

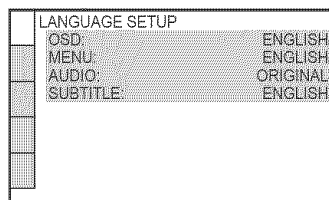

4 Press UP/DOWN to select the setup item from the displayed list:

"LANGUAGE SETUP," "SCREEN SETUP," "CUSTOM SETUP," "AUDIO SETUP" or "SPEAKER SETUP." Then press ENTER.

The Setup item is selected.

Example: "SCREEN SETUP"

Selected item

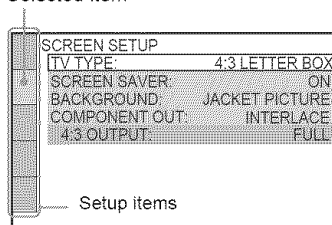

5 Press UP/DOWN to select an item, then press ENTER.

The options for the selected item appear.

Example: "TV TYPE"

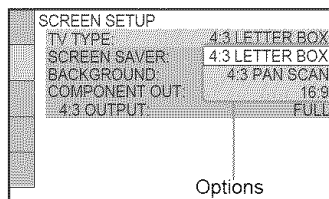

6 Press \uparrow/\downarrow to select a setting, then press ENTER.

The setting is selected and setup is complete.

Example: "16:9"

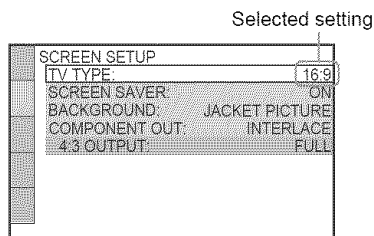

To turn off the display

Press DISPLAY repeatedly until the display is turned off.

To enter the Quick Setup mode

Select "QUICK" in step 3. Follow from step 5 of the Quick Setup explanation to make basic adjustments (page 28).

To reset all of the "SETUP" settings

- 1 Select "RESET" in step 3 and press ENTER
- 2 Select "YES" using \uparrow/\downarrow .
- 3 Press ENTER.

All of the settings explained on pages 86 to 94 return to the default settings. Do not press I/\cup while resetting the player as it takes a few seconds to complete.

Setting the Display or Sound Track Language (LANGUAGE SETUP)

"LANGUAGE SETUP" allows you to set various languages for the on-screen display or sound track.

Select "LANGUAGE SETUP" in the Setup Display. To use the display, see "Using the Setup Display" (page 85).

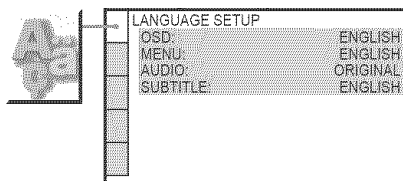

◆ OSD (On-Screen Display)

Switches the display language on the screen.

◆ MENU (DVD VIDEO only)

You can select the desired language for the disc's menu.

◆ AUDIO (DVD VIDEO only)

Switches the language of the sound track. When you select "ORIGINAL," the language given priority in the disc is selected.

◆ SUBTITLE (DVD VIDEO only)

Switches the language of the subtitle recorded on the DVD VIDEO.

When you select "AUDIO FOLLOW," the language for the subtitles changes according to the language you selected for the sound track.

💡 Hint

If you select "OTHERS \rightarrow " in "MENU," "SUBTITLE," and "AUDIO," select and enter a language code from "Language Code List" on page 102 using the number buttons.

Note

When you select a language in "MENU," "SUBTITLE," or "AUDIO" that is not recorded on the DVD VIDEO, one of the recorded languages will be automatically selected.

Settings for the Display

(SCREEN SETUP)

Choose settings according to the TV to be connected.

Select "SCREEN SETUP" in the Setup Display. To use the display, see "Using the Setup Display" on page 85.

The default settings are underlined.

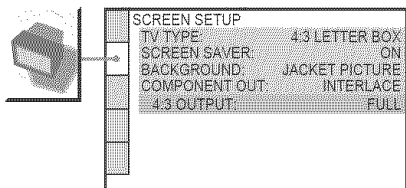

◆ TV TYPE

Selects the aspect ratio of the connected TV (4:3 standard or wide).

<u>4:3 LETTER BOX</u>	Select this when you connect a 4:3 screen TV. Displays a wide picture with bands on the upper and lower portions of the screen.
4:3 PAN SCAN	Select this when you connect a 4:3 screen TV. Automatically displays the wide picture on the entire screen and cuts off the portions that do not fit.
16:9	Select this when you connect a wide-screen TV or a TV with a wide mode function.

4:3 LETTER BOX



4:3 PAN SCAN

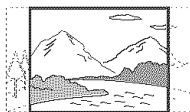

16:9

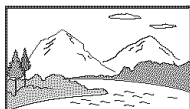

Note

Depending on the DVD, "4:3 LETTER BOX" may be selected automatically instead of "4:3 PAN SCAN" or vice versa.

◆ SCREEN SAVER

The screen saver image appears when you leave the player in pause or stop mode for 15 minutes, or when you play a Super Audio CD, CD, or DATA CD (MP3 audio) for more than 15 minutes. The screen saver will help prevent your display device from becoming damaged (ghosting). Press \blacktriangleright to turn off the screen saver.

<u>ON</u>	Turns on the screen saver.
OFF	Turns off the screen saver.

◆ BACKGROUND

Selects the background color or picture on the TV screen in stop mode or while playing a Super Audio CD, CD, or DATA CD (MP3 audio).

<u>JACKET PICTURE</u>	The jacket picture (still picture) appears, but only when the jacket picture is already recorded on the disc (CD-EXTRA, etc.). If the disc does not contain a jacket picture, the "GRAPHICS" picture appears.
GRAPHICS	A preset picture stored in the player appears.
BLUE	The background color is blue.
BLACK	The background color is black.

◆ COMPONENT OUT

Selects the type of signal output from the COMPONENT VIDEO OUT jacks when the COMPONENT VIDEO OUT/SCAN SELECT switch on the rear panel of the player is set to SELECTABLE. See page 98 for more information about the two different signal types.

<u>INTERLACE</u>	Select this when the player is connected to a standard (interlace format) TV.
PROGRESSIVE	Select this when you have a TV that can accept progressive signals.

About the COMPONENT VIDEO OUT/SCAN SELECT switch

The COMPONENT VIDEO OUT/SCAN SELECT switch on the rear panel of the player selects the signal output from the COMPONENT VIDEO OUT jacks: interlace, progressive, or selectable. The switch takes priority over the setting made in “COMPONENT OUT.”

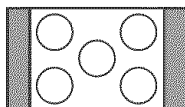

16:9 aspect ratio TV

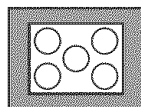

4:3 aspect ratio TV

To switch the video signal format

If you have selected “PROGRESSIVE” for a TV that does not accept signals in progressive format 480p, or if the software’s video signals are not suited for progressive video signal conversion, view the image in Interlace format.

- 1 Set the COMPONENT VIDEO OUT/SCAN SELECT switch on the rear panel of the player to INTERLACE. “COMPONENT OUT” in “SCREEN SET UP” is automatically set to “INTERLACE.”
- 2 Reset the COMPONENT VIDEO OUT/SCAN SELECT switch to SELECTABLE.
Normally leave the switch in this position when using the COMPONENT VIDEO OUT jacks.

When “PROGRESSIVE” is selected in “COMPONENT OUT”

• 4:3 OUTPUT

Adjust this when you watch progressive signals on a standard 4:3 aspect ratio television. If you can change the aspect ratio on your progressive format (480p) compatible TV, change the setting on your TV, not the player.

<u>FULL</u>	Select this when you can change the aspect ratio on your TV.
<u>NORMAL</u>	Select this when you cannot change the aspect ratio on your TV. Shows a 16:9 aspect ratio signal with black bands on left and right sides of the image, and a 4:3 aspect ratio signal with black bands on all sides of the image.

Custom Settings (CUSTOM SETUP)

Use this to make playback related adjustments and other settings.

Select "CUSTOM SETUP" in the Setup Display. To use the display, see "Using the Setup Display" (page 85).

The default settings are underlined.

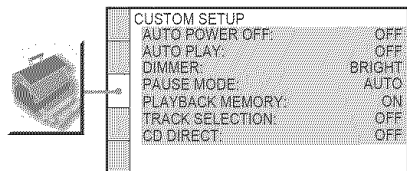

◆ AUTO POWER OFF

Switches the Auto Power Off setting on or off.

<u>OFF</u>	Switches this function off.
ON	The player enters standby mode when left in stop mode for more than 30 minutes.

◆ AUTO PLAY

Switches the Auto Play setting on or off. This function is useful when the player is connected to a timer (not supplied).

<u>OFF</u>	Switches this function off.
ON	Automatically starts playback when the player is turned on.

◆ DIMMER

Adjusts the lighting of the front panel display.

<u>BRIGHT</u>	Makes the lighting bright.
DARK	Makes the lighting dark.
AUTO DARK	Makes the front panel display dark if you do not operate the player or remote for a short while.
AUTO OFF	Turns off the lighting of the front panel display if you do not operate the player or remote for a short while.
OFF	Turns off the lighting.

◆ PAUSE MODE (DVD VIDEO/DVD-RW only)

Selects the picture in pause mode.

<u>AUTO</u>	The picture, including subjects that move dynamically, is output with no jitter. Normally select this position.
FRAME	The picture, including subjects that do not move dynamically, is output in high resolution.

◆ PLAYBACK MEMORY

The player can store "SUBTITLE" and other settings of each disc for up to 400 discs (Playback Memory).

Set this function "ON" or "OFF."

<u>ON</u>	Stores the settings in memory when you eject the disc.
OFF	Does not store the settings in memory.

The following settings are stored in memory.

- ANGLE (page 73)*
- AUDIO (page 68)*
- BNR (page 74)**
- PICTURE MODE (page 75)**
- DIGITAL VIDEO ENHANCER (page 77)**
- SUBTITLE (page 73)*

* DVD VIDEO only

** DVD VIDEO/VIDEO CD only

Notes

- The player can store the settings of up to 400 discs. When you store the setting of disc number 401, the first disc setting is canceled.
- The Playback Memory function cannot be used for DVD-RWs in VR mode.

◆ TRACK SELECTION (DVD VIDEO only)

Gives priority to the sound track which contains the highest number of channels when you play a DVD VIDEO on which multiple audio formats (PCM, DTS, or Dolby Digital format) are recorded.

<u>OFF</u>	No priority given.
AUTO	Priority given.

Notes

- When you set the item to “AUTO,” the language may change. The “TRACK SELECTION” setting has higher priority than the “AUDIO” settings in “LANGUAGE SETUP” (page 86).
- If PCM, DTS, and Dolby Digital sound tracks have the same number of channels, the player selects PCM, DTS, and Dolby Digital sound tracks in this order.

◆ CD DIRECT

Eliminates the use of unnecessary circuits when playing CDs. This setting will be activated when you open or close the front cover.

This function affects the output from the following jacks:

- LINE OUT AUDIO L/R 1/2 jacks
- 5.1CH OUTPUT jacks

<u>OFF</u>	Select this when playing CD discs, including CDs with DTS tracks.
ON	Eliminates the use of unnecessary circuits when playing CDs.

Note

If you select “ON” when playing CDs with DTS tracks, the sound will become noisy.

Settings for the Sound

(AUDIO SETUP)

“AUDIO SETUP” allows you to set the sound according to the playback and connection conditions.

Select “AUDIO SETUP” in the Setup Display. To use the display, see “Using the Setup Display” (page 85).

The default settings are underlined.

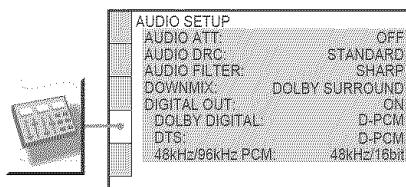

◆ AUDIO ATT (attenuation)

If the playback sound is distorted, set this item to “ON.” The player reduces the audio output level.

This function affects the output of the following jacks:

- LINE OUT AUDIO L/R 1/2 jacks
- 5.1CH OUTPUT jacks

<u>OFF</u>	Normally, select this position.
ON	Select this when the playback sound from the speakers is distorted.

◆ AUDIO DRC (Dynamic Range Control) (DVD VIDEO/DVD-RW only)

Makes the sound clear when the volume is turned down when playing a DVD that conforms to “AUDIO DRC.” This affects the output from the following jacks:

- LINE OUT AUDIO L/R 1/2 jacks
- 5.1CH OUTPUT jacks
- DIGITAL OUT (COAXIAL or OPTICAL) jack only when “DOLBY DIGITAL” is set to “D-PCM” (page 91).

<u>STANDARD</u>	Normally select this position.
TV MODE	Makes low sounds clear even if you turn the volume down.
WIDE RANGE	Gives you the feeling of being at a live performance.

◆ AUDIO FILTER (except Super Audio CD)

Selects a digital filter to reduce noise above 22.05 kHz (Sampling frequency (Fs) of the audio source is 44.1 kHz), 24 kHz (Fs is 48 kHz), or 48 kHz (Fs is above 96 kHz).

SHARP	Provides a wide frequency range and spatial feeling.
SLOW	Provides smooth and warm sound.

Note

There may be little effect by changing the digital filter depending on the disc or playback environment.

◆ DOWNMIX (DVD VIDEO/DVD-RW only)

Switches the method for mixing down to 2 channels when you play a DVD which has rear sound elements (channels) or is recorded in Dolby Digital format. For details on the rear signal components, see "Displaying the disc's audio information" (page 68). This function affects the output of the following jacks:

- LINE OUT AUDIO L/R 1/2 jacks
- DIGITAL OUT (COAXIAL or OPTICAL) jack when "DOLBY DIGITAL" is set to "D-PCM" (page 91).

DOLBY SURROUND	Normally select this position. Multi-channel audio signals are output to two channels for enjoying surround sounds.
NORMAL	Multi-channel audio signals are downmixed to two channels for use with your stereo.

◆ DIGITAL OUT (except Super Audio CD)

Selects if audio signals are output via the DIGITAL OUT (COAXIAL or OPTICAL) jack.

ON	Normally select this position. When you select "ON," see "To set the digital output signal" for further settings.
OFF	The influence of the digital circuit upon the analog circuit is minimal.

Note

Super Audio CD audio signals are not output from the digital jack.

To set the digital output signal

The following switches the method of outputting audio signals when you connect a component such as an amplifier (receiver) or MD deck with a digital input jack.

For connection details, see page 21. Select "DOLBY DIGITAL," "DTS," and "48kHz/96kHz PCM" after setting "DIGITAL OUT" to "ON."

AUDIO SETUP	
AUDIO ATT:	OFF
AUDIO DRC:	STANDARD
AUDIO FILTER:	SHARP
DOWNMIX:	DOLBY SURROUND
DIGITAL OUT:	ON
DOLBY DIGITAL:	D-PCM
DTS:	D-PCM
48kHz/96kHz PCM:	48kHz/16bit

If you connect a component that does not conform to the selected audio signal, a loud noise (or no sound) will come out from the speakers, damaging your ears or speakers.

- DOLBY DIGITAL (DVD VIDEO/DVD-RW only)

Selects the type of Dolby Digital signal.

D-PCM	Select this when the player is connected to an audio component lacking a built-in Dolby Digital decoder. You can select whether the signals conform to Dolby Surround (Pro Logic) or not by making adjustments to the "DOWNMIX" item in "AUDIO SETUP" (page 91).
DOLBY DIGITAL	Select this when the player is connected to an audio component with a built-in Dolby Digital decoder.

- DTS (DVD VIDEO only)

Selects the type of DTS signal.

D-PCM	Select this when the player is connected to an audio component without a built-in DTS decoder.
DTS	Select this when the player is connected to an audio component with a built-in DTS decoder.

- 48kHz/96kHz PCM (DVD VIDEO only)
Selects the sampling frequency of the audio signal.

48kHz/16bit	The audio signals of DVD VIDEOS are always converted to 48kHz/16bit.
96kHz/24bit	All types of signals including 96kHz/24bit are output in their original format. However, if the signal is encrypted for copyright protection purposes, the signal is only output as 48kHz/16bit.

Notes

- Even if you set “48kHz/96kHz PCM” to “96kHz/24bit,” the sampling frequency is converted to 48kHz/16bit when a “SURROUND” mode (page 69) is selected.
- The analog audio signals from the LINE OUT AUDIO L/R jacks and 5.1CH OUTPUT jacks are not affected by this setting and keep their original sampling frequency level.

Settings for the Speakers (SPEAKER SETUP)

To obtain the best possible surround sound, input the size of the speakers you have connected and their distance from your listening position. Then use the test tone to adjust the volume and balance of the speakers to the same level.

This setting is effective when connecting a speaker with 5.1 CH OUTPUT jacks (page 26).

Select “SPEAKER SETUP” in the Setup Display. To use the display, see “Using the Setup Display” (page 85).

The default settings are underlined.

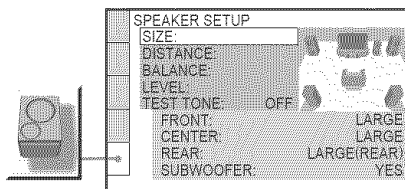

To return to the default setting

Select the item, then press CLEAR. Note that only the “SIZE” setting does not return to the default setting.

◆ SIZE

Selects the size of the speakers.

• FRONT

<u>LARGE</u>	Normally select this position.
SMALL	Select this when the speaker cannot reproduce adequate bass frequencies.

• CENTER

<u>LARGE</u>	Normally select this position.
SMALL	Select this when the speaker cannot reproduce adequate bass frequencies.
NONE	Select this if you do not connect a center speaker.

• REAR

LARGE (REAR/ SIDE)	Normally select this position. Select according to the rear speakers position*.
SMALL (REAR/ SIDE)	Select this when the sound distorts or the surround effects are difficult to hear. Select according to the rear speaker position*.
NONE	Select this if you do not connect rear speakers.

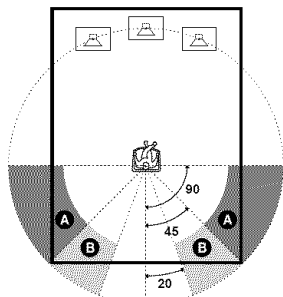

* Rear speaker position

Correctly specify the location of the rear speakers to enjoy the surround effect.

- Set to "SIDE," if the location of the rear speakers corresponds to section **A** below.
- Set to "REAR," if the location of the rear speakers corresponds to section **B** below.

This setting affects only "VIRTUAL REAR SHIFT," "VIRTUAL MULTI REAR," and "VIRTUAL MULTI DIMENSION" mode (page 71).

• SUBWOOFER

YES	Select this if you connect a subwoofer to output the LFE (low frequency effect) signals from the subwoofer.
NONE	Select this if you do not connect a subwoofer.

Notes

- The cut off frequency for the subwoofer is fixed at 120 Hz.
- If your speakers are too small to reproduce low bass frequencies, utilize a subwoofer for low frequency sound. When you set the speaker settings to "SMALL," the bass redirection circuitry will be activated and the bass frequencies for the speakers are output from the subwoofer.

- Even if there are fewer than 6 speakers connected, the player distributes the audio signal components to the front speakers.

◆ **DISTANCE**

Sets the distance from your listening position to the speakers.

Set the distance to your front speakers in "FRONT" first (**A**). Then adjust the values in "CENTER" (center speaker **B**), "REAR" (rear speaker **C**), and "SUBWOOFER" (**D**) to reflect the actual distance to your center speaker, rear speakers, and subwoofer.

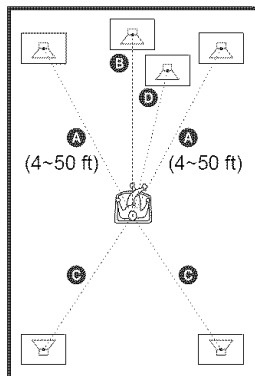

Be sure to change the value in the Setup Display each time you move the speakers. Start from the front speaker. The default adjustments are in parentheses.

FRONT (10 ft)	Set this between 4 and 50 feet in 1 foot increments.
CENTER (10 ft)	Set this within -5 feet and +2 feet of the "FRONT" setting in 1 foot increments. For example, if "FRONT" is set to 5 feet, "CENTER" can be set between 0 and 7 feet.
REAR (10 ft)	Set this within -16 feet of the "FRONT" setting in 1 foot increments. For example, if "FRONT" is set to 16 feet, "REAR" can be set between 0 and 16 feet.

Note

If each of the front or rear speakers are not placed at an equal distance from your listening position, set the distance according to the closest speaker.

◆ BALANCE

Varies the balance of the left and right speakers. Be sure to set "TEST TONE" to "ON" for easy adjustment. The default adjustments are in parentheses.

FRONT (0 dB)	Set this between -6 dB [L] and +6 dB [R] (0.5 dB increments).
REAR (0 dB)	Set this between -6 dB [L] and +6 dB [R] (0.5 dB increments).

◆ LEVEL

Varies the level of each speaker. Be sure to set "TEST TONE" to "ON" for easy adjustment. The default adjustments are in parentheses.

FRONT (0 dB)	Set this between -6 dB and 0 dB (0.5 dB increments).
CENTER (0 dB)	Set this between -12 dB and 0 dB (0.5 dB increments).
REAR (0 dB)	Set this between -12 dB and 0 dB (0.5 dB increments).
SUBWOOFER (0 dB)	Set this between -10 dB and +10 dB (0.5 dB increments).

To adjust the volume of all the speakers at one time

Use the amplifier's (receiver's) volume control.

◆ TEST TONE

The speakers will emit a test tone. Use this when you use the 5.1CH OUTPUT jacks and adjust "BALANCE" and "LEVEL."

OFF	The test tone is not emitted from the speakers.
ON	The test tone is emitted from each speaker in sequence.

Adjusting the speaker volume and level

- 1 Select "SPEAKER SETUP" in the Setup Display.
- 2 Select "TEST TONE" and set to "ON." You will hear the test tone from each speaker in sequence.
- 3 From your listening position, select "BALANCE" or "LEVEL" and adjust the value of "BALANCE" using \leftarrow/\rightarrow and "LEVEL" using \uparrow/\downarrow . The test tone is emitted from both left and right speakers simultaneously.
- 4 Select "TEST TONE" and set to "OFF" to turn off the test tone.

Note

The test tone signals are not output from the digital jack.

Troubleshooting

If you experience any of the following difficulties while using the player, use this troubleshooting guide to help remedy the problem before requesting repairs. Should any problem persist, consult your nearest Sony dealer.

Power

The power is not turned on.

- ➔ Check that the AC power cord is connected securely.

Picture

There is no picture/picture noise appears.

- ➔ Re-connect the connecting cord securely.
- ➔ The connecting cord is damaged.
- ➔ Check the connection to your TV (page 19) and switch the input selector on your TV so that the signal from the player appears on the TV screen.
- ➔ The disc is dirty or flawed.
- ➔ If the picture output from your player goes through your VCR to get to your TV or if you are connected to a combination TV/VIDEO player, the copy-protection signal applied to some DVD programs could affect picture quality. If you still experience problems even when you connect your player directly to your TV, try connecting your player to your TV's S VIDEO input (page 19).
- ➔ You have set "COMPONENT OUT" in "SCREEN SETUP" to "PROGRESSIVE" even though your TV cannot accept the signal in progressive format. In this case, set the COMPONENT VIDEO OUT/SCAN SELECT switch on the rear panel of the player to INTERLACE. "COMPONENT OUT" in "SCREEN SETUP" is automatically set to "INTERLACE," and reset the COMPONENT VIDEO OUT/SCAN SELECT switch to SELECTABLE. Normally leave the switch in this position when using the COMPONENT VIDEO OUT jacks.

- ➔ Even if your TV is compatible with progressive format 480p signals, the image may be affected when you set "COMPONENT OUT" to "PROGRESSIVE." In this case, set "COMPONENT OUT" to "INTERLACE."

The picture does not fill the screen, even though the aspect ratio is set in "TV TYPE" under "SCREEN SET UP."

- ➔ The aspect ratio of the disc is fixed on your DVD.

Sound

There is no sound.

- ➔ Re-connect the connecting cord securely.
- ➔ The connecting cord is damaged.
- ➔ The player is connected to the wrong input jack on the amplifier (receiver) (page 24, 25, 26).
- ➔ The amplifier (receiver) input is not correctly set.
- ➔ The player is in pause mode or in Slow-motion Play mode.
- ➔ The player is in fast forward or fast reverse mode.
- ➔ If the audio signal does not come through the DIGITAL OUT (COAXIAL or OPTICAL) jack, check the audio settings (page 91).
- ➔ Super Audio CD audio signals are not output from the digital jack.

Sound distortion occurs.

- ➔ Set "AUDIO ATT" in "AUDIO SETUP" to "ON" (page 90).

The volume is low.

- ➔ The volume is low on some DVDs. The volume may improve if you set "AUDIO DRC" to "TV MODE" (page 90).
- ➔ Set "AUDIO ATT" in "AUDIO SETUP" to "OFF" (page 90).

The surround effect is difficult to hear when playing a Dolby Digital, or DTS sound track.

- ➔ Check the speaker connections and settings (page 26, 28, 91).
- ➔ 5.1 channel sound is not recorded on the disc being played.

The sound only comes from the center speaker.

- ➔ Depending on the disc, the sound may come from the center speaker only.

Operation**The remote does not function.**

- ➔ The batteries in the remote are weak.
- ➔ There are obstacles between the remote and the player.
- ➔ The distance between the remote and the player is too far.
- ➔ The remote is not pointed at the remote sensor on the player.
- ➔ The COMMAND MODE switch setting on the remote does not match the setting on the player (page 18).

The disc does not play.

- ➔ The disc is skewed.
- ➔ The player cannot play certain discs (page 6).
- ➔ The region code on the DVD does not match the player.
- ➔ Moisture has condensed inside the player (page 3).
- ➔ The player cannot play a recorded disc that is not correctly finalized (page 7).

The MP3 audio track cannot be played (page 41).

- ➔ The DATA CD is not recorded in an MP3 format that conforms to ISO9660 Level 1/ Level 2 or Joliet.
- ➔ The MP3 audio track does not have the extension “.MP3.”
- ➔ The data is not formatted in MP3 even though it has the extension “.MP3.”
- ➔ The data is not MPEG1 Audio Layer 3 data.
- ➔ The player cannot play audio tracks in MP3PRO format.

“Copyright lock” appears and the screen turns blue when playing a DVD-RW.

- ➔ Images taken from digital broadcasts, etc., may contain copy protection signals, such as complete copy protection signals, single copy signals, and restriction-free signals. When images that contain copy protection signals are played, a blue screen may appear instead of the images. It may take awhile for the player to look for playable images.

The title of the MP3 audio album or track is not correctly displayed.

- ➔ The player can only display numbers and alphabet. Other characters are displayed as “?”

The disc does not start playing from the beginning.

- ➔ Program Play, Shuffle Play, Repeat Play, or A-B Repeat Play has been selected (page 43).
- ➔ Resume play has taken effect (page 36).

The player starts playing the disc automatically.

- ➔ The disc features an auto playback function.
- ➔ “AUTO PLAY” in “CUSTOM SETUP” is set to “ON” (page 89).

Playback stops automatically.

- ➔ While playing discs with an auto pause signal, the player stops playback at the auto pause signal.

Some functions such as Stop, Search, Slow-motion Play, Repeat Play, Shuffle Play, or Program Play cannot be performed.

- ➔ Depending on the disc, you may not be able to do some of the operations above. Refer to the operating manual that comes with the disc.

The language for the sound track cannot be changed.

- ➔ Try using the DVD’s menu instead of the direct selection button on the remote (page 37).
- ➔ Multilingual tracks are not recorded on the DVD being played.
- ➔ The DVD prohibits the changing of the language for the sound track.

The subtitle language cannot be changed or turned off.

- ➔ Try using the DVD’s menu instead of the direct selection button on the remote (page 37).
- ➔ Multilingual subtitles are not recorded on the DVD being played.
- ➔ The DVD prohibits the changing of subtitles.

The angles cannot be changed.

- ➔ Try using the DVD's menu instead of the direct selection button on the remote (page 37).
- ➔ Multi-angles are not recorded on the DVD being played.
- ➔ The angle can only be changed when the "ANGLE" indicator lights up on the front panel display (page 10).
- ➔ The DVD prohibits changing of the angles.

The player does not operate properly.

- ➔ When static electricity, etc., causes the player to operate abnormally, unplug the player.

5 numbers or letters are displayed on the screen and on the front panel display.

- ➔ The self-diagnosis function was activated. (See the table on page 97.)

The front cover does not open and "LOCKED" appears on the front panel display.

- ➔ Child Lock is set (page 35).

The front cover does not open and "TRAY LOCKED" appears on the front panel display.

- ➔ Contact your Sony dealer or local authorized Sony service facility.

"Data error" appears on the TV screen when playing a DATA CD.

- ➔ The MP3 audio track you want to play is broken.
- ➔ The data is not MPEG1 Audio Layer 3 data.

Self-diagnosis Function

(When letters/numbers appear in the display)

When the self-diagnosis function is activated to prevent the player from malfunctioning, a five-character service number (e.g., C 13 50) with a combination of a letter and four digits appears on the screen and the front panel display. In this case, check the following table.

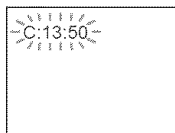

First three characters of the service number	Cause and/or corrective action
C 13	The disc is dirty. ➔ Clean the disc with a soft cloth (page 8).
C 31	The disc is not inserted correctly. ➔ Re-insert the disc correctly.
C 32	The front cover automatically opens and the player enters standby mode. ➔ Check that there is nothing wrong inside the rotary table, such as a fallen disc. After you have checked the inside of the rotary table and resolved any possible problems, press \triangleright .
E XX (xx is a number)	To prevent a malfunction, the player has performed the self-diagnosis function. ➔ Contact your nearest Sony dealer or local authorized Sony service facility and give the 5-character service number. Example: E 61 10

Glossary

Chapter (page 10, 15, 60)

Sections of a picture or a music feature that are smaller than titles. A title is composed of several chapters. Depending on the disc, no chapters may be recorded.

Dolby Digital (page 26, 91)

Digital audio compression technology developed by Dolby Laboratories. This technology conforms to multi-channel surround sound. The rear channel is stereo and there is a discrete subwoofer channel in this format. Dolby Digital provides the same discrete channels of high quality digital audio found in "Dolby Digital" theater surround sound systems. Good channel separation is realized because all of the channel data are recorded discretely and little deterioration is realized because all channel data processing is digital.

Dolby Surround (Pro Logic) (page 25, 91)

Audio signal processing technology that Dolby Laboratories developed for surround sound. When the input signal contains a surround component, the Pro Logic process outputs the front, center and rear signals. The rear channel is monaural.

DTS (page 26, 68, 91)

Digital audio compression technology that Digital Theater Systems, Inc. developed. This technology conforms to multi-channel surround sound. The rear channel is stereo and there is a discrete subwoofer channel in this format. DTS provides discrete channels of high quality digital audio. Good channel separation is realized because all of the channel data is recorded discretely and little deterioration is realized because all channel data processing is digital.

DVD VIDEO (page 6)

A disc that contains up to 8 hours of moving pictures even though its diameter is the same as a CD.

The data capacity of a single-layer and single-sided DVD is 4.7 GB (Giga Byte), which is 7 times that of a CD. The data capacity of a

double-layer and single-sided DVD is 8.5 GB, a single-layer and double-sided DVD is 9.4 GB, and double-layer and double-sided DVD is 17 GB.

The picture data uses the MPEG 2 format, one of the worldwide standards of digital compression technology. The picture data is compressed to about 1/40 (average) of its original size. The DVD also uses a variable rate coding technology that changes the data to be allocated according to the status of the picture. Audio information is recorded in a multi-channel format, such as Dolby Digital, allowing you to enjoy a more real audio presence.

Furthermore, various advanced functions such as the multi-angle, multilingual, and Parental Control functions are provided with the DVD.

DVD-RW (page 6, 38)

A DVD-RW is a recordable and rewritable disc that is the same size as the DVD VIDEO. The DVD-RW has two different modes: VR mode and Video mode.

DVD-RWs created in Video mode have the same format as a DVD VIDEO, while discs created in VR (Video Recording) mode allow the contents to be programmed or edited.

DVD+RW (page 6)

A DVD+RW (plus RW) is a recordable and rewritable disc. DVD+RWs use a recording format that is comparable to the DVD VIDEO format.

Film based software, Video based software (page 74)

DVDs can be classified as Film based or Video based software. Film based DVDs contain the same images (24 frames per second) that are shown at movie theaters. Video based DVDs, such as television dramas or sit-coms, displays images at 30 frames (or 60 fields) per second.

Index (CD)/Video Index (VIDEO CD) (page 10, 15, 60)

A number that divides a track into sections to easily locate the point you want on a CD or VIDEO CD. Depending on the disc, no index may be recorded.

Interlace format (page 87)

Interlace format shows every other line of an image as a single “field” and is the standard method for displaying images on television. The even number field shows the even numbered lines of an image, and the odd numbered field shows the odd numbered lines of an image.

Progressive conversion method (page 74)

• Video based software conversion
Video shows an image by alternately displaying every other line of an image (field) at 30 frames (60 fields) per second (Interlace format).

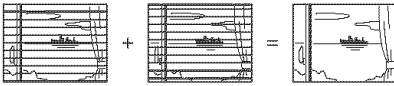

The Interlace format displays 30 frames (60 fields) per second by displaying every other line of the image, causing scanning lines to appear across the image. Since only half of the image is shown at once, the amount of information contained in an image is limited.

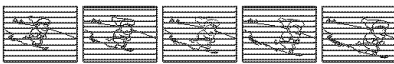

The Progressive format displays 60 entire frames per seconds. The player accomplishes this by converting each field into a frame by using either a field-based conversion method or a frame-based conversion method. The appropriate method is automatically selected by the player according to the movement of the images on the screen. If the movement on the screen is slow, the frame-based conversion method borrows adjacent frame information to fill in the missing information. If the movement on the screen is rapid, the field-based conversion method creates the missing information by predicting the movement of the images on the screen from field to field. The end result is an image that is higher in quality when compared to the Interlace format.

Interlace pictures

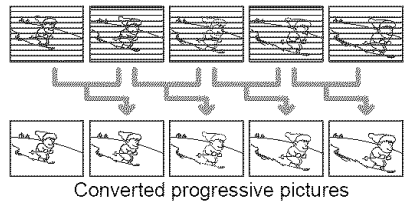

- Film based software conversion
Film shows an image by displaying an entire image at 24 frames per second. When you watch a film on television, the television displays every other line of the frame as a field, thus reducing information level and the clarity of the film image.

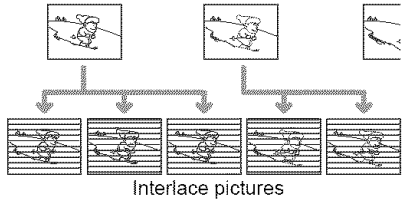

This player solves this problem by increasing the speed at which the frames are displayed, consecutively showing 3 identical frames followed by 2 identical frames in the time that it normally takes to show 2 consecutive frames. The end result is that the 24 frames per second are increased to 60 frames per second, which is the speed at which Progressive video signals are shown.

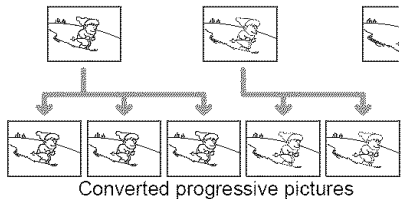

This not only allows film to be shown in a frame based format, it also increases the clarity and sharpness which is unique to Progressive format images.

Progressive format (page 87)

Compared to the Interlace format that alternately shows every other line of an image (field) to create one frame, the Progressive format shows the entire image at once as a single frame. This means that while the Interlace format can show 30 frames (60 fields) in one second, the Progressive format can show 60 frames in one second. The overall picture quality increases and still images, text, and horizontal lines appear sharper.

Scene (page 10)

On a VIDEO CD with PBC (playback control) functions, the menu screens, moving pictures and still pictures are divided into sections called "scenes."

Super Audio CD (page 6)

A Super Audio CD disc can reproduce sounds that are extremely faithful to the original sound by use of DSD (Direct Stream Digital) technology. This technology utilizes a sampling frequency of 2.8224 MHz, which is 64 times that of a conventional CD, and 1-bit quantization that enables the disc to hold 4 times the amount of information that a standard PCM format CD can hold. Super Audio CDs are divided into the following types.

- Super Audio CD (single layer disc)

This disc consists of a single HD layer*.

*High density signal layer for the Super Audio CD

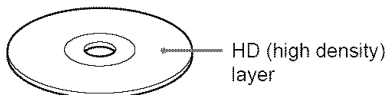

- Super Audio CD (dual layer disc)

This disc consists of dual HD layers and is capable of extended play over long periods. Also, as the dual layer disc consists of dual HD layers on one side only, you do not have to turn the disc over during playback.

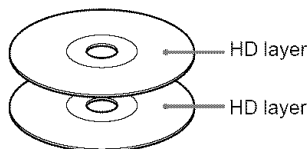

- Super Audio CD + CD (Hybrid disc)

This disc consists of an HD layer and a CD layer. Also, as the dual layers are on one side only, you do not have to turn the disc over during playback. You can play the CD layer using a conventional CD player.

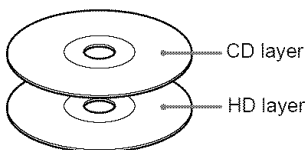

- 2 channel + Multi-channel Super Audio CD

This disc consists of the 2 channel playback area and the multi-channel playback area.

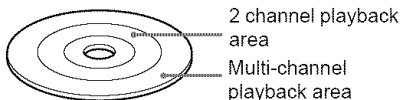

Title (page 10, 15, 60)

The longest section of a picture or music feature on a DVD, movie, etc., in video software, or the entire album in audio software.

Track (page 10, 15, 60)

Sections of a picture or a music feature on a CD or VIDEO CD (the length of a song).

Specifications

System

Laser: Semiconductor laser

$\lambda = 780$ nm for CD

$\lambda = 650$ nm for SA-CD and DVD

Emission duration: continuous

Signal format system: NTSC

Audio characteristics

Frequency response: DVD VIDEO (PCM

96 kHz): 2 Hz to 44 kHz (44 kHz: -2 dB

± 1 dB), Super Audio CD: 2 Hz to

100 kHz (50 kHz: -3 dB ± 1 dB), CD:

2 Hz to 20 kHz (± 0.5 dB)

Signal-to-noise ratio (S/N ratio): 115 dB
(LINE OUT AUDIO L/R 1/2 jacks only)

Harmonic distortion: 0.003 %

Dynamic range: DVD VIDEO/Super Audio
CD: 103 dB, CD: 99 dB

Wow and flutter: Less than detected value
($\pm 0.001\%$ W PEAK)

Outputs

(**Jack name:** Jack type/Output level/Load
impedance)

LINE OUT AUDIO L/R 1/2: Phono jack/
2 V_{rms}/10 kilohms

DIGITAL OUT (OPTICAL): Optical
output jack/ -18 dBm (wave length:
660 nm)

DIGITAL OUT (COAXIAL): Phono jack/
0.5 V_{p-p}/75 ohms

5.1CH OUTPUT: Phono jack/2 V_{rms}/
10 kilohms

**COMPONENT VIDEO OUT (Y, P_B/C_B,
P_R/C_R):** Phono jack/Y: 1.0 V_{p-p}/P_B/C_B,
P_R/C_R: 0.648 V_{p-p}/75 ohms

LINE OUT VIDEO 1/2: Phono jack/
1.0 V_{p-p}/75 ohms

S VIDEO OUTPUT 1/2: 4-pin mini DIN/
Y: 1.0 V_{p-p}/C: 0.286 V_{p-p} /75 ohms

General

Power requirements:

120 V AC, 60 Hz

Power consumption: 20 W

Dimensions (approx.): 430 × 189 × 545 mm
(17 × 7 1/2 × 21 1/2 in.) (width/height/depth)
incl. projecting parts

Mass (approx.): 8.6 kg (18 lb 15 oz)

Operating temperature: 5 °C to 35 °C
(41 °F to 95 °F)

Operating humidity: 25 % to 80 %

Supplied accessories

See page 17.

Specifications and design are subject to
change without notice.

ENERGY STAR® is a U.S. registered mark.
As an ENERGY STAR® Partner, Sony
Corporation has determined that this product
meets the ENERGY STAR® guidelines for
energy efficiency.

Language Code List

For details, see pages 68, 73, 86.

The language spellings conform to the ISO 639: 1988 (E/F) standard.

Code Language	Code Language	Code Language	Code Language
1027 Afar	1183 Irish	1347 Maori	1507 Samoan
1028 Abkhazian	1186 Scots Gaelic	1349 Macedonian	1508 Shona
1032 Afrikaans	1194 Galician	1350 Malayalam	1509 Somali
1039 Amharic	1196 Guarani	1352 Mongolian	1511 Albanian
1044 Arabic	1203 Gujarati	1353 Moldavian	1512 Serbian
1045 Assamese	1209 Hausa	1356 Marathi	1513 Siswati
1051 Aymara	1217 Hindi	1357 Malay	1514 Sesotho
1052 Azerbaijani	1226 Croatian	1358 Maltese	1515 Sundanese
1053 Bashkir	1229 Hungarian	1363 Burmese	1516 Swedish
1057 Byelorussian	1233 Armenian	1365 Nauru	1517 Swahili
1059 Bulgarian	1235 Interlingua	1369 Nepali	1521 Tamil
1060 Bihari	1239 Interlingue	1376 Dutch	1525 Telugu
1061 Bislama	1245 Inupiak	1379 Norwegian	1527 Tajik
1066 Bengali; Bangla	1248 Indonesian	1393 Occitan	1528 Thai
1067 Tibetan	1253 Icelandic	1403 (Afan)Oromo	1529 Tigrinya
1070 Breton	1254 Italian	1408 Oriya	1531 Turkmen
1079 Catalan	1257 Hebrew	1417 Punjabi	1532 Tagalog
1093 Corsican	1261 Japanese	1428 Polish	1534 Setswana
1097 Czech	1269 Yiddish	1435 Pashto; Pushto	1535 Tonga
1103 Welsh	1283 Javanese	1436 Portuguese	1538 Turkish
1105 Danish	1287 Georgian	1463 Quechua	1539 Tsonga
1109 German	1297 Kazakh	1481 Rhaeto- Romance	1540 Tatar
1130 Bhutani	1298 Greenlandic	1482 Kirundi	1543 Twi
1142 Greek	1299 Cambodian	1483 Romanian	1557 Ukrainian
1144 English	1300 Kannada	1489 Russian	1564 Urdu
1145 Esperanto	1301 Korean	1491 Kinyarwanda	1572 Uzbek
1149 Spanish	1305 Kashmiri	1495 Sanskrit	1581 Vietnamese
1150 Estonian	1307 Kurdish	1498 Sindhi	1587 Volapük
1151 Basque	1311 Kirghiz	1501 Sangho	1613 Wolof
1157 Persian	1313 Latin	1502 Serbo- Croatian	1632 Xhosa
1165 Finnish	1326 Lingala	1503 Singhalese	1665 Yoruba
1166 Fiji	1327 Laothian	1505 Slovak	1684 Chinese
1171 Faroese	1332 Lithuanian	1506 Slovenian	1697 Zulu
1174 French	1334 Latvian;		
1181 Frisian	1345 Malagasy		
			1703 Not specified

Index

Numerics

- 16:9 87
- 4:3 LETTER BOX 87
- 4:3 OUTPUT 88
- 4:3 PAN SCAN 87
- 48kHz/96kHz PCM 92
- 5.1 Channel Surround 21, 26

A

- A-B REPEAT 47
- ADVANCED 66
- ALBUM 61
- Album 41
- ANGLE 73
- AUDIO 68, 86
- AUDIO ATT 90
- AUDIO DRC 90
- AUDIO FILTER 91
- AUDIO SETUP 90
- AUTO PLAY 89
- AUTO POWER OFF 89

B

- Batteries 17
- BNR 74

C

- CD 33
- CD DIRECT 90
- CHAPTER 15, 60
- Chapter 10, 98
- CHAPTER VIEWER 62
- Child Lock 35
- COMMAND MODE 18
- COMPONENT OUT 87
- Connecting 19
- Continuous play
 - DATA CD 41
 - DVD 33
 - Super Audio CD/CD/VIDEO CD 33
- Control Menu 14
- CUSTOM 85
- CUSTOM PARENTAL CONTROL 78
- CUSTOM PICTURE MODE 75
- CUSTOM SETUP 89

D

- DATA CD 6, 41
- DIGITAL OUT 91
- Digital output 91
- DIGITAL VIDEO ENHANCER 77
- DIMMER 89
- DISC 60
- Disc Explorer 49
- Disc Memo 54
- DISC MEMO INPUT 54
- Display
 - Control Menu Display 14
 - Disc Explorer display 49
 - Front panel display 10, 65
 - Setup Display 85
- DISTANCE 93
- DOLBY DIGITAL 25, 26, 68, 91, 98
- DOWNMIX 91
- DTS 26, 68, 91, 98
- DVD VIDEO 6, 33, 98
- DVD+RW 98
- DVD/Super Audio CD/CD text 64
- DVD-RW 6, 38, 98

E

- EDIT 54

F

- Fast forward 59
- Fast reverse 59
- FILE 52
- Folder 52
- FOLDER NAME INPUT 54
- Front panel display 10, 65

G

- Genre 56

H

- Handling discs 8
- HD/CD layer 39
- Hooking up 17

I

- INDEX 15, 60
- Index 98
- INSTANT REPLAY 35
- INSTANT SEARCH 35
- INTERLACE 87, 99

J

- JACKET PICTURE 51

K

- Keyboard 55

L

- LANGUAGE SETUP 86
- LEVEL 94
- Loading Discs 49
- Locating
 - a point on a disc 59

M

- MENU 86
- Menu
 - DVD's menu 37
 - Top menu 37
- MP3 6, 41
- Multi/2CH 39

O

- ONE/ALL DISCS 43
- On-screen display
 - Control Menu Display 14
 - Disc Explorer display 49
 - Setup Display 85
- ORIGINAL 38
- ORIGINAL/PLAY LIST 38
- OSD 86

P

- PARENTAL CONTROL 78
- PAUSE MODE 89
- PBC Playback 40
- PICTURE NAVIGATION 62
- PLAY LIST 38
- PLAYBACK MEMORY 89
- PRO LOGIC 25, 98
- PROGRAM 44
- Program Play 44
- PROGRESSIVE 87, 100

Q

- QUICK 86
- Quick Setup 28, 86

R

- Remote 17, 82
- REPEAT 46
- Repeat Play 46
- RESET 86
- Resume Play 36

S

S VIDEO output 19
SCENE 15, 60, 61
Scene 10, 100
SCREEN SAVER 87
SCREEN SETUP 87
Searching 59
Selecting a disc 34, 50
SETUP 85, 86
Setup Display 85
SHUFFLE 46
Shuffle Play 46
SIZE 92
Skipping discs 32
Slow-motion Play 59
SORT 57
SPEAKER SETUP 92
Speakers
 Hooking up 21
SUBTITLE 73, 86
Super Audio CD 39, 100
SURROUND 69

T

TEST TONE 94
TIME/MEMO 15, 60
TIME/TEXT 15, 60, 64
TITLE 15, 60
Title 10, 100
TITLE VIEWER 62
TOP MENU 37
TRACK 15, 60
Track 10, 41, 100
TRACK SELECTION 89
TRACK VIEWER 62
Troubleshooting 95
TV TYPE 87
TVS (TV Virtual Surround)
 69

U

Usable discs 6

V

VIDEO CD 6, 33