

# Panasonic®

## Operating Instructions LCD TV

Model No. **TC-20LB30**

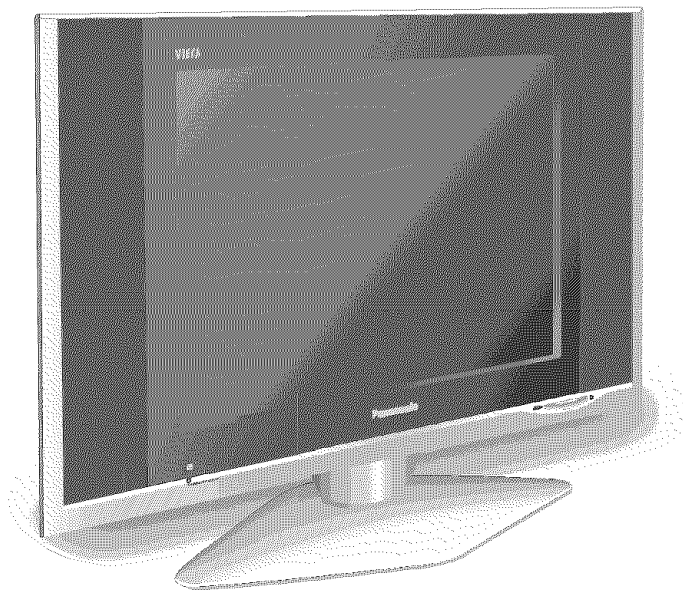

**For assistance, please call : 1-800-211-PANA (7262)**  
or send e-mail to : [consumerproducts@panasonic.com](mailto:consumerproducts@panasonic.com)  
or visit us at [www.panasonic.com](http://www.panasonic.com) (U.S.A.)

**For assistance, please call : 787-750-4300**  
or visit us at [www.panasonic.com](http://www.panasonic.com) (Puerto Rico)

**For assistance, please call : 1-800-561-5505**  
or visit us at [www.panasonic.ca](http://www.panasonic.ca) (Canada)

Before connecting, operating or adjusting this product, please read these instructions completely.  
Please keep this manual for future reference.

**English**

**Español** [Resumen]

TQBC0784

# Important Safety Instructions

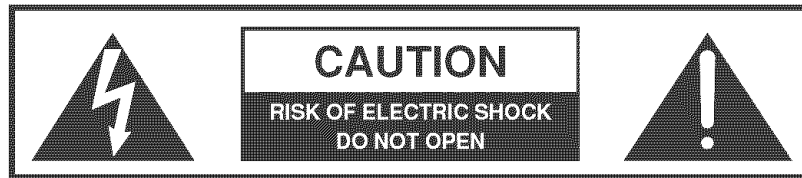

The lightning flash with arrow head within a triangle is intended to tell the user that parts inside the product are a risk of electric shock to persons.

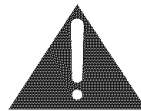

The exclamation point within a triangle is intended to tell the user that important operating and servicing instructions are in the papers with the appliance.

■ **Note to CATV System Installer:** This reminder is provided to direct the CATV system installer's attention to Article 820-40 of the NEC that provides guidelines for proper grounding and, in particular, specifies that the cable ground shall be connected to the grounding system of the building, as close to the point of cable entry as practical.

## ■ Important Safety Instructions for LCD TV

- 1) Read these instructions. All the safety and operating instructions should be read before the appliance is operated.
- 2) Keep these instructions.
- 3) Heed all warnings.
- 4) Follow all instructions.
- 5) Do not use this apparatus near water. For example: Avoid placing it near a bathtub, washbowl, kitchen sink, or laundry tub, in a wet basement, or near a swimming pool, etc.
- 6) Clean only with dry cloth. Unplug this LCD TV from the wall outlet before cleaning. Do not use liquid or aerosol cleaners.
- 7) Do not block any ventilation openings. Install in accordance with the manufacturer's instructions. Slots and openings in the cabinet and the back or bottom are provided for ventilation, and to ensure reliable operation of the LCD TV and to protect it from overheating. These openings must not be blocked or covered. There should be at least 10 cm of space from these openings. The openings should never be blocked by placing the LCD TV on a bed, sofa, rug or other similar surface. This LCD TV should not be placed in a built-in installation such as a bookcase unless proper ventilation is provided.
- 8) Do not install near any heat sources such as radiators, heat registers, stoves, or other apparatus (including amplifiers) that produce heat.
- 9) Do not defeat the safety purpose of the polarized or grounding-type plug. A polarized plug has two blades with one wider than the other. A grounding type plug has two blades and a third grounding prong. The wide blade or the third prong are provided for your safety. If the provided plug does not fit into your outlet, consult an electrician for replacement of the obsolete outlet.
- 10) Protect the power cord from being walked on or pinched particularly at plugs, convenience receptacles, and the point where they exit from the apparatus.
- 11) Only use attachments/accessories specified by the manufacturer. Otherwise it may cause hazards.
- 12) Use only with the cart, stand, tripod, bracket, or table specified by the manufacturer, or sold with the apparatus. When a cart is used, use caution when moving the cart/apparatus combination to avoid injury from tip-over. 
- 13) Unplug this apparatus during lightning storms or when unused for long periods of time. This will prevent damage to the receiver due to lightning and power-line surges.
- 14) Refer all servicing to qualified service personnel. Servicing is required when the apparatus has been damaged in any way, such as power-supply cord or plug is damaged, liquid has been spilled or objects have fallen into the apparatus, the apparatus has been exposed to rain or moisture, does not operate normally, or has been dropped.  
Upon completion of any service or repairs to this LCD TV, ask the service technician to perform routine safety checks to determine that the television is in safe operating condition.
- 15) Operate only from the type of power source indicated on the marking label. If you are not sure of the type of power supplied to your home consult your television dealer or local power company.
- 16) Follow all warnings and instructions marked on the LCD TV.
- 17) Never push objects of any kind into this LCD TV through cabinet slots as they may touch dangerous voltage points or short out parts that could result in a fire or electric shock. Never spill liquid of any kind on the LCD TV.

## Important Safety Instructions

18) If an outside antenna is connected to the television equipment, be sure the antenna system is grounded so as to provide some protection against voltage surges and built up static charges. In the U.S. Selection 810-21 of the National Electrical Code provides information with respect to proper grounding of the mast and supporting structure, grounding of the lead-in wire to an antenna discharge unit, size of grounding conductors, location of antenna discharge unit, connection to grounding electrodes, and requirements for the grounding electrode.

**EXAMPLE OF ANTENNA  
GROUNDING AS PER (NEC)  
NATIONAL ELECTRICAL  
CODE**

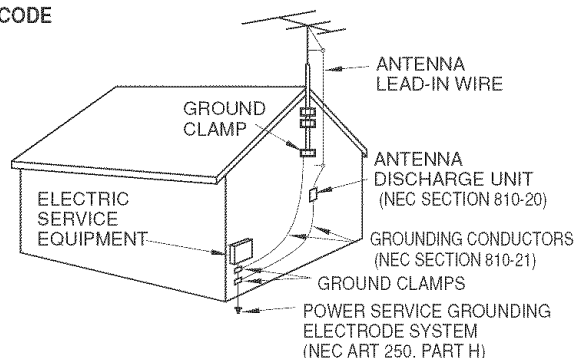

19) An outside antenna system should not be located in the vicinity of overhead power lines or other electric light or power circuits, or where it can fall into such power lines or circuits. When installing an outside antenna system extreme care should be taken to keep from touching such power lines or circuits as contact with them might be fatal.

20) Unplug this LCD TV from the wall outlet, and refer servicing to qualified service personnel under the following conditions:

- a. When the power cord or plug is damaged or frayed.
- b. If liquid has been spilled into the LCD TV.
- c. If the LCD TV has been exposed to rain or water.
- d. If the LCD TV does not operate normally by following the operating instructions.

Adjust only those controls that are covered by the operating instructions as improper adjustment of other controls may result in damage and will often require extensive work by a qualified technician to restore the LCD TV to normal operation.

- e. If the LCD TV has been dropped or the cabinet has been damaged.
- f. When the LCD TV exhibits a distinct change in performance - this indicates a need for service.

21) When replacement parts are required, be sure the service technician uses replacement parts specified by the manufacturer that have the same characteristics as the original part. Unauthorized substitutions may result in fire, electric shock, or other hazards.

22) **WARNING : TO REDUCE THE RISK OF FIRE OR ELECTRIC SHOCK, DO NOT EXPOSE THIS APPARATUS TO RAIN OR MOISTURE. DO NOT PLACE LIQUID CONTAINERS (FLOWER VASES, CUPS, COSMETICS, ETC.) ABOVE THE SET. (INCLUDING ON SHELVES ABOVE, ETC.)**

23) **CAUTION : TO PREVENT ELECTRIC SHOCK DO NOT USE THIS PLUG WITH A RECEPTACLE OR OTHER OUTLET UNLESS THE BLADES CAN BE FULLY INSERTED TO PREVENT BLADE EXPOSURE.**

24) **CAUTION : USE WITH OTHER STAND MAY RESULT IN INSTABILITY CAUSING POSSIBLE INJURY.**

25) **CAUTION : DANGER OF EXPLOSION IF BATTERY IS INCORRECTLY REPLACED. REPLACE ONLY WITH THE SAME OR EQUIVALENT TYPE.**

**NOTE:**

- This equipment is designed to operate in North America and other countries where the broadcasting system and AC house current is exactly the same as in North America.
- The marking or retained image on the LCD panel resulting from fixed image use is not an operating defect and as such is not covered by Warranty. This product is not designed to display fixed image patterns for extended periods of time.

■ **Important Information Regarding Use of Video Games, Computers, Captions or Other Fixed Image Displays.**

The extended use of fixed image program material can cause a permanent "shadow image" on the LCD panel. This background image is viewable on normal programs in the form of a stationary fixed image. This type of irreversible LCD panel deterioration can be limited by observing the following steps:

- A. Reduce the brightness/contrast setting to a minimum viewing level.
- B. Do not display the fixed image for extended periods of time.
- C. Turn the power off when not in actual use.

■ This product utilizes tin-lead solder, and has a fluorescent lamp containing a small amount of mercury. Disposal of these materials may be regulated in your community due to environmental considerations. For disposal or recycling information please contact your local authorities, or the Electronics Industries Alliance: [www.eiae.org](http://www.eiae.org).

## Dear Panasonic Customer

*Welcome to the Panasonic family of customers.*

*We hope that you will have many years of enjoyment from your new LCD TV. To obtain maximum benefit from your set, please read these instructions before making any adjustments, and retain them for future reference.*

*Retain your purchase receipt, and record the model number and serial number of your set in the space provided on the rear cover of these instructions.*

<b>For assistance, please call : 1-800-211-PANA (7262)</b> or send e-mail to : <a href="mailto:consumerproducts@panasonic.com">consumerproducts@panasonic.com</a> or visit us at <a href="http://www.panasonic.com">www.panasonic.com</a> (U.S.A.)
<b>For assistance, please call : 787-750-4300</b> or visit us at <a href="http://www.panasonic.com">www.panasonic.com</a> (Puerto Rico)
<b>For assistance, please call : 1-800-561-5505</b> or visit us at <a href="http://www.panasonic.ca">www.panasonic.ca</a> (Canada)

### Federal Communication Commission Information

This equipment has been tested and found to comply with the limits for a TV Broadcast Receiver, pursuant to Part 15 of the FCC Rules. These limits are designed to provide reasonable protection against harmful interference in a residential installation. This equipment generates, uses and can radiate radio frequency energy and, if not installed and used in accordance with the instructions, may cause harmful interference to radio communications. However, there is no guarantee that interference will not occur in a particular installation. If this equipment does cause or receive interference, which can be determined by turning equipment off and on, the user is encouraged to try to correct the interference by one or more of the following measures:

- Reorient or relocate the TV antenna.
- Increase the separation between TV and other equipment.
- Connect TV into separate outlet from other equipment.
- Consult the dealer or an experienced radio/TV technician for help.

FCC Caution: Pursuant to 47CFR, Part 15.21 of the FCC rules, any changes or modifications not expressly approved by Matsushita Electric Corporation of America could result in harmful interference and would void the user's authority to operate this equipment.



The ENERGY STAR® label, a symbol for energy efficiency, was created by the U.S. Environmental Protection Agency (EPA) and the U.S. Department of Energy (DOE) to help customers identify products that can save them money and protect the environment by saving energy. ENERGY STAR® compliant products generally consume less energy than similar standard products.

# Table of Contents

<b>Important Safety Instructions</b> .....	2	Thumbnail Mode .....	24	
<b>SUPPLIED ACCESSORIES</b> .....	5	Photo Viewer Setup Menu .....	25	
<b>Installation</b> .....	6	<div style="border: 1px solid black; padding: 5px;"> <p style="text-align: center;"><b>Manual de instrucciones [ Resumen ]</b></p> <p><b>Ajuste el soporte con el ángulo deseado ...</b> 26</p> <p><b>Instalación de las pilas del mando a distancia ...</b> 26</p> <p><b>Conexión</b> .....</p></div>		27

# SUPPLIED ACCESSORIES

Check the accessories before installations.

- Operating Instruction book
- Remote Control Transmitter (EUR7726040)
- Batteries for the Remote Control Transmitter (2 × AA size)

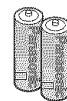
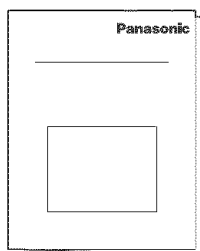

- Warranty Card



- Service Center List (For U.S.A.)



- Customer Card (For U.S.A.)



- Customer Care Plan Card (For U.S.A.)



# Installation

## Receiver Location

Locate for comfortable viewing. Avoid placing where sunlight or other bright light (including reflections) will fall on the screen. Use of some types of fluorescent lighting can reduce remote control transmitter range. Adequate ventilation is essential to prevent internal component failure. Keep away from areas of excessive heat or moisture.

## Optional External Equipment

The Video/Audio connection between components can be made with shielded video and audio cables. For best performance, Antenna cables should utilize 75 ohm coaxial shielded wire. Cables are available from your dealer or electronic supply store. Before you purchase any cables, be sure you know what type of output and input connectors your various components require. Also determine the length of cable you'll need.

## For optimum quality picture

When the LCD is exposed to light from outdoors or lighting fixtures, high-contrast pictures may not be displayed clearly. Turn off florescent lamps near the LCD and place in a location not exposed to outdoor light.

## How to hang the LCD TV on the wall

This LCD TV is for use only with the following optional accessory. Use with any other type of optional accessories may cause instability which could result in the possibility of injury.

- Wall-hanging bracket ..... TY-WK22LR1W

Always be sure to ask a qualified technician to carry out set-up.

## How to use the LCD stand

Adjust the stand to your desired angle.

The stand angle can be adjusted between 5° forward to 10° back, and rotated 20° to the right/left.

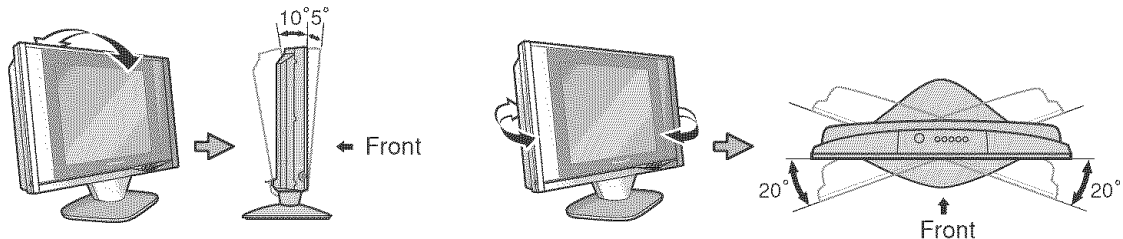

## Remote control battery installation

Requires two AA batteries.

1. Open the battery cover.
2. Install the batteries and replace the cover. Note the correct polarity (+ and -).

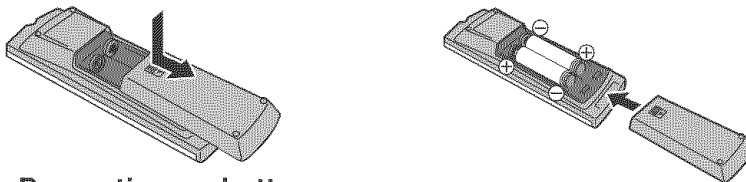

## ⚠ Precaution on battery use

Incorrect installation can cause battery leakage and corrosion that will damage the remote control transmitter.

**Observe the following precautions:**

1. Always use new batteries when replacing the old set.
2. Do not attempt to charge, short-circuit, disassemble, heat or burn used batteries.
3. Battery replacement is necessary when remote control acts sporadically or fails to operate this unit.

## Notes:

- Do not drop, apply shock to or step on the remote control.
  - Do not spill water on the remote control.
  - Do not place objects between the remote control and remote control receiver.
  - Do not use remote control for other equipment at the same time.
  - If the TV does not operate even when using the remote control from a close range, it is time to replace the batteries.
- Refer to the label on back of the remote control for directions on replacing batteries.

# Connections

**Note:**

Cables and connectors are not supplied with this set.

## Antenna Connection

For proper reception of VHF/UHF channels, an external antenna is required. For best reception, an outdoor antenna is recommended. The antenna mode must be set to TV (see page 12, MODE).

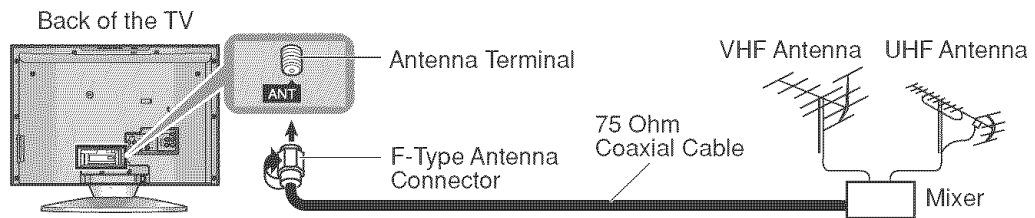

## Cable Box Connection

- For reception of cable channels (01 - 125), connect the cable supplied by your local cable company. The antenna mode must be set to CABLE (see page 12, MODE).
- Certain cable systems offset some channels to reduce interference or view Premium (scrambled) channels. A cable converter box is required for proper reception. Check with your local cable company for its compatibility requirements.
- Set the TV channel to CH3 or CH4 when using this connection.

### Cable Box

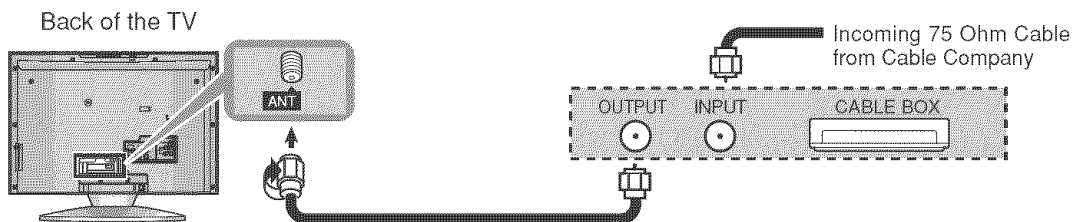

### Cable Box and VCR

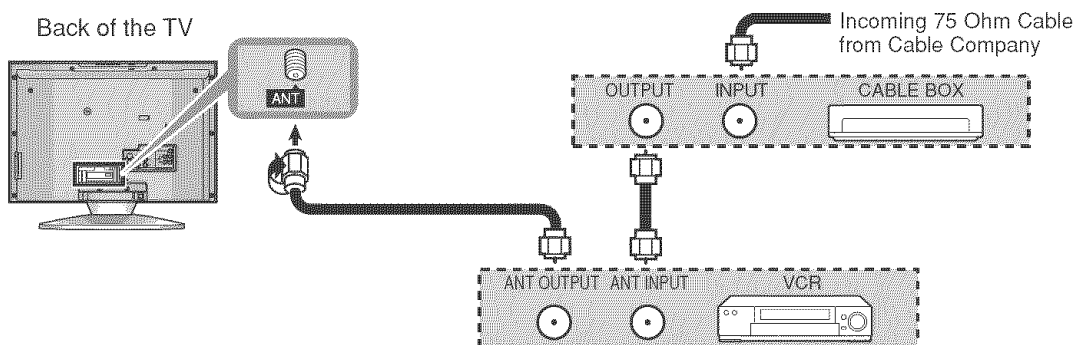

## Connections

### Connecting Other Equipment

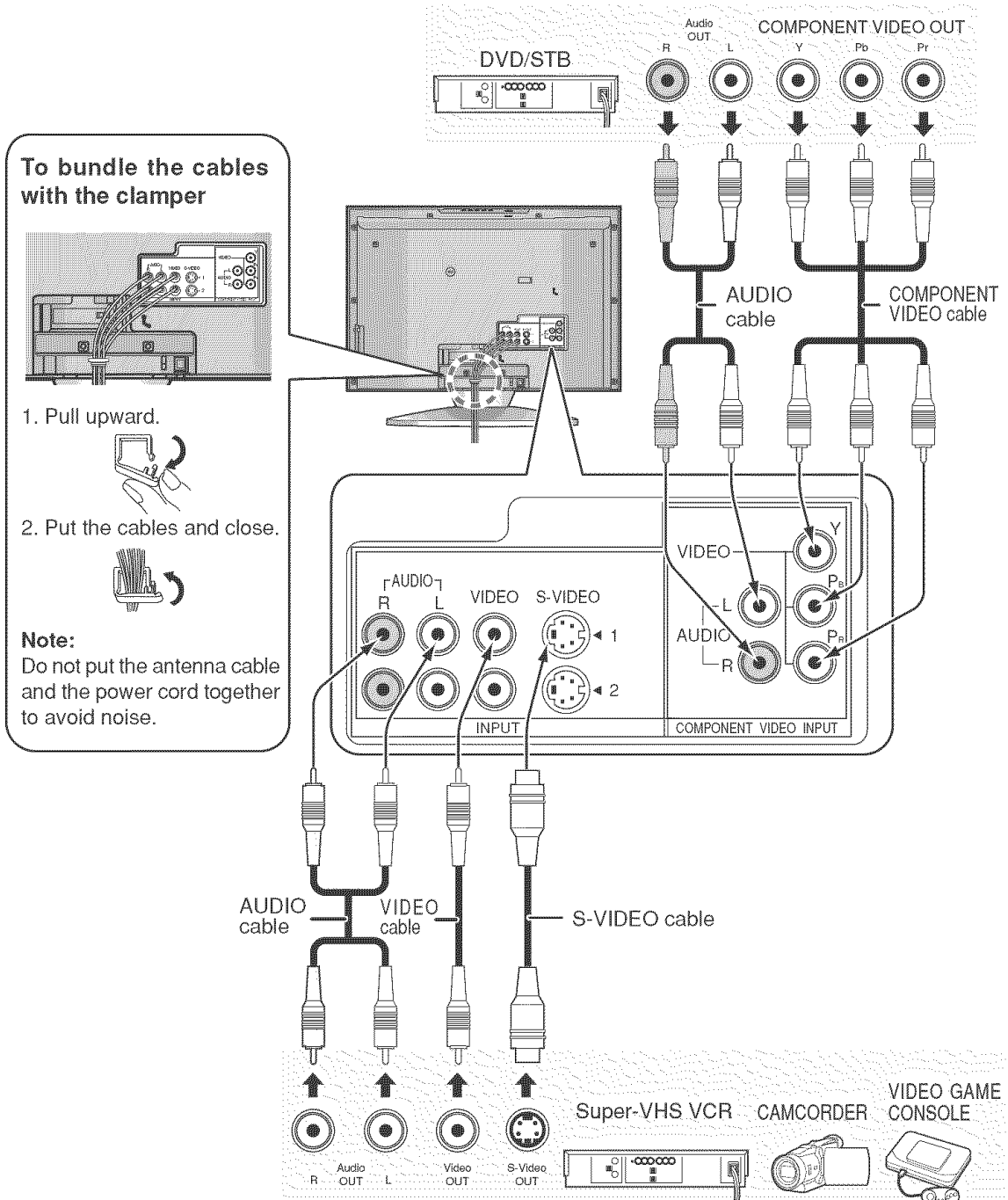

**Notes:**

- Only 480i and 480p are available through the component input terminals.
- When connecting video cables, priority is given to the S-Video cable when both the S-VIDEO input terminal and the VIDEO input terminal are connected.
- With a monaural VCR, connect the monaural audio cable to the AUDIO-L terminal.
- Please make inquiries to video game manufacturers concerning component cables to connect with video game console.



## Connecting Headphones / Earphones

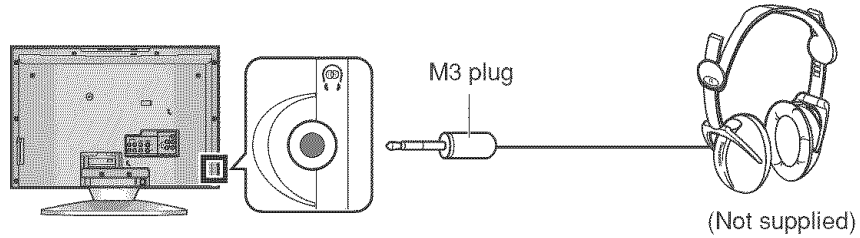

## Power ON / OFF

### Preparation

Connect the plug to the wall outlet.

### Note:

The TV consumes some power as long as the power cord is inserted into the wall outlet.

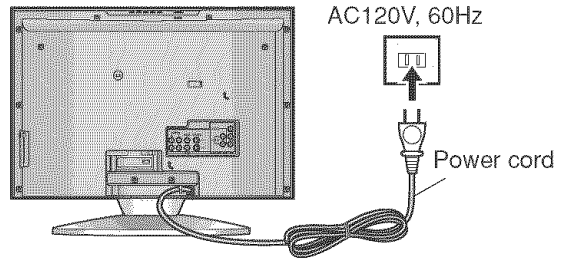

### Main POWER switch

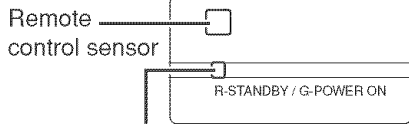
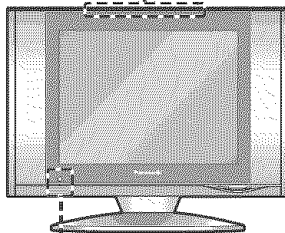
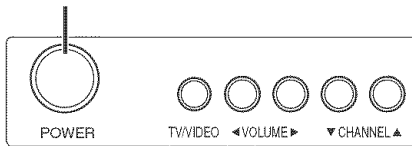

### Power Indicator

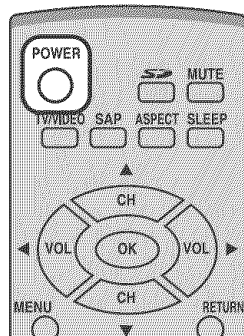

### On the main unit



- Press to turn the TV's main power on/off.
- Power indicator
  - Main power ON : Green
  - Main power OFF : No light

The screen below is displayed for a few moments when the TV is turned on.

e.g.



### On the remote control



- Press to turn the TV on/off.
- Power indicator
  - Power ON : Green
  - Power OFF (Standby) : Red
- This does not work when the main power is off (No light) (see above).

### Note:

Select the menu language in LANGUAGE of SET UP menu (see page 11) before operating the TV.

# Basic Controls

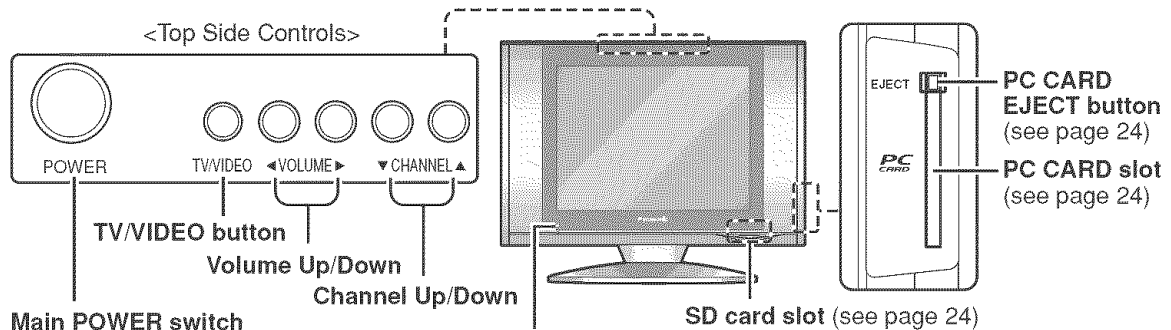

## Main POWER switch

Press to turn the TV's main power on/off. (see page 9)

## Remote control sensor

Within about 23 feet (7 meters) in front of the TV set.

## SD button

Press to access Photo Viewer (see page 24).

## POWER button

Press to turn the TV on or off (see page 9).

### Note:

This does not work when the main power is off (No light).

## TV/VIDEO button

Press to change the input mode.



## SAP button\*

Press to select the audio mode (see also page 21, AUDIO ADJUST).

### Note:

For input signals, change the audio mode on the connected equipment.



## MENU button

(see page 11)

## RETURN button

Press to return to the previous screen.

## Numbered buttons\*

## R-TUNE button\*

Press to switch to previously viewed channel or to switch between TV mode and another input mode.

Not effective under the following conditions:

1. Right after the TV is turned on.
2. After switching TV / CATV (MODE in PROGRAM CHANNELS).
3. Right after the ACP (Automatic channel programming) execution.
4. When the same channel as the present channel is selected.

\* Does not work in Photo Viewer mode.

## MUTE button\*

Press to mute the sound. Press again to cancel mute. Mute is canceled when the power is turned off or volume level is changed.

## ASPECT button\*

(see page 22)

## SLEEP button

Set the sleep time to turn the TV into standby mode.

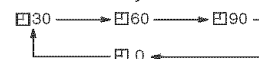

- When 3 minutes left, " 3 " will flash. ("2" for 2 minutes and "1" for 1 minute).
- The SLEEP timer is cancelled when the power is turned off.

## Channel up

Moves cursor upward during menu mode.

## Reduces volume

Moves cursor to the left during menu mode.

## Increases volume

Moves cursor to the right during menu mode.



## Channel down

Moves cursor downward during menu mode.

## RECALL button\*

Press to display channel number, sleep timer and other options.

# Menu Operations

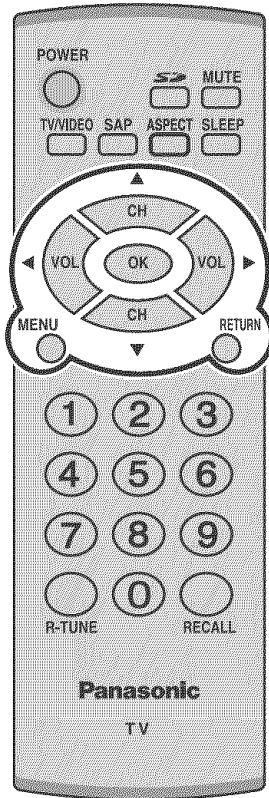

1



Press to display MENU screen.

2

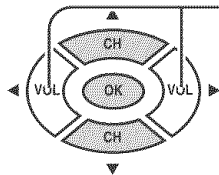

Press to select the MENU screen (ADJUST or SET UP).

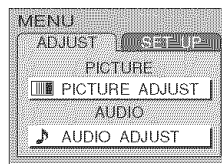

OR

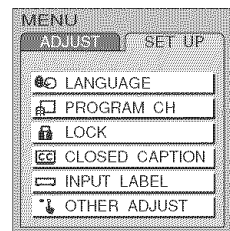

3

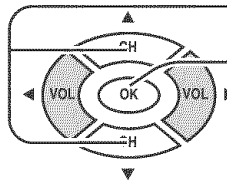

Press to select the sub-menu feature.

Press to display the sub-menu screen.

## Notes:

- Select the menu language in LANGUAGE of SET UP menu before operating the TV.

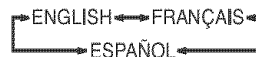

- LANGUAGE, PROGRAM CH, LOCK, CLOSED CAPTION and AUDIO ADJUST are not activated in Photo Viewer mode.
- An On Screen Help box is displayed when a menu is displayed on the TV. This Help box indicates which keys on the remote control are used to navigate the menu shown.

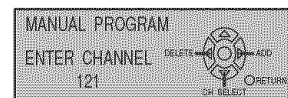

- To return to the previous screen:



- To exit the MENU screen:



This returns TV to normal viewing.

## Menu Operations

### Tuning Channels

- 1 Press the TV/VIDEO button to display the TV channel.
- 2 Press the MENU button to display the MENU screen and select SET UP.

- 3
 

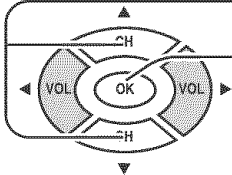

Press to select PROGRAM CH.

Press to display the PROGRAM CHANNELS screen.

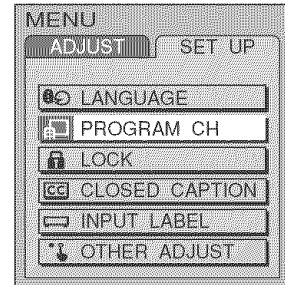

- 4
 

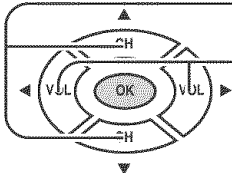

Press to select MODE.

Press to select TV or CABLE.

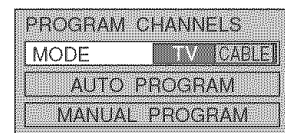

#### Automatic channel programming

Automatically scans and stores all the TV channels.

- 5
 

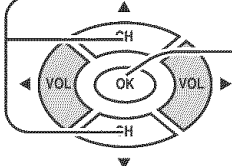

Press to select AUTO PROGRAM.

Press to display the AUTO PROGRAM screen.

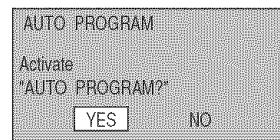

- 6
 

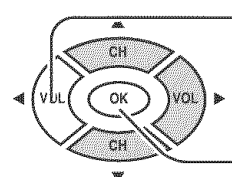

Press to select YES.

Press to start AUTO PROGRAM.

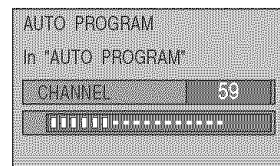

Channels will automatically advance until all channels have been scanned. Channel numbers with video signal received will be stored in the Channel Memory.





#### Notes:

- When any button is pressed during AUTO PROGRAM, the TV will return to the normal viewing. (Channels searched up to the point are added.)
- After AUTO PROGRAM finishes, the lowest channel number added will be displayed.
- When there are no receivable channels, channel 69 (for TV) or channel 125 (for cable TV) is displayed.

## Menu Operations

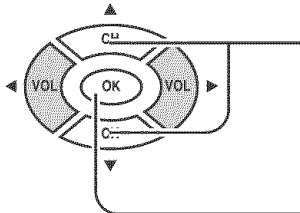
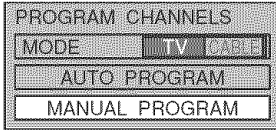
### Manual channel programming

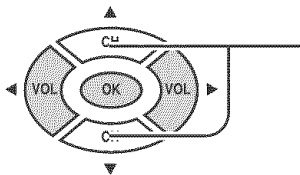
Add or delete a channel manually.

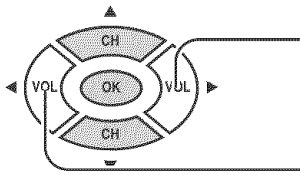
- 5**
- 
- Press to select MANUAL PROGRAM.
- 
- Press to display the MANUAL PROGRAM screen.
- 
- 6**
- 
- Press to select the channel.
- You can also use the numbered buttons.
- 
- 7**
- 
- Press to add the channel to the Channel Memory (the channel number turns blue).
- Press to delete the channel from the Channel Memory (the channel number turns yellow).
- Repeat steps 6 and 7 for other channels.

# Menu Operations

## LOCK

V-Chip technology allows parents to use the TV rating codes to block programs that they feel are inappropriate for their children to watch.

**1** Press the MENU button to display the MENU screen and select SET UP.

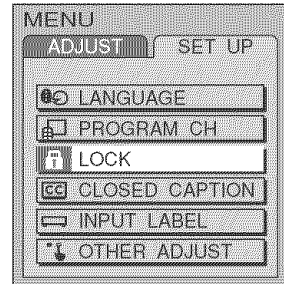

**2** Press to select LOCK.  
Press to display the LOCK screen.

**3** Input 4-digit code.  
 • To clear the numbers while entering the code, press Up or Down .  
 • You will need the code to enter the LOCK menu.  
 • After entering your password for the first time, ENTER CODE FIRST will change to CHANGE CODE.

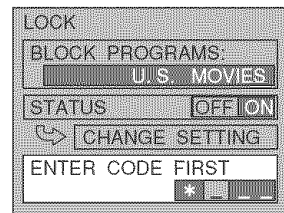

**Note:**  
Use a code that is easy to remember and record it in a safe place.

**4** Press to select BLOCK PROGRAMS.  
Press to select U.S. MOVIES, U.S. TV PROGRAMS, CANADIAN ENGLISH or CANADIAN FRENCH.

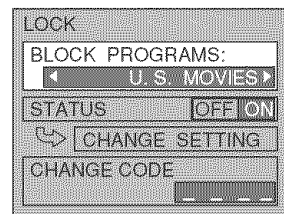

**5** Press to select STATUS.  
Press to select ON or OFF.  
OFF : Can view all programs.  
ON : Cannot view programs locked in CHANGE SETTING.

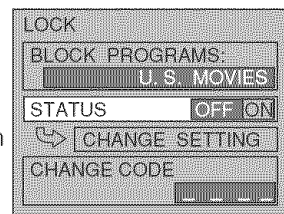

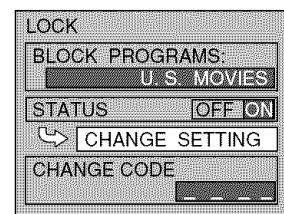

**6** Press to select CHANGE SETTING.  
Press to enter the next menu.

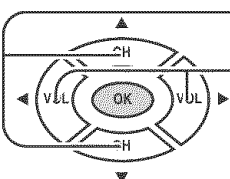

### U.S. TV PROGRAMS

This TV features the "V-Chip technology" which allows you to use U.S. TV PROGRAMS Guide ratings to block various types of TV programs.

**7**  Press to select VIEW NR PROGRAMS?.

 Press to select NO or YES.  
 NO : Cannot view programs with NR signals.  
 YES : Can view programs with NR signals.

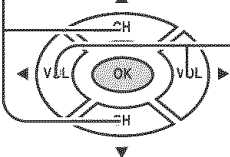
**8**  Press to select SETTING.

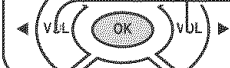
 Press to select BASIC or DETAILED.  
 BASIC : You can select the titles.  
 DETAILED : You can select the titles and options.

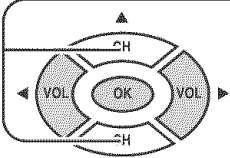
**9**  Press to select the rating.

- When a title field is selected, all ratings below this rating are selected.
- When options within an option field are selected, ratings below this rating within the same field are selected.

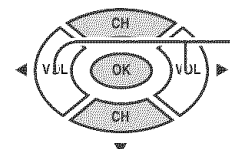
**10**  Press to lock or unlock the rating.  
 Lock : Red  
 Unlock: Green

U.S. TV PROGRAMS

VIEW NR PROGRAMS?  
NO YES

SETTING BASIC

TV-Y

TV-Y7 FV

TV-G

TV-PG V S L D

TV-14 V S L D

TV-MA V S L

Title
Option

NR	Not Rated. See Customer Caution on page 17.
TV-Y	All children. The themes and elements in this program are specifically designed for a very young audience, including children from ages 2-6.
TV-Y7	Directed to older children. Themes and elements in this program may include mild physical or comedic violence, or may frighten children under the age of 7.
TV-G	General audience. It contains little or no violence, no strong language, and little or no sexual dialogue or situations.
TV-PG	Parental guidance suggested. The program may contain infrequent coarse language, limited violence, some suggestive sexual dialogue and situations.
TV-14	Parents strongly cautioned. This program may contain sophisticated themes, sexual content, strong language and more intense violence.
TV-MA	Mature audiences only. This program may contain mature themes, profane language, graphic violence, and explicit sexual content.
FV	FANTASY/CARTOON VIOLENCE
V	VIOLENCE
S	SEX
L	OFFENSIVE LANGUAGE
D	DIALOGUE WITH SEXUAL CONTENT

# Menu Operations

## U.S. MOVIES

This TV features the "V-Chip technology" which allows you to use Motion Picture Ratings when viewing movies or video tapes. This innovation allows parents to block various types of movies and video tapes at their discretion.

**7**

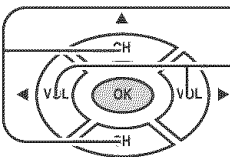

Press to select VIEW NR PROGRAMS?.

Press to select NO or YES.  
NO : Cannot view programs with NR signals.  
YES : Can view programs with NR signals.

**8**

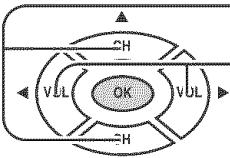

Press to select the rating.

Press to lock or unlock the rating.  
Lock : Red  
Unlock : Green

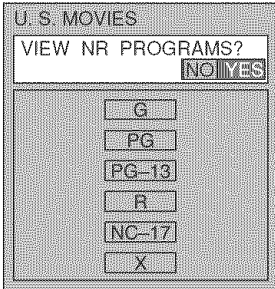

<b>NR</b>	CONTAINS NO RATING (NOT RATED) AND NA (NOT APPLICABLE) PROGRAMS. Movie has not been rated or rating does not apply.
<b>G</b>	GENERAL AUDIENCES. All ages admitted.
<b>PG</b>	PARENTAL GUIDANCE SUGGESTED. Some material may not be suitable for children.
<b>PG-13</b>	PARENTS STRONGLY CAUTIONED. Some material may be inappropriate for children under 13.
<b>R</b>	RESTRICTED. Under 17 requires accompanying parent or adult guardian.
<b>NC-17</b>	NO ONE 17 AND UNDER ADMITTED.
<b>X</b>	ADULTS ONLY.

## CANADIAN ENGLISH / CANADIAN FRENCH

The V-CHIP used in this TV allows you to block various types of movies and television programs based on the two rating systems used in Canada. It also lets you block or unblock Canadian French programs according to various ratings categories.

**7**

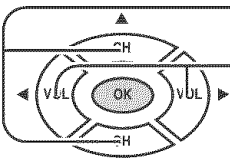

Press to select VIEW E PROGRAMS?.

Press to select NO or YES.  
NO : Cannot view programs with E signals.  
YES : Can view programs with E signals.

**8**

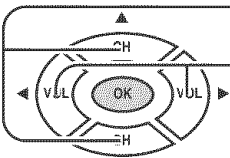

Press to select the rating.

Press to lock or unlock the rating.  
Lock : Red  
Unlock : Green

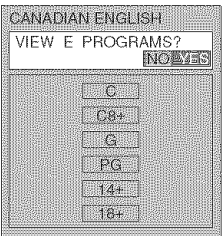
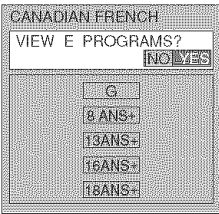

### CANADIAN ENGLISH RATINGS CHART

<b>E</b>	Exempt - Exempt programming includes: news, sports, documentaries and other information programming, talk shows, music videos, and variety programming.
<b>C</b>	Programming intended for children under age 8. No offensive language, nudity or sexual content.
<b>C8+</b>	Programming generally considered acceptable for children 8 years and over. No profanity, nudity or sexual content.
<b>G</b>	General programming, suitable for all audiences.
<b>PG</b>	Parental Guidance suggested. Some material may not be suitable for children.
<b>14+</b>	Programming contains themes or content which may not be suitable for viewers under the age of 14. Parents are strongly cautioned to exercise discretion in permitting viewing by pre-teens and early teens.
<b>18+</b>	18+ years old. Programming restricted to adults. Contains constant violence or scenes of extreme violence.

### CANADIAN FRENCH RATINGS CHART

<b>E</b>	Exempt - Exempt programming.
<b>G</b>	General - Programming intended for audience of all ages. Contains no violence, or the violence content is minimal or is depicted appropriately.
<b>8 ANS+</b>	8+ General - Not recommended for young children. Programming intended for a broad audience but contains light or occasional violence. Adult supervision recommended.
<b>13ANS+</b>	Programming may not be suitable for children under the age of 13 - Contains either a few violent scenes or one or more sufficiently violent scenes to affect them. Adult supervision strongly suggested.
<b>16ANS+</b>	Programming may not be suitable for children under the age of 16 - Contains frequent scenes of violence or intense violence.
<b>18ANS+</b>	Programming restricted to adults. Contains constant violence or scenes of extreme violence.

<i>Customer Caution</i>
<p>The V-Chip system that is used in this set is capable of blocking "NR" programs (non rated, not applicable and none) per FCC Rules Section 15.120(e)(2). If the option of blocking "NR" programs is chosen "unexpected and possibly confusing results may occur, and you may not receive emergency bulletins or any of the following types of programming:"</p> <ul style="list-style-type: none"> <li>• Emergency Bulletins (Such as EAS messages, weather warnings and others)</li> <li>• Locally originated programming • News • Political • Public Service Announcements • Religious • Sports</li> <li>• Weather</li> </ul>

## Menu Operations

# CLOSED CAPTION

This unit has a built in decoder that provides a visual depiction of the audio portion of a television program in the form of written words across the screen (white or colored letters on a black background). It allows you to read the dialogue of a television program or other information.

**1** Press the MENU button to display the MENU screen and select SET UP.

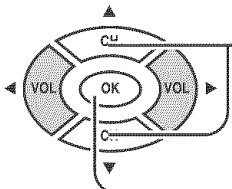
**2**  Press to select CLOSED CAPTION.  
Press to display the CLOSED CAPTION screen.

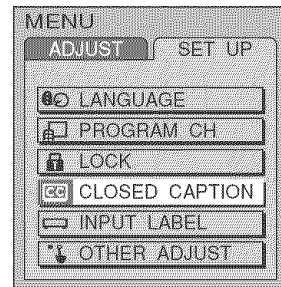

### CC ON MUTE

Displays the On-Screen Closed Caption when the MUTE button is pressed. To delete the closed caption, press the MUTE button again.

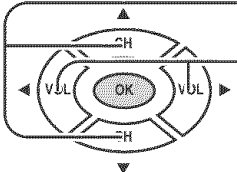
**3-1**  Press to select **CC** ON MUTE.  
Press to select NO (OFF), C1 or C2.

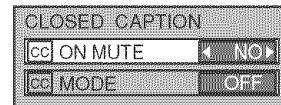

#### Notes:

- To activate this feature, set **CC** MODE to OFF .
- The program must have Closed Caption.

### CC MODE

Displays the On-Screen Closed Caption.

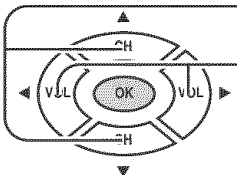
**3-2**  Press to select **CC** MODE.  
Press to select OFF, C1 or C2.

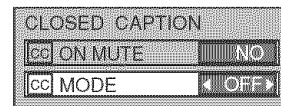

- **OFF (NO)** : Recommended mode when Closed Caption is not being used.
- **C1** : For video related information that can be displayed (up to 4 lines of script strategically placed on the television screen so that it does not obstruct relevant parts of the picture).
- **C2** : Another mode used for video related information.

## INPUT LABEL

You can change the label of the video inputs to match with the connected device (VCR, DVD player etc.).

**1** Press the MENU button to display the MENU screen and select SET UP.

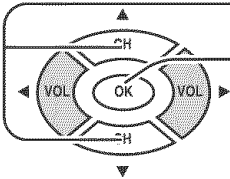
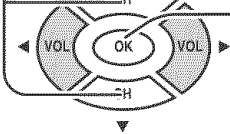
**2**  Press to select INPUT LABEL.  
 Press to display the INPUT LABEL screen.

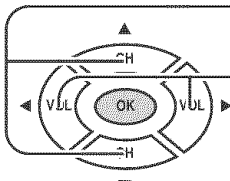
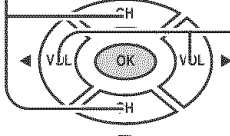
**3**  Press to select the video input (VIDEO1, VIDEO2 or COMPONENT).  
 Press to select the INPUT LABEL. (VIDEO1/VIDEO2/COMPONENT, VCR, LD, GAME, DVD, DTV, SKIP\* or [BLANK])  
 \* Select to skip unused video input when pressing TV/VIDEO button.

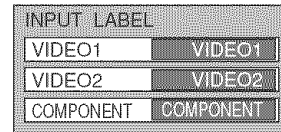
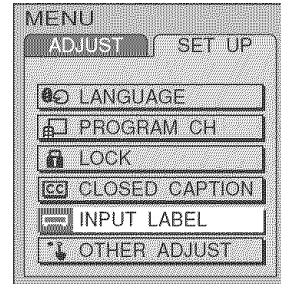

## OTHER ADJUST

**1** Press the MENU button to display the MENU screen and select SET UP.

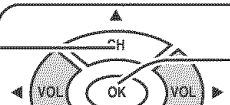
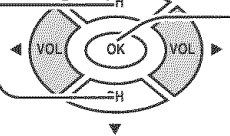
**2**  Press to select OTHER ADJUST.  
 Press to display the OTHER ADJUST screen.

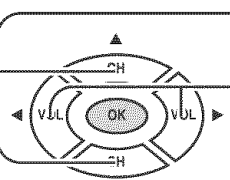
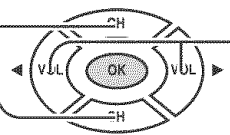
**3**  Press to select the item.  
 Press to select the setting.

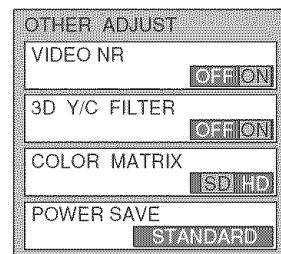
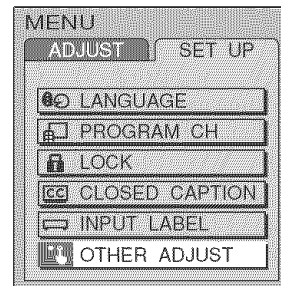

### VIDEO NR

Reduce video noise in the picture. Not available for Photo Viewer mode.

OFF ↔ ON

### 3D Y/C FILTER

Minimizes noise and cross color in the picture. Not available for COMPONENT VIDEO INPUT, S-VIDEO INPUT and Photo Viewer mode.

OFF ↔ ON

### COLOR MATRIX

Displays input signals (480p signals) in a natural color. Automatically adjusts color parameters for HD (high definition) and SD (standard definition). Not available for Photo Viewer mode.

SD ↔ HD

### POWER SAVE

Reduces screen brightness to lower power consumption. Eye-friendly for viewing in a dark room.

STANDARD ↔ SAVING

## Menu Operations

### PICTURE ADJUST

**1** Press the MENU button to display the MENU screen and select ADJUST.

**2**  Press to select PICTURE ADJUST.

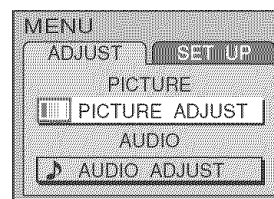

Press to display the PICTURE ADJUST screen.

**3**  Press to select the sub-menu.

Adjust the setting watching the picture behind the menu.

Press to activate the setting if necessary.

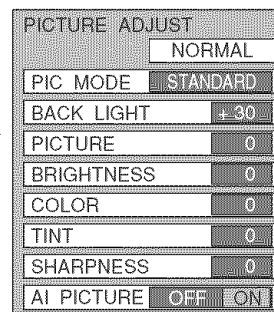

#### NORMAL/NORMALIZE

Select "NORMALIZE" and press "OK" button to return each PIC MODE to the factory default setting.

#### Notes:

- "NORMAL" means the PIC MODE is in the factory default setting. "NORMAL" changes to "NORMALIZE" when you change the setting of BACK LIGHT, PICTURE, BRIGHTNESS, COLOR, TINT, SHARPNESS or AI PICTURE.
- You can normalize each PIC MODE separately.

#### PICTURE MODE

The picture mode is stored for TV, VIDEO1/VIDEO2 and COMPONENT individually.

MODE	Function
<b>VIVID</b>	Displays a clear image with high contrast.
<b>STANDARD</b>	Displays a standard image.
<b>CINEMA</b>	Ideal for watching movies in a dark room.

#### BACK LIGHT, PICTURE, BRIGHTNESS, COLOR, TINT, SHARPNESS, AI PICTURE

You can change the sub-menu settings (BACK LIGHT, PICTURE, BRIGHTNESS, COLOR, TINT, SHARPNESS and AI PICTURE) for each PIC MODE (STANDARD, CINEMA, and VIVID) according to your personal preference.

Sub-menu	Function
<b>BACK LIGHT</b>	Luminance of the back light is adjusted.
<b>PICTURE</b>	Selects proper brightness and density for the room.
<b>BRIGHTNESS</b>	Adjusts for easier viewing of dark pictures such as night scenes.
<b>COLOR</b>	Adjusts the level of color.
<b>TINT</b>	Adjusts for flesh tone color.
<b>SHARPNESS</b>	Adjusts the degree of sharpness.
<b>AI PICTURE</b>	Controls dark areas without affecting the black level or brightness in the overall picture.

## AUDIO ADJUST

**1** Press the MENU button to display the MENU screen and select ADJUST.

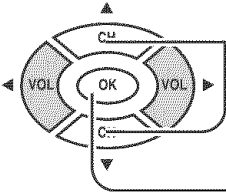
**2**  Press to select AUDIO ADJUST.

**3**  Press to display the AUDIO ADJUST screen.

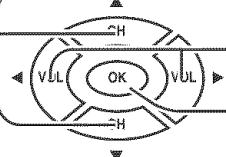
 Press to select the sub-menu.

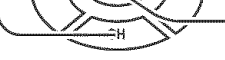
 Select the setting listening to the sound.

 Press to activate the setting if necessary.

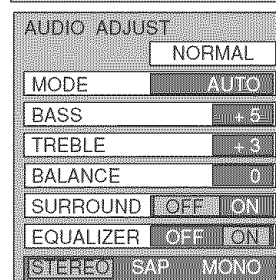
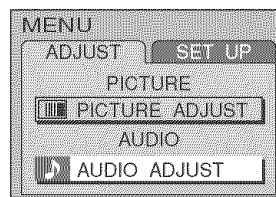

### NORMAL/NORMALIZE

Select "NORMALIZE" and press "OK" button to return each MODE to the factory default setting.

#### Notes:

- "NORMAL" means the MODE is in the factory default setting. "NORMAL" changes to "NORMALIZE" when you change the setting of BASS, TREBLE, BALANCE, SURROUND or EQUALIZER.
- You can normalize each MODE separately.

### MODE

MODE	Function
<b>DYNAMIC</b>	Gives contrast to sound.
<b>MUSIC</b>	For programs consisting mainly of music. Enhances high sounds (around 4 kHz).
<b>AUTO</b>	Automatically adjusts for a wide Dynamic Range.
<b>STANDARD</b>	Emits the original sound.

### BASS, TREBLE, BALANCE, SURROUND, EQUALIZER

You can change the level of each sub-menu (BASS, TREBLE, BALANCE, SURROUND and EQUALIZER) for each MODE (AUTO, STANDARD, DYNAMIC and MUSIC) according to your personal preference.

Sub-menu	Function
<b>BASS</b>	Adjusts low frequencies.
<b>TREBLE</b>	Adjusts high frequencies.
<b>BALANCE</b>	Adjusts left and right volume.
<b>SURROUND</b>	To enjoy a concert hall effect, select ON when stereo is playing.
<b>EQUALIZER</b>	Makes voice sound clear. Normally set to ON.

### STEREO/SAP/MONO

#### Note:

- Red display : With signal
- White display : No signal
- White display (All modes) : MONO
- To change the mode using SAP button (see page 10).

MODE	Function
<b>STEREO</b>	Two channel audio reception.
<b>SAP</b>	Second Audio Programming (typically used for bilingual audio).
<b>MONO</b>	Select when stereo signal is weak.

# ASPECT Controls

(For Video input only)

This feature allows you to enjoy viewing the picture at its maximum size, including wide screen cinema format picture.

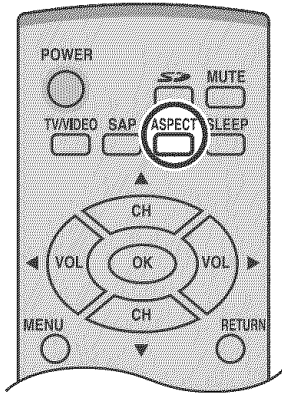

ASPECT

Each time you press the button:

4 : 3 ↔ 16 : 9

**Notes:**

- The aspect setting is stored separately for VIDEO1, VIDEO2 and COMPONENT.
- In TV mode and Photo Viewer mode, the aspect is fixed at 4:3.

Mode	Picture	Explanation
4 : 3		4:3 mode will display a 4:3 picture at its standard 4:3 size without any stretching.
16 : 9		16:9 mode will display 16:9 aspect ratio picture. Bars can be seen at the top and bottom of the image (not available in TV mode).

# Photo Viewer

Photo Viewer lets you display JPEG images recorded by digital still camera on SD card or other types of memory card when it is inserted in the proper card slot.

## Compatible card type and card size

### SD card slot

- SD Card (512MB)
- Multi Media Card (128MB)
- miniSD Card\* (128MB)

### PCMCIA card slot

- SD Card (512MB)
- Multi Media Card (128MB)
- Smart Media (128MB)
- xD Picture Card(128MB)
- Memory Stick Pro (1GB)
- miniSD Card\* (128MB)
- Compact Flash (1GB)
- Memory Stick (128MB)
- Flash ATA (128 MB)

The cards require standard PCMCIA card adapter. (Some PC card adapter will not be compatible).

\* miniSD Card requires miniSD adapter.

- Photo Viewer is not compatible with card type hard disk (Micro Drive, Mobile type hard disk, etc).
- Memory cards are not supplied with this television.
- When both SD card and PCMCIA card are inserted in the slot, SD card has the priority.

### ■ Card Data Protection

- Do not remove the card while Photo Viewer is accessing the information (when the card icon is flashing). Such action may damage the memory card or the unit itself.
- Before inserting or removing the PCMCIA card, make sure that the TV is turned Off. Otherwise, it may damage the unit.
- Do not touch the terminals on the back of the SD card / PCMCIA card.
- Always insert a card in the correct direction. Failure to do so may result in damage to the card and this unit.
- Do not subject the card to excessive pressure or strong impacts.
- Electrical interference, electrostatic discharges and malfunctions of the unit or card may all result in data loss or damage to the card.
- Stored data should be periodically backed up as a protection against data corruption, data loss or device malfunction. Please note that Panasonic shall not accept any liability for damage or loss of stored data.
- **WARNING: As with any small object, an SD card can be swallowed by young children. Do not allow children to handle SD card. Please remove SD card immediately after use.**

## Folders and Files

- Photo Viewer can only show still images recorded by a digital still camera with DCF\* and EXIF standard JPEG file.
- \* DCF (Design rule for Camera File system) Unified standard established by Japan Electronics and Information Technology Industries Association (JEITA).
- Memory cards must be formatted with FAT12 or FAT16 in order to be viewed on TV. If the card is not formatted, it may cause incompatibility with certain memory card adapters. If this happens, reformat the card using your digital still camera. **Reformatting the card will erase the images stored in it.** Refer to your camera manual for more information.
- Maximum number of folders that can be displayed: **100**.
- Maximum number of files that can be displayed: **3000**.
- **Picture resolution:** Compatible in the range 64 x 64 - 8192 x 8192 (sub-sampling 4:2:2 or 4:2:0)
- If the image is imported from a PC, it must follow the EXIF (Exchangeable Image File Format) 2.0, 2.1, 2.2 in addition to the DCF format.
- The JPEG modified using a PC will not be displayed on TV.
- The Photo Viewer cannot display Motion JPEG and still image not DCF formatted (i.e. TIFF, BMP).
- If the file is partially corrupted, it may be shown in lower resolution.
- The displayed image size depends on the recorded size.

### Example folder structure

JPEG images in all the folders are displayed sequentially.

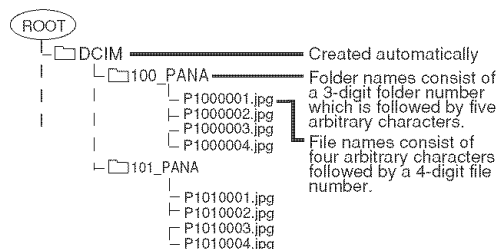

### Notes:

- Folder and file names may vary according to the digital still camera.
- Use the characters "a-z", "A-Z", "0-9" and "\_" to name a directory or a file. Do not use two-byte characters or other special codes.

# Photo Viewer

## Inserting and removing a card

**SD card slot**  
Insert the card until it clicks in.  
Label side upward



Push the center of the card to remove the card.



**PCMCIA card slot**  
Turn the TV off before inserting or removing a PCMCIA card.

Insert the card.

- Align the direction of ◀ mark.
- Label side facing toward the TV's front panel.

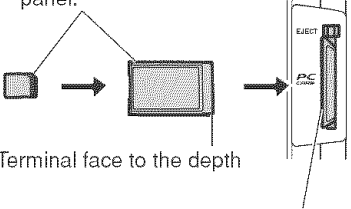

Terminal face to the depth

Holding both edges, securely insert it to the depth.

Remove the card.

1. Push, the EJECT button pops out.
2. Push it again.

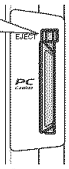

**If the eject button does not pop out:**  
Push in PCMCIA card again, and then push again the eject button.

**Note:**  
If PCMCIA card adapter is used, remove it together with the memory card.

## Thumbnail Mode

The thumbnail screen is the initial entry screen from the main menu.

- When both SD card and PCMCIA card are inserted, the TV plays SD card. To play a PCMCIA card, select "PC" in "Card" (see page 25).

**1** Insert the card into the appropriate slot (see above).  
OR  
Press to display the thumbnail screen.

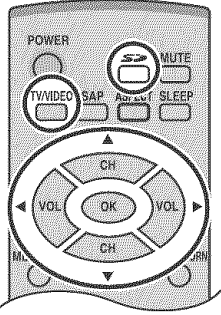
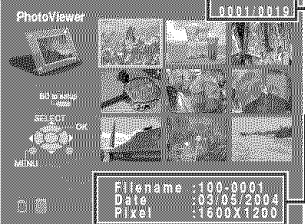
Picture No. / Total No. of pictures

File name, the date and the pixel (resolution) of the picture

**Notes:**

- It may take long time to display the thumbnail if there are lots of files or the file size is large.
- The video disappears from the screen while the Photo Viewer accesses the information from the card. After accessing the images in the card, a thumbnail screen is displayed.

**2** Select the thumbnail image.  
Press to display the image in the single picture view mode.

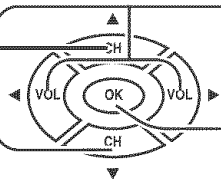

**3** Press to select the next or the previous picture.  
• Press CH ▲, CH ▼ to rotate the picture ninety degrees.  
• Press OK to return to the thumbnail screen.

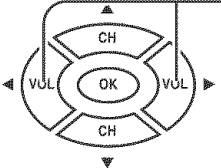

Single picture view mode

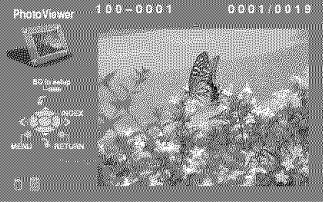

• To exit Photo Viewer:  This returns TV to normal viewing.



## Photo Viewer Setup Menu

This menu allows you to customize features in the Photo Viewer Setup Menu.

While in the thumbnail mode or the single picture view mode (see page 24)

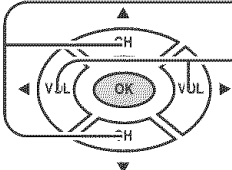
- 1  Press to display the Setup Menu screen.
- 2  Press to select the sub-menu.  
Press to adjust or activate the sub-menu.

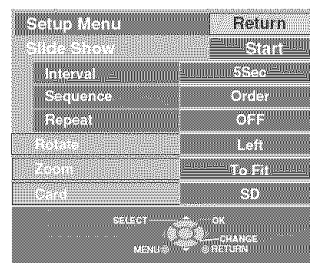

### Slide Show

Select the sub-menu settings. Select "Start" and press **OK** to start the slide show.

#### Note:

Press **OK** again to stop the slide show.

Sub-menu	Setting
Interval	5Sec, 10Sec, 15Sec, 30Sec, 60Sec, 90Sec or 10Min
Sequence	Order or Random
Repeat	OFF or ON

### Rotate

Select "Left" or "Right" and press **OK** to rotate the image (see also page 24).

### Zoom

(While in the single picture view mode only)

Select the magnification of the single picture display and press **OK**.

#### Notes:

- Press **CH ▲**, **CH ▼**, **VOL ◀**, **VOL ▶** to move the image in the picture frame.
- Press **OK** again to view the picture in normal magnification.

### Card

Select either "SD" or "PC" when both cards are inserted in the slots.  
Press **OK** to determine the selection.

### ■ Error messages

"Card is not inserted correctly"	Insert a card.
"This type of image is not supported."	The JPEG file is corrupted and cannot be decoded.
"This type of format is not supported."	The card is not formatted with FAT 12 or FAT 16 or if it is not DCF standard.
 "	Thumbnail and main picture cannot be shown.
"Photo Viewer cannot support over 3000 JPEG files."	Over 3000 image files.
"Photo Viewer cannot support over 8192 x 8192 pixels."	Resolution over.
"This type of card is not supported."	Incompatible card is inserted.

# Manual de instrucciones [ Resumen ]

## *Estimado cliente de Panasonic*

*Bienvenido a la familia de clientes de Panasonic.*

*Esperamos sinceramente que disfrute durante muchos años de su nuevo Esperamos sinceramente que disfrute durante muchos años de su nuevo televisor LCD.*

*Para obtener el máximo beneficio de su aparato, lea estas instrucciones antes de hacer cualquier ajuste, y guárdelas para poder utilizarlas como referencia en el futuro.*

*Guarde también el recibo de su compra, y anote el número del modelo y el número de serie de su aparato en el espacio provisto en la cubierta posterior de estas instrucciones.*

## Ajuste el soporte con el ángulo deseado

El ángulo del soporte se puede ajustar entre 5° hacia delante y 10° hacia atrás, y se puede girar 20° hacia la derecha/izquierda.

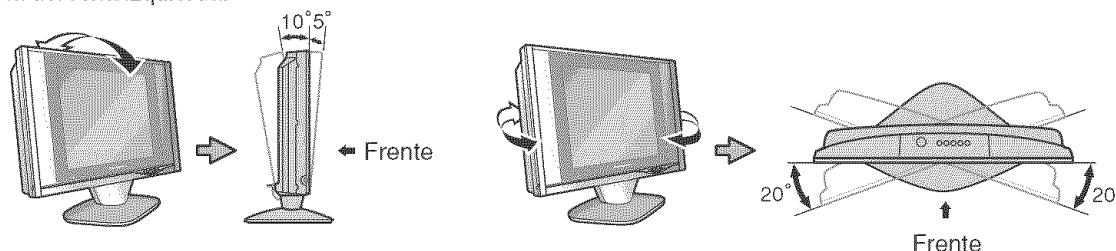

## Instalación de las pilas del mando a distancia

Se necesitan dos pilas AA.

1. Abra la cubierta de las pilas.

2. Instale las pilas y vuelva a poner la tapa. Tenga en cuenta las polaridades (+ y -) al instalar las pilas.

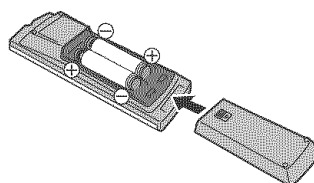
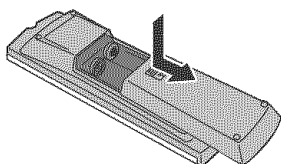

### ⚠ Precauciones relacionadas con la utilización de las pilas

La instalación incorrecta de las pilas puede causar fugas en las mismas que podrían estropear el transmisor de mando a distancia.

**Tome las precauciones siguientes:**

1. Utilice siempre pilas nuevas cuando reemplace las viejas.
2. No intente cargar, cortocircuitar, desarmar, calentar o quemar las pilas usadas.
3. Las pilas deberán cambiarse cuando el mando a distancia funcione esporádicamente o no pueda controlar esta unidad.

# Conexión

## Nota:

Con este aparato no se suministran cables ni conectores.

## Conexión de antena

Para recibir correctamente los canales de VHF/UHF se requiere una antena externa. Para obtener la mejor recepción se recomienda utilizar una antena para exteriores. El modo de antena debe ajustarse a TV (consulte la página 31, MODO).

La parte posterior del televisor

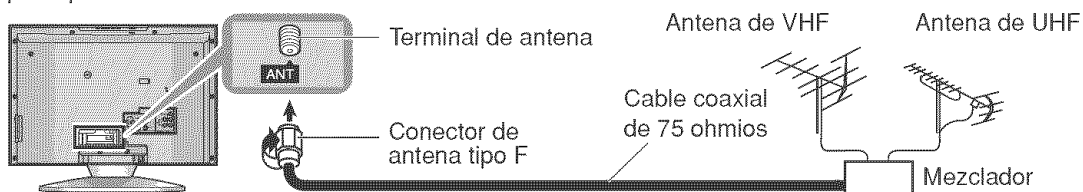

## Conexión del receptor de TV por cable

- Para recibir los canales de televisión por cable (01 - 125) conecte el cable suministrado por su compañía de televisión por cable. El modo de antena debe ajustarse a CABLE (consulte la página 31, MODO).
- Ciertos sistemas de televisión por cable neutralizan algunos canales para reducir interferencias o tienen canales especiales (codificados). Para recibir correctamente estos canales se necesita un sintonizador de conversión de televisión por cable. Póngase en contacto con su compañía de televisión por cable para conocer los requerimientos de compatibilidad.
- Ponga el canal del televisor en CH3 o CH4 utilice esta conexión.

### Receptor de TV por cable

La parte posterior del televisor

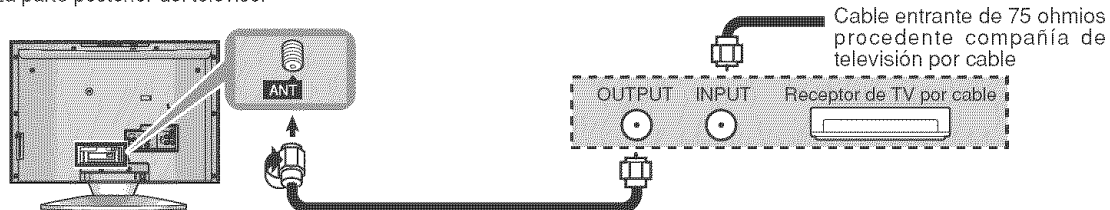

### Receptor de TV por cable y Videgrabadora

La parte posterior del televisor

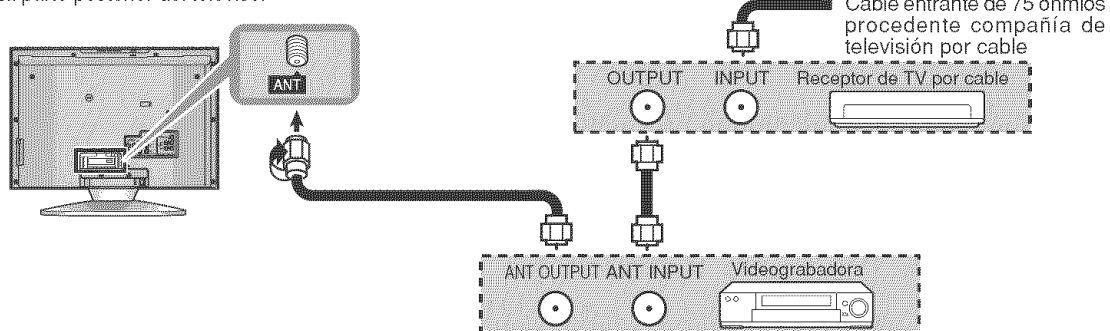

## Conexión

### Conexión de auriculares

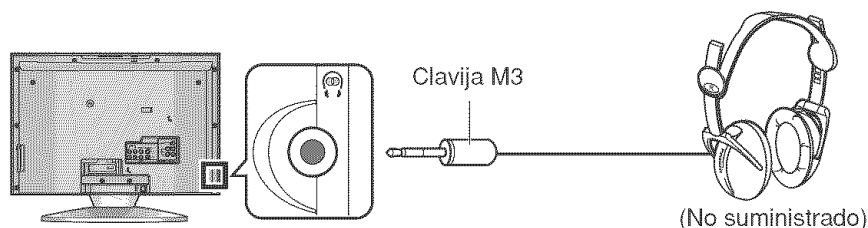

## Conexión/desconexión de la alimentación

### Preparación

Conecte el enchufe al tomacorriente.

### Nota:

El televisor consumirá algo de corriente siempre que el enchufe del cable de alimentación esté introducido en la toma de corriente.

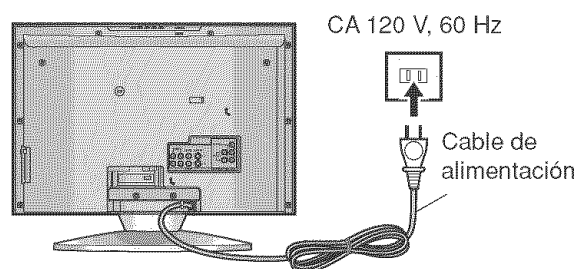

Interruptor POWER principal

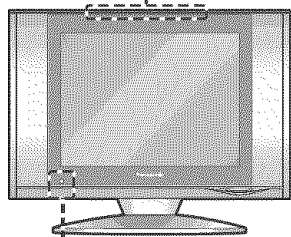
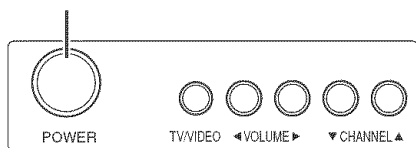

Sensor de mando a distancia

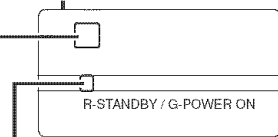

Indicador de la alimentación

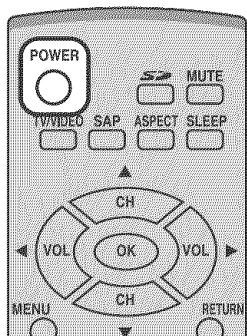

### En el aparato principal



Púselo para conectar/desconectar la alimentación principal del televisor.

• Indicador de la alimentación

Alimentación principal conectada : Verde

Alimentación principal desconectada : Apagado

La pantalla de abajo se visualiza durante un rato cuando se enciende el televisor.

Ej.:



### En el mando a distancia



Púselo para encender/apagar el televisor.

• Indicador de la alimentación

Encendido : Verde

Apagado (En espera) : Rojo

• Esto no funciona cuando la alimentación principal está desconectada (apagado) (consulte arriba).

### Nota:

Seleccione el idioma de menú en Idioma de la pantalla Configu. (consulte la página 30) antes de utilizar el televisor.

# Controles básicos

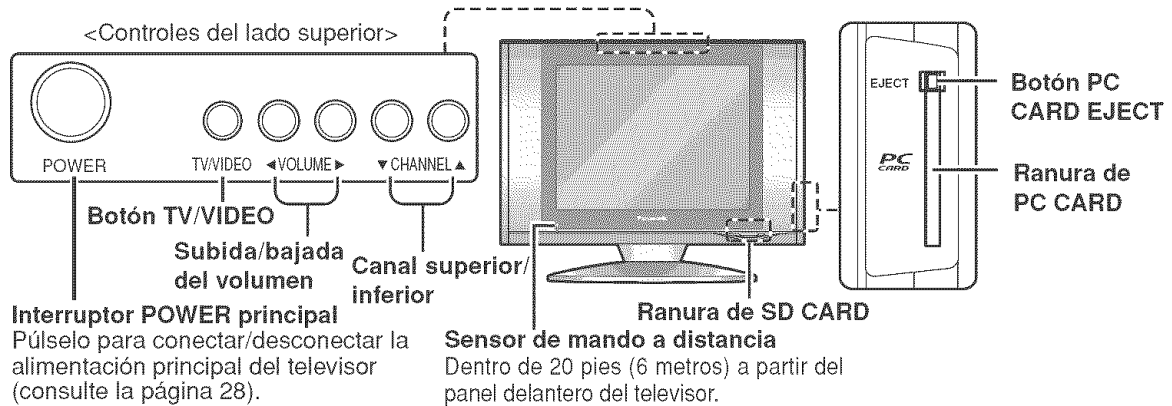

## Botón SD

Púselo para acceder Photo Viewer (consulte la página 33)

## Botón de la alimentación

Púselo para encender o apagar el televisor (consulte la página 28).

### Nota:

Esto no funciona cuando la alimentación principal está desconectada (apagado).

## Botón TV/VIDEO

Púselo para cambiar el modo de entrada.

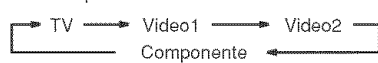

## Botón SAP\*

Púselo para seleccionar el modo de audio. También puede cambiar el modo en la pantalla MENU.

### Nota:

Para las señales de entrada, cambie el modo de audio en el equipo conectado.

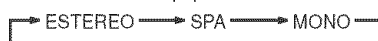

## Botón MENU

(consulte la página 30)

## Botón RETURN

Púselo para volver a la pantalla anterior.

## Botones numerados \*

## Botón R-TUNE \*

Púselo para cambiar a un canal visto previamente o para cambiar entre el modo del televisor y otro modo de entrada.

No resulta efectivo bajo las condiciones siguientes:

1. Justo después de encender el televisor.
2. Después de cambiar TV / CATV (MODO en Prog. Canales).
3. Justo después de la ejecución de ACP (programación automática de canales).
4. Cuando se selecciona el mismo canal que el canal actual.

\* No funciona en el modo Photo Viewer.

## Botón MUTE\*

Púselo para silenciar el sonido. Púselo de nuevo para cancelar el silenciamiento. El silenciamiento se cancela cuando se desconecta la alimentación o se cambia en nivel del sonido.

## Botón ASPECT \*

4 : 3 ↔ 16 : 9

## Botón SLEEP

Ponga el tiempo tras el cual el televisor se pondrá en el modo de espera.

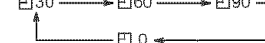

- Cuando queden 3 minutos parpadeará "3" ("2" para 2 minutos y "1" para 1 minuto).
- El temporizador de cancelado se cancelará cuando se desconecte la alimentación.

## Canal superior

Mueve el cursor hacia arriba durante el modo del menú.

### Reduce el volumen

Mueve el cursor hacia la izquierda durante el modo del menú.

### Aumenta el volumen

Mueve el cursor hacia la derecha durante el modo del menú.

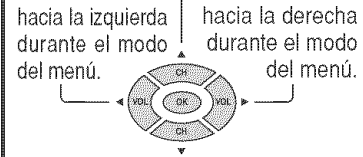

## Canal inferior

Mueve el cursor hacia abajo durante el modo del menú.

## Botón RECALL \*

Púselo para visualizar el número del canal, el temporizador de cancelado y otras opciones.

# Operaciones con menús

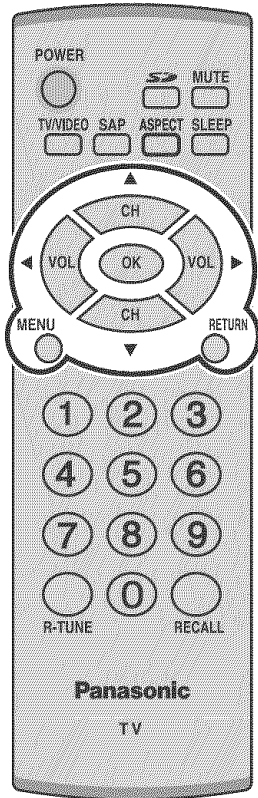

**1**  Púselo para visualizar la pantalla MENU.

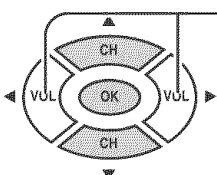
**2**  Púselo para seleccionar la pantalla MENU (Ajuste o Configu.).

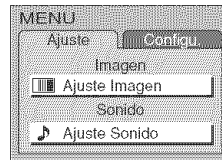

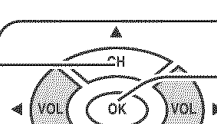
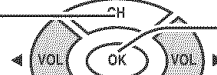
**3**  Púselo para seleccionar la función de menú secundario.  
 Púselo para visualizar la pantalla de menú secundario.

**Notas:**

- Seleccione el idioma de menú en Idioma de la pantalla Configu. antes de utilizar el televisor.

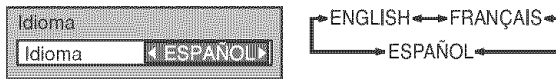

- Idioma, Prog. Canales, Bloqueo, Subtítulos y Ajuste Sonido no se activan en el modo Photo Viewer.
- Cuando se visualiza un menú en el televisor aparece un cuadro de ayuda en la pantalla. Este cuadro de ayuda indica qué teclas del mando a distancia se utilizan para navegar por el menú mostrado.

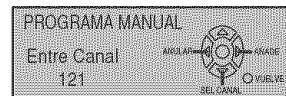

• Para volver a la pantalla anterior : 

• Para salir de la pantalla MENU :  Con esto se retorna a la visión normal.

## Sintonización de canales

**1** Pulse el botón TV/VIDEO para visualizar el canal de TV.

**2** Pulse el botón MENU para visualizar la pantalla MENU y seleccione Configu.

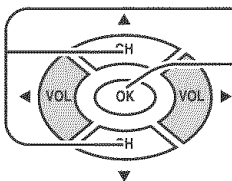
**3**  Pulse para seleccionar Prog. Canales.  
Pulse para visualizar la pantalla Prog. Canales.

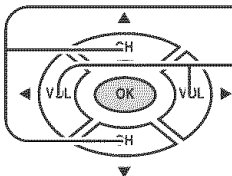

**4**  Pulse para seleccionar MODO.  
Pulse para seleccionar TV o CABLE.

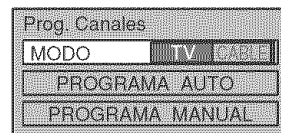

### Programación automática de canales

Explora y guarda automáticamente todos los canales de TV.

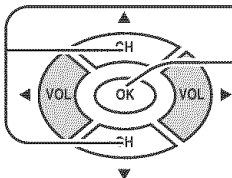
**5**  Pulse para seleccionar PROGRAMA AUTO.  
Púlselo para visualizar la pantalla PROGRAMA AUTO.

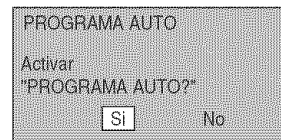

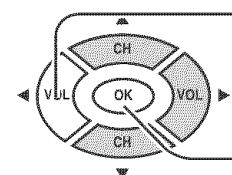
**6**  Púlselo para seleccionar Si.  
Púlselo para iniciar PROGRAMA AUTO.

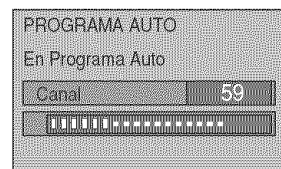

Los canales avanzarán automáticamente hasta que todos ellos hayan sido explorados. Los números de los canales con señal de vídeo recibida se guardarán en la memoria de canales.

#### Notas:

- Cuando se pulse cualquier botón durante PROGRAMA AUTO, el televisor volverá a mostrar la imagen normal. (Los canales encontrados hasta ese punto se añaden.)
- Después de terminar PROGRAMA AUTO se visualizará el número del canal más bajo añadido.
- Cuando no haya canales que puedan recibirse, se visualizará el canal 69 (para TV) o el canal 125 (para TV por cable).

## Operaciones con menús

### Programación manual de canales

Añada o borre un canal manualmente.

5

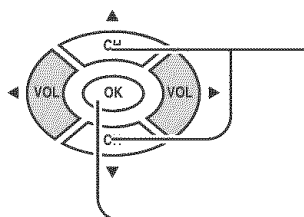

Pulse para seleccionar PROGRAMA MANUAL.



Pulse para visualizar la pantalla PROGRAMA MANUAL.

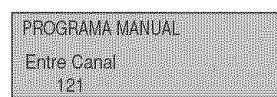

6

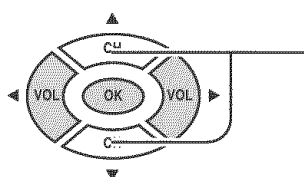

Pulse para seleccionar canal.  
• También puede utilizar los botones numerados.

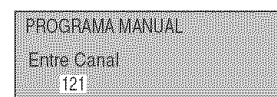

7

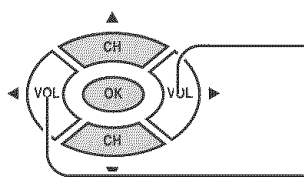

Púlselo para añadir el canal a la memoria de canales (el número del canal se pone de color azul).

Púlselo para borrar el canal de la memoria de canales (el número del canal se pone amarillo).  
• Repita los pasos 6 y 7 para otros canales.



# Photo Viewer

Photo Viewer le permite mostrar imágenes JPEG grabadas mediante una cámara digital en una tarjeta SD o en otro tipo de tarjeta de memoria cuando ésta se introduce en la ranura correcta.

## Mode de imagen miniatura

La pantalla de imagen miniatura es la pantalla de entrada inicial desde el menú principal.

- Cuando se introduzcan las tarjetas SD y PCMCIA, el televisor reproducirá la tarjeta SD. Para reproducir una tarjeta PCMCIA, seleccione "PC" en "Tarjeta" del Ajustes de Menú.

**1** Introduzca la tarjeta en la ranura apropiada (vea las página 24).

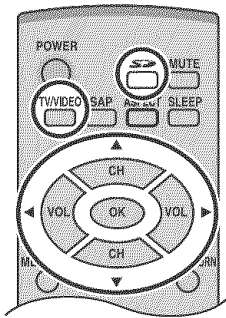

Presione para mostrar una pantalla de imagen miniatura.

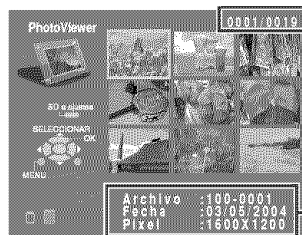

Número de imagen/Número total de imágenes

Nombre de archivo, la fecha y los píxeles (resolución) de la imagen

### Notas:

- Si hay muchos archivos o el tamaño del archivo es grande se puede tardar más tiempo en mostrar la imagen miniatura.
- La imagen desaparece de la pantalla mientras Photo Viewer accede a la información de la tarjeta. Después de acceder a las imágenes de la tarjeta se muestra una pantalla de imagen miniatura.

**2** Seleccione la imagen miniatura.

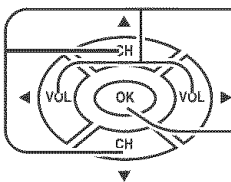

Presione para visualizar la imagen en el modo de visión de una sola imagen.

Modo de visión de una sola imagen

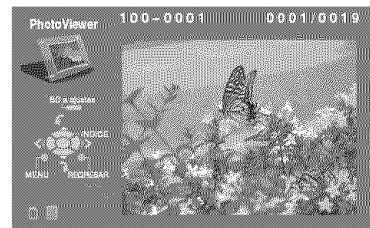

**3** Presione para seleccionar la imagen siguiente o la anterior.

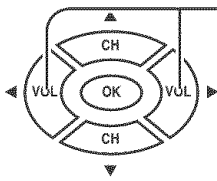

- Presione **CH ▲**, **CH ▼**, para girar la imagen noventa grados.
- Presione **OK** para volver a la pantalla de imagen miniatura.

### ■ Ajustes de Menú de Photo Viewer

En el modo de imagen miniatura o en el modo de visión de una sola imagen



Presione para mostrar la pantalla Ajustes de Menú.

Ajustes de Menú	Regresar
Dispositivos	Comenzar
Intervalo	5Seg
Secuencia	Orden
Repetir	Apagado
Rotar	Izquierda
Zoom	a Justo
Tarjeta	SD

















- Para salir de Photo Viewer :



Con esto se retorna a la visión normal.

# Troubleshooting

If there is a problem with your TV please refer to the table below to determine the symptoms, then carry out the suggested check. If this does not solve the problem, please contact your local Panasonic dealer, quoting the model number and serial number (both found on the rear of the TV).

Symptoms		Checks
Picture	Sound	
 Snowy Picture	 Noisy Sound	Antenna location, direction or connection.
 Multiple Image	 Normal Sound	Aerial location, direction or connection.
 Interference	 Noisy Sound	Electrical appliances Cars / Motorcycles Fluorescent lights
 Normal Picture	 No Sound	Volume level Sound mute switched on.
 No Picture	 No Sound	TV set to Video Input mode. Not plugged into AC outlet. Not switched on. Picture / Sound controls set at minimum levels. Check if in Standby mode.
 No Colour	 Normal Sound	Color controls set at minimum levels. Weak signal.
 Poor or Distorted Picture	 Weak or No Sound	Retune Channel (s).
 Normal Picture	 Weak or No Sound	Sound reception may have deteriorated. Switch STEREO mode to Off until reception improves.
Cannot operate with the remote control.		The battery is exhausted. The battery's polarity is wrong. The remote control sensor is exposed to strong light of a fluorescent lamp, etc.
The main unit is hot.		The main unit radiates heat and some of the parts may become hot. This is not a problem for performance or quality. Set up at a location with good ventilation. Do not cover the ventilation holes of the TV with a tablecloth etc., and do not place on top of other equipment.
There may be red spots, blue spots, green spots and black spots on the screen.		This is a characteristic of liquid crystal panels and is not a problem. The liquid crystal panel is built with very high precision technology giving you fine picture details. Occasionally, a few non-active pixels may appear on the screen as a fixed point of red, blue, green, or black. Please note this does not affect the performance of your LCD.

## ■ Photo Viewer

Cannot read the content of the card.	Not compatible format. Must be formatted with FAT 12 or FAT 16. The extension is not "JPG". The folders not under DCF standard.
PC card cannot be ejected.	Push the card all the way in, and eject.
Poor picture quality.	If the main image cannot be read (the file is partially corrupted), the Photo viewer will read the thumbnail. Please confirm the format of the image.
Picture takes a long time to display.	There are lots of images or the file size is large.

# Specifications

TC-20LB30	
<b>Power Source</b>	AC 120 V, 60 Hz
<b>Power Consumption</b>	Average use : 58 W Stand-by condition : 0.10 W Power off : 0.08 W
<b>LCD</b>	19.6-inch (499 mm) Diagonal 4:3 aspect ratio LCD panel VGA (640 × 480 pixels)
<b>Screen Size</b>	15.79 " (401 mm) (W) × 11.77 " (299 mm) (H)
<b>Channel Capability</b>	VHF-12 : UHF-56 : Cable-125
<b>Sound</b>	
<b>Speaker</b>	4 cm × 10 cm, 2 pcs, 16 Ω
<b>Audio Output</b>	6 W [3 W + 3 W] (10% THD)
<b>Headphones</b>	M3 (3.5 mm) Jack × 1
<b>FEATURES</b>	
	3D Y/C Digital Comb Filter, CLOSED CAPTION, V-Chip, SD/PC Card slot
<b>Operating Conditions</b>	Temperature : 41 °F - 95 °F (5 °C - 35 °C) Humidity : 5 % - 90 % RH (non-condensing)
<b>Connection Terminals</b>	
<b>INPUT</b>	VIDEO (RCA PIN Type × 1) × 2      1.0 Vp-p (75 Ω)
	S-VIDEO (MINI DIN 4pin × 1) × 2      Y : 1 Vp-p (75 Ω), C : 0.286 Vp-p (75 Ω)
	AUDIO L-R (RCA PIN Type × 2) × 2      0.5 Vrms
<b>COMPONENT VIDEO INPUT</b>	Y × 1      1.0 Vp-p (including synchronization)
	P <sub>B</sub> / P <sub>R</sub> × 1      ±0.35 Vp-p
	AUDIO L-R (RCA PIN Type × 2) × 1      0.5 Vrms
<b>Dimensions ( W × H × D )</b>	
<b>Including TV Stand</b>	24 3/4 " × 19 51/64 " × 10 15/64 " (629 mm × 503 mm × 260 mm)
<b>TV Set Only</b>	24 3/4 " × 16 29/64 " × 3 37/64 " (629 mm × 418 mm × 91 mm)
<b>Mass (Weight)</b>	20.7 lb. (9.4 kg) Net

**Note:** Design and specifications are subject to change without notice. Weight and dimensions shown are approximate.

# Maintenance

**To clean this unit, wipe with a soft, dry cloth.**

If the surfaces are extremely dirty, use a soft cloth dipped in a soap and water solution or a weak detergent solution.

- Use eyeglass cleaner to remove stubborn dirt from the LCD.
- Never use alcohol, paint thinner or benzine to clean this unit.
- Before using a chemically treated cloth, read the instructions that came with the cloth carefully.



## CAUTION :

If water or similar substances get inside the monitor via the liquid crystal panel surface, a malfunction may result.

**Customer's Record**

The model number and serial number of this product can be found on its rear panel. You should note this serial number in the space provided below and retain this book, plus your purchase receipt, as a permanent record of your purchase to aid in identification in the event of theft or loss, and for Warranty Service purposes.

Model Number \_\_\_\_\_

Serial Number \_\_\_\_\_

---

**Panasonic Consumer Electronics  
Company, Division of Matsushita  
Electric Corporation of America**  
One Panasonic Way Secaucus  
New Jersey 07094

**Panasonic Sales Company,  
Division of Matsushita Electric  
of Puerto Rico Inc. ("PSC")**  
Ave. 65 de Infanteria, Km 9.5  
San Gabriel Industrial Park,  
Carolina, Puerto Rico 00985

**Panasonic Canada Inc.**  
5770 Ambler Drive  
Mississauga, Ontario  
L4W 2T3