

SAMSUNG

**TX-R2028
TX-R2035
TX-R1635**

COLOR TELEVISION

**Owner's
Instructions**

CONTENTS

Chapter 1: Your New TV	4
List of Features	4
Accessories	4
Familiarizing Yourself with The TV	5
Front Panel Buttons	5
Side Panel Jacks	6
Rear Panel Jacks	7
Remote Control	8
Chapter 2: Installation	9
Connecting VHF and UHF Antennas	9
Antennas with 300-ohm Flat Twin Leads	9
Antennas with 75-ohm Round Leads	10
Separate VHF and UHF Antennas	10
Connecting Cable TV	10
Cable without a Cable Box	10
Connecting to a Cable Box that Descrambles All Channels	11
Connecting to a Cable Box that Descrambles Some Channels	11
Connecting a VCR	13
Connecting an S-VHS VCR	14
Connecting a Second VCR to Record from the TV	15
Connecting a DVD Player	15
Connecting a Camcorder	16
Installing Batteries in the Remote Control	17
Chapter 3: Operation	18
Turning the TV On and Off	18
Viewing the Menus and On-Screen Displays	18
Viewing the Menus	18
Viewing the Display	18
Selecting a Menu Language	19
Memorizing the Channels	20
Selecting the Video Signal-source	20
Storing Channels in Memory (Automatic Method)	21
Adding and Erasing Channels (Manual Method)	22
Changing Channels	23
Using the Channel Buttons	23
Directly Accessing Channels	23
Using the PRE-CH Button to select the Previous Channel	23
Channel Scan	23
Customizing the Picture	24
Using Automatic Picture Settings	25
Adjusting the Volume	26
Using Mute	26
Customizing the Sound	26
Using Automatic Sound Settings	27
Setting the Clock	28
Viewing a VCR or Camcorder Tape	29

CONTENTS

Chapter 4: Special Features 30

- Fine Tuning Channels 30
- Selecting the Color Tone 31
- Changing the Screen Size 32
- Using the Surf Feature 33
- Choosing a Multi-Channel Sound (MTS) Soundtrack 34
- Extra Sound Settings 35
- Setting the On/Off Timer 36
- Setting the Sleep Timer 37
- Viewing Closed Captions 38
- Using the V-Chip 39

Chapter 5: Troubleshooting 44

- Identifying Problems 44

Appendix 45

- Cleaning and Maintaining Your TV 45
- Using Your TV in Another Country 45
- Specifications 45

Chapter One

YOUR NEW TV

List of Features

Your TV was designed with the latest technology. This TV is a high-performance unit that includes the following special features:

- Easy-to-use remote control
- Easy-to-use on-screen menu system
- Automatic timer to turn the TV on and off
- Adjustable picture and sound settings that can be stored in the TV's memory
- Automatic channel tuning for up to 181 channels
- A special filter to reduce or eliminate reception problems
- Fine tuning control for the sharpest picture possible
- Built-in, dual channel speakers
- A special sleep timer
- Surround, Turbo sound, Auto Volume
- V-Chip function

Accessories

Once you have unpacked your TV, check to make sure that you have all the parts shown here. If any piece is missing or broken, call your dealer.

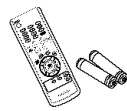

Remote Control
AAA Batteries

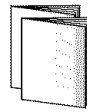

Owner's Instructions/
Safety Guide Manual

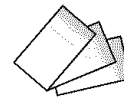

Warranty Card; 2EA/
Registration Card

YOUR NEW TV

Familiarizing Yourself with The TV

Front Panel Buttons

The buttons on the front panel control your TV's basic features, including the on-screen menu. To use the more advanced features, you must use the remote control.

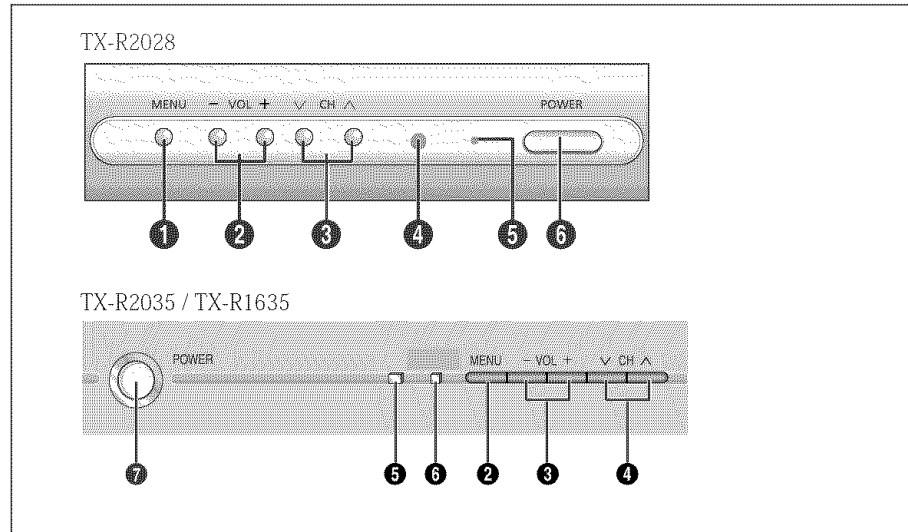

- ⌘ **MENU**
Press to see an on-screen menu of your TV's features.
- ⌘ **VOL - , +**
Press to increase or decrease the volume. Also used to select items on the on-screen menu.
- CH ▾ (▼) and CH ▲ (▲)**
Press to change channels. Also press to select various items on the on-screen menu.
- ⌘ **Remote Control Sensor**
Aim the remote control towards this spot on the TV.
- STAND BY indicator**
Lights up when you turn the power off.
- ⌘ **POWER**
Press to turn the TV on and off.

YOUR NEW TV

Side Panel Jacks

You can use the Side panel jacks to connect an A/V component that is used only occasionally, such as a camcorder or video game. (For information on connecting equipment, see page 16.)

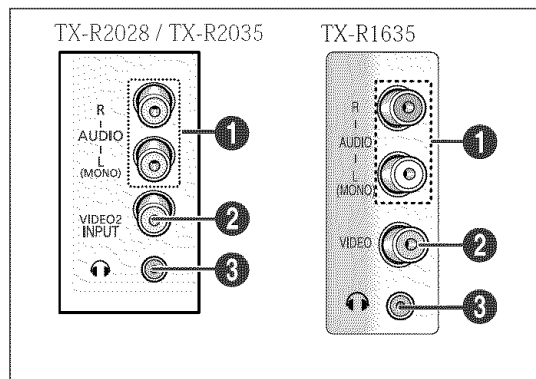

AUDIO INPUTS

Audio signals from VCRs, DVD players and similar devices.

HEADPHONE

Connect a set of external headphones to this jack for private listening.

VIDEO INPUT

Video signals from VCRs, DVD players and similar devices.

YOUR NEW TV

Rear Panel Jacks

Use the rear panel jacks to connect an A/V component that will be connected continuously, such as a VCR or a DVD player.

Because there are two sets of input jacks, you can connect two different A/V components (i.e., a VCR and a DVD, 2 VCRs, etc.)

For more information on connecting equipment, see pages 9-15.

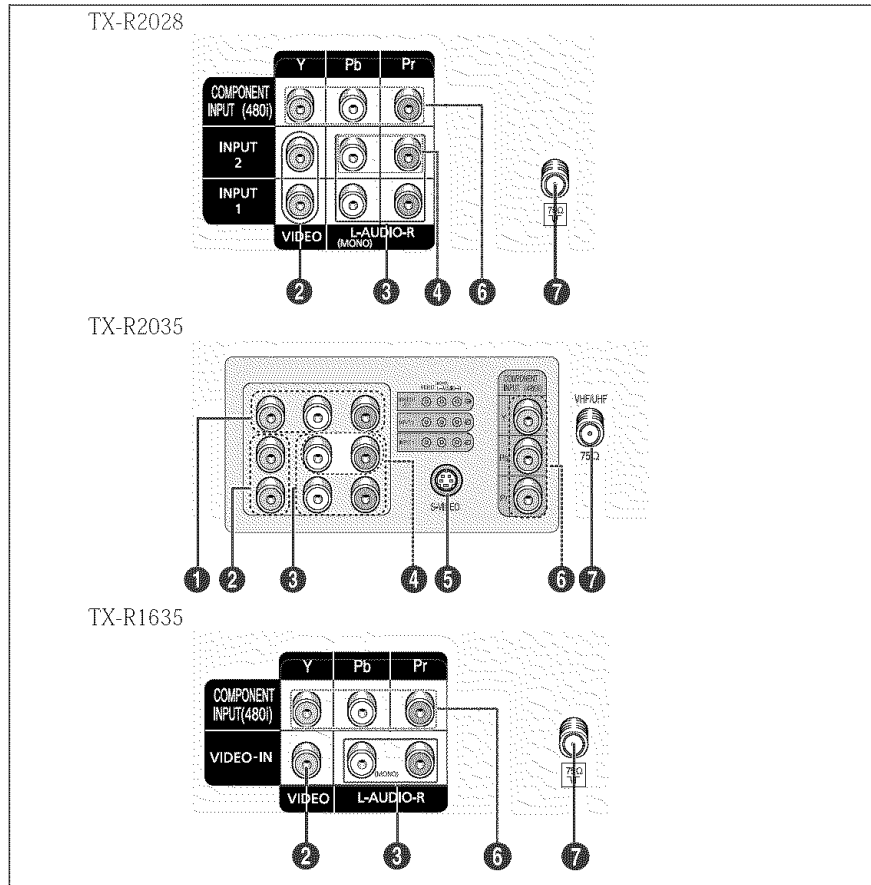

- ◀ **AUDIO-VIDEO MONITOR OUTPUTS**
These audio-video signals are identical to A/V signals being displayed on the big screen. (Typically used as the input signals for a recording VCR.)
- ◀ **VIDEO INPUT**
Video signals from VCRs, DVD players and similar devices.
- ◀ **AUDIO INPUTS**
Audio signals from VCRs, DVD players and similar devices.
- ◀ **DVD AUDIO INPUTS (INPUT 2)**
Use these jacks to connect the audio signals from a DVD player when using the DVD video input jacks. When not using the DVD jacks, these audio jacks function as audio for Video 2 or S-VIDEO.
- ◀ **S-VIDEO INPUT**
Connect to an S-VHS VCR or DVD player.
- ◀ **COMPONENT VIDEO INPUT**
Connect video from a DVD player.
Note: Monitor Output doesn't operate in the COMPONENT mode.
- ◀ **VHF/UHF**
Connect to an antenna or to a cable TV system.

YOUR NEW TV

Remote Control

You can use the remote control up to about 23 feet from the TV. When using the remote, always point it directly at the TV.

- ⌘ **POWER**
Turns the TV on and off.
- « **Number buttons**
Press to select channels directly on the TV.
- +100**
Press to select channels over 100. For example, to select channel 121, press "+100," then press "2" and "1."
- ⌘ **MUTE**
Press to temporarily cut off the sound.
- VOL -, VOL +**
Press to increase or decrease the volume.
- fi **SLEEP**
Press to select a preset time interval for automatic shutoff.
- ⌘ **MENU**
Displays the main on-screen menu.
- MTS (Multichannel Television Stereo)**
Press to choose stereo, mono or Separate Audio Program (SAP broadcast).
- TURBO**
Press to turn the TURBO sound On or Off.

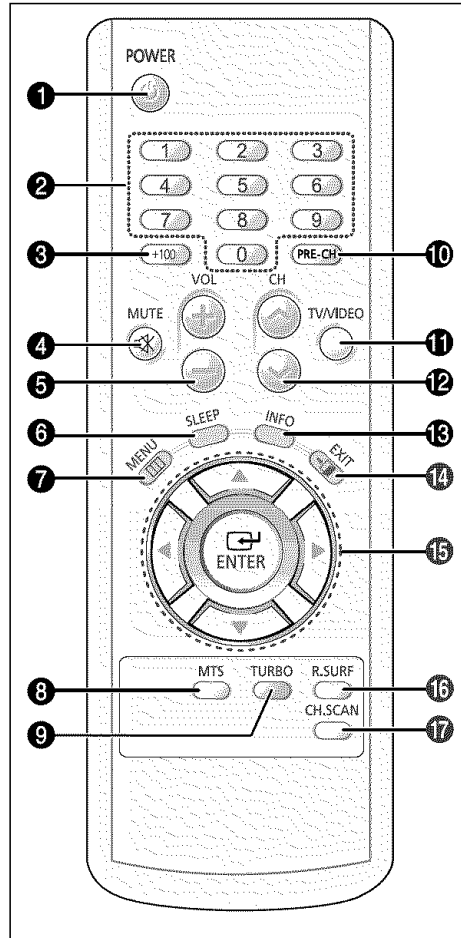

- PRE-CH**
Tunes to the previous channel.
- TV/VIDEO**
Press to display all of the available video sources (i.e., Antenna/Cable, VCR).
- CH ^ and CH v (Channel Up/Down)**
Press CH ^ or CH v to change channels.
- æ **INFO**
Press to see the time, channel, etc., on-screen.
- EXIT**
Press to exit the menu.
- fi **Up, Down, Left, Right (▲, ▼, ◀, ▶) / ENTER**
Press to select highlight up, down, left, or right. While using the on-screen menus, press the ENTER button to activate (or change) a particular item.
- 1 **R.SURF**
Press the SURF button to automatically return to a preferred channel after a user-preset time delay.
- CH.SCAN**
Press to have the TV automatically scan all of the channels it has memorized.

Chapter Two

INSTALLATION

Connecting VHF and UHF Antennas

If your antenna has a set of leads that look like this, see "Antennas with 300-ohm Flat Twin Leads" below.

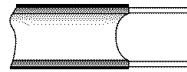

If your antenna has one lead that looks like this, see "Antennas with 75-ohm Round Leads" on next page.



If you have two antennas, see "Separate VHF and UHF Antennas" on next page.

Antennas with 300-ohm Flat Twin Leads

If you are using an off-air antenna (such as a roof antenna or "rabbit ears") that has 300-ohm twin flat leads, follow the directions below.

- 1** Place the wires from the twin leads under the screws on the 300-75 ohm adaptor (not supplied). Use a screwdriver to tighten the screws.

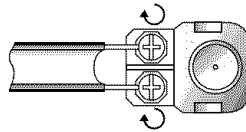

- 2** Plug the adaptor into the VHF/UHF terminal on the bottom of the back panel.

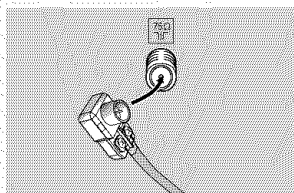

INSTALLATION

Antennas with 75-ohm Round Leads

- 1 Plug the antenna lead into the VHF/UHF terminal on the bottom of the back panel.

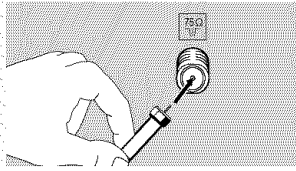

Separate VHF and UHF Antennas

If you have two separate antennas for your TV (one VHF and one UHF), you must combine the two antenna signals before connecting the antennas to the TV. This procedure requires an optional combiner-adaptor (available at most electronics shops).

- 1 Connect both antenna leads to the combiner.

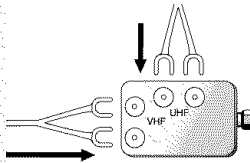

- 2 Plug the combiner into the VHF/UHF terminal on the bottom of the rear panel.

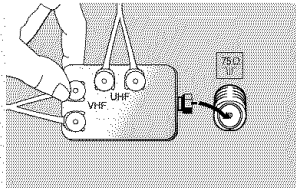

Connecting Cable TV

To connect to a cable TV system, follow the instructions below.

Cable without a Cable Box

- 1 Plug the incoming cable into the VHF/UHF antenna terminal on back of the TV.

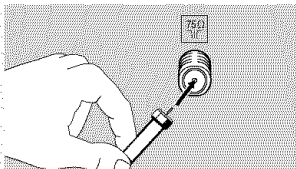

◀ Because this TV is cable-ready, you do not need a cable box to view unscrambled cable channels.

INSTALLATION

Connecting to a Cable Box that Descrambles All Channels

- 1 Find the cable that is connected to the ANTENNA OUT terminal on your cable box.

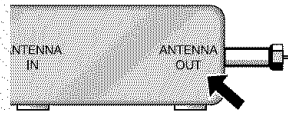

◀ This terminal might be labeled "ANT OUT", "VHF OUT" or simply, "OUT".

- 2 Connect the other end of this cable to the VHF/UHF antenna terminal on the back of the TV.

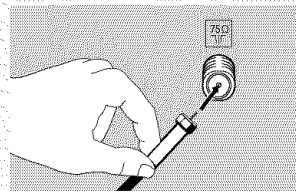

Connecting to a Cable Box that Descrambles Some Channels

If your cable box descrambles only some channels (such as premium channels), follow the instructions below. You will need a two-way splitter, an RF (A/B) switch, and four lengths of coaxial cable. (These items are available at most electronics stores.)

- 1 Find and disconnect the cable that is connected to the ANTENNA IN terminal on your cable box.

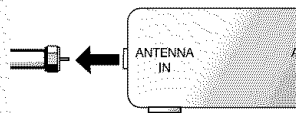

◀ This terminal might be labeled "ANT IN", "VHF IN" or simply, "IN".

- 2 Connect this cable to a two-way splitter.

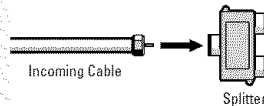

- 3 Connect a coaxial cable between an OUTPUT terminal on the splitter and the IN terminal on the cable box.

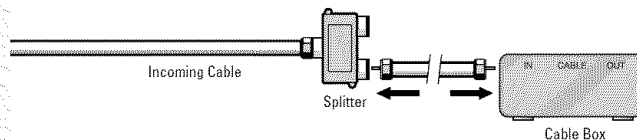

INSTALLATION

4

Connect a coaxial cable between the ANTENNA OUT terminal on the cable box and the B-IN terminal on the RF(A/B) switch.

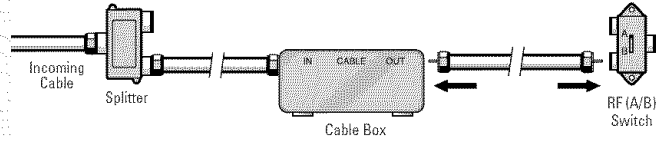

5

Connect another cable between the other OUT terminal on the splitter and the A-IN terminal on the RF (A/B) switch.

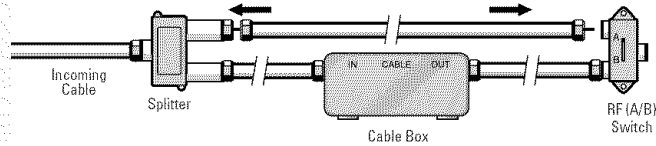

6

Connect the last coaxial cable between the OUT terminal on the RF (A/B) switch and the VHF/UHF terminal on the rear of the TV.

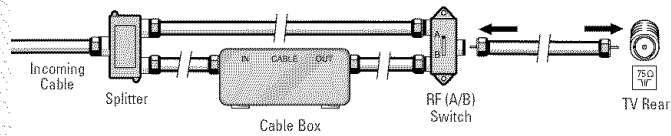

After you've made this connection, set the A/B switch to the "A" position for normal viewing. Set the A/B switch to the "B" position to view scrambled channels. (When you set the A/B switch to "B", you will need to tune your TV to the cable box's output channel, which is usually channel 3 or 4.)

INSTALLATION

Connecting a VCR

These instructions assume that you have already connected your TV to an antenna or a cable TV system (according to the instructions on pages 9-12). Skip step **1** if you have not yet connected to an antenna or a cable system.

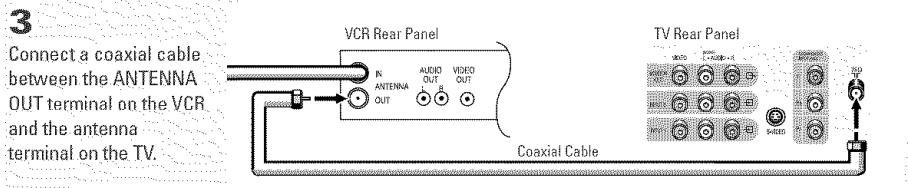
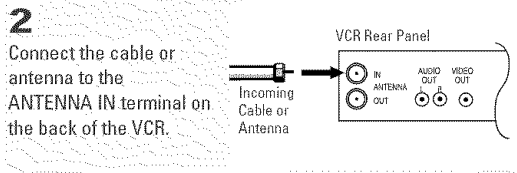
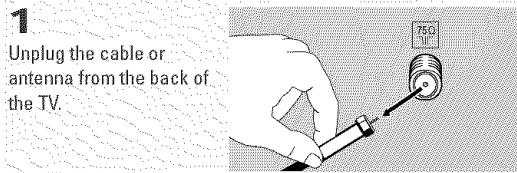

A coaxial cable is usually included with a VCR. (If not, check your local electronics store).

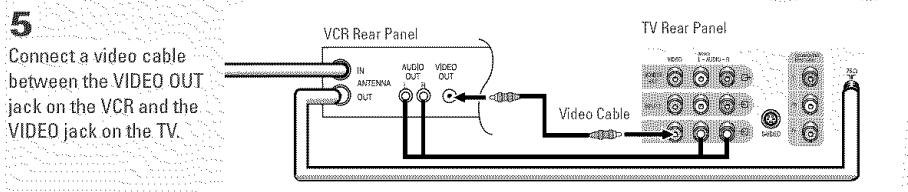
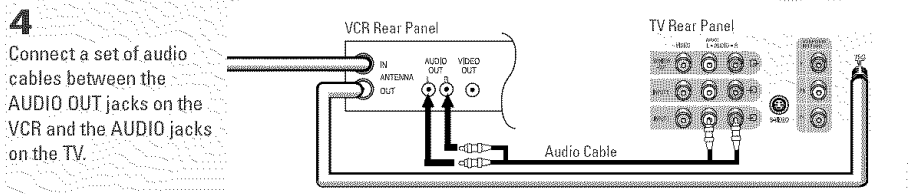

Follow the instructions in "Viewing a VCR or Camcorder Tape" to view your VCR tape.

Note: This figure shows the Standard connector-jack panel. The actual configuration for your TV may be different.

INSTALLATION

Connecting an S-VHS VCR (Depends on the model)

Your Samsung TV can be connected to an S-Video signal from an S-VHS VCR. (This connection delivers a better picture as compared to a standard VHS VCR.)

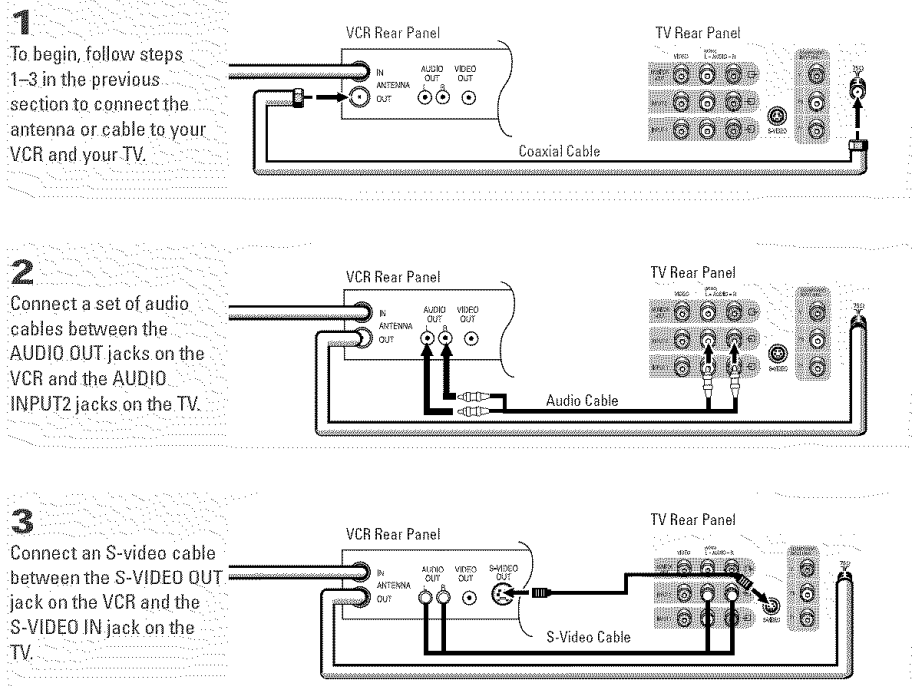

An S-video cable is usually included with an S-VHS VCR. (If not, check your local electronics store.)

Note: This figure shows the Standard connector-jack panel. The actual configuration for your TV may be different.

INSTALLATION

Connecting a Second VCR to Record from the TV (Depends on the model)

Your TV can send out signals of its picture and sound to be recorded by a second VCR. To do this, connect your second VCR as follows:

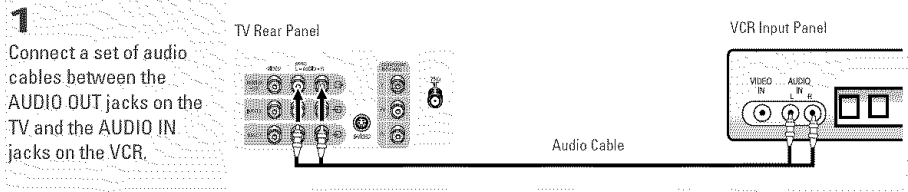

(The VCR input jacks might be either on the front or on back of the VCR.)

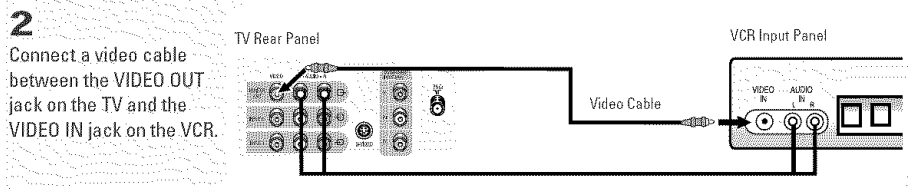

Refer to your VCR's instructions for more information about how to record using this kind of connection.

Note: This figure shows the Standard connector-jack panel. The actual configuration for your TV may be different.

Connecting a DVD Player

The rear panel jacks on your TV make it easy to connect a DVD player to your TV.

Note: Only 480i formats are supported.

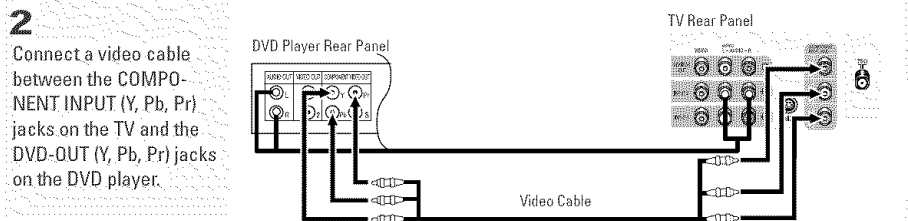
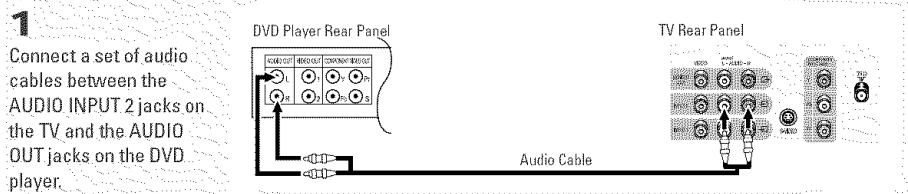

Note: For an explanation of Component video, see your DVD player's owner's manual.

INSTALLATION

Connecting a Camcorder

The side panel jacks on your TV make it easy to connect a camcorder to your TV. They allow you to view the camcorder tapes without using a VCR. (Also see "Viewing a VCR or Camcorder Tape" on page 29.)

1

Locate the A/V output jacks on the camcorder. They are usually found on the side or back of the camcorder.

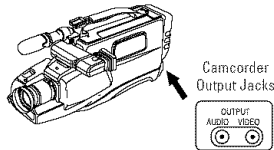

2

Connect an audio cable between the AUDIO OUTPUT jack on the camcorder and the AUDIO terminals on the side of the TV.

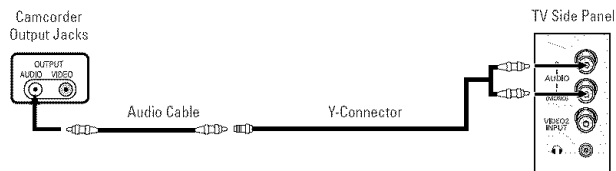

3

Connect a video cable between the VIDEO OUTPUT jack on the camcorder and the VIDEO terminal on the side of the TV.

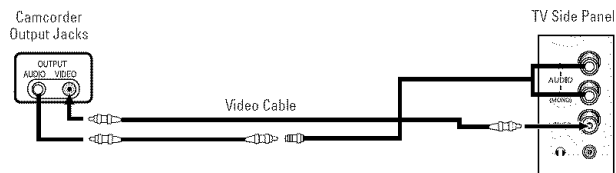

The audio-video cables shown here are usually included with a Camcorder. (If not, check your local electronics store.) If your camcorder is stereo, you need to connect a set of two cables.

Note: This figure shows the Standard connector-jack panel. The actual configuration for your TV may be different.

INSTALLATION

Installing Batteries in the Remote Control

1

Slide the cover out completely.

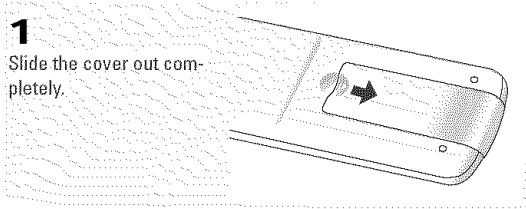

2

Install two AAA size batteries.

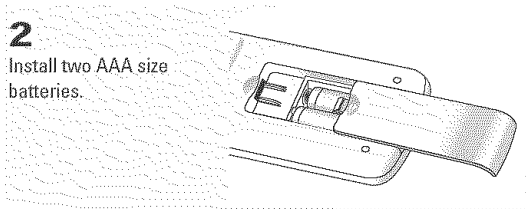

▲ Make sure to match the “+” and “-” ends of the batteries with the diagram inside the compartment.

3

Replace the cover.

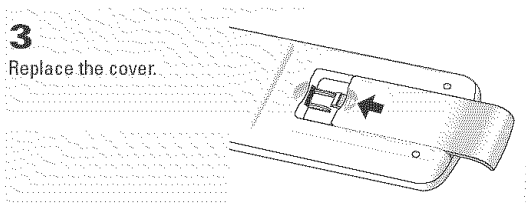

▲ Remove the batteries and store them in a cool, dry place if you won't be using the remote control for a long time.

The remote control can be used up to about 23 feet from the TV.

(Assuming typical TV usage, the batteries last for about one year.)

Note: This figure shows the Standard remote control. The actual configuration may be different.

Chapter Three

OPERATION

Turning the TV On and Off

Press the **POWER** button on the remote control.
You can also use the POWER button on the front panel.

Viewing the Menus and On-Screen Displays

Viewing the Menus

1

With the power on, press the **MENU** button.

The main menu appears on the screen. Its left side has four icons: Picture, Sound, Channel and Function.

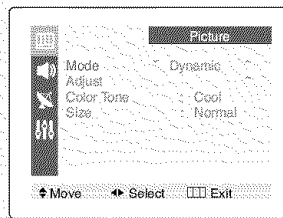

◀ The on-screen menus disappear from the screen after about two minutes.

2

Use the **▲** and **▼** buttons to highlight one of the 4 icons. Then press the **◀** button to access the icon's sub-menu. Press the **EXIT** button to exit.

◀ You can also use the MENU, CHANNEL and VOLUME buttons on the control panel of the TV to make selections.

Viewing the Display

1

Press the **INFO** button on the remote control.

The on-screen display shows any or all of the following: Active channel, picture mode, audio mode, audio source and the time. ("*" indicates a channel has been manually fine tuned.)

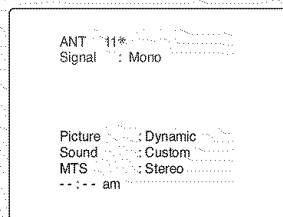

◀ The on-screen displays disappear after about ten seconds.

When Closed Caption has been set, the icon (CC) will appear by pressing the INFO button.

OPERATION

Selecting a Menu Language

1

Press the **MENU** button to display the menu.

Press the **▲** or **▼** button to select "Function", then press the **◀** or **▶** button.

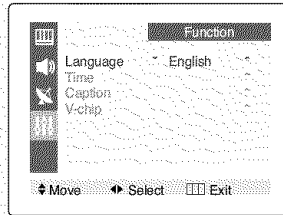

2

Press the **◀** or **▶** button to select the appropriate language: English, Spanish or French.

Press the **EXIT** button to exit.

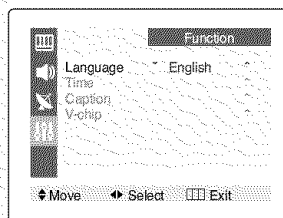

Memorizing the Channels

Your TV can memorize and store all of the available channels for both “off-air” (antenna) and cable channels. After the available channels are memorized, use the CH \wedge and CH \vee buttons to scan through the channels. This eliminates the need to change channels by entering the channel digits. There are three steps for memorizing channels: selecting a broadcast source, memorizing the channels (automatic) and adding and deleting channels (manual).

Selecting the Video Signal-source

Before your television can begin memorizing the available channels, you must specify the type of signal source that is connected to the TV (i.e., an antenna or a cable system).

1

Press the **MENU** button to display the menu.

Press the \blacktriangle or \blacktriangledown button to select “Channel”, then press the \vee or \wedge button.

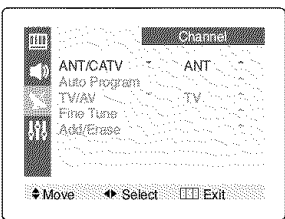

The screenshot shows a menu titled "Channel" with the following options: ANT/CATV (selected), Auto Program, TV/AV, Fine Tune, and Add/Erase. The selected option "ANT" is shown to the right of "ANT/CATV". At the bottom of the menu, there are three buttons: "Move" (left arrow), "Select" (right arrow), and "Exit" (square icon).

2

Repeatedly press the \vee or \wedge button to cycle through these choices:
ANT (antenna), STD, HRC or IRC (all cable TV).

Press the **EXIT** button to exit.

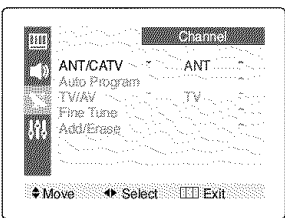

This screenshot is identical to the one in step 1, showing the "Channel" menu with "ANT/CATV" selected and "ANT" as the chosen signal source.

Note: STD, HRC and IRC identify various types of cable TV systems. Contact your local cable company to identify the type of cable system that exists in your particular area.

At this point the signal source has been selected. Proceed to “Storing Channels in Memory” (next page).

OPERATION

Storing Channels in Memory (Automatic Method)

1

First, select the correct signal source (ANT, STD, HRC, IRC). See steps 1~2 on previous page.

Press the **MENU** button, then press the ▲ or ▼ button to select "Channel" then press the ◀ or ▶ button.

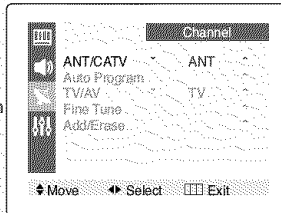

2

Press the ▲ or ▼ button to select "Auto program".

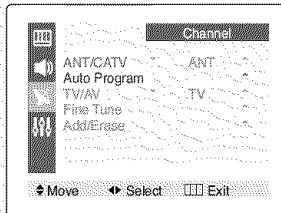

3

Press the ◀ or ▶ button. The TV will begin memorizing all of the available channels.

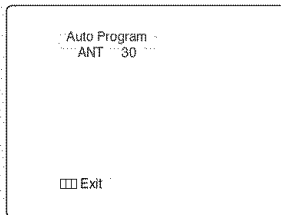

◀ The TV automatically cycles through all of the available channels and stores them in memory. This takes about one to two minutes.

Press the **MENU** button at any time to interrupt the memorization process and return to the Channel menu.

4

After all the available channels are stored, the Channel menu reappears. Press the **EXIT** button to exit.

OPERATION

Adding and Erasing Channels (Manual Method)

1
Press the **MENU** button to display the menu.

Press the **▲** or **▼** button to select "Channel", then press the **↵** or **↶** button.

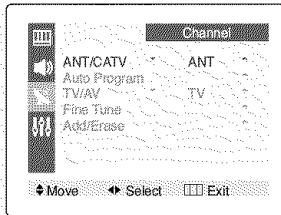

2
Press the **▲** or **▼** button to select "Add/Erase", then press the **↵** or **↶** button.

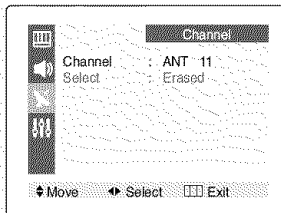

3
Press the **↵**, **↶**, or number buttons to select the channel you want added or erased.

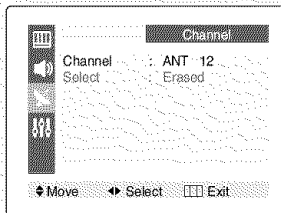

4
Press the **▲** or **▼** button to select "Select".

Press the **↵** or **↶** button to select "Added" or "Erased".

Press the **EXIT** button to exit.

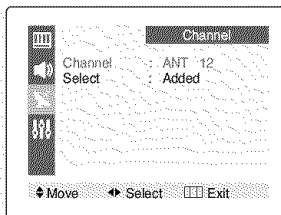

Changing Channels

Using the Channel Buttons

Press the **CH ^** or **CH v** button to change channels.

When you press **CH ^** or **CH v**, the TV changes channels in sequence. You will see all the channels that the TV has memorized. (The TV must have memorized at least three channels.) You will not see channels that were either erased or not memorized.

Directly Accessing Channels

Use the number buttons to quickly tune to any channel.

Press the number buttons to go directly to a channel.
For example, to select channel 27, press "2", then "7".
The TV will change channels when you press the second number.

When you use the number buttons, you can directly select channels that were either erased or not memorized.

To select a channel over 100, press the +100 button. (For channel 122, press "+100", then "2", then "2".)

To change to single-digit channels (0-9) faster, press "0" before the single digit. (For channel "4", press "0", then "4".)

Using the PRE-CH Button to select the Previous Channel

Press the **PRE-CH** button.
The TV will switch to the last channel viewed.

◀ To quickly switch between two channels that are far apart, tune to one channel, then use the number button to select the second channel. Then, use the **PRE-CH** button to quickly alternate between them.

Channel Scan (Depends on the model)

Press the **CH.SCAN** button.
The TV automatically scan all of the channels it has memorized.

Customizing the Picture

You can use the on-screen menus to change the contrast, brightness, sharpness, color, and tint according to personal preference. (Alternatively, you can use one of the “automatic” settings. See next page.)

1

Press the **MENU** button to display menu.

Press the \downarrow or \uparrow button to select “Picture”.

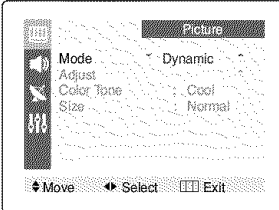

2

Press the \blacktriangle or \blacktriangledown button to select “Adjust”, then press the \downarrow or \uparrow button. (The words Contrast, Brightness, Sharpness, Color and Tint will appear on the screen.)

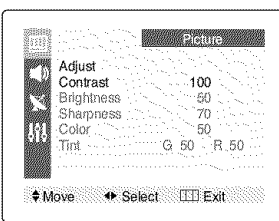

3

Press the \blacktriangle or \blacktriangledown button to select a particular item, then press the \downarrow or \uparrow button to increase or decrease the value of a particular item.

Press the **EXIT** button to exit.

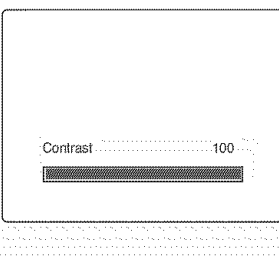

◀ After adjusting an item, the gauge will automatically disappear (after about 5 seconds).

Using Automatic Picture Settings

Your TV has three automatic picture settings (“Dynamic”, “Standard” and “Movie”) that are preset at the factory. You can activate either Dynamic, Standard or Movie by making a selection from the menu. Or, you can select “Custom” which automatically recalls your personalized picture settings.

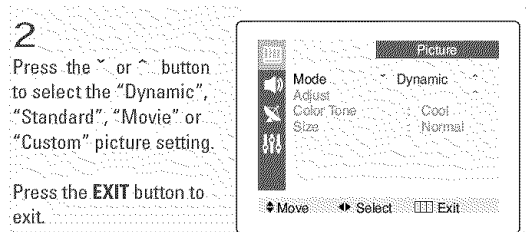
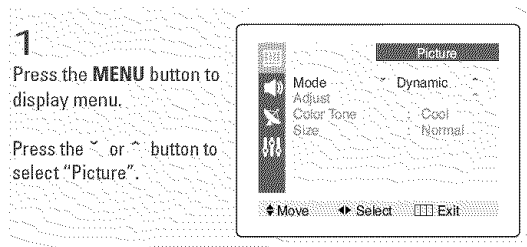

- Choose *Dynamic* for viewing the TV during the day or when there is brightlight in the room.
- Standard: Optimal indoor screen condition.
- Choose *Movie* when viewing the TV in low light, or when playing video games.
- Choose *Custom* if you want to adjust the settings according to personal preference (see “Customizing the Picture”, page 24).

Adjusting the Volume

Press the **VOL +** or **VOL-** button to increase or decrease the volume.

Using Mute

At any time, you can temporarily cut off the sound using the Mute button.

1

Press the **MUTE** button and the sound cuts off.
The word "Mute" will appear in the lower-left corner of the screen.

2

To turn mute off, press the **MUTE** button again, or simply press either the **VOL -** or **VOL +** button.

Customizing the Sound

You can use the on-screen menus to adjust the bass, treble, and balance according to individual preference. (Alternatively, you can use one of the "automatic" settings. See next page.)

1

Press the **MENU** button to display the menu.

Press the **▲** or **▼** button to select "Sound" menu, then press the **↵** or **⏏** button.

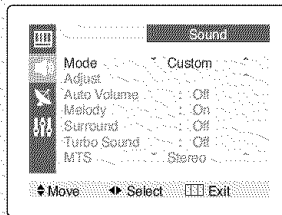

2

Press the **↵** or **⏏** button repeatedly, until the word "Custom" is selected. (When Custom is selected, the word "Adjust" will appear on the screen.)

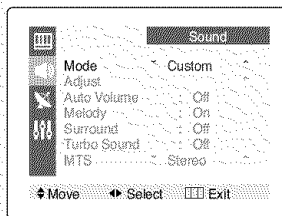

3

Press the **▲** or **▼** button to select "Adjust", then press the **↵** or **⏏** button. (The words Bass, Treble, and Balance will appear on the screen.)

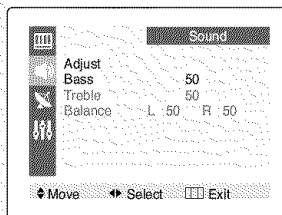

OPERATION

4

Press the ▲ or ▼ button to select a particular item to be changed.
Press the ◀ or ▶ button to increase or decrease the value of a particular item.

Press the EXIT button to exit.

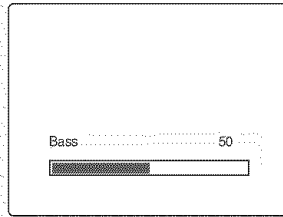

◀ After adjusting an item, the gauge will automatically disappear (after about 5 seconds).

Using Automatic Sound Settings

Your TV has four automatic sound settings (“Standard”, “Music”, “Movie” and “Speech”) that are preset at the factory. You can activate any of them by making a selection from the on-screen menu. Or, you can select “Custom”, which automatically recalls your personalized sound settings.

1

Press the MENU button to display the menu.

Press the ▲ or ▼ button to select “Sound” menu, then press the ◀ or ▶ button.

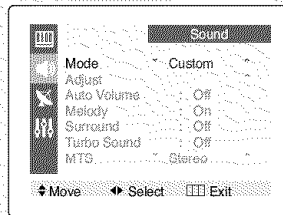

2

Press the ◀ or ▶ button repeatedly to select the “Standard”, “Music”, “Movie”, “Speech” or “Custom” sound settings.

Press the EXIT button to exit.

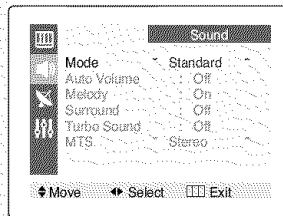

- Choose *Standard* for the standard factory settings.
- Choose *Music* when watching music videos or concerts.
- Choose *Movies* when watching movies.
- Choose *Speech* when watching a show that is mostly dialogue (i.e., news).
- Choose *Custom* to recall your personalized settings.

OPERATION

Setting the Clock

1
Press the **MENU** button to display the on-screen menu.

Press the **▲** or **▼** button to select "Function", then press the **↵** or **⏪** button.

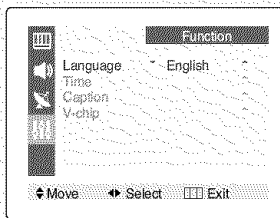

2
Press the **▲** or **▼** button to select "Time", then press the **↵** or **⏪** button. The Time menu will appear on the screen, and "Clock" will be selected.

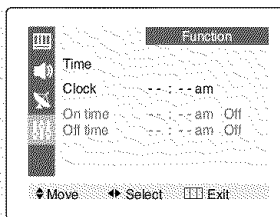

3
Press the **↵** or **⏪** button again (the hours digits will be selected). Press the **▲** or **▼** button repeatedly until the correct hour appears.

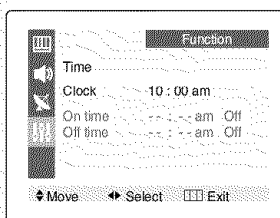

4
After the hour is entered, press the **↵** button. (at this point the minutes digits will be selected.) Press the **▲** or **▼** button to select the correct minutes.

Press the **EXIT** button to exit.

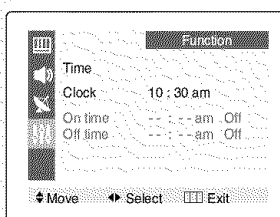

◀ When selecting the hours, be sure to select the proper time of day (AM or PM).

You can change the hours by pressing **▲** or **▼** repeatedly (or by holding down either of these buttons).

◀ The time will appear every time you press the **INFO** button.

OPERATION

Viewing a VCR or Camcorder Tape

You must select the appropriate mode in order to view the VCR or Camcorder signal on the TV.

1
Press the **MENU** button to display the menu.

Press the **▲** or **▼** button to select "Channel", then press the **◀** or **▶** button.

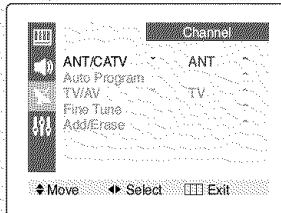

2
Press the **▲** or **▼** button to select the "TV/AV".

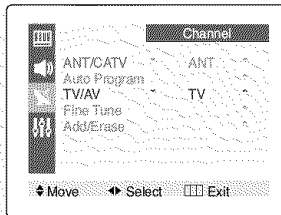

3
Press the **◀** or **▶** button. You will switch between viewing the signals coming from equipment connected to the TV's A/V jacks, and the TV signal.

Press the **EXIT** button to exit.

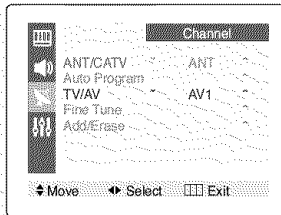

◀ AV1 and AV2 is available depending on the model.

Alternate method:
Simply press the **TV/VIDEO** button on the remote control to select an External Signal Source.

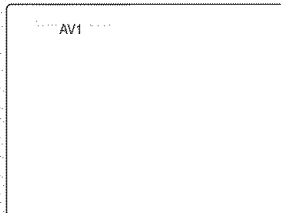

Chapter Four

SPECIAL FEATURES

Fine Tuning Channels

Use fine tuning to manually adjust a particular channel for optimal reception.

1
Press the **MENU** button to display the menu.

Press the **▲** or **▼** button to select "Channel", then press the **↵** or **⏪** button.

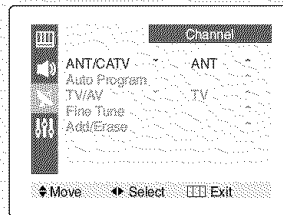

2
Press the **▲** or **▼** button to select "Fine tune", then press the **↵** or **⏪** button.

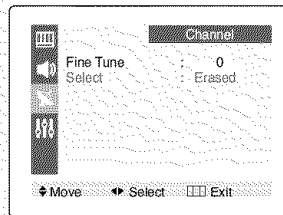

3
Press the **↵** and **⏪** buttons to adjust the fine tuning.

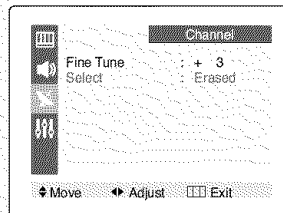

4
To store the fine tuning setting in the TV's memory, press the **▲** or **▼** button to select "Select". Press the **↵** or **⏪** button to select "Added"

To reset the fine tuning to "0", press the **↵** or **⏪** button to select "Erased"

Press the **EXIT** button to exit.

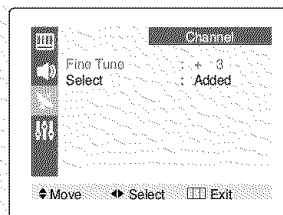

◀ After you adjust the fine tuning, "*" will appear when you press the INFO button while watching this channel.

SPECIAL FEATURES

Selecting the Color Tone

1

Press the **MENU** button to display menu.

Press the **↵** or **⏪** button to select "Picture".

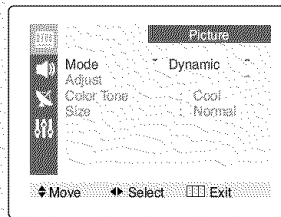

2

Press the **▲** or **▼** button to select "Color Tone".

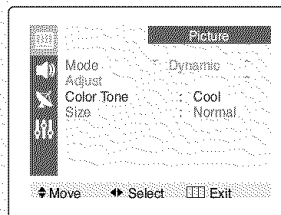

3

Press the **↵** or **⏪** button repeatedly to select "Cool", "Normal" or "Warm".

Press the **EXIT** button to exit.

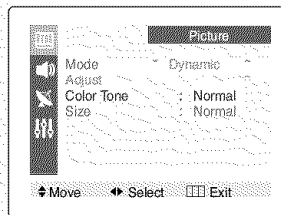

SPECIAL FEATURES

Changing the Screen Size

1
Press the **MENU** button to display menu.
Press the **◀** or **▶** button to select "Picture".

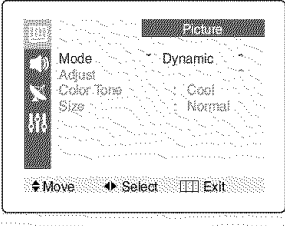

The screenshot shows a TV menu with the following options: Mode (Dynamic), Adjust (Cool), Color Tone (Normal), and Size. The 'Picture' menu item is highlighted at the top. At the bottom, there are three buttons: Move, Select, and Exit.

2
Press the **▲** or **▼** button to select "Size".

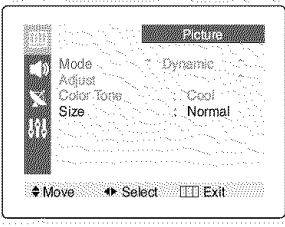

The screenshot shows the same TV menu as in step 1, but now the 'Size' option is highlighted. The other options remain the same.

3
Press the **◀** or **▶** button repeatedly to select "Normal" or "Zoom".
Press the **EXIT** button to exit.

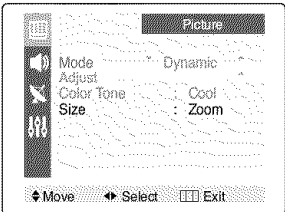

The screenshot shows the TV menu with 'Zoom' selected under the 'Size' category. The other options are the same as in the previous steps.

- Normal : Sets the picture to 4:3 normal mode. This is a standard TV screen size.
- Zoom : Magnifies the size of the picture on screen.

SPECIAL FEATURES

Using the Surf Feature

This feature allows you to set the TV to return to a particular channel after a certain amount of time. For example, you may be watching a channel when commercials start. You can set the Surf to "5 minutes", then switch channels. After 5 minutes, the TV will return to the original channel. To use the Surf:

1

While you are watching the channel to which you want to return, press the **R.SURF** button. The on-screen display will read "Surf Off".



Surf Off

2

Press the **R.SURF** button again to set the timer in thirty second intervals, up to five minutes.



Surf 1: 30

◀ The time will be decreasing while you are setting up the timer. And you will reset it when you pass five minutes or turn it off.

3

The time you set will begin counting down on the screen. When the time runs out, the TV will return to the channel you were watching when you set the timer.

Choosing a Multi-Channel Sound (MTS) Soundtrack

Depending on the particular program being broadcast, you can listen to stereo, mono or a Separate Audio Program. (SAP audio is usually a foreign-language translation. Sometimes SAP has unrelated information like news or weather.)

1
Press the **MENU** button to display the menu.

Press the **▲** or **▼** button to select "Sound" menu, then press the **◀** or **▶** button.

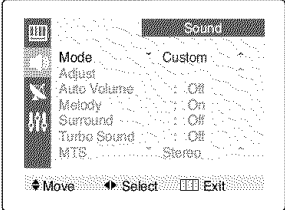

Sound	
Mode	Custom
Adjust	
Auto Volume	: Off
Melody	: On
Surround	: Off
Turbo Sound	: Off
MTS	Stereo

◀ Move ▶ Select Exit

2
Press the **▲** or **▼** button to select "MTS".

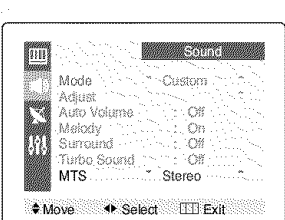

Sound	
Mode	Custom
Adjust	
Auto Volume	: Off
Melody	: On
Surround	: Off
Turbo Sound	: Off
MTS	Stereo

◀ Move ▶ Select Exit

3
Press the **◀** or **▶** button to select "Mono", "SAP" or "Stereo".

Press the **EXIT** button to exit.

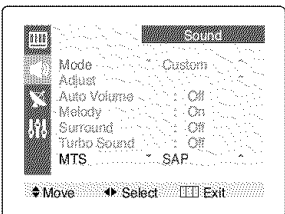

Sound	
Mode	Custom
Adjust	
Auto Volume	: Off
Melody	: On
Surround	: Off
Turbo Sound	: Off
MTS	SAP

◀ Move ▶ Select Exit

◀ The text at the bottom of the menu tells you if the incoming audio is Stereo, SAP or Mono.

Alternate method:
Simply press the **MTS** button on the remote control to change the MTS setting.

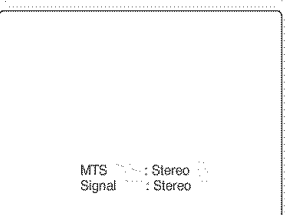

MTS	: Stereo
Signal	: Stereo

- Choose *Stereo* for channels that are broadcasting in stereo.
- Choose *Mono* for channels that are broadcasting in mono, or if you are having difficulty receiving a stereo signal.
- Choose *SAP* to listen to the Separate Audio Program, which is usually a foreign-language translation.

Extra Sound Settings

- **Auto Volume**
Each broadcasting station has its own signal conditions, and so it is not easy for you to adjust the volume every time the channel is changed. "Auto Volume" lets you automatically adjust the volume of the desired channel by lowering the sound output when the modulation signal is high or by raising the sound output when the modulation signal is low.
- **Melody**
You can set a melody to sound when the TV is powered On or Off.
- **Surround**
"Surround" converts a mono or stereo signal into simulated surround sound. Once the "Surround" is set to "On", the setting applies to sound effects such as Standard, Music, Movie and Speech.
- **Turbo Sound**
Turbo sound suitably emphasizes both higher and lower bands of sound (and includes other effects).

1
Press the **MENU** button to display the menu.

Press the **▲** or **▼** button to select "Sound" menu, then press the **◀** or **▶** button.

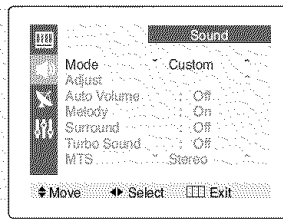

2
Press the **▲** or **▼** button to select required item you want.

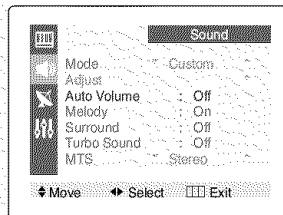

3
Press the **◀** or **▶** button to select "On" or "Off".

Press the **EXIT** button to exit.

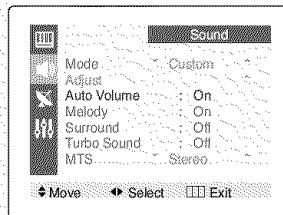

Alternate method (Turbo Sound):
Simply press the **TURBO** button on the remote control to change the turbo sound setting.

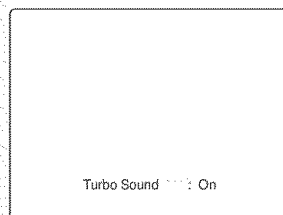

SPECIAL FEATURES

Setting the On/Off Timer

1

Press the **MENU** button to display the on-screen menu.

Press the **▲** or **▼** button to select "Function", then press the **◀** or **▶** button.

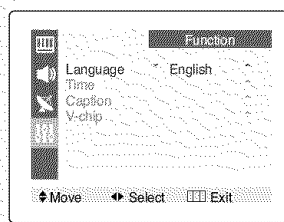

◀ Before using the timer, you must set the TV's clock. (See "Setting the Clock" on page 28).

2

Press the **▲** or **▼** button to select "Time" then press the **◀** or **▶** button. The Time menu will appear on the screen.

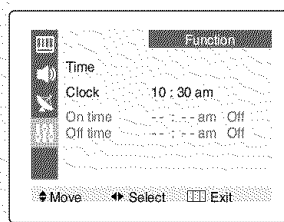

3

Press the **▲** or **▼** button to select "On time".

Press the **◀** or **▶** button to select the "On time" hours. (The hours digits will be highlighted.)

Press the **▲** or **▼** button repeatedly to select the appropriate hours (i.e., the hour when the TV will turn on.)

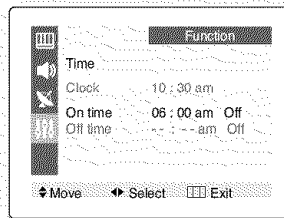

◀ When you set the hours, make sure the correct time of day (AM or PM) appears to the right of the hour.

4

Press the **◀** button to select the "On time" minutes. (The minutes digits will be highlighted.)

Press the **▲** or **▼** button to select the appropriate minutes.

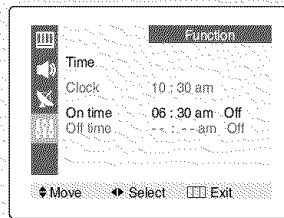

SPECIAL FEATURES

5

Press the **^** button to select "On/Off".

Press the **▲** or **▼** button to turn the On time "On". (Repeatedly pressing the **▲** or **▼** button will alternate between on and off.)

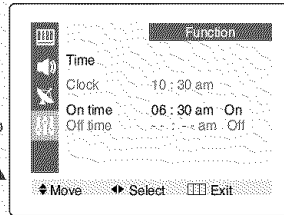

◀ To deactivate the "On time", select "Off" during this step.

6

When finished, press the **^** button.

7

To set the Off time, press the **▲** or **▼** button to select "Off time".

Press the **^** button and set the hours and minutes. (Follow the same procedure as in steps 3-6 above.)

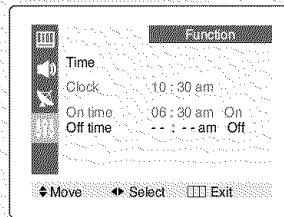

Press the **EXIT** button to exit.

Setting the Sleep Timer

The sleep timer automatically shuts off the TV after a preset time (from 10 to 180 minutes).

Press the **SLEEP** button repeatedly until the appropriate time interval appears (any of the preset values from "Off" to "180").

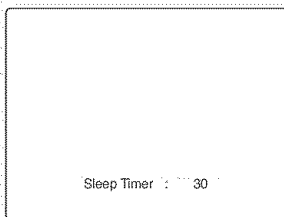

◀ After about 5 seconds, the sleep display will disappear from the screen, and the time interval will be set.

Viewing Closed Captions

Your TV decodes and displays the closed captions that are broadcast with certain TV shows. These captions are usually subtitles for the hearing impaired or foreign-language translations. All VCRs record the closed caption signal from television programs, so home-recorded video tapes also provide closed captions. Most pre-recorded commercial video tapes provide closed captions as well. Check for the closed caption symbol on your television schedule and on the tape's packaging: **CC**.

1
Press the **MENU** button to display the on-screen menu.

Press the **▲** or **▼** button to select "Function", then press the **◀** or **▶** button.

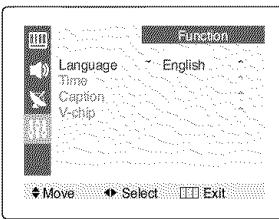

2
Press the **▲** or **▼** button to select the "Caption", then press the **◀** or **▶** button.

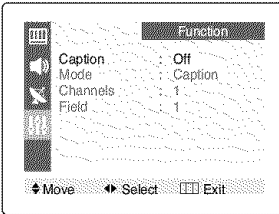

3
Press the **◀** or **▶** button to turn closed captioning On/Off.

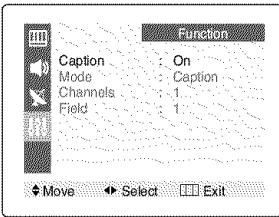

4
Press the **▲** or **▼** button to select "Mode".

Press the **◀** or **▶** button to select "Caption" or "Text".

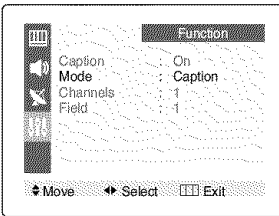

5
Depending on the particular broadcast, it might be necessary to make changes to "Channels" and "Field": Use the **▲**, **▼**, **◀** and **▶** buttons to make the changes. (Follow the same procedure as in steps 3-4 above.)

Press the **EXIT** button to exit.

◀ Misspellings and unusual characters sometimes occur during closed caption transmissions, especially those of live events. There may be a small delay before captions appear when you change channels. These are not malfunctions of the TV.

◀ In caption mode, captions appear at the bottom of the screen, and they usually cover only a small portion of the picture.

In text mode, information unrelated to the program, such as news or weather, is displayed. Text often covers a large portion of the screen.

◀ Different channels and fields display different information: Field 2 carries additional information that supplements the information in Field 1. (For example, Channel 1 may have subtitles in English, while Channel 2 has subtitles in Spanish.)

Using the V-Chip

The V-Chip feature automatically locks out programming that is deemed inappropriate for children. The user must first enter a PIN (personal ID number) before any of the V-Chip restrictions can be set up or changed.

Setting Up Your Personal ID Number (PIN)

1
Press the **MENU** button to display the menu.

Press the **▲** or **▼** button to select the "Function" menu, then press the **↵** or **⏏** button.

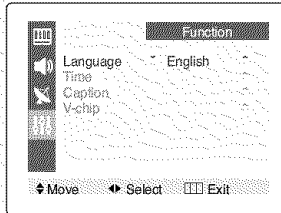

2
Press the **▲** or **▼** button to select the "V-chip", then press the **↵** or **⏏** button.

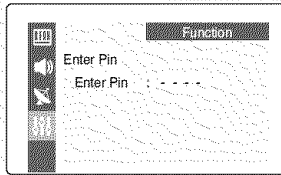

The "Enter Pin" screen will appear. Enter your 4-digit PIN number. Note: The default PIN number for a new TV set is "0-0-0-0."

3
After entering a valid PIN number, the "V-chip" screen will appear. Press the **▲** or **▼** button and highlight "Change pin."

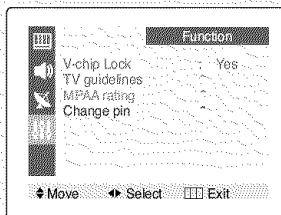

4
While the "Change pin" field is selected, press the **↵** or **⏏** button.

The Change pin screen will appear. Choose any 4-digits for your PIN and enter them.

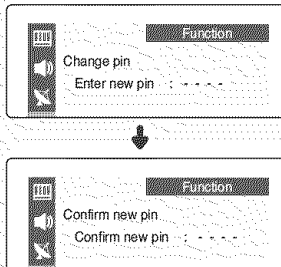

As soon as the 4 digits are entered, the "Confirm new pin" screen appears. Re-enter the same 4 digits. When the Confirm screen disappears, your PIN has been memorized.

Press the **EXIT** button to exit.

◀ Note: If you forget the PIN, press the remote-control keys in the following sequence, which resets the pin to 0-0-0-0:

POWER OFF → MUTE → 8 → 2 → 4 → POWER ON.

SPECIAL FEATURES

How to Enable/Disable the V-Chip

1

Press the **MENU** button to display the menu.

Press the **▲** or **▼** button to select the "Function" menu, then press the **↵** or **⏏** button.

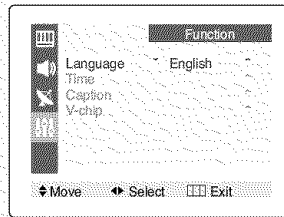

2

Press the **▲** or **▼** button to select the "V-chip", then press the **↵** or **⏏** button.

The "Enter Pin" screen will appear. Enter your 4-digit PIN number.

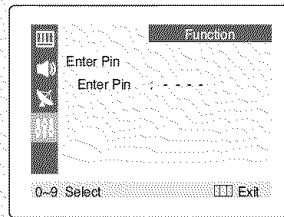

3

The "V-chip" screen will appear, and "V-chip Lock" will be selected.

To enable the V-chip feature, press the **↵** button so that the "V-chip Lock" field is Yes. (Pressing **↵** will alternate between Yes and No.)

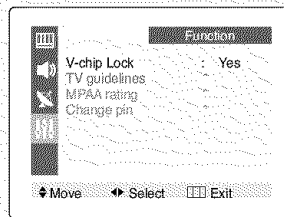

How to Set up Restrictions Using the "TV guidelines"

First, set up a personal identification number (PIN), and enable the V-chip. (See previous section.) Parental restrictions can be set up using either of two methods: The TV guidelines or the MPAA rating.

1

Press the **MENU** button to display the menu.

Press the **▲** or **▼** button to select the "Function" menu, then press the **↵** or **⏏** button.

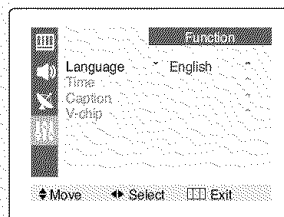

SPECIAL FEATURES

2
Press the ▲ or ▼ button to select the “V-chip”, then press the ◀ or ▶ button.

The “Enter Pin” screen will appear. Enter your 4-digit PIN number.

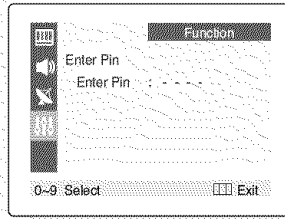

3
The “V-chip” screen will appear. Press the ▲ or ▼ button, and highlight the field for “TV guidelines”.

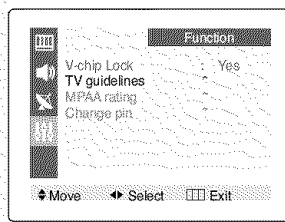

4
Press the ◀ or ▶ button. The “TV guidelines” screen will appear. Press the ▲ or ▼ button to highlight one of the six age-based categories:

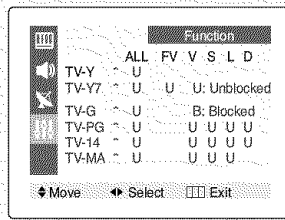

- TV-Y Young children
- TV-Y7 Children 7 and over
- TV-G General audience
- TV-PG Parental guidance
- TV-14 Viewers 14 and over
- TV-MA Mature audience

◀ Note: These categories consist of two separate groups: TV-Y and TV-Y7 (young children through age 7), and TV-G through TV-MA (everybody else).

The restrictions for these two groups work independently: If a household includes very young children as well as young adults, the TV guidelines must be set up separately for each age group. (See next step.)

5
At this point, one of the TV-Ratings is highlighted.

Press the ◀ or ▶ button: Depending on your existing setup, a letter “U” or “B” will be selected. (U= Unblocked, B= Blocked)

While the “U” or “B” is red, press the ▲ or ▼ button to block or unblock the category.

Press the **MENU** button once to save the TV guidelines. A TV-Rating will be highlighted, and no letters will be selected. To exit this screen, press the **MENU** button again. To select a different TV-Rating, press the ▲ or ▼ button and then repeat the process.

Note 1: The TV-Y7, TV-PG, TV-14 and TV-MA have additional options. See the next step to change any of the following sub-ratings:

- FV: Fantasy violence
- D: Dialog
- L: Offensive language
- S: Sexual situation
- V: Violence

Note 2: The V-Chip will automatically block certain categories that are “more restrictive.” For example, if you block “TV-Y” category, then “TV-Y7” will automatically be blocked. Similarly, if you block the TV-G category, then all the categories in the “young adult” group will be blocked (TV-G, TV-PG, TV-14 and TV-MA). The sub-ratings (D, L, S, V) work together similarly. (See next section.)

SPECIAL FEATURES

6

How to set the FV, V, S, L and D sub-ratings:

First, highlight one of these TV-Ratings: TV-Y7, TV-PG, TV-14 or TV-MA (See Step 4, on previous page).

Next, while the TV-Rating is highlighted, repeatedly press the \wedge button. This will cycle through the available sub-ratings (FV, L, S, D or V).

A red letter ("U" or "B") will be displayed for each sub-rating. While the "U" or "B" is red, press the \blacktriangle or \blacktriangledown button to change the sub-rating.

Press the **MENU** button once to save the TV guidelines. A TV-Rating will be highlighted, and no letters will be selected. To exit this screen, press MENU again. To select a different TV-Rating, press the \blacktriangle or \blacktriangledown button and then repeat the process.

Note: The V-chip will automatically block certain categories that are "More restrictive". For example, if you block "L" sub-rating in TV-PG, then the "L" sub-ratings in TV-14 and TV-MA will automatically be blocked.

7

Press the **EXIT** button to clear all the screens (Or proceed to the next section, and set up additional restrictions based on the MPAA codes).

How to Set up Restrictions Using the MPAA Ratings: G, PG, PG-13, R, NC-17, X, NR

The MPAA rating system uses the Motion Picture Association of America (MPAA) system, and its main application is for movies. (Eventually, movie videocassettes will be encoded with MPAA ratings.) When the V-chip Lock is on, the TV will automatically block any programs that are coded with objectionable ratings (either MPAA or TV-Ratings).

1

Press the **MENU** button to display the menu.

Press the \blacktriangle or \blacktriangledown button to select the "Function" menu, then press the \wedge or \wedge button.

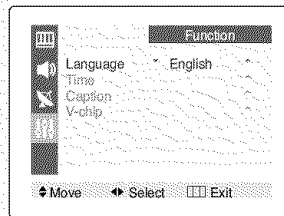

2

Press the \blacktriangle or \blacktriangledown button to select the "V-chip", then press the \wedge or \wedge button.

The "Enter Pin" screen will appear. Enter your 4-digit PIN number.

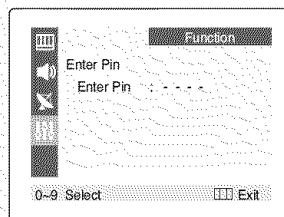

SPECIAL FEATURES

3
The “V-chip” screen will appear. Press the ▲ or ▼ button, and select “MPAA rating”.

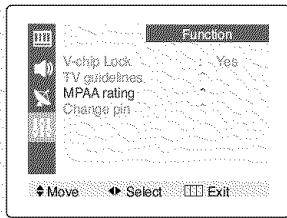

4
While “MPAA rating” is selected, press the ~ or ^ button. The “MPAA rating” screen will appear.

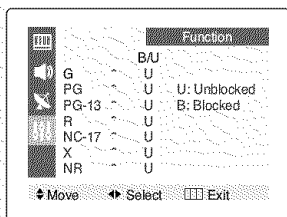

5
Repeatedly press the ▲ or ▼ button to select a particular MPAA category. Pressing the ▲ or ▼ button will cycle through the MPAA categories:

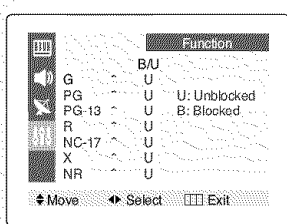

G	General audience (no restrictions).
PG	Parental guidance suggested.
PG-13	Parents strongly cautioned.
R	Restricted. Children under 17 should be accompanied by an adult.
NC-17	No children under age 17.
X	Adults only.
NR	Not rated.

While a particular category is selected, press ^ to activate it. A letter (“U” or “B”) will be displayed. Press ▲ or ▼ to select “U” or “B”.

Press the EXIT button to save the settings and to clear all screens.

Note: The V-Chip will automatically block any category that is “more restrictive.” For example, if you block the “PG-13” category, then “R,” “NC-17,” and “X” will automatically be blocked also.

How to Reset the TV after the V-Chip Blocks a Channel (“Emergency Escape”)

If the TV is tuned to a restricted channel, the V-Chip will block it. The screen will go black and the following message will appear: “Excessive rating”.

To resume normal viewing, tune to a different channel using the number buttons. Under certain conditions (depending on the rating of the local TV programs) the V-Chip might lock out all the channels. In this case, use the V-Chip function for an “emergency escape”:

Press the **MENU** button to display the menu. Press the ▲ or ▼ button three times to select the “Function” menu and press the ~ or ^ button.

Press the ▲ or ▼ button to highlight the “V-chip” menu and press the ~ or ^ button.

Enter your PIN number, and press the ^ button to temporarily disable the V-chip Lock.

Chapter Five

TROUBLESHOOTING

If the TV seems to have a problem, first try this list of possible problems and solutions. If none of these troubleshooting tips apply, then call your nearest service center.

Identifying Problems

Problem	Possible Solution
Poor picture	Try another channel. Adjust the antenna. Check all wire connections.
Poor sound quality.	Try another channel. Adjust the antenna.
No picture or sound.	Try another channel. Press the TV/VIDEO button. Make sure the TV is plugged in. Check the antenna connections.
No color, wrong colors or tints.	Make sure the program is broadcast in color. Adjust the picture settings. If the set is moved or turned in a different direction, the power should be OFF for at least 30 minutes.
Picture rolls vertically.	Adjust the antenna. Check all wire connections.
The TV operates erratically	Unplug the TV for 30 seconds, then try operating it again.
The TV won't turn on.	Make sure the wall outlet is working.

APPENDIX

Cleaning and Maintaining Your TV

With proper care, your TV unit will give you many years of service. Please follow these guidelines to get the maximum performance from your TV.

Placement

- Do not place the TV near extremely hot, cold, humid or dusty places.
- Do not place the TV near appliances with electric motors that create magnetic fields, such as vacuum cleaners.
- Keep the ventilation openings clear; do not place the TV on a soft surface, such as cloth or paper.
- Place the TV in a vertical position only.

Liquids

- Do not handle liquids near or on the TV. Liquids that spill into it can cause serious damage.

Cabinet

- Never open the cabinet or touch the parts inside.
- Wipe your TV with a clean, dry cloth. Never use water, cleaning fluids, wax, or chemicals.
- Do not put heavy objects on top of the cabinet.

Temperature

- If your TV is suddenly moved from a cold to a warm place, unplug the power cord, and allow at least two hours for moisture that may have formed inside the unit to dry completely.

Using Your TV in Another Country

If you plan to take your TV with you to a foreign country, please be aware of the different television systems that are in use around the world. A TV designed for one system may not work properly with another system due to differences in the TV channel frequencies.

Specifications

Model	TX-R2028 / TX-R2035 / TX-R1635
Voltage	AC 120V
Frequency of Operation	60Hz
Dimensions (mm/inches)	TX-R2028: 590 x 492 x 464 / 23.22 x 19.37 x 18.27
	TX-R2035: 582 x 481 x 456 / 22.91 x 18.93 x 17.95
	TX-R1635: 572 x 497 x 470 / 22.52 x 19.57 x 18.50
Weight (Kg/ lbs)	TX-R2028: 22.5 / 49.60
	TX-R2035: 24.0 / 52.91
	TX-R1635: 16.6 / 36.6

MEMO

MEMO



ELECTRONICS

1-800-SAMSUNG (1-800-726-7864)

**Samsung Electronics America
Service Division**

400 Valley Road, Suite 201
Mount Arlington, NJ 07856
www.samsung.com

**Samsung Electronics Canada Inc.
Samsung Customer Care**

7037 Financial Drive
Mississauga, Ontario
L5N 6R3
www.samsung.ca

Printed in Mexico
AA68-03591A (ENG)