

## DVD Recorder

Operating Instructions

RDR-GX315

### For customers in the U.S.A

#### Owner's Record

The model and serial numbers are located at the rear of the unit. Record the serial number in the space provided below. Refer to them whenever you call upon your Sony dealer regarding this product.  
Model No. RDR-GX315  
Serial No. \_\_\_\_\_

### For customers in Canada

If this product is not working properly, please call 1-877-602-2008 for **Peace of Mind Warranty Replacement service**. For other product related questions please contact our **Customer Information Service Centre** at 1-877-899-7669 or write to us at: Customer Information Service 115 Gordon Baker Road, Toronto, Ontario, M2H 3R6



## WARNING

To reduce the risk of fire or electric shock, do not expose this apparatus to rain or moisture.

To avoid electrical shock, do not open the cabinet. Refer servicing to qualified personnel only. The AC power cord must be changed only at a qualified service shop only.



This appliance is classified as a CLASS 1 LASER product. The CLASS 1 LASER PRODUCT MARKING is located on the rear exterior.

## CAUTION

The use of optical instruments with this product will increase eye hazard. As the laser beam used in this DVD recorder is harmful to eyes, do not attempt to disassemble the cabinet. Refer servicing to qualified personnel only.



This symbol is intended to alert the user to the presence of uninsulated "dangerous voltage" within the product's enclosure that may be of sufficient magnitude to constitute a risk of electric shock to persons.



This symbol is intended to alert the user to the presence of important operating and maintenance (servicing) instructions in the literature accompanying the appliance.

## CAUTION

TO PREVENT ELECTRIC SHOCK, MATCH WIDE BLADE OF PLUG TO WIDE SLOT, FULLY INSERT.

## CAUTION

You are cautioned that any change or modifications not expressly approved in this manual could void your authority to operate this equipment.

## Note

This equipment has been tested and found to comply with the limits for a Class B digital device, pursuant to Part 15 of the FCC Rules. These limits are designed to provide reasonable protection against harmful interference in a residential installation. This equipment generates, uses, and can radiate radio frequency energy and, if not installed and used in accordance with the instructions, may cause harmful interference to radio communications. However, there is no guarantee that interference will not occur in a particular installation. If this equipment does cause harmful interference to radio or television reception, which can be determined by turning the equipment off and on, the user is encouraged to try to correct the interference by one or more of the following measures:

- Reorient or relocate the receiving antenna.
- Increase the separation between the equipment and receiver.
- Connect the equipment into an outlet on a circuit different from that to which the receiver is connected.
- Consult the dealer or an experienced radio/TV technician for help.

## Precautions

### On safety

Should any solid object or liquid fall into the cabinet, unplug the recorder and have it checked by qualified personnel before operating it any further.

### On power sources

- Operate the recorder only on 120 V AC, 60 Hz.
- The recorder is not disconnected from the AC power source as long as it is connected to the wall outlet, even if the recorder itself has been turned off.
- If you are not going to use the recorder for a long time, be sure to disconnect the recorder from the wall outlet. To disconnect the AC power cord, grasp the plug itself; never pull the cord.

### On placement

- Place the recorder in a location with adequate ventilation to prevent heat build-up in the recorder.
- If the recorder is brought directly from a cold to a warm location, or is placed in a very damp room, moisture may condense on the lenses inside the recorder. Should this occur, the recorder may not operate properly. In this case, remove the disc and leave the recorder turned on for about half an hour until the moisture evaporates.
- Do not place the recorder on a soft surface such as a rug that might block the ventilation holes.
- Do not place the recorder in a confined space such as a bookshelf or similar unit.
- Do not place the recorder in a location near heat sources, or in a place subject to direct sunlight, excessive dust, or mechanical shock.
- Do not place the recorder in an inclined position. It is designed to be operated in a horizontal position only.

- Keep the recorder and discs away from equipment with strong magnets, such as microwave ovens, or large loudspeakers.
- Do not place heavy objects on the recorder.
- To prevent fire or shock hazard, do not place objects filled with liquids, such as vases, on the apparatus.
- When you move the recorder, take out any discs. If you do not, the disc may be damaged.

### On recording

- Contents of the recording cannot be compensated for if the recording or playback is not made due to a malfunction of the recorder, disc, etc.
- Make trial recordings before making the actual recording.

### Copyrights

- Television programs, films, video tapes, discs, and other materials may be copyrighted. Unauthorized recording of such material may be contrary to the provisions of the copyright laws. Also, use of this recorder with cable television transmission may require authorization from the cable television transmitter and/or program owner.
- This product incorporates copyright protection technology that is protected by U.S. patents and other intellectual property rights. Use of this copyright protection technology must be authorized by Macrovision, and is intended for home and other limited viewing uses only unless otherwise authorized by Macrovision. Reverse engineering or disassembly is prohibited.

### Copy guard function

Since the recorder has a copy guard function, programs received through an external tuner (not supplied) may contain copy protection signals (copy guard function) and as such may not be recordable, depending on the type of signal.

### IMPORTANT NOTICE

Caution: This recorder is capable of holding a still video image or on-screen display image on your television screen indefinitely. If you leave the still video image or on-screen display image displayed on your TV for an extended period of time you risk permanent damage to your television screen. Plasma display panels and projection televisions are especially susceptible to this.

If you have any questions or problems concerning your recorder, please consult your nearest Sony dealer.

### IMPORTANT SAFETY INSTRUCTIONS

- 1 Read these instructions.
- 2 Keep these instructions.
- 3 Heed all warnings.
- 4 Follow all instructions.
- 5 Do not use this apparatus near water.
- 6 Clean only with dry cloth.
- 7 Do not block any ventilation openings. Install in accordance with the manufacturer's instructions.
- 8 Do not install near any heat sources such as radiators, heat registers, stoves, or other apparatus (including amplifiers) that produce heat.
- 9 Do not defeat the safety purpose of the polarized or grounding-type plug. A polarized plug has two blades with one wider than the other. A grounding type plug has two blades and a third grounding prong. The wide blade or the third prong are provided for your safety. If the provided plug does not fit into your outlet, consult an electrician for replacement of the obsolete outlet.
- 10 Protect the power cord from being walked on or pinched particularly at plugs, convenience receptacles, and the point where they exit from the apparatus.
- 11 Only use attachments/ accessories specified by the manufacturer.











- 12 Use only with the cart, stand, tripod, bracket, or table specified by the manufacturer, or sold with the apparatus. When a cart is used, use caution when moving the cart/apparatus combination to avoid injury from tip-over.



- 13 Unplug this apparatus during lightning storms or when unused for long periods of time.
- 14 Refer all servicing to qualified service personnel. Servicing is required when the apparatus has been damaged in any way, such as power-supply cord or plug is damaged, liquid has been spilled or objects have fallen into the apparatus, the apparatus has been exposed to rain or moisture, does not operate normally, or has been dropped.

## About this manual

- Instructions in this manual describe the controls on the remote. You can also use the controls on the recorder if they have the same or similar names as those on the remote.
- The on-screen display illustrations used in this manual may not match the graphics displayed on your TV screen.
- The explanations regarding discs in this manual refer to discs created on this recorder. The explanations do not apply to discs that are created on other recorders and played back on this recorder.

Icon	Meaning
	Functions available for DVD+RWs
	Functions available for DVD-RWs in VR (Video Recording) mode
	Functions available for DVD-RWs in video mode
	Functions available for DVD+Rs
	Functions available for DVD-Rs
	Functions available for DVD VIDEOS
	Functions available for VIDEO CDs or CD-Rs/CD-RWs in video CD format
	Functions available for music CDs or CD-Rs/CD-RWs in music CD format
	Functions available for DATA CDs (CD-Rs/CD-RWs containing MP3* audio tracks or JPEG files)
	Functions available for DATA DVDs (DVD+RWs/DVD-RWs/DVD+Rs/DVD-Rs containing MP3* audio tracks or JPEG files)

\* MP3 (MPEG1 Audio Layer 3) is a standard format defined by ISO/MPEG which compresses audio data.

# Table of Contents

WARNING .....	2
Precautions .....	2
Ways to Use Your DVD Recorder .....	8
How to Use the On-Screen Menus .....	10
<b>Hookups and Settings .....</b>	<b>12</b>
Hooking Up the Recorder .....	12
Step 1: Unpacking .....	12
Step 2: Connecting the Antenna Cable .....	12
Step 3: Connecting to Your TV .....	15
Step 4: Connecting to Your AV Amplifier (Receiver) .....	17
Step 5: Connecting the Power Cord .....	19
Step 6: Preparing the Remote .....	19
Step 7: Easy Setup .....	22
Connecting a VCR or Similar Device .....	26
<b>Quick Guide to Disc Types .....</b>	<b>28</b>
Recordable and Playable Discs .....	28
12 cm/8 cm Discs .....	30
Playable Discs .....	30
<b>Playback .....</b>	<b>32</b>
Playing Discs .....	32
Playback Options .....	33
Playing a Title From the Title List .....	37
Searching for a Title/Chapter/Track, etc. ....	38
Playing MP3 Audio Tracks .....	40
Playing JPEG Image Files .....	41
Displaying the Playing Time and Play Information .....	43
<b>Recording .....</b>	<b>45</b>
Before Recording .....	45
Recording Without the Timer .....	46
Timer Recording .....	48
Recording From Connected Equipment With a Timer (Synchro Rec) .....	50
Changing or Canceling Timer Settings (Timer List) .....	52
Recording From Connected Equipment Without a Timer .....	53
<b>Editing .....</b>	<b>55</b>
Before Editing .....	55
Editing a Title .....	56
Changing the Name of a Title .....	60
Creating a Playlist .....	61
Editing a Playlist .....	62
Formatting/Renaming/Protecting a Disc .....	66
Finalizing a Disc (Preparing a Disc for Playback on Other Equipment) .....	67

---

<b>DV/D8 Dubbing (DV/D8 → DVD)</b> . . . . .	<b>69</b>
Before DV/D8 Dubbing . . . . .	69
Connecting a Digital Video Camera to the DV IN Jack . . . . .	69
Dubbing From a DV/D8 Format Tape to a DVD . . . . .	70
<hr/>	
<b>Settings and Adjustments</b> . . . . .	<b>73</b>
Using the Setup Displays . . . . .	73
Antenna Reception Setting (Tuner Preset) . . . . .	74
Clock Setting (Clock Set) . . . . .	75
Video Settings (Video) . . . . .	76
Audio Settings (Audio) . . . . .	78
Recording Settings (Features) . . . . .	80
Language, Parental Control Settings/Factory Settings (Options) . . . . .	81
Easy Setup (Resetting the Recorder) . . . . .	83
<hr/>	
<b>Additional Information</b> . . . . .	<b>84</b>
Troubleshooting . . . . .	84
Notes About This Recorder . . . . .	88
Specifications . . . . .	89
About i.LINK . . . . .	90
Guide to Parts and Controls . . . . .	91
Glossary . . . . .	95
DVD Audio/Subtitle Language . . . . .	96
Index . . . . .	98



# Ways to Use Your DVD Recorder

## Quick access to recorded titles – Title List

- Display the Title List to view all titles on a disc and select a title for playback or editing (page 37).

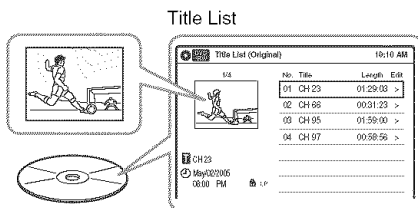

## Creating your own program – Playlist

- Record a program on a DVD-RW (VR mode), then erase, move or add scenes as you like without changing the original contents (page 61).

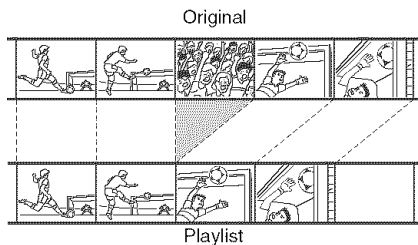

## One Touch Dubbing – DV/D8 Dubbing

- Connect your digital video camera to the DV IN jack and press the ONE TOUCH DUBBING button to dub a DV/D8 format tape over to a disc (page 69).

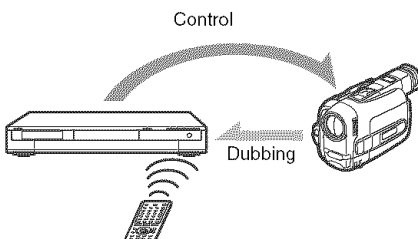



---

## Progressive playback

- ➔ If your TV is compatible with progressive signals, you can enjoy accurate color reproduction and high quality images in Progressive mode (page 77).

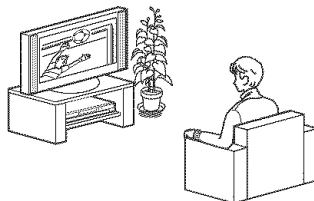

---

## Playing JPEG image files or MP3 audio files

- ➔ You can enjoy viewing JPEG images on your TV screen. First, take pictures with a digital camera and save them in JPEG format to a DATA CD (CD-RW/CD-R) or DATA DVD (DVD+RW/DVD-RW/DVD+R/DVD-R) on a PC. Then play the disc on this recorder (page 41). You can also play MP3 audio files on this recorder (page 40).

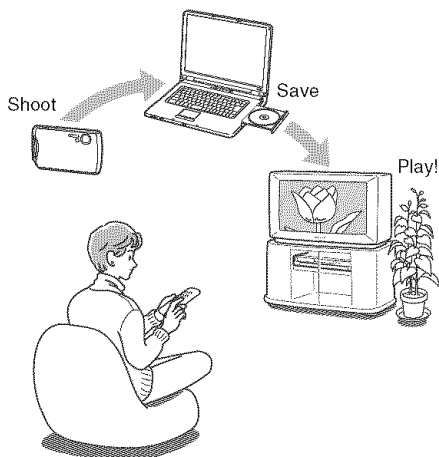

A list of recordable and playable discs is on page 28.

# How to Use the On-Screen Menus

The following three displays are mainly used to operate this recorder. Once you become familiar with the basic operations, you will find the recorder easy to use.

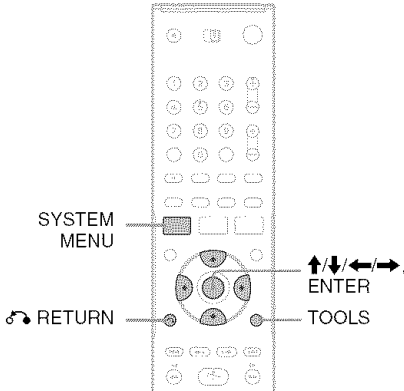

- 1 "Title List"  
Displays the list of the disc contents, including the recording information and movie thumbnail image, which allows you to select a title to play or edit.
- 2 "Timer"  
Used to set a new timer recording, as well as change or cancel the timer recordings you set.
- 3 "Edit"  
Used to create or edit a Playlist (unfinalized DVD-RWs (VR mode) only).
- 4 "DV/D8 Dubbing"  
Used to dub from a DV/D8 format tape to a disc.
- 5 "Disc Setting"  
Used to rename, format, or finalize a disc.
- 6 "Setup"  
Displays the "Setup" display for setting up the recorder to suit your preferences.

## System Menu

The System Menu appears when you press SYSTEM MENU, and provides entries to all of the recorder's main functions, such as timer recording and setup.

Select an option by pressing  $\uparrow/\downarrow$  and ENTER.

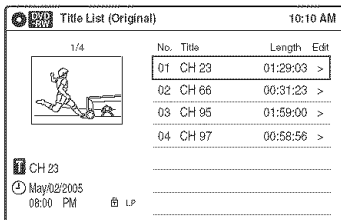
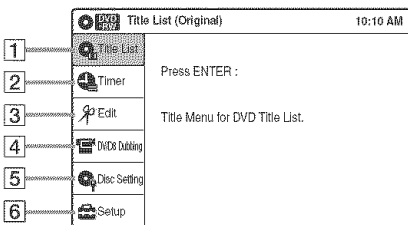

## Sub-menu

The sub-menu appears when you select an item from a list menu (e.g., a title from the Title List menu), and press ENTER. The sub-menu displays options applicable only to the selected item. The displayed options differ depending on the situation and disc type.

Select an option by pressing  $\uparrow/\downarrow$  and ENTER.

Example: The Title List menu

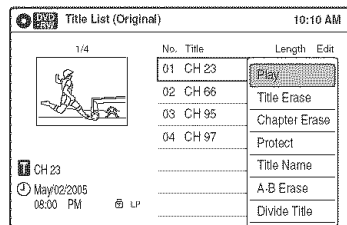

Options for the selected item

## TOOLS

The TOOLS menu appears when you press TOOLS. You can search for a title/chapter/track, check the playing and remaining time, or change audio and repeat settings. The displayed options differ depending on the media type.

Press **↑/↓** to select an option, press **←/→** to select the desired item, and press ENTER.

Example: When you press TOOLS while a DVD-RW (VR mode) is playing.

	Title	1/4
	Chapter	1/1
	Time	00:00:25
	Audio	ENG Dolby 5.1ch (1/8)
	Repeat	Off
	Remain	00:01:30

## Selectable options

Selectable options on the System Menu differ depending on the media type, disc condition, and operating status.

Example: When a disc is stopped.

Type	Selectable option					
<b>+RW</b>						
<b>-RWVR</b>						
<b>-RWVideo</b>						
<b>+R</b>						
<b>R</b>						
<b>DVD</b>						
<b>VCD</b>						
<b>CD</b>						
<b>DATA CD</b>						
<b>DATA DVD</b>						

\* Unfinalized disc only

## To return to the previous display

Press **↶** RETURN.

### Note

The System Menu does not appear when recording on a DVD.

## Hooking Up the Recorder

Follow steps 1 to 7 to hook up and adjust the settings of the recorder.

### Notes

- Plug cords securely to prevent unwanted noise.
- See the instructions supplied with the components to be connected.
- You cannot connect this recorder to a TV that does not have a video input jack.
- Be sure to disconnect the power cord of each component before connecting.

## Step 1: Unpacking

Check that you have the following items:

- Audio/video cord  
(phono plug × 3 ↔ phono plug × 3) (1)
- Antenna cable (1)
- Remote commander (remote) (1)
- Size AA (R6) batteries (2)

## Step 2: Connecting the Antenna Cable

Select one of the following antenna hookups. Do not connect the power cord until you reach “Connecting the Power Cord” on page 19.

If you have	Hookup
Cable box or satellite receiver with a video/audio output	A (page 13)
Cable box with an antenna output only	B (page 14)
Cable without cable box, or antenna only (no cable TV)	C (page 14)

### Note to CATV system installer (in USA)

This reminder is provided to call the CATV system installer’s attention to Article 820-40 of the NEC that provides guidelines for proper grounding and, in particular, specifies that the cable ground shall be connected to the grounding system of the building, as close to the point of cable entry as practical.

### Notes

- If your antenna is a flat cable (300-ohm twin lead cable), use an external antenna connector (not supplied) to connect the antenna to the recorder.
- If you have separate cables for VHF and UHF antennas, use a UHF/VHF band mixer (not supplied) to connect the antenna to the recorder.

## A: Cable box or satellite receiver with a video/audio output

With this hookup, you can record any channel on the cable box or satellite receiver. Be sure that the satellite receiver or cable box is turned on.  
 To watch cable or satellite programs, you need to match the channel on the recorder (L1) to the input jack connected to the cable box or satellite receiver (LINE 1 IN).

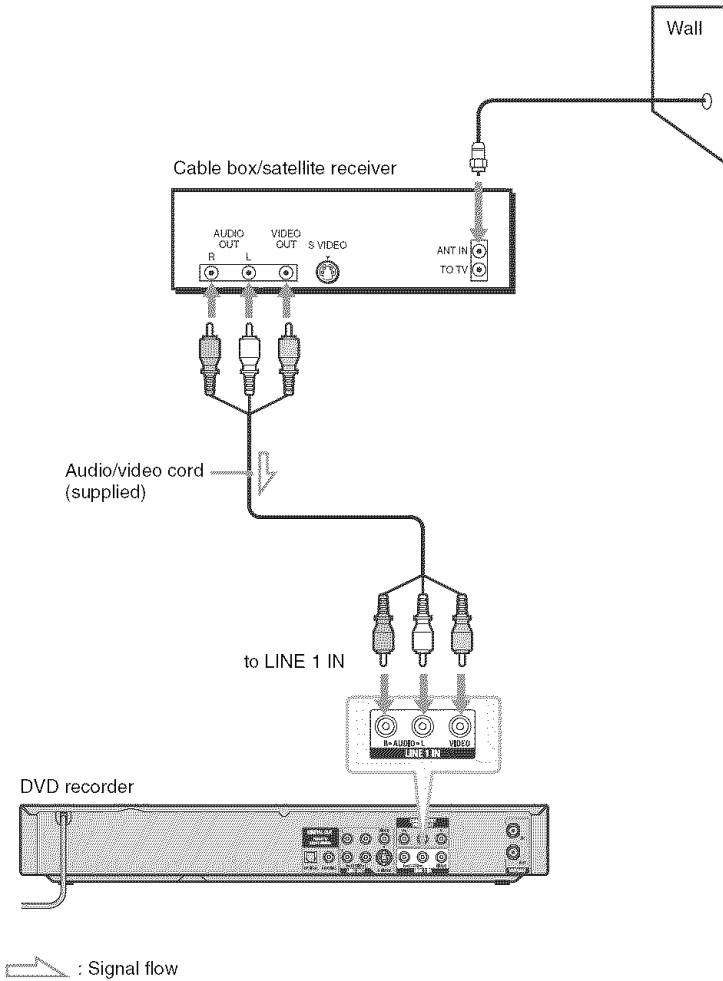

---

## B: Cable box with an antenna output only

With this hookup, you can record any channel on the satellite receiver or cable box. Be sure that the satellite receiver or cable box is turned on.

To watch cable programs, you need to match the channel on the recorder (2ch, 3ch or 4ch) to the antenna output channel on the cable box (2ch, 3ch or 4ch).

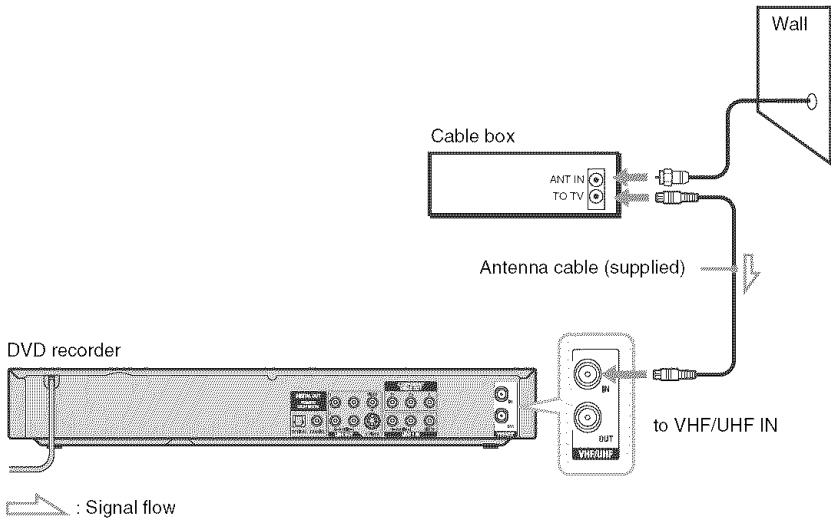

---

## C: Cable without cable box, or antenna only (no cable TV)

Use this hookup if you watch cable channels without a cable box. Also use this hookup if you are using a VHF/UHF antenna or separate VHF and UHF antennas.

With this hookup, you can record any channel by selecting the channel on the recorder.

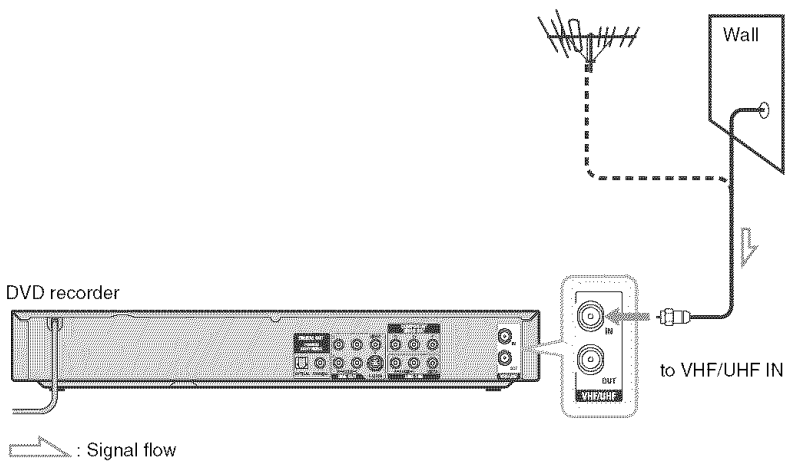

## Step 3: Connecting to Your TV

Connect the supplied audio/video cord to the LINE OUT 1 (AUDIO L/R/VIDEO) jacks of the recorder. To enjoy higher quality images, connect an S video cord (not supplied) instead of the yellow (video) plug. When using this connection, be sure to connect the audio cord to the LINE OUT 1 (AUDIO L/R) jacks.

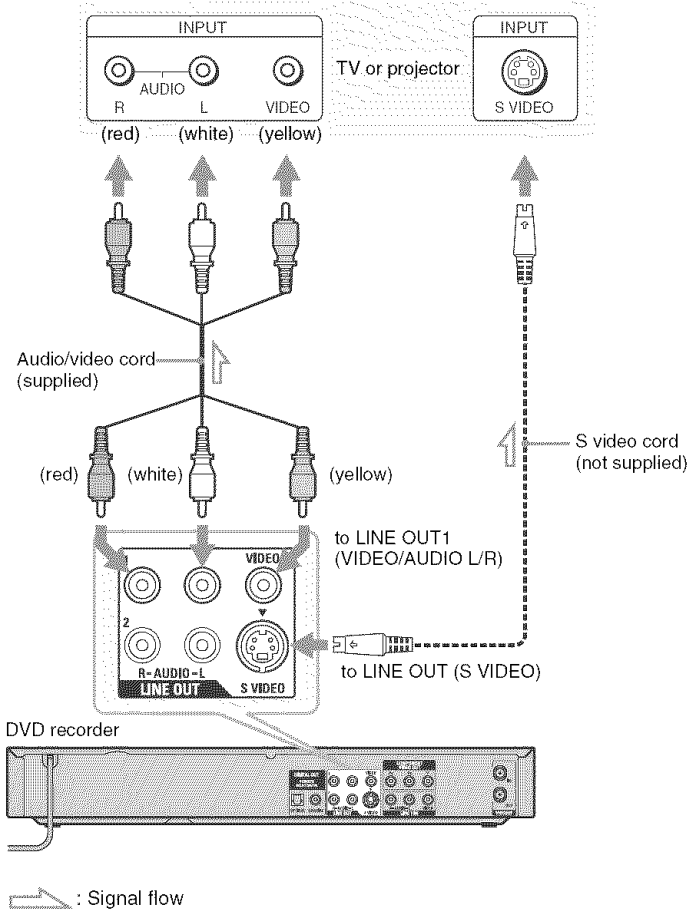

### When playing “wide screen” images

Some recorded images may not fit your TV screen. To change the picture size, see page 76.

### Notes

- Do not connect more than one type of video cord between the recorder and your TV at the same time.
- Do not connect your TV’s audio output jacks to the LINE IN (AUDIO L/R) jacks at the same time. This will cause unwanted noise to come from your TV’s speakers.

## If your TV has component video input jacks

Connect the COMPONENT VIDEO OUT jacks using a component video cord (not supplied) or three video cords (not supplied) of the same kind and length. You will enjoy accurate color reproduction and high quality images.

If your TV accepts progressive 480p format signals, you must use this connection and then set "Progressive" of "Video" to "On" in the "Setup" display (page 77). The PROGRESSIVE indicator lights up when the recorder outputs progressive signals.

When using this connection, be sure to connect the audio cord to the LINE OUT 1 (AUDIO L/R) jacks.

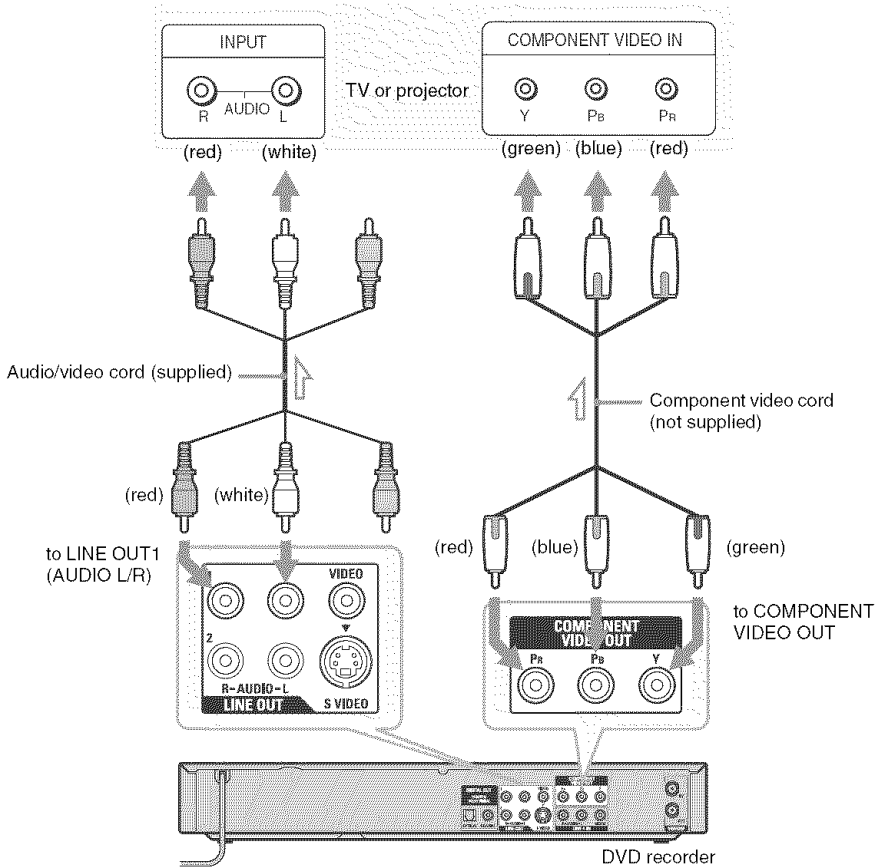



# Step 4: Connecting to Your AV Amplifier (Receiver)

Select one of the following patterns **A** or **B**, according to the input jack on your AV amplifier (receiver). This will enable you to listen to DVD audio tracks through your AV amplifier (receiver).

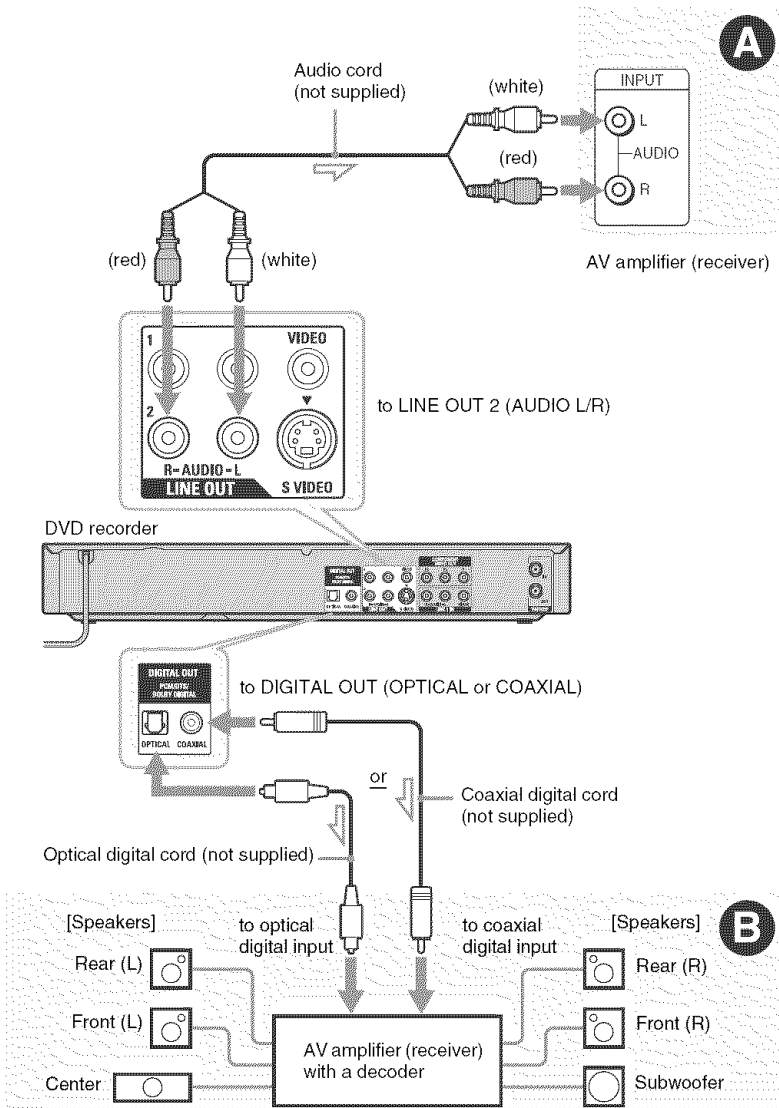

## A Connecting to audio L/R jacks

This connection uses a stereo amplifier's (receiver's) two front speakers for sound. You can enjoy the surround function that creates virtual speakers from two stereo speakers. Select from "Surround1," "Surround2," or "Surround3" of the surround effects (page 33).  
Surround 1

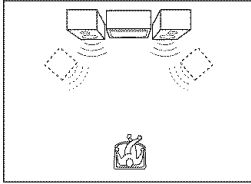

Surround 2

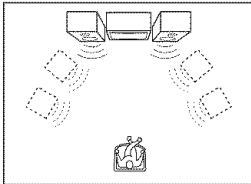

Surround 3

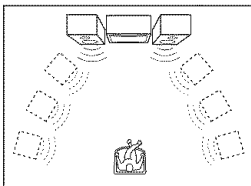

 Virtual speaker

## B Connecting to a digital audio input jack

Use this connection if your AV amplifier (receiver) has a Dolby\*<sup>1</sup> Digital or DTS\*<sup>2</sup> decoder and a digital input jack. You can enjoy the surround effect of Dolby Digital (5.1ch) or DTS (5.1ch).

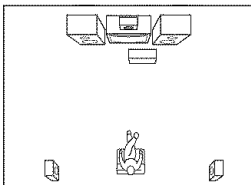

\*<sup>1</sup> Manufactured under license from Dolby Laboratories. "Dolby" and the double-D symbol are trademarks of Dolby Laboratories.

\*<sup>2</sup> "DTS" and "DTS Digital Out" are trademarks of Digital Theater Systems, Inc.

### 💡 Hint

For correct speaker location, see the operating instructions supplied with the connected components.

### Notes

- After you have completed the connection, make the appropriate settings under "Audio Connection Setup" in Easy Setup (page 22). Otherwise, no sound or a loud noise will come from your speakers.
- With a coaxial or optical digital connection, you cannot use the virtual surround effects of this recorder.
- The recorder cannot play Linear PCM soundtracks of 2 channels or more.
- When outputting from the DIGITAL OUT jacks, you cannot switch the bilingual sounds on a DVD-RW (VR mode) by pressing AUDIO.

## Step 5: Connecting the Power Cord

Plug the recorder and TV power cords into an AC outlet. After you connect the power cord, **you must wait for a short while before operating the recorder.** You can operate the recorder only after the front panel display lights up and the recorder enters standby mode.

If you connect additional equipment to this recorder (page 26), be sure to connect the power cord only after all connections are complete.

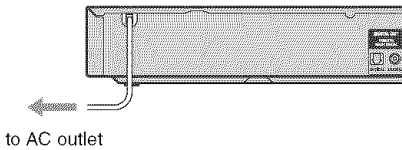

## Step 6: Preparing the Remote

You can control the recorder using the supplied remote. Insert two size AA (R6) batteries by matching the ⊕ and ⊖ ends on the batteries to the markings inside the battery compartment. When using the remote, point it at the remote sensor  on the recorder.

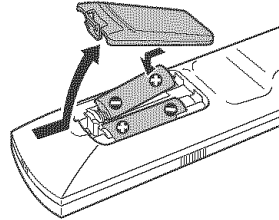

### Notes

- If the supplied remote interferes your other Sony DVD recorder or player, change the command mode number for this recorder (page 24).
- Use the batteries correctly to avoid possible leakage and corrosion. Do not touch the liquid with bare hands should leakage occur. Observe the following:
  - Do not use a new battery with an old battery, or batteries of different manufacturers.
  - Do not attempt to recharge the batteries.
  - If you do not intend to use the remote for an extended period of time, remove the batteries.
  - If battery leakage occurs, wipe out any liquid inside the battery compartment, and insert new batteries.
- Do not expose the remote sensor (marked  on the front panel) to strong light, such as direct sunlight or lighting apparatus. The recorder may not respond to the remote.
- With normal use, the batteries should last about three to six months.
- Do not leave the remote in an extremely hot or humid place.
- Do not drop any foreign object into the remote casing, particularly when replacing the batteries.

## Controlling TVs with the remote

You can adjust the remote control's signal to control your TV.

If you connect the recorder to an AV amplifier (receiver), you can also use the supplied remote to control the AV amplifier's (receiver's) volume.

### Notes

- Depending on the connected unit, you may not be able to control your TV or AV amplifier (receiver) with some or all of the buttons below.
- If you enter a new code number, the code number previously entered will be erased.
- When you replace the batteries of the remote, the code number may be reset to the default setting. Set the appropriate code number again.

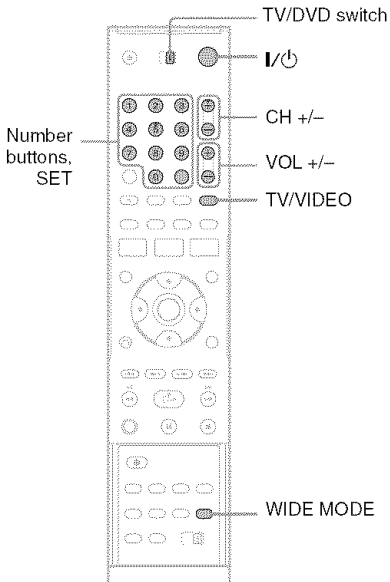

- 1 Slide the TV/DVD switch to TV.
- 2 Hold down I/⏻.
- 3 Enter your TV's manufacturer code (see below) using the number buttons.
- 4 Release I/⏻.

When the TV/DVD switch is set to TV, the remote performs the following:

Press	To
I/⏻	Turn your TV on or off

VOL +/-	Adjust the volume of your TV
CH +/-	Select the channel on your TV
TV/VIDEO	Switch your TV's input source
Number buttons and SET	Select the channel on a Sony TV
WIDE MODE	Switch to or from the wide mode of a Sony wide-screen TV

### Code numbers of controllable TVs

If more than one code number is listed, try entering them one at a time until you find the one that works with your TV.

Manufacturer	Code number
Sony	01 (default)
Akai	04
AOC	04
Centurion	12
Coronado	03
Curtis-Mathes	12, 14
Daewoo	04, 22
Daytron	03, 12
Fisher	11
General Electric	04, 06, 10
Hitachi	02, 03, 04
J.C.Penney	04, 10, 12
JVC	09
KMC	03
LG/Gold Star	03, 04, 17
Magnavox	03, 04, 08, 12, 21
Marantz	04, 13
MGA/Mitsubishi	04, 12, 13, 17
NEC	04, 12
Panasonic	06, 19
Philco	02, 03, 04, 08
Philips	08, 21
Pioneer	06, 16

Manufacturer	Code number
Portland	03
Proscan	10
Quasar	06, 18
Radio Shack	05, 10, 14
RCA	04, 10
Sampo	12
Samsung	03, 04, 12, 20
Sanyo	11, 14
Scott	12
Sears	07, 10, 11
Sharp	03, 05, 18
Sylvania	08, 12
Teknika	03, 08, 14
Toshiba	07, 18
Wards	03, 04, 12
Yorx	12
Zenith	14, 15

**💡 Hint**

If you want to control the TV's volume even when the TV/DVD switch is set to DVD, repeat the steps above and enter the code number 90 (default).

**Code numbers of controllable AV amplifiers (receivers)**

If more than one code number is listed, try entering them one at a time until you find the one that works with your AV amplifier (receiver).

Manufacturer	Code number
Sony	78, 79, 80, 91
Denon	84, 85, 86
Kenwood	92, 93
Onkyo	81, 82, 83
Pioneer	99
Sansui	87
Technics	97, 98
Yamaha	94, 95, 96

**Controlling the volume of your AV amplifier (receiver) with the remote**

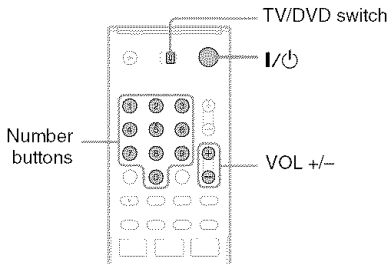

- 1** Slide the TV/DVD switch to DVD.
- 2** Hold down I/⏻, and enter the manufacturer code (see the table below) for your AV amplifier (receiver) using the number buttons.

- 3** Release I/⏻.  
The VOL +/- buttons control the AV amplifier's volume.  
If you want to control the TV's volume, slide the TV/DVD switch to TV.

## Step 7: Easy Setup

Follow the steps below to make the minimum number of basic adjustments for using the recorder. If you do not complete Easy Setup, it will appear each time you turn on your recorder. Settings are made in the following order.

OSD Language Setup



Clock Setup



Tuner and Channel Setup



TV Type Setup



Audio Connection Setup



**Finished!**

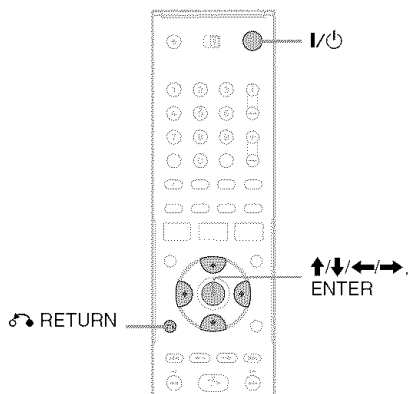

- 1 Turn on the TV.**
- 2 Press I/⏻.**  
The recorder turns on.
- 3 Switch the input selector on your TV so that the signal from the recorder appears on your TV screen.**

“Initial setting necessary to operate the DVD recorder will be made. You can change them later using setup.” appears.

- If this message does not appear, select “Easy Setup” in the “Setup” display to run Easy Setup (page 83).

- 4 Press ENTER.**

The setup display for selecting the language used in the on-screen display appears.

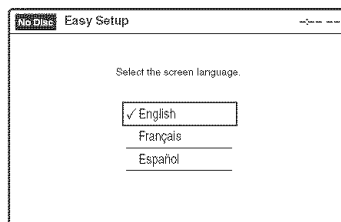

- 5 Select a language, and press ENTER.**

The setup display for clock setting appears.

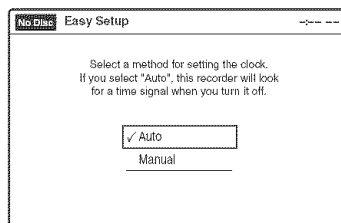

- 6 Select “Auto,” and press ENTER.**

The recorder will automatically search for a channel that carries a time signal when you turn off the recorder after finishing Easy Setup.

- If broadcasters in your area are not sending time signals, select “Manual,” and press ENTER. Press **↑/↓** to set the month and press **→**. Set the day, year, hour, minutes, and AM/PM in the same way. The day of the week is set automatically.

**7 Select whether or not you have a cable connection.**

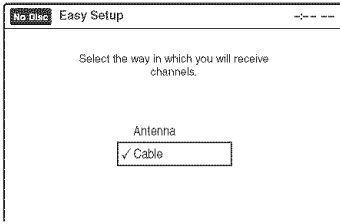

If you use an antenna only (no cable TV), select “Antenna.”  
For all other connections, select “Cable.”

**8 Press ENTER.**

The Tuner Preset function automatically starts searching for all of the receivable channels and presets them.

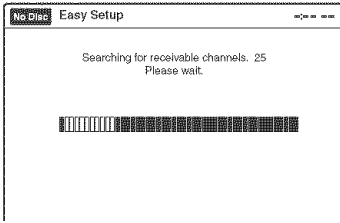

To set the channels manually, see page 75. After the Tuner Preset is finished, the setup display for selecting the picture size of the connected TV appears.

**9 Select the setting that matches your TV type.**

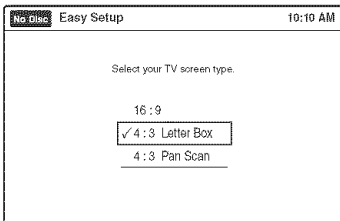

“4:3 Letter Box”: For standard TVs. Displays “wide screen” pictures with bands on the upper and lower sections of the screen.  
“4:3 Pan Scan”: For standard TVs. Automatically displays “wide screen” pictures on the entire screen and cuts off the sections that do not fit.  
“16:9”: For wide-screen TVs or standard TVs with a wide screen mode.  
For details, see “Video Settings (Video)” on page 76.

**10 Press ENTER.**

The setup display for selecting the type of Dolby Digital signal appears.

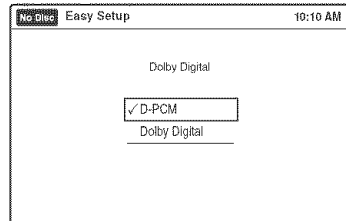

**11 Select the type of Dolby Digital signal you want to send to your amplifier (receiver).**

If your AV amplifier (receiver) has a Dolby Digital decoder, select “Dolby Digital.” Otherwise, select “D-PCM.”

**12 Press ENTER.**

The setup display for selecting the type of DTS signal appears.

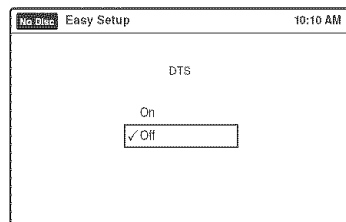

**13 Select whether or not you want to send a DTS signal to your amplifier (receiver), and press ENTER.**

If your AV amplifier (receiver) has a DTS decoder, select “On.” Otherwise, select “Off.”

## 14 Press ENTER when “Finish” appears.

Easy Setup is finished. All connections and setup operations are complete.



### To return to the previous display

Press RETURN.

#### Hint

If you want to run Easy Setup again, select “Easy Setup” in the “Setup” display (page 83).

#### Note

To record TV programs using the timer, you must set the clock accurately.

## If you have a Sony DVD player or more than one Sony DVD recorder

If the supplied remote interferes with your other Sony DVD recorder or player, set the command mode number for this recorder and the supplied remote to one that differs from the other Sony DVD recorder or player.

The default command mode setting for this recorder and the supplied remote is DVD 3.

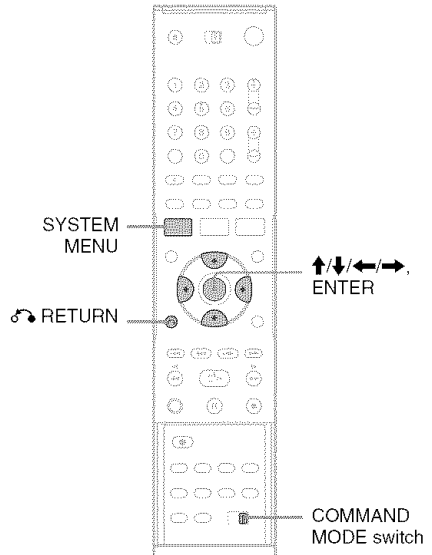

- 1 Press **SYSTEM MENU**.  
The System Menu appears.
- 2 Select “Setup,” and press **ENTER**.

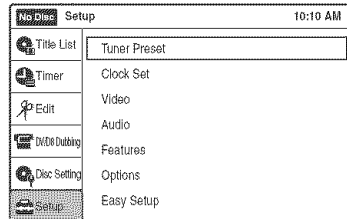

- 3 Select “Options,” and press **ENTER**.

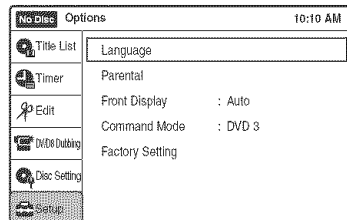



- 4** Select “Command Mode,” and press ENTER.

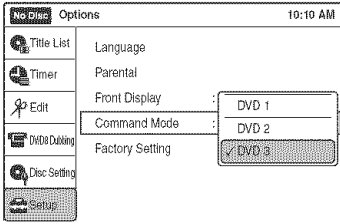

- 5** Select the command mode (“DVD 1,” “DVD 2,” or “DVD 3”), and press ENTER.
- 6** Slide the COMMAND MODE switch on the remote so it matches the mode you selected above.

**To return to the previous display**

Press  RETURN.

**Note**

If the command mode does not match, the recorder’s command mode appears on the front panel display when you operate the remote. Set the remote’s command mode to one that matches the recorder’s.

# Connecting a VCR or Similar Device

After disconnecting the recorder's power cord from an AC outlet, connect a VCR or similar recording device to the LINE IN jacks of this recorder. See also the instruction manual supplied with the connected equipment.

To record on this recorder, see "Recording From Connected Equipment With a Timer (Synchro Rec)" on page 50. Connect the equipment to the LINE 1 IN jacks of the recorder to record using the Synchro Rec function.

## Connecting to the LINE 2 IN jacks on the front panel

Connect a VCR or similar device to the LINE 2 IN jacks of this recorder. If the equipment has an S video jack, you can use an S video cord (not supplied) instead of the yellow (video) plug of the audio/video cord. You can connect a second DVD player and record DVDs.

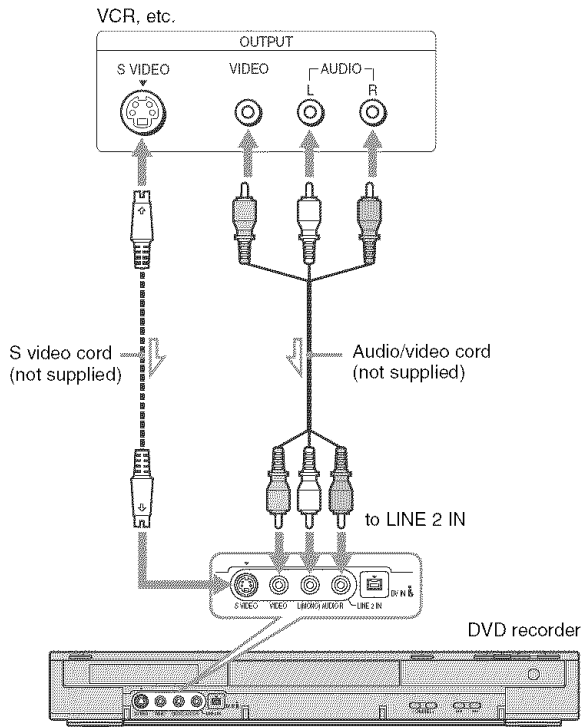

 : Signal flow

### Notes

- You cannot dub a copy guard DVD VIDEO to this DVD recorder.
- Do not connect the yellow LINE 2 IN (VIDEO) jack when using an S video cord.

## Connecting to the LINE 1 IN jacks

You can connect a VCR or similar device.

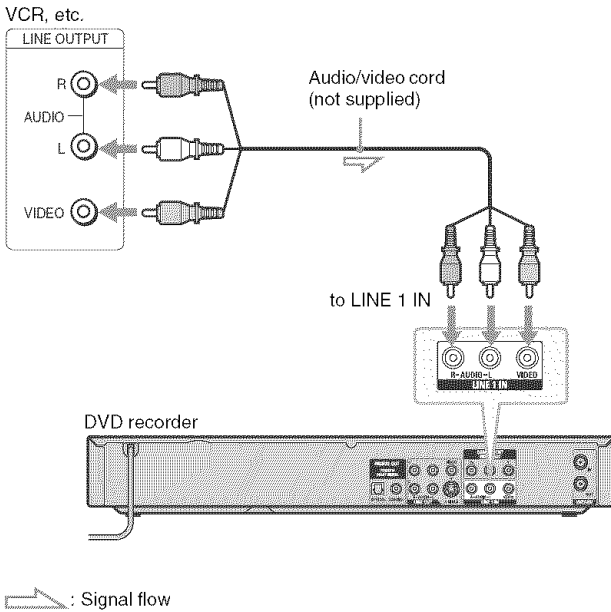

### Hint

When the connected equipment outputs only monaural sound, connect an audio cord to the LINE 2 IN AUDIO L (MONO) jack.

### Notes

- Do not connect the output jack of this recorder to another equipment's input jack with the other equipment's output jack connected to the input jack of this recorder. Noise (feedback) may result.
- Pictures containing copy protection signals that prohibit any copying cannot be recorded.
- If you pass the recorder signals via the VCR, you may not receive a clear image on your TV screen.

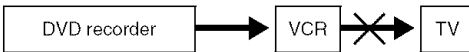



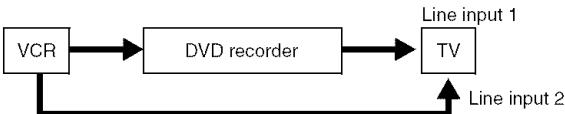









Be sure to connect your VCR to the DVD recorder and your TV in the order shown below. To watch video tapes, watch the tapes through a second line input on your TV.



- If the recorder's power cord is disconnected, you will not be able to view the signals from the connected VCR.
- Do not connect more than one type of video cord between the recorder and your TV at the same time.

## Recordable and Playable Discs

Disc Type		Disc Logo	Icon used in this manual	Formatting (new discs)	Compatibility with other DVD players (finalizing)
DVD+RW		 DVD+ReWritable		Automatically formatted	Playable on DVD+RW compatible players (automatically finalized)
DVD-RW	VR mode	 RW		Format in VR mode*2 (page 66)	Playable only on VR mode compatible players (finalization unnecessary) (page 67)
	Video mode	 RW 		Format in Video mode*2 (page 66)	Playable on most DVD players (finalization necessary) (page 67)
DVD+R		 DVD+R		Automatically formatted	Playable on DVD+R compatible players (finalization necessary) (page 67)
DVD+R DL		 DVD+R DL			
DVD-R		 R R4.7		Automatically formatted	Playable on most DVD players (finalization necessary) (page 67)

### Usable disc versions (as of May 2005)

- 4x-speed or slower DVD+RWs
- 2x-speed or slower DVD-RWs (Ver.1.1, Ver.1.1 with CPRM\*1)
- 4x-speed or slower DVD-RWs (Ver.1.2, Ver.1.2 with CPRM)
- 8x-speed or slower DVD+Rs
- 8x-speed or slower DVD-Rs (Ver.2.0)
- 2.4x-speed DVD+R DL (Double Layer) discs

\*DVD+RW,™ “DVD-RW,™ “DVD+R,™ “DVD+R DL,™ and “DVD-R” logos are trademarks.

Recording Features			Editing Features					
Rewrite (page 66)	Auto Chapter (page 48)	Manual Chapter (page 59)	Change Title Name (page 60)	Erase Title/ Chapter (page 56)	A-B Erase (page 57)	Divide Title (page 58)	Playlist (page 61)	
Yes	Yes	Yes	Yes	Yes* <sup>3</sup> /No	No	Yes	No	
Yes	Yes	Yes	Yes	Yes/Yes	Yes	Yes	Yes	
Yes	Yes	No	Yes	Yes* <sup>3</sup> /No	No	No	No	
No	Yes	No	Yes	Yes* <sup>4</sup> /No	No	No	No	
No	Yes	No	Yes	Yes* <sup>4</sup> /No	No	No	No	

### Discs that cannot be recorded on

- DVD-RWs (Ver.1.0)
- DVD+RWs that are not 2.4x-speed compatible
- 8 cm discs
- DVD-R DL (Dual Layer) discs
- DVD-Rs in VR mode (Video Recording format)
- DVD-Rs with CPRM\*<sup>1</sup>

\*<sup>1</sup> CPRM (Content Protection for Recordable Media) is a coding technology that protects copyrights for images.

\*<sup>2</sup> Unused DVD-RWs are automatically formatted according to the setting of "Format DVD" in "Features" setup (page 81).









\*<sup>3</sup> Erasing titles only frees up disc space if you erase the last title.

\*<sup>4</sup> Erasing titles does not free up disc space.

## 12 cm/8 cm Discs

Operation	DVD+RW		DVD-RW				DVD+R		DVD-R	
			VR mode		Video mode					
	12 cm	8 cm	12 cm	8 cm	12 cm	8 cm	12 cm	8 cm	12 cm	8 cm
<b>Playback</b>	Yes	Yes	Yes	Yes	Yes	Yes	Yes	—	Yes	Yes
<b>Recording</b>	Yes	No	Yes	No	Yes	No	Yes	—	Yes	No

## Playable Discs

Disc Type	Disc Logo	Icon Used in This Manual	Characteristics
<b>DVD VIDEO</b>			Discs such as movies that can be purchased or rented
<b>VIDEO CD</b>			VIDEO CDs or CD-Rs/CD-RWs in VIDEO CD format (with PBC function)
<b>CD</b>			Music CDs or CD-Rs/CD-RWs in music CD format that can be purchased
<b>DATA CD</b>			CD-Rs/CD-RWs created on a PC or similar device in music format, or MP3 or JPEG format that conforms to ISO9660* Level 1/Level 2
<b>DATA DVD</b>	—		DVD+RWs/DVD-RWs/DVD+Rs/DVD-Rs in MP3 or JPEG format conforming to UDF
<b>8 cm DVD+RW/ DVD-RW/ DVD-R</b>	—	—	8 cm DVD+RWs, DVD-RWs, and DVD-Rs recorded with a DVD video camera (Still images recorded with a DVD video camera cannot be played.)

“DVD VIDEO” and “CD” logos are trademarks.

\* A logical format of files and folders on DATA-CDs, defined by ISO (International Standard Organization).

## Discs that cannot be played

- CD-Rs/CD-RWs, other than those recorded in music CD format, MP3 or JPEG format, or Video CD format
- Data part of CD-Extras
- DVD-ROMs
- CD-ROMs
- DVD Audio discs
- DVD-R DL (Dual Layer) discs
- DVD-Rs recorded in VR mode (Video Recording format)
- DVD-Rs with CPRM
- DVD-RAMs
- HD layer on Super Audio CDs
- DVD VIDEOS with a different region code (see page 31)
- A disc recorded in a color system other than NTSC, such as PAL or SECAM

## Note on playback operations of DVD VIDEOS/VIDEO CDs

Some playback operations of DVD VIDEOS/VIDEO CDs may be intentionally set by software producers. Since this recorder plays DVD VIDEOS/VIDEO CDs according to the disc contents the software producers designed, some playback features may not be available. Also, see the instructions supplied with the DVD VIDEOS/VIDEO CDs.

## Note on DualDiscs

A DualDisc is a two sided disc product which mates DVD recorded material on one side with digital audio material on the other side. However, since the audio material side does not conform to the Compact Disc (CD) standard, playback on this product is not guaranteed.

## Region code (DVD VIDEO only)

Your recorder has a region code printed on the rear of the unit and will only play DVD VIDEOS (playback only) labeled with identical region codes. This system is used to protect copyrights. DVD VIDEOS labeled  will also play on this recorder.

If you try to play any other DVD VIDEO, a message will appear on the TV screen to indicate that the disc is not playable. Depending on the DVD VIDEO, no region code indication may be labeled even though playing the DVD VIDEO is prohibited by area restrictions.

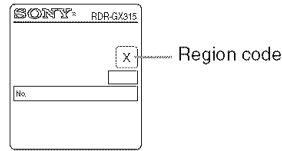

## Music discs encoded with copyright protection technologies

This product is designed to playback discs that conform to the Compact Disc (CD) standard. Recently, various music discs encoded with copyright protection technologies are being marketed by some record companies. Please be aware that among those discs, there are some that do not conform to the CD standard and may not be playable by this product.

## Notes

- Some DVD+RWs/DVD+Rs, DVD-RWs/DVD-Rs, or CD-RWs/CD-Rs cannot be played on this recorder due to the recording quality or physical condition of the disc, or the characteristics of the recording device and authoring software. The disc will not play if it has not been correctly finalized. For more information, see the operating instructions for the recording device.
- You cannot mix VR mode and Video mode on the same DVD-RW. To change the disc's format, reformat the disc (page 66). Note that the disc's contents will be erased after reformatting.
- You cannot shorten the time required for recording even with high-speed discs. Also, you cannot record on the disc if the disc is not 1x speed compatible.
- It is recommended that you use discs with "For Video" printed on their packaging.
- You cannot add new recordings to DVD-RWs (Video mode) or DVD-Rs that contain recordings made on other DVD equipment.
- You may not be able to further record on a DVD+RW recorded on other equipment. Note that recording on such discs may cause the recorder to rewrite the DVD menu.
- If the disc contains PC data unrecognizable by this recorder, the data may be erased.

## Playing Discs

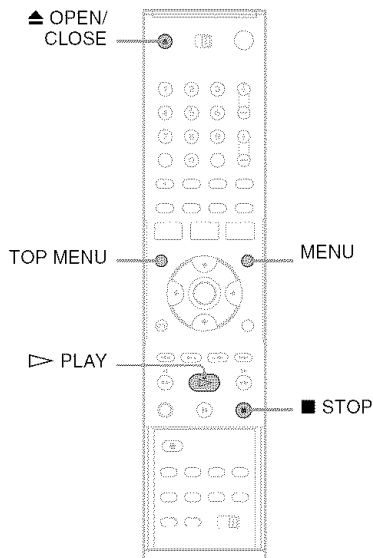

- 1 Press **▲ OPEN/CLOSE**, and place a disc on the disc tray.

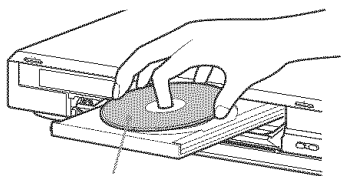

Playback side facing down

- 2 Press **▲ OPEN/CLOSE** to close the disc tray.

Wait until "LOAD" disappears from the front panel display.

- 3 Press **▶ PLAY**.

Playback starts.

### Hints

- You can play DATA CDs or DATA DVDs with MP3 tracks or JPEG files (page 40, 41).
- If you insert a DVD VIDEO, VIDEO CD, or CD, playback starts automatically depending on the disc.
- When playing a DVD+RW, DVD-RW, DVD+R, and DVD-R, you can select the title from the Title List menu (page 37).

### Note

To play a disc recorded with other equipment on this recorder, finalize the disc on the recording equipment first.

## Using the DVD's Menu



When you play a DVD VIDEO, or a finalized DVD+RW, DVD-RW (Video mode), DVD+R, or DVD-R, you can display the disc's menu by pressing **TOP MENU** or **MENU**.

### To stop playback





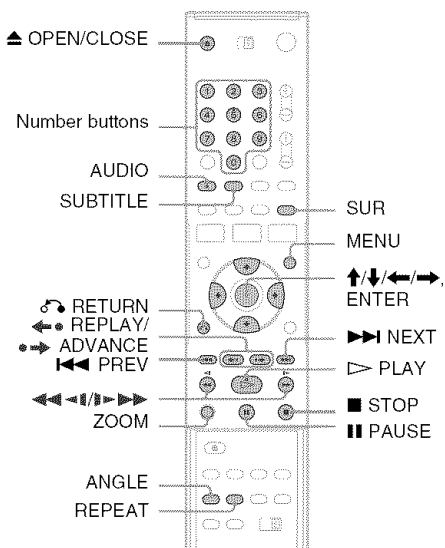

Press **■ STOP**.



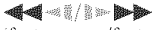

# Playback Options



Button	Operation	Disc
▲ OPEN/CLOSE	Stops playing and opens the disc tray.	All discs
AUDIO	Selects one of the audio tracks recorded on the disc when pressed repeatedly. <b>DVD</b> : Selects the audio source. <b>VCD</b> : Selects stereo or monaural audio tracks.	<b>DVD</b> <b>VCD</b>
SUBTITLE	Selects a subtitle language when pressed repeatedly.	<b>DVD</b>
ANGLE	Selects an angle when pressed repeatedly. If various angles (multi-angles) for a scene are recorded on the disc, "◻" appears in the front panel display.	<b>DVD</b>
ZOOM	Zooms into a scene during playback or still mode when pressed repeatedly. Magnification changes as follows: normal → ×2 → ×4 → normal  The zoom function may not work depending on the DVD. To zoom in a JPEG image, see page 42.	<b>+RW</b> <b>-RWv</b> <b>-RWvideo</b> <b>+R</b> <b>-R</b> <b>DVD</b> <b>VCD</b>

Button	Operation	Disc								
SUR (surround)	<p>Surround lets you enjoy surround sound effects by using sound imaging to create virtual rear speakers from a stereo TV or two front speakers (page 18). Selects one of the effects when pressed repeatedly.</p> <p>“Off”: No surround effect.</p> <p>“Surround1”: Creates one set of virtual surround speakers.</p> <p>“Surround2”: Creates two sets of virtual surround speakers.</p> <p>“Surround3”: Creates three sets of virtual surround speakers.</p> <p>This feature is effective when you use two separate front speakers.</p>	All discs								
 <p>• REPLAY/ • ADVANCE</p>	<ul style="list-style-type: none"> <li>Replays or briefly fast forwards a scene when pressed during playback.</li> <li>Goes to the previous or next frame when pressed during pause mode.</li> </ul>									
 <p>◀◀ PREV/ NEXT ▶▶</p>	<ul style="list-style-type: none"> <li>Goes to the beginning of the current or next title/chapter/scene/track and starts playback when pressed during playback.</li> <li>Goes to the beginning of the previous title/chapter/scene/track when ◀◀ PREV is pressed within three seconds after starting a title/chapter/scene/track.</li> </ul>	All discs								
 <p>(fast reverse/fast forward)</p>	<p>Fast reverses or fast forwards the disc when pressed during playback.</p> <p>Search speed changes with each press:</p> <table style="margin-left: auto; margin-right: auto;"> <tr> <td style="text-align: center;">fast reverse</td> <td style="text-align: center;">fast forward</td> </tr> <tr> <td style="text-align: center;">FR1 ◀</td> <td style="text-align: center;">→ FF1 *1</td> </tr> <tr> <td style="text-align: center;">FR2 *2 ◀◀</td> <td style="text-align: center;">→→ FF2 *2</td> </tr> <tr> <td style="text-align: center;">FR3 *3 ◀◀◀</td> <td style="text-align: center;">→→→ FF3 *3</td> </tr> </table>	fast reverse	fast forward	FR1 ◀	→ FF1 *1	FR2 *2 ◀◀	→→ FF2 *2	FR3 *3 ◀◀◀	→→→ FF3 *3	<p>All discs</p> <p>*1 FF1 with sound (Scan Audio) is available for DVDs with Dolby Digital soundtracks.</p> <p>*2 FR2 and FF2 are not available for MP3.</p> <p>*3 FR3 and FF3 are only available for DVDs and VIDEO CDs.</p>
fast reverse	fast forward									
FR1 ◀	→ FF1 *1									
FR2 *2 ◀◀	→→ FF2 *2									
FR3 *3 ◀◀◀	→→→ FF3 *3									
 <p>(slow)</p>	<p>Plays in slow motion when pressed in pause mode. Playback speed changes with each press:</p> <table style="margin-left: auto; margin-right: auto;"> <tr> <td style="text-align: center;">reverse slow motion</td> <td style="text-align: center;">forward slow motion</td> </tr> <tr> <td style="text-align: center;">◀◀ 3 ◀</td> <td style="text-align: center;">→ 3 ▶▶</td> </tr> <tr> <td style="text-align: center;">◀◀ 2 ◀◀</td> <td style="text-align: center;">→→ 2 ▶▶</td> </tr> <tr> <td style="text-align: center;">◀◀ 1 ◀◀◀</td> <td style="text-align: center;">→→→ 1 ▶▶▶</td> </tr> </table>	reverse slow motion	forward slow motion	◀◀ 3 ◀	→ 3 ▶▶	◀◀ 2 ◀◀	→→ 2 ▶▶	◀◀ 1 ◀◀◀	→→→ 1 ▶▶▶	 <p>* * Playback direction only</p>
reverse slow motion	forward slow motion									
◀◀ 3 ◀	→ 3 ▶▶									
◀◀ 2 ◀◀	→→ 2 ▶▶									
◀◀ 1 ◀◀◀	→→→ 1 ▶▶▶									
 <p>   PAUSE</p>	<p>Pauses playback.</p> <p>If you pause playback for more than five minutes, playback starts automatically.</p>	All discs								

Button	Operation	Disc
REPEAT	<p>Displays the items to be repeated when pressed. Select an item using <math>\uparrow/\downarrow</math>, and press ENTER. To cancel Repeat Play, select “Off” and press ENTER. Press <math>\rightarrow</math> RETURN to turn off the display.</p> <p><b>When playing a DVD</b></p> <p>“Chapter”: Repeats the current chapter.  “Title”: Repeats the current title on a disc.  “A-B” (Repeat A-B Play): Repeats a specific portion (page 36).</p> <p><b>When playing a VIDEO CD (with PBC function off)</b></p> <p>“Track”: Repeats the current track.  “Disc”: Repeats all of the tracks.  “A-B” (Repeat A-B Play): Repeats a specific portion (page 36).</p>	 <p>* With PBC function off</p>
	<p>Selects the item to be repeated when pressed repeatedly. To cancel Repeat Play, select “Off.”</p> <p><b>When playing a CD</b></p> <p>“Track”: Repeats the current track.  “Disc”: Repeats all of the tracks.</p> <p><b>When playing a DATA CD/DATA DVD (MP3 audio)</b></p> <p>“File”: Repeats the current track.  “Folder”: Repeats the current album.</p>	

To resume normal playback, press  $\triangleright$  PLAY.

### Hints

- You can change playback options, such as subtitle, audio track, angle, etc., using the TOOLS menu (page 11).
- During playback or pause mode, the recorder’s  $\lll/\ggg$  buttons and the remote’s  $\lll$ PREV/ $\ggg$ NEXT buttons work the same way (page 34). Hold the buttons down during playback to fast forward or fast reverse. In pause mode, you can play in slow motion. Three speeds are available, depending on the duration of the press.
- See “DVD Audio/Subtitle Language” on page 96 for the meaning of the language abbreviation.

### Notes

- You cannot use the repeat play function with VIDEO CDs while the PBC function is on (page 36).
- When the playback signal does not contain a signal for the surround speakers, the surround effects will be difficult to hear.
- When you select one of the surround modes, turn off the surround settings of the connected TV or amplifier (receiver).
- If you pause playback of a CD, or DATA CD/DATA DVD containing MP3 audio tracks, playback will not start until you press  $\triangleright$  PLAY or  $\parallel$  PAUSE.
- Make sure that your listening position is between and at an equal distance from your speakers, and that the speakers are located in similar surroundings.
- Sound will be interrupted during Scan Audio (page 36).

### Notes on playing DTS soundtracks on a CD

When playing DTS-encoded CDs, excessive noise will be heard from the analog stereo jacks. To avoid possible damage to the audio system, the consumer should take proper precautions when the analog stereo jacks of the recorder are connected to an amplification system. To enjoy DTS Digital Surround™ playback, an external 5.1-channel decoder system must be connected to the digital jack of the recorder.

### Notes on playing DVDs with a DTS soundtrack

DTS audio signals are output only through the DIGITAL OUT (OPTICAL or COAXIAL) jack. When you play a DVD with DTS soundtracks, set “Digital Out” – “DTS” to “On” of “Audio” in the “Setup” display (page 78).

---

## Playing quickly with sound (Scan Audio) (DVDs with Dolby Digital soundtracks only)

You can play quickly with dialog or sound during FFI fast-forward of a DVD with Dolby Digital soundtracks. Simply press **▶▶** during playback.

### Hint

To turn off the Scan Audio function, set "Scan Audio" of "Audio" to "Off" in the "Setup" display (page 79).

### Note

Sound will be interrupted during Scan Audio.

---

## Playing VIDEO CDs with PBC functions



PBC (Playback Control) allows you to play VIDEO CDs interactively using a menu on your TV screen.

When you start playing a VIDEO CD with PBC functions, a menu appears.

Select an item using the number buttons and press ENTER. Then follow the instructions in the menu (press **▷** PLAY when "Press SELECT" appears).

Operations differ depending on the disc. See the instructions supplied with the disc.

### To cancel PBC Playback

Press MENU to display "Menu: Off." To use the PBC functions, press MENU again to display "Menu:On."

---

## Resuming playback from the point where you stopped the disc (Resume Play)

Press **▷** PLAY again after stopping a disc to resume playback from the same point.

To start from the beginning, press **■** STOP twice, and press **▷** PLAY.

The point where you stopped playing is cleared when:

- you open the disc tray.
- you play another title.
- you switch the Title List menu to Original or Playlist (DVD-RW (VR mode) only).
- you edit the title after stopping playback.

- you make a recording.

---

## Repeating a specific portion (Repeat A-B Play)



- 1 During playback, press REPEAT.
- 2 Select "A" using **↑/↓**.
- 3 Press ENTER at the starting point (point A) of the portion to be played repeatedly. "A-" appears.
- 4 Continue playing or press **◀/▶** to locate the ending point (point B), and press ENTER. Repeat A-B Play starts.

To return to normal playback, press REPEAT to select "Off," and press ENTER. Press **↶** RETURN to turn off the display.

\* Only with PBC function off.

---

## Playing restricted DVDs (Parental Control)



If you play a restricted DVD, a message appears asking whether you want to override the restriction.

- 1 Select "OK" and press ENTER. The display for entering your password appears.
- 2 Enter your four digit password using the number buttons. The recorder starts playback.

To register or change the password, see "Parental (DVD VIDEOS only)" on page 82.

## Locking the recorder (Child Lock)

You can lock all of the buttons on the recorder so that the settings are not canceled by mistake.

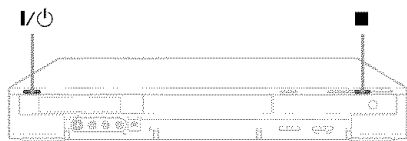

With the recorder turned on, hold down **I/⏻** on the recorder. The recorder turns off and “CHILD LOCK” appears in the front panel display. The **⊖** indicator remains lit if there is a timer setting. The recorder will not work except for timer recordings.

To unlock the recorder, hold down **I/⏻** on the recorder until “CHILD LOCK” disappears from the front panel display. The recorder is unlocked and turns on.

To stop timer recording while the recorder is locked, press **■** twice. The recording stops and the recorder is unlocked.

### Note

The recorder will be unlocked when you stop timer recording by pressing **■**.

## Playing a Title From the Title List



The Title List menu displays the program titles on the disc.

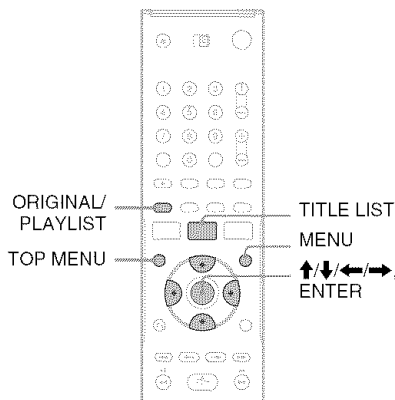

- 1 Place a disc on the disc tray.
- 2 Press **TITLE LIST**.

Example: DVD-RW (VR mode)

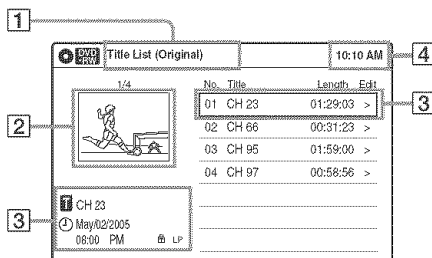

- 1 Title type (DVD-RWs (VR mode) only):  
Displays the title type, “Title List (Original)” or “Playlist.”
- 2 Movie thumbnail image
- 3 Title information:  
Displays the title number, title name, recording date, and recording mode.  
“**⊖**” indicates a protected title, while “**⊕**” indicates unprotected.
- 4 Clock

### 3 Select the title, and press ENTER.

The sub-menu appears.

### 4 Select "Play," and press ENTER.

Playback starts from the selected title on the disc.

#### About the Title List for DVD-RWs (VR mode)

You can switch the Title List to show original or Playlist.

While the Title List menu is turned on, press ORIGINAL/PLAYLIST repeatedly to select either "Title List (Original)" or "Playlist."

For details, see "Edit options for DVD-RWs (VR mode)" on page 55.

#### To turn off the Title List

Press TITLE LIST.

#### Notes

- The Title List does not appear for DVD-RWs (Video mode), DVD+Rs, or DVD-Rs that have been finalized. To view a title, press TOP MENU or MENU (page 32).
- The Title List may not appear for discs created on other DVD recorders.
- Letters that cannot be displayed are replaced with "∅."

## Searching for a Title/Chapter/Track, etc.



You can search a DVD by title or chapter, and VIDEO CD by track or scene. As titles and tracks are assigned individual numbers on the disc, select the title or track by entering its number. You can also search for a scene using the time code.

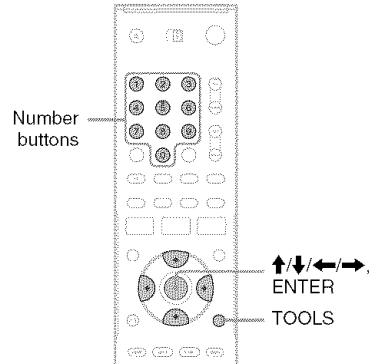

### 1 Press TOOLS during playback.

The TOOLS menu appears.

### 2 Select a search method.

"Title" (for DVDs)

"Chapter" (for DVDs)

"Track" (for VIDEO CDs with PBC function off)

"Time" (for DVDs/VIDEO CDs): Searches for a starting point using the time code.

### 3 Press ↑/↓/←/→ to select the number of the title, chapter, track, etc., you want, or press the number buttons to enter the time code.

For example: "Time"

To find a scene at 2 hours, 10 minutes, and 20 seconds, enter "21020."

If you make a mistake, wait a moment until the display returns to the elapsed playing time display, then select another number.

### 4 Press ENTER.

The recorder starts playback from the selected point.

To turn off the display, press TOOLS.

**Note**

Depending on the disc, you may not be able to use the TOOLS menu to search for a title/chapter/track, or enter the time code for a playback point.

**Bookmarking a favorite scene (Bookmark)**



You can have the recorder store specific portions of a disc in memory and play them immediately whenever you want (Bookmark). Up to ten bookmarks per disc can be set.

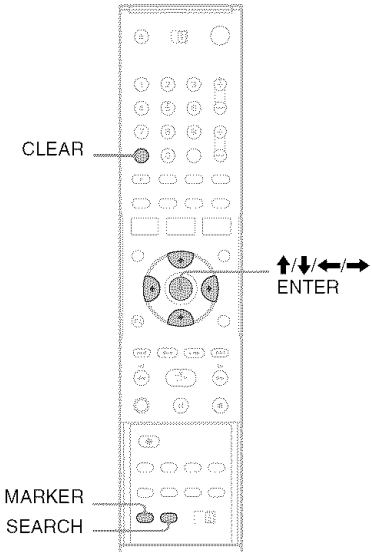

**During playback, press MARKER at a favorite scene.**

The bookmark is set.

**To play from bookmarks**

1 During playback, press SEARCH.

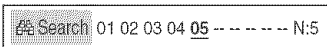

2 Press ←/→ to select a bookmark, and press ENTER.  
Playback starts from the selected bookmark.

**To erase bookmarks**

1 During playback, press SEARCH.

2 Press ←/→ to select the bookmark to be erased.

3 Press CLEAR.

**Note**

When you eject the disc, the bookmark information is cleared.

# Playing MP3 Audio Tracks

DATA CD DATA DVD

You can play MP3 audio tracks on DATA CDs (CD-Rs/CD-RWs) or DATA DVDs (DVD+RWs/DVD-RWs/DVD+Rs/DVD-Rs).

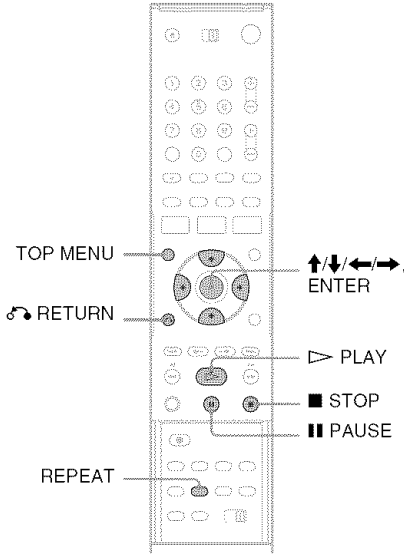

## 1 Place a DATA CD/DATA DVD on the disc tray.

When you insert a DATA CD/DATA DVD containing MP3 audio tracks and JPEG image files, the display for selecting a media type appears.

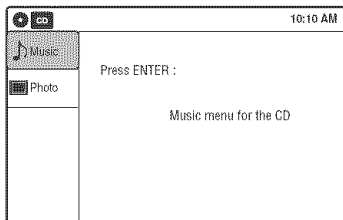

If you insert a DATA CD/DATA DVD containing only MP3 audio files, the “Music” display appears. Go to step 3.

- 2 Select “Music,” and press ENTER. The “Music” display appears.
- 3 Select an album, and press ENTER.

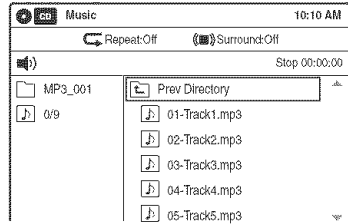

## 4 Select a track, and press ENTER.

Playback starts from the selected track. When a track or album is being played, the title is shown in a box.

### To stop playback

Press ■ STOP.

### To pause playback

Press ▮ PAUSE.

To restart playback, press ▷ PLAY or ▮ PAUSE.

### To play repeatedly

Press REPEAT repeatedly during playback.

“Off”: Does not play repeatedly.

“File”: Repeats the current track.

“Folder”: Repeats the current album.

### To return to the previous display

Press ↶ RETURN.

### To switch between MP3 audio tracks and JPEG image files

Press ■ STOP, and press TOP MENU.

## About MP3 audio tracks

You can play back DATA CDs (CD-Rs/CD-RWs) or DATA DVDs (DVD+RWs/DVD-RWs/DVD+Rs/DVD-Rs) recorded in MP3 (MPEG-1 Audio Layer III) format. However, the discs must be recorded according to ISO9660 Level 1/Level 2 or Joliet format and DATA DVDs of Universal Disk Format (UDF) for the recorder to recognize the tracks (or files).



See the instructions supplied with the CD-R/CD-RW/DVD-R/DVD-RW drives and the recording software (not supplied) for details on the recording format.

### Hints

- Since a disc with many trees takes longer to start playback, it is recommended that you create albums with no more than two trees.
- When playback of all the MP3 audio tracks within the album finishes, the recorder stops.

### Notes

- The recorder may not be able to play some DATA CDs or DATA DVDs created in the Packet Write format.
- The recorder will play any data with the extension “.MP3,” even if they are not in MP3 format. Playing such data may generate a loud noise which could damage your speaker system.
- Only one session of a multi-session DATA DVD can be played back.
- The recorder does not conform to audio tracks in MP3PRO format.
- The recorder can recognize up to 499 MP3 audio tracks within a single album. The recorder may not recognize some discs depending on the recording device used for recording or the disc condition.
- The recorder can play MP3 audio tracks recorded in the following sampling frequencies: 32 kHz, 44.1 kHz, 48 kHz.
- ID3 tags cannot be displayed.
- Only alphabet and numbers can be used for album or track names. Anything else is displayed as an asterisk.

## Playing JPEG Image Files

DATA CD DATA DVD

You can play JPEG image files on DATA CDs (CD-Rs/CD-RWs) or DATA DVDs (DVD+RWs/DVD-RWs/DVD+Rs/DVD-Rs).

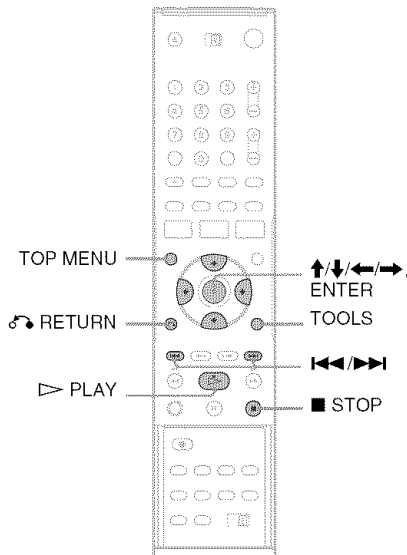

### 1 Place a DATA CD/DATA DVD on the disc tray.

When you insert a DATA CD/DATA DVD containing MP3 audio tracks and JPEG image files, the display for selecting a media type appears.

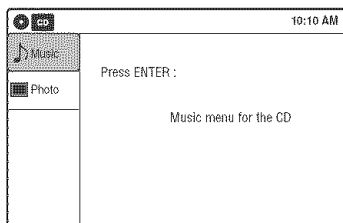

If you insert a DATA CD/DATA DVD containing only JPEG files, the “Photo” display appears. Go to step 3.

## 2 Select “Photo,” and press ENTER.

The “Photo” display appears.

## 3 Select a folder, and press ENTER.

Directory information

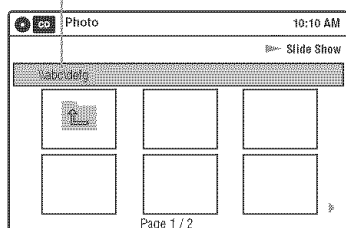

To display the previous or next page, press **◀/▶**.

## 4 Select an image file, and press ENTER.

The selected image is displayed over the entire screen.

To display the previous or next image, press **◀/▶**.

The following menu icons appear in the upper part of the screen.

: Returns to the “Photo” display.

: Starts the slide show (page 42).

: Rotates the image (page 42).

: Zooms the image (page 42).

Press **TOOLS** to turn on/off the menu icons.

## To play the slide show

### 1 Press **◀/▶** to select “,” and press ENTER.

The “Slide Show Speed” menu appears.

“”: Slow

“”: Normal

“”: Fast

### 2 Press **◀/▶** to select the desired play speed, and press ENTER.

Slide show starts from the selected image. To stop playing, press **■ STOP**.

## To rotate the selected image

Press **◀/▶** to select “,” and press ENTER. Each time you press ENTER, the image turns clockwise by 90°.

## To zoom in an image

Press **◀/▶** to select “,” and press ENTER. Each time you press ENTER, the magnification changes as follows:

2× → 4× → 2× → normal

## To return to the previous display

Press **↶ RETURN**.

## To switch between MP3 audio tracks and JPEG image files

Press **■ STOP**, and press **TOP MENU**.

### Hint

You can also start the slide show by pressing **▷ PLAY** in step 4 above.

### Notes

- You cannot use **↑/↓/←/→** to move the image within the screen while zooming.
- Slide show can play in only one direction.
- You cannot rotate or zoom during slide show.
- If you select “” in the rotated image display, the images in the “Photo” display will not be rotated.

## About JPEG image files

You can play back DATA CDs (CD-Rs/CD-RWs) or DATA DVDs (DVD+RWs/DVD-RWs/DVD+Rs/DVD-Rs) recorded in JPEG format. However, the discs must be recorded according to ISO9660 Level 1/Level 2 or Joliet format and DATA DVDs of Universal Disk Format (UDF) for the recorder to recognize the tracks (or files). See the instructions supplied with the CD-R/CD-RW/DVD-R/DVD-RW drives and the recording software (not supplied) for details on the recording format.

### Hint

If you add numbers (01, 02, 03, etc.) to the front of the file names, the files will be played in that order.

### Notes

- The recorder can only play the files with the extension “.JPG” or “.JPEG.”
- Some DATA CDs or DATA DVDs cannot be played on this recorder depending on file format.
- If you add the extension “.JPG” or “.JPEG” to data not in JPEG format, a message appears indicating that the format is not supported.
- Only one session of a multi-session DATA DVD can be played back.
- Depending on the disc or the size of image files, playback may take some time to start.
- The recorder can recognize up to 999 JPEG image files within a single folder. The recorder may not recognize some discs depending on the recording device used for recording or the disc condition.

- Progressive and lossless compression JPEG image files are not supported.
- The image size that the recorder can display is limited to width 32 - 7680 pixels by height 32 - 8192 pixels.

## Displaying the Playing Time and Play Information



You can check disc information, such as playing time, recording mode, and remaining disc space.

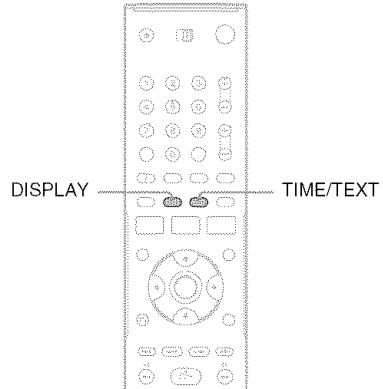

### Press DISPLAY.

The information display appears. Each time you press the button, the display changes as follows:

Disc information/date and time



Disc information only



No display

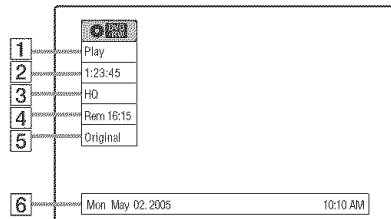

- 1** Playing status
- 2** Playing time
- 3** Recording mode

- 4 Remaining disc space (in stop mode)  
Remaining time of the current title (during playback)
- 5 Channel or input source\*
- 6 Date and time

\* Title type (original or Playlist) for DVD-RWs (VR mode).

## Viewing information on the front panel display

You can view the information on the front panel display.

### Press TIME/TEXT repeatedly.

The displays differ depending on the disc type or playing status.

Example: When playing a DVD

Playing time of the current title



Current title number and current chapter number

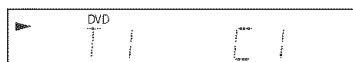

Clock

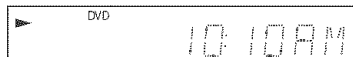

Example: When a DVD is stopped

Clock



Current title and chapter number



Remaining disc space



Channel or input source

Example: When playing a CD

Playing time of the current track



Current track number



Clock

## Before Recording

### Before you start recording...

- This recorder can record on various disc types. Select the disc type according to your needs (page 28).
- Check that the disc has enough available space for the recording (page 43). For DVD+RWs or DVD-RWs, you can free up disc space by erasing titles (page 56).

### Hint

To play a disc recorded with this recorder on other equipment, finalize the disc (page 67).

### Notes

- Timer recordings will start with or without the recorder turned on. The recorder automatically turns off after a recording has finished.
- This recorder records at  $\times 1$  speed.





## Recording mode

Like the SP or EP recording mode of VCRs, this recorder has eight different recording modes. Select a recording mode according to the time and picture quality you need. For example, if picture quality is your top priority, select the High Quality mode (HQ). If recording time is your priority, Super Extended Play mode (SEP) can be a possible choice. Note that the recording time in the following table is an approximate guide.

**Press REC MODE repeatedly to switch the recording modes.**

I want to record with the best possible picture quality, so I'll select HQ.



Recording mode	Recording time (minute)
HQ (High quality)	60
HSP 	90
SP (Standard mode)	120
LSP 	150
LP 	180
EP 	240
SLP 	360
SEP (Long duration)	480

### Note

Situations below may cause slight inaccuracies with the recording time.

- Recording a program with poor reception, or a program or video source of low picture quality
- Recording on a disc that has already been edited
- Recording only a still picture or just sound

## Recording a stereo/SAP program

The recorder can receive and record stereo/SAP programs.

### Stereo programs



When a stereo program is received, the "STEREO" indicator lights up in the front panel display. If there is noise in the stereo program, press AUDIO repeatedly until the "MONO" indicator disappears from the TV screen. The sound will be recorded in monaural but with less noise.

### SAP (Second Audio Program)

When a SAP is received, the "SAP" indicator lights up in the front panel display. To record only SAP sound, set "Tuner Audio" of "Audio" to "SAP" in the "Setup" display (page 78).

## Unrecordable pictures

Pictures with copy protection cannot be recorded on this recorder. Recording stops when a copy guard signal is detected.

Copy control signals	Recordable discs
Copy-Free	
Copy-Once	 Ver.1.1 with CPRM* Ver.1.2 with CPRM*
Copy-Never	None

\* The recorded disc can be played only on CPRM compatible equipment (page 29).

## Recording Without the Timer

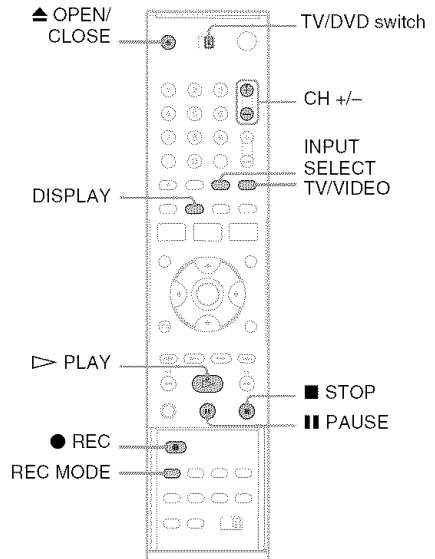

- 1 Press **▲ OPEN/CLOSE**, and place a recordable disc on the disc tray.

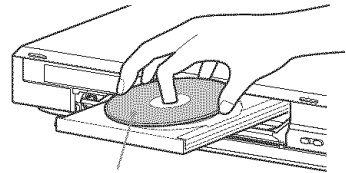

Recording side facing down

- 2 Press **▲ OPEN/CLOSE** to close the disc tray.  
 Wait until "LOAD" disappears from the front panel display.  
 Unused DVD-RWs are formatted in VR mode automatically. To format in Video mode, see page 81.
- 3 Press **CH +/-** or **INPUT SELECT** repeatedly to select the channel or input source you want to record.

#### 4 Press **REC MODE** repeatedly to select the recording mode.

The display changes on the TV screen as follows:

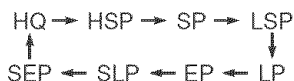

For details about the recording mode, see page 45.

#### 5 Press **REC**.

Recording starts.

Recording continues until you stop the recording or the disc is full.

#### To stop recording

Press **STOP**.

Note that it may take a few seconds for the recorder to stop recording.

#### To pause recording

Press **PAUSE**.

To restart recording, press **PAUSE** again.

#### To watch another TV program while recording

1 Slide the TV/DVD switch to TV.

2 Press TV/VIDEO to set the TV to the TV input.

3 Select another channel on the TV.

#### Hints

- To play a disc recorded with this recorder on other equipment, finalize the disc (page 67).
- You can use the number buttons for channel selection. Enter the channel number, and press SET.
- You can select a video source from the LINE 1 IN or LINE 2 IN jacks using the INPUT SELECT button.
- You can turn off the TV during recording. If you are using a cable box or a satellite receiver, make sure to leave it on.

#### Notes

- Recording may not start immediately after **REC** is pressed.
- You cannot change the recording mode during recording or recording pause.
- If there is a power failure, the program you are recording may be erased.
- You cannot change the channel or input source during recording.

## Recording using the Quick Timer (One-touch Timer Recording)

You can set the recorder to record in 30-minute increments.

#### Press **REC** repeatedly to set the duration.

Each press increases the time by 30 minutes, up to eight hours (12 hours for DVD+R DL (Double Layer) discs).

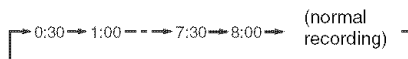

“⊕” and “OTR” light up, and the remaining recording time appears in the front panel display.

When the counter reaches “0:00,” the recorder stops recording and turns off.

#### To cancel the Quick Timer

Press **REC** repeatedly until the counter appears in the front panel display. The recorder returns to normal recording mode.

#### To stop recording.

Press **STOP** twice.

Note that it may take a few seconds for the recorder to stop recording.

## Checking the disc status while recording

You can check the recording information such as recording time or disc type.

#### Press **DISPLAY** during recording.

The information display appears.

Press the button repeatedly to change the display (page 43).

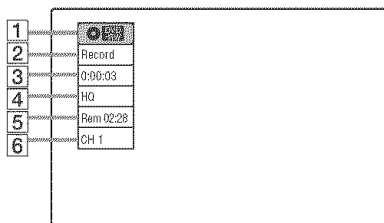

1 Disc type

2 Recording status

- 3 Recording time
- 4 Recording mode
- 5 Remaining disc space
- 6 Channel or input source

**Hint**

You can view the information also in the front panel display. Press TIME/TEXT repeatedly to change the display. Note that TIME/TEXT does not work during One-touch Timer Recording.

## Creating chapters in a title

The recorder will automatically divide a recording (a title) into chapters by inserting chapter marks at 5 or 15-minute intervals during recording. Select the interval, "5 Min" (default) or "15 Min" in "DVD Auto Chapter" of "Features" in the "Setup" display (page 80).

If you do not want to divide titles, select "Off."

**Hint**

You can create chapters manually when playing DVD+RWs or DVD-RWs (VR mode) (page 59).

## Timer Recording



You can set the timer for a total of 12 programs, up to one month in advance.

Note that the maximum continuous recording time for a single title is 12 hours. Contents beyond this time will not be recorded.

Follow the steps below to set each timer recording item.

**Note**

Do not operate your cable box or satellite receiver just before or during a timer recording. This may prevent the accurate recording of a program.

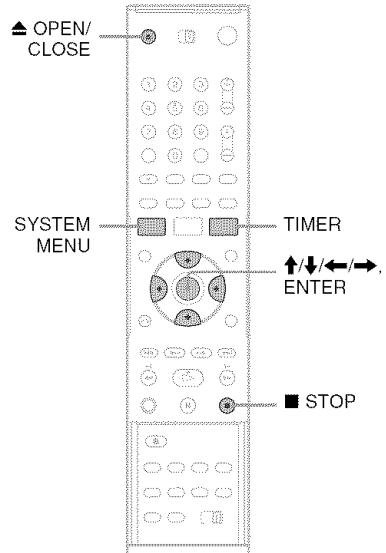

- 1 Press **▲ OPEN/CLOSE**, and place a recordable disc on the disc tray.

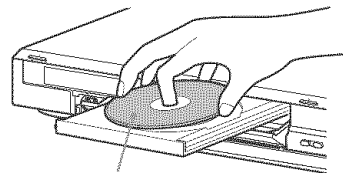

Recording side facing down



## 2 Press $\blacktriangle$ OPEN/CLOSE to close the disc tray.

Wait until "LOAD" disappears from the front panel display.

Unused DVD-RWs are formatted in VR mode automatically. To format in Video mode, see page 81.

## 3 Press TIMER.

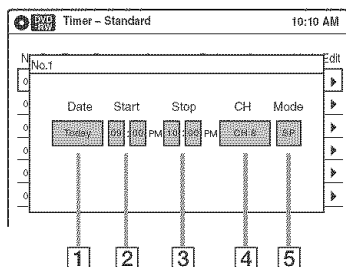

## 4 Select an item using $\leftarrow/\rightarrow$ and adjust using $\uparrow/\downarrow$ .

- 1 "Date": Sets the date using  $\uparrow$ .  
To record the same program every day or the same day every week, press  $\downarrow$ .  
The item changes as follows:  
Today  $\leftrightarrow$  Sun-Sat (Sunday to Saturday)  
 $\leftrightarrow$  Mon-Sat (Monday to Saturday)  $\leftrightarrow$   
Mon-Fri (Monday to Friday)  $\leftrightarrow$  Sun (every Sunday)  $\leftrightarrow$  Mon (every Monday)  
 $\leftrightarrow$  ...  $\leftrightarrow$  Sat (every Saturday)  $\leftrightarrow$   
1 month later  $\leftrightarrow$  ...  $\leftrightarrow$  Today
- 2 "Start": Sets the start time.
- 3 "Stop": Sets the stop time.
- 4 "CH": Selects the channel or input source.
- 5 "Mode": Selects the recording mode (page 45).  
To use the Rec Mode Adjust function (page 49), select "AUTO."

If you make a mistake, select the item and change the setting.

## 5 Press ENTER.

The Timer List menu (page 52) appears.

The  $\odot$  indicator lights up in the front panel display, and the recorder is ready to start recording.

If the  $\odot$  indicator flashes in the front panel display, check that a recordable disc is inserted and that there is enough disc space for the recording.

There is no need to turn off the recorder before the timer recording starts.

If timer settings overlap, a message appears. To change or cancel a timer recording, select "Edit" from the Timer List (page 52).

## 6 Press SYSTEM MENU to turn off the menu.

### To stop recording

Press  $\blacksquare$  STOP twice.

Note that it may take a few seconds for the recorder to stop recording.

### If timer settings overlap

The program that starts first has priority and the second program starts recording only after the first program has finished. If the programs start at the same time, the program listed first in the menu has priority. If the end time of one setting and the start time of another timer setting is the same, the beginning of the program that starts later will be cut.

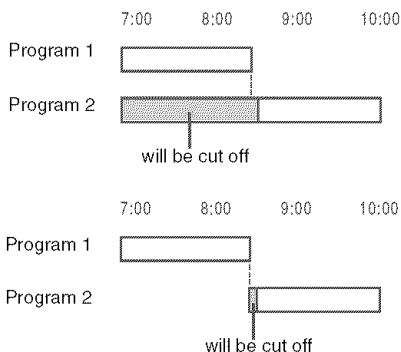

### To change or cancel timer recording

See "Changing or Canceling Timer Settings (Timer List)" on page 52.

### To use the Rec Mode Adjust function

If the remaining disc space is not enough for the current recording, the recorder automatically

adjusts the recording mode. Select "AUTO" for "Mode" when setting the timer.

#### Hints

- You can play the recorded program by selecting the program title in the Title List menu.
- You can also turn on the timer programming menu from the System Menu. Press SYSTEM MENU to select "Timer," and select "Timer-Standard."

#### Notes

- To record a cable or satellite program, turn on the cable box or satellite receiver and select the program you want to record. Leave the cable box or satellite receiver turned on until the recorder finishes recording.
- Even when correctly set, the program may not be recorded if another recording is underway, or other prioritized timer setting overlaps.
- Before the timer recording starts, "TIMER REC" flashes in the front panel display.
- The recorder automatically turns off when a timer recording finishes, even if the recording started with the recorder turned on.
- The recorder does not record programs with Copy-Never signals. Such recordings stop after a few seconds.

## Recording From Connected Equipment With a Timer (Synchro Rec)



You can set the recorder to automatically record programs from connected equipment that has a timer function (such as a satellite tuner). Connect the equipment to the LINE 1 IN jacks on the rear of the recorder (page 27).

When the connected equipment turns on, the recorder starts recording a program from the LINE 1 IN jacks.

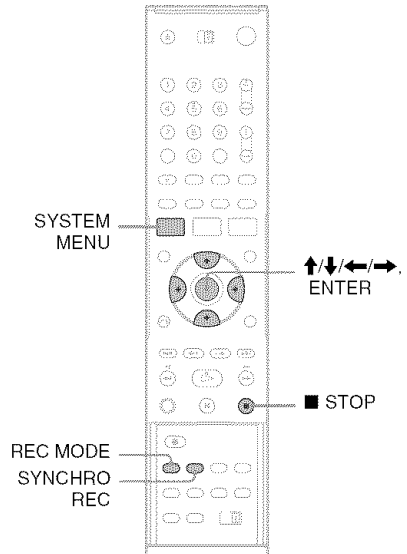

**1** Insert a recordable disc.

**2** Select the line input audio.

Set "Line Audio Input" of "Audio" to "Stereo" or "Main/Sub" in the "Setup" display (page 80).

### 3 Press REC MODE repeatedly to select the recording mode.

The display changes on the TV screen as follows:

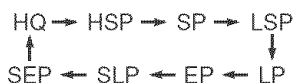

For details about the recording mode, see page 45.

### 4 Set the timer on the connected equipment to the time you want to record, and turn it off.

### 5 Press SYNCHRO REC.

The SYNCHRO REC indicator lights up on the front panel and the recorder stands by for Synchro-Rec.

The recorder starts recording when a signal is received from the connected equipment.

When the connected equipment turns off, the recording stops and the recorder turns off.

#### To stop recording

Press ■ STOP twice.

#### To cancel a Synchro-Rec standby

Press SYNCHRO REC before recording starts. The SYNCHRO REC indicator on the recorder turns off.

If you press SYNCHRO REC during Synchro-Rec, the recording stops, the SYNCHRO REC indicator turns off, and the recorder turns off.

### If the timer settings of a Synchro-Recording and another timer recording overlap

Regardless of whether or not the program is a Synchro-Rec program, the program that starts first has priority. The recorder starts recording the second program about ten seconds after the first program has finished. If the end time of one setting and the start time of another timer setting is the same, the beginning of the program that starts later will be cut.

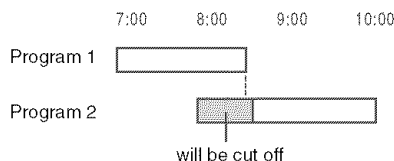

#### Notes

- The recorder starts recording only after detecting the video signal from the connected equipment. The beginning of the program may not be recorded regardless of whether or not the recorder's power is on or off.
- To use the connected equipment during Synchro-Rec standby, cancel the standby mode by pressing SYNCHRO REC. To return to standby mode again, be sure to turn off the equipment and press SYNCHRO REC, before Synchro-Rec starts.
- The Synchro-Rec function does not work with some tuners. For details, see the tuner's operating instructions.
- During Synchro-Rec standby, the Auto Clock Set function does not work (page 75).
- After a recording has finished, the recorder enters the Synchro-Rec standby mode until the SYNCHRO REC indicator turns off.
- If Synchro-Rec starts with the recorder turned on, the recorder will turn off when the recording ends.
- The recorder does not record programs with Copy-Never signals. Such recordings stop after a few seconds.

# Changing or Canceling Timer Settings (Timer List)



You can change or cancel timer settings using the Timer List menu.

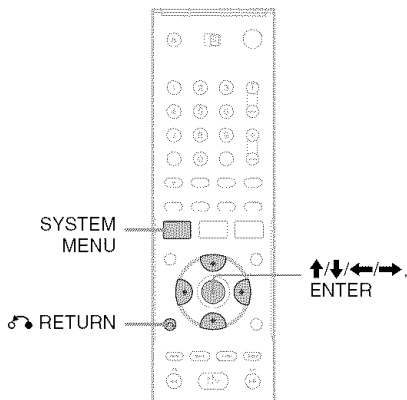

- 1** Press **SYSTEM MENU**.  
The System Menu appears.
- 2** Select **"Timer,"** and press **ENTER**.
- 3** Select **"Timer List,"** and press **ENTER**.

No	Date	Start	Stop	CH	Mode	Edit
01	04/15	09:00PM	10:00PM	CH8	SP	▶
02	04/30	09:15PM	09:45PM	CH11	SP	▶
03	--:--	--:--	--:--	----	---	▶
04	--:--	--:--	--:--	----	---	▶
05	--:--	--:--	--:--	----	---	▶
06	--:--	--:--	--:--	----	---	▶

Timer information displays the recording date, time, recording mode, etc.  
If there are more than six timer settings, press **↓** to display the next page.

- 4** Select the timer setting you want to change or cancel, and press **ENTER**.

The sub-menu appears.

No	Date	Start	Stop	CH	Mode	Edit
01	04/15	09:00PM	10:00PM	CH8	Edit	▶
02	04/30	09:15PM	09:45PM	CH11	Del	▶
03	--:--	--:--	--:--	----	---	▶
04	--:--	--:--	--:--	----	---	▶
05	--:--	--:--	--:--	----	---	▶
06	--:--	--:--	--:--	----	---	▶

- 5** Select one of the options, and press **ENTER**.

"Edit": Changes the timer setting.

Select an item using **←/→** and adjust using **↑/↓**. Press **ENTER**.

No	Date	Start	Stop	CH	Mode	Edit
No.1	04/15	09:00 PM	10:00 PM	CH 8	SP	▶
02	--:--	--:--	--:--	----	---	▶
03	--:--	--:--	--:--	----	---	▶
04	--:--	--:--	--:--	----	---	▶
05	--:--	--:--	--:--	----	---	▶
06	--:--	--:--	--:--	----	---	▶

"Del": Erases the timer setting.

Select **"OK"** and press **ENTER** when asked for confirmation.

No	Date	Start	Stop	CH	Mode	Edit
No.1	04/15	09:00 PM	10:00 PM	CH 8	SP	▶
02	--:--	--:--	--:--	----	---	▶
03	--:--	--:--	--:--	----	---	▶
04	--:--	--:--	--:--	----	---	▶
05	--:--	--:--	--:--	----	---	▶
06	--:--	--:--	--:--	----	---	▶

- 6** Press **SYSTEM MENU** to turn off the Timer List.

**To return to the previous display**

Press **↶ RETURN**.

## Notes

- Even when correctly set, the program may not be recorded if another recording is underway, or other prioritized timer setting overlaps. For priority, see page 49.

- You cannot change the timer settings for a recording currently underway.

## Recording From Connected Equipment Without a Timer



You can record from a connected VCR or similar device. For connection details, see “Connecting a VCR or Similar Device” on page 26.

Use the DV IN jack on the front panel if the equipment has a DV/D8 output jack (i.LINK jack).

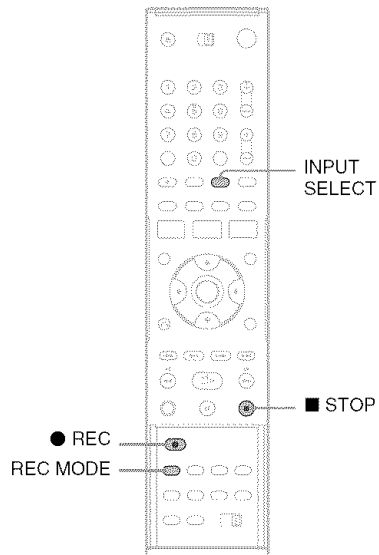

- 1** Insert a recordable disc.
- 2** Press **INPUT SELECT** repeatedly to select an input source according to the connection you made.

The front panel display changes as follows:

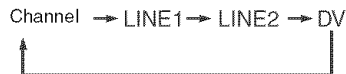

### 3 Press REC MODE repeatedly to select the recording mode.

The display changes on the TV screen as follows:

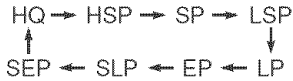

For details about the recording mode, see page 45.

### 4 Select the line input audio.

Set “Line Audio Input” of “Audio” to “Stereo” or “Main/Sub” in the “Setup” display (page 80).

### 5 Insert the source tape into the connected equipment and set to playback pause.

### 6 Press ● REC on this recorder and the pause or play button on the connected equipment at the same time.

Recording starts.

To stop recording, press ■ STOP on this recorder.

---

## If you connect a digital video camera with a DV IN jack

See “Dubbing from a DV/D8 Format Tape to a DVD” (page 70) for an explanation of how to record from the DV IN jack.

### Notes

- A video game image may not be recorded clearly.
- The recorder does not record programs with Copy-Never signals. Such recordings stop after a few seconds.
- During recording or recording pause, you cannot change the recording mode.
- You cannot change the channel or input source during recording.

## Before Editing

This recorder offers various edit options for various disc types. Before you edit, check the disc type in the front panel display, and select the option available for your disc (page 28).

### Note

You may lose the edited contents if you remove the disc or a timer recording starts while editing.

## Edit options for DVD+RWs/DVD-RWs (Video mode)/DVD+Rs/DVD-Rs



You can perform simple edits. Since Video mode titles are actual recordings on the disc, you cannot undo any edits you make. The edit functions available for Video mode titles are:

- Renaming a title (page 60).
- Erasing a title (page 56).
- Setting protection against erasure (DVD+RWs only) (page 56).
- Dividing a title (DVD+RWs only) (page 58).

### Notes

- Once the disc is finalized, you cannot edit or record on the disc (except for DVD+RWs).
- If a message appears and indicates that the disc's control information is full, erase unnecessary titles.

## Edit options for DVD-RWs (VR mode)



You can enjoy advanced edit functions. First you have two options for a DVD-RW (VR mode): editing either the original recording (called the “original”), or the playback information created from the original (called a “Playlist”). Since each is different in nature and offers different merits, read the following and select the one that better suits your needs.

## To edit original titles

Edits made to the original titles are final. If you plan to retain an unaltered original recording, create and edit a Playlist (see below). The edit functions available for original titles are:

- Renaming a title (page 60).
- Erasing a title (page 56).
- Erasing a chapter (page 57).
- Setting protection against erasure (page 56).
- Erasing a section of a title (A-B Erase) (page 57).
- Dividing a title (page 58).

## To create and edit Playlist titles

A Playlist is a group of Playlist titles created from the original title for editing purposes. When you create a Playlist, only the control information necessary for playback, such as the playback order, is stored on the disc. Since the original titles are left unaltered, Playlist titles can be re-edited. If you erase an original title used in a Playlist, that Playlist is also erased.

Example: You have recorded the final few matches of a soccer tournament on a DVD-RW (VR mode). You want to create a digest with the goal scenes and other highlights, but you also want to keep the original recording.

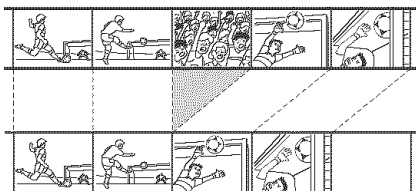

In this case, you can compile highlight scenes as a Playlist title. You can even rearrange the scene order within the Playlist title. See “Editing a Playlist” on page 62.

The advanced edit functions available for Playlist titles are:

- Renaming a title (page 60).
- Erasing a title (page 56).
- Erasing a chapter (page 57).
- Erasing a section of a title (A-B Erase) (page 57).
- Editing a Playlist scene (page 62).
- Dividing a title (page 58).
- Combining titles (page 63).

## Hint

You can switch the Title List to show original or Playlist. While the Title List menu is turned on, press ORIGINAL/PLAYLIST repeatedly.

## Notes

- You cannot protect Playlist titles.
- If a message appears and indicates that the disc's control information is full, erase unnecessary titles.
- Once the disc is finalized, you cannot create or edit Playlist titles on the disc.

# Editing a Title



This section explains the basic edit functions. Note that editing is irreversible. To edit a DVD-RW (VR mode) without changing the original recordings, create a Playlist title (page 61).

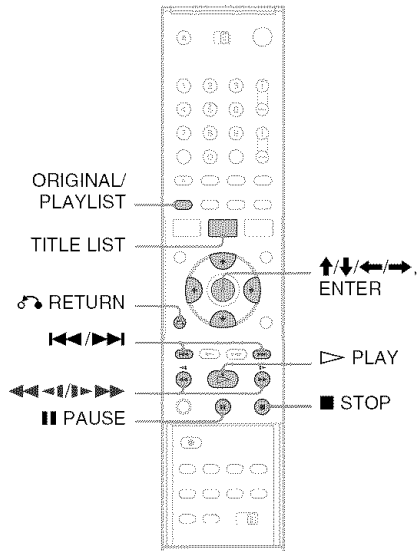

## 1 Press TITLE LIST.

When editing a DVD-RW (VR mode), press ORIGINAL/PLAYLIST to switch to the “Title List (Original),” if necessary.

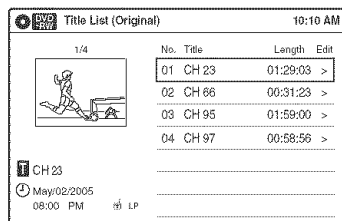

## 2 Select a title, and press ENTER.

The sub-menu appears.



### 3 Select an option, and press ENTER.

You can select from the following:

“Title Erase”: Erases the selected title. Select “OK” when asked for confirmation.

“Chapter Erase”<sup>\*1</sup>: Allows you to select a chapter in the title and erase it (see below).

“Protect”<sup>\*2</sup>: Protects the title. Select “On” when the Protection display appears. “

“Title Name”: Allows you to rename the title (page 60).

“A-B Erase”<sup>\*1</sup>: Erases a section of the title (see below).

“Divide Title”<sup>\*2</sup>: Divides a title into two (page 58).

<sup>\*1</sup> DVD-RWs (VR mode) only

<sup>\*2</sup> DVD+RWs and DVD-RWs (VR mode) only

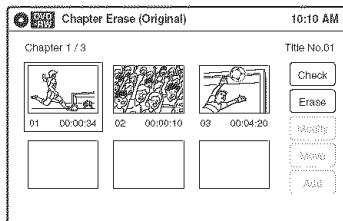

### 4 Select the chapter you want to erase, and press ENTER.

“Check” is selected. To preview the chapter, press ENTER. When playback finishes or when you press  RETURN, the display returns to “Chapter Erase (Original).”

### 5 Select “Erase,” and press ENTER.

The display asks for confirmation.

### 6 Select “OK,” and press ENTER.

The selected chapter is erased from the title. To erase other chapters, repeat from step 4.

#### Hints

- You can also rename a disc (page 66).
- For a DVD+R or DVD-R, erasing titles does not free up disc space. For DVD+RWs and DVD-RWs (Video mode), you can free up space only by erasing the last title.

#### Notes

- When editing a DVD-RW (Video mode), DVD+R, or DVD-R, finish all editing before finalizing the disc. You cannot edit a finalized disc.
- You cannot erase protected titles or erase chapters from a protected title.
- If you erase an original title used in a Playlist, that Playlist is also erased.

## Erasing a chapter (Chapter Erase)



You can select a chapter within a title and erase it. Note that erasing chapters from original titles cannot be undone.

### 1 Press TITLE LIST.

Press ORIGINAL/PLAYLIST to switch to the “Title List (Original),” if necessary.

### 2 Select a title, and press ENTER.

The sub-menu appears.

### 3 Select “Chapter Erase,” and press ENTER.

The display for erasing chapters appears.

#### Hint

You can also erase chapters from a Playlist (page 62).

#### Note

If you erase an original title used in a Playlist, that Playlist is also erased.

## Erasing a section of a title (A-B Erase)



You can select a section (scene) within a title and erase it. Note that erasing scenes from original titles cannot be undone.

### 1 Press TITLE LIST.

Press ORIGINAL/PLAYLIST to switch to the “Title List (Original),” if necessary.

### 2 Select a title, and press ENTER.

The sub-menu appears.

### 3 Select “A-B Erase,” and press ENTER.

The display for setting point A and B appears.

“Start” is selected.

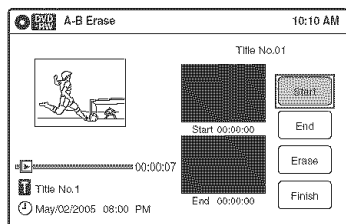

#### 4 Press ENTER at the start point of the section to be erased (point A).

You can use  $\blacktriangleright$  PLAY,  $\blacktriangleleft\blacktriangleleft\blacktriangleleft/\blacktriangleright\blacktriangleright\blacktriangleright$ ,  $\blacksquare$  STOP, and  $\parallel$  PAUSE to find the point. “End” is selected.

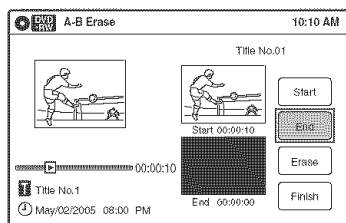

#### 5 Press ENTER at the end point of the section (point B).

“Erase” is selected.

To reset the start or end point, select “Start” or “End” and repeat from step 4 or 5.

#### 6 Press ENTER.

The display asks for confirmation.

#### 7 Select “OK,” and press ENTER.

The scene is erased.

To continue, repeat from step 4.

To finish, select “Finish,” and press ENTER.

#### Hints

- A chapter mark is inserted after the scene was erased. The chapter mark divides the title into separate chapters on either side of the mark.
- You can also erase a section of a Playlist title (page 62).

#### Notes

- Images or sound may be momentarily interrupted at the point where you erase a section of a title.
- Sections shorter than five seconds may not be erased.
- The start and end points of a title may be different from what you have set.
- The total playing time of the title does not change even if a scene was erased.

- If you erase an original title used in a Playlist, that Playlist is also erased.

## Dividing a title into two (Divide Title)



You can divide a title into two. Note that dividing original titles cannot be undone.

#### 1 Press TITLE LIST.

When editing a DVD-RW(VR mode), press ORIGINAL/PLAYLIST to switch to the “Title List (Original),” if necessary.

#### 2 Select a title, and press ENTER.

The sub-menu appears.

#### 3 Select “Divide Title,” and press ENTER.

The display for setting the dividing point appears.

“Point” is selected.

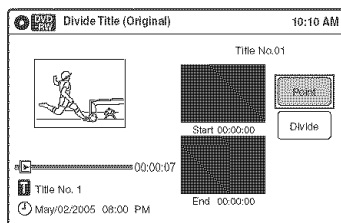

#### 4 Press ENTER at the point where you want to divide the title.

You can use  $\blacktriangleright$  PLAY,  $\blacktriangleleft\blacktriangleleft\blacktriangleleft/\blacktriangleright\blacktriangleright\blacktriangleright$ ,  $\blacksquare$  STOP, and  $\parallel$  PAUSE to find the point.

“Divide” is selected.

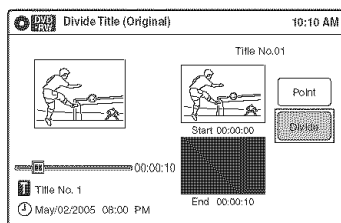

#### 5 Press ENTER.

The display asks for confirmation.

To reset the dividing point, select “No” and press ENTER, then repeat from step 4.

## 6 Select “Yes,” and press ENTER.

The display asks whether to use the same title name as before.

To use the same name, select “Yes” and press ENTER to finish.

## 7 Select “No,” and press ENTER.

The display asks whether to rename the title.

## 8 Select “Yes,” and press ENTER.

The “Title Name” display appears.

## 9 Follow steps 4 to 6 of “Changing the Name of a Title” (page 60) to complete renaming.

The divided title appears in the Title List with the new name.

### Hint

You can also divide a Playlist title (page 62).

## Creating chapters manually



You can manually insert a chapter mark at any point you like during playback.

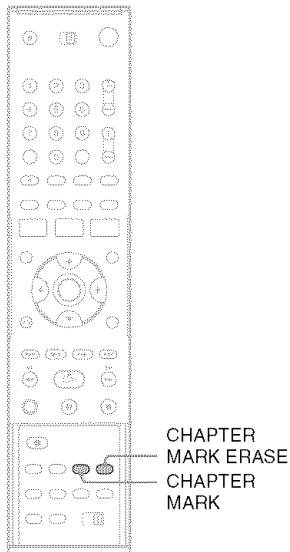

## Press CHAPTER MARK at the point where you want to divide the title into chapters.

Each time you press the button, “Marking...” appears on the screen, and the scenes before and after the mark become separate chapters.

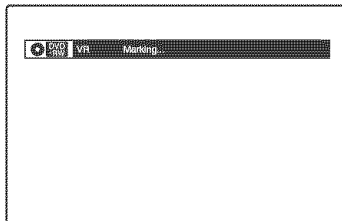

## To erase chapter marks

You can combine two chapters by erasing the chapter mark during playback.

During playback, press CHAPTER MARK ERASE.

The current chapter combines with the previous chapter.

### Notes

- If a message appears and indicates that no more chapter marks can be added, you may not be able to record or edit.
- You cannot add or erase chapter marks on protected titles or discs.

# Changing the Name of a Title



You can enter a title name of up to 32 characters. Since the displayed number of characters is limited, their appearance in menus such as Title List may be different. When the display for entering characters appears, follow the steps below.

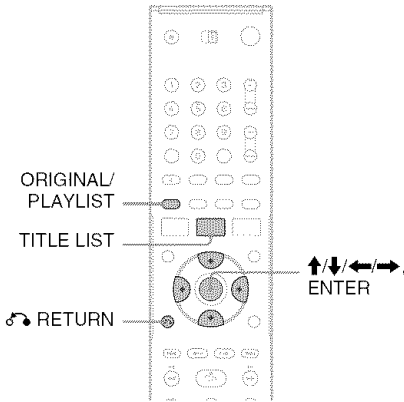

## 1 Press TITLE LIST.

When editing a DVD-RW (VR mode), press ORIGINAL/PLAYLIST to switch to the "Title List (Original)," if necessary.

## 2 Select a title, and press ENTER.

The sub-menu appears.

## 3 Select "Title Name," and press ENTER.

The "Title Name" display appears.

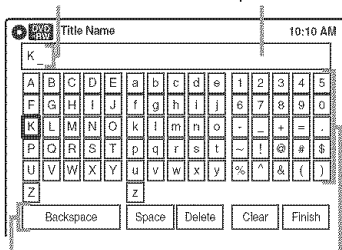

Setting buttons

Character palette

## 4 Select the character you want to enter using $\uparrow/\downarrow/\leftarrow/\rightarrow$ , and press ENTER.

The selected character appears in the input row.

You can only enter characters and symbols that are displayed.

- To change the cursor position, select the input row using  $\uparrow$ , and press  $\leftarrow/\rightarrow$ .
- To erase a character, select either of the following setting buttons and press ENTER.
  - "Backspace": Erases the character to the left of the cursor.
  - "Delete": Erases the character at the cursor position.
  - "Clear": Erases all the characters in the input row.
- To insert a space, move the cursor to the desired position, select "Space," and press ENTER.
- To insert a character, move the cursor to the desired position, select the character, and press ENTER.

## 5 Repeat step 4 to enter the remaining characters.

To return to the Title List without renaming the title, press  $\hookrightarrow$  RETURN.

## 6 Select "Finish," and press ENTER.

### Hint

You can also rename a disc (page 66). Follow steps 4 to 6 above when the "Disc Name" display appears.



## Playing a Playlist title

- 1 Press **TITLE LIST**.
- 2 Press **ORIGINAL/PLAYLIST** to switch to the "Playlist" Title List.
- 3 Select a Playlist title, and press **ENTER**.  
The sub-menu appears.
- 4 Select "Play," and press **ENTER**.

### Hint

When a Playlist title is created, the start and end points will become chapter marks, and each scene will become a chapter.

### Notes

- The picture may pause when an edited scene is played.
- The start and end points in a title may be different from what you have set.

## Editing a Playlist



You can edit Playlist titles or scenes within them, without changing the actual recordings.

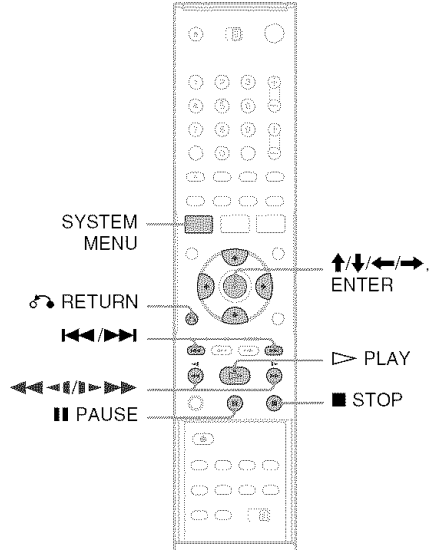

- 1 Press **SYSTEM MENU** while the recorder is in stop mode.

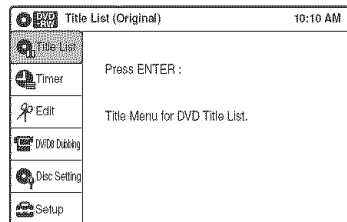

- 2 Select "Edit," and press **ENTER**.

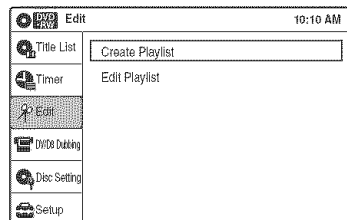

- 3 Select “Edit Playlist,” and press ENTER.**  
The “Playlist” Title List appears.

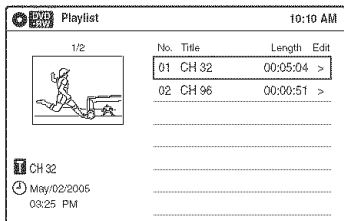

- 4 Select a Playlist title, and press ENTER.**  
The sub-menu appears.

- 5 Select an option, and press ENTER.**

Select from the following options. For details, see the pages in parentheses.

“Title Erase”: Erases the title. Select “OK” when asked for confirmation.

“Chapter Erase”: Allows you to select chapters in the Playlist title to erase (page 57).

“Title Name”: Allows you to rename the title (page 60).

“A-B Erase”: Allows you to select sections in the title to erase (page 57).

“Edit Scene”: Allows you to re-edit scenes in the Playlist title. Go to step 6.

“Divide Title”: Divides the title in two at a desired point (page 58).

“Combine Titles”: Allows you to combine two titles into one (page 63).

- 6 Select “Edit Scene,” and press ENTER.**  
The display for editing scenes appears.

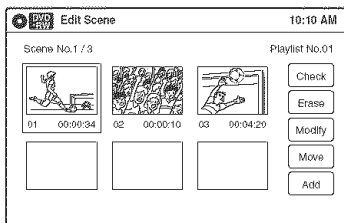

“Check”: Allows you to preview a scene.

Starts playback of the selected scene when you press ENTER. The display returns to the “Edit Scene” display when the playback finishes or when you press RETURN.

“Erase”: Erases a scene (page 64).

“Modify”: Allows you to change the start and end point of a scene (page 64).

“Move”: Allows you to change scene order (page 65).

“Add”: Allows you to add other scenes before a selected scene (page 65).

### To return to the previous display

Press RETURN.

### To turn off the display

Press SYSTEM MENU.

### Hint

The Resume Play function will work for scene playback.

### Note

Once the disc is finalized, you cannot edit Playlist titles on the disc.

## Combining two titles into one (Combine Titles)



You can select a Playlist title and combine it with another Playlist title.

- 1 Follow steps 1 to 4 of “Editing a Playlist” (page 62) to select a Playlist title.**

The sub-menu appears.

- 2 Select “Combine Titles,” and press ENTER.**

The next title below is also selected.

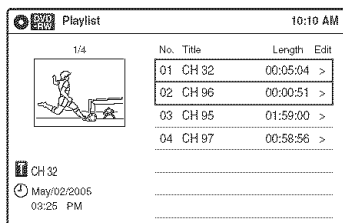

- 3 Select a Playlist title to be combined.**

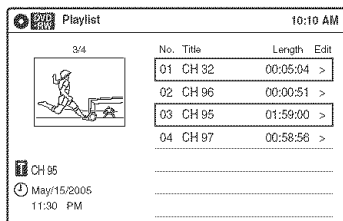

#### 4 Press ENTER.

The display asks for confirmation.

#### 5 Select “Yes,” and press ENTER.

The display asks whether to use the same title name as before.

To use the same name, select “Yes” and press ENTER to finish.

#### 6 Select “No,” and press ENTER.

The display asks whether to rename the title.

#### 7 Select “Yes,” and press ENTER.

The “Title Name” display appears.

#### 8 Follow steps 4 to 6 of “Changing the Name of a Title” (page 60) to complete renaming.

The two Playlist titles become one Playlist title with the new name.

---

### Erasing a scene (Erase)

**-RWVR**

You can erase a selected scene.

#### 1 Follow steps 1 to 6 of “Editing a Playlist” (page 62).

#### 2 Select a scene in the “Edit Scene” display and press ENTER.

#### 3 Select “Erase,” and press ENTER.

The display asks for confirmation.

#### 4 Select “OK,” and press ENTER.

The selected scene is erased.

To erase other scenes, repeat from step 2.

---

### Modifying a scene (Modify)

**-RWVR**

You can change the start and end point of the selected scene.

#### 1 Follow steps 1 to 6 of “Editing a Playlist” (page 62).

#### 2 Select a scene in the “Edit Scene” display and press ENTER.

#### 3 Select “Modify,” and press ENTER.

“Start” is selected.

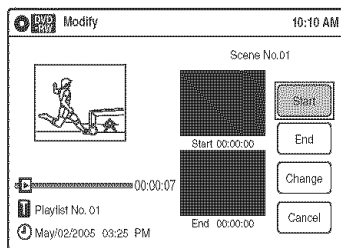

#### 4 Press ENTER at the start point.

You can use PLAY, STOP, and PAUSE to find the point.

“End” is selected.

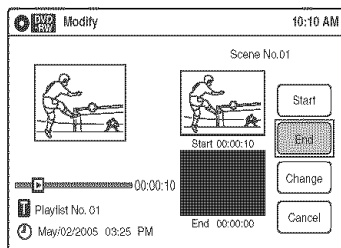

#### 5 Press ENTER at the end point.

“Change” is selected.

To reset the start or end point, select “Start” or “End” and repeat step 4 or 5.

#### 6 Press ENTER.

The display returns to the “Edit Scene” display.

The re-selected section is captured as a scene. To modify other scenes, repeat from step 2.

---

#### To cancel modifying

Select “Cancel,” and press ENTER.

#### Note

The start and end point of a scene may be different from what you have set.



## Moving a scene (Move)



You can change the scene order within the Playlist title.

- 1 Follow steps 1 to 6 of “Editing a Playlist” (page 62).
- 2 Select a scene in the “Edit Scene” display and press ENTER.
- 3 Select “Move,” and press ENTER.

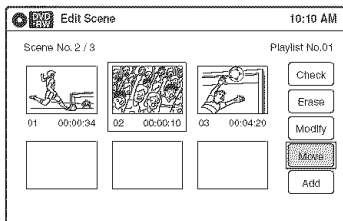

- 4 Select a new location using  $\leftarrow/\rightarrow$ , and press ENTER.

The selected scene moves to the new location. To move other scenes, repeat from step 2.

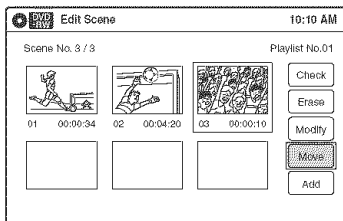

## Adding a scene (Add)



You can add a scene before the selected scene.

- 1 Follow steps 1 to 6 of “Editing a Playlist” (page 62).
- 2 Select a scene in the “Edit Scene” display, and press ENTER.

- 3 Select “Add,” and press ENTER. “Start” is selected.

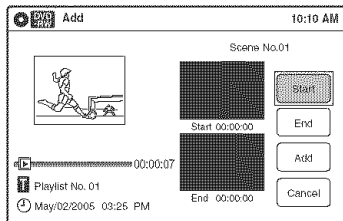

- 4 Press ENTER at the start point.

You can use  $\triangleright$  PLAY,  $\lll/\lll/\lll$ ,  $\lll/\triangleright/\triangleright$ ,  $\blacksquare$  STOP, and  $\parallel$  PAUSE to find the point.

“End” is selected.

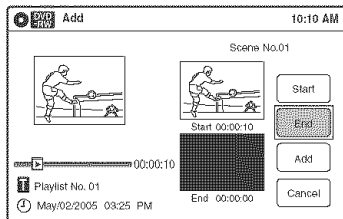

- 5 Press ENTER at the end point.

“Add” is selected.

To reset the start or end point, select “Start” or “End” and repeat step 4 or 5.

- 6 Press ENTER.

The display returns to the “Edit Scene” display.

The selected section is added before the selected scene.

To add other scenes, repeat from step 2.

### To cancel adding

Select “Cancel,” and press ENTER.

### Note

The start and end point of a scene may be different from what you have set.

# Formatting/Renaming/ Protecting a Disc



The “Disc Setting” display allows you to check the disc information or change the disc name. Depending on the disc type, you can also format or set protection.

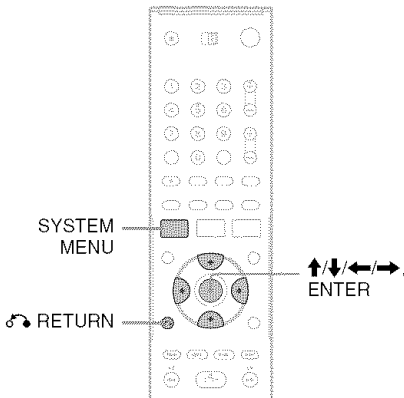

- 1 Press **SYSTEM MENU** while the recorder is in stop mode.
- 2 Select “Disc Setting,” and press **ENTER**. The “Disc Setting” display appears.

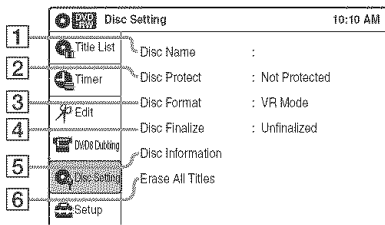

- 3 Select an option, and press **ENTER**.
  - 1 “Disc Name”: Allows you to rename a disc.  
For details on how to enter characters, see page 60.
  - 2 “Disc Protect” (DVD-RWs (VR mode) only): Protects all titles on the disc when “Protected” is selected. To cancel the protection, select “Not Protected.”

- 3 “Disc Format” (DVD+RWs/DVD-RWs only): Erases all contents of the disc, including protected titles, and makes a blank disc.  
For DVD-RWs, select a recording format (“VR Mode” or “Video Mode”) according to your needs.
- 4 “Disc Finalize”: Finalizes a disc. See page 67 for details.
- 5 “Disc Information”: Displays the following information.
  - Disc name
  - Disc type (and recording format for a DVD-RW (VR mode))
  - Total number of titles
  - Protect setting
  - The oldest and most recent recording date
  - The total available recording time in each recording mode

Disc Information		10:10 AM	
Disc Name	Disc 1		
Media	DVD-RW	Format	VR Mode
Title No.	Original 6 / Playlist 1		
Protected	Not Protected		
Date	04/05/2005 - 04/30/2005		
Remainder	HO : 0H 57M	HSP : 1H 26M	SP : 1H 55M
	LSP : 2H 23M	LP : 2H 52M	EP : 3H 50M
	SLP : 5H 46M	SEP : 7H 40M	4:44.7GB

- 6 “Erase All Titles” (DVD+RWs/DVD-RWs only): Erases all titles on the disc (except protected titles). Select “OK” when asked for confirmation.  
For DVD-RWs (VR mode), Playlist titles created with protected titles are also erased.

**To return to the previous display**  
Press **RETURN**.

- Hints**
- You can set protection for individual titles (page 56).
  - By reformatting, you can change the recording format on DVD-RWs, or record again on DVD-RWs (Video mode) that have been finalized.

**Note**  
You can label a disc using up to 32 characters; however, the name may not display on other DVD equipment.

# Finalizing a Disc (Preparing a Disc for Playback on Other Equipment)



Finalizing is necessary in order to play discs recorded with this recorder on other DVD equipment.

When you finalize a DVD+RW/DVD-RW (Video mode)/DVD+R/DVD-R, a DVD menu will be automatically created, which can be displayed on other DVD equipment.

Before finalizing, check the differences between the disc types in the table below.

## Differences between the disc types



Discs are automatically finalized when removed from the recorder. If you want to record on it again, reformat the disc (page 66). Note however, that reformatting a disc erases all its contents.



Finalizing is unnecessary when playing a disc on VR format compatible equipment. Even if your other DVD equipment is VR format compatible, you may need to finalize the disc, especially if the recording time is short. After finalizing, you cannot edit or record on the disc. If you want to edit or record on it again, unfinalize or reformat the disc (page 66). Note however, that reformatting a disc erases all its contents.



Finalizing is necessary in order to play on equipment other than this recorder. After finalizing, you cannot edit or record on the disc. If you want to edit or record on it again, unfinalize or reformat the disc (page 66). Note however, that reformatting a disc erases all its contents.



Finalizing is necessary in order to play on equipment other than this recorder.



After finalizing, you cannot further edit or record on the disc.

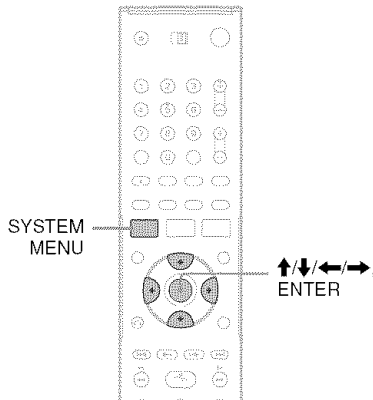

- 1** Insert a disc.
- 2** Press **SYSTEM MENU** while the recorder is in stop mode.  
The System Menu appears.
- 3** Select **"Disc Setting,"** and press **ENTER**.  
The "Disc Setting" display appears.

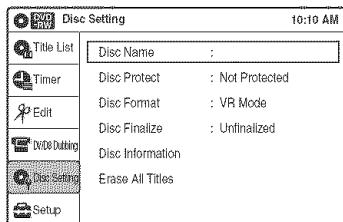

- 4** Select **"Disc Finalize,"** and press **ENTER**.  
The display asks for confirmation.

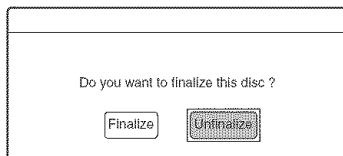

- 5** Select **"Finalize,"** and press **ENTER**.  
The display asks for confirmation again.

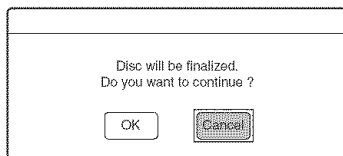

## **6** Select “OK,” and press ENTER.

The recorder starts finalizing the disc.

---

### **To turn off the display**

Press SYSTEM MENU.

### **To unfinalize a DVD-RW (VR mode)**

If you cannot record or edit on a DVD-RW (VR mode) that has been finalized, unfinalize the disc by selecting “Unfinalize” in step 5 above.

#### **Hints**

- You can check whether the disc has been finalized or not. If you cannot select “Finalize” in step 5 above, the disc has already been finalized.
- To check the disc information, select “Disc Information” in the “Disc Setting” display and press ENTER. See page 66 for details.

#### **Notes**

- A finalized disc may not play, depending on the condition of the disc, recording, or the DVD equipment.
- The recorder may not be able to finalize a disc if it was recorded on another recorder.

## Connecting a Digital Video Camera to the DV IN Jack

### Before DV/D8 Dubbing

This section explains dubbing with a digital video camera via the DV IN jack on the front panel. If you want to dub by way of the LINE IN jacks, see “Recording From Connected Equipment With a Timer (Synchro Rec)” on page 50.

#### To record from the DV IN jack

The DV IN jack on this recorder conforms to the i.LINK standard. You can connect any other equipment that has an i.LINK (DV) jack, and record digital signals.

Follow the instructions in “Connecting a Digital Video Camera to the DV IN Jack,” and then move on to the section on dubbing. For more information about i.LINK, see “About i.LINK” on page 90.

#### Hint

If you plan to do additional editing on a disc after the initial dub, use the DV IN jack and record on a DVD-RW (VR mode).

You can connect a digital video camera to the DV IN jack on the recorder to record or edit from a DV/D8 format tape. Operation is straightforward because the DVD recorder will fast forward and rewind the tape for you – you do not need to operate your digital video camera. Do the following to start using the “DV/D8 Edit” functions of this recorder.

See the instruction manual supplied with the digital video camera as well before connecting.

#### Notes

- The DV IN jack is for input only. It will not output signals.
- You cannot use the DV IN jack when:
  - your digital video camera does not work with this recorder. Connect the camera to the LINE IN jack and follow the instructions of “Recording From Connected Equipment Without a Timer” on page 53.
  - the input signal is not in DVC-SD format. Do not connect a MICRO MV format digital video camera even if it has an i.LINK jack.
  - the images on the tape contain copy protection signals, which limit recording.

#### Hookups

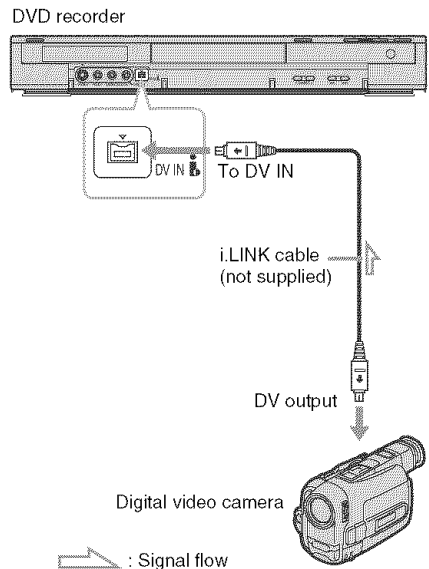

# Dubbing From a DV/D8 Format Tape to a DVD



You can record a DV/D8 format tape onto a disc. The recorder controls the digital video camera. You can fast forward, rewind, play in slow motion, and stop the tape to select the scenes using the on-screen menu.

To simply dub the entire contents of a DV/D8 format tape (One Touch Dubbing), see page 72.

## ◆How titles and chapters are created

The dubbed contents on the disc become one title, and the title is then divided into chapters at either 5 or 15-minute intervals, according to the “DVD Auto Chapter” setting of “Features” in the “Setup” display.

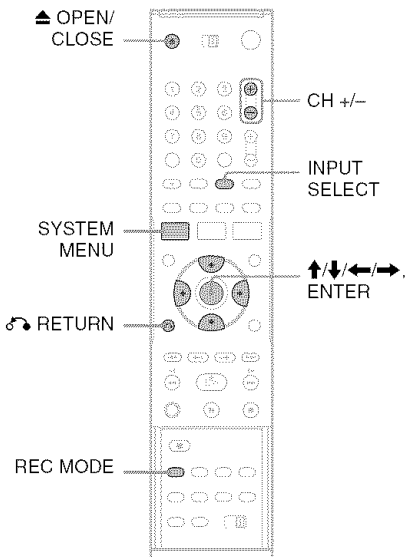

- 1 Press **▲ OPEN/CLOSE**, and place a recordable disc on the disc tray.

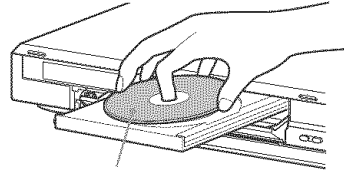

Recording side facing down

- 2 Press **▲ OPEN/CLOSE** to close the disc tray.

Wait until “LOAD” disappears from the front panel display.

Unused DVD-RWs are formatted in VR mode automatically. To format in Video mode, see page 81.

- 3 Insert the source DV/D8 format tape into your digital video camera.

For the recorder to record or edit, your digital video camera must be set to video playback mode.

- 4 Press **INPUT SELECT** repeatedly to select “DV.”

- 5 Press **REC MODE** repeatedly to select the recording mode.

For details about the recording mode, see page 45.

- 6 Press **SYSTEM MENU** while the recorder is in stop mode.

The System Menu appears.

- 7 Select “Setup,” and press **ENTER**.

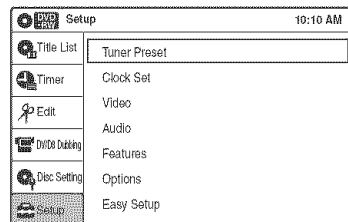

## 8 Select “Audio,” and press ENTER.

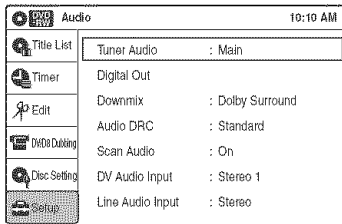

## 9 Select “DV Audio Input,” and press ENTER.

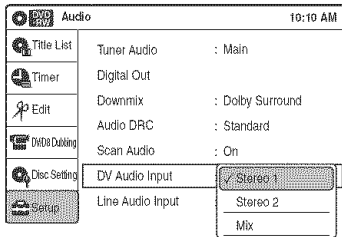

“Stereo 1”: Records original sound only. Normally select this when dubbing a DV format tape.

“Stereo 2”: Records additional audio only.

“Mix”: Records original and additional sounds.

Select “Stereo 2” or “Mix” if you have added a second audio channel when recording with your digital video camera. For the details, see page 80.

## 10 Select an option, and press ENTER.

## 11 Press RETURN twice.

## 12 Select “DV/D8 Dubbing,” and press ENTER.

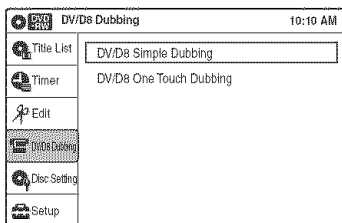

## 13 Select “DV/D8 Simple Dubbing,” and press ENTER.

The following display appears.

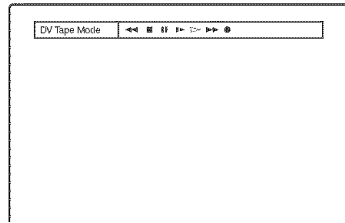

If “DV” or “DV Camera Mode” is displayed instead of “DV Tape Mode,” check that the digital video camera is correctly connected and its power turned on, and that its mode is set for dubbing.

## 14 Find the dubbing start point on the tape, and stop or pause playback.

Press / to select , , , , , or on the TV screen and press ENTER to find the point, and stop or pause with or .

## 15 Press to select on the TV screen, and press ENTER.

Dubbing starts.

### To stop during recording

Select on the TV screen, and press ENTER.

Note that it may take a few seconds for the recorder to stop recording.

### To turn off the display for DV/D8 dubbing

Press INPUT SELECT or CH +/-.

### Hint

If “DV Camera Mode” appears on the screen, you can use on the TV screen to record the camera image directly on the recorder.

### Notes

- If you want to play the disc on other DVD equipment, finalize the disc (page 67).
- You cannot connect more than one piece of digital video equipment to the recorder.
- You cannot record the date, time, or contents of a DV/D8 format tape onto the disc.
- If you record from a DV/D8 format tape with a soundtrack that is recorded in multiple sampling frequencies (48 kHz, 44.1 kHz, or 32 kHz), no sound, or an unnatural sound will be output when playing back the sampling frequency switch point on the disc.
- The recorded picture may be momentarily affected if the picture size of the source image changes, or if there is nothing recorded on the tape.
- Noise may occur when you switch the audio sampling mode (48 kHz/16 bits → 32 kHz/12 bits).

## Dubbing an entire DV/D8 format tape to a DVD (One Touch Dubbing)

+RW +RWvR -RWvideo +R -R

You can record the entire contents of a DV/D8 format tape onto a disc with a single press of the ONE TOUCH DUBBING button. The recorder controls the digital video camera for the whole process, and completes the recording.

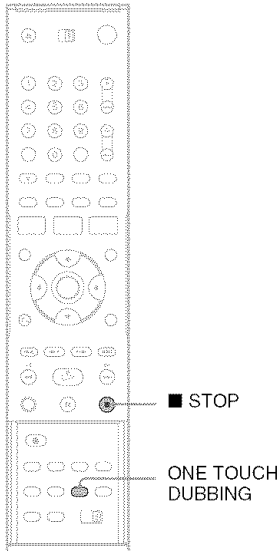

Follow steps 1 to 10 of “Dubbing From a DV/D8 Format Tape to a DVD” (page 70), and press **ONE TOUCH DUBBING** on the remote.

The recorder rewinds the tape in the digital video camera and then starts recording the tape contents from the beginning.

When playback of the tape stops, One Touch Dubbing ends automatically.

---

### To stop during recording

Press **■ STOP**.

Note that it may take a few seconds for the recorder to stop recording.

### 💡 Hint

You can also perform One Touch Dubbing when you select “DV/D8 One Touch Dubbing” and press ENTER in step 13 of “Dubbing From a DV/D8 Format Tape to a DVD” on page 70. Follow the instructions appearing on the TV screen.



## Using the Setup Displays

By using the setup displays, you can make various adjustments to items such as picture and sound, as well as select a language for the subtitles. The setup displays are used in the following way.

### Note

Playback settings stored on the disc take priority over the setup display settings, and not all of the functions described may work.

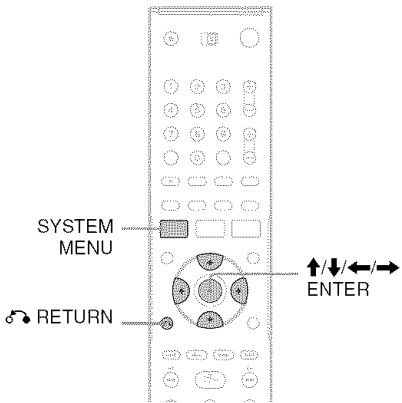

- 1 Press SYSTEM MENU while the recorder is in stop mode.**  
The System Menu appears.

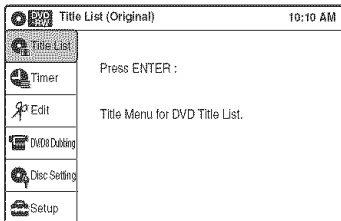

- 2 Select "Setup," and press ENTER.**  
The "Setup" display appears.

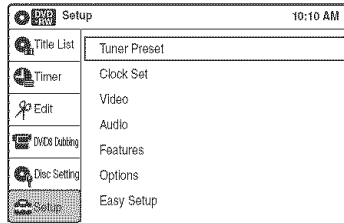

- 3 Select "Tuner Preset," "Clock Set," "Video," "Audio," "Features," "Options," or "Easy Setup," and press ENTER.**  
The selected setup display appears.  
Example: "Video" setup

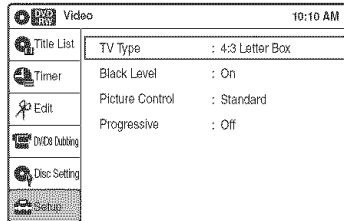

- 4 Select the item you want to set up, and press ENTER.**  
Available options for the item appear.  
Example: "TV Type"

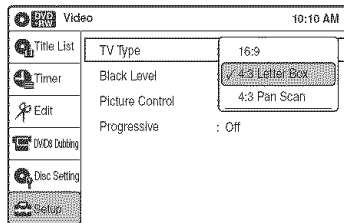

Some items display a dialog box that requires additional settings.

Example: When “Parental” in “Options” setup is selected.

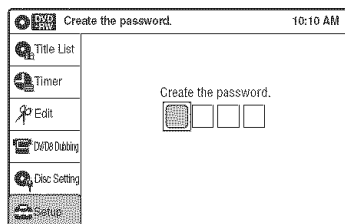

## 5 Select an option, and press ENTER.

The currently selected option is displayed next to the setup item.

Example: When “16:9” is set.

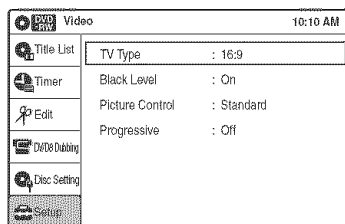

### To return to the previous display

Press RETURN.

### To turn off the display

Press SYSTEM MENU.

## Antenna Reception Setting (Tuner Preset)

The “Tuner Preset” setup allows you to make tuner settings for the recorder.

- 1 Press **SYSTEM MENU** while the recorder is in stop mode.
- 2 Select “Setup,” and press **ENTER**.
- 3 Select “Tuner Preset,” and press **ENTER**.

The “Tuner Preset” setup appears with the following options.

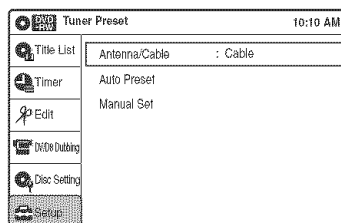

### Note

You cannot preset channels for a connected cable box or satellite receiver.

### Auto Preset

Automatically presets the receivable channels. The recorder can receive VHF channels 2 to 13, UHF channels 14 to 69, and unscrambled CATV channels 1 to 125. First, we recommend that you preset the receivable channels in your area using automatic presetting methods.

- 1 Select “Antenna/Cable,” and press **ENTER**.

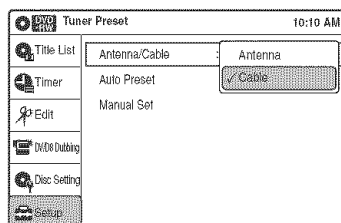

“Antenna”: Presets VHF and UHF channels.  
“Cable”: Presets cable TV channels.

- 2 Select an option, and press **ENTER**.
- 3 Select “Auto Preset,” and press **ENTER**.

All receivable channels are preset in numerical sequence.

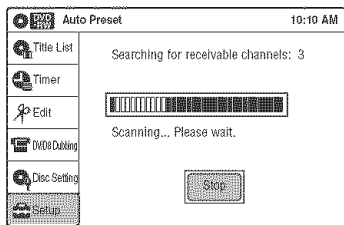

## Clock Setting (Clock Set)

The “Clock Set” setup allows you to make clock settings for the recorder.

- 1 Press **SYSTEM MENU** while the recorder is in stop mode.
- 2 Select “Setup,” and press **ENTER**.
- 3 Select “Clock Set,” and press **ENTER**.  
The “Clock Set” setup appears with the following options.

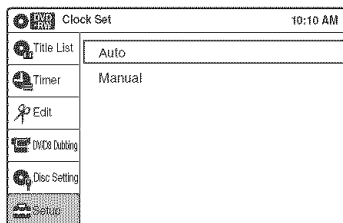

### Manual Set

Presets or disables channels manually.

If some channels could not be set using the “Auto Preset” or “Easy Setup” function, you can set them manually.

- 1 Select “Antenna/Cable,” and press **ENTER**.

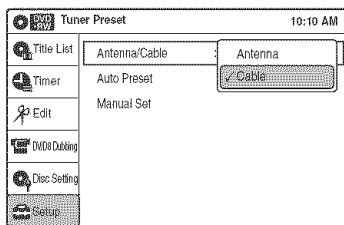

“Antenna”: Presets VHF and UHF channels.  
“Cable”: Presets cable TV channels.

- 2 Select an option, and press **ENTER**.
- 3 Select “Manual Set,” and press **ENTER**.
- 4 Select the channel you want to preset/disable using **↑/↓** or **CH +/-**, and press **ENTER**.

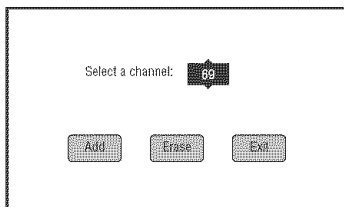

- 5 Select “Add” or “Erase” using **←/→**, and press **ENTER**.  
To cancel the setting, select “Exit” and press **ENTER**.
- 6 To preset or disable another channel, repeat steps 4 and 5.

### Auto (Auto Clock Set)

Turns on the Auto Clock Set function when a channel in your local area broadcasts a time signal.

- 1 Select “Auto,” and press **ENTER**.

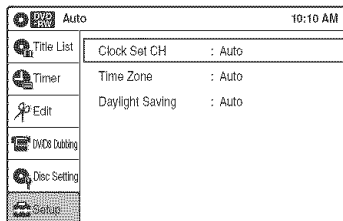

- 2 Select “Clock Set CH,” “Time Zone,” or “Daylight Saving” and press **ENTER**.
- 3 Adjust these settings by pressing **↑/↓** and **ENTER**.

#### ◆ Clock Set CH

Select a channel that carries a time signal using **↑/↓**.

Use this option if you know of a channel that carries a time signal. Most PBS member stations broadcast a time signal. For the fastest response, select your local PBS station. Leave the setting at “Auto” to have the recorder

automatically search for a channel that carries a time signal.

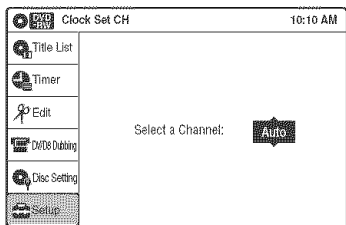

### ◆ Time Zone

Select the time zone for your area, or select "Auto" to have the recorder automatically set your time zone.

The options are:

Auto ↔ Atlantic ↔ Eastern ↔ Central  
 ↔ Mountain ↔ Pacific ↔ Alaska ↔  
 Hawaii ↔ Auto

### ◆ Daylight Saving

Select "On" or "Off" (standard time), or select "Auto" to have the recorder automatically set the daylight saving time.

## Manual

If the Auto Clock Set function did not set the clock correctly for your local area, set the clock manually.

- 1 Select "Manual," and press ENTER.

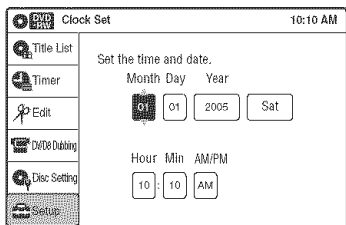

- 2 Press **↑/↓** to set the month, and press **→**. Set the day, year, hour, minutes, and AM/PM in sequence. Press **←/→** to select the item to be set, then press **↑/↓** to set the item. The day of the week is set automatically.
- 3 Press ENTER to start the clock.

## Video Settings (Video)

The "Video" setup allows you to adjust items related to the image, such as size and color. Choose the settings according to the type of TV, tuner, or decoder connected to the recorder.

- 1 Press **SYSTEM MENU** while the recorder is in stop mode.
- 2 Select "Setup," and press ENTER.
- 3 Select "Video," and press ENTER.

The "Video" setup appears with the following options. The default settings are underlined.

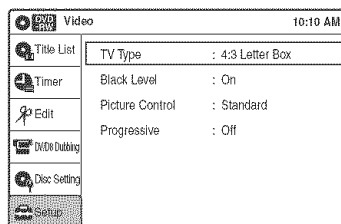

### TV Type

Selects the aspect ratio of the connected TV (4:3 standard or wide).

16:9	Select this when connecting to a wide-screen TV or TV with a wide mode function.
<u>4:3 Letter Box</u>	Select this when connecting to a 4:3 screen TV. Displays a wide picture with bands on the upper and lower portions of the screen.
4:3 Pan Scan	Select this when connecting to a 4:3 screen TV. Automatically displays a wide picture on the entire screen and cuts off the portions that do not fit.

16:9

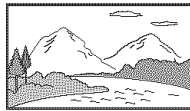

4:3 Letter Box



4:3 Pan Scan

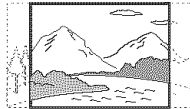

<u>Standard</u>	Off Displays a standard picture.
Cinema 1	White colors become brighter and black colors become richer, and the color contrast is increased.
Cinema 2	Enhances details in dark areas by increasing the black level.
Personal	Adjusts “Contrast,” “Brightness,” “Color,” and “Hue” using ↑/↓/←/→.

### Note

Depending on the disc, “4:3 Letter Box” may be selected automatically instead of “4:3 Pan Scan” or vice versa.

### Black Level

Selects the black level (setup level) for the video signals output from the LINE OUT 1 jacks (page 15).

This setting is not effective when the PROGRESSIVE indicator lights up in the front panel and the recorder outputs progressive signals.

<u>On</u>	Raises the standard black level. Select this when the picture appears too dark.
Off	Sets the black level of the output signal to the standard level.

### Picture Control

You can adjust the video signal of DVD or VIDEO CD (with PBC function off) from the recorder to obtain the picture quality you want. Select the setting that best suits the program you are watching.

Dynamic 1	Produces a bold dynamic picture by increasing the picture contrast and the color intensity.
Dynamic 2	Produces a more dynamic picture than Dynamic 1 by further increasing the picture contrast and the color intensity.

### Hint

When you watch a movie, “Cinema 1” or “Cinema 2” is recommended.

### Progressive

If your TV accepts progressive (480p) format signals, you will enjoy accurate color reproduction and high quality image.

- 1 Select “Progressive,” and press ENTER.
- 2 Select “On,” and press ENTER.
- 3 Follow the instructions appearing on the TV screen.

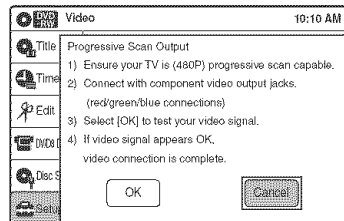

- 1 Ensure your TV is (480p) Progressive Scan capable.
- 2 Connect with Component Video Output jacks (red/green/blue connections). See “If your TV has component video input jacks” on page 16.
- 3 Select [OK] to test your video signal.
- 4 If video signal appears OK, video connection is complete.
- 4 Select “OK” and press ENTER. The PROGRESSIVE indicator on the recorder lights up. If picture is distorted, press ⏪ RETURN. Check the connection (page 16).

## Hint

The “Progressive” setting can be canceled by pressing **II PAUSE** on the recorder continuously for five seconds or more, or selecting “Off” in step 2.

## Note

If you select progressive signals when you connect the recorder to a TV that cannot accept the signal in progressive format, the image quality will deteriorate. In this case, set “Progressive” to “Off.”

# Audio Settings (Audio)

The “Audio” setup allows you to adjust the sound according to the playback and connection conditions.

- 1 Press SYSTEM MENU while the recorder is in stop mode.**
- 2 Select “Setup,” and press ENTER.**
- 3 Select “Audio,” and press ENTER.**

The “Audio” setup appears with the following options. The default settings are underlined.

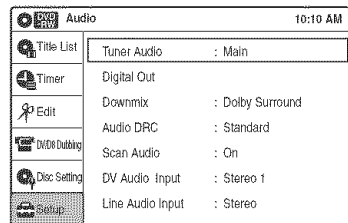

## Tuner Audio

Selects the sound to be recorded.

<u>Main</u>	Records only the main sound.
SAP	Records only the SAP (Second Audio Program) sound.

## Note

If no SAP sound is received, the main sound is recorded regardless of the setting.

## Digital Out

The following setup items switch the method of outputting audio signals when you connect a component such as an amplifier (receiver) with a digital input jack.

For connection details, see “Connecting to Your AV Amplifier (Receiver)” on page 17.

Press ENTER, and select “Dolby Digital Output” or “DTS.”

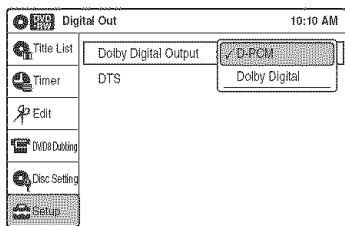

If you connect a component that does not accept the selected audio signal, a loud noise (or no sound) will come out from the speakers, and may affect your ears or cause speaker damage.

- **Dolby Digital Output (DVDs only)**  
Selects the type of Dolby Digital signal.

<u>D-PCM</u>	Select this when the recorder is connected to an audio component lacking a built-in Dolby Digital decoder. You can select whether the signals conform to Dolby Surround or not by making adjustments to the “Downmix” item in “Audio” setup (page 79).
<u>Dolby Digital</u>	Select this when the recorder is connected to an audio component with a built-in Dolby Digital decoder.

- **DTS (DVD VIDEOS only)**  
Selects whether or not to output DTS signals.

<u>On</u>	Select this when the recorder is connected to an audio component with a built-in DTS decoder.
<u>Off</u>	Select this when the recorder is connected to an audio component without a built-in DTS decoder.

### Downmix (DVDs only)

Switches the method for mixing down to two channels when you play a DVD which has rear sound elements (channels) or is recorded in Dolby Digital format. For details on the rear signal components, see “**A** Connecting to audio L/R jacks” on page 18. This function affects the output of the following jacks:

- LINE OUT (AUDIO L/R) 1/2 jacks
- DIGITAL OUT (OPTICAL or COAXIAL) jack when “Dolby Digital Output” is set to “D-PCM” (page 78).

<u>Dolby Surround</u>	Normally select this position. Multi-channel audio signals are output to two channels for enjoying surround sounds.
<u>Normal</u>	Multi-channel audio signals are downmixed to two channels for use with your stereo.

### Audio DRC (Dynamic Range Control) (DVDs only)

Makes the sound clear when the volume is turned down when playing a DVD that conforms to “Audio DRC.” This affects the output from the following jacks:

- LINE OUT (AUDIO L/R) 1/2 jacks
- DIGITAL OUT (OPTICAL or COAXIAL) jack only when “Dolby Digital Output” is set to “D-PCM” (page 78).

<u>Standard</u>	Normally select this position.
<u>Wide Range</u>	Gives you the feeling of being at a live performance.

### Scan Audio (DVDs only)

<u>On</u>	Outputs audio signals during FF1 fast-forward of a DVD disc with Dolby Digital soundtracks.
<u>Off</u>	No sound is output during FF1 fast-forward.

### Note

Sound will be interrupted during Scan Audio.

## DV Audio Input

<u>Stereo 1</u>	Records original sound only. Normally select this when dubbing a DV format tape.
Stereo 2	Records additional audio only.
Mix	Records both original and additional sounds.

### Note

Select “Stereo 2” or “Mix” if you have added a second audio channel when recording with your digital video camera.

## Line Audio Input

When recording from equipment connected to the LINE 1 IN or LINE 2 IN jack to a DVD disc in this recorder, select line input audio.

<u>Stereo</u>	Records stereo sound only. Select this for discs other than DVD-RWs (VR mode).
Main/Sub	Records the two different soundtracks on DVD-RWs (VR mode). You can select either soundtrack when playing back the disc.

### Hint

Audio selected with the connected equipment is recorded on a disc other than DVD-RW(s) (VR mode).

# Recording Settings (Features)

The “Features” setup allows you to adjust recording settings.

- 1 Press **SYSTEM MENU** while the recorder is in stop mode.
- 2 Select “Setup,” and press **ENTER**.
- 3 Select “Features,” and press **ENTER**.

The “Features” setup appears with the following options. The default settings are underlined.

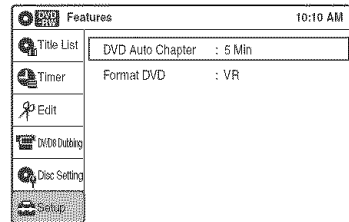

## DVD Auto Chapter

Automatically divides a recording (a title) into chapters by inserting chapter markings at specified intervals. The markings are inserted while the recording is being made.

<u>Off</u>	No chapter mark is inserted.
<u>5 Min</u>	Inserts chapter marks at approximately 5 minute intervals.
15 Min	Inserts chapter marks at approximately 15 minute intervals.

### Note

Actual intervals may differ depending on the size of the recording. The selected setting should be regarded as an approximate chapter interval.



## Format DVD (DVD-RWs only)

Selects the format for an unused DVD-RW, when first inserted.

<u>VR</u>	Automatically formats the disc in VR mode.
Video	Automatically formats the disc in Video mode.

## Language, Parental Control Settings/Factory Settings (Options)

The “Options” setup allows you to set up other operational settings.

- 1** Press **SYSTEM MENU** while the recorder is in stop mode.
- 2** Select “Setup,” and press **ENTER**.
- 3** Select “Options,” and press **ENTER**.

The “Options” setup appears with the following options. The default settings are underlined.

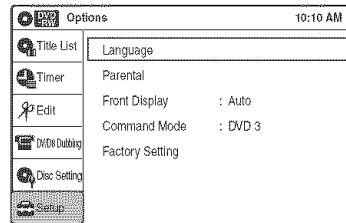

### Language

#### ◆ OSD (On-Screen Display)

Switches the display language on the screen.

#### ◆ Disc Menu (DVD VIDEOS only)

Switches the language for the DVD menu.

#### ◆ Audio (DVD VIDEOS only)

Switches the language of the soundtrack.

When you select “Original,” the language given priority in the disc is selected.

#### ◆ Subtitle (DVD VIDEOS only)

Switches the language of the subtitles recorded on the disc.

When you select “Auto,” the subtitle language changes according to the language you selected for the soundtrack. See page 96 for an explanation of the language abbreviations.

### Note

If you select a language in “Disc Menu,” “Subtitle,” or “Audio” that is not recorded on the DVD VIDEO, one of the recorded languages will be automatically selected.

## Parental (DVD VIDEOS only)

Playback of some DVD VIDEOS can be limited according to a predetermined level, such as the age of the users. Scenes may be blocked or replaced with different scenes.

- 1 After step 3 above, select "Parental," and press ENTER.
  - If you have not entered a password, the display for registering a new password appears.  
Enter a 4-digit password using the number buttons.

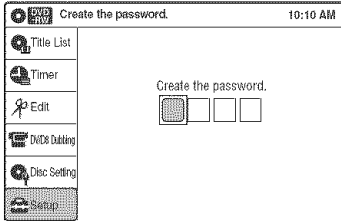

The display for confirming the password appears.  
Re-enter the password.

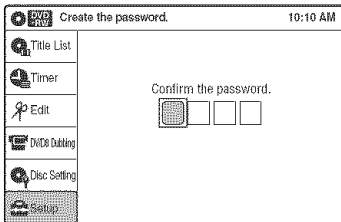

- When you have already registered a password, the display for entering the password appears.  
Enter a 4-digit password using the number buttons.

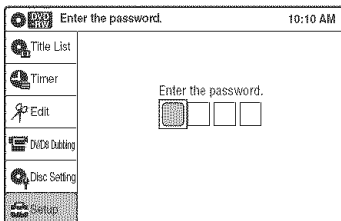

- 2 Select "Rating Level," and press ENTER.  
The selection items for "Rating Level" are displayed.

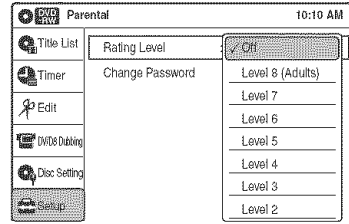

The lower the value, the stricter the limitation.

- 3 Select the level, and press ENTER.  
The Parental setting is complete.

- To cancel the Parental setting for the disc, set "Rating Level" to "Off" in step 3.
- To change the password, select "Change Password" in step 2, and press ENTER.  
When the display for registering a password appears, enter a new four-digit password using the number buttons.

## Notes

- If you forget your password, select "Factory Setting" of "Options" in the "Setup" display.
- Playback of discs without the Parental Control function cannot be limited on this recorder.
- Depending on the disc, you may be asked to change the Parental Control level while playing the disc. In this case, enter your password, then change the level.

## Front Display

Adjusts the lighting of the front panel display.

Auto	Adjusts to low lighting when power is off.
Bright	Maintains bright lighting when power is off.
Dimmer	Maintains low lighting regardless of whether power is on or off.

## Command Mode

Changes the command mode of this recorder if other DVD equipment is assigned the same command mode. Be sure to match the COMMAND MODE switch on the remote to the setting made here. For details, see "If you have a Sony DVD player or more than one Sony DVD recorder" on page 24.

DVD 1	Select this if the default command mode conflicts with other DVD equipment.
DVD 2	Select this if the default command mode conflicts with other DVD equipment.
<u>DVD 3</u>	The default command mode of the recorder.

### Factory Setting

Allows you to return the setup settings to their default settings. Note that all of your previous settings will be lost.

- 1** After step 3 above, select "Factory Setting," and press ENTER.
- 2** Select "Start," and press ENTER.  
The setup settings return to their default settings.
- 3** Press ENTER when "Finish" appears.  
The power automatically turns off and then on again, and the recorder is reset to the factory settings.  
When the "Easy Setup" display appears, follow the instructions for Easy Setup (page 22) from step 4.

## Easy Setup (Resetting the Recorder)

Select this to run the Easy Setup program.

- 1** Press **SYSTEM MENU** while the recorder is in stop mode.
- 2** Select "Setup," and press ENTER.
- 3** Select "Easy Setup," and press ENTER.

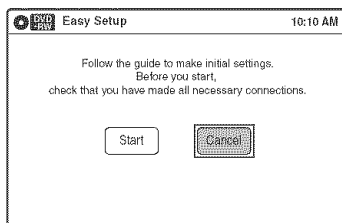

- 4** Select "Start," and press ENTER.
- 5** Follow the instructions for Easy Setup (page 22) from step 5.

## Troubleshooting

If you experience any of the following difficulties while using the recorder, use this troubleshooting guide to help remedy the problem before requesting repairs. Should any problem persist, consult your nearest Sony dealer.

### Power

#### The power does not turn on.

- ➔ Check that the AC power cord is connected securely.

### Picture

#### There is no picture.

- ➔ Re-connect all connecting cords securely.
- ➔ The connecting cords are damaged.
- ➔ Check the connection to your TV (page 12).
- ➔ Switch the input selector on your TV (such as to "VIDEO") so that the signal from the recorder appears on the TV screen.

#### Picture noise appears.

- ➔ Check the connection to your TV (page 12) and switch the input selector on your TV so that the signal from the recorder appears on the TV screen.
- ➔ If the picture output signal from your recorder passes through your VCR to get to your TV, or if you are connected to a combination TV/VIDEO player, the copy-protection signal applied to some DVD programs could affect picture quality. If you still experience this problem even when you connect your recorder directly to your TV, try connecting your recorder to your TV's S VIDEO input.
- ➔ You have set the recorder to progressive format (the PROGRESSIVE indicator lights up) even though your TV cannot accept the progressive signal. In this case, set "Progressive" to "Off" in "Video" setup (page 77).
- ➔ Even if your TV is compatible with progressive format (480p) signals, the image may be affected when you set the recorder to progressive format. In this case, set "Progressive" to "Off" in "Video" setup (page 77).

#### TV program reception does not fill the screen.

- ➔ Set the channel manually in "Tuner Preset" setup (page 74).
- ➔ Select the correct source using the INPUT SELECT button, or select a channel of any TV program using the CH +/- buttons.

#### TV program pictures are distorted.

- ➔ Reorient the TV antenna.
- ➔ Adjust the picture (see the TV's instruction manual).
- ➔ Place the recorder and TV farther apart.
- ➔ Place the TV and any bunched antenna cables farther apart.

#### TV channels cannot be changed.

- ➔ The channel is disabled (page 75).
- ➔ A timer recording started, which cause the channels to change.

#### The picture from equipment connected to the recorder's input jack does not appear on the screen.

- ➔ If the equipment is connected to the LINE 1 IN jack, select "LINE1" in the front panel display by pressing INPUT SELECT.  
If the equipment is connected to the LINE 2 IN jacks, select "LINE2" in the front panel display by pressing INPUT SELECT.

#### The playback picture or TV program from the equipment connected through the recorder is distorted.

- ➔ If the playback picture output from a DVD player, VCR, or tuner goes through your recorder before reaching your TV, the copy-protection signal applied to some programs could affect picture quality. Disconnect the playback equipment in question and connect it directly to your TV.

#### The picture does not fill the screen.

- ➔ Set "TV Type" in "Video" setup to fit the aspect ratio of your TV (page 76).

#### The picture does not fill the screen, even though the aspect ratio is set in "TV Type" in "Video" setup.

- ➔ The aspect ratio of the disc is fixed on your DVD.

---

## Sound

### There is no sound.

- ➔ Re-connect all connections securely.
- ➔ The connecting cord is damaged.
- ➔ The input source setting on the amplifier or the connection to the amplifier is incorrect.
- ➔ The recorder is in reverse play, fast-forward, slow motion, or pause mode.
- ➔ If the audio signal does not come through the DIGITAL OUT (OPTICAL or COAXIAL) jack, check the “Audio” setup settings (page 78).

---

### Sound is noisy.

- ➔ When playing a CD with DTS soundtracks, noise will come from the LINE OUT (AUDIO L/R) 1/2 jacks (page 35).

---

### The sound volume is low.

- ➔ The sound volume is low on some DVDs. The sound volume may improve if you set “Audio DRC” in “Audio” setup to “Wide Range” (page 79).

---

### An alternate audio track cannot be recorded or played.

- ➔ Second Audio Program (SAP) is not available for all programs. The program you are recording does not have a second audio program.
- ➔ You have set “Tuner Audio” in “Audio” setup to “Main” (page 78). Select “SAP” to record alternate audio programs.
- ➔ If you have connected an AV amplifier to the DIGITAL OUT (OPTICAL or COAXIAL) jack and want to change the audio track for a DVD-RW (VR mode) during playback, set “Dolby Digital Output” in “Audio” setup to “D-PCM” (page 78).
- ➔ When recording to a disc other than DVD-RWs (VR mode), set “Line Audio Input” in “Audio” setup to “Stereo.”

---

## Playback

### The disc does not play.

- ➔ The disc is upside down. Insert the disc with the labeled side facing up.
- ➔ The disc is not correctly inserted.
- ➔ Moisture has condensed inside the recorder. Remove the disc and leave the recorder turned on for about half an hour until the moisture evaporates.
- ➔ If the disc was recorded on another recorder, the recorder cannot play the disc if it was not finalized (page 67).

---

### The disc does not start playback from the beginning.

- ➔ Resume play was activated (page 36).
- ➔ You have inserted a disc whose Title menu or DVD menu automatically appears on the TV screen when it is first inserted. Use the menu to start playback.

---

### The recorder starts playing the disc automatically.

- ➔ The DVD VIDEO features an auto playback function.

---

### Playback stops automatically.

- ➔ If the disc has an auto pause signal, the recorder stops playback at the auto pause signal.

---

### Some functions such as Stop, Search, or Slow-motion Play cannot be performed.

- ➔ Depending on the disc, you may not be able to do some of the operations above. See the instruction manual supplied with the disc.
- ➔ While the recorder is reading disc information, playback operations will not work.

---

### The language for the soundtrack cannot be changed.

- ➔ Multilingual tracks are not recorded on the disc being played.
- ➔ The DVD VIDEO prohibits the changing of the language for the soundtrack.
- ➔ Try changing the language using the DVD VIDEO’s menu.

---

### The subtitle language cannot be changed or turned off.

- ➔ Multilingual subtitles are not recorded on the DVD VIDEO.
- ➔ The DVD VIDEO prohibits changing of the subtitles.
- ➔ Try changing the subtitle using the DVD VIDEO's menu.
- ➔ The subtitles cannot be changed for the titles recorded on this recorder.

---

### The angles cannot be changed.

- ➔ Multi-angles are not recorded on the DVD VIDEO being played.
- ➔ You are trying to change the angles when “” does not appear in the front panel display (page 33).
- ➔ The DVD VIDEO prohibits changing angles.
- ➔ Try changing the angle using the DVD VIDEO's menu.
- ➔ The angles cannot be changed for the titles recorded on this recorder.

---

### The MP3 audio track cannot be played.

- ➔ The DATA CD is not recorded in the MP3 format that conforms to ISO9660 Level 1/Level 2.
- ➔ The MP3 audio track does not have the extension “.MP3.”
- ➔ The data is not formatted in MP3 even though it has the extension “.MP3.”
- ➔ The data is not MPEG1 Audio Layer 3 data.
- ➔ The recorder cannot play audio tracks in MP3PRO format.

---

### The JPEG image file cannot be played.

- ➔ The DATA CD is not recorded in a JPEG format that conforms to ISO9660 Level 1/Level 2.
- ➔ The JPEG image file does not have the extension “.JPG” or “.JPEG.”
- ➔ The data is not formatted in JPEG even though it has the extension “.JPG” or “.JPEG.”
- ➔ The length or width of the image is more than 4,720 dots.

---

### The title of the MP3 audio album/track or JPEG image folder/file is not correctly displayed.

- ➔ The recorder can only display numbers and alphabet. Other characters are displayed as asterisks.

---

## Recording/Timer recording/Editing

### The channel cannot be changed from the channel you are recording.

- ➔ Set the TV's input source to “TV.”

---

### Recording does not start immediately after

#### ● REC is pressed.

- ➔ Operate the recorder only after “LOAD,” “FORMAT,” or “INF WRITE” disappears from the front panel display.

---

### Nothing was recorded even though the timer setting is set correctly.

- ➔ There was a power failure during recording.
- ➔ Disconnect the AC power cord from the AC outlet, and connect it again.
- ➔ The program contains copy protection signals that restrict copying.
- ➔ The program that starts first has priority and the second program starts recording only after the first program has finished. If the programs start at the same time, the program listed first in the menu has priority (page 49).
- ➔ There is no DVD inserted in the recorder.
- ➔ There is not enough disc space for the recording.

---

### Recording does not stop immediately after

#### ■ STOP is pressed.

- ➔ It will take a few seconds for the recorder to input disc data before recording can stop.

---

### Timer recording is not complete or did not start from the beginning.

- ➔ There was a power failure during recording. If the power recovers when there is a timer recording, the recorder resumes recording. The clock is automatically set by EDS, but it is reset during a power failure when the EDS signal cannot be received (page 75).
- ➔ The program that starts first has priority and the second program starts recording only after the first program has finished. If the programs start at the same time, the program listed first in the menu has priority (page 49).
- ➔ There is not enough disc space for the recording.

---

**The  indicator flashes after timer recording is set.**

- ➔ Insert a recordable disc (page 28).
- ➔ Insert a disc with enough space for the recording.
- ➔ The disc has 99 or more titles, which prevents further recording.
- ➔ The disc is protected (page 66).

---

**The SYNCHRO REC indicator flashes after Synchro-Recording is set.**

- ➔ Insert a recordable disc (page 28).
- ➔ Insert a disc with enough space for the recording.
- ➔ The disc has 99 or more titles, which prevents further recording.
- ➔ The disc is protected (page 66).

---

**Contents previously recorded were erased.**

- ➔ Data that has been recorded on a DVD with a PC will be erased from the disc when the disc is inserted.

---

**Display****Menus or displays do not appear on the screen.**

- ➔ While the recorder is reading disc information, the System Menu, TOOLS menu, or information display will not appear.

---

**“- :- -” appears in the front panel display.**

- ➔ Set the clock again (page 75).

---

**The  indicator is flashing.**

- ➔ The disc does not have enough space.
- ➔ Insert a recordable disc in place inside the recorder.

---

**Remote control****The remote does not function.**

- ➔ Batteries are weak.
- ➔ The remote is too far from the recorder.
- ➔ The remote's manufacturer code returned to the default setting when you replaced the batteries. Reset the code (page 19).
- ➔ Turn on the recorder.
- ➔ The remote is not pointed at the remote sensor on the recorder.
- ➔ Different command modes are set for the recorder and remote. Set the same command mode (page 24).
- ➔ Slide the TV/DVD switch to DVD (page 20).

---

**Other Sony equipment responds to the remote.**

- ➔ The same command mode is set for both the Sony DVD equipment. Set a different command mode for the recorder (page 24).

---

**Others****The recorder does not operate properly.**

- ➔ Restart the recorder. Press down  on the recorder for more than ten seconds until “SONY DVD” appears in the front panel display.
- ➔ When static electricity, etc., causes the recorder to operate abnormally, turn off the recorder and wait until the clock appears in the front panel display. Then, unplug the recorder and after leaving it off for a while, plug it in again.

---

**The disc tray does not open after you press  OPEN/CLOSE.**

- ➔ It may take a few seconds for the disc tray to open after you have recorded or edited a disc. This is because the recorder is adding disc data to the disc.

---

**The disc tray does not open and “TRAY LOCKED” appears in the front panel display.**

- ➔ Contact your Sony dealer or local authorized Sony service facility.

---

**“CAN NOT RECORD BECAUSE OF HIGH TEMP.” appears in the front panel display.**

- ➔ Check that the vent on the rear of the recorder is not blocked. Then, turn off the recorder, wait until the clock appears in the front panel display, and disconnect the AC power cord. Leave the recorder off for a while, then re-connect the power cord, and press  on the recorder.

---

**“CHILD LOCK” appears in the front panel display.**

- ➔ The recorder is locked. Cancel the Child Lock (page 37).

---

**Control by AV mouse is not possible.**

- ➔ Some satellite receivers may not support AV mouse.

# Notes About This Recorder

## On adjusting volume

Do not turn up the volume while listening to a section with very low level inputs or no audio signals. If you do, the speakers may be damaged when a peak level section is played.

## On cleaning

Clean the cabinet, panel, and controls with a soft cloth slightly moistened with a mild detergent solution. Do not use any type of abrasive pad, scouring powder or solvent such as alcohol or benzine.

## On cleaning discs

Do not use a commercially available cleaning disc. It may cause a malfunction.

## Notes about the discs

- To keep the disc clean, handle the disc by its edge. Do not touch the surface. Dust, fingerprints, or scratches on the disc may cause it to malfunction.



- Do not expose the disc to direct sunlight or heat sources such as hot air ducts, or leave it in a car parked in direct sunlight as the temperature may rise considerably inside the car.
- After playing, store the disc in its case.
- Clean the disc with a cleaning cloth. Wipe the disc from the center out.



- Do not use solvents such as benzine, thinner, commercially available disc/lens cleaners, or anti-static spray intended for vinyl LPs.
- Do not use the following discs.
  - A disc that has a non-standard shape (e.g., card, heart).
  - A disc with a label or sticker on it.
  - A disc that has cellophane tape or sticker adhesive on it.



# Specifications

## System

### [DVD recorder section]

#### Laser

Semiconductor laser

#### Audio recording format

Dolby Digital

#### Video recording format

MPEG Video

### [Tuner section]

#### Channel coverage

VHF 2 to 13

UHF 14 to 69

CATV A-8 to A-1, A to W, W+1 to W+84

#### Antenna

75-ohm antenna terminal for VHF/UHF

### [Timer section]

#### Clock

Quartz locked

#### Timer indication

12-hour cycle

#### Timer setting

12 programs (max.)

## Inputs and outputs

### LINE 1 IN and LINE 2 IN

VIDEO IN, phono jack (1 each)

Input signal: 1 Vp-p, 75 ohms, unbalanced, sync negative

AUDIO IN, phono jacks (2 each)

Input level: 327 mVrms

Input impedance: more than 47 kilohms

### LINE 2 IN

S VIDEO, 4-pin, mini-DIN jack

Y: 1.0 Vp-p, unbalanced, sync negative

C: 0.286 Vp-p, load impedance 75 ohms

DV IN, 4-pin jack, i.LINK S100

### LINE OUT

VIDEO OUT, phono jack (1)

Output signal: 1 Vp-p, 75 ohms, unbalanced, sync negative

AUDIO OUT, phono jacks (2)

Standard output: 327 mVrms

Load impedance: 47 kilohms

Output impedance: less than 10 kilohms

## DIGITAL OUT

OPTICAL, Optical output jack

-18 dBm (wave length: 660 nm)

COAXIAL, phono jack

Output signal: 0.5 Vp-p, 75 ohms

## COMPONENT VIDEO OUT (Y, Pb, Pr)

Phono jack

Y: 1.0 Vp-p/Pb, Pr: 0.7 Vp-p, 75 ohms

## S VIDEO OUT

4-pin, mini-DIN jack

Y: 1.0 Vp-p, unbalanced, sync negative

C: 0.286 Vp-p, load impedance 75 ohms

## General

### Power requirements

120 V AC, 60 Hz

### Power consumption

28 W

### Power back-up

Back-up duration: 0 min

### Operating temperature

5°C to 35°C (41°F to 95°F)

### Storage temperature

-20°C to 60°C (-4°F to 140°F)

### Operating humidity

25% to 80%

### Dimensions including projecting parts and controls (w/h/d)

Approx. 430 × 63 × 263 mm

(Approx. 17 × 2 1/2 × 10 3/8 inches)

### Mass

Approx. 2.9 kg (Approx. 6.4 lbs)

### Supplied accessories

Remote commander (remote) (1)

Size AA (R6) batteries (2)

Antenna cable (1)

Audio/video cord (1)

Design and specifications are subject to change without notice.

---

## About i.LINK

The DV IN jack on this recorder is an i.LINK-compliant DV IN jack. This section describes the i.LINK standard and its features.

### What is i.LINK?

i.LINK is a digital serial interface for handling digital video, digital audio and other data in two directions between equipment having the i.LINK jack, and for controlling other equipment.

i.LINK-compatible pieces of equipment can be connected by a single i.LINK cable. Possible applications are operations and data transactions with various digital AV equipment. When two or more i.LINK-compatible equipment are connected to this recorder in a daisy chain, operations and data transactions are possible with not only the equipment that this recorder is connected to but also with other devices via the directly connected equipment.

Note, however, that the method of operation sometimes varies according to the characteristics and specifications of the equipment to be connected, and that operations and data transactions are sometimes not possible on some connected equipment.

#### Note

Normally, only one piece of equipment can be connected to this recorder by the i.LINK cable (DV connecting cable). When connecting this recorder to i.LINK-compatible equipment having two or more i.LINK jacks (DV jacks), see the instruction manual of the equipment to be connected.

---

## About the name “i.LINK”

i.LINK is a more familiar term for IEEE 1394 data transport bus proposed by SONY, and is a trademark approved by many corporations. IEEE 1394 is an international standard standardized by the Institute of Electrical and Electronics Engineers.

---

## i.LINK baud rate

i.LINK's maximum baud rate varies according to the equipment. Three maximum baud rates are defined:

S100 (approx. 100 Mbps\*)

S200 (approx. 200 Mbps)

S400 (approx. 400 Mbps)

The baud rate is listed under “Specifications” in the instruction manual of each equipment. It is also indicated near the i.LINK jack on some equipment.

The maximum baud rate of equipment on which it is not indicated such as this unit is “S100.”

When units are connected to equipment having a different maximum baud rate, the baud rate sometimes differs from the indicated baud rate.

\* What is Mbps?

Mbps stands for megabits per second, or the amount of data that can be sent or received in one second. For example, a baud rate of 100 Mbps means that 100 megabits of data can be sent in one second.

---

## i.LINK functions on this recorder

For details on how to dub when this recorder is connected to other video equipment having DV jacks, see page 69.

The DV jack on this recorder can only input DVC-SD signals. It cannot output signals. The DV jack will not accept MICRO MV signals from equipment such as a MICRO MV digital video camera with an i.LINK jack.

For further precautions, see the notes on page 69.

For details on precautions when connecting this recorder, also see the instruction manuals for the equipment to be connected.

---

## Required i.LINK cable

Use the Sony i.LINK 4-pin-to-4-pin cable (during DV/D8 dubbing).

i.LINK and  are trademarks.

# Guide to Parts and Controls

For more information, see the pages in parentheses.

## Front panel

Buttons on the recorder have the same function as the buttons on the remote if they have the same or similar names.

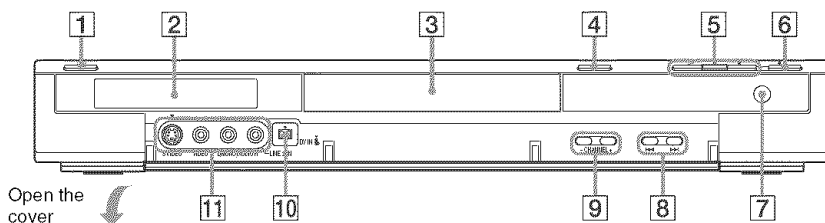

**1** (on/standby) button (22)

**2** Front panel display (44)

**3** Disc tray (32, 46, 70)

**4** (open/close) button (32, 46, 70)

**5** (play) button (32)

**||** (pause) button (33, 46)

**■** (stop) button (32, 46)

**6** (record) button (46)

**7** (remote sensor) (19)

**8** (previous/next) buttons (35)

**9** CHANNEL +/- buttons\* (20, 46)

**10** DV IN jack (69)

**11** LINE 2 IN (S VIDEO/VIDEO/AUDIO L (MONO)/R) jacks (26)

\* CHANNEL + button has a tactile dot. Use the tactile dot as a reference.

## Remote

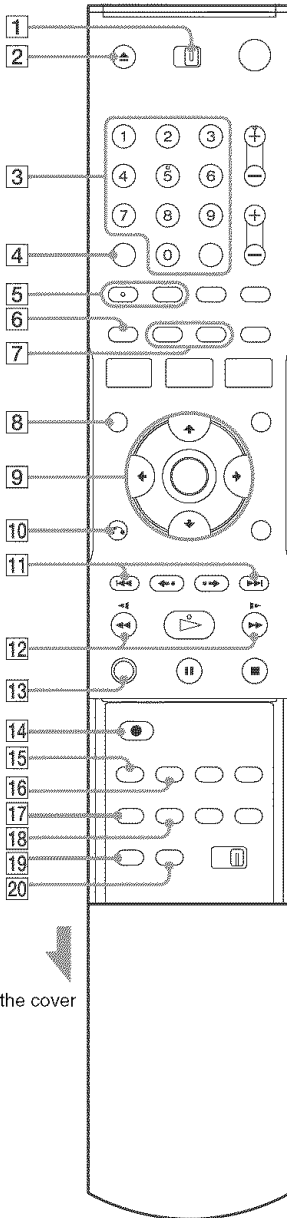

Slide the cover

Buttons with an orange dot next to them can be used with your TV when the TV/DVD switch is set to TV.

- 1** TV/DVD switch (20)
- 2** ▲ OPEN/CLOSE button (32, 46, 70)
- 3** Number buttons\* (20, 33)  
SET button (20)
- 4** CLEAR button (39)
- 5** AUDIO button\* (33)  
SUBTITLE button (33)
- 6** ORIGINAL/PLAYLIST button (37, 56)
- 7** DISPLAY button (43)  
TIME/TEXT button (44)
- 8** TOP MENU button (32)
- 9** ↑/↓/←/→/ENTER button (22)
- 10** ↶ ↷ RETURN button (22)
- 11** ◀◀ PREV (previous)/▶▶ NEXT buttons (33)
- 12** ◀◀ ◀ ◁ ▷ ▶ ▶▶ (search) buttons (33)
- 13** ZOOM button (33)
- 14** ● REC (record) button (46)
- 15** REC MODE button (46, 70)
- 16** SYNCHRO REC button (50)
- 17** ANGLE button (33)
- 18** REPEAT button (33)
- 19** MARKER button (39)
- 20** SEARCH button (39)

\* Number 5 and AUDIO buttons have a tactile dot. Use the tactile dot as a reference.

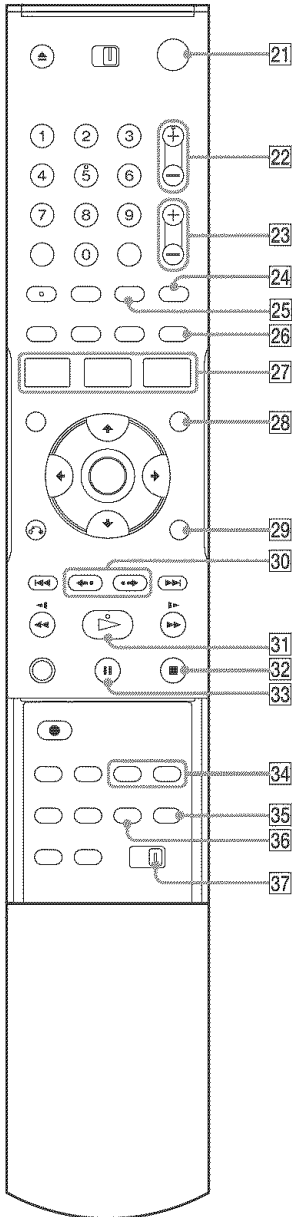

- 21** I/⏻ (on/standby) button (22)
- 22** CH (channel) +/- buttons\* (20, 46)
- 23** VOL (volume) +/- buttons (20)
- 24** TV/VIDEO button (20)
- 25** INPUT SELECT button (46, 53, 70)
- 26** SUR (surround) button (33)
- 27** SYSTEM MENU button (10)  
TITLE LIST button (37, 56)  
TIMER button (48)
- 28** MENU button (32)
- 29** TOOLS button (38)
- 30** ⏮ REPLAY/ ⏭ ADVANCE buttons (33)
- 31** ▷ PLAY button\* (32)
- 32** ■ STOP button (32, 46)
- 33** || PAUSE button (46)
- 34** CHAPTER MARK/CHAPTER MARK ERASE buttons (59)
- 35** WIDE MODE button (20)
- 36** ONE TOUCH DUBBING button (72)
- 37** COMMAND MODE switch (DVD 1, 2, 3) (24)

\* CH + and ▷ PLAY buttons have a tactile dot. Use the tactile dot as a reference.

Slide the cover

## Front panel display

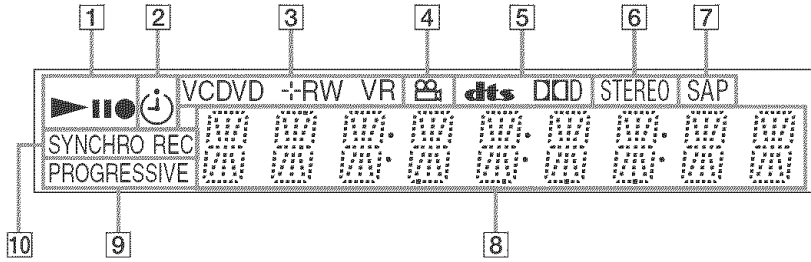

- |  |  |
|--|--|
| <p><b>1</b> Playing/recording status</p> <p><b>2</b> Timer indicator</p> <p><b>3</b> Disc type/recording format</p> <p><b>4</b> (angle) indicator (33)</p> <p><b>5</b> Audio signal indicators</p> <p><b>6</b> STEREO indicator (45)</p> <p><b>7</b> SAP (Second Audio Program) indicator (45)</p> | <p><b>8</b> Displays the following (44):</p> <ul style="list-style-type: none"> <li>• Playing time/remaining time</li> <li>• Current title/chapter/track/index number</li> <li>• Recording time/recording mode</li> <li>• Clock</li> <li>• Channel</li> </ul> <p><b>9</b> PROGRESSIVE indicator (16, 77)</p> <p><b>10</b> SYNCHRO REC indicator (50)</p> |
|--|--|

## Rear panel

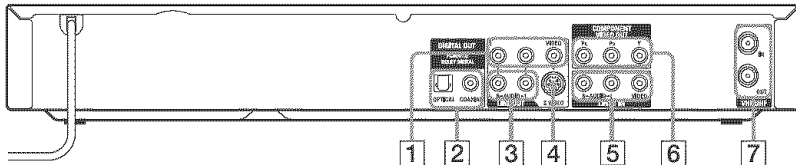

- |   |   |
|---|---|
| <p><b>1</b> LINE OUT 1 (VIDEO/AUDIO L/R) jacks (15, 16)</p> <p><b>2</b> DIGITAL OUT (OPTICAL/COAXIAL) jacks (17)</p> <p><b>3</b> LINE OUT 2 (AUDIO L/R) jacks (17)</p> <p><b>4</b> LINE OUT (S VIDEO) jack (15)</p> | <p><b>5</b> LINE 1 IN (VIDEO/AUDIO L/R) jacks (27)</p> <p><b>6</b> COMPONENT VIDEO OUT (Y, Pb, Pr) jacks (16)</p> <p><b>7</b> VHF/UHF IN/OUT jacks (14)</p> |
|---|---|

---

# Glossary

## Chapter (page 38)

Sections of a picture or a music feature that are smaller than titles. A title is composed of several chapters. Depending on the disc, no chapters may be recorded.

---

## Copy protection signals (page 46)

Copy restriction set by copyright owners, etc. These signals are included in some software or TV programs and restrict recording on this recorder.

---

## Dolby Digital (page 78)

Digital audio compression technology developed by Dolby Laboratories. This technology conforms to multi-channel surround sound. The rear channel is stereo and there is a discrete subwoofer channel in this format. Dolby Digital provides the same discrete channels of high quality digital audio found in "Dolby Digital" theater surround sound systems. Good channel separation is realized because all of the channel data is recorded discretely, and little deterioration occurs because all channel data processing is digital.

---

## DTS (page 78)

Digital audio compression technology by Digital Theater Systems, Inc. This technology conforms to multi-channel surround sound. The rear channel is stereo and there is a discrete subwoofer channel in this format. DTS provides the same discrete channels of high quality digital audio. Good channel separation is realized because all of the channel data is recorded discretely, and little deterioration occurs because all channel data processing is digital.

---

## DVD+RW (page 28)

A DVD+RW (read "plus RW") is a recordable and rewritable disc. DVD+RWs use a recording format that is comparable to the DVD VIDEO format.

---

## DVD-RW (page 28)

A DVD-RW is a recordable and rewritable disc that is the same size as a DVD VIDEO. The DVD-RW has two different modes: VR mode and Video mode. DVDs created in Video mode have the same format as a DVD VIDEO, while discs created in VR (Video Recording) mode allow the contents to be programmed or edited.

---

## DVD+R (page 28)

A DVD+R (read "plus R") is a recordable disc that is the same size as a DVD VIDEO. Contents can be recorded only once to a DVD+R, and will have the same format as a DVD VIDEO.

---

## DVD-R (page 28)

A DVD-R is a recordable disc that is the same size as a DVD VIDEO. Contents can be recorded only once to a DVD-R, and will have the same format as a DVD VIDEO.

---

## DVD VIDEO (page 30)

A disc that contains up to eight hours of moving pictures on a disc the same diameter as a CD. The data capacity of a single-layer and single-sided DVD is 4.7 GB (Giga Byte), which is 7 times that of a CD. The data capacity of a double-layer and single-sided DVD is 8.5 GB, a single-layer and double-sided DVD is 9.4 GB, and double-layer and double-sided DVD is 17 GB. The picture data uses the MPEG 2 format, which is a worldwide standard of digital compression technology. The picture data is compressed to about 1/40 (average) of its original size. The DVD also uses a variable rate coding technology that changes the data to be allocated according to the status of the picture. Audio information is recorded in a multi-channel format, such as Dolby Digital, allowing you to enjoy a more real audio presence. Furthermore, various advanced functions such as the multi-angle, multilingual, and Parental Control functions are provided on the DVD.

---

### **Interlace format**

Interlace format shows every other line of an image as a single “field” and is the standard method for displaying images on television. The even number field shows the even numbered lines of an image, and the odd numbered field shows the odd numbered lines of an image.

---

### **Original (page 55)**

Titles actually recorded on a DVD-RW (VR mode). Erasing original titles frees up disc space.

---

### **Playlist (page 55)**

Playback information created from the actual recordings on a DVD-RW (VR mode). A Playlist leaves the original titles as they are, and contains only the information needed to control playback. A Playlist title takes up very little disc space.

---

### **Progressive format (page 77)**

Compared to the Interlace format that alternately shows every other line of an image (field) to create one frame, the Progressive format shows the entire image at once as a single frame. This means that while the Interlace format can show 30 frames/60 fields in one second, the Progressive format can show 60 frames in one second. The overall picture quality increases and still images, text, and horizontal lines appear sharper.

---

### **Title (page 38)**

The longest section of a picture or music feature on a DVD, movie, etc., in video software, or the entire album in audio software.

---

### **Track (page 38)**

Sections of a music feature on a CD (the length of a song).

---

---

## **DVD Audio/Subtitle Language**

When you play a DVD VIDEO, the language of the selected audio track or subtitle is abbreviated as follows. See page 81 to change the audio track or subtitle.

<b>Abbreviation</b>	<b>Language</b>
ARA	Arabic
BUL	Bulgarian
CHI	Chinese
CRO	Croatian
CZE	Czech
DAN	Danish
DEU	German
ENG	English
ESP	Spanish
FIN	Finish
FRA	French
GRE	Greek
HUN	Hungarian
IDN	Indonesian
IND	Hindi
ISL	Icelandic
ITA	Italian
IWR	Hebrew
JPN	Japanese
KOR	Korean
MAL	Malay
NLD	Dutch
NOR	Norwegian
POL	Polish
POR	Portuguese
RUS	Russian
SVE	Swedish
THA	Thai



<b>Abbreviation</b>	<b>Language</b>
TUR	Turkish
VIE	Vietnamese
ZAF	Afrikaans

---

# Index

Words in quotations appear in the on-screen displays.

## Numerics

- 16:9 23, 76
- 4:3 Letter Box 23, 76
- 4:3 Pan Scan 23, 76

## A

- “A-B Erase” 57
- “Add” 63, 65
- ADVANCE 34
- ANGLE 33
- Antenna 14
- AUDIO 33
- “Audio” 81
- Audio cords 17
- “Audio DRC” 79
- Audio settings 78
- Auto Clock Set 75
- “Auto Preset” 74

## B

- Batteries 19
- “Black Level” 77
- Bookmark 39

## C

- Cable box 13, 14
- Changing or Canceling Timer Settings (Timer List) 52
- Chapter 95
- “Chapter Erase” 57
- CHAPTER MARK 59
- CHAPTER MARK ERASE 59
- “Check” 63
- Child Lock 37
- Cleaning discs 88
- “Clock Set CH” 75
- Clock Set settings 75
- “Combine Titles” 63
- “Command Mode” 25, 82
- COMPONENT VIDEO OUT 16

- Connecting
  - the antenna cable 12
  - to your AV/amplifier (receiver) 17
  - to your TV 15

Controlling TVs with the remote 20

Copy protection 46, 95

Copy-Free 46

Copy-Never 46

Copy-Once 46

CPRM 28

“Create Playlist” 61

Creating chapters 48, 59

## D

- “Daylight Saving” 76
- “Del” 52
- “Digital Out” 78
- “Disc Finalize” 66, 67
- “Disc Format” 66
- “Disc Information” 66
- “Disc Menu” 81
- “Disc Name” 66
- “Disc Protect” 66
- “Disc Setting” 66
- Disc types 28
- Display
  - front panel display 94
  - Setup Display 73
- “Divide Title” 58, 63
- Dolby Digital 23, 79, 95
- “Downmix” 79
- DTS 23, 35, 79, 95
- “DV Audio Input” 71, 80
- “DV/D8 Dubbing” 71
- “DV/D8 One Touch Dubbing” 72
- “DVD Auto Chapter” 80
- DVD VIDEO 30, 95
- DVD+R 28, 95
- DVD+R DL 28
- DVD+RW 28, 95
- DVD-R 28, 95
- DVD-RW 28, 95

## E

- Easy Setup 83
- “Edit” 52

- “Edit Playlist” 63
- “Edit Scene” 63
- Editing 55
- Enter characters 60
- “Erase” 57
- “Erase All Titles” 66

## F

- “Factory Setting” 83
- Fast forward 34
- Fast reverse 34
- Feature settings 80
- Finalizing 67
- “Format DVD” 81
- “Front Display” 82
- Front panel 91
- Front panel display 94

## H

Handling discs 88

## I

- i.LINK 69, 90
- INPUT SELECT 46, 70
- Interlace format 96

## J

JPEG image files 41

## L

- “Language” 81
- Language Abbreviation 96
- LINE 1 IN 27
- LINE 2 IN 26
- “Line Audio Input” 50, 54, 80

## M

- Manual Clock Set 76
- “Manual Set” 75
- MARKER 39
- MENU 32
- Menu
  - Top menu 32
- “Modify” 63
- “Move” 63
- MP3 audio tracks 40

## **N**

NEXT 34  
Number buttons 20, 38

## **O**

One Touch Dubbing 72  
On-screen display  
    Setup Display 73  
    Sub-menu 10  
    System Menu 10  
    TOOLS menu 11  
Options settings 81  
Original 38, 96  
ORIGINAL/PLAYLIST 38, 56  
“OSD” language 22, 81

## **P**

“Parental” 82  
Parental Control 36  
Parts and controls 91  
PAUSE 34, 47  
PBC 36  
“Picture control” 77  
PLAY 32  
Playable discs 30  
Playback 32  
    MP3 audio tracks 40  
    Repeat Play 35  
    Resume Play 36  
    Slow-motion play 33  
Playlist 38, 61, 96  
Power cord 19  
PREV 34  
“Progressive” 77  
Progressive format 96  
“Protect” 57

## **Q**

Quick Timer 47

## **R**

Rear panel 94  
REC 47  
REC MODE 47

Recording 45  
    recordable discs 28  
    recording format 28  
    recording mode 45  
    while watching another  
        program 47

Recording mode 45  
Recording time 45, 48  
Region code 31  
Remote 19, 92  
REPEAT 35  
Repeat A-B Play 36  
REPLAY 34  
Resetting 83  
Resume Play 36  
Rotate 42

## **S**

SAP (Second Audio Program) 45  
Satellite receiver 13  
“Scan Audio” 36, 79  
Searching  
    for “Chapter” 38  
    for “Title” 38  
    for “Track” 38  
    Time Search 38  
Settings 73  
Setup Display 73  
Stereo programs 45  
STOP 32, 47  
Sub-menu 10  
SUBTITLE 33  
“Subtitle” 81  
SURROUND 34  
SYNCHRO REC 51  
System Menu 10

## **T**

“Time Zone” 76  
TIME/TEXT 44  
TIMER 49  
Timer List 52  
Timer recording 48  
    change or cancel 52  
Title 96  
“Title Erase” 57, 63  
TITLE LIST 37, 56  
Title List 37

“Title Name” 57, 63  
TOOLS 11  
TOP MENU 32  
Track 96  
Troubleshooting 84  
“Tuner Audio” 78  
Tuner Preset 23  
Tuner Preset settings 74  
“TV Type” 76  
TV/DVD 20  
TV/VIDEO 47

## **U**

“Unfinalize” 68  
Unrecordable pictures 46

## **V**

VIDEO CD 30  
Video mode 28  
Video settings 76  
VR mode 28

## **Z**

ZOOM 33  
Zoom 42

<http://www.sony.net/>