

SYLVANIA

Owner's Manual

DVD Recorder

DVR90DEA

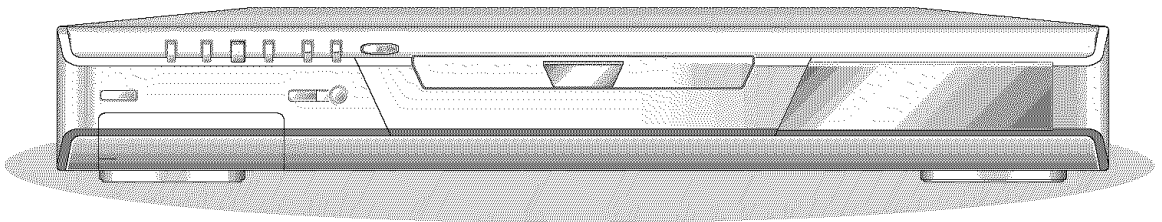

INSTRUCCIONES EN ESPAÑOL INCLUIDAS.

Supplied Accessory

- Remote control (NB001UD) with two AA batteries
- RF cable (WPZ0901TM002 or WPZ0901CAB01)
- Audio/Video cables (WPZ0102TM015 or WPZ0102LTE01)
- Owner's Manual (IVMN20110)
- Quick Use Guide (0VMN04181)

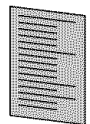
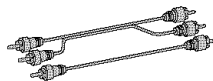
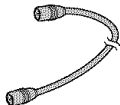

Please read before using this equipment.
If you need additional operating assistance after reading this owner's manual or to order replacement accessories, please call
TOLL FREE : 1-800-968-3429
or visit our web site at <http://www.funai-corp.com>

**Before you use this unit, you need to complete connections.
Refer to "Connections" on pages 13-15.**

**To record a program easily, refer to "Easy DVD recording" on pages 16-17 after connections are completed.
(You CANNOT record on any copyright protected DVD disc with this DVD recorder.)**

Before you start

Connections

Getting started

Recording

Playing discs

Editing

Changing the SETUP menu

Others

Español

Before you start

Precautions

WARNING: TO REDUCE THE RISK OF FIRE OR ELECTRIC SHOCK, DO NOT EXPOSE THIS APPLIANCE TO RAIN OR MOISTURE.



CAUTION

RISK OF ELECTRIC SHOCK
DO NOT OPEN



CAUTION:
TO REDUCE THE RISK OF ELECTRIC SHOCK, DO NOT REMOVE COVER (OR BACK). NO USER SERVICEABLE PARTS INSIDE. REFER SERVICING TO QUALIFIED SERVICE PERSONNEL.



The lightning flash with arrowhead symbol, within an equilateral triangle, is intended to alert the user to the presence of uninsulated "dangerous voltage" within the product's enclosure that may be of sufficient magnitude to constitute a risk of electric shock to persons.



The exclamation point within an equilateral triangle is intended to alert the user to the presence of important operating and maintenance (servicing) instructions in the literature accompanying the appliance.

Laser Safety

This unit employs a laser. Only a qualified service person should remove the cover or attempt to service this device, due to possible eye injury.

CAUTION: USE OF CONTROLS OR ADJUSTMENTS OR PERFORMANCE OF PROCEDURES OTHER THAN THOSE SPECIFIED HEREIN MAY RESULT IN HAZARDOUS RADIATION EXPOSURE.

CAUTION: VISIBLE AND INVISIBLE LASER RADIATION WHEN OPEN AND INTERLOCK DEFEATED. DO NOT STARE INTO BEAM.

LOCATION: INSIDE, NEAR THE DECK MECHANISM.

FCC WARNING- This equipment may generate or use radio frequency energy. Changes or modifications to this equipment may cause harmful interference unless the modifications are expressly approved in the instruction manual. The user could lose the authority to operate this equipment if an unauthorized change or modification is made.

RADIO-TV INTERFERENCE

This equipment has been tested and found to comply with the limits for a Class B digital device, pursuant to Part 15 of the FCC Rules. These limits are designed to provide reasonable protection against harmful interference in a residential installation. This equipment generates, uses, and can radiate radio frequency energy and, if not installed and used in accordance with the instructions, may cause harmful interference to radio communications. However, there is no guarantee that interference will not occur in a particular installation. If this equipment does cause harmful interference to radio or television reception, which can be determined by turning the equipment off and on, the user is encouraged to try to correct the interference by one or more of the following measures:

- 1) Reorient or relocate the receiving antenna.
- 2) Increase the separation between the equipment and receiver.
- 3) Connect the equipment into an outlet on a circuit different from that to which the receiver is connected.
- 4) Consult the dealer or an experienced radio/TV technician for help.

This Class B digital apparatus complies with Canadian ICES-003.

Cet appareil numérique de la classe B est conforme à la norme NMB-003 du Canada.

CAUTION: TO PREVENT ELECTRIC SHOCK, MATCH WIDE BLADE OF PLUG TO WIDE SLOT, FULLY INSERT.

ATTENTION: POUR ÉVITER LES CHOC ÉLECTRIQUES, INTRODUIRE LA LAME LA PLUS LARGE DE LA FICHE DANS LA BORNE CORRESPONDANTE DE LA PRISE ET POUSSER JUSQU'AU FOND.

A NOTE ABOUT RECYCLING

This product's packaging materials are recyclable and can be reused. Please dispose of any materials in accordance with your local recycling regulations.

Batteries should never be thrown away or incinerated but disposed of in accordance with your local regulations concerning chemical wastes.

Make your contribution to the environment!!!

- Used up batteries do not belong in the dust bin.
- You can dispose of them at a collection point for used up batteries or special waste. Contact your council for details.



For Customer Use:

Read carefully the information located at the back of this unit and enter below the Serial No. Retain this information for future reference.

Model No. _____

Serial No. _____

Important Safeguards

1. Read Instructions - All the safety and operating instructions should be read before the appliance is operated.
2. Retain Instructions-The safety and operating instructions should be retained for future reference.
3. Heed Warnings - All warnings on the appliance and in the operating instructions should be adhered to.
4. Follow Instructions - All operating and use instructions should be followed.
5. Cleaning - Unplug this product from the wall outlet before cleaning. Do not use liquid cleaners or aerosol cleaners. Use a damp cloth for cleaning.
EXCEPTION:A product that is meant for uninterrupted service and, that for some specific reason, such as the possibility of the loss of an authorization code for a CATV converter, is not intended to be unplugged by the user for cleaning or any other purpose, may exclude the reference to unplugging the appliance in the cleaning description otherwise required in item 5.
6. Attachments - Do not use attachments not recommended by the product manufacturer as they may cause hazards.
7. Water and Moisture- Do not use this product near water, for example, near a bath tub, wash bowl, kitchen sink, or laundry tub, in a wet basement, or near a swimming pool, and the like.
8. Accessories - Do not place this product on an unstable cart, stand, tripod, bracket, or table. The product may fall, causing serious injury to a child or adult, and serious damage to the appliance. Use only with a cart, stand, tripod, bracket, or table recommended by the manufacturer, or sold PORTABLE CART WARNING (Symbol provided by RETAC)

S3125A appliance should follow the manufacturer's instructions and should use a mounting accessory recommended by the manufacturer. An appliance and cart combination should be moved with care. Quick stops, excessive force, and uneven surfaces may cause the appliance and cart combination to overturn.
9. Ventilation - Slots and openings in the cabinet are provided for ventilation and to ensure reliable operation of the product and to protect it from overheating, and these openings must not be blocked or covered. The openings should never be blocked by placing the product on a bed, sofa, rug, or other similar surface. This product should not be placed in a built-in installation such as a bookcase or rack unless proper ventilation is provided or the manufacturer's instructions have been adhered to.
10. Power Sources - This product should be operated only from the type of power source indicated on the marking label. If you are not sure of the type of power supply to your home, consult your appliance dealer or local power company. For products intended to operate from battery power, or other sources, refer to the operating instructions.
11. Grounding or Polarization - This product is equipped with a polarized alternating-current line plug (a plug having one blade wider than the other). This plug will fit into the power outlet only one way. This is a safety feature. If you are unable to insert the plug fully into the outlet, try reversing the plug. If the plug should still fail to fit, contact your electrician to replace your obsolete outlet. Do not defeat the safety purpose of the polarized plug.
12. Power Cord Protection - Power supply cords should be routed so that they are not likely to be walked on or pinched by items placed upon or against them, paying particular attention to cords at plugs, convenience receptacles, and the point where they exit from the appliance.
13. Outdoor Antenna Grounding - If an outside antenna or cable system is connected to the product, be sure the antenna or cable system is grounded so as to provide some protection against voltage surges and built-up static charges. Article 810 of the National Electrical Code, ANSI/NFPA No. 70, provides information with regard to proper grounding of the mast and sup-

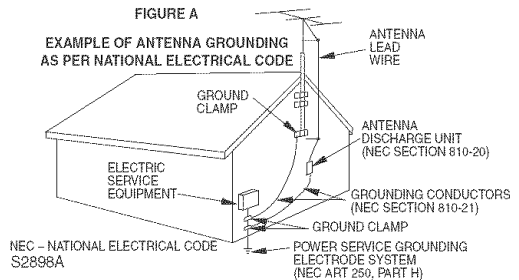
porting structure, grounding of the lead-in wire to an antenna discharge unit, size of grounding conductors, location of antenna-discharge unit, connection to grounding electrodes, and requirements for the grounding electrode. (Fig. A)



14. Lightning - For added protection for this product during a lightning storm, or when it is left unattended and unused for long periods of time, unplug it from the wall outlet and disconnect the antenna or cable system. This will prevent damage to the product due to lightning and power-line surges.
15. Power Lines - An outside antenna system should not be located in the vicinity of overhead power lines or other electric light or power circuits, or where it can fall into such power lines or circuits. When installing an outside antenna system, extreme care should be taken to keep from touching such power lines or circuits as contact with them might be fatal.
16. Overloading - Do not overload wall outlets and extension cords as this can result in a risk of fire or electric shock.
17. Object and Liquid Entry - Never push objects of any kind into this product through any openings as they may touch dangerous voltage points or short-out parts that could result in a fire or electric shock. Never spill liquid of any kind on the product.
18. Servicing - Do not attempt to service this product yourself as opening or removing covers may expose you to dangerous voltage or other hazards. Refer all servicing to qualified service personnel.
19. Damage Requiring Service - Unplug this product from the wall outlet and refer servicing to qualified service personnel under the following conditions:
 - a. When the power-supply cord or plug is damaged.
 - b. If liquid has been spilled, or objects have fallen into the product.
 - c. If the product has been exposed to rain or water.
 - d. If the product does not operate normally by following the operating instructions. Adjust only those controls that are covered by the operating instructions as an improper adjustment of other controls may result in damage and will often require extensive work by a qualified technician to restore the product to its normal operation.
 - e. If the product has been dropped or damaged in any way.
 - f. When the product exhibits a distinct change in performance this indicates a need for service.
20. Replacement Parts - When replacement parts are required, be sure the service technician has used replacement parts specified by the manufacturer or have the same characteristics as the original part. Unauthorized substitutions may result in fire, electric shock or other hazards.
21. Safety Check - Upon completion of any service or repairs to this product, ask the service technician to perform safety checks to determine that the product is in proper operating condition.
22. Heat - This product should be situated away from heat sources such as radiators, heat registers, stoves, or other products (including amplifiers) that produce heat.

Before you start

Precautions (cont'd)

Installation Location

For safety and optimum performance of this unit:

- Install the unit in a horizontal and stable position. Do not place anything directly on top of the unit. Do not place the unit directly on top of the TV.
- Shield it from direct sunlight and keep it away from sources of intense heat. Avoid dusty or humid places. Avoid places with insufficient ventilation for proper heat dissipation. Do not block the ventilation holes on the sides of the unit. Avoid locations subject to strong vibration or strong magnetic fields.

Avoid the Hazards of Electrical Shock and Fire

- Do not handle the power cord with wet hands.
- Do not pull on the power cord when disconnecting it from AC wall outlet. Grasp it by the plug.
- If, by accident, water is spilled on this unit, unplug the power cord immediately and take the unit to our Authorized Service Center for servicing.

Moisture Condensation Warning

Moisture condensation may occur inside the unit when it is moved from a cold place to a warm place, or after heating a cold room or under conditions of high humidity. Do not use this unit at least for 2 hours until its inside gets dry.

About Copyright

Unauthorized copying, broadcasting, public performance and lending of discs are prohibited.

This product incorporates copyright protection technology that is protected by method claims of certain U.S. patents and other intellectual property rights owned by Macrovision Corporation and other rights owners. Use of this copyright protection technology must be authorized by Macrovision Corporation, and is intended for home and other limited viewing uses only unless otherwise authorized by Macrovision Corporation. Reverse engineering or disassembly is prohibited.







Notice for progressive scan outputs

Consumers should note that not all high definition television sets are fully compatible with this product and may cause artifacts to be displayed in the picture. In case of 525 progressive scan picture problems, it is recommended that the user switch the connection to the 'standard definition' output. If there are questions regarding our TV set compatibility with this model 525p DVD recorder, please contact our customer service center.

Symbol in this owner's manual

Many functions of this DVD recorder are depending on the disc type or the recording mode.

To specify for what disc type or recording mode each function is, we put the following symbols at the beginning of each item to operate.

Symbol	Description
	Available to DVD Video discs
	Available to DVD-RW in Video mode
	Available to DVD-RW in VR mode
	Available to DVD-R discs
	Available to Audio CDs
	Available to CD-R/RW discs with MP3 files

Maintenance

SERVICING

- Please refer to relevant topics on the Troubleshooting Guide on pages 92-94 before returning the product.
- If this unit becomes inoperative, do not try to correct the problem by yourself. There are no user-serviceable parts inside. Turn off, unplug the power plug, and please call our help line mentioned on the front page to locate an Authorized Service Center.

CLEANING THE CABINET

- Use a soft cloth slightly moistened with a mild detergent solution. Do not use a solution containing alcohol, spirits, ammonia or abrasive.

CLEANING DISCS

- When a disc becomes dirty, clean it with a cleaning cloth. Wipe the disc from the center out. Do not wipe in a circular motion.
- Do not use solvents such as benzene, thinner, commercially available cleaners, detergent, abrasive cleaning agents or antistatic spray intended for analogue records.

CLEANING THE DISC LENS

- If this unit still does not perform properly although you refer to the relevant sections and to "TROUBLESHOOTING GUIDE" in this Owner's Manual, the laser optical pickup unit may be dirty. Consult your dealer or an Authorized Service Center for inspection and cleaning of the laser optical pickup unit.

DISC HANDLING

- Handle the discs so that fingerprints and dust do not adhere to the surfaces of the discs.
- Always store the disc in its protective case when it is not used.

Table of contents

Before you start	2	Skipping TV commercials during play	47
Precautions	2	Pause	47
Table of contents	5	Step by step playback	48
Features	6	Slow forward / Slow reverse play	48
Functional overview	7	Zoom	49
Installing batteries in the remote control	9	Marker Setup	49
Using a remote control	9	Search	50
SETUP/DISC/CD menu	10	Title/Chapter search	50
DISPLAY menu	11	Track search	51
Connections	13	Time search	51
Connection to a TV	13	Repeat/Random/Program playback	52
Connection to a cable box or satellite box	14	Repeat play	52
When connecting to a cable box or satellite box with only a few scrambled channels	14	Random playback	52
When connecting to a cable box or satellite box with many scrambled channels	14	Program play	53
Connection to an Audio System	15	Selecting the format of audio and video	54
Getting started	16	Switching audio soundtrack	54
Easy DVD recording	16	Switching subtitles	55
Channel setting	18	Switching camera angles	56
Getting channels automatically	18	Reducing block noise	56
Adding/deleting channels	19	Editing	57
Selecting the TV stereo or SAP	20	Information on disc editing	57
Clock setting	21	Guide to a title list	57
Auto Clock Setting	21	Editing discs with Video mode	57
Manual Clock Setting	22	Editing discs with VR mode	58
Setting the daylight saving time	24	Editing DVD-RW discs in Video mode	59
Selecting the TV aspect ratio	25	Deleting titles	59
Recording	26	Putting names on titles	60
Information on DVD recording	26	Setting or clearing chapter markers	62
Information	26	Editing DVD-RW discs in VR mode (Original)	63
Recording speed	26	Deleting titles	63
Restrictions on recording	26	Deleting parts of titles	64
Information on copy control	27	Putting names on titles	65
Making discs playable in other DVD player (Finalize)	27	Setting or clearing chapter markers	67
Formatting a disc	28	Setting pictures for thumbnails	68
Settings for the recording format to a blank disc	28	Setting titles to protect	70
Reformatting a disc	30	Releasing titles from protecting	71
Basic recording	31	Editing DVD-RW discs in VR mode (Playlist)	72
Checking the recording picture quality	32	Deleting titles	72
One-touch timer recording	33	Deleting parts of titles	73
Timer recording	34	Putting names on titles	74
Hints for timer recording	36	Setting or clearing chapter markers	76
Settings for an external source	37	Setting pictures for thumbnails	77
Connection to an external source	37	Adding titles to a Playlist	79
Recording from an external source	38	Deleting a Playlist	80
Finalizing the discs	39	Editing DVD-R discs	81
Setting a disc to protect	40	Deleting titles	81
Playing discs	41	Putting names on titles	82
Information on DVD play	41	Changing the SETUP menu	83
Guide to displays	41	Tour of the SETUP menu	83
Basic playback	42	Settings for Language	84
Playback	42	Settings for Display	86
Playing discs using the disc menu	44	Settings for Audio	88
Playing discs using the title menu	45	Settings for Parental lock level	90
Special playback	46	Others	92
Resume play	46	Troubleshooting	92
Fast forward / Fast reverse	46	Language code	95
		Glossary	96
		Specifications	97
		Español	98

Before you start

Features

This DVD unit not only plays DVD's and CD's but also offers features for you to record to DVD discs and edit them after that.

The following features are offered with this DVD recorder.

Recording

This DVD recorder is compatible with both DVD-RW, which is rewritable repeatedly, and DVD-R, which is available for recording once. You can choose either one for your convenience.

Up to 8 program recording:

You can program the DVD recorder to record up to 8 programs, up to a year in advance. Daily or weekly program recordings are also available.

One-touch timer recording:

You can easily set a recording time as you prefer. Every time the REC button pressed during recording, the recording time will be increased by 30 minutes up to 4 hours. The recording automatically stops when the recording time you set is reached.

REC MONITOR:

You can confirm the picture quality for recording in the current recording speed which you set. If you want to change the recording speed, press REC SPEED button to set the desired recording mode.

Automatic Chapter marker setting:

Chapter markers will be put on recordings as you set in SETUP menu before attempting to record.

Automatic Title menu making:

The DVD recorder makes title menus automatically when finalizing the disc which are recorded in Video mode.

Automatic PLAYLIST making (VR mode):

A Playlist will be prepared from an Original list, so that you can edit titles in a Playlist as you prefer. An Original list is kept as it is.

Play

Theater surround sound in your home:

When connecting the DVD recorder to an amplifier or a decoder which is compatible with Dolby Digital, you are allowed to experience the theater surround sound from discs with surround sound system.

Quick search for what you want to watch:

You can easily find the part you want to watch using the search function. Search for a desired point on a disc by title, chapter, or time.

Start to play from Original and Playlist:

Title playing is available from either an Original list or Playlist.

Editing

Setting/Clearing chapter markers:

You can easily add chapter markers anywhere in your recordings for easy editing. (VR mode)

Making your own Playlist:

With the original remains as it is, you can edit titles on various Playlist as you prefer.

Putting names on titles

Setting pictures for thumbnails

Setting/clearing chapter markers

Deleting parts of titles etc

Protecting titles:

To avoid editing or erasing titles, the protect function is useful when it is ON in the original list.

Compatibility

Available for playing discs recorded in Video mode on a regular DVD player (Video mode):

Discs recorded in Video mode can be played on regular DVD players, including computer DVD drives compatible with DVD-Video playback*. You will need to finalize the discs recorded in Video mode to play in other DVD players.

** DVD-Video Format (Video mode) is a new format for recording on DVD-R/RW discs that was approved by the DVD Forum in 2000. Adoption of this format is optional for manufactures of DVD playback devices, and there are DVD-Video players, DVD-ROM drives or other DVD playback devices that do not play DVD-R/RW discs recorded in the DVD-Video Format.*

Others

Progressive Scan system

Unlike conventional interlace scanning, the progressive scan system provides less flickering and images in higher resolution than that of traditional television signals.

Manufactured under license from Dolby Laboratories. "Dolby" and the double-D symbol are trademarks of Dolby Laboratories.

Before you start

Functional overview

Front Panel

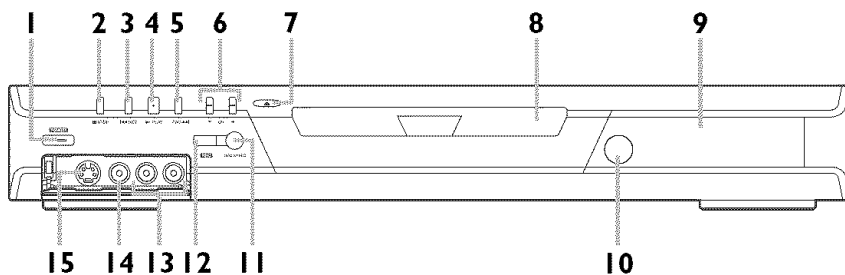

- 1. POWER button**
Press to turn the DVD recorder on and off.
If timer programmings have been set, press to set the unit in timer-standby mode.
- 2. STOP ■ button**
Press to stop play or recording.
- 3. REV ◀◀ button**
Press to skip to the previous chapter or track.
Press and hold for 1.5 seconds to fast reverse.
- 4. PLAY ▶▶ button**
Press to start or resume play.
- 5. FWD ▶▶▶ button**
Press to skip to the next chapter or track.
Press and hold for 1.5 seconds to fast forward.
- 6. CH ▼ / ▲ button**
Press to change the channel up and down.
- 7. ▲ (OPEN/CLOSE) button**
Press to open or close the disc tray.
- 8. Disc tray**
Place a disc when open.
- 9. Display**
Refer to "Guide to Displays on the front panel" on page 12.
- 10. Remote control sensor**
Receive signals from your remote control so that you can control the DVD recorder from a distance.
- 11. REC SPEED button**
Press to switch the recording speed.
- 12. REC button**
Press to start recording.
- 13. AUDIO INPUT jacks (LINE2)**
Use to connect external equipment with standard audio cables.
- 14. VIDEO INPUT jack (LINE2)**
Use to connect external equipment with a standard video cable.
- 15. S-VIDEO INPUT jack (LINE2)**
Use to connect the S-Video output of external equipment with an S-Video cable.

Rear Panel

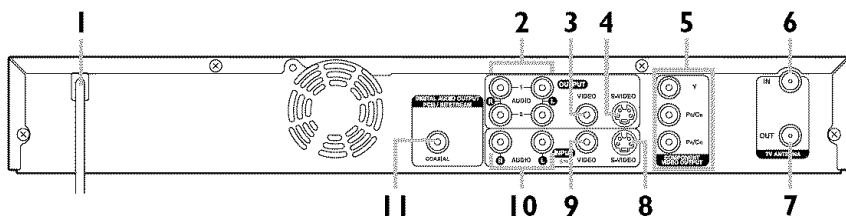

- 1. AC Power Cord**
Connect to a standard AC outlet to supply power to this unit.
- 2. AUDIO OUTPUT jacks 1, 2**
Use to connect a TV monitor, AV receiver or other equipment with standard audio cables.
- 3. VIDEO OUTPUT jack**
Use to connect a TV monitor, AV receiver or other equipment with a standard video cable.
- 4. S-VIDEO OUTPUT jack**
Use to connect the S-Video input of a TV monitor, AV receiver or other equipment with an S-Video cable.
- 5. COMPONENT VIDEO OUTPUT jacks**
Use to connect a TV monitor with component video inputs with component video cables.
- 6. TV ANTENNA IN jack**
Use to connect an antenna.
- 7. TV ANTENNA OUT jack**
Use to connect an antenna cable to pass the signal from the TV ANTENNA IN to your TV monitor.
- 8. S-VIDEO INPUT jack(LINE1)**
Use to connect the S-Video output of external equipment with an S-Video cable.
- 9. VIDEO INPUT jack(LINE1)**
Use to connect external equipment with a standard video cable.
- 10. AUDIO INPUT jacks(LINE1)**
Use to connect external equipment with standard audio cables.
- 11. COAXIAL DIGITAL AUDIO OUTPUT jack**
Use to connect an AV receiver, Dolby Digital decoder or other equipment with a coaxial digital input with a digital coaxial cable.

Note

- Do not touch the inner pins of the jacks on the rear panel. Electrostatic discharge may cause permanent damage to the DVD recorder.
- This unit does not have the RF modulator.

Before you start

Functional overview (cont'd)

Remote Control

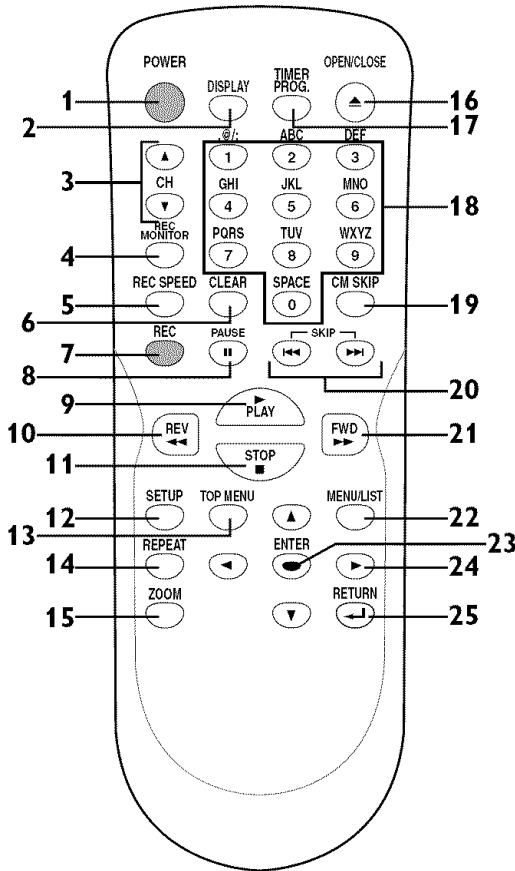

1. POWER button

Press to turn the DVD recorder on and off. If timer programmings have been set, press to set the unit in timer-standby mode.

2. DISPLAY button

Press to display or change the on-screen display.

3. CH ▲ / ▼ buttons

Press to change the channel up and down.

4. REC MONITOR button

Press to check the video to be recorded before attempting.

5. REC SPEED button

Press to switch the recording speed.

6. CLEAR button

Press to clear the password once entered or to cancel the programming for CD or to clear the selecting marker number in the marker setup mode or to clear the program once entered in the timer recording setting mode, etc.

7. REC button

Press once to start a recording. Press repeatedly to start a One-Touch Recording.

8. PAUSE button

Press to pause play or recording.

9. PLAY button

Press to start or resume play.

10. REV button

During playback, press to play fast reverse. Or during playback is paused, press to play slow reverse.

11. STOP button

Press to stop play or recording.

12. SETUP button

Press to display the setup menu. During DVD playback, press and hold for more than 3 seconds to switch to the progressive scanning mode or the interlace mode.

13. TOP MENU button

Press to display the top menu.

14. REPEAT button

Press to display the repeat setting menu.

15. ZOOM button

During playback, press to enlarge the picture on the screen.

16. OPEN/CLOSE button

Press to open or close the disc tray.

17. TIMER PROG. button

Press to display the timer program setting menu.

18. Number buttons

Press to select channel numbers. Press to select a title/chapter/track on display or a TV channel.

Or press to enter values for the settings in the SETUP menu.

19. CM SKIP button

During playback, press to skip the 30 seconds.

20. SKIP button

During playback, press to skip to the previous chapter or track. Or during play is paused, press to play reverse step by step.

SKIP button

During playback, press to skip to the next chapter or track. Or during playback is paused, press to play forward step by step.

21. FWD button

During playback, press to play fast forward.

Or during playback is paused, press to play slow forward.

22. MENU/LIST button

Press to display the Disc menu.

To change ORIGINAL and PLAYLIST on the TV screen. (VR mode only)

23. ENTER button

Press to confirm or select menu items.

24. ▲ / ▼ / ◀ / ▶ buttons

Press to select items or settings.

25. RETURN button

Press to return to the previously displayed menu screen.

Functional overview (cont'd)

Installing batteries in the remote control

Install two AA batteries (supplied) matching the polarity indicated inside battery compartment of the remote control.

1

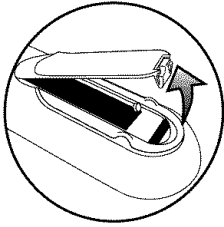

2

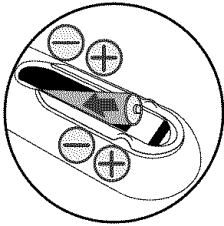

3

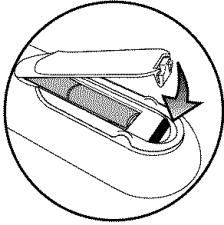

Note:

Incorrect use of batteries can result in hazards such as leakage and bursting. Please observe the following:

- Do not mix new and old batteries together.
- Do not use different kinds of batteries together, although they may look similar, different batteries may have different voltages.
- Make sure that the plus and minus ends of each battery match the indications in the battery compartment.
- Remove batteries from equipment that is not going to be used for a month or more.
- When disposing of used batteries, please comply with governmental regulations or environmental public instruction's rules that apply in your country or area.
- Do not recharge, short-circuit, heat, burn or disassemble batteries.

Using a remote control

Keep in mind the following when using the remote control:

- Make sure that there is no obstacle between the remote control and the remote sensor on the DVD recorder.
- Use within the operating range and angle as shown.
- Remote operation may become unreliable if strong sunlight or fluorescent light is shining on the remote sensor of the DVD recorder.
- Remote control for different devices can interfere with each other. Avoid using remote control for other equipment located close to the DVD recorder.
- Replace the batteries when you notice a fall off in the operating range of the remote control.

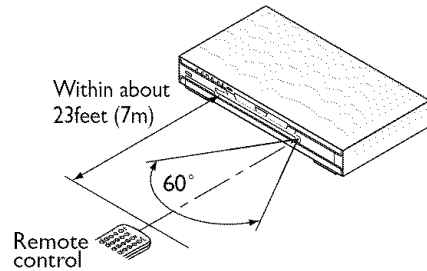

Before you start

Functional overview (cont'd)

Guide to Displays on screen menu

The DVD recorder uses the following types of display for most operations. SETUP/DISC/CD menu, Title list, and DISPLAY, which allows you to change the playing status of disc during play. DISPLAY also gives you some disc information for checking the status of the disc.

SETUP/DISC/CD menu

Press SETUP button to display the setup main menu, then choose either of SETUP/DISC/CD by ▲ / ▼ / ◀ / ▶ button. Then, press ENTER button to display each menu.

These provides entries to all main functions of the DVD recorder.

“SETUP” is available only in the Stop mode.

“DISC” is available only when a DVD-R/RW disc is inserted into the DVD recorder. When playing back a DVD-Video disc (commercially available) or the finalized DVD-R disc, you cannot select “DISC”.

“CD” is available only when an Audio CD disc or a CD-R/RW disc with MP3 files is inserted into the DVD recorder.

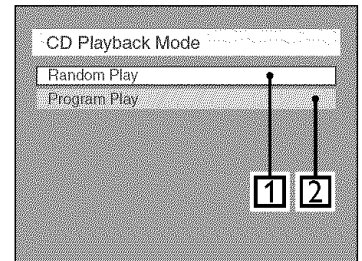
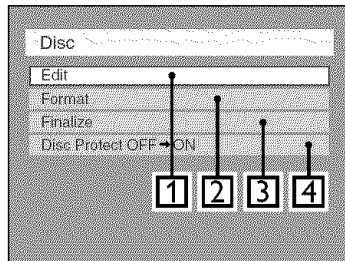
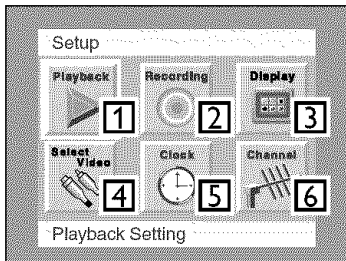
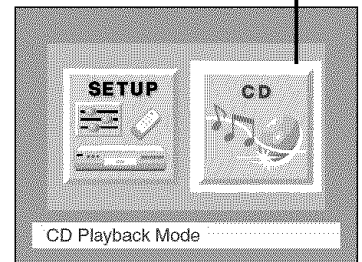
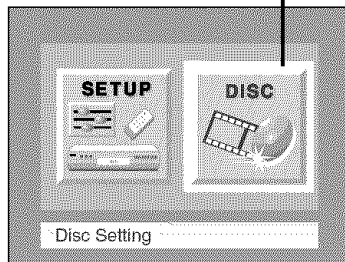
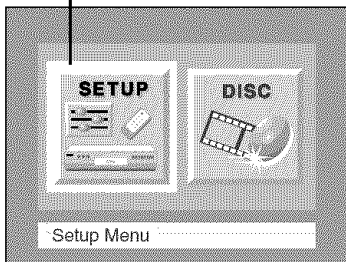

1. Playback:

To set up the DVD recorder to play discs as you prefer.

2. Recording:

To set up the DVD recorder to record to discs as you prefer.

3. Display:

To set up the OSD screen and the front display of the DVD recorder as you prefer.

4. Select Video:

To choose a line input to record to DVD discs from other video equipment.

5. Clock:

To set up the clock of the DVD recorder as you need.

6. Channel:

To make the channel setting of the DVD recorder as you prefer.

10

1. Edit:

Turns on a title list. (When a disc with VR mode is inserted, 'Original' or 'PlayList' is available.), which shows the recorded titles on the disc.

2. Format:

Allows you to erase all of the recorded content on the disc. The disc will be completely blank.

3. Finalize:

Allows you to finalize a disc recorded titles.

4. Disc Protect (VR mode only):

Allows you to protect a disc from accidental editing or recording.

1. Random Play:

To set the random play programming.

2. Program Play:

To set the program playing.







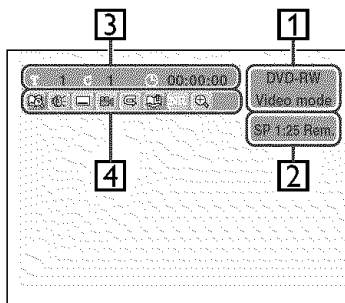

DISPLAY menu

Press DISPLAY button to call up the display menu. This menu will give you the information on the playing disc. Some operations are available while disc is playing.

Details are on page 41.



1. Indicates a disc type and a format mode.
2. Indicates a recording mode and possible recording time.
3. Indicates a title number, chapter number, and the time lapse of disc play.
4. Each icon means:

-  : Search
-  : Audio
-  : Subtitle
-  : Angle (except VR mode)
-  : Repeat
-  : Marker
-  : Noise Reduction
-  : Zoom



Before you start

Functional overview (cont'd)

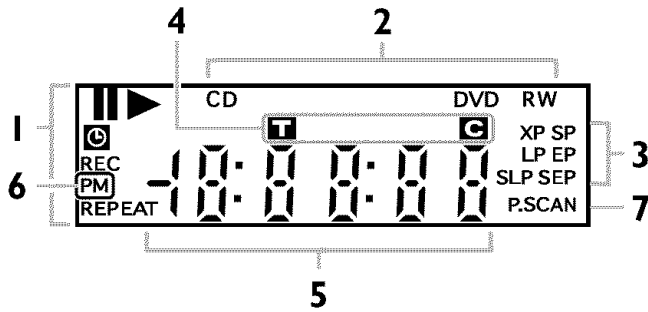
Guide to Displays on the front panel



1. Current status of the DVD recorder

-  : Appears when a disc play is paused.
-  : Appears when playing a disc.
-  : Appears when the timer programming has been set and is proceeding.
- REC** : Appears during recording process.
- REPEAT** : Appears when repeat play.



2. Disc type

- CD** : Appears when an audio CD or a disc with MP3 files is inserted in the disc tray.
- DVD** : Appears when a DVD disc is inserted in the disc tray.
- DVD R** : Appears when a DVD-R disc is inserted in the disc tray.
- DVD RW** : Appears when a DVD-RW disc is inserted in the disc tray.

3. Recording speed

Indicates the recording speed of the disc.

4. Title/Track and Chapter mark

-  : Appears when indicating a title/track number.
-  : Appears when indicating a chapter number.

5. Displays the following

- Playing time / remaining time
- Current title / chapter / track number
- Recording time
- Clock
- Channel number
- OTR remaining time

6. PM : Appears in the afternoon with the clock displaying.

7. P.SCAN :

Appears when the progressive scan system is activated.

Display message

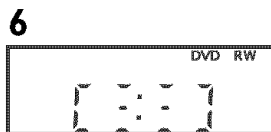
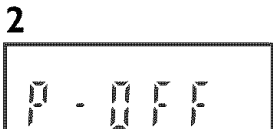

1. Appears when the DVD recorder is powered on.
2. Appears when the DVD recorder is powered off.
3. Appears when the disc tray is opening.
4. Appears when the disc tray is closing or close.
5. Appears when a disc is loading in the disc tray.
6. Appears when recording data is writing on to the disc.

Connections

Connection to a TV

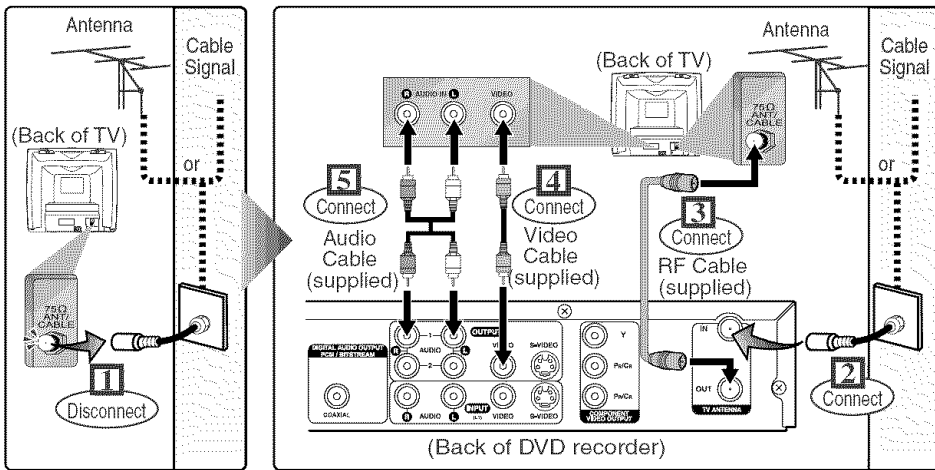

6 Plug in the AC power cord of the DVD recorder.

Make one of the following connections, depending on the capabilities of your existing equipment.

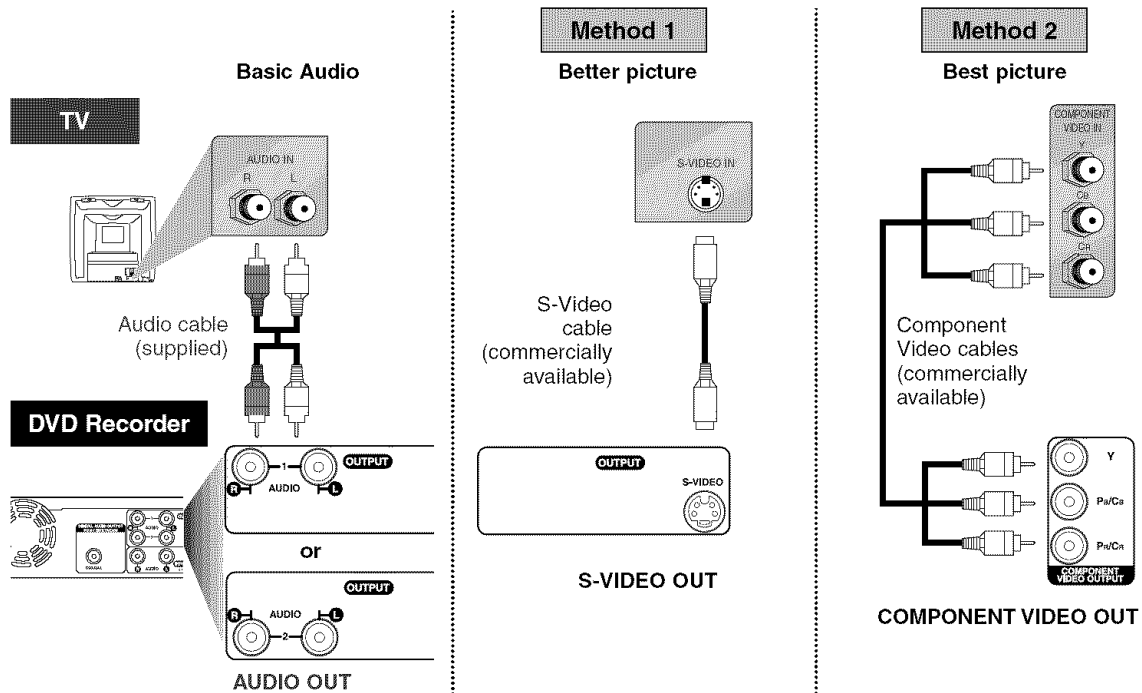

Note

- Connect this unit directly to the TV. If the A/V cables are connected to a VCR, pictures may be distorted due to the copy protection system.
- When progressive scanning mode is selected, no video signal will be output from the VIDEO OUT or S-VIDEO OUT jack.

If your TV is compatible with 525p (480p) progressive scanning and you want to enjoy that high quality picture:

You must select the connection Method 2 above and progressive scanning mode. To set the mode, press and hold the SETUP button on the remote control for more than 3 seconds during DVD playback, so that "PSCAN" will appear on the display of this unit.

If your TV is not compatible with progressive scanning:

Use this unit in interlace mode. Make sure that no "PSCAN" is on the display of this unit. If not, press and hold the SETUP button on the remote control for more than 3 seconds during DVD playback, so that "PSCAN" on the display of this unit will disappear.

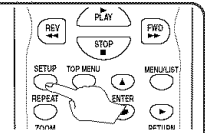

more than 3 seconds during DVD playback [Interlace mode]

[Progressive scanning mode]

Connections

Connection to a cable box or satellite box

A When connecting to a cable box or satellite box with only a few scrambled channels

If you are using a cable box or satellite box with only a few scrambled channels, follow the setup on this page. If many or all the channels are scrambled, we recommend using the setup on the following page.

With this setup:

- You can record any unscrambled channel by selecting the channel on the DVD recorder.
- You cannot record scrambled channels that require a cable box or satellite box.

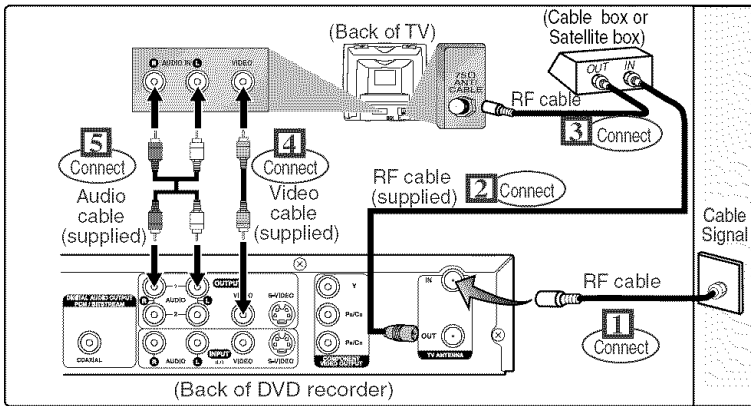

B When connecting to a cable box or satellite box with many scrambled channels

If many or all the channels you receive by cable or satellite are scrambled, we recommend using this setup.

With this setup:

- You can record any unscrambled channel by selecting the channel on the cable box or satellite box. Be sure that the cable box or satellite box is turned on.
- You cannot record one channel while watching another channel.

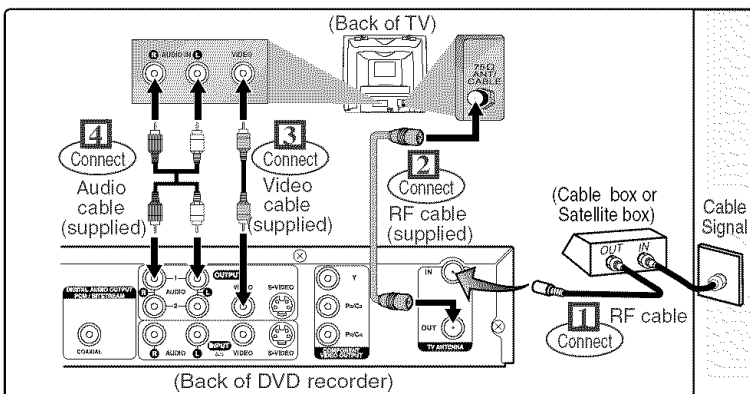

Note to the Cable TV System Installer :

This reminder is provided to call the Cable TV system installer's attention to Article 820-40 of the National Electrical Code, which provides guidelines for proper grounding - in particular, specifying that the cable ground shall be connected to the grounding system of the building, as close to the point of cable entry as possible.

Connection to an Audio System

- When you change the connections, all devices should be turned off.
- Refer to each owner's manual for further information on other devices.

Method 1

Stereo system

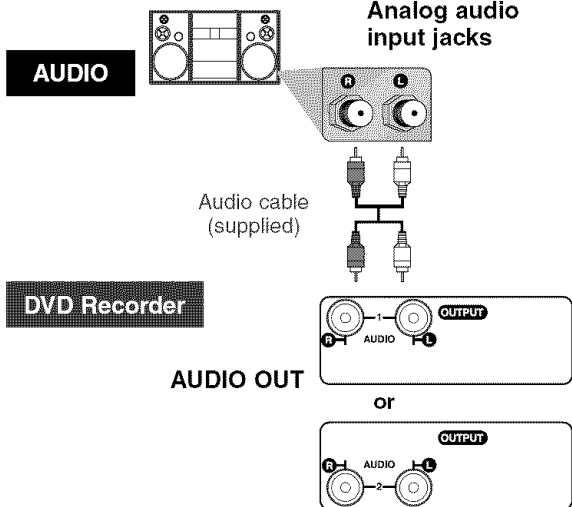

Method 2

Dolby Digital decoder,
MD deck or DAT deck

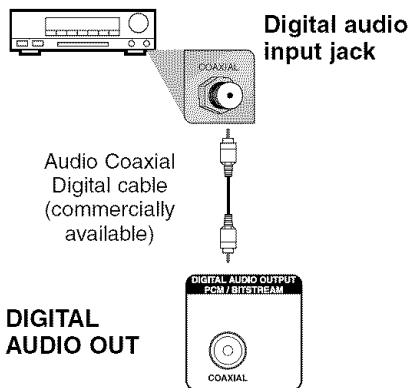

Note

- If output is Dolby Digital encoded audio, connect to a Dolby Digital decoder, and set "Dolby Digital" to "Stream" for the "Digital Out" setting in the SETUP menu. (Refer to pages 88-89.)
- The audio source on a disc in a Dolby Digital 5.1 channel surround format cannot be recorded as digital sound by an MD or DAT deck.
- Unless connected to a Dolby Digital decoder, set "Dolby Digital" to "PCM" for the "Digital Out" setting in the SETUP menu. Playing a DVD using incorrect settings may generate noise distortion, and may also damage the speakers. (Refer to pages 88-89.)
- Set "Dolby Digital" to "PCM" for the "Digital Out" setting in the SETUP menu for connecting to an MD deck or DAT deck. (Refer to pages 88-89.)
- By hooking this unit up to a Multi-channel Dolby Digital decoder, you can enjoy high-quality Dolby Digital 5.1 channel surround sound as heard in the movie theaters.

Getting started

Easy DVD recording

The following will help you to understand easily how to record to DVD discs.

Note:

Make sure batteries are in the remote control and you have connected this unit and the TV correctly.

Step 1: Choose a disc type

There are several types of DVD disc recordable to choose from. Choose an applicable type by "DVD disc types" on this page.

This DVD recorder can record on the following type of discs.



For example, when you want to record repeatedly on the same disc, or when you want to edit the disc after recording, select the rewritable DVD-RW type disc.

When you want to save recordings without any alteration, a non-rewritable DVD-R can be your choice.

Step 2: Insert a blank disc

Remote Control

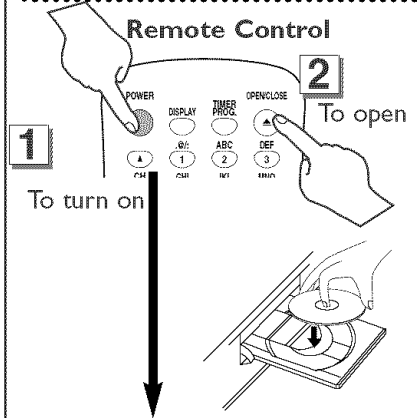

To turn on

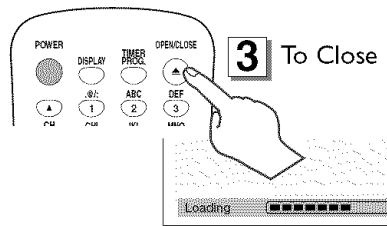

To Close

This operation may take a while to be recognized.

DVD disc types

☆☆☆: Most suitable. ☆☆☆: Can be used. ☆☆☆: Some functions are limited. —: Cannot be used.

You want to	DVD-RW VR	DVD-RW Video	DVD-R
Record TV programs	☆☆☆	☆☆☆	☆☆
Reuse by deleting unwanted contents	☆☆☆	☆☆	—
Edit recorded contents	☆☆☆	☆☆	☆☆
Edit/Record from connected equipment	☆☆☆	☆☆☆	☆☆☆
Copy discs for distribution	☆☆ ^{*1}	☆☆☆	☆☆☆
Play on other DVD equipment	☆☆ ^{*1}	☆☆☆	☆☆☆

Features	DVD-RW VR	DVD-RW Video	DVD-R
Recording			
Rewritable?	Yes	Yes	No
Can create chapters at fixed intervals (auto.)	Yes	Yes	Yes
Can create chapters wherever you like (manual)	Yes	No	No
Can record 16:9 size pictures	Yes	Yes	Yes
Can record Copy-Once programs	Yes	No	No
Editing			
Can perform basic edit functions	Yes	Yes	Yes
Can perform advanced edit functions (Playlist edit)	Yes	No	No

^{*1} DVD-RW (VR mode) can only be played on DVD equipment that is VR compatible.

Note:

For details of the above functions and implied restrictions, see the explanations inside the manual.

Format the disc

Insert the disc in the recorder. Then, format the disc from SETUP menu. Video format (Video mode) or Video recording format (VR mode) will be available depending on the disc type inserted. This is necessary to prepare the disc for recording. Details are on pages 28-30.

Getting started

Easy DVD recording (Cont'd)

Step 3: Select the recording speed

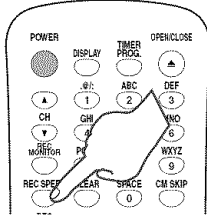

Step 4: Select the desired channel

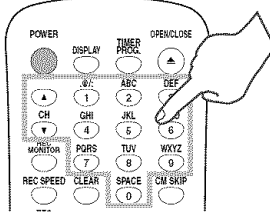

Step 5: Record to DVD discs

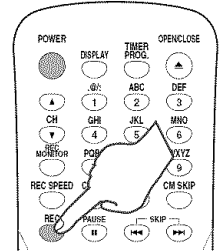

Hint 1: Play the recorded contents

You can select the title you want to play from a displayed menu, and immediately start to play. Recorded contents are very accessible on a disc, the procedure is simple really as you choose a title on a chapter from the menu screen.

What is titles and chapters?

The contents of DVD disc are generally divided into some titles. Titles may be further subdivided into chapters.

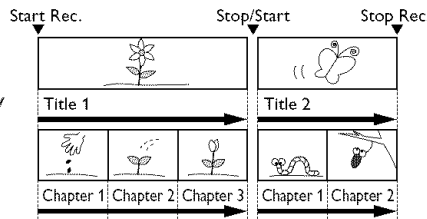

Hint 2: Edit the recorded disc

You will find editing discs is very easy, and the DVD recorder offers convenient edit functions, which are possible only with DVD-R/RW discs.

You can edit the following from a title list.

- Putting names on titles
- Setting pictures for thumbnails (VR mode)
- Setting/clearing chapter markers
- Deleting parts of titles (VR mode)

Original and Playlist (VR mode)

You can edit the recordings in Playlist without changing the original recordings. Any Playlist does not take up much disc space.

What "Original" or "Playlist" is for?

Throughout this manual, you will find *Original* and *Playlist* to refer to the actual content and the edited version.

- **Original** content refers to what's actually recorded on the disc.
- **Playlist** content refers to the edited version of the disc; how the Original content is to be played.

Step 6: Stop the record

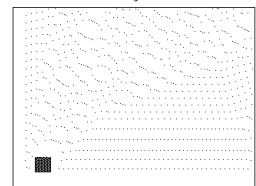
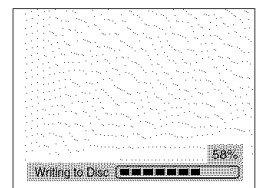
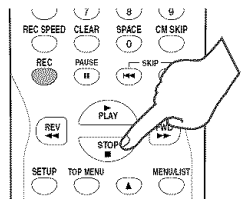

This operation may take a while to be completed.

Getting started

Channel setting

All channels are stored in the DVD recorder when purchased. We recommend that you get available channels in your area stored using "Auto Preset" in the Channel Preset of the SETUP menu.

Getting channels automatically

1

Press **POWER** button to turn on the DVD recorder.

2

Turn the TV on and be sure to select the input to which the DVD recorder is connected.

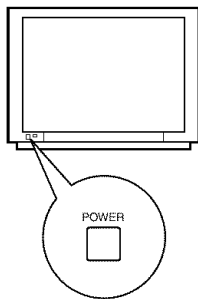

3

Press **SETUP** button to display **SETUP/DISC** menu. SETUP/DISC menu will appear.

Screen:

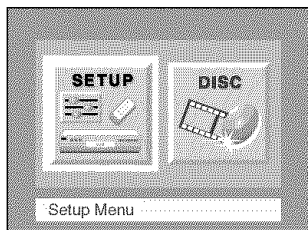

4

Select "**SETUP**" using **◀/▶** buttons, then press **ENTER** button.

SETUP menu will appear.

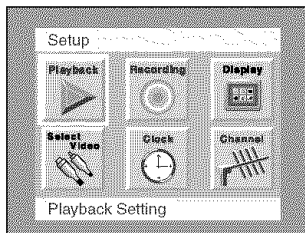

5

Select "**Channel**" using **▲ / ▼ / ◀ / ▶** buttons, then press **ENTER** button.

Channel Preset menu will appear.

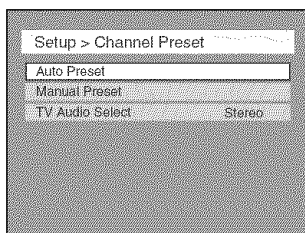

6

Select "**Auto Preset**" using **▲ / ▼** buttons, then press **ENTER** button.

The DVD recorder will start getting channels available in your area.

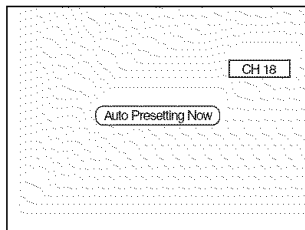

7

Press **SETUP** button to exit.

• You can select only the channels memorized in this unit by using the **CHANNEL** buttons.

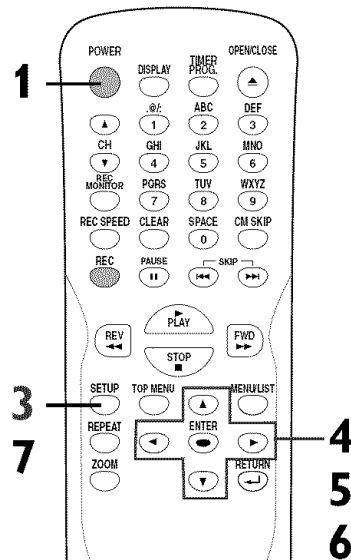

To select a channel

You can select a channel by directly entering channel using the Number buttons on the remote control.

Notes for using the Number buttons:

- When selecting cable channels which are higher than 99, enter channel numbers as a three-digit number. (For example: 117, press 1,1,7)
- You must precede single-digit channel numbers with a zero (For example: 02, 03, 04 and so on).
- You can select the line input mode ("L1" or "L2"). To select "L1" by pressing [0], [0], [1]. To select "L2" by pressing [0], [0], [2]. Details are on page 38.

Note

- If the auto presetting is cancelled during presetting, some channels not yet preset may not be received.
- The selection will depend on how you receive the TV channels.

To cancel the auto presetting during scanning:

Press **RETURN** button or **SETUP** button to cancel.

Adding/deleting channels

The channels you no longer receive or seldom watch can be deleted from the memory. You also may add channels into memory.

1

Press **SETUP** button to display **SETUP/DISC** menu. **SETUP/DISC** menu will appear.

Screen:

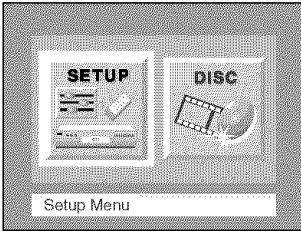

2

Select "**SETUP**" using **◀ / ▶** buttons, then press **ENTER** button. **SETUP** menu will appear.

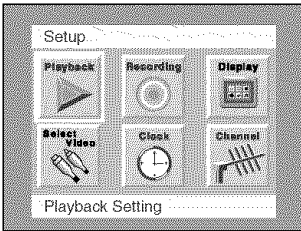

3

Select "**Channel**" using **▲ / ▼** / **◀ / ▶** buttons, then press **ENTER** button. Channel Preset menu will appear.

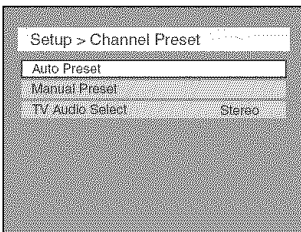

4

Select "**Manual Preset**" using **▲ / ▼** buttons, then press **ENTER** button. Manual Preset menu will appear.

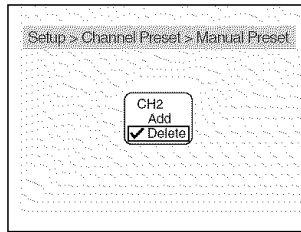

5

Select the channel number to add or delete. Press **◀** button to move to a lower channel number. Press **▶** button to move to a higher channel number.

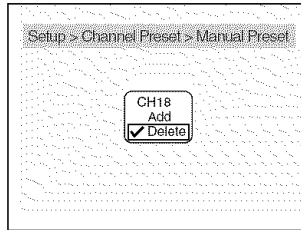

6

Select "**Add**" or "**Delete**" using **▲ / ▼** buttons, then press **ENTER** button. The channel number will be added or deleted from a channel memory. Then a next channel number will appear so that you can continue adding or deleting channels.

7

Press **SETUP** button to exit.

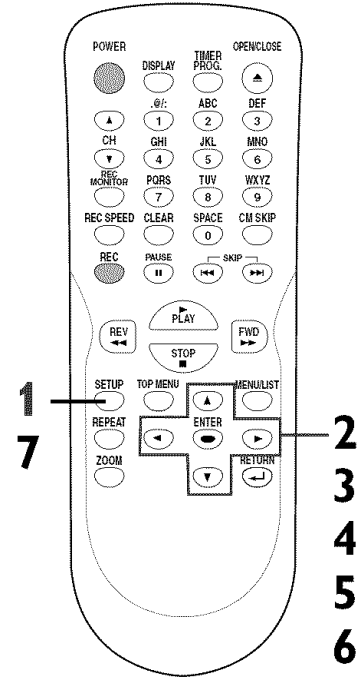

Getting started

Selecting the TV stereo or SAP

You can select a sound channel to output from TV. "Stereo" has been selected as the default.

1

Press **SETUP** button to display **SETUP/DISC** menu. **SETUP/DISC** menu will appear.

Screen:

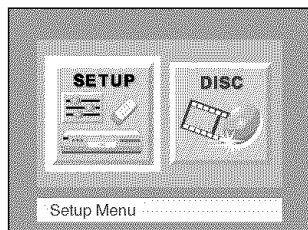

2

Select "**SETUP**" using **◀/▶** buttons, then press **ENTER** button.

SETUP menu will appear.

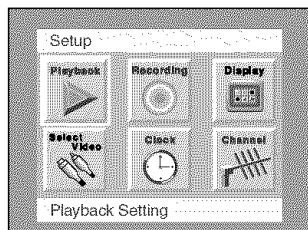

3

Select "**Channel Preset**" using **▲/▼/◀/▶** buttons, then press **ENTER** button. **Channel Preset** menu will appear.

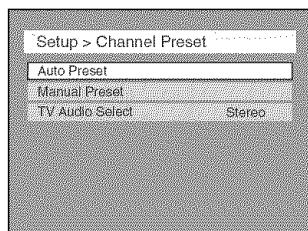

4

Select "**TV Audio Select**" using **▲/▼** buttons, then press **ENTER** button.

Option window will appear.

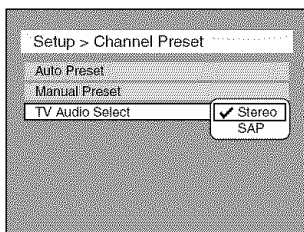

5

Select "**Stereo**" or "**SAP**" using **▲/▼** buttons, then press **ENTER** button.

Stereo:

Outputs main-audio.

SAP:

(**Secondary Audio Program**)

Outputs Sub-audio.

Refer to the item in "Glossary" on page 96 for more information.

6

Press **SETUP** button to exit.

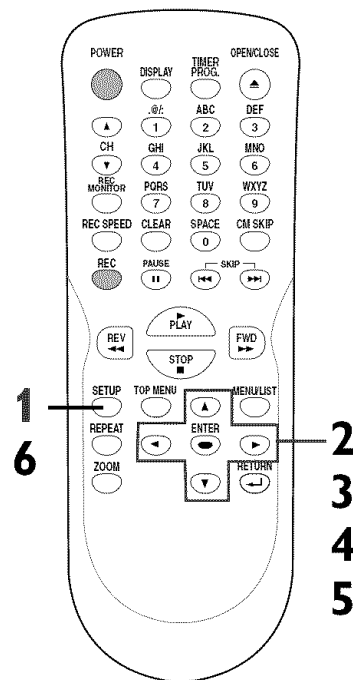

Getting started

Clock setting

Set the clock before you try the timer recording. If a Public Broadcasting Station (PBS) is available in your area, follow Auto Clock Setting below. If not, follow Manual Clock Setting on pages 22-23.

Auto Clock Setting

Make sure

- The antenna/Cable TV connections are correct.
- If this unit is connected to a Cable Box or Satellite Box, select the local PBS station on them to set the clock automatically.

1

Press **SETUP** button to display **SETUP/DISC** menu.

SETUP/DISC menu will appear.

Screen:

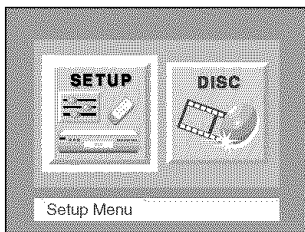

2

Select "**SETUP**" using **◀/▶** buttons, then press **ENTER** button.

SETUP menu will appear.

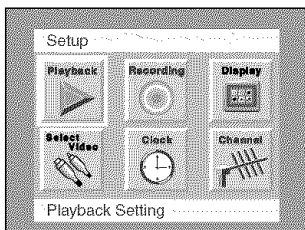

3

Select "**Clock**" using **▲/▼/◀/▶** buttons, then press **ENTER** button.

Clock menu will appear.

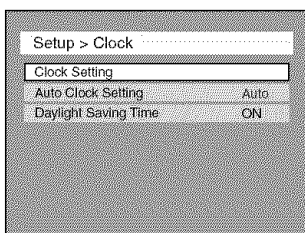

4

Select "**Auto Clock Setting**" using **▲/▼** buttons, then press **ENTER** button.

Option window will appear.

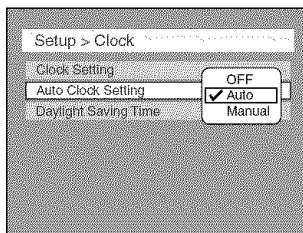

5

If you do not know your **PBS** channel number, select "**Auto**" using **▲/▼** buttons, then press **ENTER** button.

If you know your **PBS** channel number, select "**Manual**" using **▲/▼** buttons, then press **ENTER** button.

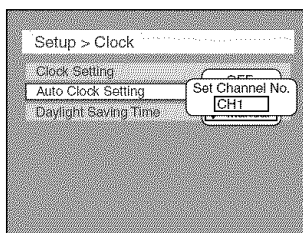

Enter your **PBS** channel number using **Number** or **▲/▼** buttons, then press **ENTER** button.

6

Press **SETUP** button to exit.

7

Press **POWER** button to turn off the **DVD** recorder. This unit will search for the time only when the power is off. Leave it off for several minutes to give this unit time to set the clock on the front display of the front panel.

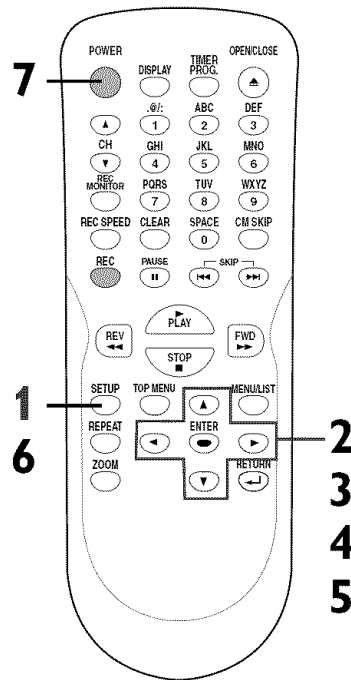

Note

- The clock may set itself automatically after you connect the antenna/cable signal to this unit and plug in the power cord. In this case, the current time will appear on the front display on the front panel.
- The current time is not displayed or the displayed clock is not correct, set the clock manually.

Before you start

Connectors

Getting started

Recording

Playing discs

Editing

Changing the SETUP menu

Others

Spanish

Getting started

Clock setting (cont'd)

Manual Clock Setting

1

Press **SETUP** button to display **SETUP/DISC** menu. **SETUP/DISC** menu will appear.

Screen:

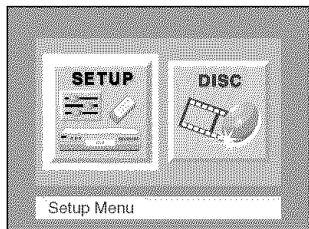

2

Select "**SETUP**" using **◀ / ▶** buttons, then press **ENTER** button.

SETUP menu will appear.

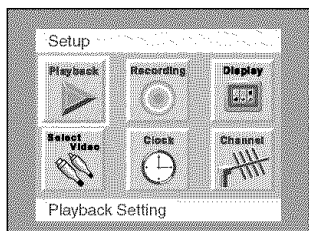

3

Select "**Clock**" using **▲ / ▼ / ◀ / ▶** buttons, then press **ENTER** button.

Clock menu will appear.

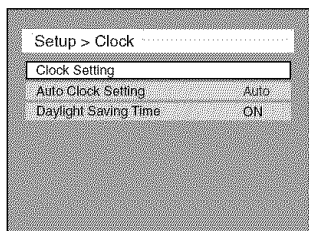

4

Select "**Clock Setting**" using **▲ / ▼** buttons, then press **ENTER** button.

A clock setting window will appear.

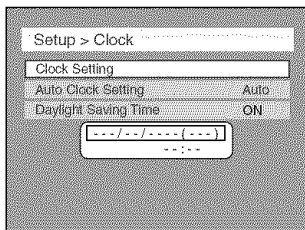

Press **ENTER** button again.

Default date will appear.

5

Enter the date (month / day / year) using **▲ / ▼** buttons.

Press **◀ / ▶** button to move the cursor.

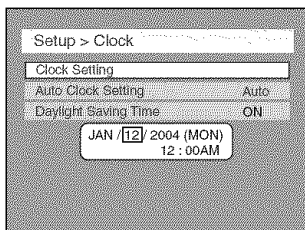

6

Enter the time (hour / minute) using **▲ / ▼** buttons, then press **◀ / ▶** buttons.

A cursor will move on **AM** or **PM**.

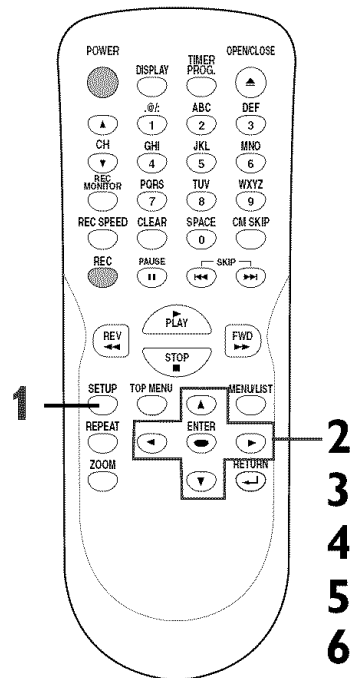
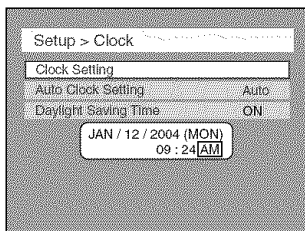

Note

- Your clock setting will be lost if either there is a power failure or this unit has been unplugged for more than 30 seconds when you set the clock manually.

Getting started

Clock setting (cont'd)

7

Press **▲ / ▼** buttons to select **AM** or **PM**, then press **ENTER** button.

Clock menu will appear, then the settings will be activated.

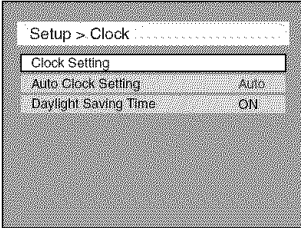

8

Press **SETUP** button to exit. Although seconds are not displayed, they begin counting from zero.

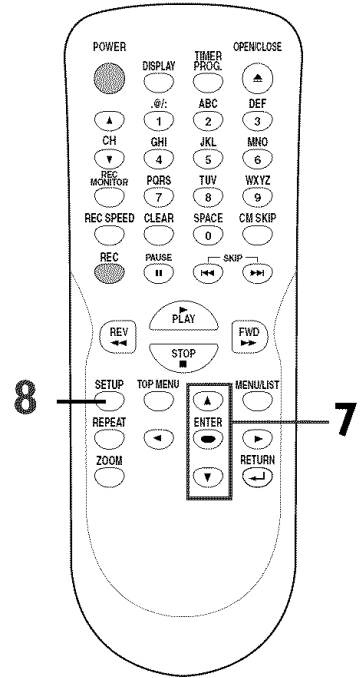

When “Auto Clock Setting” is selected to “Auto” or “Manual”, change it to “OFF” as following steps.

Repeat steps (1) to (3) in “Manual Clock Setting”.

4

Select “Auto Clock Setting” using **▲ / ▼** buttons, then press **ENTER** button.

Option window will appear.

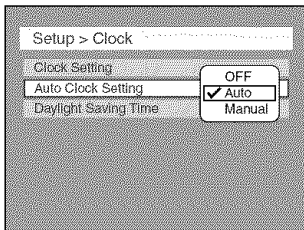

5

Select “OFF” using **▲ / ▼** buttons, then press **ENTER** button.

6

Press **SETUP** button to exit.

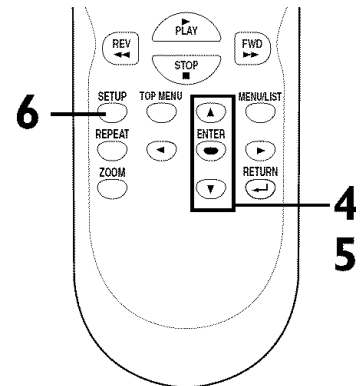

Getting started

Clock setting (cont'd)

Setting the daylight saving time

When Daylight Saving Time is ON, the DVD recorder clock will automatically move forward one hour on the first Sunday in April and move back one hour on the last Sunday in October.

1

Press **SETUP** button to display **SETUP/DISC** menu. **SETUP/DISC** menu will appear.

Screen:

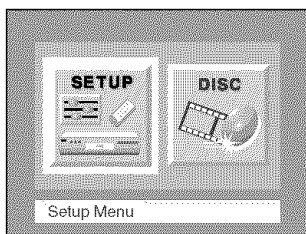

2

Select "**SETUP**" using **◀/▶** buttons, then press **ENTER** button.

SETUP menu will appear.

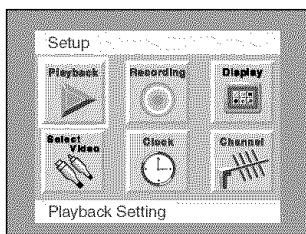

3

Select "**Clock**" using **▲/▼/◀/▶** buttons, then press **ENTER** button.

Clock menu will appear.

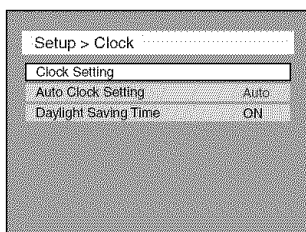

4

Select "**Daylight Saving Time**" using **▲/▼** buttons, then press **ENTER** button.

Daylight Saving Time options will appear.

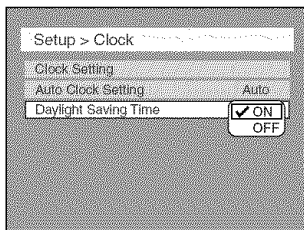

5

Select "**ON**" or "**OFF**" using **▲/▼** buttons, then press **ENTER** button.

Choose "**ON**" when currently observing the daylight saving time.

6

Press **SETUP** button to exit.

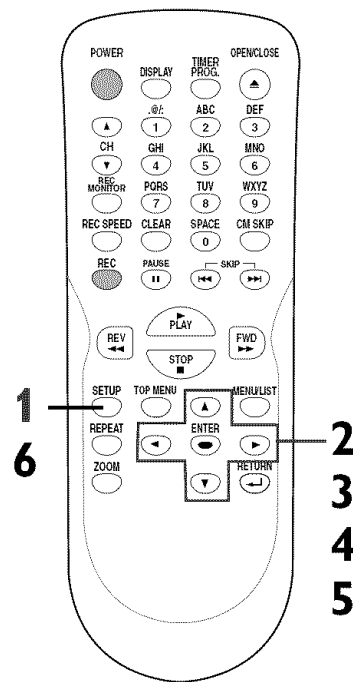

Getting started

Selecting the TV aspect ratio

You can select the TV aspect ratio to match the formats of what you are playing with the DVD recorder and your TV screen (4:3 standard or 16:9 widescreen TV). "4:3 Letter Box" has been selected as the default.

1
Press **SETUP** button to display **SETUP/DISC** menu.

SETUP/DISC menu will appear.

Screen:

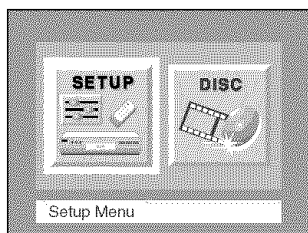

2
Select "**SETUP**" using **◀ / ▶** buttons, then press **ENTER** button.

SETUP menu will appear.

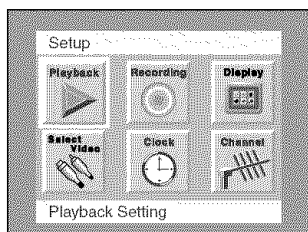

3
Select "**Playback**" using **▲ / ▼** / **◀ / ▶** buttons, then press **ENTER** button.

Playback menu will appear.

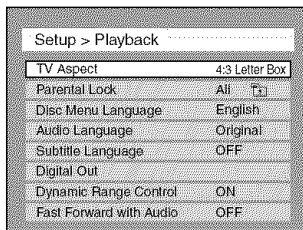

4
Select "**TV Aspect**" using **▲ / ▼** buttons, then press **ENTER** button.

Option window will appear.

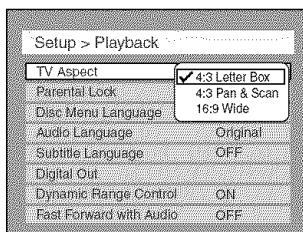

Refer to the **Note** on this page.

5
Select a desired option using **▲ / ▼** buttons, then press **ENTER** button.

6
Press **SETUP** button to exit.

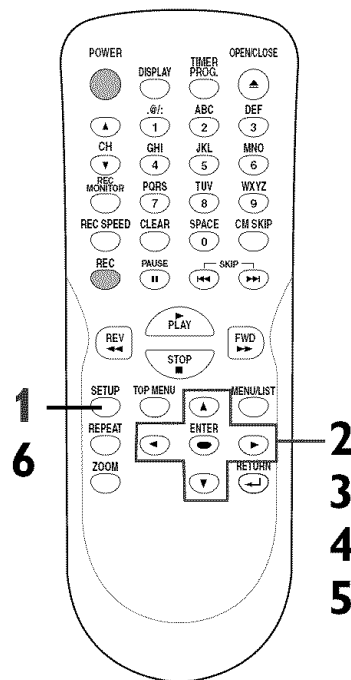

Note

If you have a standard TV:
Select "4:3 Letter Box", so that black bars appear on the top and bottom of the screen.
Select "4:3 Pan & Scan" for a full height picture with both sides trimmed.



If you have a widescreen TV:
Select "16:9 Wide".

Recording

Information on DVD recording

Information

This DVD recorder can record to DVD-R and DVD-RW discs. When recording, you will need to select a recording format between Video mode and VR mode depending on the disc format. The disc format for DVD-R is always "Video format," so a recording format will be "Video mode". On the other hand, when recording to DVD-RW, a recording format will be "Video mode" or "VR mode" because a disc format is available between "Video Recording format" and "Video format" for DVD-RW.







Logo	Attributes
	12cm, single-sided, single layer disc Approx. max. recording time (SEP mode): 600 minutes (4.7GB)
	12cm, single-sided, single layer disc Approx. max. recording time (SEP mode): 600 minutes (4.7GB)

About Video mode and VR (Video Recording) mode

Video mode is the same recording format as DVD-Video discs purchased locally, so that you can play in most DVD players. To play in other DVD players, you will need to finalize (see page 39). Unless finalized, you can play, record additionally or edit discs recorded in Video mode with this unit.

VR (Video Recording) mode is a basic recording format for DVD-RW. You can record and edit repeatedly.

DVD players with **RW COMPATIBLE** are capable of playing DVD-RW recorded in VR mode.

Disc type	Disc format	Functions
	 Video mode	Playing, limited recording, limited editing
	 VR mode	Playing, recording, Original/Playlist editing
	 Video mode	Playing, limited recording, limited editing

Recording speed

You can select a recording speed among 6 options, and the recording time will depend on the recording speed you select as follows.

Recording speed	Recording time *	Video/Sound Quality
XP (1H)	60 min	☆☆☆☆☆☆
SP (2H)	120 min	☆☆☆☆☆
LP (4H)	240 min	☆☆☆☆
EP (6H)	360 min	☆☆☆
SLP (8H)	480 min	☆☆
SEP (10H)	600 min	☆

* This table is designed for a new single-sided 12cm disc as the standard. The recording time are estimates and actual recording time may differ.

* The audio and video quality is getting poorer as the Recording time becomes longer.

Restrictions on recording

You cannot record copy-protected video using this DVD recorder. Copy-protected video includes DVD-Video discs and some satellite broadcasts. If copy-protected material is encountered during a recording, recording will pause or stop automatically and an error message will be displayed on-screen. Video that is "copy-once only" can only be recorded using a DVD-RW disc in VR mode with CPRM (see below).

When recording a TV broadcast or through an external input, you can display copy control information on screen.

What is "CPRM"?

CPRM is a copy protection system with scramble system regarding the recording of "copy once" broadcast programs. CPRM stands for Content Protection for Recordable Media. This DVD recorder is CPRM compatible, which means that you can record copy-once broadcast programs, but you cannot then make a copy of those recordings. CPRM recordings can only be made on DVD-RW discs formatted in VR mode, and CPRM recordings can only be played on players that are specifically compatible with CPRM.

Information on DVD recording (cont'd)

Information on copy control

Some satellite broadcasts include copy-protected information. For recording these, refer to the following.

Disc type/ format	Copy-free	Copy-once	Copy- prohibited
VR mode DVD-RW ver:1.0 ver:1.1 ver:1.1 CPRM compatible	☆☆	☆	—
Video mode DVD-RW ver:1.1 ver:1.1 CPRM compatible	☆☆	—	—
Video mode DVD-R ver:2.0	☆☆	—	—

- ☆☆ Recordable
- ☆ Recordable only for DVD-RW ver:1.1 compatible with CPRM
- Not Recordable

Making discs playable in other DVD player (Finalize)

You will need to finalize discs when in the following:

- when playing DVD-R/RW (Video mode) recorded with this DVD recorder in other DVD players.
- when DVD-RW (VR mode) recorded with this DVD recorder fails to be played in other DVD players.

- Once DVD-R/RW (Video mode) is finalized, you cannot record additionally or edit.
- You can record additionally to or edit DVD-RW (VR mode), which is finalized with this DVD recorder.
- Be sure to finalize discs recorded with this DVD recorder by using this DVD recorder.
- Title menu will be created automatically in DVD-R/RW (Video mode) finalized with this DVD recorder.

To play in other DVD players, finalize discs recorded from this DVD recorder with the following condition.

Disc type	Mode
DVD-R ver:2.0	Video mode
DVD-RW ver:1.1 ver:1.1 CPRM compatible	Video mode

Note

- The audio and video quality is getting poorer as the Recording time becomes longer.
- This recorder cannot record CD-R or CD-RW discs.
- DVD-R/RW and CD-R/RW discs recorded using a personal computer or a DVD or CD recorder may not play if the disc is damaged or dirty, or if there is dirt or condensation on the player's lens.
- If you record a disc using a personal computer, even if it is recorded in a compatible format, there are cases in which it may not play because of the settings of the application software used to create the disc. (Check with the software publisher for more detailed information.)

Recording

Formatting a disc

Settings for the recording format to a blank disc

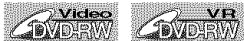

When inserting a blank disc, the DVD recorder starts to initialize the blank disc.

After that, you can record to the disc with the recording format selected in SETUP menu.

You are allowed to set a specified time for chapter marks.

1

Press **SETUP** button to display **SETUP/DISC** menu. **SETUP/DISC** menu will appear.

Screen:

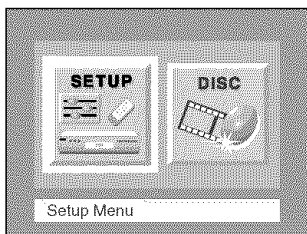

2

Select **"SETUP"** using **◀/▶** buttons, then press **ENTER** button.

SETUP menu will appear.

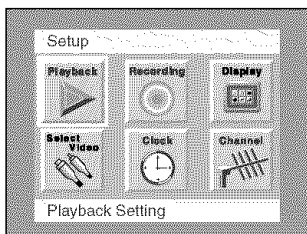

3

Select **"Recording"** using **▲/▼/◀/▶** buttons, then press **ENTER** button.

Recording menu will appear.

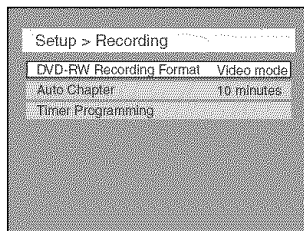

4

Select **"DVD-RW Recording Format"** using **▲/▼** buttons, then press **ENTER** button.

Option window will appear.

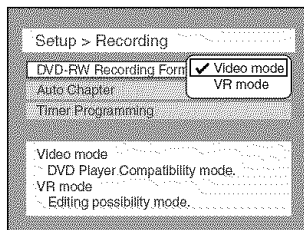

Video mode has been selected as the default.

5

Select **"Video mode"** or **"VR mode"** using **▲/▼** buttons, then press **ENTER** button.

The recording mode will be set.

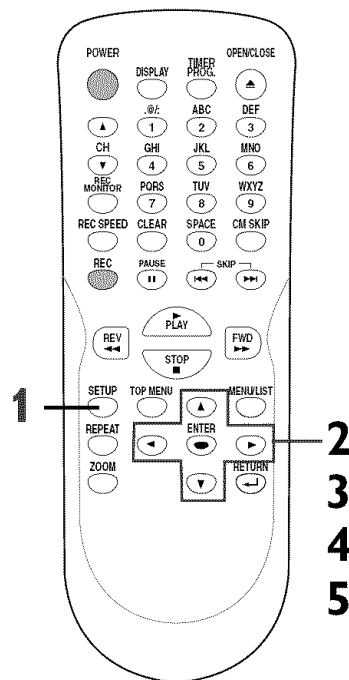

Note

- When inserting a blank DVD+R or DVD+RW disc, the error message ("Disc Error") will appear. This DVD recorder is not compatible with a DVD+R/RW disc.
- If using a DVD-RW (ver 1.0) disc, recording will start in VR mode even you choose video mode in SETUP menu.

6

Select "Auto Chapter" using ▲ / ▼ buttons, then press **ENTER** button.

Option window will appear.

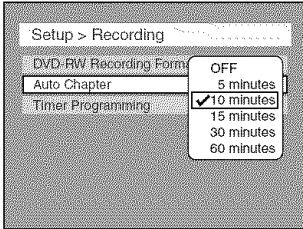

"10 minutes" has been selected as the default.

7

Select a desired time option using ▲ / ▼ buttons, then press **ENTER** button.

Chapter marks will be put as you specified.

8

Press **SETUP** button to exit **SETUP** menu.

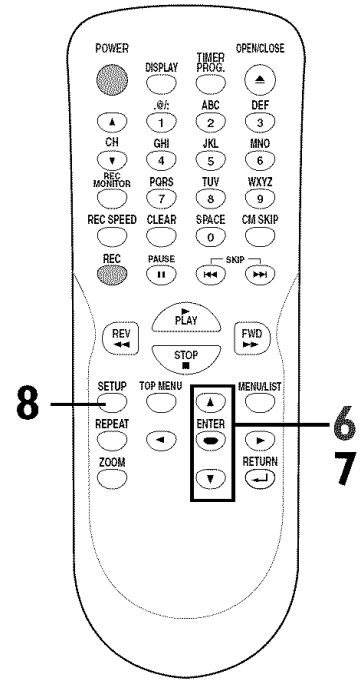

Note

- The time for chapter marks is not accurate in Video mode.

Recording

Formatting a disc (cont'd)

Reformatting a disc

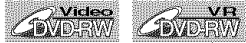

If you are using a DVD-RW disc, by default it will be Video mode. You can change this to VR mode from SETUP menu.

1

Press **SETUP** button to display **SETUP/DISC** menu. **SETUP/DISC** menu will appear.

Screen:

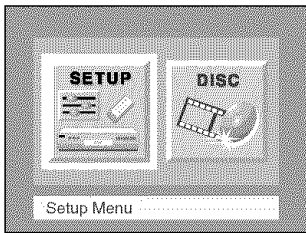

2

Select **"DISC"** using **◀ / ▶** buttons, then press **ENTER** button.

DISC menu will appear.

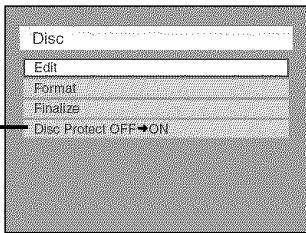

*VR mode only

3

Select **"Format"** using **▲ / ▼** buttons, then press **ENTER** button.

Option window will appear.

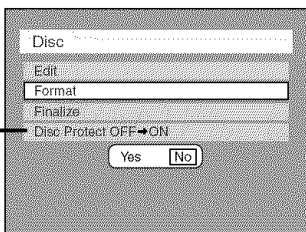

*VR mode only

4

Select **"Yes"** using **◀ / ▶** buttons, then press **ENTER** button.

Option window will appear.

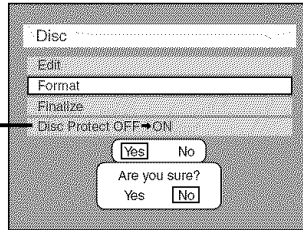

*VR mode only

5

Select **"Yes"** using **◀ / ▶** buttons, then press **ENTER** button.

Formatting will start.

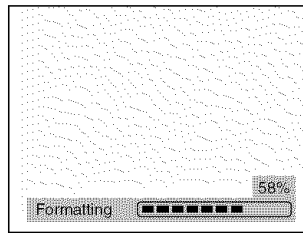

6

Formatting is complete.

100% will be indicated.

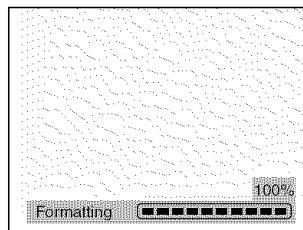

This operation may take a while to be completed.

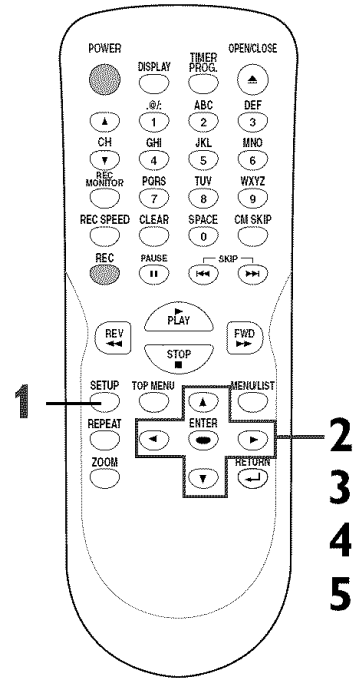

Note

- When you reformat the disc, the contents of the disc will be erased.
- If you want to cancel format at step 5, select "No".

Basic recording



Follow the steps below to record TV programs.

1

Turn on the DVD recorder and load a recordable disc.

Make sure that the TV input is set on the DVD recorder.

This operation may take a while to be recognized.

2

Select a recording speed using REC SPEED button.

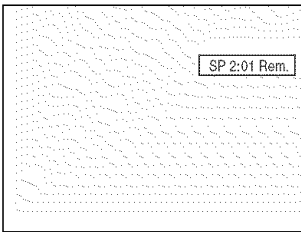

Refer to "Recording speed" on page 26.

3

Make sure that the recording format is set to the desired mode.

Refer to "Formatting a disc" on pages 28-30.

When a DVD-RW disc is loaded:

You can choose Video mode or VR mode from SETUP menu. "Video mode" has been selected as the default. Refer to "Settings for the recording format to a blank disc" on pages 28-29.

When a DVD-R disc is loaded:

DVD-R discs will always be in Video mode.

4

Select a desired channel to record using CH ▲ / ▼ buttons or number buttons.

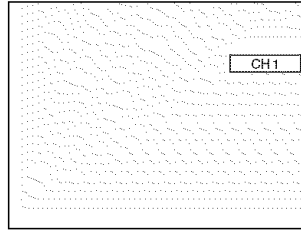

5

Press REC button to start recording.

REC mark will be displayed for 5 seconds.

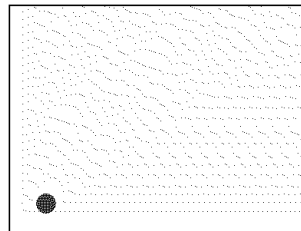

To pause the recording, press PAUSE ||| button. Press REC button to restart the recording.

6

Press STOP ■ button to stop the recording.

This operation may take a while to be completed.

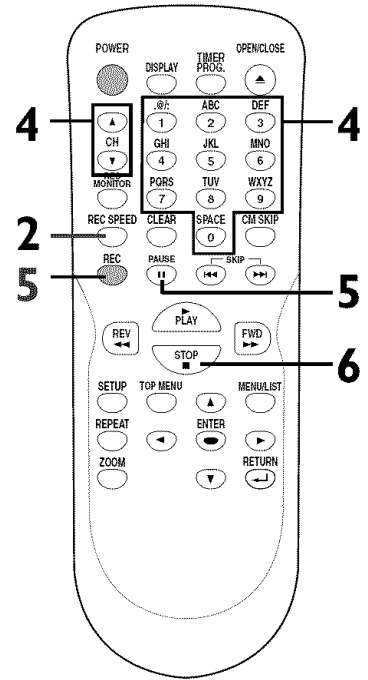

Note

- Recording starts immediately and continues until the disc is full or you stop recording.
- When the clock setting has not been made, the space for a date and time of title names in the original or playlist will be blank.
- You cannot mix two formats on one DVD-RW disc. When you load a disc once recorded before, the recording format cannot be changed even if you change it in SETUP menu.
- You cannot change the recording speed during the REC pause mode.
- You can change a channel during the REC pause mode.

Basic recording (cont'd)

Checking the recording picture quality



You can confirm the recording picture quality with the recording picture speed you have selected before attempting to record to a DVD disc.

1

While the DVD recorder is in **STOP** or **REC** with a DVD disc to record inserted, press **REC MONITOR** button.

The TV program will be on the screen in the recording picture quality with the recording speed you have selected.

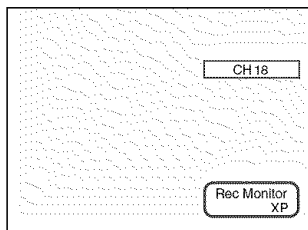

If you want to change the recording speed, press **REC SPEED** button repeatedly.

The recording speed will be changed as you press the button as shown. Refer to "Recording speed" on page 26.

- You cannot change the recording speed during recording.

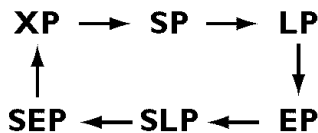

2

Press **REC MONITOR** button again to exit.

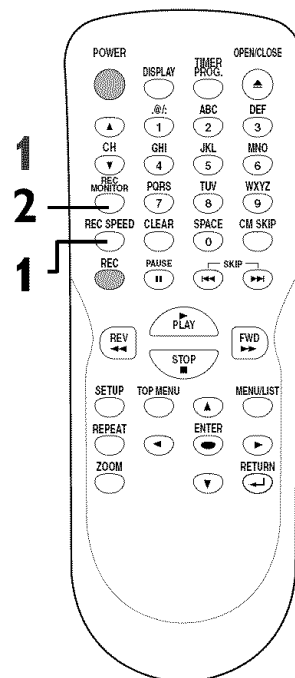

Note

- You cannot check the recording sound with the Rec monitor function.

One-touch timer recording



This is a simple way to set the recording time in blocks of 30 minutes. Check that the disc you are recording onto has enough space for the time you set. When the recording finishes the recorder automatically goes into standby.

1
Turn on the DVD recorder and load a recordable disc. Make sure that the TV input is set on the DVD recorder.

This operation may take a while to be recognized.

2
Select a recording speed using **REC SPEED** button. Refer to "Recording speed" on page 26.

3
Make sure that the recording format is set to the desired mode. Refer to "Formatting a disc" on pages 28-30.

When a DVD-RW disc is loaded:
You can choose Video mode or VR mode from **SETUP** menu. "Video mode" has been selected as the default. Refer to pages 28-29 "Settings for the recording format to a blank disc."

When a DVD-R disc is loaded:
DVD-R discs will always be in Video mode.

4
Select a desired channel to record using **CH ▲ / ▼** buttons or number buttons.

5
Press **REC** button on the remote control or the front panel, then press **REC** button repeatedly until a desired recording time (30 minutes to 4 hours) appears on the TV screen. Recording will start.

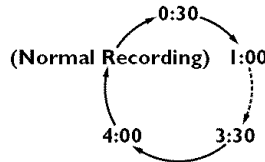
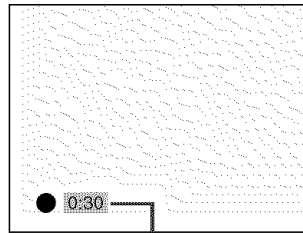

When the DVD recorder reaches the specified time, it will be turned off automatically.

To cancel the one-touch timer recording within the specified time, press **STOP** button.

This operation may take a while to be completed.

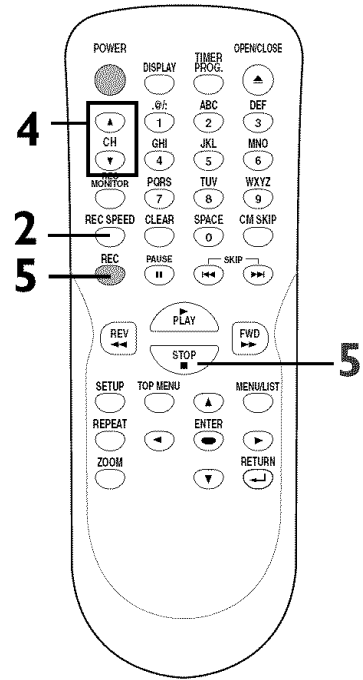

Note
The DVD recorder will be turned off automatically under the conditions following.

- No space remained on the disc.
- When a power failure occurs.

Recording

Timer recording



You can program the unit to record up to 8 programs, up to a year in advance. Daily or weekly program recordings are also available.

- Be sure to set the clock before making a timer programming.
- Insert a recordable disc.

1

Press **SETUP** button to display **SETUP/DISC** menu. **SETUP/DISC** menu will appear.

Screen:

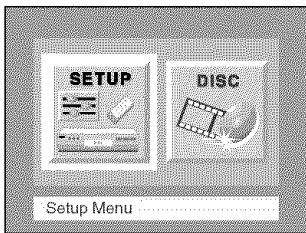

2

Select **"SETUP"** using **◀/▶** buttons, then press **ENTER** button.

SETUP menu will appear.

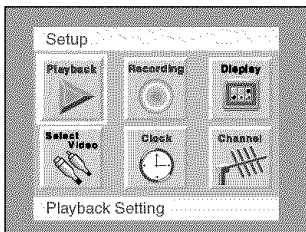

3

Select **"Recording"** using **▲ / ▼ / ◀ / ▶** buttons, then press **ENTER** button.

Recording menu will appear.

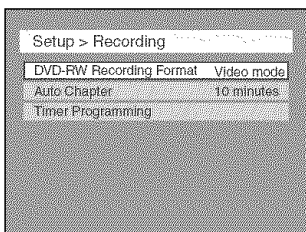

4

Select **"Timer Programming"** using **▲ / ▼** buttons, then press **ENTER** button.

Timer Programming list will appear.

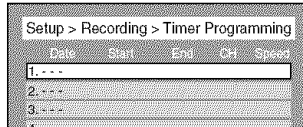

5

Select the program which is not set up using **▲ / ▼** buttons, then press **ENTER** button.

6

Enter the date using **▲ / ▼** buttons, then press **▶** button.

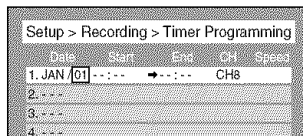

e.g. January 1st

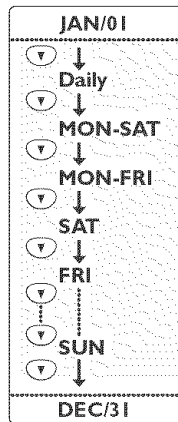

When pressing **▼** button at the current date, timer recording mode will change as follows.

7

Enter the time to start and to end using **▲ / ▼** buttons, then press **▶** button.

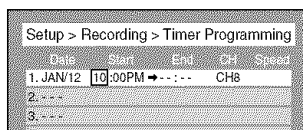

You can choose the timer programming menu by pressing **TIMER PROG.** button. In this case, continue with step 5.

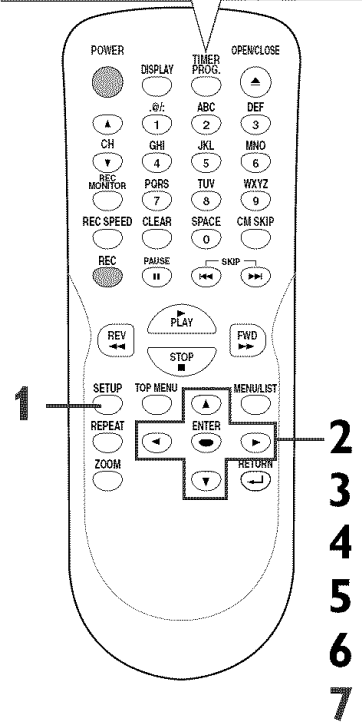

Note

• If you have not set the clock yet:

A clock setting window will appear after step 4. Continue with the step 4 in "Auto Clock Setting" on page 21 or "Manual Clock Setting" on page 22 before making a timer programming.

• Press **◀** or **▶** buttons to move the cursor to the left and the right in the timer programming menu.

Recording

Timer recording (cont'd)

8

Select the channel number to record using ▲ / ▼ buttons, then press ► button.

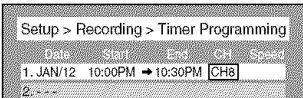

To record from external input, L1 or L2.

9

Select a recording speed using ▲ / ▼ buttons.

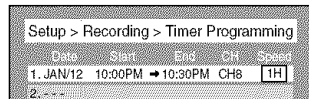

Refer to "Recording speed" on page 26.

Checking, canceling, or correcting the timer programming information

1

Press **POWER** button so that indicator disappears from the front display.

2

Press **TIMER PROG.** button. Timer Programming list will appear.

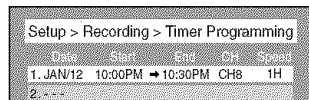

3

Check the information on the list you will need.

10

Press **ENTER** button when all information required is entered. Your program setting will be stored.

- To set another program, repeat steps 5 to 10.
- To exit, press **SETUP** button.

11

Press **POWER** button to turn off. indicator will appear on the front display.



11

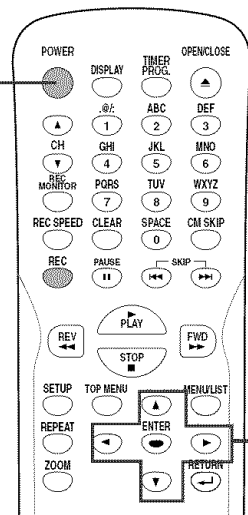

Note

- After step 11, the DVD recorder will be turned on automatically 2 minutes in advance of the recording time to start and waits to start. Then the recording will start at the recording time you set.

4

To clear the timer programming, select your desired program using ▲ / ▼ buttons. Then, **CLEAR** button.

To correct the timer programming, select your desired program using ▲ / ▼ buttons. Then, press **ENTER** button. Next, correct the timer programming by using press ▲/▼/◀▶ buttons. Finally, press **ENTER** button again.

5

Press **TIMER PROG.** button to exit.

6

Press **POWER** button to return to the timer standby mode.

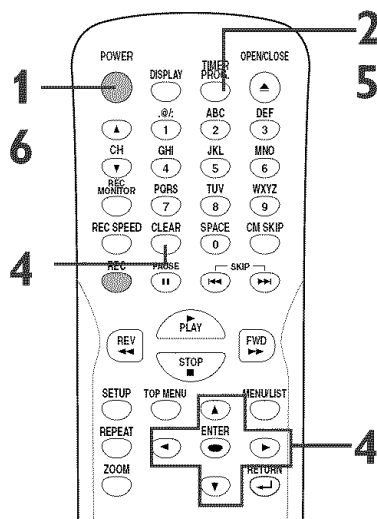

Note

- Press **TIMER PROG.** button to check the timer programming in process. When the timer recording is proceeding, that program will be highlighted with red. In this case, you cannot select any other program.







To stop the timer recording in process

Press **STOP** button on the front panel of the main unit. **STOP** button on the remote control is not effective.

Recording

Timer recording (cont'd)

Hints for timer recording

- If there is a power failure or this unit has been unplugged for more than 30 seconds, the clock setting and all timer settings will be lost.
- If a disc is not on the tray, the  indicator flashes and timer recording cannot be performed. Please insert a recordable disc.
- When all the timer recording is completed, the  indicator flashes. To play or eject the recorded disc, press POWER button first, and then press PLAY  or OPEN/CLOSE  button.
- During timer recording or timer standby ( indicator is on the front display), any operations on the unit will not be available. To make these operations available, cancel the timer recording or timer standby first ( indicator disappears).
- To cancel the timer standby mode, press POWER button.

The priority of overlapped settings

This unit records the programs according to priority if the timer programmings are overlapped. The timer programming set previously has priority. A timer recording of lower priority will be canceled, start from the middle, or stop on the way. Check the overlapped timer programmings and change the priority if necessary.

■ A programming set previously has priority

When the starting time is the same:

A program set previously (PROG. 1) has priority.

When some programming have been made at the end time of the programming currently being recorded:

A program set previously (PROG. 2) has priority.

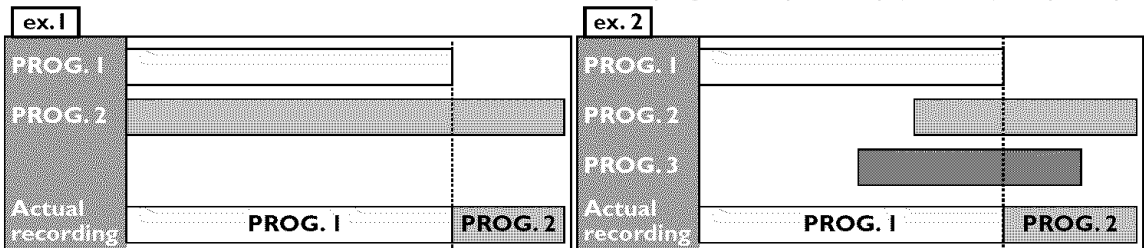

■ When the recording time is partially overlapped:

PROG. 1 will start after PROG. 2 is complete to be recorded.

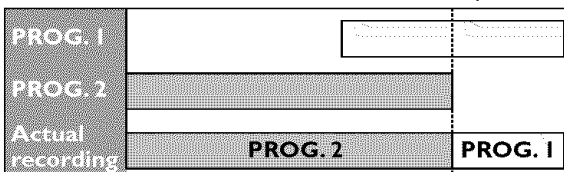

■ When the recording time is entirely overlapped:

PROG. 1 will not be recorded.

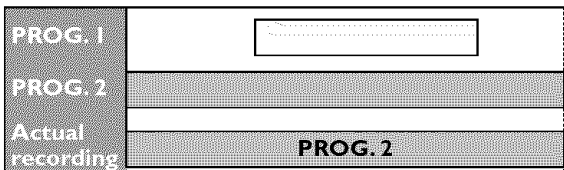

■ When the end time of the programming currently being recorded and the starting time of the one to be recorded sequentially are same:

The first 20-90 seconds of the programming to be recorded sequentially will be cut off.

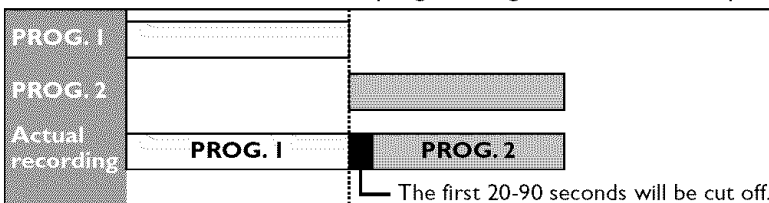

Settings for an external source

Connection to an external source



Connect the external source properly to the DVD recorder by using input jacks either LINE2 (Front) or LINE1 (Rear).

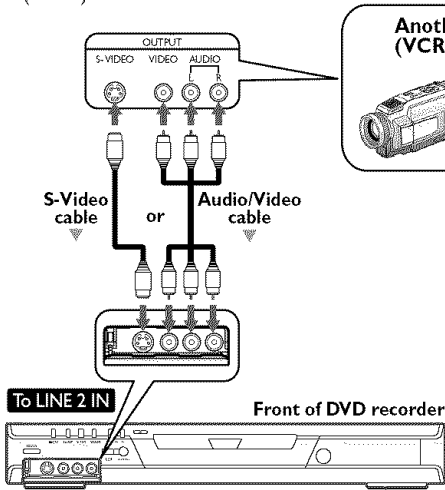

1. Press **SETUP** button to display **SETUP/DISC** menu.
2. Select **"SETUP"** using **◀/▶** buttons, then press **ENTER** button.
3. Select **"Select Video"**, then press **ENTER** button.

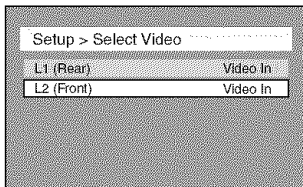

4. Select **"L2 (Front)"**, then press **ENTER** button.

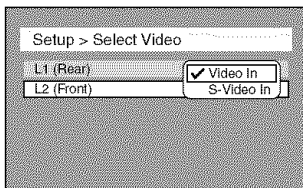

5. Select the input jack type to connect, then press **ENTER** button.
If you want to use **S-VIDEO INPUT**, select **"S-Video In"**.
If you want to use **VIDEO INPUT (Composite)**, select **"Video In"**.

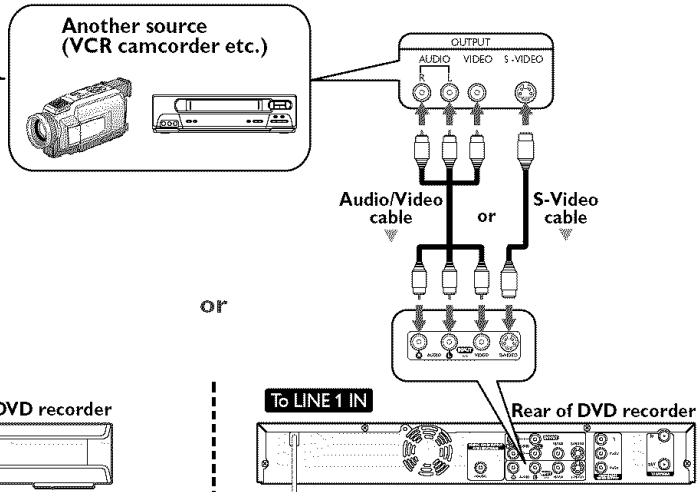
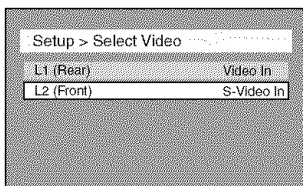

1. Press **SETUP** button to display **SETUP/DISC** menu.
2. Select **"SETUP"** using **◀/▶** buttons, then press **ENTER** button.
3. Select **"Select Video"**, then press **ENTER** button.

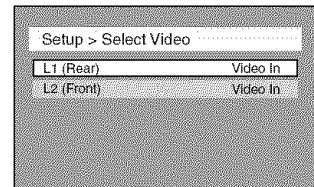

4. Select **"L1 (Rear)"**, then press **ENTER** button.

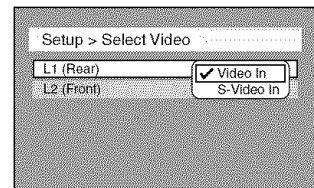

5. Select the input jack type to connect, then press **ENTER** button.
If you want to use **S-VIDEO INPUT**, select **"S-Video In"**.
If you want to use **VIDEO INPUT (Composite)**, select **"Video In"**.

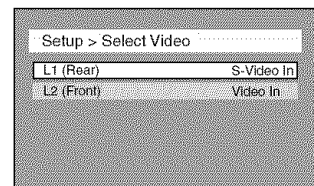

Recording

Settings for an external source (cont'd)

Recording from an external source



Before recording from an external source, see the instructions for the connection on page 37.

1. Turn the TV and the DVD recorder on, and be sure to select the input of the TV to which the DVD recorder is connected.
2. Press **OPEN/CLOSE** button to open the disc tray, then place the disc to record properly.

This operation may take a while to be recognized.

3. Select the input of the DVD recorder which the external equipment is connected. (**L2** or **L1**)
 - To use the input jacks on the back of this unit, select "L1" position by pressing [0], [0], [1] on the remote control or the CH / buttons.
 - To use the input jacks on the front of this unit, select "L2" position by pressing [0], [0], [2] on the remote control or the CH / buttons.
4. Select a recording speed using **REC SPEED** button. Refer to "Recording speed" on page 26.

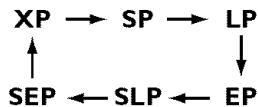

5. Press **REC** button on the DVD recorder to start recording.
6. Press **Play** button on the external source to record from.
7. Press **STOP** button on the DVD recorder to stop recording.

This operation may take a while to be completed.

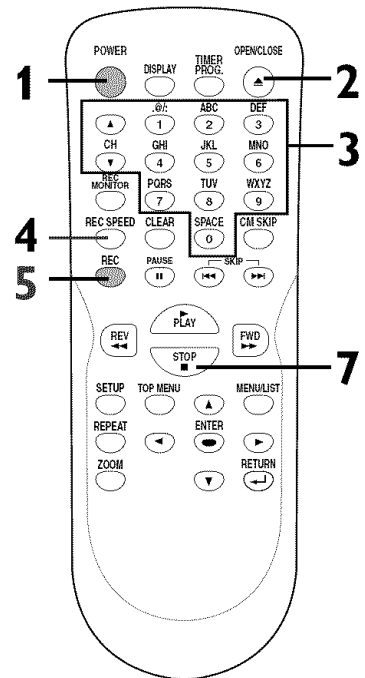

Finalizing the discs



You will need to finalize the discs recorded in Video mode to play in other DVD players.

Finalizing discs in Video mode automatically creates title menus.

1

Press **SETUP** button to display **SETUP/DISC** menu.

SETUP/DISC menu will appear.

Screen:

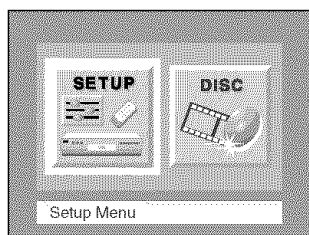

2

Select **"DISC"** using **◀/▶** buttons, then press **ENTER** button.

DISC menu will appear.

Video mode:

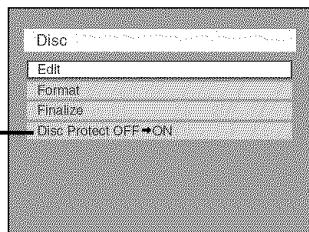

*VR mode only

3

Select **"Finalize"** using **▲/▼** buttons, then press **ENTER** button.

Option window will appear.

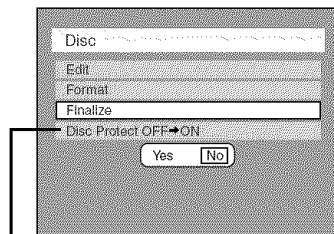

*VR mode only

4

Select **"Yes"** using **◀/▶** buttons, then press **ENTER** button.

Finalizing will start.

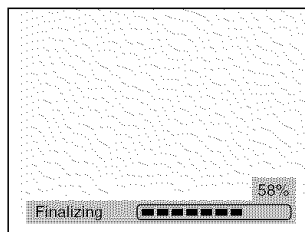

To cancel finalizing, press **STOP** button.

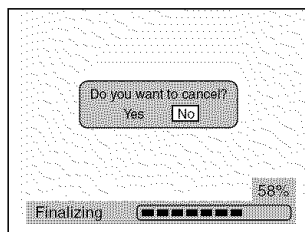

Select **"Yes"**, then press **ENTER** button.

Finalizing is cancelled, then the DVD recorder will be in stop mode.

5

Finalizing is complete.

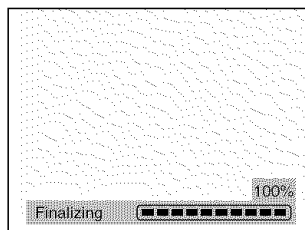

This operation may take a while to be completed.

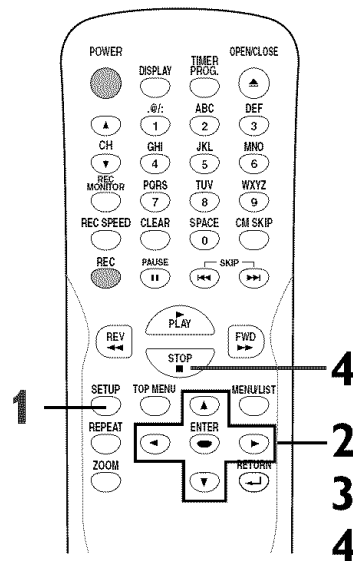

Note

- Once you have finalized a disc recorded in Video mode, you cannot edit or record anything else on that disc. A VR mode disc can still be recorded and edited on this recorder even after finalizing.
- When you insert a DVD-RW disc finalized with this DVD recorder, "Undo Finalize" will appear instead of "Finalize".

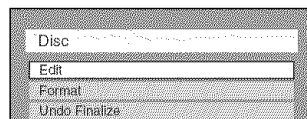

To release the finalizing for the disc, select "Undo Finalize" at step 3.

- If appear when pressing **STOP** button, you cannot cancel finalizing because the finalizing has been in certain progress.

When selecting "No" and press **ENTER** or **RETURN** button, finalizing will be continued.

You cannot cancel finalizing the DVD-R disc when it has been started.

Recording

Setting a disc to protect



To prevent accidental recording, editing, or erasing the titles, you can protect them from DISC menu.

1

Press **SETUP** button to display **SETUP/DISC** menu. **SETUP/DISC** menu will appear.

Screen:

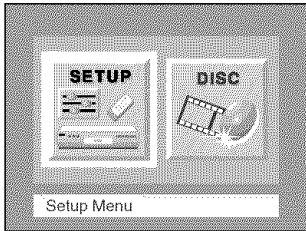

2

Select "**DISC**" using **◀/▶** buttons, then press **ENTER** button. **DISC** menu will appear.

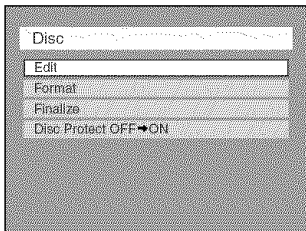

3

Select "**Disc Protect OFF → ON**" using **▲/▼** buttons, then press **ENTER** button. Option window will appear.

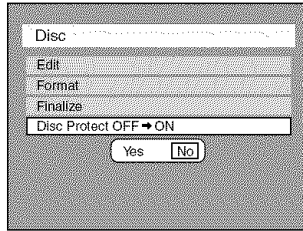

4

Select "**Yes**" using **◀/▶** buttons, then press **ENTER** button. A disc will be protected.

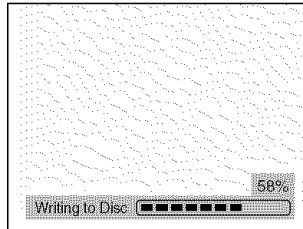

This operation may take a while to be completed.

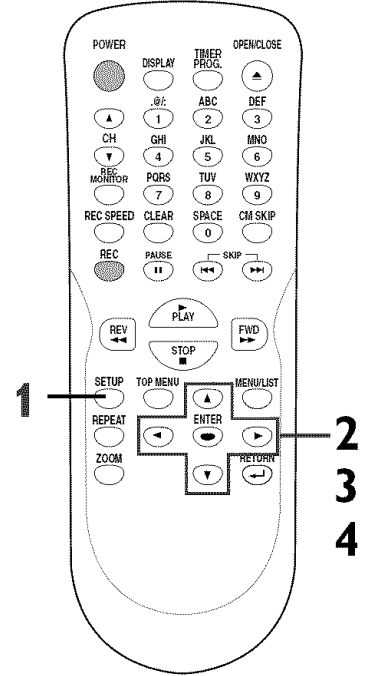

Information on DVD play

Before you attempt to play DVD discs, read the following information.

Playable discs

This DVD recorder is compatible to play the following discs.

To play a DVD, make sure that it meets the requirements for Region Codes and Color Systems as described below. Discs that have the following logos will play on the DVD recorder. Other Disc types are not guaranteed to play.

Disc	Logo
DVD VIDEO	
DVD-RW (VIDEO/VR FORMAT)	
DVD-R (VIDEO FORMAT)	
CD-DA (AUDIO CD)	
CD-R (CD-DA FORMAT, MP3 files)	
CD-RW (CD-DA FORMAT, MP3 files)	

Color systems

DVDs are recorded in different color systems throughout the world. The most common color systems are NTSC (which is used primarily in the United States and Canada), PAL, and SECAM.

This DVD Recorder uses NTSC, so DVDs you play must be recorded in the NTSC system. You cannot play DVDs recorded in other color system.

Guide to displays

Press DISPLAY button to call up the display menu. This menu will give you the information on the playing disc. Some operations are available while disc is playing.

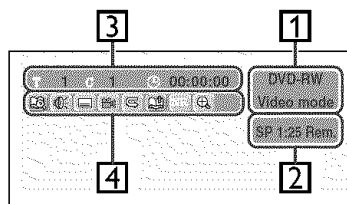

1. Indicates a disc type and a format mode.
2. Indicates a recording speed and possible recording time. / Indicates a channel number.
3. Indicates a title number, chapter number, and the time lapse of disc play.
4. Each icon means:

- : Search
- : Audio
- : Subtitle
- : Angle (except VR mode)
- : Repeat
- : Marker
- : Noise Reduction
- : Zoom

Region codes

This DVD recorder has been designed to play DVD discs with Region One (1). DVDs must be labeled for ALL regions or for Region 1 in order to play on the DVD recorder. You cannot play DVDs that are labeled for other regions. Look for the symbols below on your DVDs. If these region symbols do not appear on your DVD, you cannot play the DVD in this DVD recorder.



The number inside the globe refers to region of the world. Region 1 represents the United States, Canada, Bermuda, the U.S. Virgin Islands, and small regions near Australia.

A DVD labeled for a specific region can only play on the DVD recorder with the same region code.

Hint for DVD playback

The contents of DVD disc are generally divided into some titles. Titles may be further subdivided into chapters.

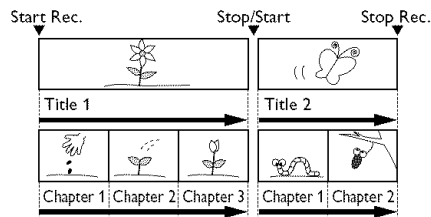

Playing discs

Basic playback

Playback



1
Press **POWER** button on the remote control or the front panel of the DVD recorder. When you are playing a DVD, turn the TV on and be sure to select the input to which the DVD recorder is connected.

2
Press **OPEN/CLOSE** \blacktriangle button to open the disc tray. The disc tray will open.

3
Place the disc onto the disc tray with its label facing up and make sure to align the disc to the disc tray guide.

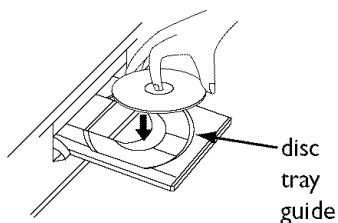

This operation may take a while to be recognized.

4
Press **TOP MENU** button to display the title menu. You can change "Original" or "Playlist" of VR mode using **MENU / LIST** button.

Video mode:

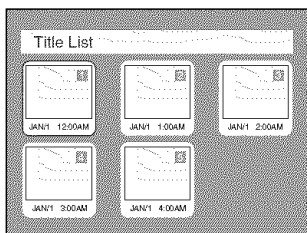

VR mode:

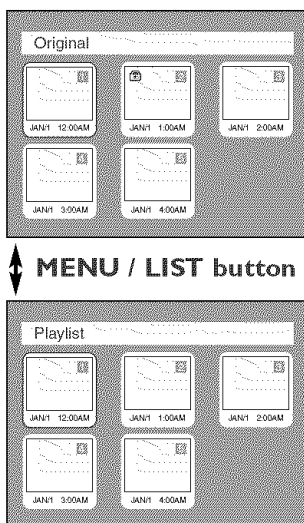

5
Select a desired title using \blacktriangle / \blacktriangledown / \blacktriangleleft / \blacktriangleright buttons, then press **ENTER** button. Playing will start.

6
Press **STOP** \blacksquare button to stop play.
To eject the disc, press **OPEN/CLOSE** \blacktriangle button to open the disc tray, then remove the disc before turning the DVD recorder off.

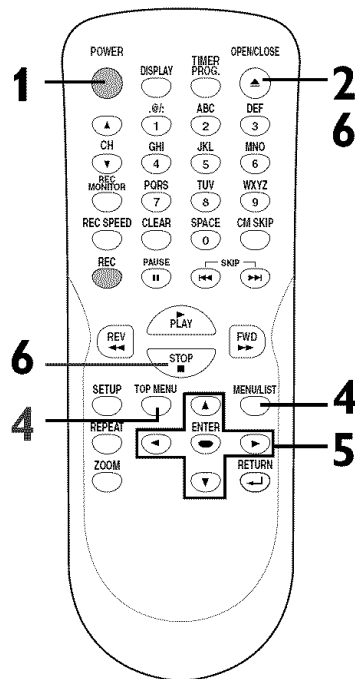

Note

- For DVD-R (Video mode) and DVD-RW (Video mode) discs which are already finalized, a title list will be displayed instead of thumbnails.

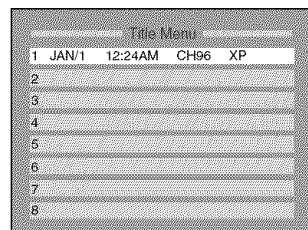

- You can resume play from where you stopped playing the disc. (Resume play) Refer to page 46 for details about resume play.
- Some discs may start playing automatically.

Playing discs

Basic playback (cont'd)



1

Press **POWER** button on the remote control or the front panel of the DVD recorder. When you are playing a DVD, turn the TV on and be sure to select the input to which the DVD recorder is connected.

2

Press **OPEN/CLOSE** ▲ button to open the disc tray. The disc tray will open.

3

Place the disc onto the disc tray with its label facing up and make sure to align the disc to the disc tray guide.

4

Press **PLAY** ► button to start playing. Playing will start.

If you are playing a DVD-Video disc, a menu may appear. Refer to pages 44-45 for details about a disc menu.

5

Press **STOP** ■ button to stop playing.

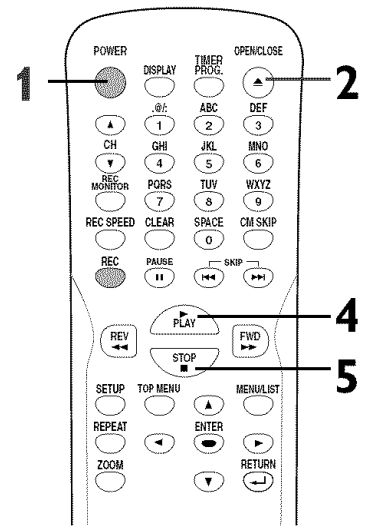

Note

- Some discs may start playing automatically.

For MP3 playback

1

In stop mode, press **TOP MENU** button to call up the MP3 menu.

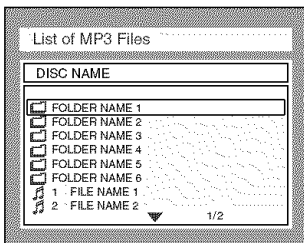

- To exit the menu, press **TOP MENU** button again.

2

Press ▲ / ▼ buttons to select a desired folder (group) or track, then press **ENTER** button.

When selecting track:

Playback will start.

When selecting the folder:

The files in folder will appear.

Press ▲ / ▼ buttons to select the track or folder you want, then press **ENTER** button.

- Press ◀ button or **RETURN** ↵ button to the previous hierarchy.
- Press **STOP** button to return to the first to the first item.

Hints for MP3 files:

- Folders are known as Groups, files are known as Tracks.
- Folders are accompanied by 📁 icon.
- MP3 files are accompanied by 🎵 icon. Reproduction will start from the selected track and go to the next one in turn.
- The system can recognize up to 255 groups (or folders) and up to 255 tracks.
- The name of group and track can be displayed in up to 32 characters. Unrecognizable characters will be replaced with asterisks.
- If there are no files in the folder, "No Files" will be displayed.

This unit recommends the files recorded under the following circumstances:

- Sampling frequency: 44.1kHz or 48kHz.
- Constant bit rate: 112kbps - 320kbps.

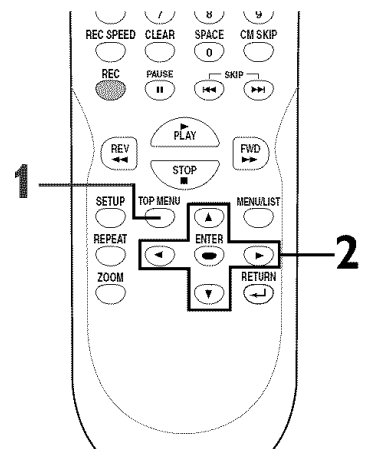

Note

- The audio source of MP3 files cannot be recorded as digital sound by an MD or DAT deck.
- Files whose extension is other than ".mp3(MP3)" will not be listed in the MP3 menu.
- Some unplayable folders or tracks may be listed in the MP3 menu due to the recording status.

Playing discs

Basic playback (cont'd)

Playing discs using the disc menu



A DVD disc contains a disc menu that describes the contents or allows you to customize the playback. For example, the menu may offer choices for subtitle languages, special features, or chapter selection.

Sometimes these are displayed automatically when you start playback, otherwise only appear when you press MENU / LIST button.

1

Press MENU / LIST button.
The DVD main menu will appear.

If the feature is not available,  may appear on the TV screen.

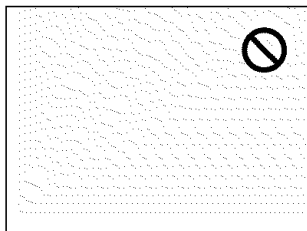

2

Select an item using ▲ / ▼ / ◀ / ▶ buttons, then press ENTER button to confirm.

Continue this step to set up all the features you want or to start playing the disc from the menu.

MENU / LIST button:

Displays a DVD disc menu which varies with the disc and may be the same as the 'Title menu.'

▲ / ▼ / ◀ / ▶ buttons:

Moves the cursor around screen.

Enter button:

Selects the currently highlighted menu option.

Number buttons:

Selects a numbered menu option (some discs only). (Press ENTER button after.)

3

Press MENU / LIST button to exit the menu.

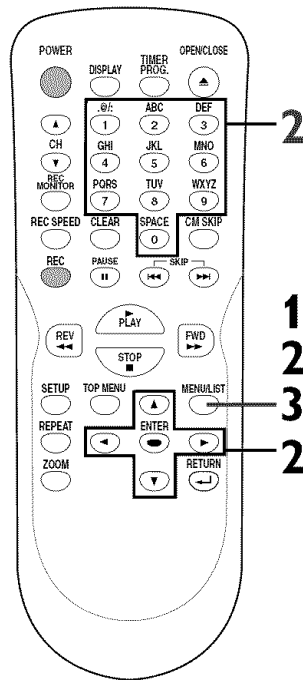

Note

- Menus vary among discs. Refer to the information accompanying the disc for details.

Basic playback (cont'd)

Playing discs using the title menu



Some DVDs have a title menu, which lists the titles available on them. It helps you to start play at a specific title.

1

Press TOP MENU button.

The title menu will appear.

If the feature is not available,  may appear on the TV screen.

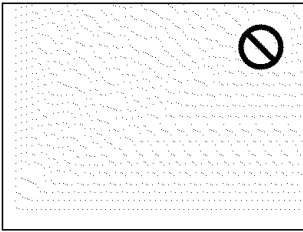

2

Select a title to play using the ▲ / ▼ / ◀ / ▶ buttons, then press ENTER button.

Play will begin at the title you selected.

TOP MENU button:

Displays the 'Title menu' of a DVD disc which varies with the disc.

▲ / ▼ / ◀ / ▶ buttons:

Moves the cursor around screen.

Enter button:

Selects the currently highlighted menu option.

Number buttons:

Selects a numbered menu option (some discs only). (Press ENTER button after.)

3

Press TOP MENU button to exit the title menu.

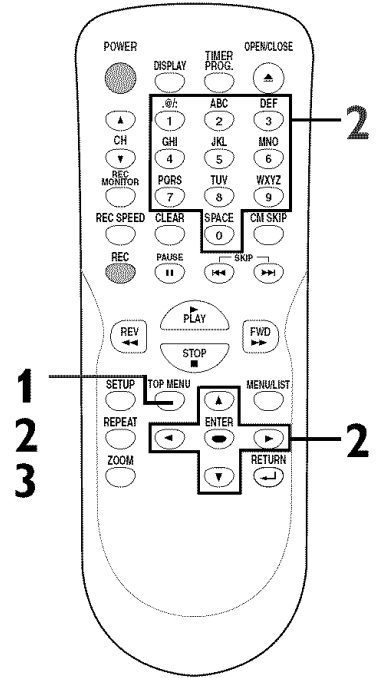

Note

- The TOP MENU button will not always be active with all DVDs.
- Menus vary among discs. Refer to the information accompanying the disc for details.

Before you start | Conventions | Getting started | Recording | Playing discs | Editing | Changing the SETUP menu | Others | Español

Playing discs

Special playback

Resume play



You can resume play from where you stopped playing the disc last.

1

During play, press **STOP** ■ button.

The resume message will appear.

Screen:

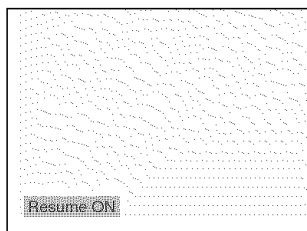

2

Press **PLAY** ► button.

In a few seconds, play will resume from the point at which it stopped last. You can resume play at the same point even if you turn off the DVD recorder.

To cancel the resume play and start playing the disc from the beginning, press **STOP** ■ button the second time while the play is stopped.

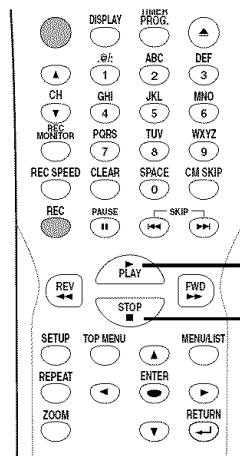

Note

- For MP3 files, playback will resume from the beginning of the track at which playback was stopped.

Fast forward / Fast reverse



1

During play, press **FWD** ►► or **REV** ◄◄ button.

Every time you press **FWD** ►► or **REV** ◄◄ button, approximate speed will be changed as follows.

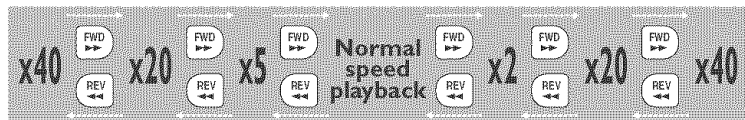

For Audio CDs, approximate speed is fixed at x8 with sound.

For MP3 files, approximate speed is fixed at x8.

To return to the normal play, press **PLAY** ► button.

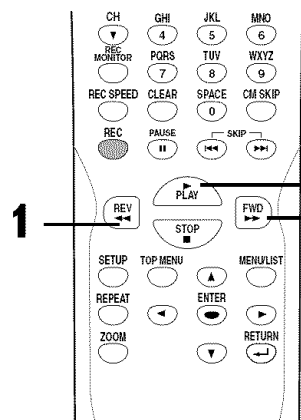

Note

- Forward/reverse speed will be indicated with icons as follows.

Forward (Approx. Speed)

x2: ►►

x20: ►►►

x40: ►►►►

Reverse (Approx. Speed)

x5: ◄◄

x20: ◄◄◄

x40: ◄◄◄◄

Special playback (cont'd)

Skipping TV commercials during play



You can skip TV commercials by pressing CM SKIP button, so that you can enjoy the recorded programs without interrupting.

1

During play, press CM SKIP button.

Normal play will start at 30 seconds ahead from the point you press CM SKIP button.

Every time you press CM SKIP button, the searching point will be extended by 30 seconds ahead. You can press up to 6 times (180 seconds).

e.g. Press CM SKIP button once

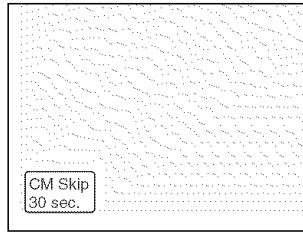

(forwarding 30 seconds.)

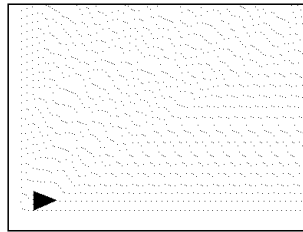

Playback will restart automatically.

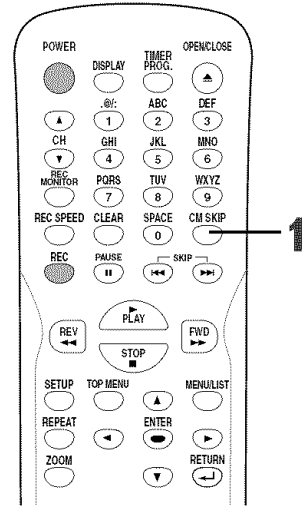

Pause



1

During play, press PAUSE II button.

Play will pause and sound will be muted.

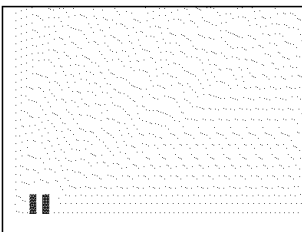

2

Press PLAY ► button to resume play.

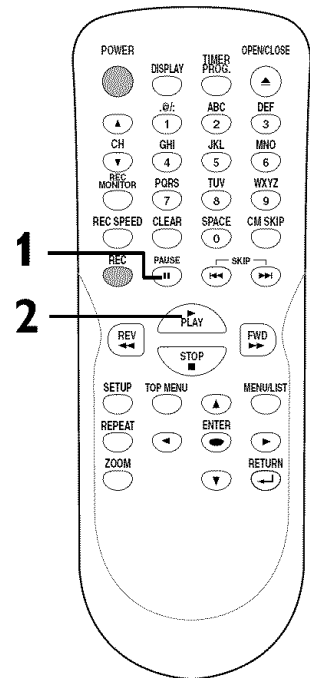

Playing discs

Special playback (cont'd)

Step by step playback



1

During play, press **PAUSE** **||** button.

Play will pause and sound will be muted.

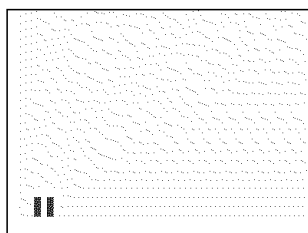

2

Press **SKIP** **▶▶** button repeatedly.

The play will advance one frame (or step) at a time when you press the SKIP button with the sound muted.

To play step by step backward:

Press **SKIP** **◀◀** button repeatedly. Every time you press the button, the play will go backward by one frame.

3

Press **PLAY** **▶** button to resume play.

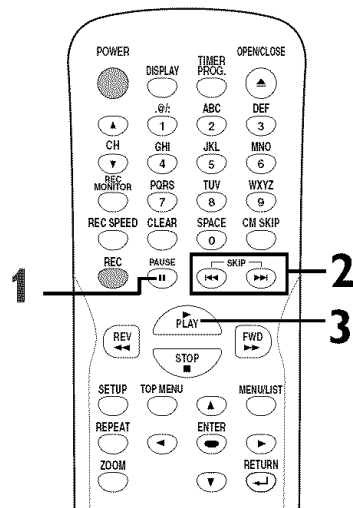

Slow forward / Slow reverse play



1

During play, press **PAUSE** **||** button, then press **FWD** **▶▶** or **REV** **◀◀** button.

Every time you press **FWD** **▶▶** or **REV** **◀◀** button, approximate speed will be changed as follows.

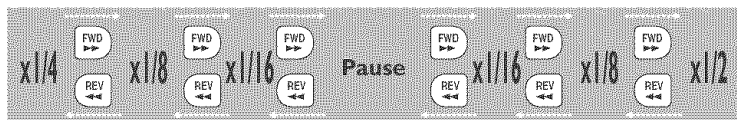

To return to the normal play, press **PLAY** **▶** button.

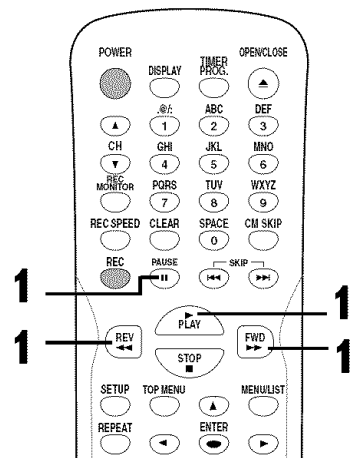

Note

• Forward/reverse speed will be indicated with icons as follows.

Forward (Approx. Speed)

x1/16: **▶▶▶▶**

x1/8: **▶▶▶**

x1/2: **▶▶▶▶▶▶**

Reverse (Approx. Speed)

x1/16: **◀◀◀◀**

x1/8: **◀◀◀**

x1/4: **◀◀◀◀◀**

Special playback (cont'd)

Zoom



1

During play, press **ZOOM** button.

Zoom menu will appear.

Screen:

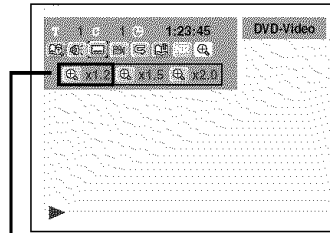

There are four options (x1.0, x1.2, x1.5 and x2.0), these are displayed excluding the current zoom rate.

2

Select a desired zoom factor to zoom using **◀/▶** buttons, then press **ENTER** button. The zoom area will be displayed.

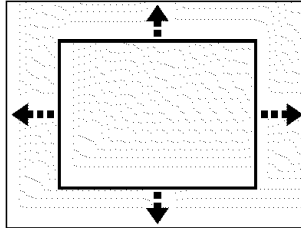

3

Select a desired zoom position using **▲/▼/◀/▶** buttons, then press **ENTER** button. The zoom play will start.

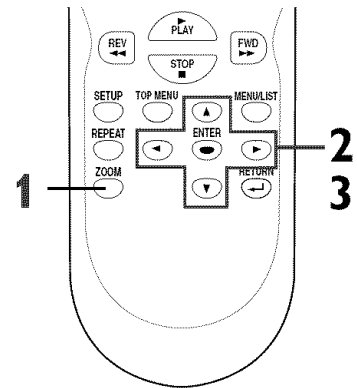

Note

- When selecting a smaller factor than the current one, the zoom area will not be displayed.
- To remove the zoom menu, press **ZOOM** button again at step 1.
- To cancel the zoom function, select x1.0 using **◀/▶** buttons, then press **ENTER** button.

Marker Setup



This feature allows you to assign a specific point on a disc to be called back later.

1

During play, press **DISPLAY** button.

The display menu will appear.

Screen:

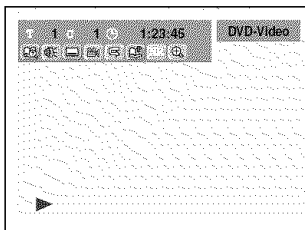

Screen for DVD:

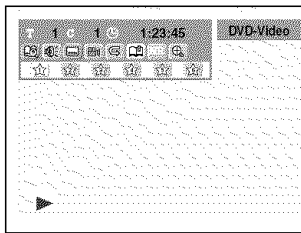

Screen for CD:

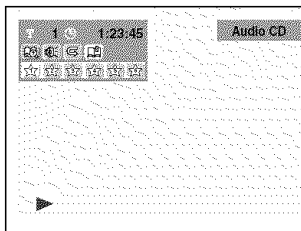

2

Select **📍** icon using **◀/▶** buttons, then press **ENTER** button.

Marker setup menu will appear.

3

Select a desired marker number using **◀/▶** buttons. When it reaches the desired point, press **ENTER** button.

4

To return to the marker later, select the desired marker number using **◀/▶** buttons, then press **ENTER** button.

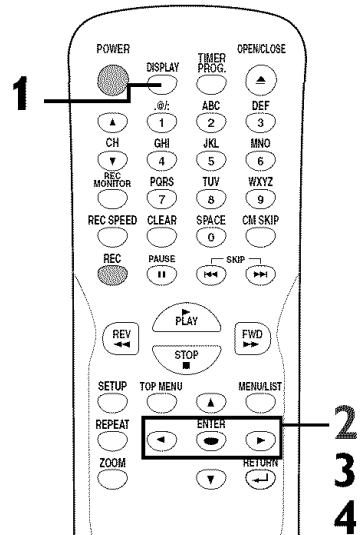

Note

- To clear a marker, select the marker number to be cleared, then press **CLEAR** button.
- All markers will be erased when you operate these operations listed below.
 - Opening the disc tray.
 - Turning off the power.
 - Recording to a recordable disc.
 - Changing the mode between Original and Playlist. (VR mode)
- You can mark up to 6 points.

Title/Chapter search



Using SKIP ◀◀ / ▶▶ buttons

1

During play, press **SKIP ▶▶** button to skip the current title or chapter and move to the next.

The title or chapter will move forward by one at a time.

To go back to the previous title or chapter, press **SKIP ◀◀** button. The title or chapter will move backward one title at a time.

Using DISPLAY button

1

During play, press **DISPLAY** button.

The display menu will appear.

Screen:

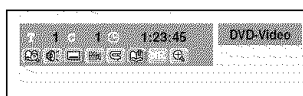

2

Select  icon using ◀ / ▶ buttons, then press **ENTER** button.

'T' for title will be highlighted.

Title:

Enter a desired title number to search using ▲ / ▼ buttons or number buttons, then press **ENTER** button.

Title search will start.

Chapter:

To move to 'C' for chapter, press ▶ button.

Enter a desired chapter number to search using ▲ / ▼ buttons or number buttons, then press **ENTER** button.

Chapter search will start.

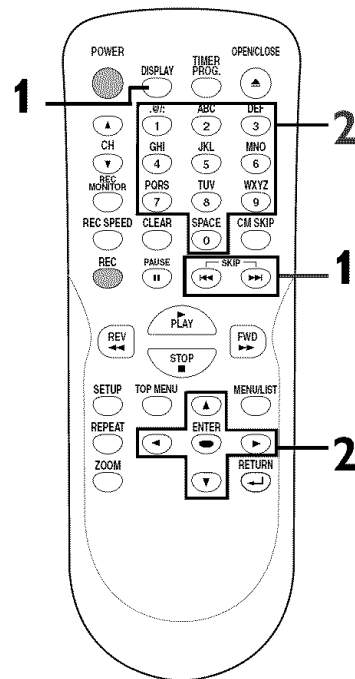

Playing discs

Search (cont'd)

Track search



Using SKIP |◀◀/▶▶| buttons

1

During play, press **SKIP ▶▶|** button to skip the current track and move to the next.

The track will move forward one track at a time.

To go back to the previous track, press **SKIP |◀◀** button. The track will move backward by one at a time.

Using DISPLAY button

1

During play, press **DISPLAY** button.

The display menu will appear.

Screen:

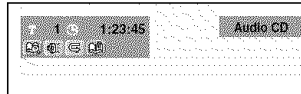

2

Select icon using **◀/▶** buttons, then press **ENTER** button.

'T' for track will be highlighted.

3

Enter a desired track number to search using **▲/▼** buttons or number buttons, then press **ENTER** button.

Track search will start.

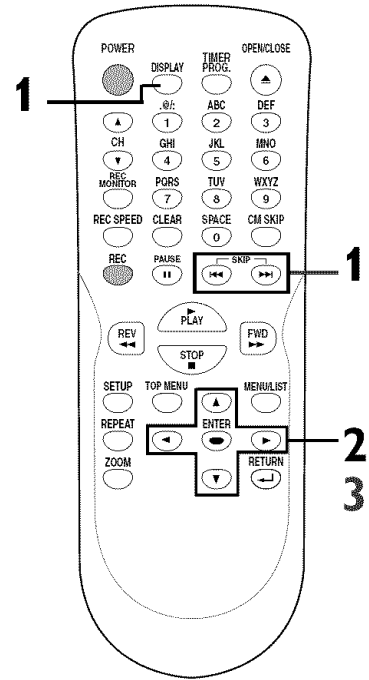

Time search



1

During play, press **DISPLAY** button.

The display menu will appear.

Screen for DVD:

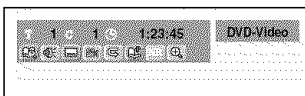

Screen for CD:

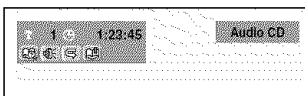

2

Select icon using **◀/▶** buttons, then press **ENTER** button.

'T' for title or track will be highlighted.

To move to the clock icon, press **▶** button.

3

Enter a desired time to search using **▲/▼** buttons or number buttons, then press **ENTER** button.

Time search will start.

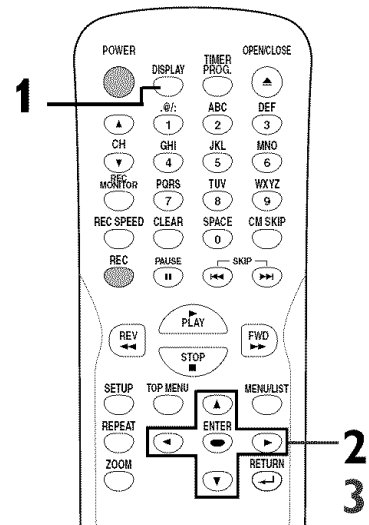

Note

- Time search function is available only in the same track or title.

Playing discs

Repeat/Random/Program playback

Repeat play



1

During play, press **REPEAT** button.

Repeat menu will appear.

Screen:

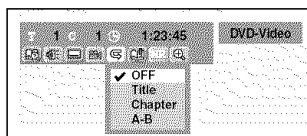

2

Select a desired option to repeat using **▲ / ▼** buttons, then press **ENTER** button.

The selected repeat play will start.

Title:

The current title will be played repeatedly. (DVD only)

Chapter:

The current chapter will be played repeatedly. (DVD only)

All:

The current disc will be played repeatedly. (CD, MP3, DVD-RW (VR mode) only)

A-B:

The A-B point will be played repeatedly. When pressing **ENTER** button while A-B is highlighted, the starting point (A) will be decided.

Press **ENTER** button again to select the ending point (B).

Track:

The current track will be played repeatedly. (CD, MP3 only)

Group:

The current group will be played repeatedly. (MP3 only)

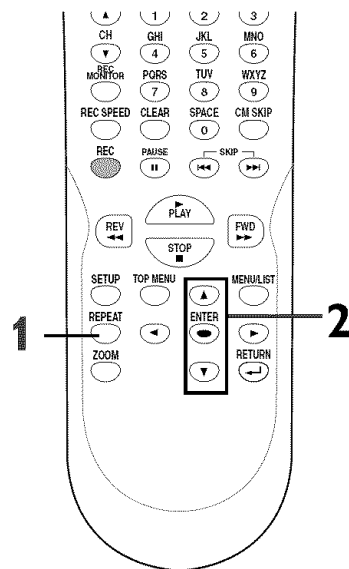

Note

- The A-B Repeat playback can only be set with in the current title (for DVDs), or current track (for Audio CDs).
- To cancel the repeat playback, select OFF at step 2.
- You cannot select "Group" during the random playback of MP3 files.

Random playback



With this function, you can play a disc randomly instead of playing in the original order.

1

Press **SETUP** button to display **SETUP/CD** menu.

SETUP/CD menu will appear.

Screen:

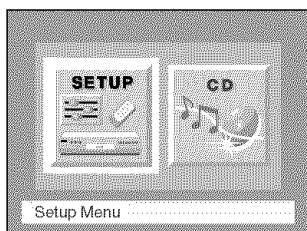

2

Select "**CD**" using **◀ / ▶** buttons, then press **ENTER** button.

CD Playback Mode menu will appear.

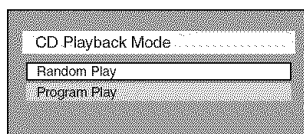

3

Select "**Random Play**" using **▲ / ▼** buttons, then press **ENTER** button.

Random play will start.

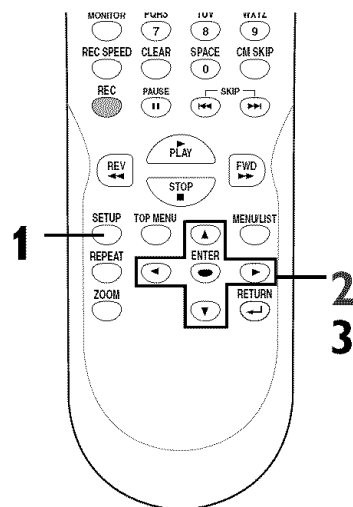

Note

- To cancel random play, press **STOP** button twice during random play.

Repeat/Random/Program playback (cont'd)

Program play



You can program the disc to play in your desired order.

1

Press **SETUP** button to display **SETUP/CD** menu. **SETUP/CD** menu will appear.

Screen:

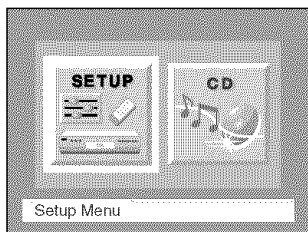

2

Select "**CD**" using **◀/▶** buttons, then press **ENTER** button.

CD Playback Mode menu will appear.

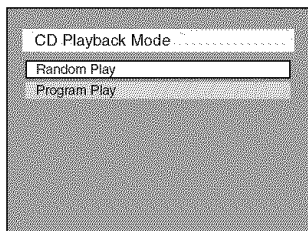

3

Select "**Program Play**" using **▲/▼** buttons, then press **ENTER** button.

Program play list will appear.

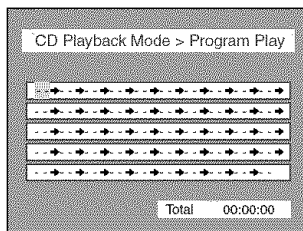

4

Select a desired track using **▲/▼** buttons, then press **ENTER** button or **▶** button.

A cursor will move to next.

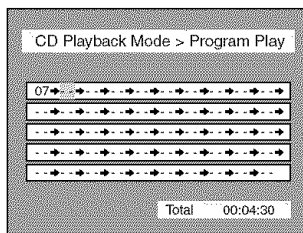

5

Press **PLAY ▶** button to start **program play**.

Program play will start.

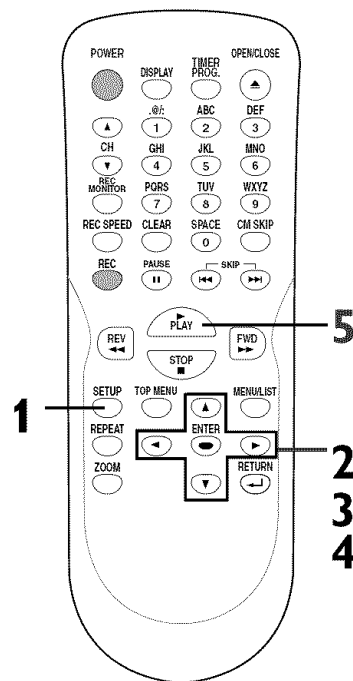

Note

- To erase tracks you selected, press **CLEAR** button.
- You can make program settings up to 50.
- To cancel program play, press **STOP ■** button twice during program play.
- You may also select a desired track using **Number** buttons at step 4.

Playing discs

Selecting the format of audio and video

You can select an audio or video format as you prefer depending on the contents of the disc you are playing.

Switching audio soundtrack



When playing a DVD-Video disc recorded with two or more soundtracks (these are often in different languages), you can switch them during play. On DVD-RW discs recorded in VR mode, you can switch to main (L), sub audio (R) or a mix of both (L/R).

1

During play, press **DISPLAY** button.

The display menu will appear.

Screen:

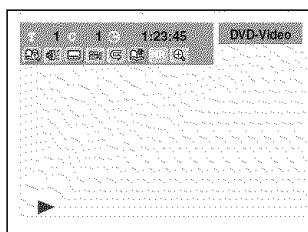

2

Select icon using **◀ / ▶** buttons, then press **ENTER** button.

Audio menu will appear.

<DVD-Video>

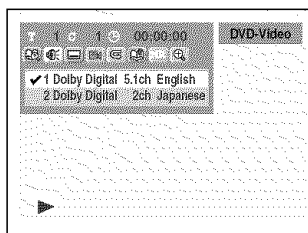

<DVD-RW VR mode>

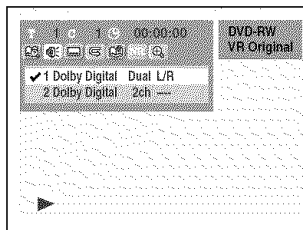

3

Select a desired audio soundtrack using **▲ / ▼** buttons, then press **ENTER** button.

<DVD-Video>

Audio soundtrack will switch.

<DVD-RW VR mode>

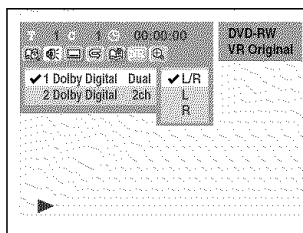

4

Select a desired audio channel using **▲ / ▼** buttons, then press **ENTER** button.

Audio channel will switch.

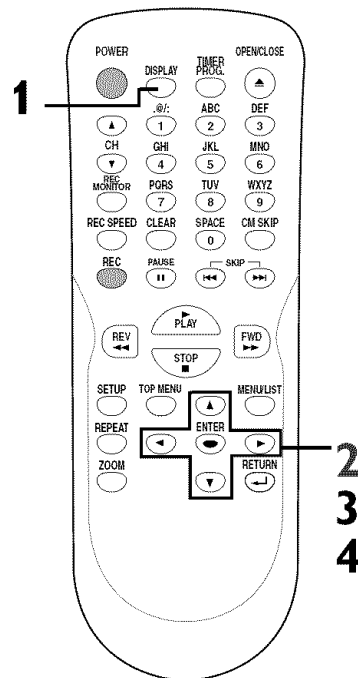

Note

- Some discs will only allow you to change the soundtrack from the disc's menu. Press **TOP MENU** button or **MENU / LIST** button to display the disc's menu.
- On DVD-RW discs recorded in VR mode that may have both a main and a sub audio channel, you can switch to main (L), sub audio (R), or a mix of both (L/R).
- This unit **CANNOT** record in both stereo and SAP (Secondary Audio Program) at the same time.

Playing discs

Selecting the format of audio and video (cont'd)



When playing Audio CDs or MP3 files you can switch between stereo, just the left channel or just the right channel.

1

During play, press **DISPLAY** button.

The display menu will appear.

Screen:

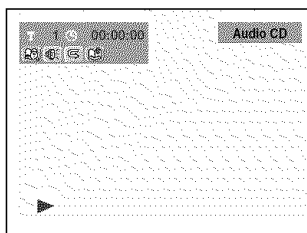

2

Select icon using **◀ / ▶** buttons, then press **ENTER** button.

Audio menu will appear.

3

Select a desired audio channel using **▲ / ▼** buttons, then press **ENTER** button.

Audio channel will switch.

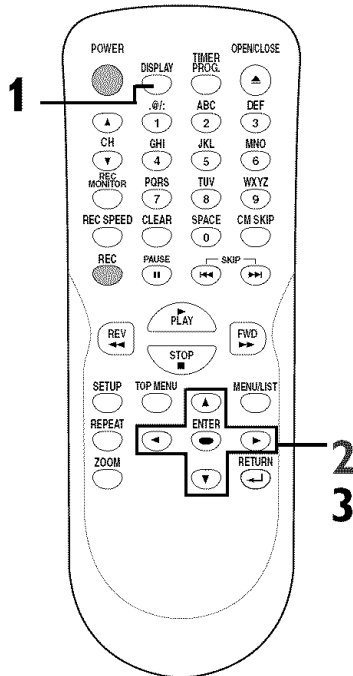
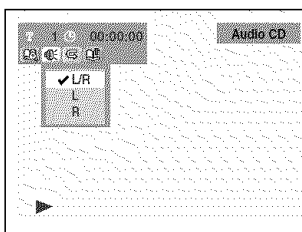

Switching subtitles



Many DVD Video discs have subtitles in one or more languages – the case usually tells you which subtitle languages are available. You can switch subtitle languages anytime during playback.

1

During play, press **DISPLAY** button.

The display menu will appear.

Screen:

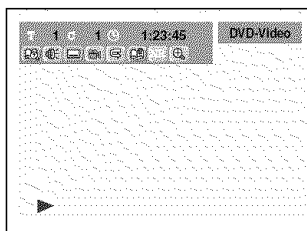

2

Select icon using **◀ / ▶** buttons, then press **ENTER** button.

Subtitle menu will appear.

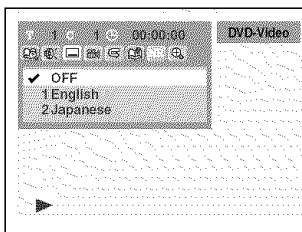

3

Select a desired subtitle language using **▲ / ▼** buttons, then press **ENTER** button.

Subtitle will be displayed in the selected language.

When selecting “OFF,” subtitle will disappear.

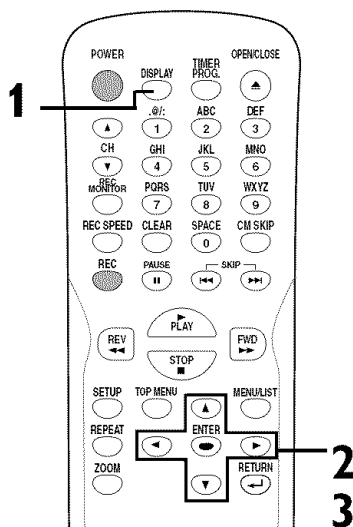

Note

- Some discs will only allow you to change the subtitle from the disc menu. Press **TOP MENU** button or **MENU / LIST** button to display the disc menu.

Playing discs

Selecting the format of audio and video (cont'd)

Switching camera angles



Some DVD Video discs feature scenes shot from two or more angles, check the case for details: it should be marked with an angle icon if it contains multi-angle scenes.

1

During play, press **DISPLAY** button.

The display menu will appear.

Screen:

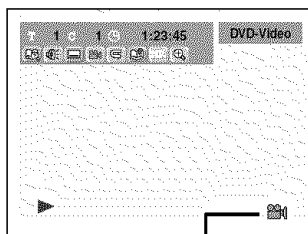

Angle icon appears when a switching camera angle is available.

2

Select icon using **◀/▶** buttons, then press **ENTER** button.

Angle will switch each time you press ENTER button.

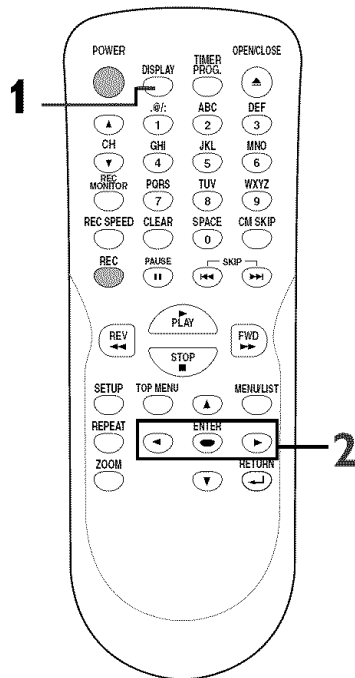

Reducing block noise

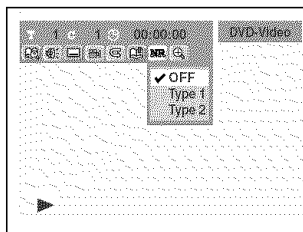

1

During play, press **DISPLAY** button.

The display menu will appear.

Screen:

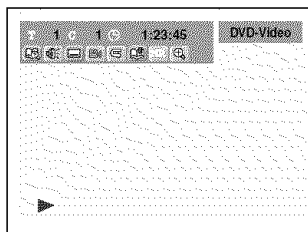

2

Select icon using **◀/▶** buttons, then press **ENTER** button.

NR menu will appear.

3

Select a desired option using **▲/▼** buttons, then press **ENTER** button.

Your setting will be activated.

This function reduces noise in the playback picture. When playing back discs recorded in long time mode such as SLP or SEP mode, select "Type 1" or "Type 2". ("Type 2" is more effective.) When playing back discs with a few noises such as DVD-Video discs, select "OFF".

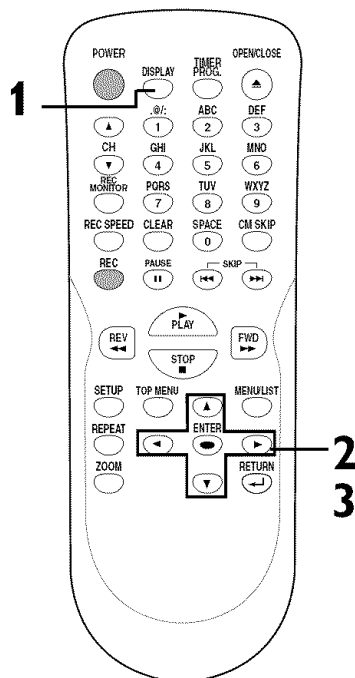

Guide to a title list

Title list allows you to check the titles recorded on the disc easily. You can choose a title to play from this screen and easily edit the titles as you prefer.

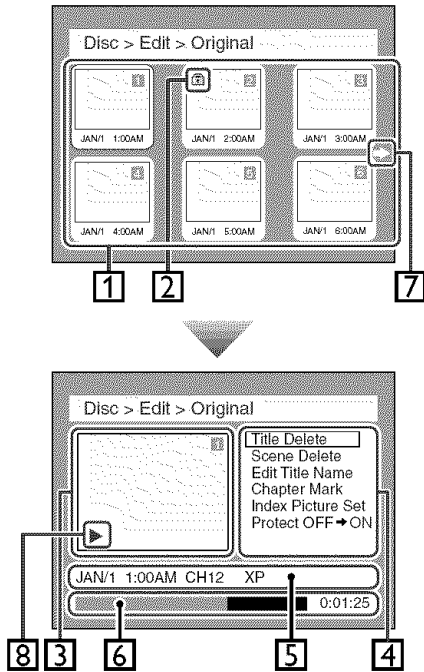

1. Titles recorded on the disc can be selected to edit by pressing ENTER button with the cursor on the title.
2. Protect icon, which appears when the title has been protected.
3. The selected title thumbnails from the title list.
4. The menus in here for editing titles as you prefer. The available menus depends on the disc type and the format type.
5. The details of the title, which can be changed to the title name you will edit.
6. Time status bar of the title.
7. The arrow icon, which means the title list includes a next or a previous page. Press ► or ◀ button by following direction of the icon.
8. Playback status of the current disc.

Editing discs with Video mode

You can edit discs with Video mode for the following items. Be sure that once you edit titles, they will not remain as original.

- Deleting titles (Refer to page 59)
- Putting names on titles (Refer to pages 60-61)
- Setting or clearing chapter markers (Refer to page 62)

Note

- Once a disc is finalized, editing the disc or recording to the disc will not be available. (Except DVD-RW discs in VR mode.)
- A playlist is not available with the DVD-R discs and DVD-RW discs in Video mode.

Information on disc editing (cont'd)

Editing discs with VR mode

For discs with VR mode, you can edit from “Original” menu or “Playlist” menu, which is created from the original.

Editing original titles

The following items can be used to edit the original titles.

- Deleting titles (Refer to page 63)
- Deleting parts of titles (Refer to pages 64-65)
- Putting names on titles (Refer to pages 65-66)
- Setting or clearing chapter markers (Refer to pages 67-68)
- Setting pictures for thumbnails (Refer to pages 68-69)
- Setting titles to protect (Refer to page 70)
- Releasing titles from protecting (Refer to page 71)

Editing playlists

You can create a playlist from original titles, so that you can edit as you prefer without losing original titles.

The following items you can edit with a playlist.

- Deleting titles (Refer to page 72)
- Deleting parts of titles (Refer to pages 73-74)
- Putting names on titles (Refer to pages 74-75)
- Setting or clearing chapter markers (Refer to pages 76-77)
- Setting pictures for thumbnails (Refer to pages 77-78)
- Adding titles to a playlist (Refer to page 79)
- Deleting a playlist (Refer to page 80)

Note

- Original titles once edited will not remain as recorded originally. When you want to leave the original as it is, edit the playlist as you prefer. (Refer to pages 72-80)

Deleting titles



You can delete titles which you do not need anymore. Be advised that the titles once deleted cannot be brought back to the disc.

When the last title in the title list in Video mode is deleted, the disc space to record will be increased.

1

Press **SETUP** button. Select **"DISC"** using **◀ / ▶** buttons, then press **ENTER** button. DISC menu will appear.

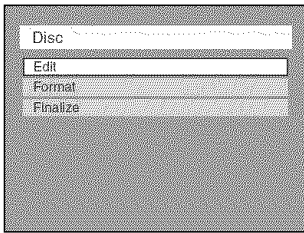

2

Select **"Edit"** using **▲ / ▼** buttons, then press **ENTER** button.

Titlelist will appear.
Screen:

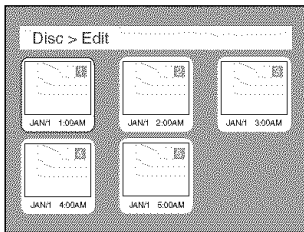

3

Select a desired title using **▲ / ▼ / ◀ / ▶** buttons, then press **ENTER** button.

Edit menu will appear.

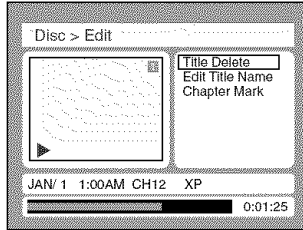

4

Select **"Title Delete"** using **▲ / ▼** buttons, then press **ENTER** button.

Option window will appear.

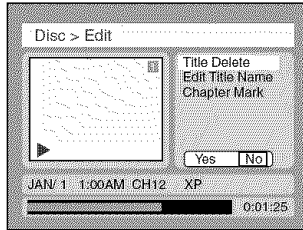

5

Select **"Yes"** using **◀ / ▶** buttons, then press **ENTER** button.

Title will be deleted.

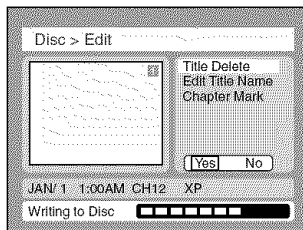

This operation may take a while to be completed.

6

After writing to disc is completed, press **SETUP** button to exit DISC menu.

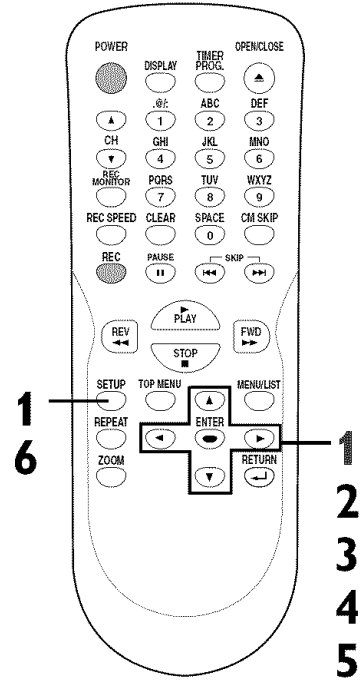

Before you start... Conventions... Getting started... Recording... Playing discs... Editing... Changing the SETUP menu... Others... Español

Editing DVD-RW discs in Video mode (cont'd)

Putting names on titles



You can put title names on the titles and change the names from this menu.

The names you put on the titles will be displayed on a titelist.

1
Press **SETUP** button. Select "DISC" using **◀/▶** buttons, then press **ENTER** button. DISC menu will appear.

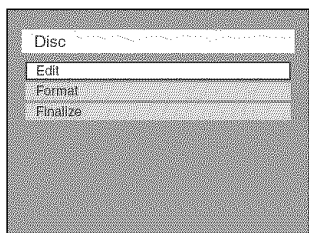

2
Select "Edit" using **▲/▼** buttons, then press **ENTER** button. Titelist will appear.

Screen:

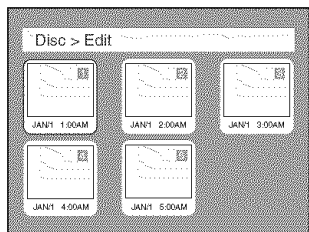

3
Select a desired title using **▲/▼/◀/▶** buttons, then press **ENTER** button. Edit menu will appear.

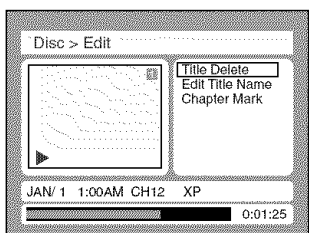

4
Select "Edit Title Name" using **▲/▼** buttons, then press **ENTER** button. A window for entering a title name will appear.

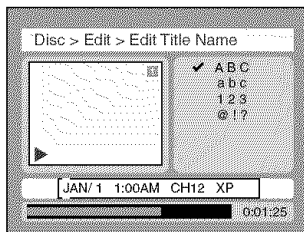

5
To enter a title name, follow the steps of "Guide to edit title name" on this page.

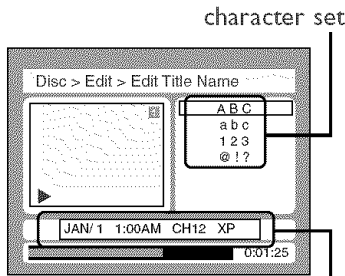

area for entering title names

When you finish entering a title name, press **ENTER** button.

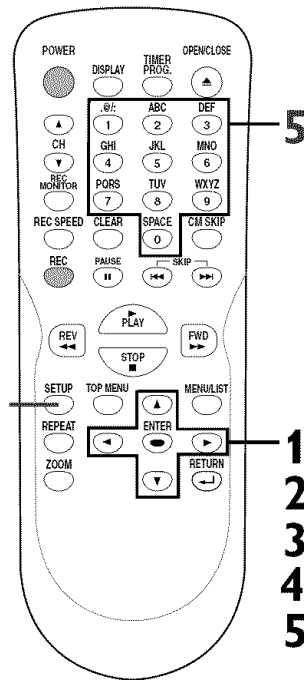

[Guide to edit title name]

[Step1]: Select a desired character set using **▲/▼** buttons, then press **ENTER** button.

[Step2]: Press Number buttons following by the list below.

Select	ABC	abc	123	@!?
Press	<space>	<space>	0	<space>
①	-	-	-	"#\$%&'()*+,-./:;<=>?@ [] ^ _ { } !
②	ABC	abc	2	-
③	DEF	def	3	-
④	GHI	ghi	4	-
⑤	JKL	jkl	5	-
⑥	MNO	mno	6	-
⑦	PQRS	pqrs	7	-
⑧	TUV	tuv	8	-
⑨	WXYZ	wxyz	9	-

* Press **①** button, character set will be changed to the "@!?" mode automatically.

- To delete letters, press **CLEAR** button repeatedly. Holding **CLEAR** button to delete all letters.
- To go on to the next entering area for letters, press **▶** button.
- You can enter up to 30 letters.

6

Select "Yes" using ◀ / ▶ buttons, then press ENTER button.

The name you entered will be activated for the title.

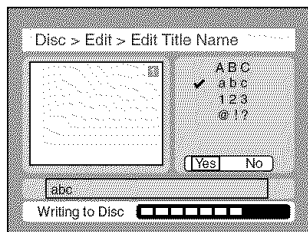

This operation may take a while to be completed.

7

After writing to disc is completed, press SETUP button to exit DISC menu.

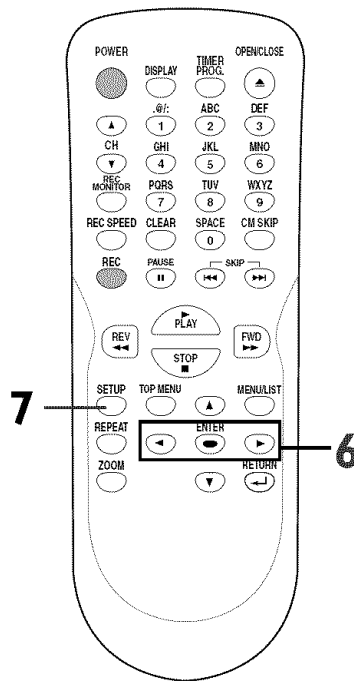

Editing DVD-RW discs in Video mode (cont'd)

Setting or clearing chapter markers



You can put chapter markers in each title. Once a chapter is marked, you can use it for the chapter search feature.

You can set chapter markers at a specified time you selected for titles with more than 5 minutes.

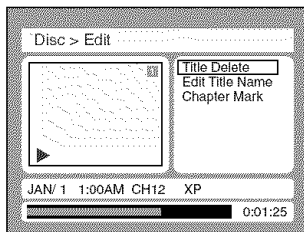

1
Press **SETUP** button. Select **"DISC"** using **◀ / ▶** buttons, then press **ENTER** button. DISC menu will appear.

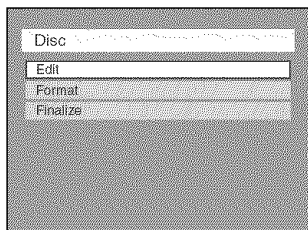

4
Select **"Chapter Mark"** using **▲ / ▼** buttons, then press **ENTER** button. Option window will appear.

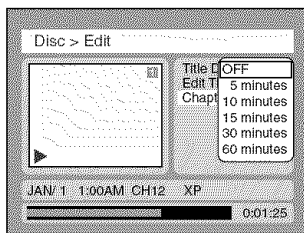

2
Select **"Edit"** using **▲ / ▼** buttons, then press **ENTER** button. Titlelist will appear.
Screen:

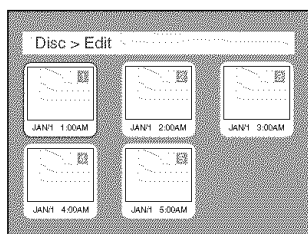

5
Select a desired time using **▲ / ▼** buttons, then press **ENTER** button. Option window will appear.

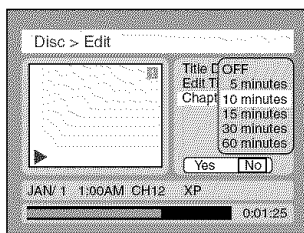

3
Select a desired title using **▲ / ▼ / ◀ / ▶** buttons, then press **ENTER** button. Edit menu will appear.

6
Select **"Yes"** using **◀ / ▶** buttons, then press **ENTER** button. A chapter marker will be added.

7
After writing to disc is completed, press **SETUP** button to exit DISC menu.

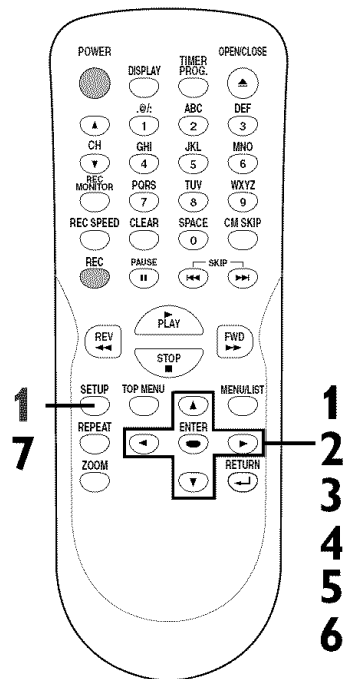

Note
• You cannot select a time for putting markers beyond a length of a title.
• A chapter marker may be delayed according to the recording content.

Editing DVD-RW discs in VR mode (Original)

Deleting titles



When a title is deleted from an original list in VR mode, the disc space to record will be increased. Be advised that the titles once deleted cannot be brought back to the disc.

1
Press **SETUP** button. Select “**DISC**” using **◀ / ▶** buttons, then press **ENTER** button. **DISC** menu will appear.

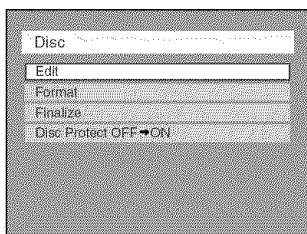

2
Select “**Edit**” using **▲ / ▼** buttons, then press **ENTER** button. Original/PlayList menu will appear. Screen:

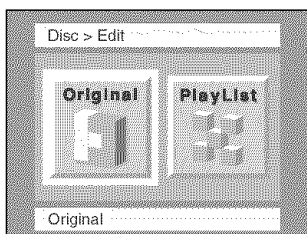

3
Select “**Original**” using **◀ / ▶** buttons, then press **ENTER** button. Original list will appear.

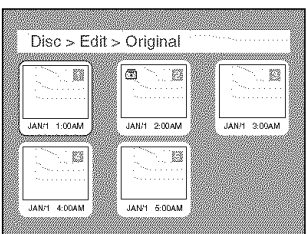

4
Select a desired title using **▲ / ▼ / ◀ / ▶** buttons, then press **ENTER** button. Original menu will appear.

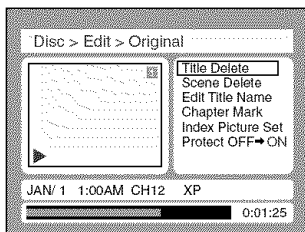

5
Select “**Title Delete**” using **▲ / ▼** buttons, then press **ENTER** button. Option window will appear.

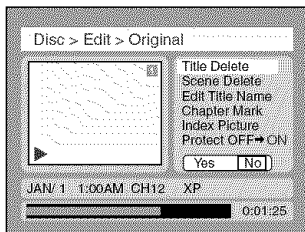

6
Select “**Yes**” using **◀ / ▶** buttons, then press **ENTER** button. Title will be deleted.

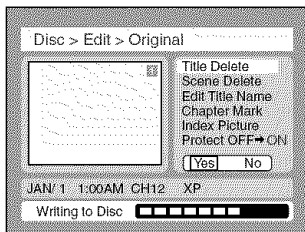

This operation may take a while to be completed.

7
After writing to disc is completed, press **SETUP** button to exit **DISC** menu.

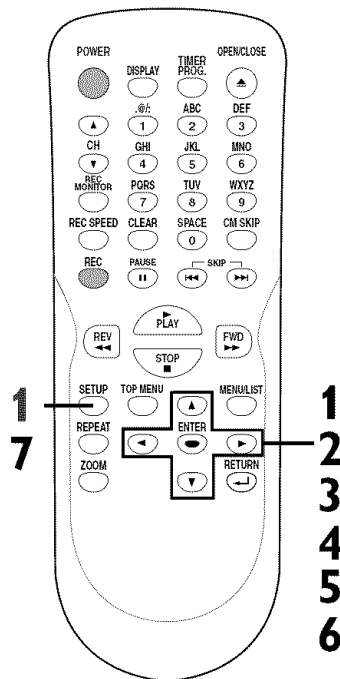

Before you start

Connections

Getting started

Recording

Playing discs

Editing

Changing the SETUP menu

Others

Spanish

Editing DVD-RW discs in VR mode (Original) (cont'd)

Deleting parts of titles



You can delete part of a title, the disc space to record will be increased.

Be advised that the parts once deleted cannot be brought back to the disc.

1

Press **SETUP** button. Select **"DISC"** using **◀ / ▶** buttons, then press **ENTER** button. DISC menu will appear.

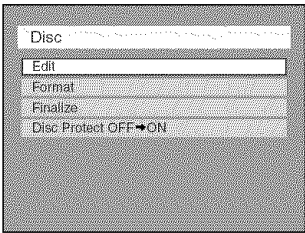

2

Select **"Edit"** using **▲ / ▼** buttons, then press **ENTER** button. Original/PlayList menu will appear. Screen:

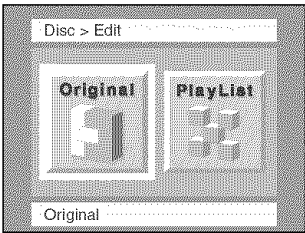

3

Select **"Original"** using **◀ / ▶** buttons, then press **ENTER** button. Original list will appear.

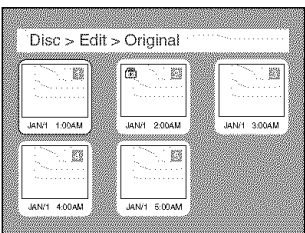

4

Select a desired title using **▲ / ▼ / ◀ / ▶** buttons, then press **ENTER** button. Original menu will appear.

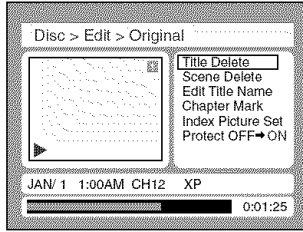

5

Select **"Scene Delete"** using **▲ / ▼** buttons, then press **ENTER** button. Option window will appear.

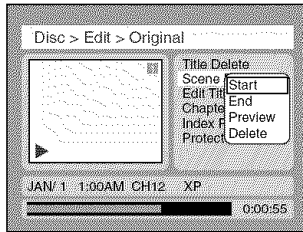

6

Press **ENTER** button to decide a start point, then press **ENTER** button to decide an end point. A cursor will move to "Preview." You can check a preview.

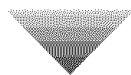

<Preview>

Start point End point

Before editing



Edited

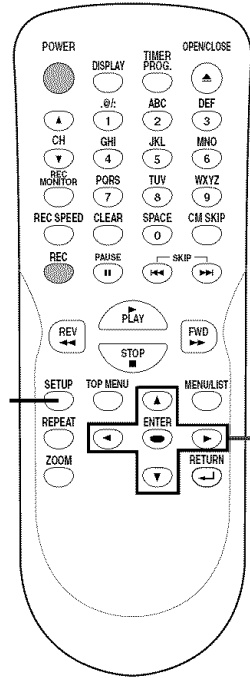
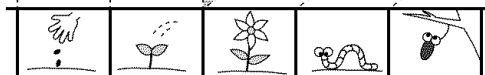

Editing DVD-RW discs in VR mode (Original) (cont'd)

7
Select "Delete" using ▲ / ▼ buttons, then press ENTER button.

Option window will appear.

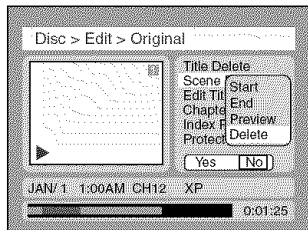

8
Select "Yes" using ◀ / ▶ buttons, then press ENTER button.

Part of a title will be deleted.

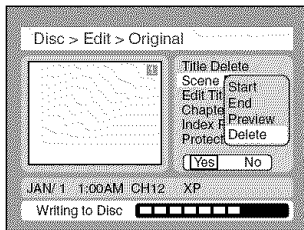

This operation may take a while to be completed.

9
After writing to disc is completed, press SETUP button to exit DISC menu.

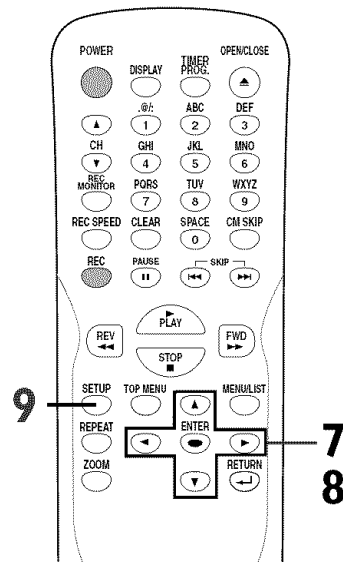

Note
• You cannot select "Scene Delete" when the number of chapter markers in the original or playlist is more than 900.

Putting names on titles



You can put title names on the titles and change the names from this menu.

The names you put on the titles will be displayed on a titlelist.

1
Press SETUP button. Select "DISC" using ◀ / ▶ buttons, then press ENTER button. DISC menu will appear.

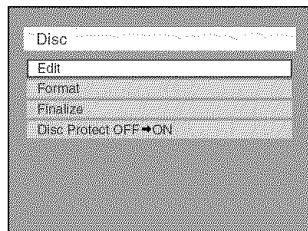

2
Select "Edit" using ▲ / ▼ buttons, then press ENTER button.

Original/PlayList menu will appear. Screen:

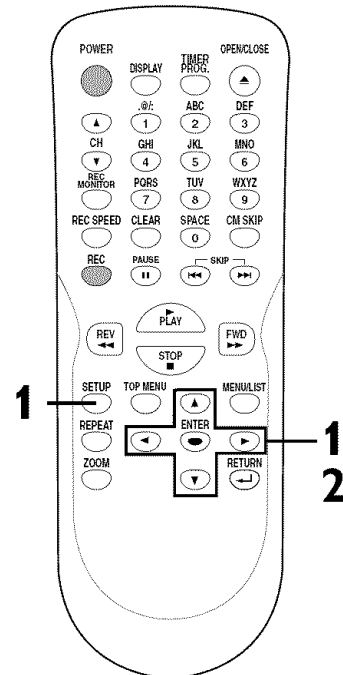
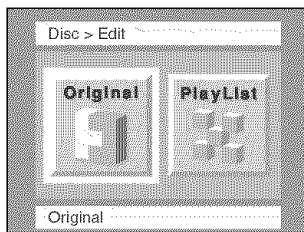

Editing

Editing DVD-RW discs in VR mode (Original) (cont'd)

3

Select "Original" using ◀/▶ buttons, then press ENTER button.

Original list will appear.

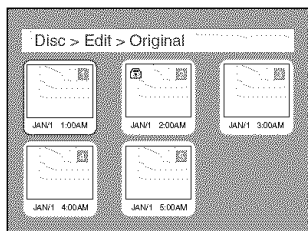

4

Select a desired title using ▲/▼/◀/▶ buttons, then press ENTER button.

Original menu will appear.

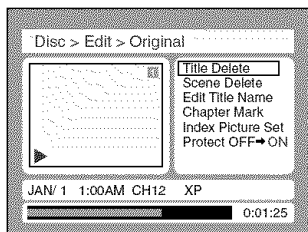

5

Select "Edit Title Name" using ▲/▼ buttons, then press ENTER button.

A window for entering a title name will appear.

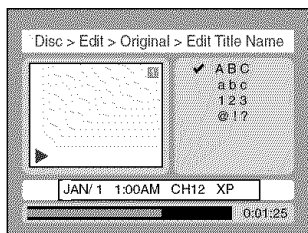

6

To enter a title name, follow the steps of "Guide to edit title name" on this page.

character set

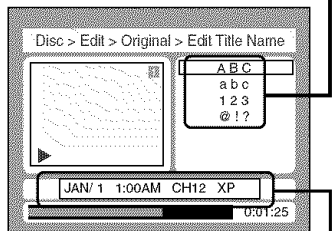

area for entering title names

When you finish entering a title name, press ENTER button.

7

Select "Yes" using ◀/▶ buttons, then press ENTER button.

The name you entered will be activated for the title.

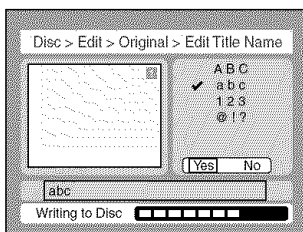

This operation may take a while to be completed.

8

After writing to disc is completed, press SETUP button to exit DISC menu.

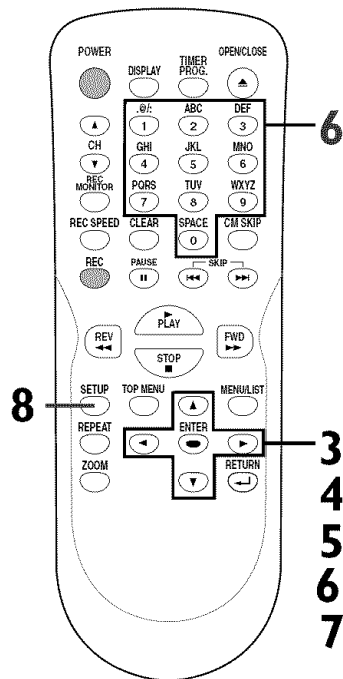

[Guide to edit title name]

[Step1]: Select a desired character set using ▲/▼ buttons, then press ENTER button.

[Step2]: Press Number buttons following by the list below.

Select Press	ABC	abc	123	@!?
0	<space>	<space>	0	<space>
1	-	-	1	"#\$%&'()*+,-./:;<=>?@[]^_{ }!
2	ABC	abc	2	-
3	DEF	def	3	-
4	GHI	ghi	4	-
5	JKL	jkl	5	-
6	MNO	mno	6	-
7	PQRS	pqrs	7	-
8	TUV	tuv	8	-
9	WXYZ	wxyz	9	-

* Press 1 button, character set will be changed to the "@!?" mode automatically.

- To delete letters, press CLEAR button repeatedly. Holding CLEAR button to delete all letters.
- To go on to the next entering area for letters, press ▶ button.
- You can enter up to 30 letters.

Editing DVD-RW discs in VR mode (Original) (cont'd)

Setting or clearing chapter markers



You can put chapter markers in each title. Once a chapter is marked, you can use it for the chapter search feature.

You can put a chapter marker anywhere you want.

When the number of chapter markers in the original list comes to 999 in total, you cannot add any more chapter markers.

1

Press **SETUP** button. Select “**DISC**” using **◀ / ▶** buttons, then press **ENTER** button. DISC menu will appear.

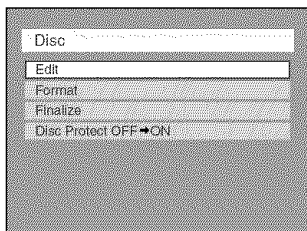

2

Select “**Edit**” using **▲ / ▼** buttons, then press **ENTER** button.

Original/PlayList menu will appear.

Screen:

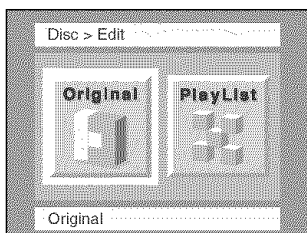

3

Select “**Original**” using **◀ / ▶** buttons, then press **ENTER** button.

Original list will appear.

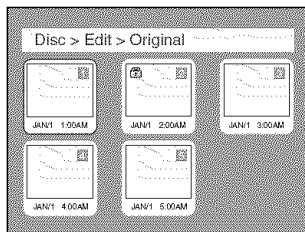

4

Select a desired title using **▲ / ▼ / ◀ / ▶** buttons, then press **ENTER** button.

Original menu will appear.

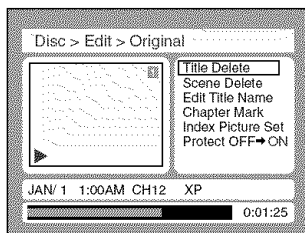

5

Select “**Chapter Mark**” using **▲ / ▼** buttons, then press **ENTER** button.

Option window will appear.

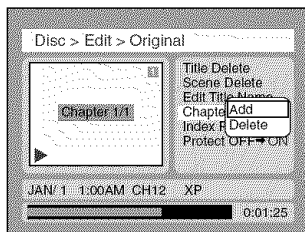

6

Select “**Add**” or “**Delete**” using **▲ / ▼** buttons, then press **ENTER** button.

Option window will appear.

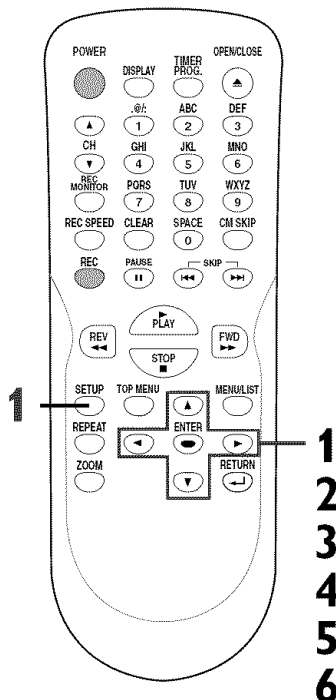
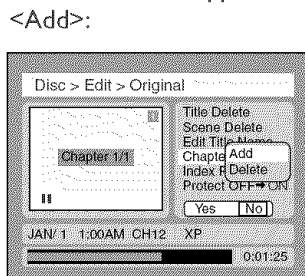

1
2
3
4
5
6

Before you start

Connections

Getting started

Recording

Playing discs

Editing

Changing the SETUP menu

Others

Spanish

Editing DVD-RW discs in VR mode (Original) (cont'd)

<Delete>:

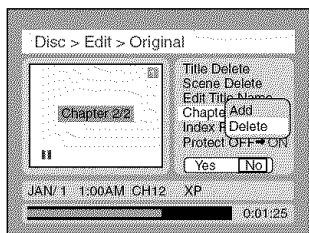

- You cannot delete the first chapter marker of each title.

7

Select "Yes" using **◀/▶** buttons, then press **ENTER** button.

A chapter marker will be added.

<Add>:

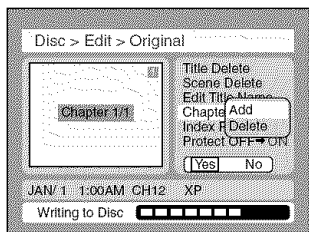

This operation may take a while to be completed.

The chapter marker which you selected will be deleted.

<Delete>:

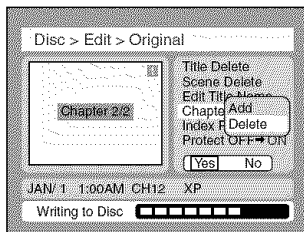

This operation may take a while to be completed.

8

After writing to disc is completed, press **SETUP** button to exit DISC menu.

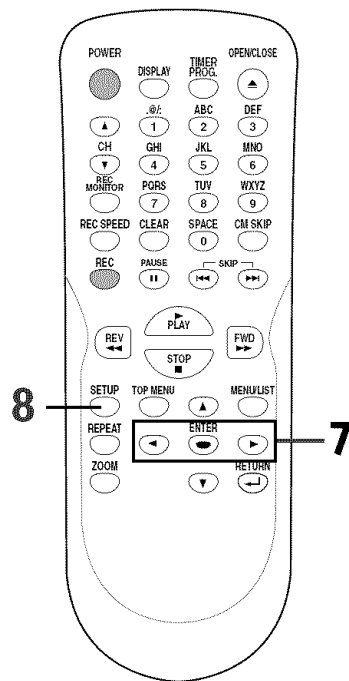

Setting pictures for thumbnails



You can set a picture to each title for a thumbnail. It helps you to remember the contents of the title you are playing. The beginning picture has been selected as the default.

1

Press **SETUP** button. Select "DISC" using **◀/▶** buttons, then press **ENTER** button. DISC menu will appear.

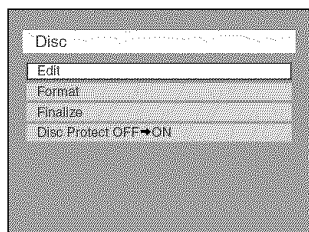

2

Select "Edit" using **▲/▼** buttons, then press **ENTER** button.

Original/PlayList menu will appear.

Screen:

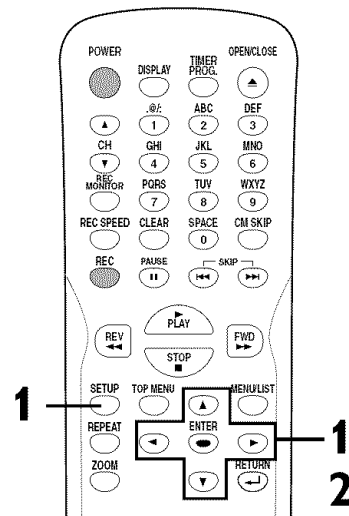
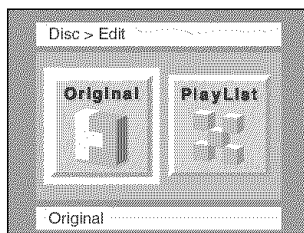

Note

- If a selected picture for a thumbnail is deleted by deleting a part of a title, a default picture will be selected.

3

Select "Original" using ◀/▶ buttons, then press ENTER button.

Original list will appear.

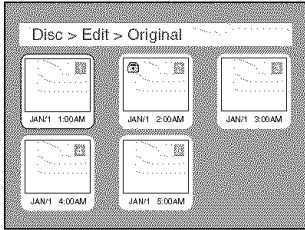

4

Select a desired title using ▲/▼/◀/▶ buttons, then press ENTER button.

Original menu will appear.

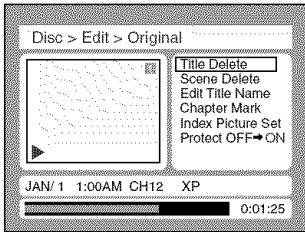

5

Select "Index Picture Set" using ▲/▼ buttons, then press ENTER button.

Option window will appear.

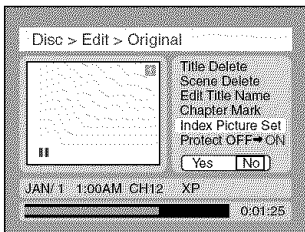

6

Select "Yes" using ◀/▶ buttons, then press ENTER button.

A picture for thumbnail will be set.

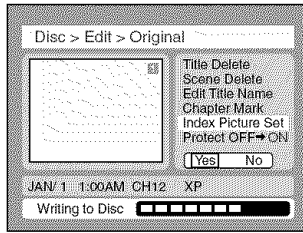

This operation may take a while to be completed.

7

After writing to disc is completed, press SETUP button to exit DISC menu.

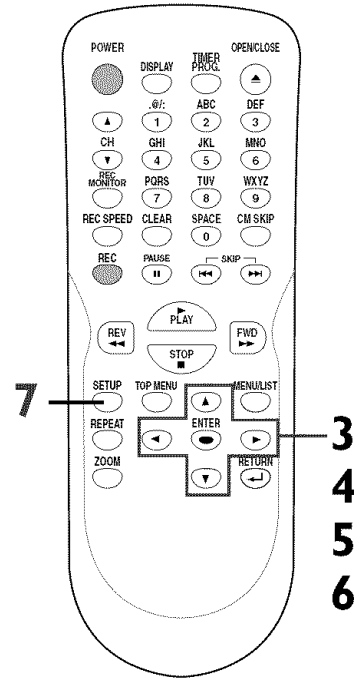

Editing DVD-RW discs in VR mode (Original) (cont'd)

Setting titles to protect



To prevent accidental editing, or erasing the titles, you can protect them from the original menu.

1

Press **SETUP** button. Select “**DISC**” using **◀/▶** buttons, then press **ENTER** button. DISC menu will appear.

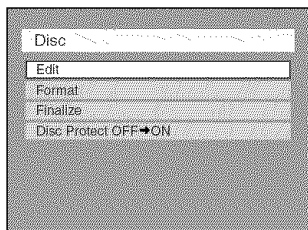

2

Select “**Edit**” using **▲/▼** buttons, then press **ENTER** button. Original/PlayList menu will appear. Screen:

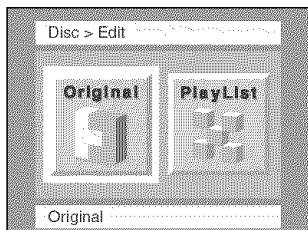

3

Select “**Original**” using **◀/▶** buttons, then press **ENTER** button. Original list will appear.

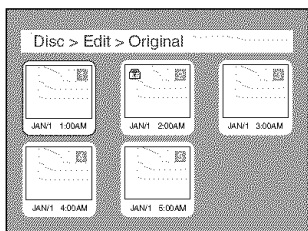

4

Select a desired title using **▲/▼/◀/▶** buttons, then press **ENTER** button.

Original menu will appear.

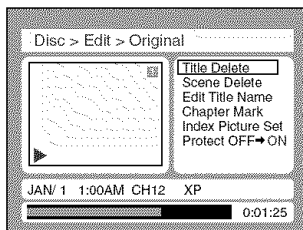

5

Select “**Protect OFF → ON**” using **▲/▼** buttons, then press **ENTER** button.

Option window will appear.

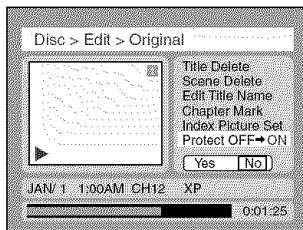

6

Select “**Yes**” using **◀/▶** buttons, then press **ENTER** button.

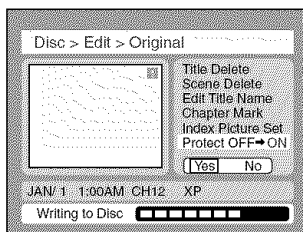

This operation may take a while to be completed.

7

After writing to disc is completed, press **SETUP** button to exit DISC menu.

To protect a whole disc (DVD-RW VR mode Only): Select “Disc Protect” from Disc menu, then select “Yes”.

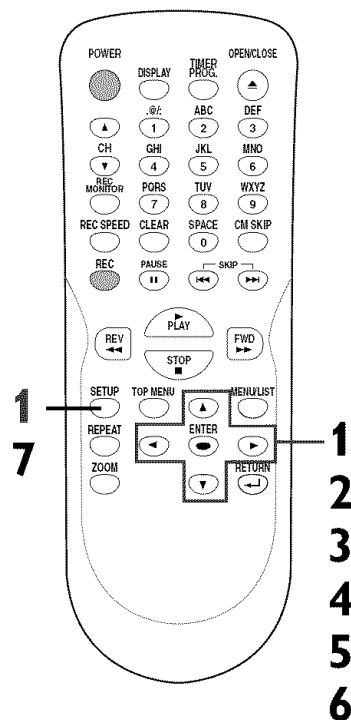

Editing DVD-RW discs in VR mode (Original) (cont'd)

Releasing titles from protecting



You are allowed to release the titles protecting feature once protected.

1

Press **SETUP** button. Select "DISC" using **◀/▶** buttons, then press **ENTER** button. DISC menu will appear.

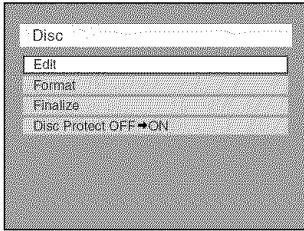

2

Select "Edit" using **▲/▼** buttons, then press **ENTER** button.

Original/PlayList menu will appear.
Screen:

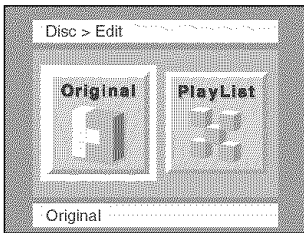

3

Select "Original" using **◀/▶** buttons, then press **ENTER** button.

Original list will appear.

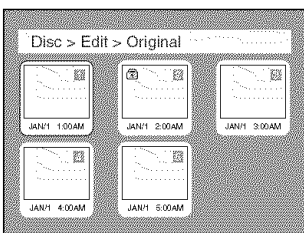

4

Select a desired title using **▲/▼/◀/▶** buttons, then press **ENTER** button.

Original menu will appear.

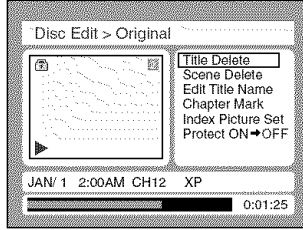

5

Select "Protect ON → OFF" using **▲/▼** buttons, then press **ENTER** button.

Option window will appear.

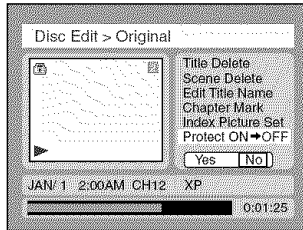

6

Select "Yes" using **◀/▶** buttons, then press **ENTER** button.

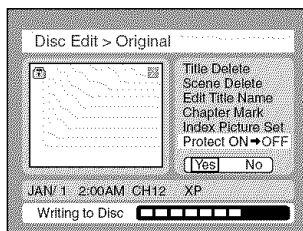

This operation may take a while to be completed.

7

After writing to disc is completed, press **SETUP** button to exit DISC menu.

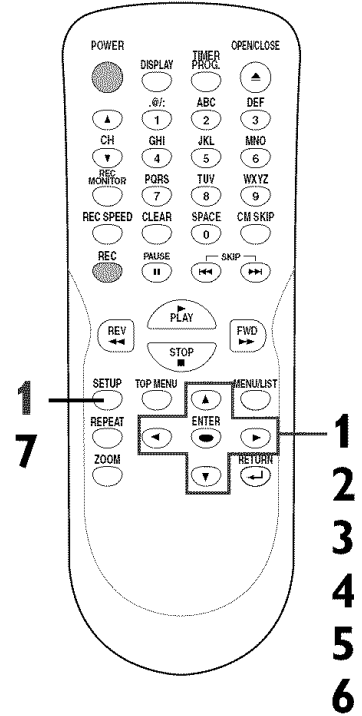

Before you start

Connections

Getting started

Recording

Playing discs

Editing

Changing the SETUP menu

Others

Appendix

Editing DVD-RW discs in VR mode (Playlist)

Deleting titles



In VR mode, even when a title is deleted from a Playlist, the original title will remain in an Original list. The disc space to record will not be increased.

1

Press **SETUP** button. Select “**DISC**” using **◀/▶** buttons, then press **ENTER** button. DISC menu will appear.

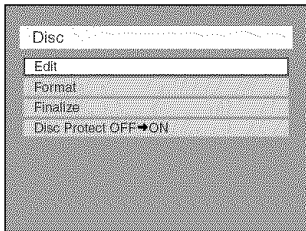

2

Select “**Edit**” using **▲/▼** buttons, then press **ENTER** button.

Original/PlayList menu will appear.
Screen:

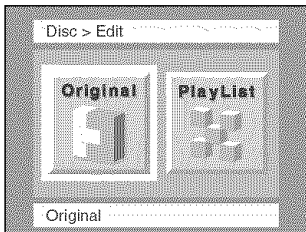

3

Select “**PlayList**” using **◀/▶** buttons, then press **ENTER** button.

Playlist will appear.

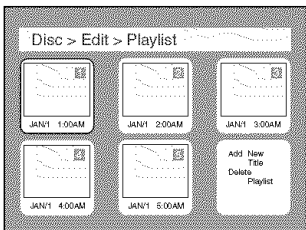

4

Select a desired title using **▲/▼/◀/▶** buttons, then press **ENTER** button.

Playlist menu will appear.

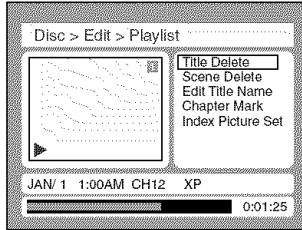

5

Select “**Title Delete**” using **▲/▼** buttons, then press **ENTER** button.

Option window will appear.

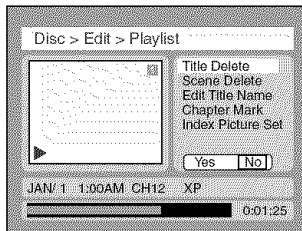

6

Select “**Yes**” using **◀/▶** buttons, then press **ENTER** button.
Title will be deleted.

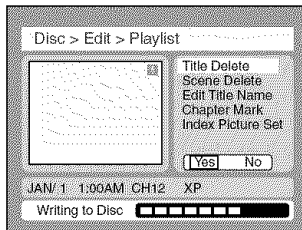

This operation may take a while to be completed.

7

After writing to disc is completed, press **SETUP** button to exit DISC menu.

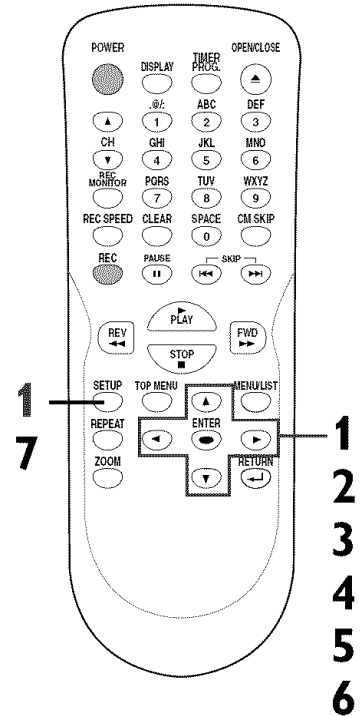

Editing DVD-RW discs in VR mode (Playlist) (cont'd)

Deleting parts of titles



You can delete a specific part of a title.

Even when a title is deleted from the playlist, the original title will remain.

The disc space to record will not be increased.

1

Press **SETUP** button. Select “**DISC**” using **◀ / ▶** buttons, then press **ENTER** button. DISC menu will appear.

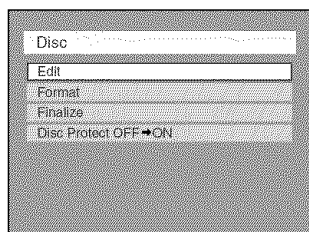

2

Select “**Edit**” using **▲ / ▼** buttons, then press **ENTER** button. Original/PlayList menu will appear. Screen:

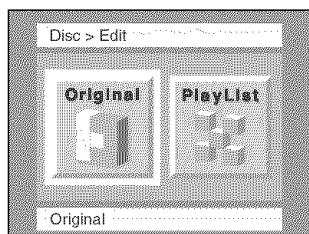

3

Select “**PlayList**” using **◀ / ▶** buttons, then press **ENTER** button. Playlist will appear.

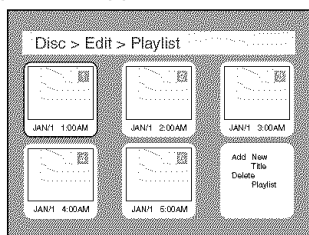

4

Select a desired title using **▲ / ▼ / ◀ / ▶** buttons, then press **ENTER** button. Playlist menu will appear.

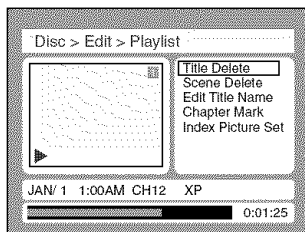

5

Select “**Scene Delete**” using **▲ / ▼** buttons, then press **ENTER** button. Option window will appear.

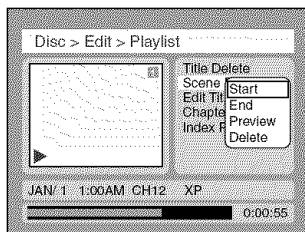

6

Press **ENTER** button to decide a start point, then press **ENTER** button to decide an end point. A cursor will move to “**Preview**”. You can check a preview.

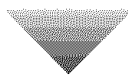

<Preview>

Start point End point

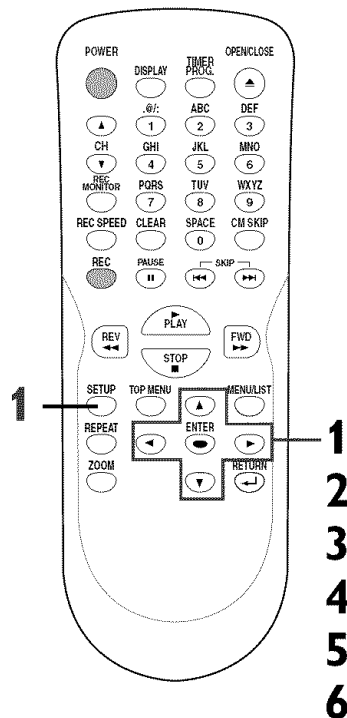
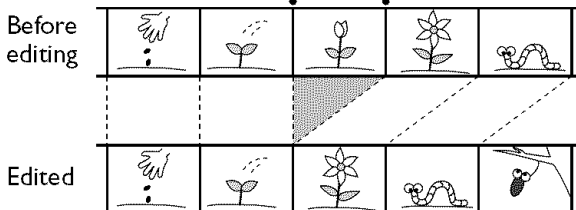

Before you start

Conventions

Getting started

Recording

Playing discs

Editing

Changing the SETUP menu

Others

Spanish

Editing DVD-RW discs in VR mode (Playlist) (cont'd)

7

Select "Delete" using ▲ / ▼ buttons, then press ENTER button.

Option window will appear.

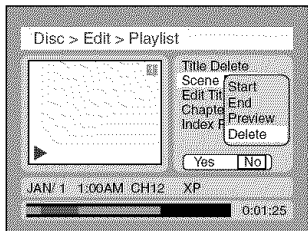

Part of a title will be deleted.

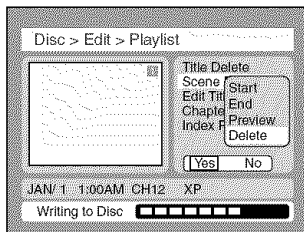

This operation may take a while to be completed.

8

Select "Yes" using ◀ / ▶ buttons, then press ENTER button.

Putting names on titles



You can put names on the titles and change the names from this menu.

The names you put on the titles will be displayed on a titlelist.

1

Press SETUP button. Select "DISC" using ◀ / ▶ buttons, then press ENTER button. DISC menu will appear.

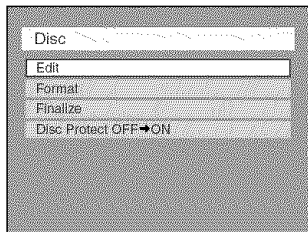

2

Select "Edit" using ▲ / ▼ buttons, then press ENTER button.

Original/PlayList menu will appear.

Screen:

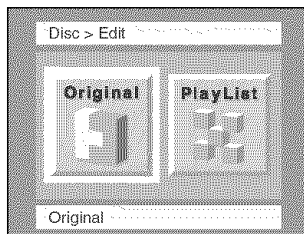

3

Select "PlayList" using ◀ / ▶ buttons, then press ENTER button.

Playlist will appear.

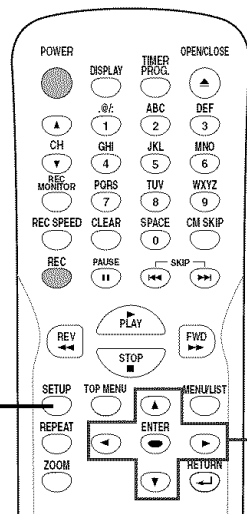
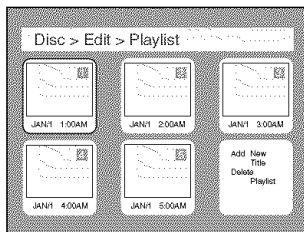

Note

- You cannot select "Scene Delete" when the number of chapter markers in the original or playlist is more than 900.

1

1
2
3

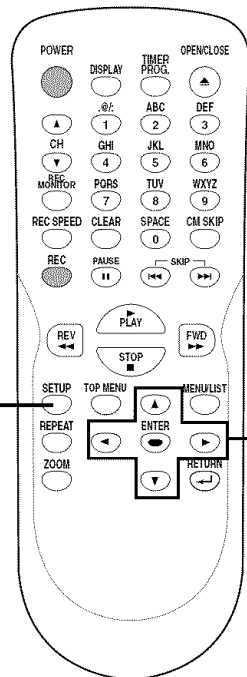

4

Select a desired title using ▲ / ▼ / ◀ / ▶ buttons, then press **ENTER** button.

Playlist menu will appear.

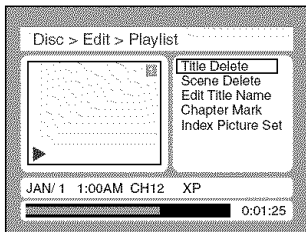

7

Select "Yes" using ◀ / ▶ buttons, then press **ENTER** button.

The name you entered will be activated for the title.

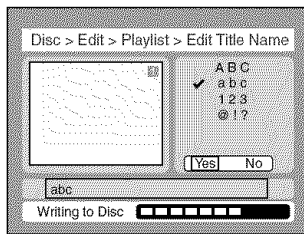

This operation may take a while to be completed.

5

Select "Edit Title Name" using ▲ / ▼ buttons, then press **ENTER** button.

A window for entering a title name will appear.

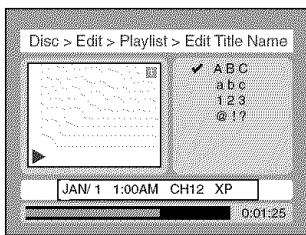

6

To enter a title name, follow the steps of "Guide to edit title name" on this page.

character set

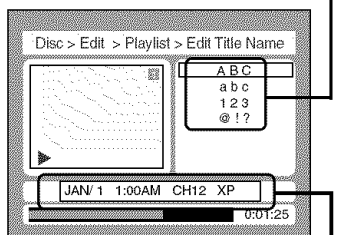

area for entering title names

When you finish entering a title name, press **ENTER** button.

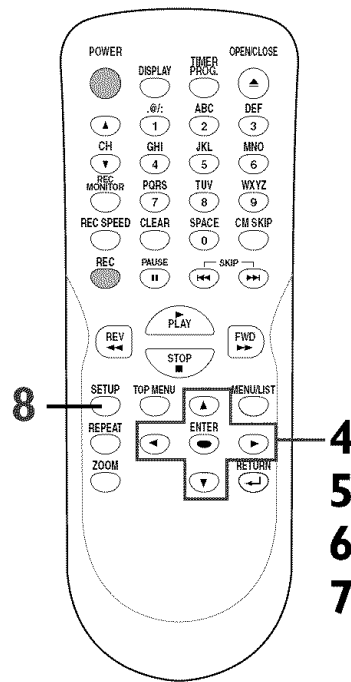

8

After writing to disc is completed, press **SETUP** to exit **DISC** menu.

[Guide to edit title name]

[Step1]: Select a desired character set using ▲ / ▼ buttons, then press **ENTER** button.

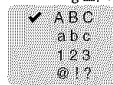

[Step2]: Press Number buttons following by the list below.

Select	ABC	abc	123	@!?
0	<space>	<space>	0	<space>
1	-	-		" # \$ % & ' () * + , - . / : ; < = > ? @ [] ^ _ { } !
2	ABC	abc	2	-
3	DEF	def	3	-
4	GHI	ghi	4	-
5	JKL	jkl	5	-
6	MNO	mno	6	-
7	PQRS	pqrs	7	-
8	TUV	tuv	8	-
9	WXYZ	wxyz	9	-

* Press 1 button, character set will be changed to the "@!?" mode automatically.

- To delete letters, press **CLEAR** button repeatedly. Holding **CLEAR** button to delete all letters.
- To go on to the next entering area for letters, press ▶ button.
- You can enter up to 30 letters.

Editing DVD-RW discs in VR mode (Playlist) (cont'd)

Setting or clearing chapter markers



You can put chapter markers in each title. Once a chapter is marked, you can use it for the chapter search feature.

You can put a chapter marker anywhere you want.

When the number of chapter markers in the playlist comes to 999 in total, you cannot add any more chapter markers.

1

Press **SETUP** button. Select **"DISC"** using **◀ / ▶** buttons, then press **ENTER** button. DISC menu will appear.

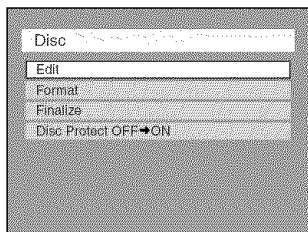

2

Select **"Edit"** using **▲ / ▼** buttons, then press **ENTER** button.

Original/PlayList menu will appear.
Screen:

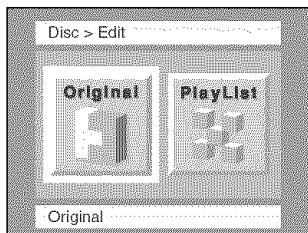

3

Select **"PlayList"** using **◀ / ▶** buttons, then press **ENTER** button.

Playlist will appear.

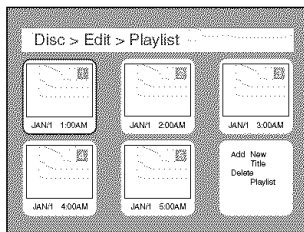

4

Select a desired title using **▲ / ▼ / ◀ / ▶** buttons, then press **ENTER** button.

Playlist menu will appear.

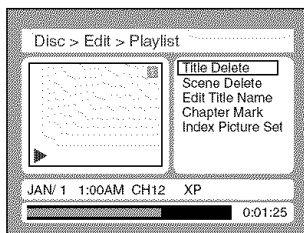

5

Select **"Chapter Mark"** using **▲ / ▼** buttons, then press **ENTER** button.

Option window will appear.

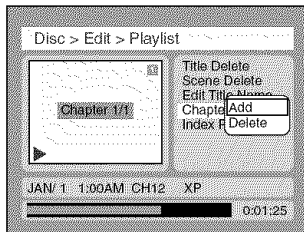

6

Select **"Add"** or **"Delete"** using **▲ / ▼** buttons, then press **ENTER** button.

Option window will appear.

<Add>:

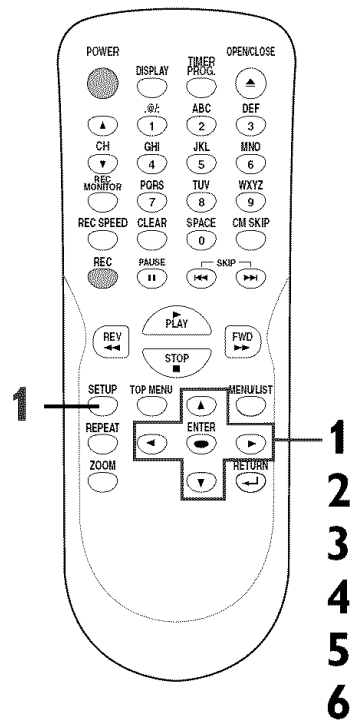
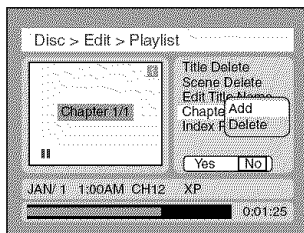

Editing DVD-RW discs in VR mode (Playlist) (cont'd)

<Delete>:



- You cannot delete the first chapter of each title.

7

Select "Yes" using ◀ / ▶ buttons, then press ENTER button. A chapter marker will be added.

<Add>:

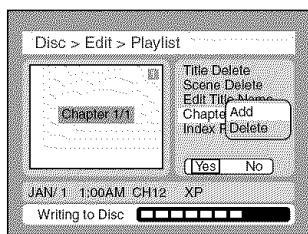

This operation may take a while to be completed.

The chapter marker which you selected will be deleted.

<Delete>:

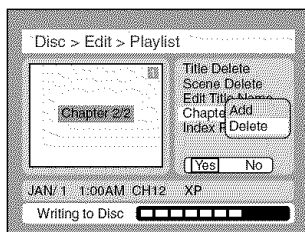

This operation may take a while to be completed.

8

After writing to disc is completed, press SETUP button to exit DISC menu.

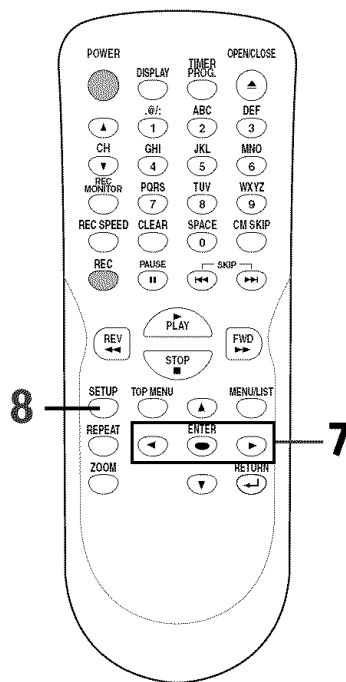

Setting pictures for thumbnails



You can set a picture to each title for a thumbnail. It helps you to remember the contents of the title you are playing. The beginning picture has been selected as the default.

1

Press SETUP button. Select "DISC" using ◀ / ▶ buttons, then press ENTER button. DISC menu will appear.

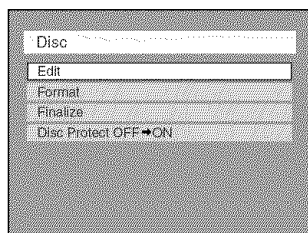

2

Select "Edit" using ▲ / ▼ buttons, then press ENTER button.

Original/PlayList menu will appear.

Screen:

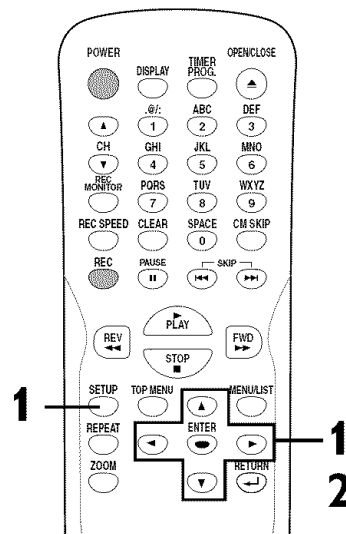
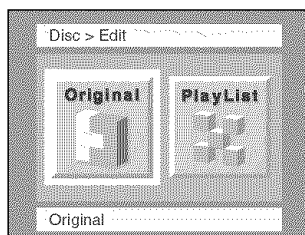

Note

- If a selected picture for a thumbnail is deleted by deleting a part of a title, a default picture will be selected.

Editing

Editing DVD-RW discs in VR mode (Playlist) (cont'd)

3

Select "PlayList" using ◀/▶ buttons, then press ENTER button.

Playlist will appear.

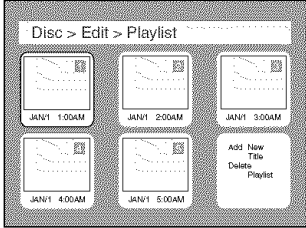

6

Select "Yes" using ◀/▶ buttons, then press ENTER button.

A picture for thumbnail will be set.

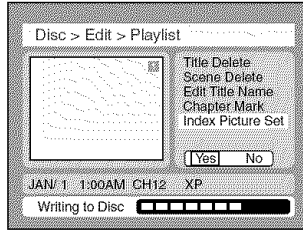

This operation may take a while to be completed.

4

Select a desired title using ▲/▼/◀/▶ buttons, then press ENTER button.

Playlist menu will appear.

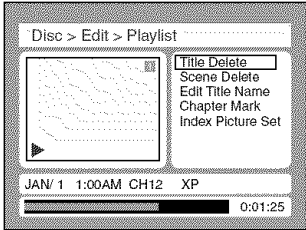

5

Select "Index Picture Set" using ▲/▼ buttons, then press ENTER button.

Option window will appear.

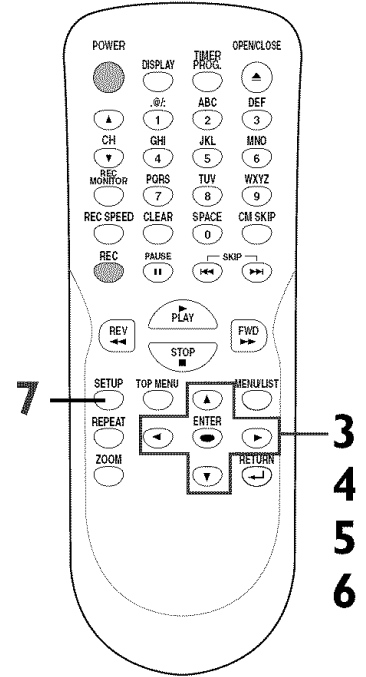
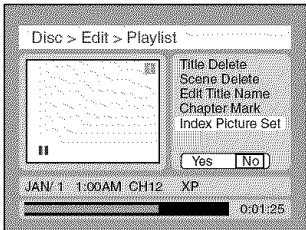

3
4
5
6

7

After writing to disc is completed, press SETUP button to exit DISC menu.

Editing DVD-RW discs in VR mode (Playlist) (cont'd)

Adding titles to a Playlist



You can add or delete a title in the playlist as you prefer. You can add titles to a Playlist up to 99.

1

Press **SETUP** button. Select **"DISC"** using **◀/▶** buttons, then press **ENTER** button. DISC menu will appear.

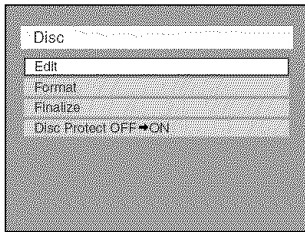

2

Select **"Edit"** using **▲/▼** buttons, then press **ENTER** button. Original/PlayList menu will appear. Screen:

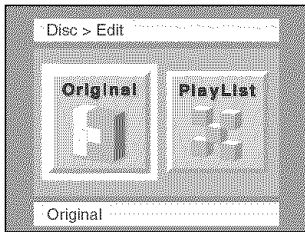

3

Select **"PlayList"** using **◀/▶** buttons, then press **ENTER** button. Playlist will appear.

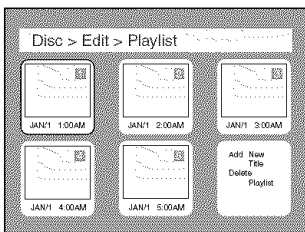

4

Select **"Add New Title"** using **▲/▼/◀/▶** buttons, then press **ENTER** button. Original list will appear.

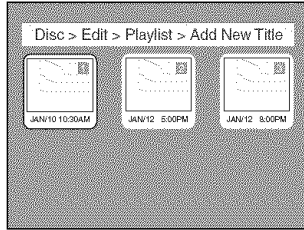

5

Select a desired title using **▲/▼/◀/▶** buttons, then press **ENTER** button.

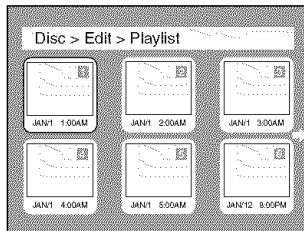
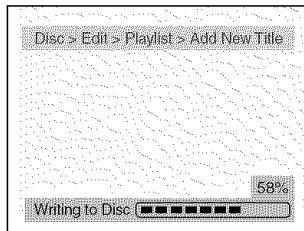

6

After writing to disc is completed, press **SETUP** button to exit DISC menu.

To delete a title from Playlist, refer to "Deleting titles" on page 72.

To delete a Playlist, refer to "Deleting a Playlist" on page 80.

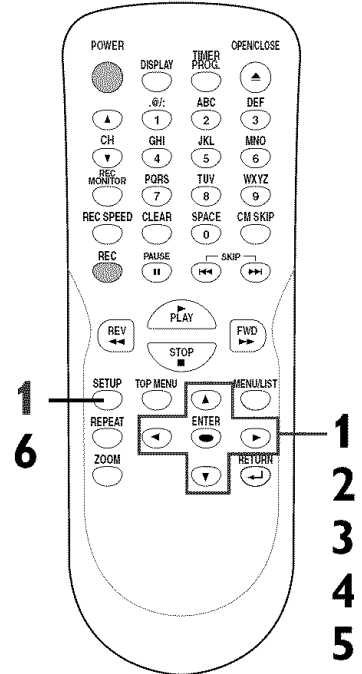

Before you start | Connections | Getting started | Recording | Playing discs | Editing | Changing the SETUP menu | Others | Español

Editing DVD-RW discs in VR mode (Playlist) (cont'd)

Deleting a Playlist



A Playlist can be deleted if no longer needed.

1

Press **SETUP** button. Select **"DISC"** using **◀/▶** buttons, then press **ENTER** button. DISC menu will appear.

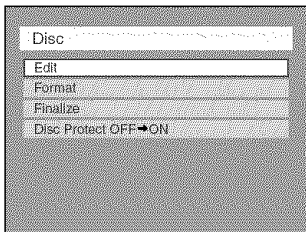

2

Select **"Edit"** using **▲/▼** buttons, then press **ENTER** button. Original/PlayList menu will appear. Screen:

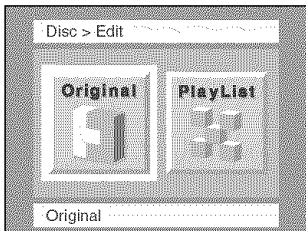

3

Select **"PlayList"** using **◀/▶** buttons, then press **ENTER** button. Playlist will appear.

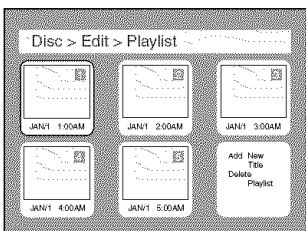

4

Select **"Delete Playlist"** using **▲/▼/◀/▶** buttons, then press **ENTER** button. Option window will appear.

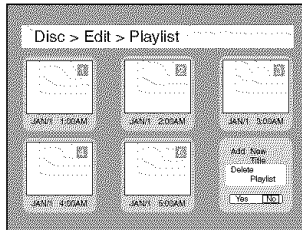

5

Select **"Yes"** using **◀/▶** buttons, then press **ENTER** button. A Playlist will be erased.

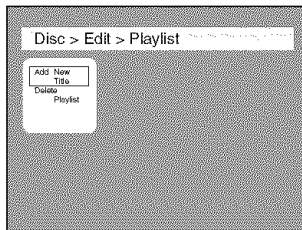

6

After writing to disc is completed, press **SETUP** button to exit DISC menu.

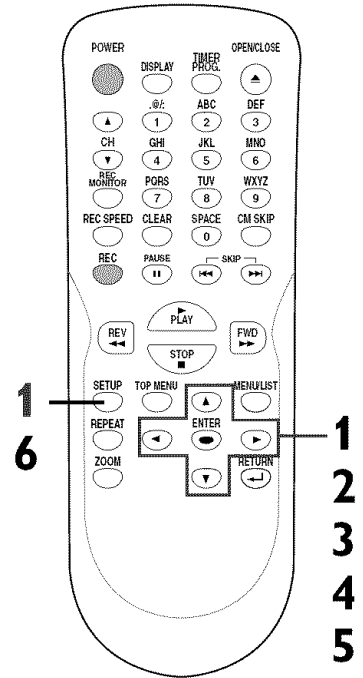

Note

- Deleting a Playlist will not increase the available recording time.

Editing DVD-R discs

Deleting titles



You can delete titles which you do not need, however the disc space to record will not be changed.

Be sure to know that the titles once deleted cannot be brought back to the disc.

1
Press **SETUP** button. Select **"DISC"** using **◀ / ▶** buttons, then press **ENTER** button. DISC menu will appear.

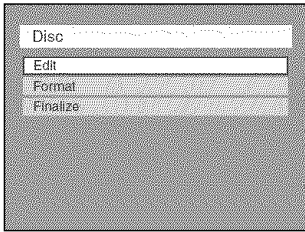

2
Select **"Edit"** using **▲ / ▼** buttons, then press **ENTER** button. Titlelist will appear.
Screen:

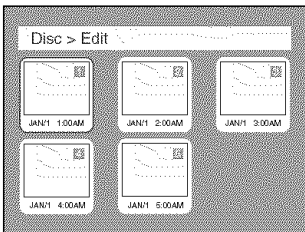

3
Select a desired title using **▲ / ▼ / ◀ / ▶** buttons, then press **ENTER** button. Edit menu will appear.

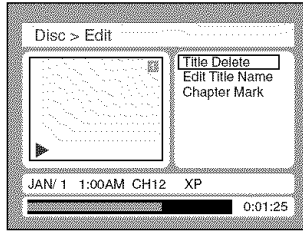

You cannot select "Chapter Mark".

4
Select **"Title Delete"** using **▲ / ▼** buttons, then press **ENTER** button. Option window will appear.

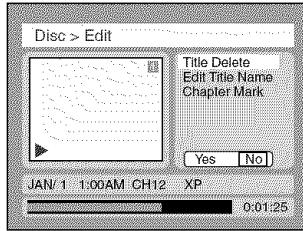

5
Select **"Yes"** using **◀ / ▶** buttons, then press **ENTER** button. Title will be deleted.

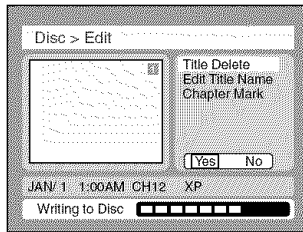

This operation may take a while to be completed.

6
After writing to disc is completed, press **SETUP** button to exit DISC menu.

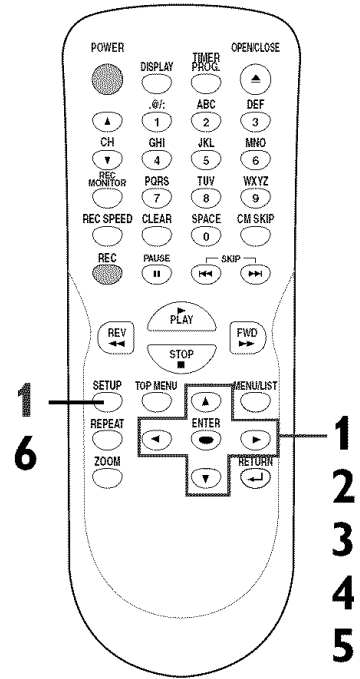

Before you start | Conventions | Getting started | Recording | Playing discs | Editing | Changing the SETUP menu | Others | Español

Editing DVD-R discs (cont'd)

Putting names on titles



You can put names on the titles and change the names from this menu.

The names you put on the titles will be displayed on a titelist.

1
Press **SETUP** button. Select "DISC" using **◀/▶** buttons, then press **ENTER** button. DISC menu will appear.

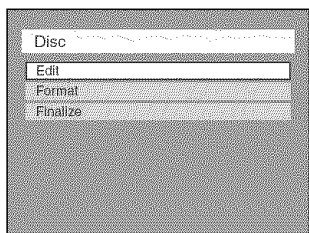

2
Select "Edit" using **▲/▼** buttons, then press **ENTER** button. Titelist will appear.

Screen:

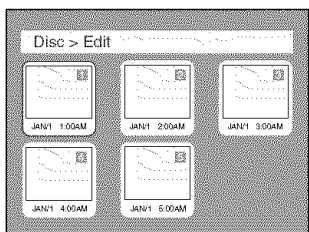

3
Select a desired title using **▲/▼/◀/▶** buttons, then press **ENTER** button. Edit menu will appear.

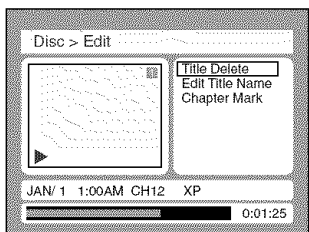

You cannot select "Chapter Mark".

4
Select "Edit Title Name" using **▲/▼** buttons, then press **ENTER** button. A window for entering a title name will appear.

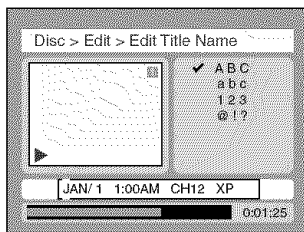

5
To enter a title name, follow the steps of "Guide to edit title name" on this page.

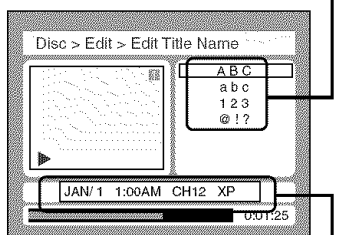

area for entering title names
When you finish entering a title name, press **ENTER** button.

6
Select "Yes" using **◀/▶** buttons, then press **ENTER** button.

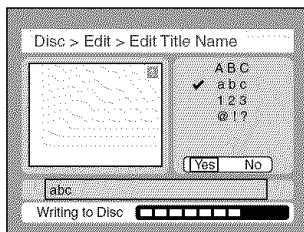

This operation may take a while to be completed.

7
After writing to disc is completed, press **SETUP** button to exit DISC menu.

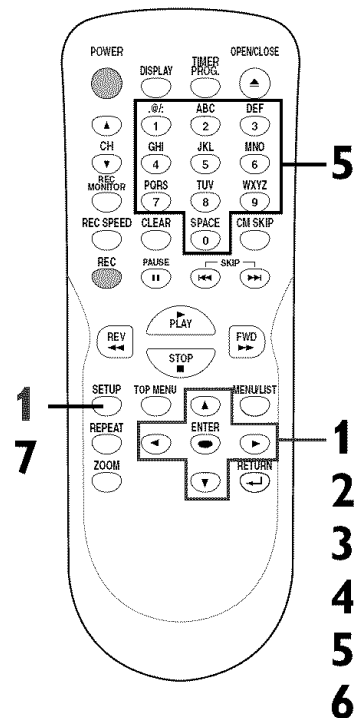

[Guide to edit title name]

[Step1]: Select a desired character set using **▲/▼** buttons, then press **ENTER** button.

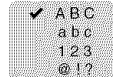

[Step2]: Press Number buttons following by the list below.

Select	ABC	abc	123	@!?
0	<space>	<space>	0	<space>
1	"#\$%&'()*+,-./:; @ [] ^ _ { } !			
2	ABC	abc	2	-
3	DEF	def	3	-
4	GHI	ghi	4	-
5	JKL	jkl	5	-
6	MNO	mno	6	-
7	PQRS	pqrs	7	-
8	TUV	tuv	8	-
9	WXYZ	wxyz	9	-

* Press **1** button, character set will be changed to the " @!?" mode automatically.

- To delete letters, press **CLEAR** button repeatedly. Holding **CLEAR** button to delete all letters.
- To go on to the next entering area for letters, press **▶** button.
- You can enter up to 30 letters.

Changing the SETUP menu

Tour of the SETUP menu

The following table is the contents which you can set and the default settings. Refer to the following table for useful operation.

SETUP menu	Items (highlight is the default)	Contents	
1. Language setting ➡ Pages 84-85	Disc Menu Language	English French Spanish ⋮	Set the language for disc menu.
	Audio Language	Original English French ⋮	Set the language for audio.
	Subtitle Language	OFF English French ⋮	Set the language for subtitle.
2. Display setting ➡ Pages 86-87	OSD Background Transparency	100% ⋮ 35% 25% ⋮	Set the background transparency of OSD screen.
	OSD Background Color	1 2 3	Set the OSD screen color. 1 (Green), 2 (Blue), 3 (Red)
	OSD Language	English Français Español	Set the language for OSD (On Screen Display).
	FL Dimmer	Auto Bright Dark	Set the brightness of front display.
	Screen Saver	OFF 5 minutes 10minutes ⋮	Set the time to work the screen saver on the screen.
3. Audio setting ➡ Pages 88-89	Digital Out	PCM Auto 48kHz 96kHz	Set whether the sound recorded in 96kHz will be down sampled in 48kHz.
		Dolby Digital PCM Stream	Set the type of sound signal which outputs from the digital audio output jack.
	Dynamic Range Control	ON OFF	Compressing the range of sound volume.
	Fast Forward with Audio	ON OFF	Outputting the sound during play in fast forward.
4. Parental setting ➡ Pages 90-91	Parental Lock	ALL level 8 to 1	Set the parental level of your DVD discs.
	(Change password)	Enter the current four-digit password	Set and change the password.

Note

- If you change the setting in SETUP menu, the information of contents stays on even when the power is switched off.

Changing the SETUP menu

Settings for Language

Press STOP button if you are playing a disc.

1

Press **SETUP** button to display **SETUP/DISC** menu. **SETUP/DISC** menu will appear.

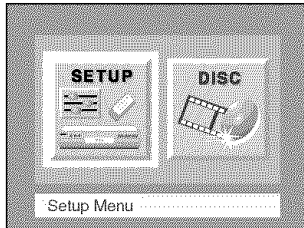

2

Select "**SETUP**" using **◀/▶** buttons, then press **ENTER** button. **SETUP** menu will appear.

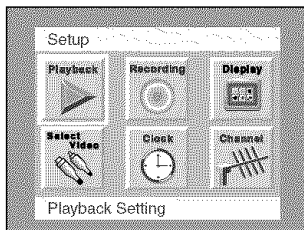

3

Select "**Playback**" using **▲/▼/◀/▶** buttons, then press **ENTER** button. Option window will appear.

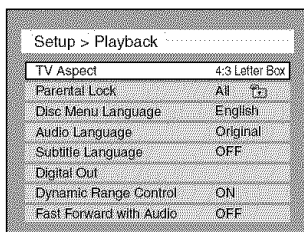

4

Select a desired item using **▲/▼** buttons, then press **ENTER** button.

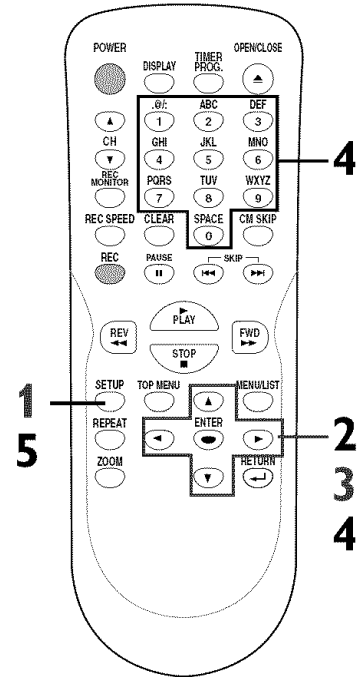

Note

- Only the languages supported by the disc can be selected.
- Audio Language setting may not be available to some discs.
- You can change or switch off the subtitles on a DVD disc also from the disc menu if it is available.

Changing the SETUP menu

Settings for Language (cont'd)

Disc Menu Language (Default : English)

Set the language for Disc Menu.

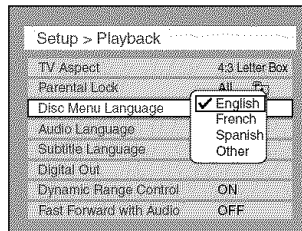
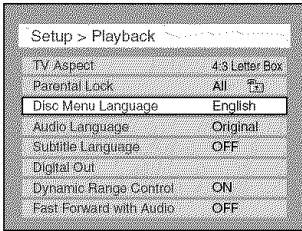

- Select a setting using ▲ / ▼ buttons, then press ENTER button.

Your setting will be activated.

Audio Language (Default : Original)

Set the Audio language.

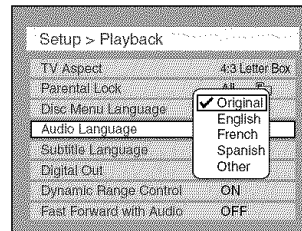
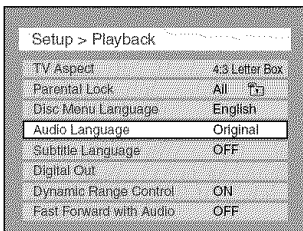

- Select a setting using ▲ / ▼ buttons, then press ENTER button.

Your setting will be activated.

Subtitle Language (Default : OFF)

Set the subtitle language.

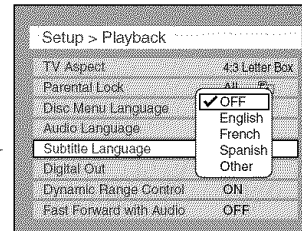
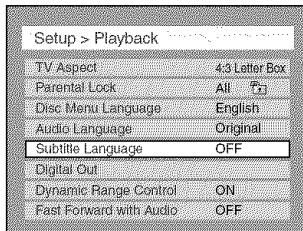

- Select a setting using ▲ / ▼ buttons, then press ENTER button.

Your setting will be activated.

If "Other" is selected, press 4-digit code using number buttons.

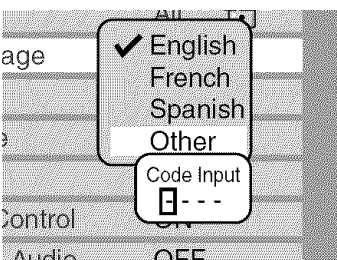

- When you finish entering the code, press ENTER button. Refer to the language code table on page 95.

5

Press SETUP button to exit SETUP menu.

Changing the SETUP menu

Settings for Display

Press STOP button if you are playing a disc.

1

Press **SETUP** button to display **SETUP/DISC** menu. **SETUP/DISC** menu will appear.

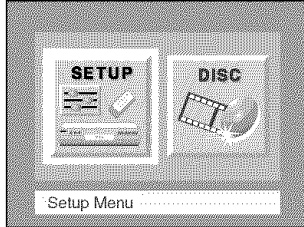

2

Select "**SETUP**" using **◀ / ▶** buttons, then press **ENTER** button. **SETUP** menu will appear.

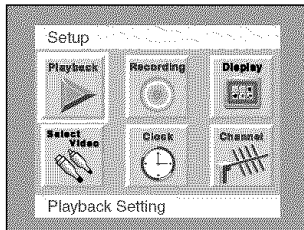

3

Select "**Display**" using **▲ / ▼ / ◀ / ▶** buttons, then press **ENTER** button. Option window will appear.

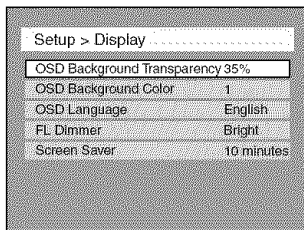

4

Select a desired item using **▲ / ▼** buttons, then press **ENTER** button.

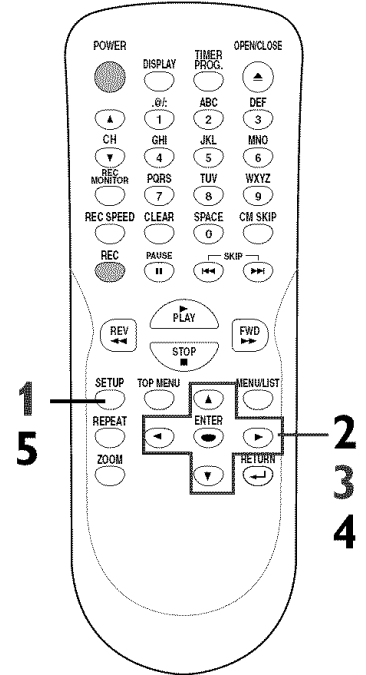

Changing the SETUP menu

Settings for Display (cont'd)

OSD Background Transparency (Default : 35%)

Set the background transparency of OSD screen.
You can choose one among 0% through 100%.

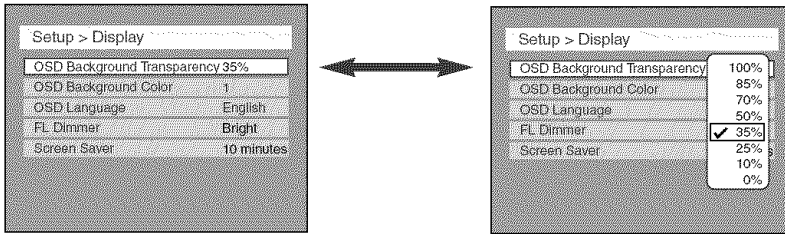

- Select a setting using ▲ / ▼ buttons, then press ENTER button.
Your setting will be activated.

OSD Background Color (Default : 1 Green)

Set the OSD screen color.
You can choose one among 1(Green), 2(Blue), and 3(Red).

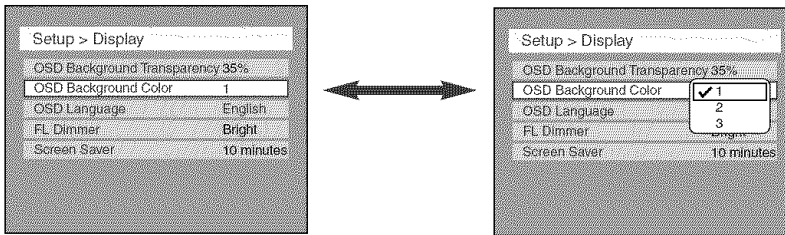

- Select a setting using ▲ / ▼ buttons, then press ENTER button.
Your setting will be activated.

OSD Language (Default : English)

Set the language for OSD.

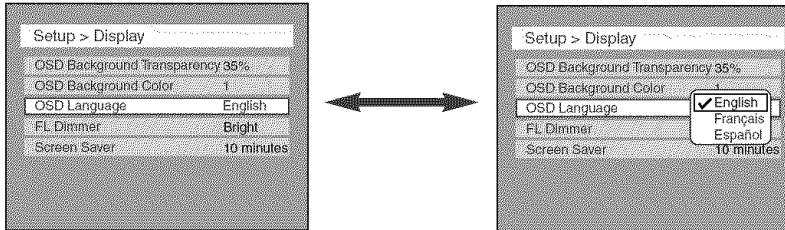

- Select a setting using ▲ / ▼ buttons, then press ENTER button.
Your setting will be activated.

FL Dimmer (Default : Bright)

Set the brightness of front display.
You can choose one among "Auto", "Bright" and "Dark".
When "Auto" is selected, the display dims after 15 seconds of no use.

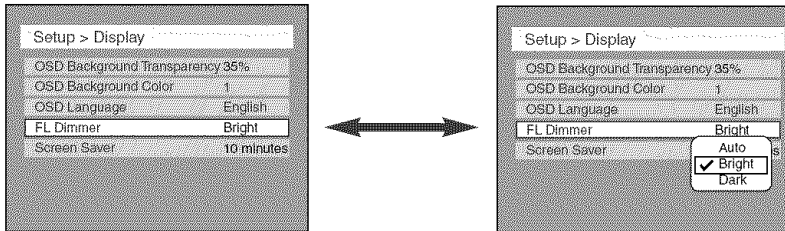

- Select a setting using ▲ / ▼ buttons, then press ENTER button.
Your setting will be activated.

Screen Saver (Default : 10 minutes)

Set the time to work the screen saver function on the screen.

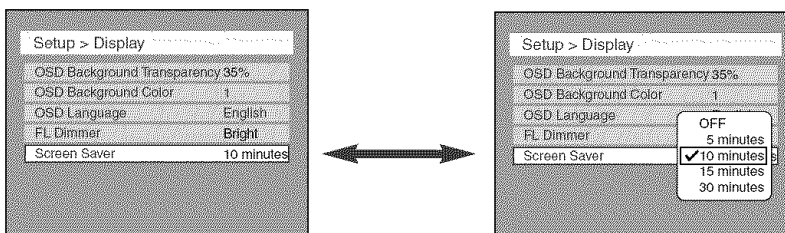

- Select a setting using ▲ / ▼ buttons, then press ENTER button.
Your setting will be activated.

Changing the SETUP menu

Settings for Audio

Choose the appropriate Audio settings for your equipment as it will only affect DVD discs during playback.

Press STOP button if you are playing a disc.

1

Press **SETUP** button to display **SETUP/DISC** menu. SETUP/DISC menu will appear.

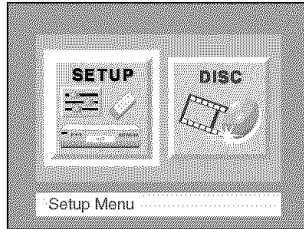

2

Select "**SETUP**" using **◀ / ▶** buttons, then press **ENTER** button. SETUP menu will appear.

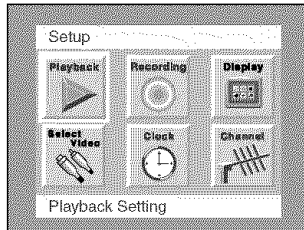

3

Select "**Playback**" using **▲ / ▼ / ◀ / ▶** buttons, then press **ENTER** button. Option window will appear.

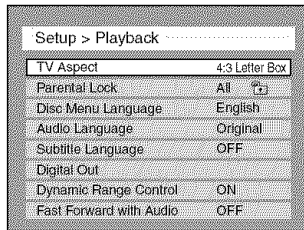

4

Select a desired item using **▲ / ▼** buttons, then press **ENTER** button.

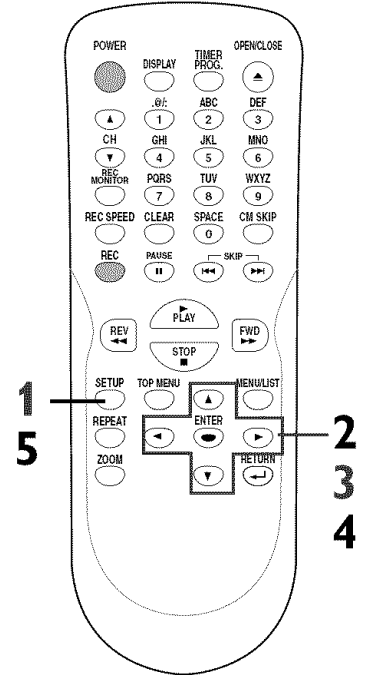

Note

- Dynamic Range Control function is available only on the discs which are recorded in the Dolby Digital format.

Changing the SETUP menu

Settings for Audio (cont'd)

Digital Out

Set the digital audio output.

- Select a setting using **▲ / ▼** buttons, then press **ENTER** button. Option window will appear. Proceed to steps A or B.

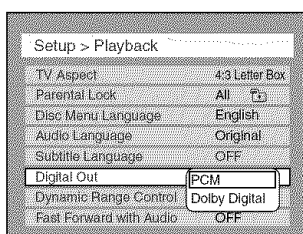
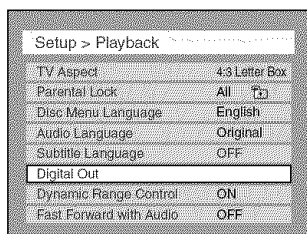

A Settings for Dolby Digital (Default : Stream)

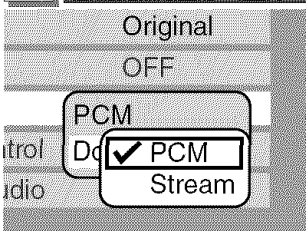

- Select a setting using **▲ / ▼** buttons, then press **ENTER** button. Your setting will be activated.
PCM : Convert the Dolby Digital into PCM(2 channel).
When your amplifier/decoder is NOT compatible with Dolby Digital, set to "PCM".
Stream : Outputs a Dolby Digital signals
When your amplifier/decoder is compatible with Dolby Digital, set to "Stream".

Note
When playing a DVD-RW disc recorded in VR mode

- If the audio source on a disc is Dolby Digital format, set "Dolby Digital" to "PCM" so that you can switch to main (L), sub audio (R), or a mix of both (L/R) with your amplifier/decoder.

B Settings for PCM (Default : Auto)

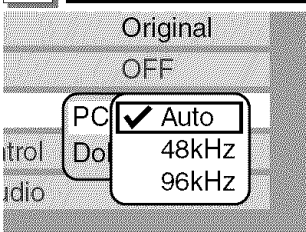

- Select a setting using **▲ / ▼** buttons, then press **ENTER** button. Your setting will be activated.
Auto : Select "Auto" usually.
48kHz : If your amplifier/decoder is NOT compatible with 96kHz PCM, select "48kHz". 96kHz sound will be output in 48kHz.
96kHz : If your amplifier/decoder is compatible with 96kHz PCM, select "96kHz". 96kHz sound will be output.

Note
When playing disc with copy-right protection

- If you select "Auto", the sound will be down sampled at 48kHz.
- If you select "96kHz", no digital sound will be output. Select "Auto", so that outputting 48kHz digital sound.

Dynamic Range Control (Default : ON)

Set to ON to compress the range between soft and loud sounds.

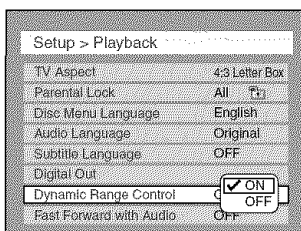
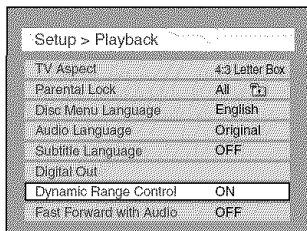

- Select a setting using **▲ / ▼** buttons, then press **ENTER** button. Your setting will be activated.

Fast Forward with Audio (Default : OFF)

Set to ON to output the sound during play in fast forward of x2.

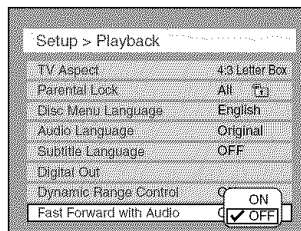
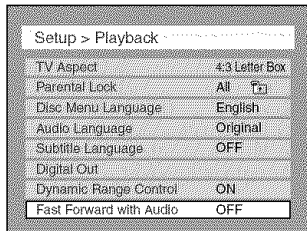

- Select a setting using **▲ / ▼** buttons, then press **ENTER** button. Your setting will be activated.

5

Press **SETUP** button to exit **SETUP** menu.

Changing the SETUP menu

Settings for Parental lock level

Some DVD-Video discs feature a Parental Lock level. Playback will stop if the ratings exceed the levels you set, it will require you to enter a password before the disc will playback. This feature prevents your children from viewing inappropriate material.

Press STOP button if you are playing a disc.

1

Press **SETUP** button to display **SETUP/DISC** menu. **SETUP/DISC** menu will appear.

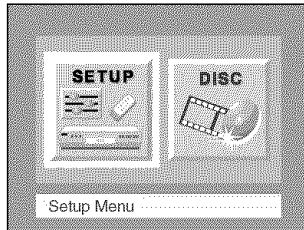

2

Select "**SETUP**" using **◀ / ▶** buttons, then press **ENTER** button.

SETUP menu will appear.

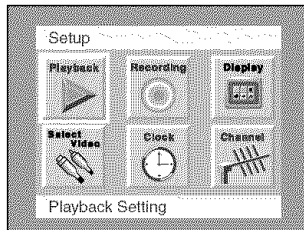

3

Select "**Playback**" using **▲ / ▼ / ◀ / ▶** buttons, then press **ENTER** button.

Option window will appear.

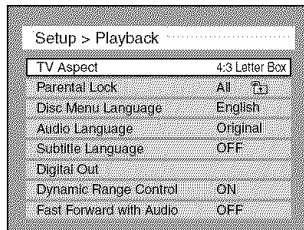

4

Select "**Parental Lock**" using **▲ / ▼** buttons, then press **ENTER** button.

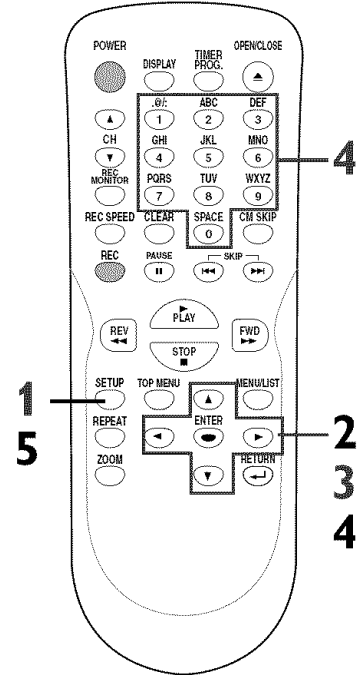

Note

- Parental lock function may not be available to some discs.
- With some DVDs, it may be difficult to find if they are compatible with parental lock. Be sure to check if the parental lock function operates in the way that you have set.
- Record the password in case you forget it.

Changing the SETUP menu

Settings for Parental lock level (cont'd)

Parental Lock (Default :All)

Set the Parental Lock level.

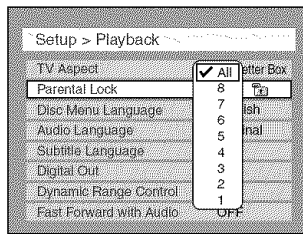
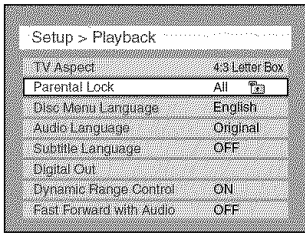

- Change the parental level using ▲ / ▼ buttons, then press ENTER button. Option window will appear. Proceed to steps A or B.

A A password has not been set yet

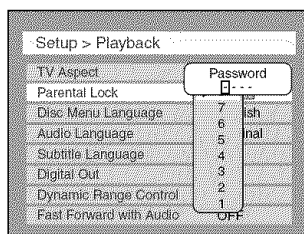
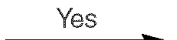
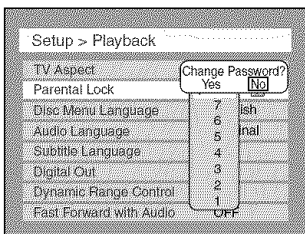

- Select "Yes" using ◀ / ▶ buttons, then enter a new password using Number buttons. Your setting will be activated.

- If you select "No", proceed to Step 5.

B A password has been set already

Change the password

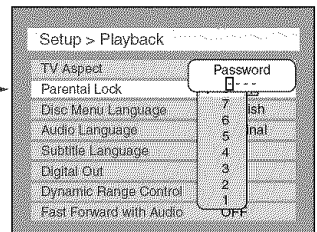
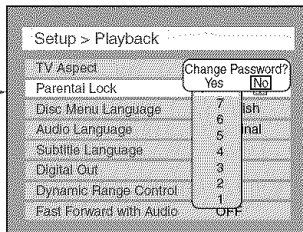
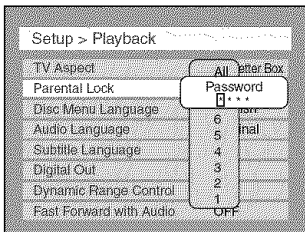

- Enter the current password using Number buttons.

- If you select "No", proceed to Step 5.

- Select "Yes" using ◀ / ▶ buttons, then enter a new password using Number buttons. Your setting will be activated.

5
Press **SETUP** button to exit **SETUP** menu.

Note

- Press CLEAR button to erase numbers entered incorrectly.
- When you forget the password or you want to clear all settings in Parental lock, enter 4,7,3,7 using Number buttons in option window. Password will be cleared and parental levels will be set to All.

Troubleshooting

Before requesting service for this DVD recorder, check the table below for a possible cause of the problem you are experiencing. Some simple checks or a minor adjustment on your part may eliminate the problem and restore proper operation.

Symptom	Remedy
Power	
The power does not turn on.	<ul style="list-style-type: none"> • Check that the AC power cord is connected securely.
Picture	
There is no picture.	<ul style="list-style-type: none"> • Re-connect the connecting cord securely. • The connecting cords are damaged. • The Setup Display appears. Press RETURN ◀ button to turn off the display. • Check the connection to your TV (page 13). • Check if the INTERLACE/PROGRESSIVE mode is set correctly according to your TV. See page 13. • Switch the input selector on your TV (such as to "LINE1") so that the signal from the DVD recorder appears on the TV screen.
Picture noise appears.	<ul style="list-style-type: none"> • The disc is dirty or flawed. • If the picture output signal from the DVD recorder passes through your VCR to get to your TV, or if you are connected to a combination TV/VIDEO player, the copy-protection signal applied to some DVD programs could affect picture quality. If you still experience this problem even when you connect the DVD recorder directly to your TV, try connecting the DVD recorder to your TV's S-VIDEO input.
TV program reception does not fill the screen.	<ul style="list-style-type: none"> • Try to set the channels with "Auto Preset" in SETUP menu (page 18). • Select a channel of any TV program using the CH▲/▼ buttons.
TV program pictures are distorted.	<ul style="list-style-type: none"> • Adjust TV antenna. • Adjust the picture (see the TV's instruction manual). • Place the DVD recorder and TV farther apart. • Place the TV and any bunched antenna cables farther apart.
TV channels cannot be changed.	<ul style="list-style-type: none"> • Switch the input to TV. • Connect the antenna cable correctly (page 13).
The playback picture or TV program from the equipment connected through the DVD recorder is distorted.	<ul style="list-style-type: none"> • If the playback picture output from a DVD player, VCR, or tuner goes through the DVD recorder before reaching your TV, the copy-protection signal applied to some programs could affect picture quality. Disconnect the playback equipment in question and connect it directly to your TV.
Sound	
There is no sound.	<ul style="list-style-type: none"> • The disc is dirty or flawed. • Re-connect all connections securely. • The connecting cord is damaged. • Check the connections to the amplifier input. • The input source setting on the amplifier is incorrect. • The recorder is in pause mode or in Slow-motion Play mode. • The recorder is in fast forward or fast reverse mode. • If the audio signal does not come through the DIGITAL OUT (COAXIAL) jack, check the Audio Setup settings (pages 88-89).
Sound is noisy.	<ul style="list-style-type: none"> • The disc is dirty or flawed. • When playing a DTS-CD, noise may come from the speakers. This DVD recorder is not compatible with DTS-CD.
No DTS sound is output	<ul style="list-style-type: none"> • This DVD recorder is not compatible with DTS sound.

Troubleshooting (cont'd)

Symptom	Remedy
Playback	
The disc does not play.	<ul style="list-style-type: none"> • No disc is inserted. • A blank disc is inserted. • The disc is upside down. Insert the disc with the labeled side facing up. • The disc is not correctly inserted. • The DVD recorder cannot play certain discs (such as a CD-ROM) (page 41). • The region code on the DVD VIDEO does not match the DVD recorder (page 41). • Moisture has condensed inside the DVD recorder. Remove the disc and leave the DVD recorder turned on for about half an hour until the moisture evaporates (page 4). • If the disc was recorded on another recorder, the DVD recorder cannot play the disc if it was not finalized (page 39).
The disc does not start playback from the beginning.	<ul style="list-style-type: none"> • Resume play was activated (page 46). Press STOP ■ button twice. • You have inserted a disc whose Title menu or DVD menu automatically appears on the TV screen when it is first insert.
The DVD recorder starts playing from the disc automatically.	<ul style="list-style-type: none"> • The DVD VIDEO features an auto playback function.
Some functions such as Stop, Search, or Slow-motion Play cannot be performed.	<ul style="list-style-type: none"> • Depending on the disc, you may not be able to do some of the operations above. See the instruction manual supplied with the disc.
The language for the sound track cannot be changed.	<ul style="list-style-type: none"> • Multilingual tracks are not recorded on the DVD VIDEO, DVD-R or DVD-RW being played. • The DVD VIDEO prohibits the changing of the language for the sound track. • Try changing the language using the DVD VIDEO's menu.
The subtitle language cannot be changed or turned off.	<ul style="list-style-type: none"> • Multilingual subtitle are not recorded on the DVD VIDEO. • The DVD VIDEO prohibits changing of the subtitles. • Try changing the subtitle using the DVD VIDEO's menu.
The angles cannot be changed.	<ul style="list-style-type: none"> • Multi-angles are not recorded on the DVD VIDEO being played. • You are trying to change the angles when  icon does not appear on the TV screen (page 56). • The DVD VIDEO prohibits changing angles. • Try changing the angle using the DVD VIDEO's menu.
Recording/Timer recording/Editing	
The channel cannot be changed from the channel you are recording.	<ul style="list-style-type: none"> • Set the TV's input to "TV."
Recording does not start immediately after you press REC button.	<ul style="list-style-type: none"> • An unused DVD-R or DVD-RW was inserted. It takes a while for the DVD recorder to automatically format a DVD-RW.
Nothing was recorded even though you set the timer setting correctly.	<ul style="list-style-type: none"> • There was a power failure during recording. • The DVD recorder's internal clock stopped due to a power failure that lasted for more than 30 seconds. Reset the clock (pages 22-23). • Disconnect the AC power cord from the AC outlet, and connect it again. • The program contains copy protection signals that restricts copying. • The timer setting overlapped with another setting that was set later or has priority.
Recording does not stop immediately after you press STOP ■ button.	<ul style="list-style-type: none"> • It will take a few seconds for the DVD recorder to input disc data before recording can stop.
Timer recording is not complete or did not start from the beginning.	<ul style="list-style-type: none"> • The timer setting overlapped with another setting that was set later or has priority (page 36). • Disc space was not enough.

Troubleshooting (cont'd)

Symptom	Remedy
Remote control The remote does not function.	<ul style="list-style-type: none"> • Batteries are weak. • There are obstacles between the remote and the DVD recorder. • The remote is far from the DVD recorder. • There are no batteries in the remote. • Turn on the DVD recorder. • The remote is not pointed at the remote sensor on the DVD recorder.

Others The DVD recorder does not operate properly.	<ul style="list-style-type: none"> • When static electricity, etc., causes the DVD recorder to operate abnormally, unplug the DVD recorder and then plug it in again.
The disc tray does not open when you press OPEN/CLOSE  button.	<ul style="list-style-type: none"> • It may take a few seconds for the disc tray to open after you have recorded or edited a disc. • This is because the DVD recorder is adding disc data to the disc.

Error message	Cause	Solution
<div style="border: 1px solid black; padding: 2px; text-align: center;">Disc Error</div> — Please eject the disc. — Playback feature may not be available on this Disc.	Unplayable disc is inserted in the DVD recorder.	Insert the standardized disc which bear the marks on page 41.
<div style="border: 1px solid black; padding: 2px; text-align: center;">Region Error</div> — Please eject the disc. — Playback is not authorized in your region.	Playback is not authorized in the region of the DVD-Video disc which you inserted in the DVD recorder.	Insert the DVD-Video disc with region codes 1 or ALL.
<div style="border: 1px solid black; padding: 2px; text-align: center;">Parental Lock On</div> — Please eject the disc. — The current selected parental level Prohibits playback.	The current selected parental level in the SETUP Menu prohibits playback.	Check the "Parental Lock" setting (pages 90-91).
<div style="border: 1px solid black; padding: 2px; text-align: center;">Recording Error</div> This program is not allowed to be recorded.	The recording function encountered the copy prohibited program.	You cannot record copy prohibited programs.
<div style="border: 1px solid black; padding: 2px; text-align: center;">Recording Error</div> This program is not recordable in Video mode.	You are trying to record the copy-once program onto the DVD-RW disc in Video mode.	Set "DVD-RW Recording Format" to "VR mode" (page 28).
<div style="border: 1px solid black; padding: 2px; text-align: center;">Recording Error</div> Can not record on this disc.	You are trying to record onto the disc which is unrecordable, or the disc status is unable to record.	Insert the recordable disc, and ensure the disc status is satisfied with recording (pages 26-40).
<div style="border: 1px solid black; padding: 2px; text-align: center;">Recording Error</div> This program is not allowed to be recorded on this disc.	You are trying to record the copy-once program onto the DVD-RW disc which is not compatible with CPRM.	Insert the DVD-RW disc (ver.1.1 compatible with CPRM).
<div style="border: 1px solid black; padding: 2px; text-align: center;">Recording Error</div> This disc is protected and not recordable.	You are trying to record on to the protected disc which is set in the Disc Setting Menu.	Release the disc protect setting in the Disc Setting menu (page 40).

Others

Language code

Language	Code
(Afan) Oromo	6159
Abkhazian	4748
Afar	4747
Afrikaans	4752
Albanian	6563
Amharic	4759
Arabic	4764
Armenian	5471
Assamese	4765
Aymara	4771
Azerbaijani	4772
Bashkir	4847
Basque	5167
Bengali; Bangla	4860
Bhutani	5072
Bihari	4854
Bislama	4855
Breton	4864
Bulgarian	4853
Burmese	5971
Byelorussian	4851
Cambodian	5759
Catalan	4947
Chinese	7254
Corsican	4961
Croatian	5464
Czech	4965
Danish	5047
Dutch	6058
English	5160
Esperanto	5161
Estonian	5166
Faroese	5261
Fiji	5256
Finnish	5255
French	5264
Frisian	5271
Galician	5358
Georgian	5747
German	5051
Greek	5158
Greenlandic	5758
Guarani	5360
Gujarati	5367
Hausa	5447
Hebrew	5569

Language	Code
Hindi	5455
Hungarian	5467
Icelandic	5565
Indonesian	5560
Interlingua	5547
Interlingue	5551
Inupiak	5557
Irish	5347
Italian	5566
Japanese	5647
Javanese	5669
Kannada	5760
Kashmiri	5765
Kazakh	5757
Kinyarwanda	6469
Kirghiz	5771
Kirundi	6460
Korean	5761
Kurdish	5767
Laothian	5861
Latin	5847
Latvian; Lettish	5868
Lingala	5860
Lithuanian	5866
Macedonian	5957
Malagasy	5953
Malay	5965
Malayalam	5958
Maltese	5966
Maori	5955
Marathi	5964
Moldavian	5961
Mongolian	5960
Nauru	6047
Nepali	6051
Norwegian	6061
Occitan	6149
Oriya	6164
Panjabi	6247
Pashto; Pushto	6265
Persian	5247
Polish	6258
Portuguese	6266
Quechua	6367
Rhaeto-Romance	6459
Romanian	6461

Language	Code
Russian	6467
Samoa	6559
Sangho	6553
Sanskrit	6547
Scots Gaelic	5350
Serbian	6564
Serbo-Croatian	6554
Sesotho	6566
Setswana	6660
Shona	6560
Sindhi	6550
Singhalese	6555
Siswat	6565
Slovak	6557
Slovenian	6558
Somali	6561
Spanish	5165
Sundanese	6567
Swahili	6569
Swedish	6568
Tagalog	6658
Tajik	6653
Tamil	6647
Tatar	6666
Telugu	6651
Thai	6654
Tibetan	4861
Tigrinya	6655
Tonga	6661
Tsonga	6665
Turkish	6664
Turkmen	6657
Twi	6669
Ukrainian	6757
Urdu	6764
Uzbek	6772
Vietnamese	6855
Volapuk	6861
Welsh	4971
Wolof	6961
Xhosa	7054
Yiddish	5655
Yoruba	7161
Zulu	7267

Before you start

Conventions

Getting started

Recording

Playing discs

Editing

Changing the STU menu

Others

Esperanto

Analog audio

An electrical signal that directly represents sound. Compare this to digital audio which can be an electrical signal, but is an indirect representation of sound. See also Digital audio.

Aspect ratio

The width of a TV screen relative to its height. Conventional TVs are 4:3 (in other words, the screen is almost square); widescreen models are 16:9 (the screen is almost twice as wide as it is high).

Chapter

Just as a book is split up into several chapters, a title on a DVD disc is usually divided into chapters. See also Title.

Component video output

Each signal of luminance(Y) and component(Pb/Cb, Pr/Cr) is independent to output so that you can experience picture color as it is. Also, due to compatibility with progressive video (525p/480p), you can experience higher-density picture than that in interlace (525i/480i).

CPRM

(Content Protection for Recordable Media)

CPRM is a copy protection system with scramble system regarding the recording of "copy-once" broadcast programs (e.g. some satellite broadcasts).

Digital audio

An indirect representation of sound by numbers. During recording, the sound is measured at discrete intervals (44, 100 times a second for CD audio) by an analog-to-digital converter, generating a stream of numbers. On playback, a digital-to-analog converter generates an analog signal based on these numbers. See also Sampling frequency and Analog audio.

Dolby Digital

The system to compress digital sound developed by Dolby Laboratories. It offers you sound of stereo(2ch) or multi-channel audio (up to 5.1ch).

MP3 (MPEG Audio Layer 3)

MP3 is a method of compressing files. You can copy MP3 files on CD-R/RW discs from the computer and play the files on this unit.

Finalize

To make DVD discs, which have been recorded on, possible to play in DVD players. With this DVD recorder, it is possible to finalize DVD-R/DVD-RW discs.

PCM

(Pulse Code Modulation)

The most common system of encoding digital audio, found on CDs and DAT. Excellent quality, but requires a lot of data compared to formats such as Dolby Digital and MPEG audio. For compatibility with digital audio recorders (CD, MD and DAT) and AV amplifiers with digital inputs, this unit can convert Dolby Digital and MPEG audio to PCM. See also Digital audio.

Playlist

From this list you can play contents of a disc as your desired order or in sequence. Also it is allowed to search a specific scene directly.

Regions code

Regions associate discs and players with particular areas of the world. This unit will only play discs that have compatible region codes. You can find the region code of your unit by looking on the rear panel. Some discs are compatible with more than one region (or all regions).

Sampling frequency

The rate which sound is measured by a specified interval to turn into digital audio data. The numbers of sampling in one second defines as sampling frequency. The higher the rate, the better the sound quality as possible as it is.

SAP

(Secondary Audio Program)

Sub-audio channel which is delivered separately from main-audio channel. This audio channel is used as an alternate in bilingual broadcasting.

S-Video output

It delivers independently each signal of color(C) and luminance(Y) to TV as video signals, so that higher-quality picture will be gained.

Title (DVD only)

A collection of chapters on DVD disc. See also chapter.

Track

Audio CDs use tracks to divide up the content of a disc. The DVD equivalent is called a chapter. See also Chapter.

Specifications

General

System	DVD-Video, DVD-R/RW, Audio CD
Power requirements	AC 120 V, 60 Hz
Power consumption	23 W (standby: 4.0 W)
Weight	6.0 lbs (2.7 kg)
Dimensions (width x height x depth)	17 1/8" x 2 5/8" x 11 3/4" (435 x 66 x 297 mm)
Operating temperature	41F° to 104F° (5°C to 40°C)
Operating humidity	5% to 85% (no condensation)
TV format	NTSC

Recording

Recording format	DVD VideoRecording, DVD-VIDEO
Recordable discs	DVD-ReRecordable, DVD-Recordable

Video recording format

Sampling frequency	13.5MHz
Compression format	MPEG

Audio recording format

Sampling frequency	48kHz
Compression format	Dolby Digital

Tuner

Receivable channels

VHF	2-13ch
UHF	14-69ch
CATV	C1-C125ch

Input/Output

VHF/UHF antenna input/output terminal	VHF/UHF set 75Ω
---------------------------------------	-----------------

Video input

Input level	Input 1 (rear), 2 (front)
Jacks	1 V _{p-p} (75Ω) RCA jack

Video output

Output level	Output 1,2
Jacks	1 V _{p-p} (75Ω) RCA jack

S-Video input

Y (luminance) - Input level	Input 1 (rear), 2 (front)
C (color) - Input level	1 V _{p-p} (75Ω)
Jacks	286 mV _{p-p} (75Ω) 4 pin mini DIN

S-Video output

Y (luminance) - Output level	1 V _{p-p} (75Ω)
C (color) - Output level	286 mV _{p-p} (75Ω)
Jacks	4 pin mini DIN

Component video output

Output level	Y: 1.0V _{p-p} (75Ω), PB/CB, PR/CR: 0.7V _{p-p} (75Ω)
Jacks	RCA jacks

Audio input

During audio input	Input 1 (rear), 2 (front) L/R
Jacks	2V rms (Input impedance: more than 22kΩ) RCA jacks

Audio output

During audio output	Output 1,2 L/R
Jacks	2V rms (Output impedance: less than 1kΩ) RCA jacks

Digital audio output

Output level	500 mV _{p-p} (75Ω)
Jacks	RCA jack

Note:

The specifications and design of this product are subject to change without notice.

Fácil grabación de DVD

Estas instrucciones le ayudarán a entender fácilmente cómo grabar discos DVD.

Nota:

Asegúrese que las pilas están en el mando a distancia y que ha conectado correctamente esta unidad y el TV.

Paso 1: Elija un tipo de disco

Hay varios tipos de discos DVD grabables a su elección. Elija el tipo según "Tipos de disco DVD" en esta página.

Este grabador de DVD puede grabar en los siguientes tipos de disco.



Por ejemplo, cuando desea grabar repetidamente en el mismo disco o cuando desea editar el disco después de grabar, seleccione el disco de tipo regrabable DVD-RW.

Cuando desea guardar grabaciones sin alterarlas, un DVD no regrabable DVD-R puede ser más conveniente.

Paso 2: Coloque un disco en blanco

Mando a distancia

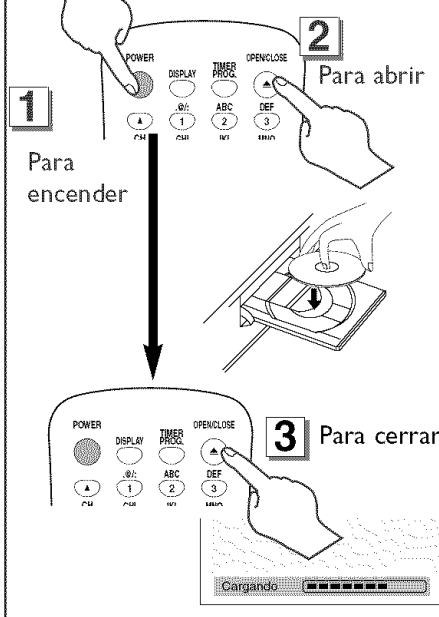

Esta operación puede demorar en reconocerse.

Tipos de disco DVD

☆☆☆ : Más adecuado ☆☆☆ : Puede utilizar ☆ : Algunas funciones son limitadas — : No puede utilizar

Desea	DVD-RW VR	DVD-RW Video	DVD-R
Grabar programas de TV	☆☆☆	☆☆☆	☆☆
Volver a utilizar borrando partes no deseadas	☆☆☆	☆☆	—
Editar las grabaciones	☆☆☆	☆	☆
Editar/grabar de equipos conectados	☆☆☆	☆☆☆	☆☆☆
Copiar discos para distribución	☆☆ ^{*1}	☆☆☆	☆☆☆
Reproducir en otro equipo de DVD	☆☆ ^{*1}	☆☆☆	☆☆☆

Detalles	DVD-RW VR	DVD-RW Video	DVD-R
Grabación			
¿Regrabable?	Sí	Sí	No
Puede crear capítulos a intervalos fijos (auto.)	Sí	Sí	Sí
Puede crear capítulos donde desee (manual)	Sí	No	No
Puede grabar imágenes de tamaño 16:9	Sí	Sí	Sí
Puede grabar un programa de Copia-una-vez	Sí	No	No
Edición			
Puede hacer funciones de edición básica	Sí	Sí	Sí
Puede hacer funciones de edición avanzadas (edición de lista a reproducir)	Sí	No	No

^{*1} El DVD-RW (modo VR) sólo puede reproducirse en equipos de DV compatibles con VR.

Nota:
Para más detalles sobre las funciones anteriores y las limitaciones implícitas, lea las explicaciones en este manual.

Formato del disco

Coloque el disco en el grabador. Haga el formato del disco del menú SETUP, existen los formatos de video (modo de Video) o de grabación de video (modo VR) según el tipo de disco colocado. Esto es necesario para preparar el disco para grabación. Vea los detalles en las páginas 28-30.

Fácil grabación de DVD (cont.)

Paso 3: Seleccione la velocidad de grabación

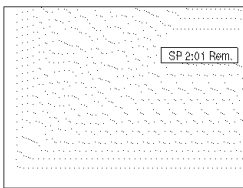
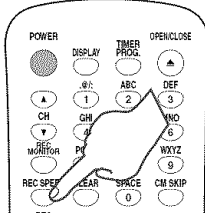

Paso 4: Seleccione el canal deseado

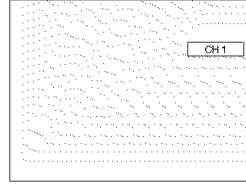
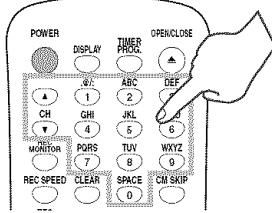

Paso 5: Grabe en discos DVD

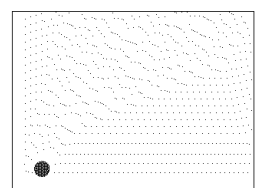
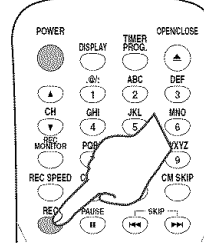

Sugerencia 1: Reproduzca el contenido grabado

Puede seleccionar el título que desea reproducir de un menú indicado y empiece a reproducir inmediatamente. Las grabaciones pueden verse fácilmente en un disco, el procedimiento es simple ya que sólo tiene que elegir el título en un capítulo de la pantalla del menú.

¿Qué son títulos y capítulos?

Las grabaciones del disco DVD se dividen generalmente en títulos. Los títulos pueden subdividirse en capítulos.

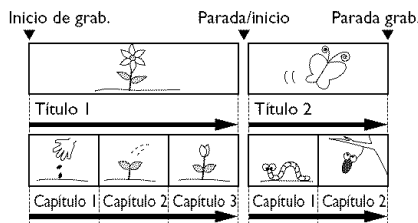

Sugerencia 2: Edite el disco grabado

La edición de discos puede ser muy fácil y el grabador de DVD ofrece convenientes funciones de edición posibles sólo con los discos DVD-R/RW.

Puede editar lo siguiente de la lista de títulos.

- Poniendo nombres en títulos
- Seleccionando imágenes para índices (modo VR)
- Seleccionando/borrando marcadores de capítulos
- Borrando partes de títulos (modo VR)

Original y Playlist (modo VR)

Puede editar las grabaciones en la lista a reproducir sin cambiar las grabaciones originales. Cualquier lista a reproducir no ocupa mucho espacio en el disco.

¿Qué significa "Original" o "Playlist"?

A lo largo de este manual encontrará *Original* y *Playlist* que se refieren a las grabaciones reales y la versión editada.

- La grabación **Original** se refiere a la grabación real en el disco.
- El **Playlist** se refiere a la versión editada del disco; cómo se va a reproducir la versión Original.

Paso 6: Pare la grabación

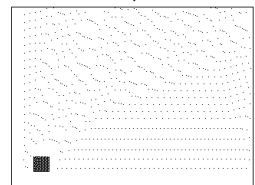
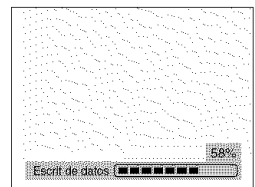
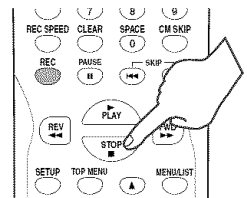

Esta operación puede demorar en completarse.

Before you start
Connections
Getting started
Recording
Playing discs
Editing
Changing setup menu
Others
Español

SYLVANIA

LIMITED WARRANTY

FUNAI CORP. will repair this SYLVANIA product, free of charge in the USA in the event of defect in materials or workmanship as follows:

DURATION:

PARTS: FUNAI CORP. will provide parts to replace defective parts without charge for one (1) year from the date of original retail purchase. Two (2) years for Picture Tube. Certain parts are excluded from this warranty.

LABOR: FUNAI CORP. will provide the labor without charge for a period of ninety (90) days from the date of original retail purchase.

LIMITS AND EXCLUSIONS:

This warranty is extended only to the original retail purchaser. A purchase receipt or other proof of original retail purchase will be required together with the product to obtain service under this warranty.

This warranty shall not be extended to any other person or transferee.

This warranty is void and of no effect if any serial numbers on the product are altered, replaced, defaced, missing or if service was attempted by an unauthorized service center. This SYLVANIA Limited warranty does not apply to any product not purchased and used in the United States.

This product is produced for home use and this warranty only covers failures due to defects in material or workmanship which occurs during normal use. It does not cover damage which occurs in shipment, or failures which are caused by repairs, alterations or product not supplied by FUNAI CORP., or damage which results from accident, misuse, abuse, mishandling, misapplication, alteration, faulty installation, improper maintenance, commercial use such as hotel, rental or office use of this product or damage which results from fire, flood, lightning or other acts of God.

THIS WARRANTY DOES NOT COVER PACKING MATERIALS, ANY ACCESSORIES (EXCEPT REMOTE CONTROL), ANY COSMETIC PARTS, COMPLETE ASSEMBLY PARTS, DEMO OR FLOOR MODELS.

FUNAI CORP. AND ITS REPRESENTATIVES OR AGENTS SHALL IN NO EVENT BE LIABLE FOR ANY GENERAL, INDIRECT OR CONSEQUENTIAL DAMAGES ARISING OUT OF OR OCCASIONED BY THE USE OF OR THE INABILITY TO USE THIS PRODUCT. THIS WARRANTY IS MADE IN LIEU OF ALL OTHER WARRANTIES, EXPRESS OR IMPLIED, AND OF ALL OTHER LIABILITIES ON THE PART OF FUNAI. ALL OTHER WARRANTIES INCLUDING THE WARRANTY OF MERCHANTABILITY, AND FITNESS FOR A PARTICULAR PURPOSE, ARE HEREBY DISCLAIMED BY FUNAI AND ITS REPRESENTATIVES IN THE UNITED STATES. ALL WARRANTY INSPECTIONS AND REPAIRS MUST BE PERFORMED BY A FUNAI AUTHORIZED SERVICE CENTER. THIS WARRANTY IS VALID WHEN THE UNIT IS CARRIED-IN TO FUNAI AUTHORIZED SERVICE FACILITY.

IMPORTANT:

THIS LIMITED WARRANTY GIVES YOU SPECIFIC LEGAL RIGHTS. YOU MAY HAVE OTHER RIGHTS THAT VARY FROM STATE TO STATE, IF, AT ANY TIME DURING THE WARRANTY PERIOD, YOU ARE UNABLE TO OBTAIN SATISFACTION WITH THE REPAIR OF THIS PRODUCT, PLEASE CONTACT FUNAI CORP.

ATTENTION:

FUNAI CORP. RESERVES THE RIGHT TO MODIFY ANY DESIGN OF THIS PRODUCT WITHOUT PRIOR NOTICE.

To locate your nearest SYLVANIA Authorized Service Center or for general service procedure, please call 1-800-968-3429 or write to the following:

**FUNAI CORPORATION, INC.
SERVICE CENTER**

19900 Van Ness Avenue, Torrance, CA 90501

Tel :1-800-968-3429

<http://www.funai-corp.com>

Head Office: 100 North Street, Teterboro, NJ 07608

PLEASE DO NOT SHIP YOUR UNIT TO THE TETERBORO ADDRESS.