

RCA

Television User's Guide

Changing Entertainment. Again.



CAUTION

RISK OF ELECTRIC SHOCK
DO NOT OPEN



This symbol indicates that this product incorporates double insulation between hazardous mains voltage and user accessible parts. When servicing use only identical replacement parts.

Caution: To reduce the risk of electric shock, do not remove cover (or back). No user serviceable parts inside. Refer servicing to qualified service personnel.



This symbol indicates "dangerous voltage" inside the product that presents a risk of electric shock or personal injury.



This symbol indicates important instructions accompanying the product.

WARNING

To reduce the risk of fire or electric shock, do not expose this product to rain or moisture.

The apparatus shall not be exposed to dripping or splashing and no objects filled with liquids, such as vases, should be placed on the apparatus.

Refer to the identification/rating label located on the back panel of your product for its proper operating voltage.

FCC Regulations state that unauthorized changes or modifications to this equipment may void the user's authority to operate it.

Caution: To prevent electric shock, match wide blade of plug to wide slot, fully insert.

Caution: Using video games or any external accessory with fixed images for extended periods of time can cause them to be permanently imprinted on the picture tube (or projection TV picture tubes). ALSO, some network/program logos, phone numbers, black borders (sides, top and bottom), etc. may cause similar damage. This damage is not covered by your warranty.

Cable TV Installer: This reminder is provided to call your attention to Article 820-40 of the National Electrical Code (Section 54 of the Canadian Electrical Code, Part 1) which provides guidelines for proper grounding and, in particular, specifies that the cable ground shall be connected to the grounding system of the building as close to the point of cable entry as practical.

Important Stand and Base Safety Information

Choose the location for your TV carefully. Place the TV on a stand or base that is of adequate size and strength to prevent the TV from being accidentally tipped over, pushed off, or pulled off. This could cause personal injury and/or damage the TV. Refer to the Important Safety Instructions on page 2.

Product Registration

Please fill out the product registration card (packed separately) and return it immediately. For US customers: Your RCA Consumer Electronics product may also be registered at www.rca.com/productregistration. Registering this product allows us to contact you if needed.

Product Information

Keep your sales receipt to obtain warranty parts and service and for proof of purchase. Attach it here and record the serial and model numbers in case you need them. These numbers are located on the product.

Model No. _____ Serial No. _____ Purchase Date: _____

Dealer/Address/Phone: _____

IMPORTANT SAFETY INSTRUCTIONS

Read before operating equipment

1. Read these instructions.
2. Keep these instructions
3. Heed all warnings.
4. Follow all instructions.
5. Do not use this apparatus near water.
6. Clean only with a dry cloth.
7. Do not block any of the ventilation openings. Install in accordance with the manufacturer's instructions.
8. Do not install near any heat sources such as radiators, heat registers, stoves, or other apparatus (including amplifiers) that produce heat.
9. Do not defeat the safety purpose of the polarized or grounding-type plug. A polarized plug has two blades with one wider than the other. A grounding type plug has two blades and a third grounding prong. The wide blade or third prong are provided for your safety. When the provided plug does not fit into your outlet, consult an electrician for replacement of the obsolete outlet.
10. Protect the power cord from being walked on or pinched, particularly at plugs, convenience receptacles, and the point where they exit from the apparatus.
11. Only use attachments/accessories specified by the manufacturer.
12. Use only with a cart, stand, tripod, bracket, or table specified by the manufacturer or sold with the apparatus. When a cart is use caution when moving the cart/apparatus combination to avoid injury from tip-over.
13. Unplug this apparatus during lightning storms or when unused for long periods of time.
14. Refer all servicing to qualified service personnel. Servicing is required when the apparatus has been damaged in any way, such as if the power-supply cord or plug is damaged, liquid has been spilled or objects have fallen into the apparatus, or if the apparatus has been exposed to rain or moisture, does not operate normally, or has been dropped.
15. This product may contain lead and mercury. Disposal of these materials may be regulated due to environmental considerations. For disposal or recycling information, please contact your local authorities or the Electronic Industries Alliance (www.eiae.org).
16. **Damage Requiring Service** - The appliance should be serviced by qualified service personnel when:
 - A. The power supply cord or the plug has been damaged;
 - B. Objects have fallen or liquid has been spilled into the appliance;
 - C. The appliance has been exposed to rain;
 - D. The appliance does not appear to operate normally or exhibits a marked change in performance;
 - E. The appliance has been dropped or the enclosure damaged.
17. **Tilt/Stability** - All televisions must comply with recommended international global safety standards for tilt and stability properties of its cabinet design.
 - Do not compromise these design standards by applying excessive pull force to the front, or top, of the cabinet, which could ultimately overturn the product.
 - Also, do not endanger yourself, or children, by placing electronic equipment/toys on the top of the cabinet. Such items could unsuspectingly fall from the top of the set and cause product damage and/or personal injury.
18. **Wall or Ceiling Mounting** - The appliance should be mounted to a wall or ceiling only as recommended by the manufacturer.
19. **Power Lines** - An outdoor antenna should be located away from power lines.
20. **Outdoor Antenna Grounding** - If an outside antenna is connected to the receiver, be sure the antenna system is grounded so as to provide some protection against voltage surges and built up static charges. Section 810 of the National Electrical Code, ANSI/NFPA No. 70 1984, provides information with respect to proper grounding of the mast and supporting structure, grounding of the lead-in wire to an antenna-discharge unit, size of grounding connectors, location of antenna-discharge unit, connection to grounding electrodes, and requirements for the grounding electrode. See Figure below.
21. **Object and Liquid Entry** - Care should be taken so that objects do not fall and liquids are not spilled into the enclosure through openings.
22. **Battery usage CAUTION** - To prevent battery leakage that may result in bodily injury, property damage, or damage to the unit:
 - Install all batteries correctly, with + and - aligned as marked on the unit.
 - Do not mix batteries (old and new or carbon and alkaline, etc.).
 - Remove batteries when the unit is not used for a long time.
23. Apparatus shall not be exposed to dripping or splashing and no objects filled with liquids, such as vases, shall be placed on the apparatus.

Note to the Cable TV system installer: This reminder is provided to call the Cable TV system installer's attention to Article 820-40 of the NEC that provides guidelines for proper grounding and, in particular, specifies that the cable ground shall be connected to the grounding system of the building, as close to the point of cable entry as practical.

Example of Antenna Grounding as per NEC - National Electrical Code

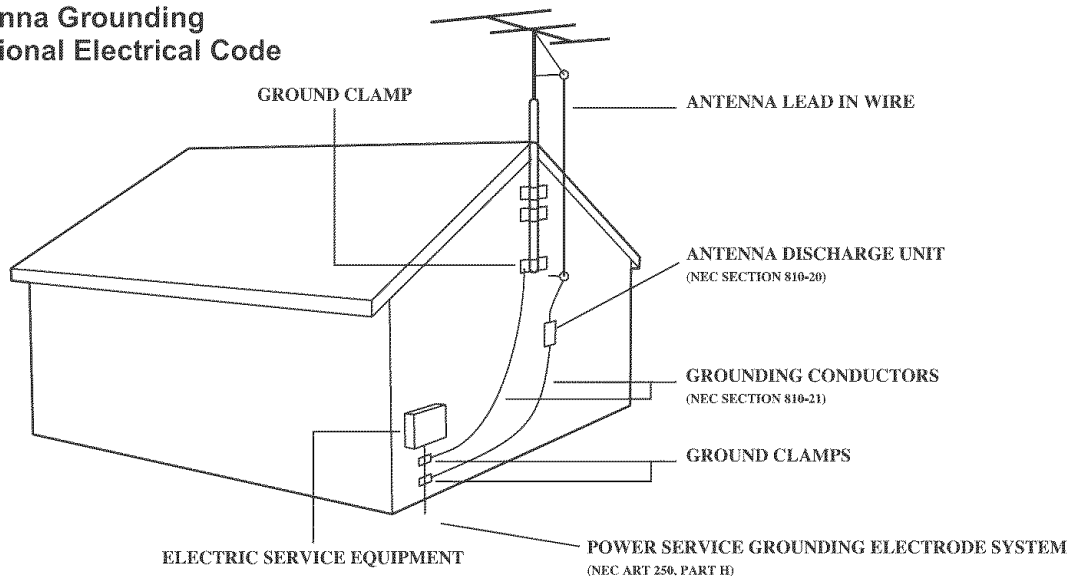

Table of Contents

Introduction

Safety/precaution	2
Table of Contents	3
Features	3

Getting Started

Basic Cable TV connection	4
Basic Antenna Connection	5
Basic TV to VCR Connection	6
Description of Buttons on the TV	7
Remote Control	8-9

Setup Menus

Language	10
TV/Cable TV (CATV)	11
Auto Search (Setting TV Channels)	12
Manual Channel Tuning	13
Favorite Channel Setting	14
Adding or Erasing Channels	15

On-screen Menus

Picture Adjustments	16
Preset Picture Mode	17
Clock	18
On-Timer	19
Off-Timer	20
Closed Caption	21
Sleep Timer	22

Parental Lock

Understanding Parental Lock	23
Changing Your Password	24
Blocking Programming with Movie Ratings	25
Blocking Programming with TV Ratings	26
Parental Lock Blocking Options	27
Child Lock	28

Sound

Sound Mode Selection	29
Sound Adjustments	30
Surround	31
Stereo and Second Audio Program	32

Others

Notebook	33
Calendar	34

<u>Troubleshooting</u>	35
-------------------------------------	----

<u>Care and Cleaning</u>	36
---------------------------------------	----

<u>Limited Warranty</u>	36-37
--------------------------------------	-------

Here are a few of the special features of your new Color Television.

Automatic Channel Programming: Quick and easy selection of available stations.

Child Lock (FPA Lock): Locks the buttons on the front of the TV so it cannot be operated accidentally by young children.

Closed Captioning: Allows you to read TV program dialog or voice conversations as on-screen text.

Off-Timer: Turns off the TV at a preset time.

On-Timer: Turns on the TV at a preset time to a designated TV channel or video source.

On-screen Menus: On-screen text (in English, French, or Spanish) for setting TV controls.

Parental Lock: Allows you to block the viewing of certain TV channels if you do not want your children viewing inappropriate material.

Remote Control: Operates your TV and navigates the menus.

Sleep Timer: Turns off the TV within an amount of time you specify. (10-120 minutes from the current time).

Picture Preset Mode: Lets you set the picture's color, tint, contrast, etc. for various types of programming. Settings include Bright, Normal, Theater, and Personal, which set the picture control as you want.

Sound Mode: (Model 24V511T only) Lets you set the TV's sound settings for the current programming. Choices include Personal, Theatre, Concert, or Speech.

Standard broadcast (VHF/UHF) or Cable TV channel capability.

Stereo Capability: (Model 24V511T only) Includes built-in amplifier and twin-speaker system; allows reception of TV programs broadcast in stereo.

Basic Cable TV Connection

The Cable TV signal into your home may be a single cable (75ohm) or may include a Cable Box. In either case, the connection to the TV is easy.

If your Cable TV signal comes directly via a 75ohm coaxial cable, use the following steps:

- 1** Connect the Cable TV signal to the 75OHM ANTENNA INPUT jack on the rear of the TV. Screw it down tight.
- 2** Plug the TV's power cord into a power outlet and turn on the TV. Set TV/CATV to CATV as detailed on page 11. Refer to AUTO SEARCH to set up your available TV channels. Details are on page 12.

If you have a Cable Box, use the following steps:

- 1** Connect the Cable TV signal to the IN jack on the Cable Box.
- 2** Connect a separate coaxial cable to the OUT jack on the Cable Box and to the 75OHM ANTENNA INPUT jack on the rear of the TV.
- 3** Plug the TV's power cord into a power outlet and turn on the TV. Set TV/CATV to CATV as detailed on page 11.
- 4** Set the TV to channel 3 or 4 (the same as the channel 3/4 switch on your Cable Box if applicable). Change channels at the Cable Box.

Helpful Hint

An RF coaxial cable (to connect the Cable Box to the TV) may be supplied by the Cable TV company. It is not supplied with the TV.

You can connect a Satellite Receiver the same way you would connect a Cable Box.

Your Cable Box may have separate Audio and Video Out jacks instead. If so, use audio and video cables to connect the AUDIO/VIDEO OUT jacks of the Cable Box to the AUDIO/VIDEO INPUT jacks.

Press the INPUT button on the remote control to set the TV to the correct video input channel. For front inputs choose FRNT. For rear AV inputs choose VIDEO.

Your model has an S-Video input, choose S-VIDEO. Change the channel at the Cable Box.

Basic Antenna Connection

A combination antenna receives normal broadcast channels (VHF 2-13 and UHF 14-69). Your connection is easy since you will connect the antenna to the 75OHM ANTENNA INPUT jack on the rear of the TV.

- 1 If your antenna has a round cable (75ohm) on the end, then you are ready to connect it to the TV. Go to the next step. If your antenna has flat twin-lead wire (300ohm), you first need to attach the antenna wires to the screws on a 300 to 75ohm adapter (not supplied with TV).
- 2 Push the round end of the adapter or antenna cable onto the 75OHM ANTENNA INPUT jack on the rear of the TV. If the round end of the antenna cable is threaded, screw it down tight.
- 3 Plug the TV's power cord into a power outlet and turn on the TV. Set TV/CATV to TV mode as detailed on page 11. Refer to AUTO SEARCH to set up your available TV channels. Details are on page 12.

Before plugging the UHF/VHF Rod Antenna into the ANTENNA IN jack, check that the pin is not bent. If it is bent, straighten the pin as illustrated, then plug the pin into the ANTENNA IN jack.

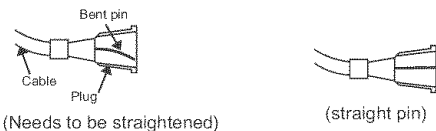

FCC WARNING -This equipment may generate or use radio frequency energy. Changes or modifications to this equipment may cause harmful interference unless the modifications are expressly approved in the instruction manual. The user could lose the authority to operate this equipment if an unauthorized change or modification is made.

*Some cable TV systems use scrambled signals and require a special converter to receive these channels. Consult your local cable company.

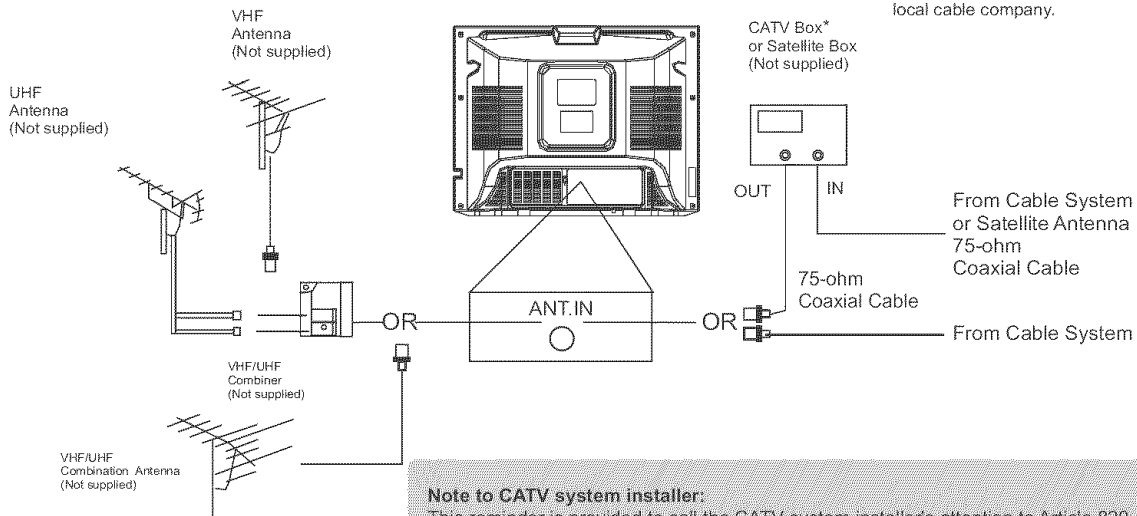

Note to CATV system installer:

This reminder is provided to call the CATV system installer's attention to Article 820-40 of the NEC (Section 54 of the Canadian Electrical Code, Part 1) that provides guidelines for proper grounding and, in particular, specifies that the cable ground shall be connected to the grounding system of the building as close to the point of cable entry as practical.

CABLE TV/ANTENNA CONNECTIONS

Helpful Hint

If you have separate UHF and VHF antennas, you need an optional combiner to connect the antennas to the TV.

Basic TV to VCR Connection

The basic component (VCR, DVD player etc.) to TV connection is described below. For other hookups, refer to your component's instruction manual.

- 1 Connect a yellow video cable to the VIDEO jack on the front of the TV and to the VIDEO OUT jack on your VCR (or other component).
- 2 Connect an audio cable to the AUDIO jack on the front of the TV and to the AUDIO OUT of the VCR (or other device). Match the cable color to the jack color.
- 3 Turn on the TV and the VCR.
- 4 Press the **INPUT** button on the remote control until the correct video input channel appears in the upper right corner of the TV screen. When you play material on the VCR, DVD player, etc. that is connected to the AUDIO and VIDEO jacks it will appear on the video input channel. (Page 4 has a complete list.)

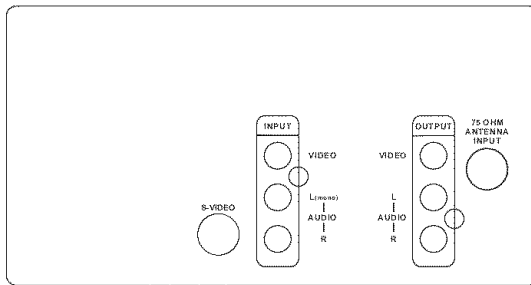

Model 24V511T: rear terminal



Model 24V511T: side AV (front)

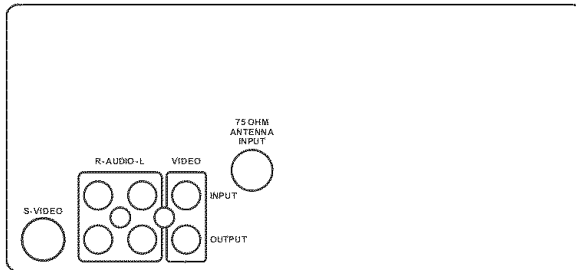

Model 20V500T: rear terminal

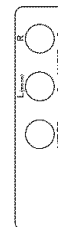

Model 20V500T: side AV (front)

Helpful Hint

Audio and video cables are not supplied with the TV. Audio cables are usually red and white. Video cables are usually yellow. Your VCR may not have audio and video out jacks, but only an RF or ANTENNA OUT jack. Use a coaxial cable to connect the VCR's ANTENNA OUT jack to the TV's 75OHM ANTENNA INPUT jack.

There is also an S-VIDEO jack on the rear of the TV. Use S-Video connection if your DVD player, camcorder, etc. has an S-Video Out jack. S-Video provides a clearer picture than the standard video (the yellow jack). Choose **S-VIDEO** to view material playing on equipment connected to the **S-VIDEO** jack. Use either S-VIDEO jack or VIDEO jack. Do not use both at the same time for the same piece of equipment. This would interfere with the picture display. If both are used, S-VIDEO has priority over the yellow VIDEO jack.

Description of Buttons on the TV

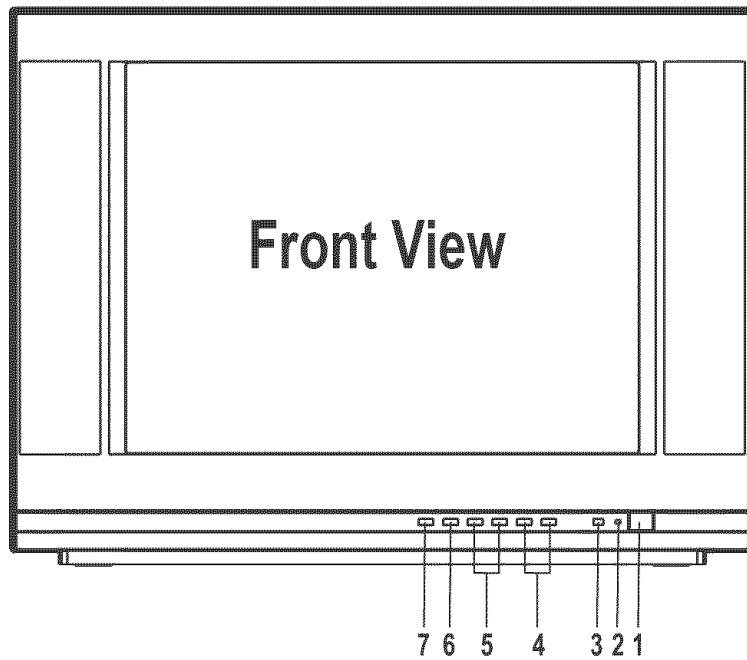

Front View

- 1. POWER BUTTON**
Turns the TV on and off.
- 2. STANDBY (LED INDICATOR)**
Lights to show AC power is available.
- 3. SENSOR**
Receives infra-red signals from the remote.
- 4. CHANNEL +/- BUTTONS**
Selects channel numbers.
Selects items in the submenus.
- 5. VOLUME +/- BUTTONS**
Press to decrease/increase the volume.
- 6. MENU BUTTON**
Press to display the main menu.
- 7. TV/VIDEO (INPUT) BUTTON**
Choose between TV programming and the AV input.

Remote Control

Battery Installation

Load batteries into the remote control:

- 1** Remove the battery compartment lid on the rear of the remote. Press in the tab, then lift off the lid.
- 2** Place two AA batteries in the remote. Be sure the (+) and (-) ends of the batteries line up correctly (as marked inside the battery compartment).
- 3** Reattach the battery compartment lid.

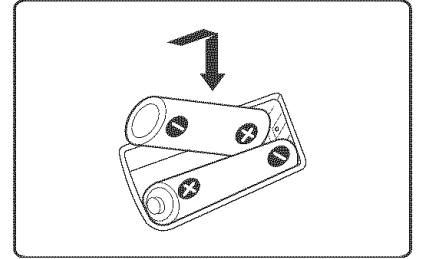

Effectively Using the Remote Control

- 4** Point the remote control toward the remote sensor on the front of the TV when operating the TV with the remote control.

Remote Control

NUMBER Button

When the TV/cable menu option is in the TV position, all channels can be selected by using two buttons. For example, to select channel 2, press "0" then "2". You can also press "2".

For channels 100 and above, press three number buttons of the channel directly. (You can select channels above 69 only if you have Cable TV. Make sure TV/CATV is set to CATV. Details are on page 11.)

In notebook mode, press to enter a letter, a digit or a symbol. Details are on page 33.

INPUT Button

Press to select TV channels or the Audio/Video IN channels. Page 4 has a complete list.

MENU Button

Press to see the TV's on-screen menu. Press to go back to the previous menu or to remove a menu from the screen.

GO BACK Button

Press to return to the previously viewed channel.

VOLUME +/- Button

Press to adjust the TV sound level.

MUTE Button

Press to mute or restore the TV sound. Pressing the volume buttons (VOLUME+ or VOL+) will also cancel mute and restore the sound.

MTS Button (Model 24V511T only)

Press to select a sound mode if available with the TV programming: MONO, STEREO, and SAP. Details are on page 32.

NOTEPAD Button

Press to display or close the NOTEBOOK window.

CAPS Button

Press to toggle the entry mode between uppercase or lowercase letters. Details are on page 33.

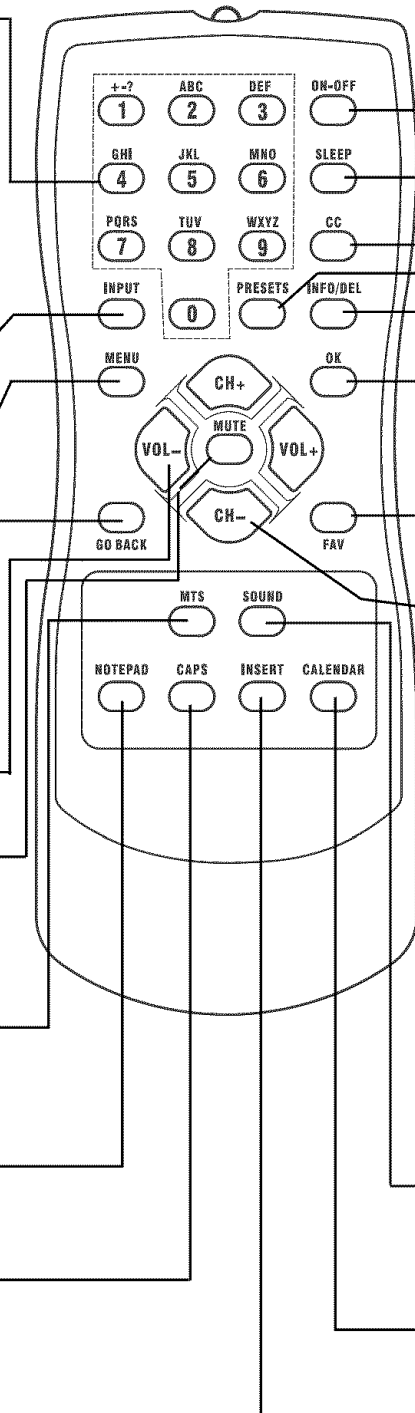

ON-OFF Button

Press to turn the TV on or off. You can also turn on the TV by pressing the CHANNEL +/- buttons on the front of the TV.

SLEEP Button

Press to select a time period (120 minutes to 10 minutes in 10-minute decrements) after which the TV will turn itself off. Details are on page 22.

CC (C.Mute) Button

Press to turn on/off C.Mute function directly. Details are on page 21.

PRESETS Button

Press to select one of the four preset picture settings (Bright, Normal, Theater or Personal). Details are on page 17.

INFO/DEL(ETE) Button

Press to see the current channel number and sound information on the TV screen. Press again to display the current time on the screen. Press to remove a menu from the screen. In notebook mode, press to delete the unwanted text. Details are on page 33.

OK Button

Within the on-screen menu, press to select some special function, such as Favorite list, etc.

FAV(ORITE) Button

Press to browse the channels in your Favorite List. Details are on page 14.

CHANNEL +/- Button

Press to select memorized TV channels.

SOUND Button (Model 24V511T only)

Press to select one of the four sound settings (Theater, Concert, Speech or Personal). Details are on page 29.

CALENDAR Button

Press to display or close the calendar.

INSERT Button

In notebook mode, press to select INS(ERT) or OVR(overwrite). Details are on page 33.

Language

You can set the TV's on-screen menu to English, French or Spanish.

- 1** Press **MENU** to see the main menu.
- 2** Press **CH+** or **CH-** to highlight Preferences.
- 3** Press **OK** to enter the Preferences submenu.
- 4** **Language** is highlighted. Press **VOL+** or **VOL-** to select **English**, **Francais (French)**, or **Espanol (Spanish)**.
- 5** Press **MENU** repeatedly to exit the menu or the menu will automatically disappear within a few seconds if no buttons are pressed on the remote control.

Model 20V500T: If you have this model you will not see the Sound menu option and your remote will not have MTS or SOUND buttons.

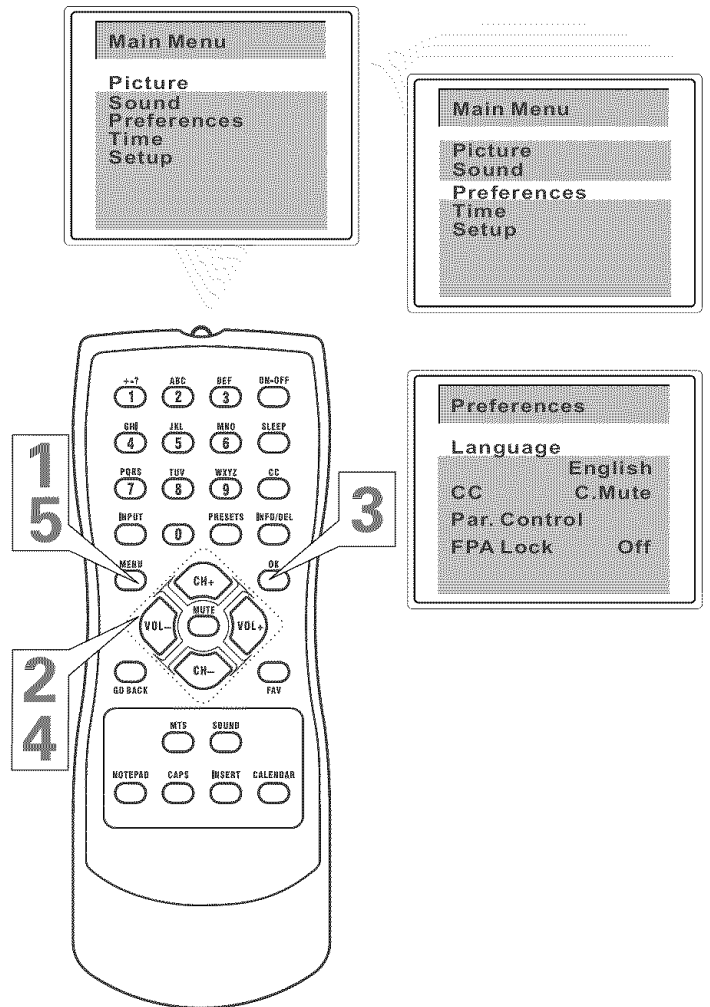

Helpful Hint

The language control only affects the language of the TV menus. It does not change the other on-screen text features, such as Closed Captions.

TV/Cable TV(CATV)

It is important for the TV to know what type of signal-Cable TV (CATV) or a normal antenna you are using. Choose your signal (Antenna or Cable):

- 1** Press **MENU** to see the main menu.
- 2** Press **CH+** or **CH-** to highlight **Setup**.
- 3** Press **OK** to enter the **Setup** submenu.
- 4** **TV/CATV** is highlighted. Press **VOL+** or **VOL-** to select **TV** or **CATV**.
Choose **CATV** if you have Cable TV service. (See page 4 for connection details.) If you do not have Cable TV service and you connected an antenna to the TV, choose **TV**. (See page 5 for connection details.)
- 5** Press **MENU** repeatedly to exit the menu or the menu will automatically disappear within a few seconds if no buttons are pressed on the remote control.

Model 20V500T: If you have this model you will not see the **Sound** menu option and your remote will not have **MTS** or **SOUND** buttons.

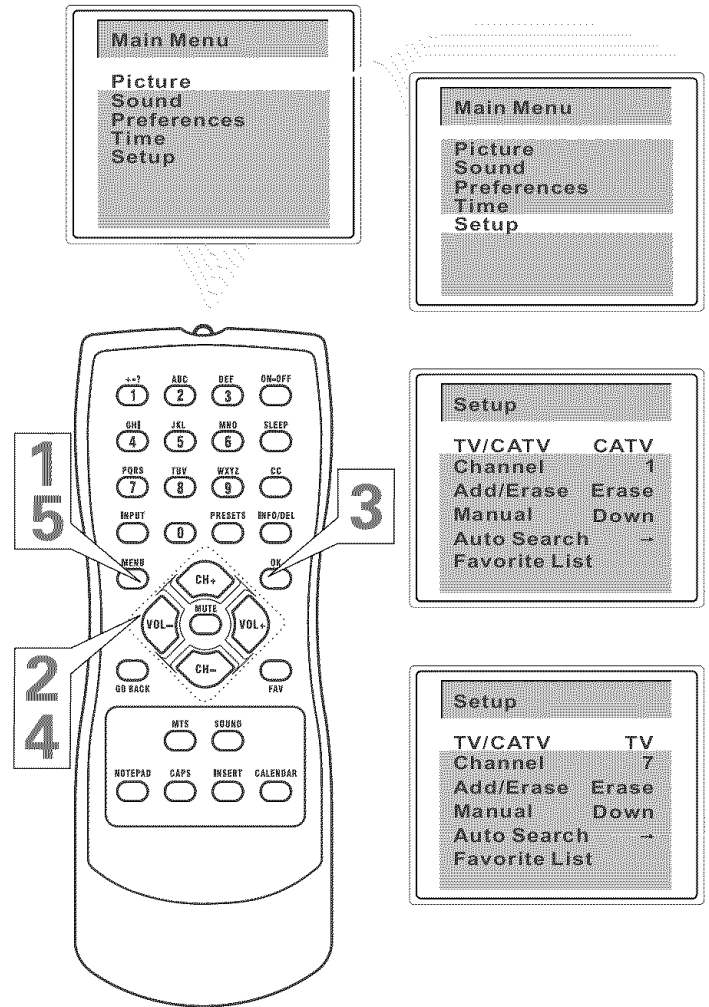

Helpful Hint

When **CATV** is selected, channels 1-125 are available.

When **TV** is selected, only channels 2-69 are available.

You cannot select the **Setup** menu if the TV is set to a video input channel (FRNT). Press **INPUT** repeatedly to get to regular TV programming.

Auto Search (Setting TV Channels)

You can set your TV to receive local TV channels (from an antenna) or Cable TV channels (when you have Cable TV service). Then, use Auto Search to set up channels that are available for you. This makes it easy for you to select only the available TV stations when you press CH+ or CH-. Before you start Auto Search, make the Antenna or Cable TV connection described on pages 4 and 5. In the menu select TV or Cable (CATV) as described on page 11.

- 1 Press **MENU** to see the main menu.
- 2 Press **CH+** or **CH-** to highlight **Setup**.
- 3 Press **OK** to enter the **Setup** submenu.
- 4 Press **CH+** or **CH-** repeatedly to highlight **Auto Search**.
- 5 Press **VOL+** to start programming TV channels. Press **VOL-** if you need to stop channel programming during the process.
When channel setup is completed, the TV will go to its lowest channel.

Model 20V500T: If you have this model you will not see the Sound menu option and your remote will not have MTS or SOUND buttons.

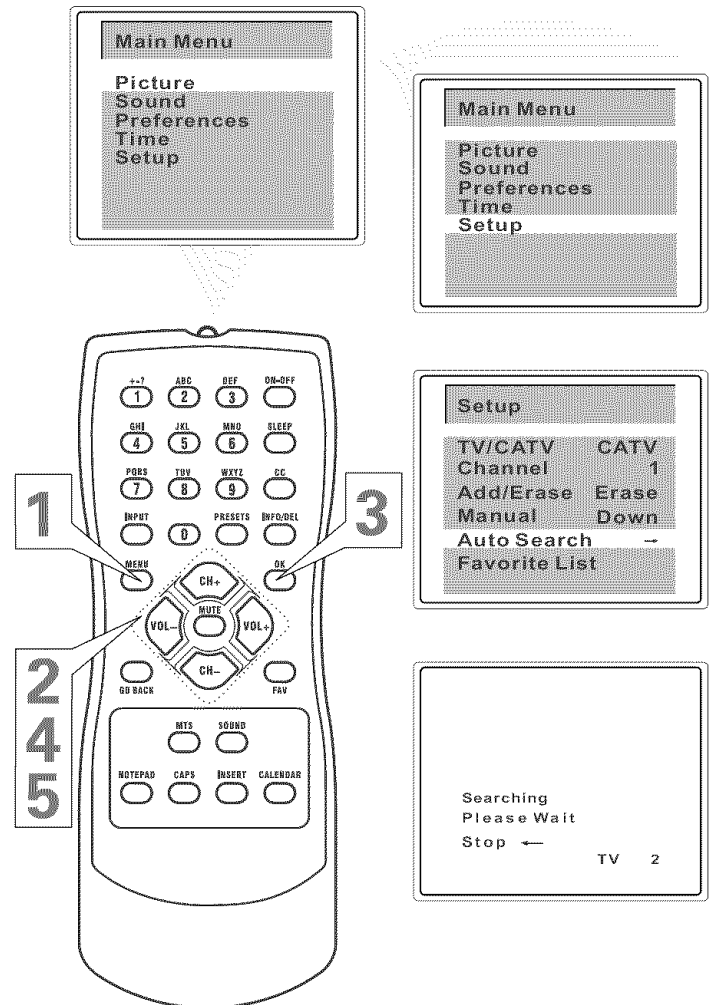

Helpful Hint

Press **CH+** or **CH-** to see which channels are in the TV's memory. You can also select channels that have not been memorized using the number buttons on the remote control.

To delete unwanted channels from the TV's memory or to add more channels, see **ADD/ERASE** on page 15.

You cannot select the **Setup** menu if the TV is set to a video input channel (FRNT). Press **INPUT** repeatedly to get to regular TV programming.

Manual Channel Tuning

Manual Channel Tuning allows you to search for channels that may have been missed during the Auto Search. For example, if you are looking for a channel between 60 and 70, start the search at channel 60 and go up.

- 1 Press **MENU** to see the main menu.
- 2 Press **CH+** or **CH-** to highlight **Setup**.
- 3 Press **OK** to enter the **Setup** submenu.
- 4 **TV/CATV** is highlighted. Press **VOL+** or **VOL-** to select **TV** or **CATV** (whichever you have). Details are on page 11.
- 5 Press **CH+** or **CH-** repeatedly to highlight **Channel**.
- 6 Press **VOL+** or **VOL-** to enter the channel number at which you want to begin the search.
- 7 Press **CH+** or **CH-** repeatedly to select **Manual**.
- 8 Press **VOL+** to start searching upward (for example, starting at channel 60 and going up to 61, 62, 63, etc.). Press **VOL-** when you find the channel you want. This stops the search. Otherwise the search will stop at the first available channel.
Or, press **VOL-** to start searching downward (for example, starting at channel 60 and going down to 59, 58, 57, etc.). Press **VOL+** when you find the channel you want. This stops the search. Otherwise the search will stop at the first available channel.
- 9 Press **MENU** repeatedly to exit the menu or the menu will automatically disappear within a few seconds if no buttons are pressed on the remote control.

Model 20V500T: If you have this model you will not see the **Sound** menu option and your remote will not have **MTS** or **SOUND** buttons.

Helpful Hint

You cannot select the **Setup** menu if the TV is set to a video input channel (FRNT). Press **INPUT** repeatedly to get to regular TV programming.

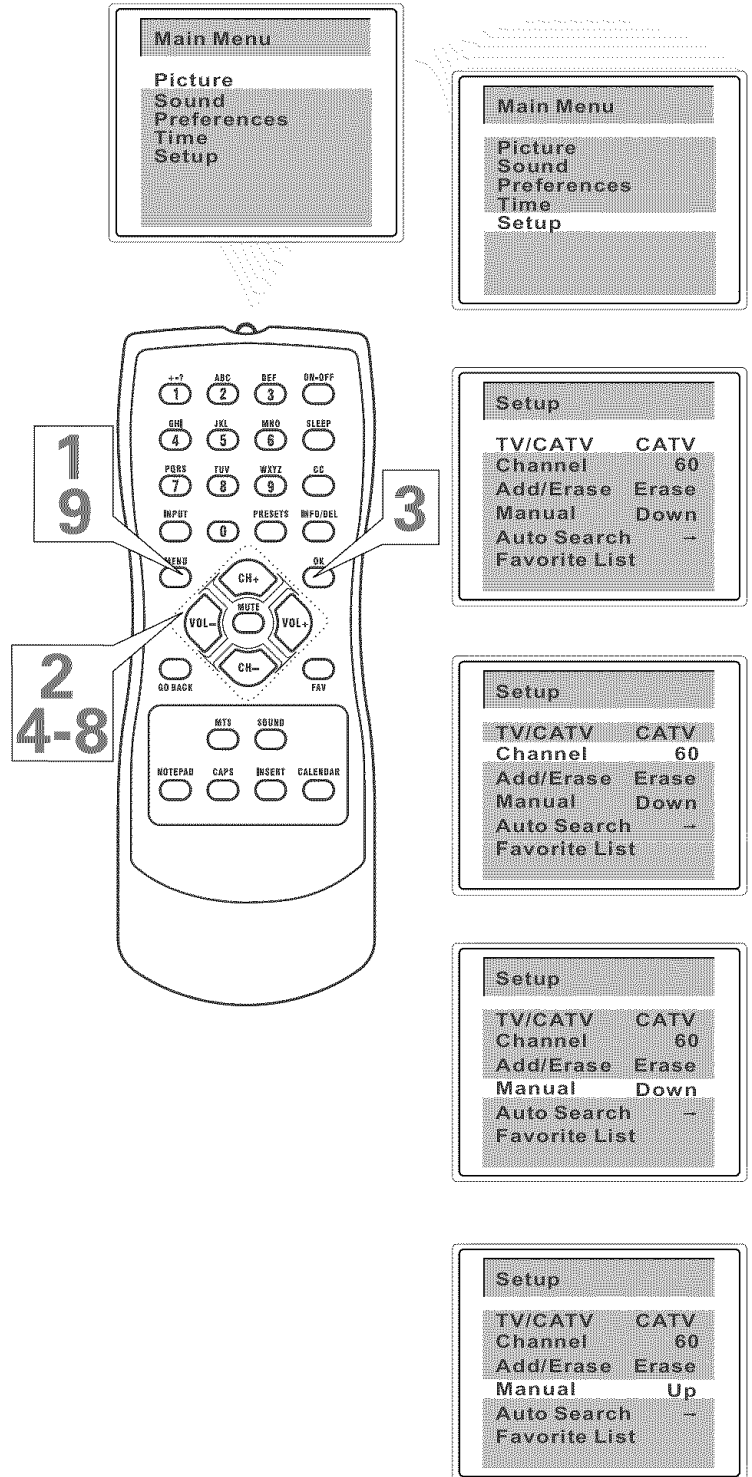

Favorite Channel Setting

You can store five channels you prefer into the Favorite List and recall these channels easily by pressing the FAV button on the remote control.

- 1** Press **MENU** to see the main menu.
- 2** Press **CH+** or **CH-** to highlight **Setup**.
- 3** Press **OK** to enter the **Setup** submenu.
- 4** Press **CH+** or **CH-** repeatedly to highlight **Favorite List**.
- 5** Press **OK** to display the features of **Favorite List**.
- 6** **TV/CATV** is highlighted. Press **VOL+** or **VOL-** to select **TV** or **CATV** (whichever you have).
- 7** Press **CH+** or **CH-** to select **CH1** (the first channel position), then press **VOL+** or **VOL-** to enter a channel number you want to store at this position, such as **CATV 8**. Repeat to set the other four favorite channels.
- 8** Press **MENU** repeatedly to exit the menu or the menu will automatically disappear within a few seconds if no buttons are pressed on the remote control.

Model 20V500T: If you have this model you will not see the **Sound** menu option and your remote will not have **MTS** or **SOUND** buttons.

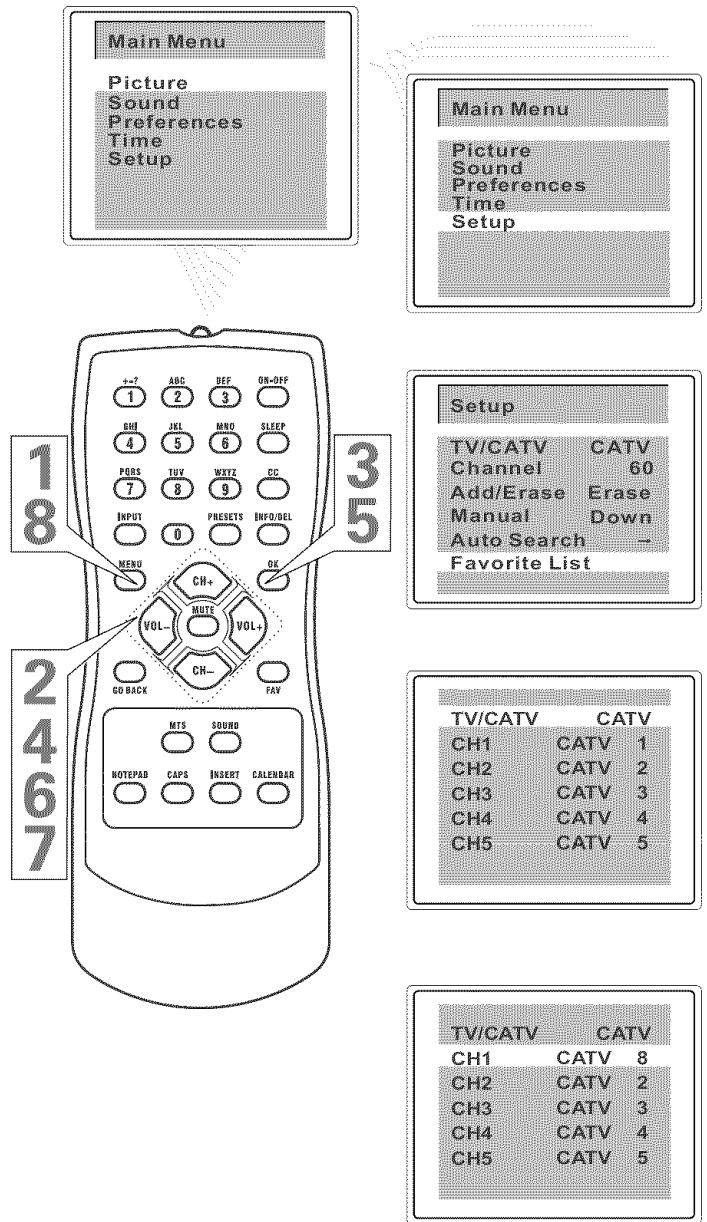

Helpful Hint

You cannot select the **Setup** menu if the TV is set to a video input channel (FRNT). Press **INPUT** repeatedly to get to regular TV programming.

Adding or Erasing Channels

You can add or erase channels from the list in the TV's memory.

- 1** Press **MENU** to see the main menu.
- 2** Press **CH+** or **CH-** to highlight **Setup**.
- 3** Press **OK** to enter the **Setup** submenu.
- 4** **TV/CATV** is highlighted. Press **VOL+** or **VOL-** to select **TV** or **CATV** (whichever you have). Details are on page 11.
- 5** Press **CH+** or **CH-** repeatedly to highlight **Channel**.
- 6** Press **VOL+** or **VOL-** to enter the channel number you want to add or erase.
- 7** Press **CH+** or **CH-** repeatedly to highlight **Add/Erase**.
- 8** Press **VOL+** or **VOL-** to choose **Add** or **Erase**. If you select **Add**, the channel will be available when you press **CH+** and **CH-** to move through the channels. Choosing **Erase** will remove the channel from the TV's memory. The channel will not be available when you flip through channels with the **CH+** and **CH-** buttons.
- 9** Press **MENU** repeatedly to exit the menu or the menu will automatically disappear within a few seconds if no buttons are pressed on the remote control.
- 10** You won't see the change take effect until you scroll through the channels in memory using the **CH+/-** buttons.

Model 20V500T: If you have this model you will not see the **Sound** menu option and your remote will not have **MTS** or **SOUND** buttons.

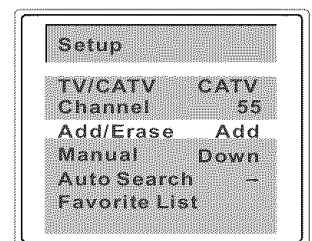
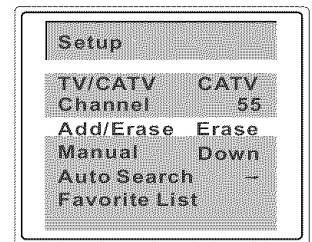
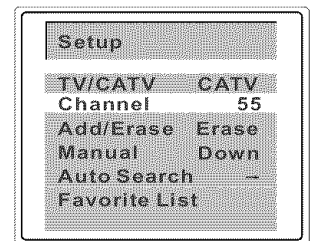
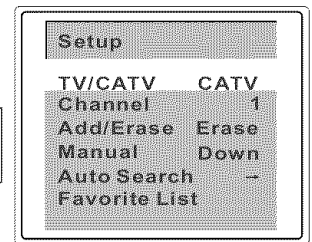
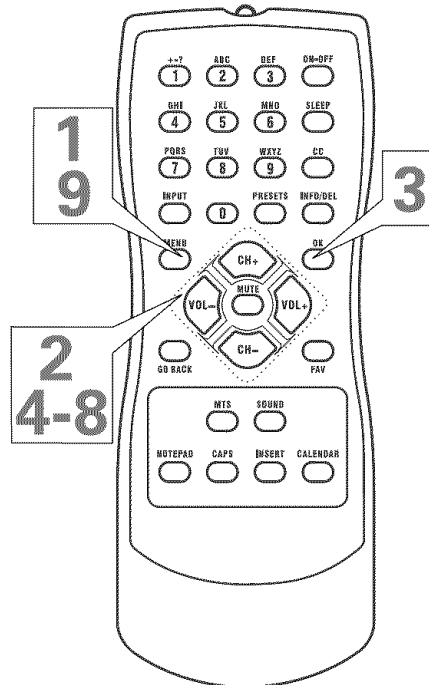
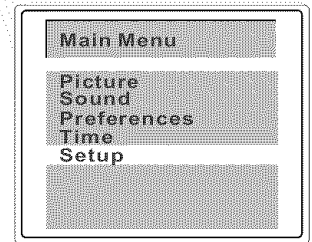
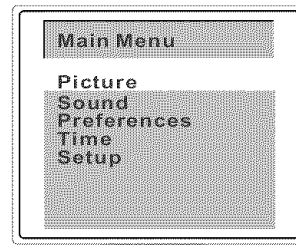

Helpful Hint

You cannot select the **Setup** menu if the TV is set to a video input channel (FRNT). Press **INPUT** repeatedly to get to regular TV programming.

Picture Adjustments

To adjust your TV picture, select a channel and follow the steps below:

- 1** Press **MENU** to see the main menu.
- 2** **Picture** is highlighted. Press **OK** to enter the **Picture** submenu.
- 3** Press **CH+** or **CH-** repeatedly to highlight your choice: **Color**, **Brightness**, **Contrast**, **Sharpness**, **Tint**, **Blue Back** (background), or **C.Warmth** (color temperature.)
- 4** Press **VOL+** or **VOL-** to increase or decrease the element you choose. However, you can turn **Blue Back** to only **On** or **Off** (see below). You can choose **Warm**, **Cool** or **Normal** mode for color temperature.
- 5** Press **MENU** repeatedly to exit the menu or the menu will automatically disappear within a few seconds if no buttons are pressed on the remote control.

Model 20V500T: If you have this model you will not see the **Sound** menu option and your remote will not have **MTS** or **SOUND** buttons.

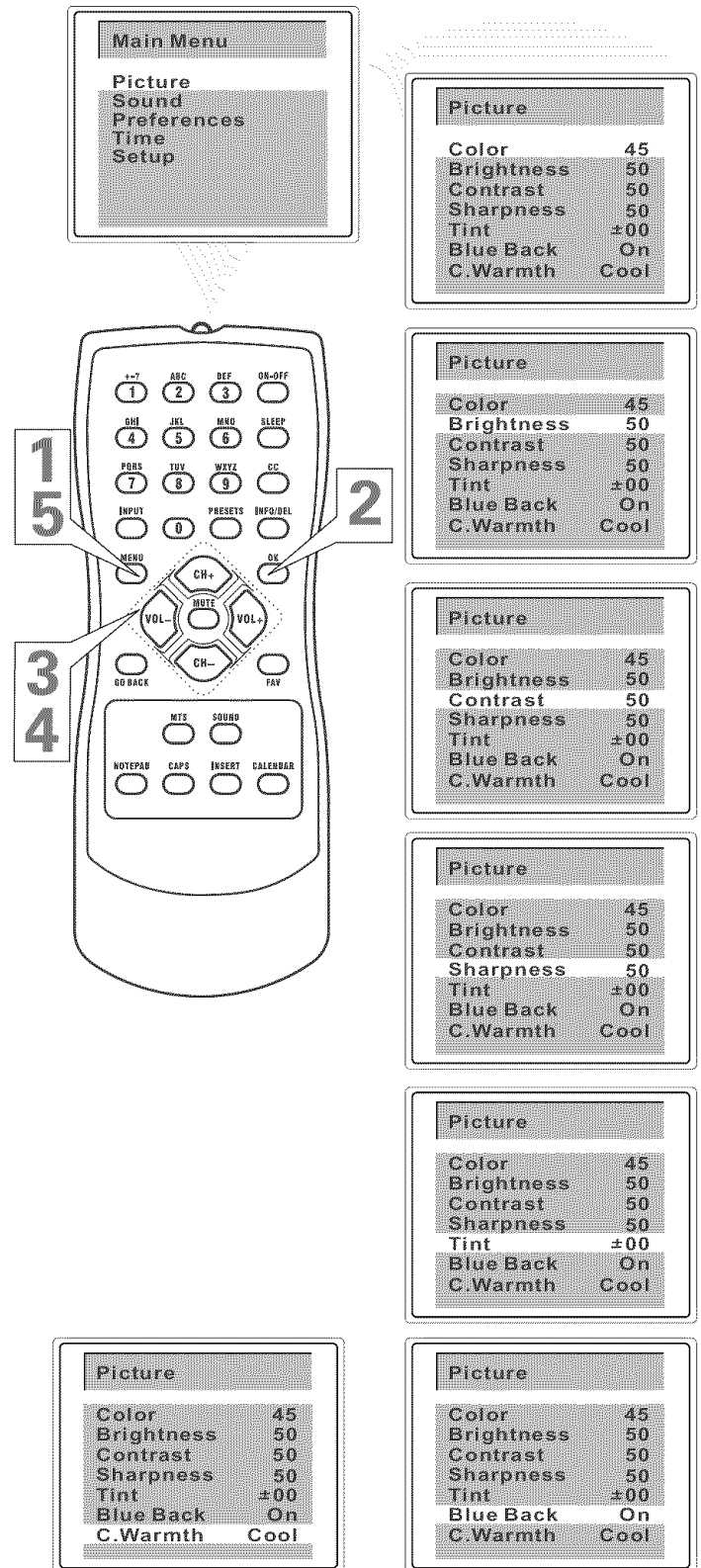

Helpful Hint

Color: Adjust to add or reduce color.

Brightness: Adjust to brighten the darkest parts of the picture.

Contrast: Adjust the distinction between the black and white parts of the picture.

Sharpness: Improve picture detail.

Blue Back: Turn this option On or Off. If you choose On, a solid blue background screen will appear if the TV is on a weak channel (for example, if the reception is very poor or if the station has gone off the air for the night). After being on such a channel for 15 minutes, the TV will turn itself off automatically.

C. Warmth: Set this option to Normal, Warm or Cool mode.

Preset Picture Mode

This function enables you to choose preset video settings for different types of programs and viewing conditions. Most picture settings are preset at the factory to automatically adjust the TV's Brightness, Color, Contrast, and Sharpness.

- 1** Press **PRESETS** on the remote control. The current preset picture setting will appear on the screen.
- 2** Press **PRESETS** repeatedly to select **Personal**, **Normal**, **Bright**, or **Theater**.
The **Personal** setting is what you specify with the picture adjustments as described on page 16. **Personal** is the only picture setting you can change. All others are set at the factory.

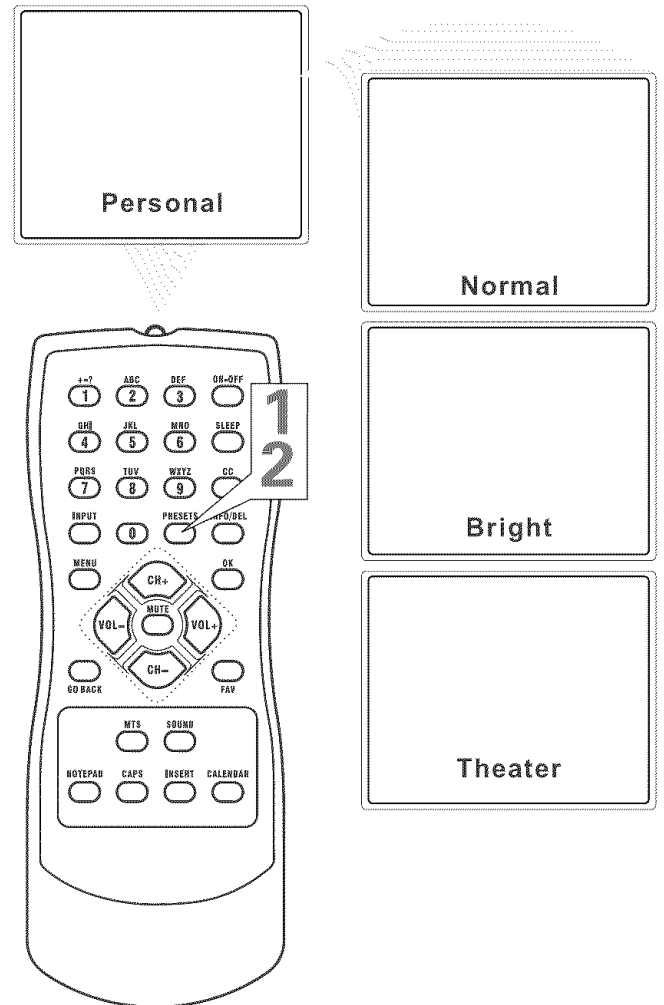

Clock

Follow these steps to set the clock.

- 1** Press **MENU** to see the main menu.
- 2** Press **CH+** or **CH-** to highlight **Time**.
- 3** Press **OK** to enter the **Time** submenu.
- 4** Press **CH+** or **CH-** repeatedly to highlight **Clock**.
- 5** Press **VOL+** or **VOL-** to change the time in minutes. Press and hold **VOL+** or **VOL-** to change the time quickly in 10 minute increments; press **OK**. The highlight moves to the hour position. Use **VOL+** or **VOL-** to set the hour.
- 6** Press **MENU** repeatedly to exit the menu or the menu will automatically disappear within a few seconds if no buttons are pressed on the remote control.

Model 20V500T: If you have this model you will not see the **Sound** menu option and your remote will not have **MTS** or **SOUND** buttons.

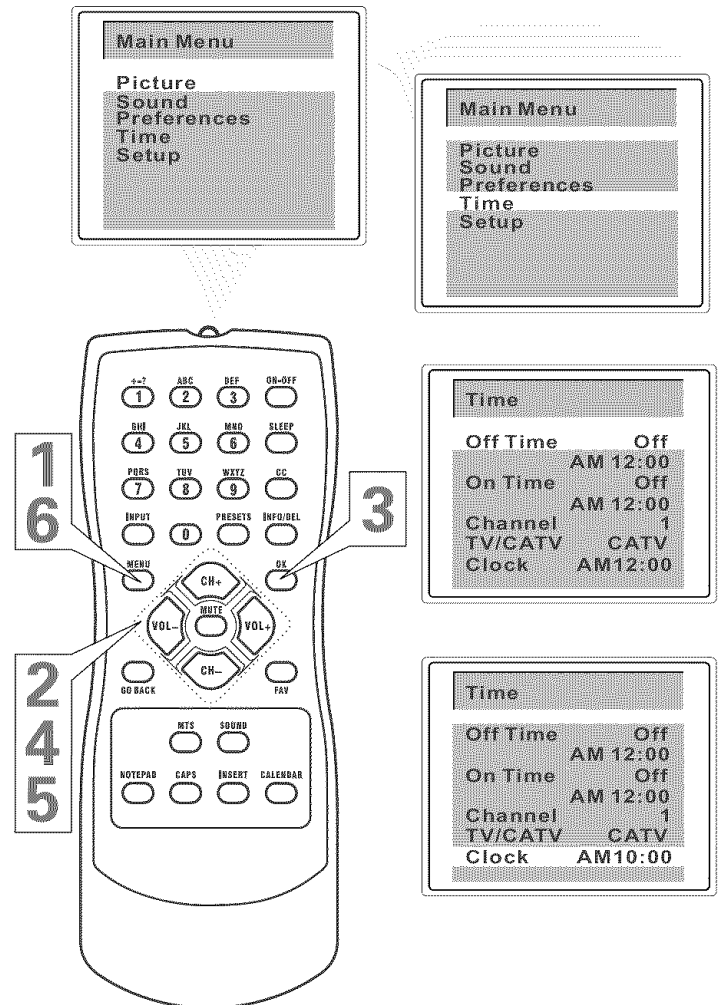

Helpful Hint

If the power fails, you must reset the clock.

On-Timer

To turn on the TV to a specific channel at a specific time, use the On-Timer. Before you begin, set the clock correctly. Details are on page 18.

- 1** Press **MENU** to see the main menu.
- 2** Press **CH+** or **CH-** to highlight **Time**.
- 3** Press **OK** to enter the **Time** submenu.
- 4** Press **CH+** or **CH-** repeatedly to highlight **TV/CATV**.
- 5** Press **VOL+** or **VOL-** to select **TV** or **CATV**, depending on whether you have Cable TV service or not. Details are on page 11.
- 6** Press **CH+** or **CH-** repeatedly to highlight **Channel**.
- 7** Press **VOL+** or **VOL-** to enter the channel number. This will be the channel to which the TV turns on at the specified time.
- 8** Press **CH+** or **CH-** repeatedly to highlight **On Time**.
- 9** Press **VOL+** or **VOL-** to select **Once**, **Daily** or **Off**. If you select **Once**, the timer will turn on the TV one time within the next 24 hours only. If you select **Daily**, the timer will turn on the TV at the same time and to the same channel every day. Choose **Off** to cancel the On-timer.
- 10** Press **CH+** or **CH-** repeatedly to highlight **0:00** under the line of **On Time**.
- 11** Press **VOL+** or **VOL-** to enter the on time. Hold down **VOL+** or **VOL-** to change the time quickly in 10 minute increments; press **OK**. The hour is highlighted. Use **VOL+** or **VOL-** to set the hour. This will be the time at which the TV will turn itself on.
- 12** Press **MENU** repeatedly to exit the menu or the menu will automatically disappear within a few seconds if no buttons are pressed on the remote control.

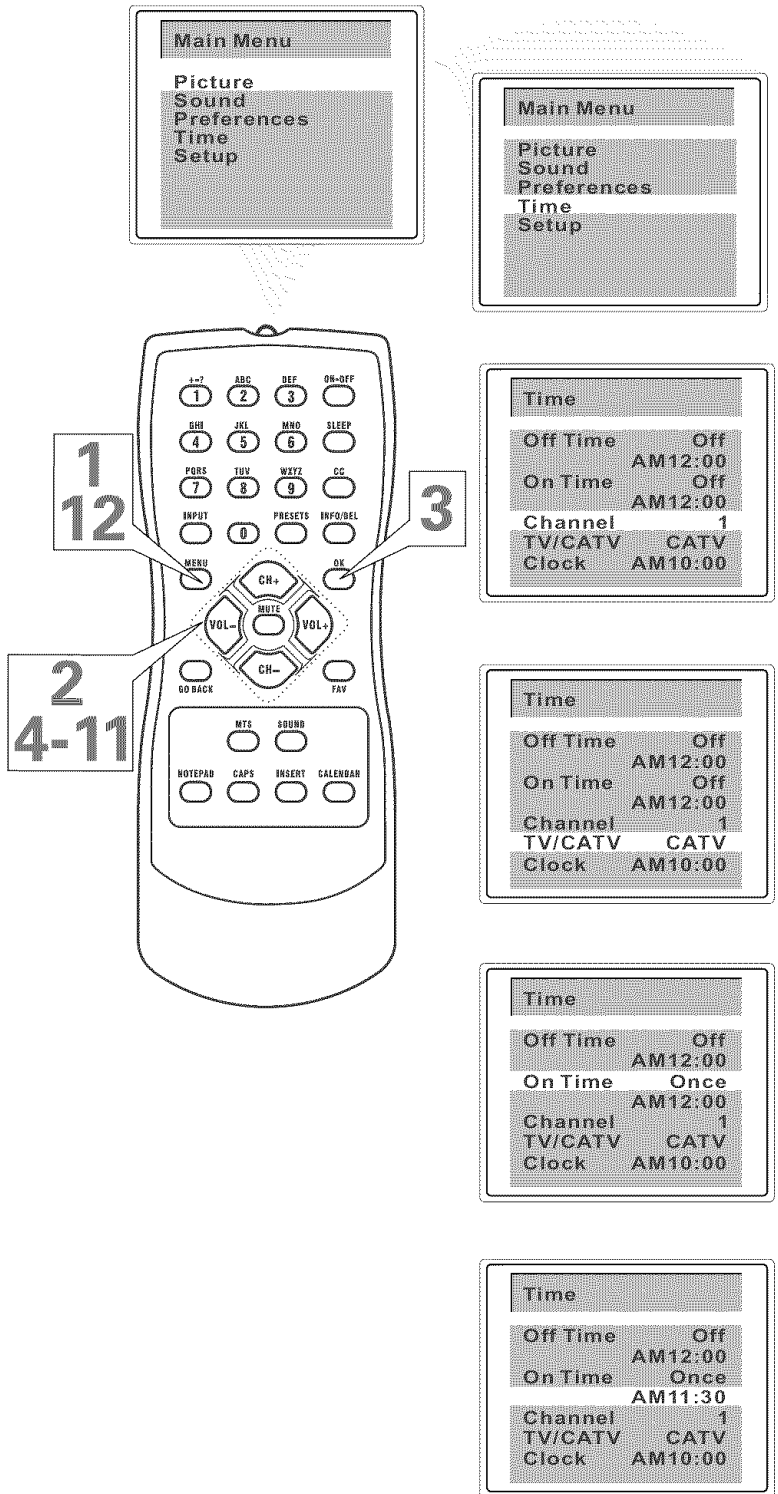

Model 20V500T: If you have this model you will not see the Sound menu option and your remote will not have MTS or SOUND buttons.

Off-Timer

To turn off the TV at a specific time every day, use the Off-Timer. Before you begin, you must set the clock correctly. Details are on page 18.

- 1** Press **MENU** to see the main menu.
- 2** Press **CH+** or **CH-** to highlight **Time**.
- 3** Press **OK** to enter the **Time** submenu.
- 4** **Off Time** is highlighted. Press **VOL+** or **VOL-** to select **Once**, **Daily** or **Off**.
If you select **Once**, the timer will turn off the TV once. If you select **Daily**, the timer will turn off the TV at the same time every day. Choose **Off** to cancel the Off-timer.
- 5** Press **CH+** or **CH-** repeatedly to highlight **0:00** under the line of **Off Time**.
- 6** Press **VOL+** or **VOL-** to enter the off time. Hold down **VOL+** or **VOL-** to change the time quickly in 10 minute increments; press **OK**. The highlight moves to the hour position. Use **VOL+** or **VOL-** to set the hour. This will be the time at which the TV will turn itself off.
- 7** Press **MENU** repeatedly to exit the menu or the menu will automatically disappear within a few seconds if no buttons are pressed on the remote control.

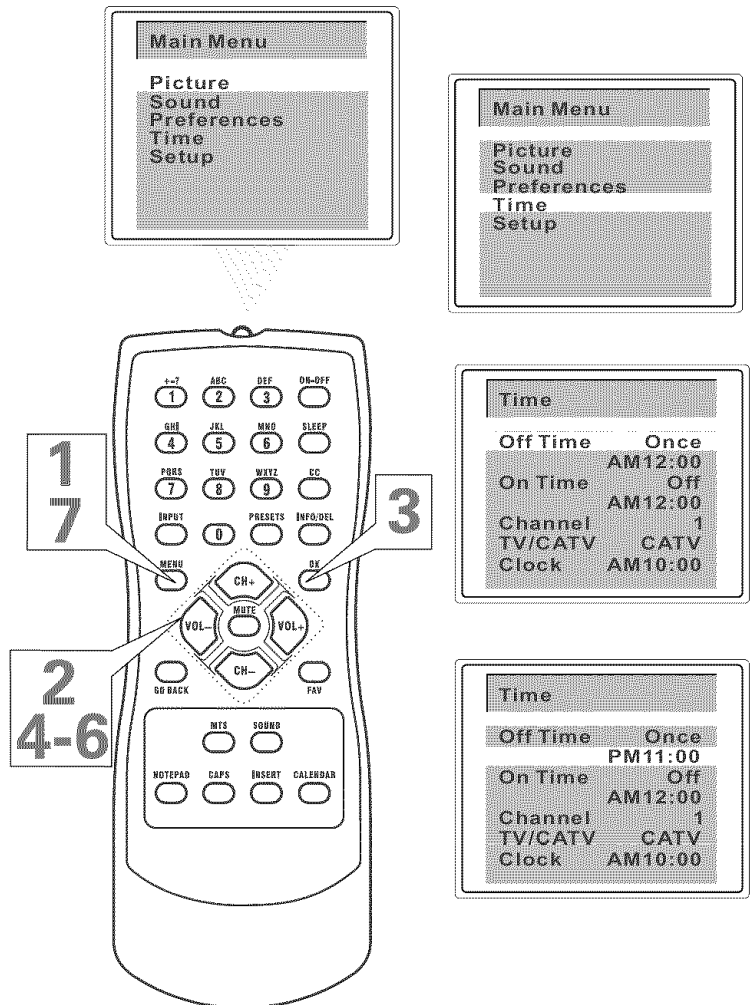

Model 20V500T: If you have this model you will not see the **Sound** menu option and your remote will not have **MTS** or **SOUND** buttons.

Closed Caption

Closed captioning (CC) lets you read the voice content of TV programs on the TV screen. Designed to help the hearing impaired, on-screen text boxes will show dialog, conversation, and activity during TV programming.

- 1 Press **MENU** to see the main menu.
- 2 Press **CH+** or **CH-** to highlight Preferences.
- 3 Press **OK** to enter the Preferences submenu.
- 4 Press **CH+** or **CH-** repeatedly to highlight CC.
- 5 Press **VOL+** or **VOL-** to select the closed caption you want (**Off**, **C1**, **C2**, or **C.Mute**). **C.Mute** sets the TV to show closed caption when you press **MUTE**. The TV volume will be disabled until you press **MUTE** or **VOL+** again to restore the sound.
- 6 Press **MENU** repeatedly to exit the menu or the menu will automatically disappear within a few seconds if no buttons are pressed on the remote control.

Model 20V500T: If you have this model you will not see the Sound menu option and your remote will not have MTS or SOUND buttons.

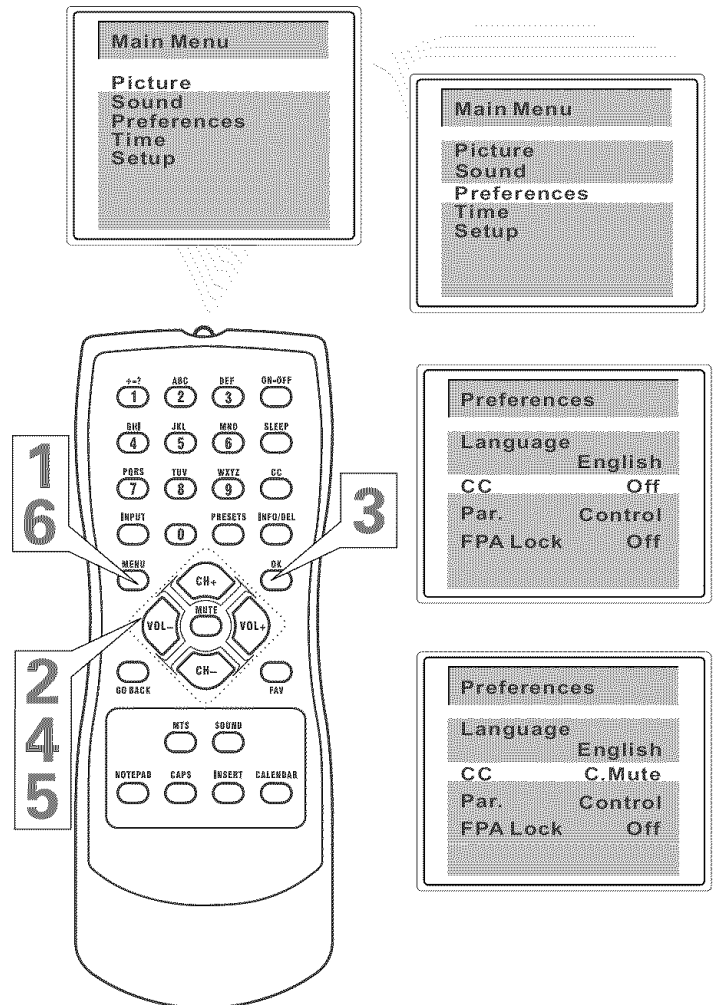

Helpful Hint

Not all TV programs and commercials are broadcast with Closed Caption information. Neither are all Closed Caption modes transmitted by a station for a closed caption program.

See your TV listings for the stations and times of Closed Caption shows.

Press **CC** on the remote control to turn on/off C.Mute function directly. C.Mute On or C.Mute Off will appear on the screen accordingly.

Sleep Timer

The Sleep Timer turns off the TV within an amount of time you specify (10-120 minutes from the current time).

- 1** Press **SLEEP** repeatedly to set the sleep timer from 120 to 10 minutes in 10-minute decrements.
- 2** After setting the sleep timer, press **SLEEP** once to display the remaining time.
- 3** To cancel the sleep timer, press **SLEEP** until "Off" appears.
- 4** Within **1 minute** of the time set, a clock icon will flash to remind you that the TV will turn itself off soon.

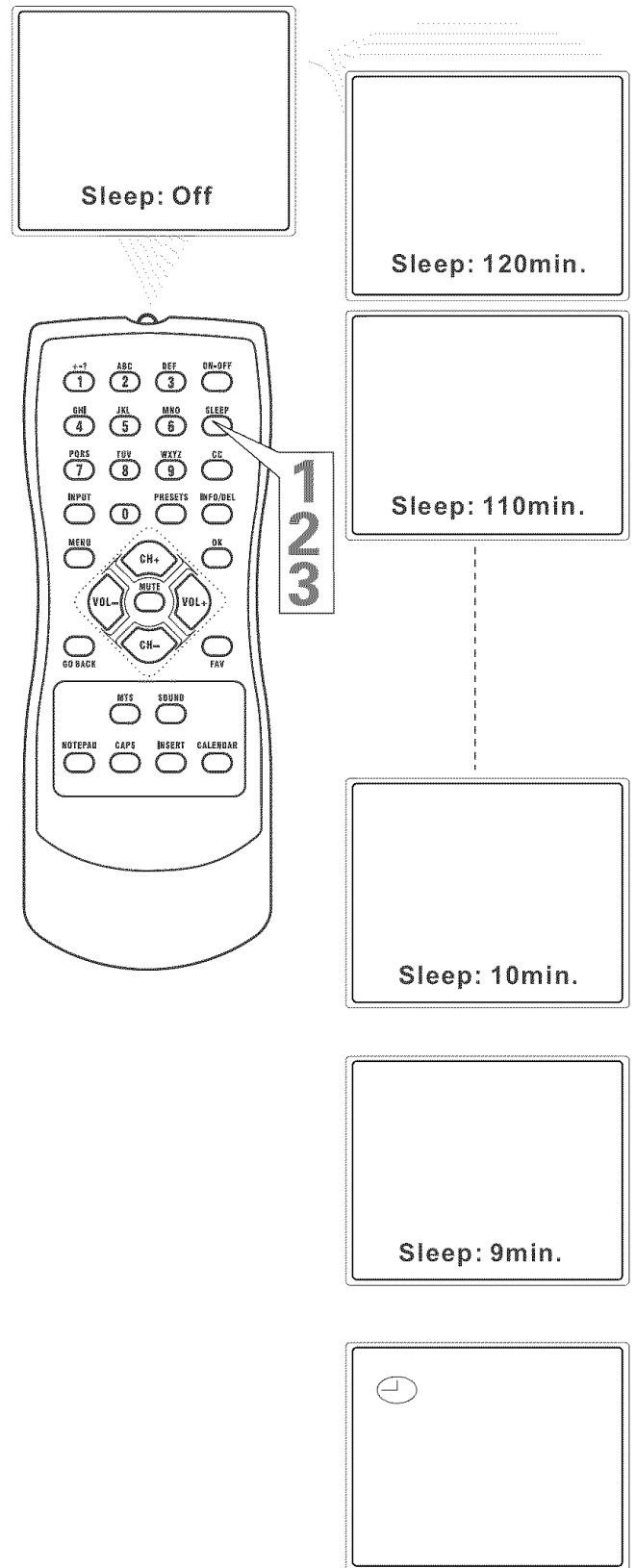

Understanding Parental Lock

Parental Lock processes program content advisories from broadcasters. Parental Lock can respond to the content advisories and block objectionable content (offensive language, violence, sexual situations, etc.) This is a great feature to censor the type of programming children watch. **Parental Lock offers various blocking options from which to choose:**

MASTER ENABLE: This is the "master switch" for Parental Lock. When ON, all blocking/censoring you have set is enabled. When OFF, all blocking is disabled.

BLOCK UNRATED: All unrated programs (based on Movie Ratings or TV Ratings) will be blocked if this feature is ON and MASTER ENABLE is ON.

BLOCK NO RATING: All programming with no content advisory data will be blocked if this feature is ON and MASTER ENABLE is ON.

After you set your password you can block up to six ratings in TV Ratings or Movie Ratings. These ratings are set by the Motion Picture Association of America and TV broadcasters.

MPAA Ratings

(Motion Picture Association of America)

G: General Audience - All ages admitted. Most parents would find this program suitable for all ages. This type of programming contains little or no violence, no strong language, and little or no sexual dialog or situation.

PG: Parental Guidance Suggested - This programming contains material that parents may find unsuitable for younger children. It may contain one or more of the following: moderate violence, some sexual situations, infrequent coarse language, or some suggestive dialog.

PG-13: Parents Strongly Cautioned - This programming contains material that parents may find unsuitable for younger children under the age of 13. It contains one or more of the following: violence, sexual situations, coarse language, or suggestive dialog.

R: Restricted - This programming is specially designed for adults. Anyone under the age of 17 should only view this programming with an accompanying parent or adult guardian. It contains one or more of the following: intense violence, intense sexual situations, strong coarse language, or intensely suggestive dialog.

NC17: No children under the age of 17 will be admitted- This type of programming should be viewed by adults only. It contains graphic violence, explicit sex, or crude, indecent language.

X: Adult only - This type of programming contains one or more of the following: very graphic violence, very graphic and explicit sexual acts, very coarse and intensely suggestive language.

TV Ratings

(TV broadcaster)

TV Y All children - Appropriate for all children. Designed for a very young audience, including children age 2-6. This type of programming is not expected to frighten younger children.

TV Y7 Directed to Older Children - Designed for children age 7 and above. It may be appropriate for children who can distinguish between make-believe and reality. This programming may include mild fantasy and comic violence (FV or Fantasy violence).

TV G General Audience - Most parents would find this programming suitable for all ages. This type of programming contains little or no violence, no strong language, and little or no sexual dialog or situation.

TV PG Parents Guidance Cautioned - Contains material that parents may find unsuitable for younger children. This type of programming contains one or more of the following: moderate violence(V), some sexual situations (S), infrequent coarse language (L), or some suggestive dialog (D).

TV 14 Parents Strongly Cautioned - Contains material that parents may find unsuitable for children under 14 years of age. This type of programming contains one or more of the following: intense violence (V), intense sexual situations (S), strong coarse language (L), or intensely suggestive dialog (D).

TV MA Mature Audience only - Specially designed to be viewed by adults and may be unsuitable for children under 17. This type of programming contains one or more of the following: graphic violence (V), explicit sexual situations (S), or crude, indecent language (L).

Changing Your Password

Over the next few pages, you'll learn how to block programs and understand the rating terms for certain broadcasts. First set your password.

- 1 Press **MENU** to see the main menu.
- 2 Press **CH+** or **CH-** to highlight Preferences.
- 3 Press **OK** to enter the Preferences submenu.
- 4 Press **CH+** or **CH-** repeatedly to highlight Par. (Parental) Control.
- 5 Press **OK**. The display asking you to Enter Password will appear on the screen.
If you want to set a new code, go on to steps 6-8 directly. (You can press the number buttons to enter a four-digit code. The code "0000" is the default password of the TV. If you have not set up a code previously, then "0000" is the code).

Resetting your Password

- 6 Press **VOL+** on the remote and **CHANNEL +** on the front of the TV at the same time. Enter New Pwd. will appear on the screen. (You must be in the Enter password screen when attempting this).
- 7 Press the **number buttons** to enter a four-digit code. The code will appear on the screen as you enter it.
- 8 Press **OK** to save the code.
- 9 Press **MENU** repeatedly to exit the menu or the menu will automatically disappear within a few seconds if no buttons are pressed on the remote control.

Model 20V500T: If you have this model you will not see the Sound menu option and your remote will not have MTS or SOUND buttons.

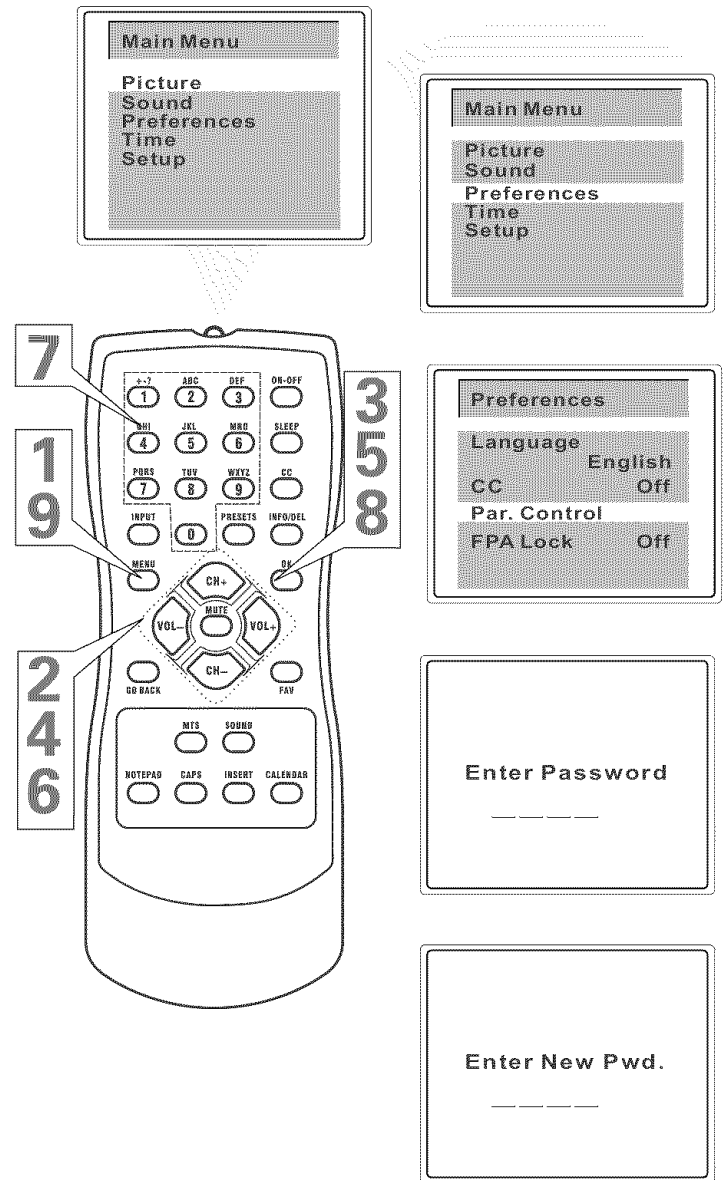

Helpful Hint

You cannot change Parental Lock settings without knowing the password.

Blocking Programming with Movie Ratings

There are two types of ratings for Parental Lock. One is based on movie industry ratings. The other is based on TV industry ratings. Both can be used to censor programming. Let's first look at the MPAA Rating options of Parental Lock.

- 1 Press **MENU** to see the main menu.
- 2 Press **CH+** or **CH-** to highlight **Preferences**.
- 3 Press **OK** to enter the **Preferences** submenu.
- 4 Press **CH+** or **CH-** repeatedly to highlight **Par. (Parental) Control**.
- 5 Press **OK** to display the password screen.
- 6 Press the **number buttons** to enter your four-digit code. The **Parental Lock** setup menu appears on the screen and the **MPAA rating** is highlighted.
- 7 Press **OK** to display **MPAA ratings** (G, PG, PG-13, R, NC-17, and X).
- 8 Press **CH+** or **CH-** to select the rating you want to block.
- 9 Press **OK** to block (or unblock) the rating. A checkmark will appear to the left of the rating when blocked. When you block a rating, higher ratings are blocked automatically. To unblock all the ratings, select **N/A**.
- 10 Press **MENU** repeatedly to exit the menu or the menu will automatically disappear within a few seconds if no buttons are pressed on the remote control.

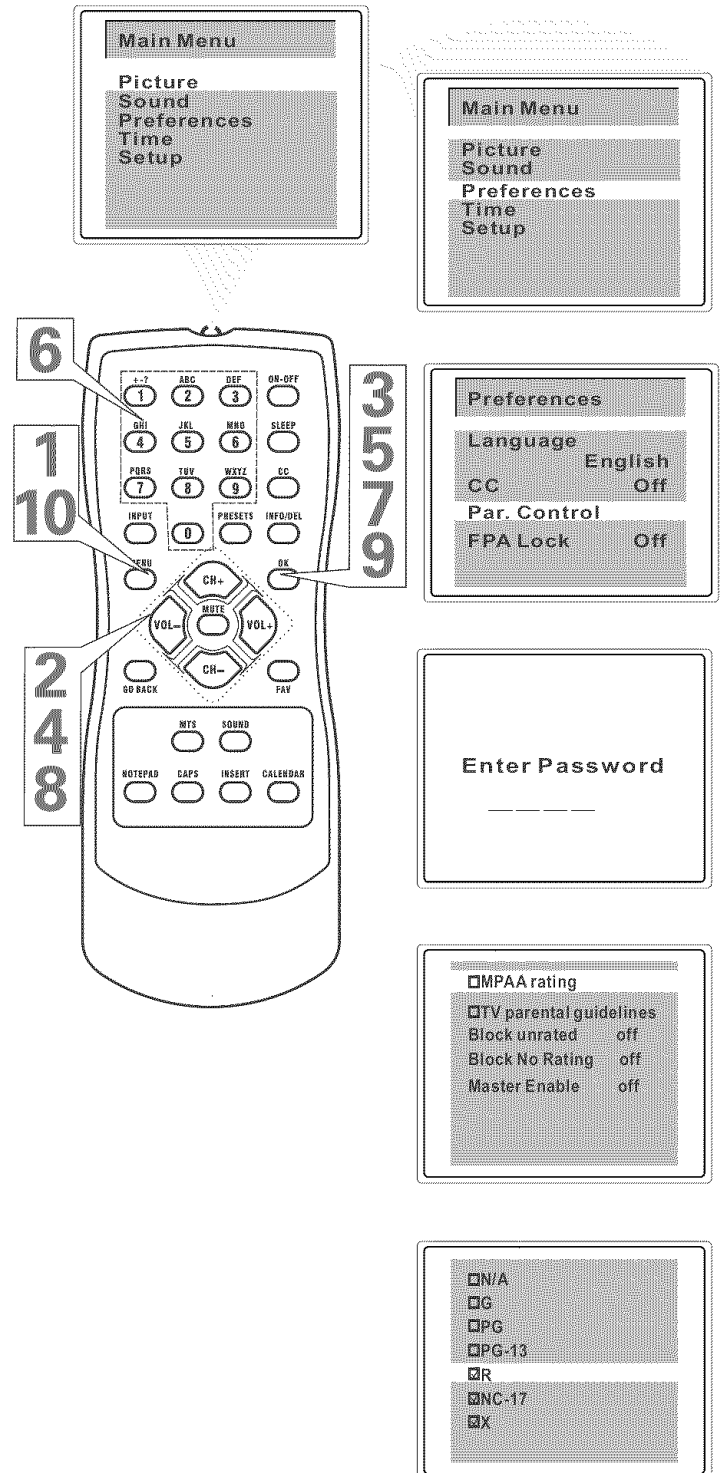

Model 20V500T: If you have this model you will not see the Sound menu option and your remote will not have MTS or SOUND buttons.

Helpful Hint

Blocking any rating (ON) will block all the higher ratings automatically. For example, if R is blocked manually, NC17 and X will be blocked automatically.

To turn a rating OFF, set each rating individually.

Blocking Programming with TV Ratings

Some program ratings are based on TV industry ratings as described below.

- 1** Press **MENU** to see the main menu.
- 2** Press **CH+** or **CH-** to highlight Preferences.
- 3** Press **OK** to enter the Preferences submenu.
- 4** Press **CH+** or **CH-** repeatedly to highlight Par. (Parental) Control.
- 5** Press **OK** to display the password screen.
- 6** Press the **number buttons** to enter your four-digit code. The Parental Lock setup menu appears on the screen.
- 7** Press **CH+** or **CH-** to highlight TV parental guidelines.
- 8** Press **OK** to display the parental guidelines (TV-Y, TV-Y7, TV-G, TV-PG, TV-14, or TV-MA).
- 9** Press **CH+** or **CH-** to select a rating.
- 10** Press **OK** to turn the rating on or off. A checkmark appears when the rating is blocked. TV-Y and TV-G can be turned on (to block viewing) or off (to allow viewing) only. TV-Y7, TV-PG, TV-14, and TV-MA can be customized to block V (violence), F (fantasy violence), S (sexual situations), L (coarse language), or D (suggestive dialog). To do so, continue with these steps.
- 11** Press **CH+** or **CH-** to highlight Content.
- 12** Press **OK** to enter the Content menu.
- 13** Press **CH+** or **CH-** to select a rating, then press **VOL+**.
- 14** Press **CH+** or **CH-** to select the sub-ratings (Fantasy-V, Violence, Sexual, Language, or Dialog), then press **OK** to block or view that sub-rating.
- 15** Press **MENU** to return to the Parental Guidelines screen and check your settings. A checkmark appears when the sub-rating is blocked.
- 16** Press **MENU** repeatedly to exit the menu or the menu will automatically disappear within a few seconds if no buttons are pressed on the remote control.

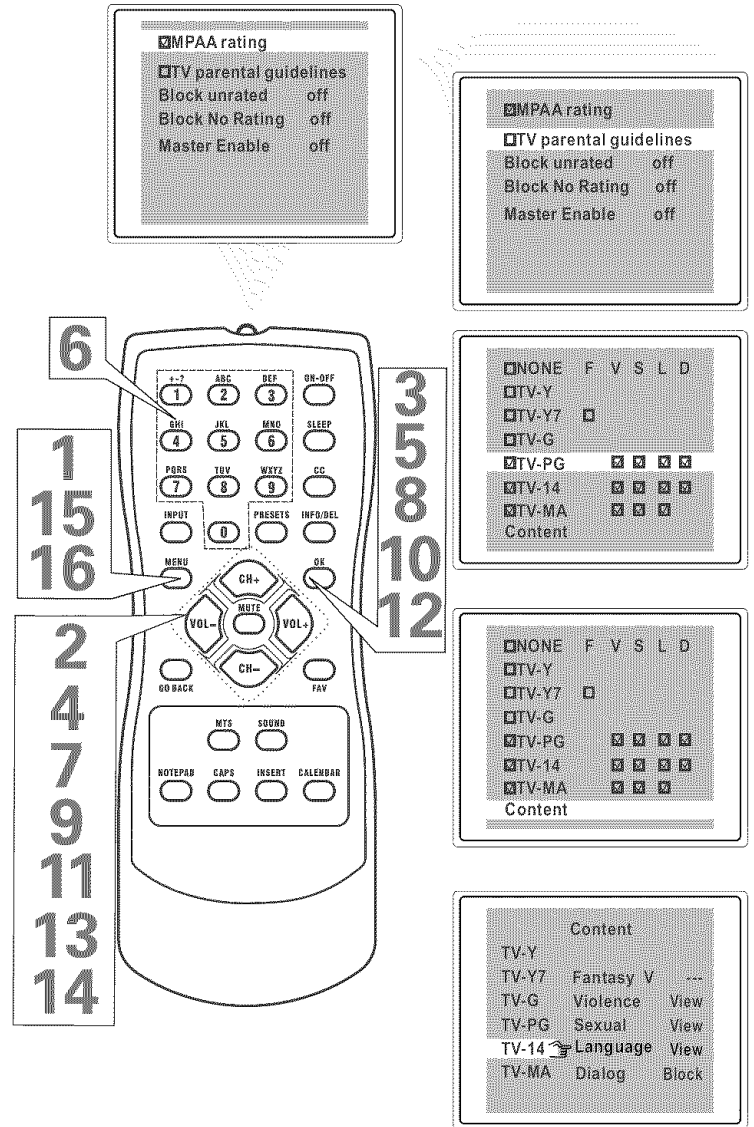

Helpful Hint

Any rating will block higher ratings automatically. To unblock all the ratings, select NONE.

Notes:

1. Blocking TV-Y, only TV-Y7 is blocked automatically.
2. Blocking TV-Y7, other ratings will not change.

Parental Lock Blocking Options

After setting your password Parental Lock also offers these special blocking options.

- 1 Press MENU to see the main menu.
- 2 Press CH+ or CH- to highlight Preferences.
- 3 Press OK to enter the Preferences submenu.
- 4 Press CH+ or CH- repeatedly to highlight Par. (Parental) Control.
- 5 Press OK to display the password screen.
- 6 Press the Number buttons to enter your four-digit code. The Parental Lock setup menu appears on the screen.
- 7 Press CH+ or CH- to select Master Enable, Block Unrated, or Block No Rating.
 - MASTER ENABLE:** this is the "master switch" for Parental Lock. When ON, all blocking/censoring you have set is enabled. When OFF, all blocking is disabled.
 - BLOCK UNRATED:** All unrated programs (based on Movie Ratings or TV Ratings) will be blocked if this feature is ON and MASTER ENABLE is ON.
 - BLOCK NO RATING:** All programming with no content advisory data will be blocked if this feature is ON and MASTER ENABLE is ON.
- 8 Press VOL+ or VOL- to turn the blocking option On or Off.
- 9 Press MENU repeatedly to exit the menu or the menu will automatically disappear within a few seconds if no buttons are pressed on the remote control.

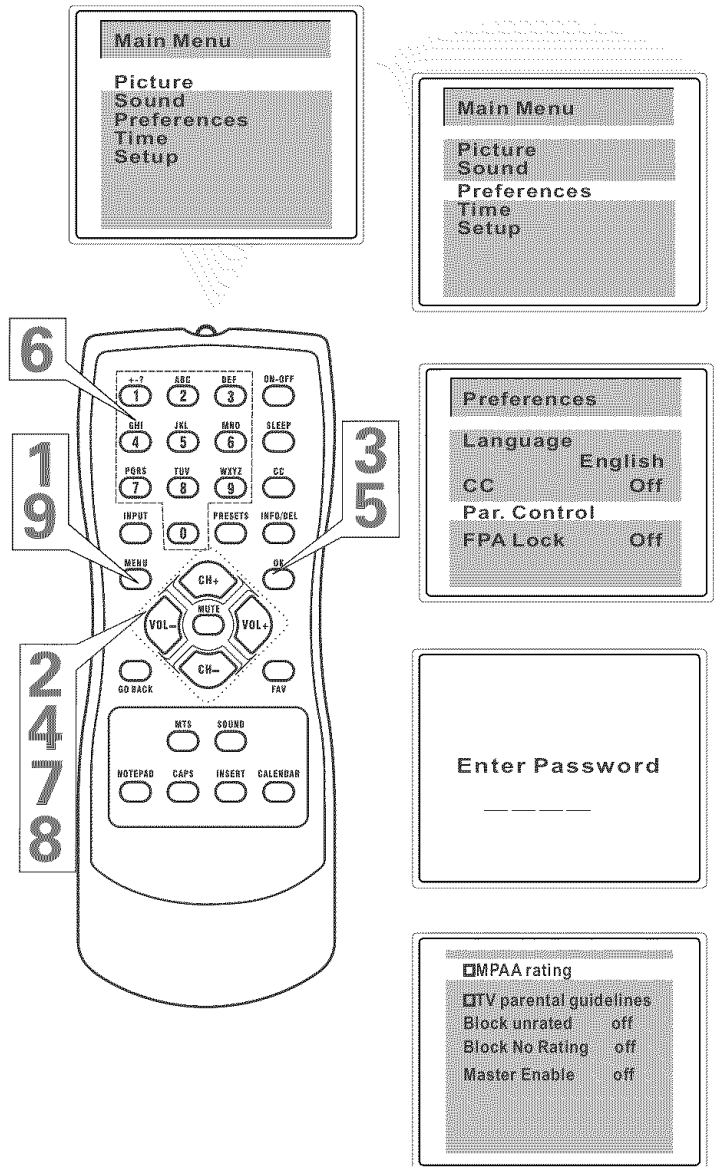

Model 20V500T: If you have this model you will not see the Sound menu option and your remote will not have MTS or SOUND buttons.

Child Lock

Child lock allows you to lock the buttons on the front panel of the TV.

- 1** Press **MENU** to see the main menu.
- 2** Press **CH+** or **CH-** to highlight Preferences.
- 3** Press **OK** to enter the Preferences submenu.
- 4** Press **CH+** or **CH-** repeatedly to highlight **FPA (Front Panel) Lock**.
- 5** Press **VOL+** or **VOL-** to turn on or off FPA Lock. Choose **On** to disable all the buttons on the front of the TV. **FPA Lock On** will appear on the TV screen each time you press the buttons on the front of the TV. You can still operate the TV with the remote control. You can still use the **POWER** button on the front of the TV, but only to turn off the TV (not on). Set FPA Lock to **Off** to cancel this feature so you can use the buttons on the front of the TV again.
- 6** Press **MENU** repeatedly to exit the menu or the menu will automatically disappear within a few seconds if no buttons are pressed on the remote control.

Model 20V500T: If you have this model you will not see the Sound menu option and your remote will not have MTS or SOUND buttons.

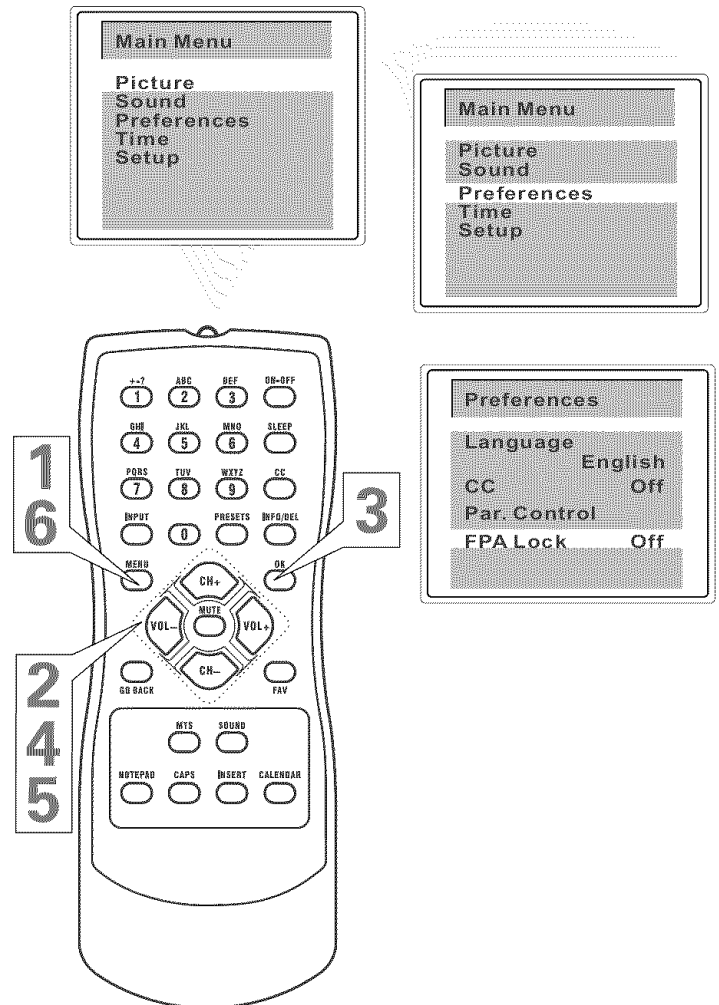

Sound Mode Selection

Model 24V511T: This feature is available with this model only. You can preset sound mode that best suits your current programming among Personal, Theater, Concert and Speech.

- 1** Press **MENU** to see the main menu.
- 2** Press **CH+** or **CH-** to highlight **Sound**.
- 3** Press **OK** to enter the **Sound** submenu.
- 4** Press **CH+** or **CH-** repeatedly to highlight **Sound Mode**.
- 5** Press **VOL+** or **VOL-** to select **Personal**, **Theater**, **Concert**, or **Speech**.
- 6** Press **MENU** repeatedly to exit the menu or the menu will automatically disappear within a few seconds if no buttons are pressed on the remote control.

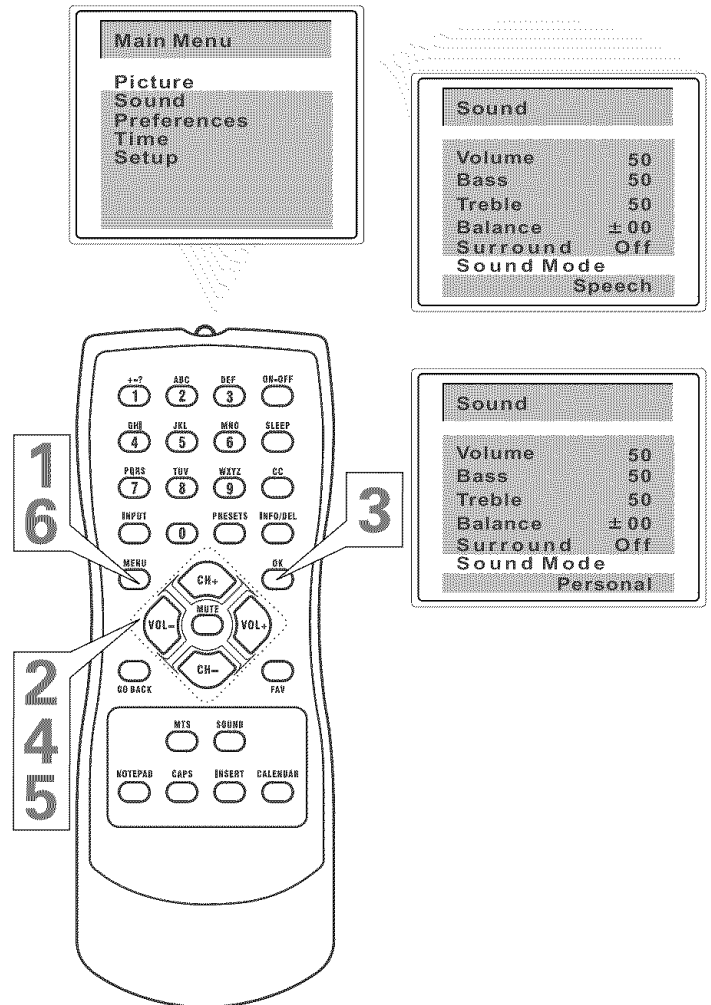

Helpful Hint

You can choose a sound mode setting quickly by pressing the **SOUND** button on the remote control.

Sound Adjustments

Model 24V511T: This feature is available with this model only. You can adjust the low frequency (Bass) or high frequency (Treble). You can also adjust the **Balance** to increase the volume of the left and right sound channels.

- 1 Press **MENU** to see the main menu.
- 2 Press **CH+** or **CH-** to highlight **Sound**.
- 3 Press **OK** to enter the **Sound** submenu.
- 4 Press **CH+** or **CH-** repeatedly to highlight **Volume**, **Bass**, **Treble** or **Balance**.
- 5 Press **VOL+** or **VOL-** to adjust the option.
- 6 Press **MENU** repeatedly to exit the menu or the menu will automatically disappear within a few seconds if no buttons are pressed on the remote control.

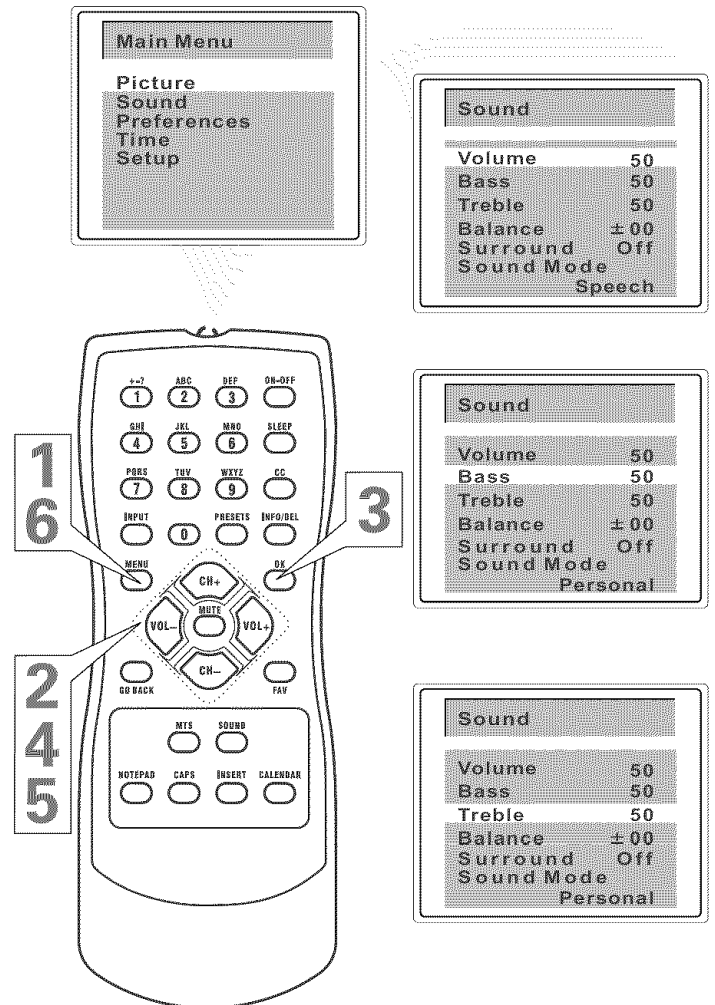

Helpful Hint

Bass: Enhances the low frequency sounds.

Treble: Enhances the high frequency sounds.

Balance: Distributes the sound between the left and right speakers of the TV.

Surround

Model 24V511T: This feature is available with this model only. When stereo signals are available, this function enhances the stereo spatial effect.

- 1** Press **MENU** to see the main menu.
- 2** Press **CH+** or **CH-** to highlight **Sound**.
- 3** Press **OK** to enter the **Sound** submenu.
- 4** Press **CH+** or **CH-** repeatedly to highlight **Surround**.
- 5** Press **VOL+** or **VOL-** to turn this option on or off.
- 6** Press **MENU** repeatedly to exit the menu or the menu will automatically disappear within a few seconds if no buttons are pressed on the remote control.

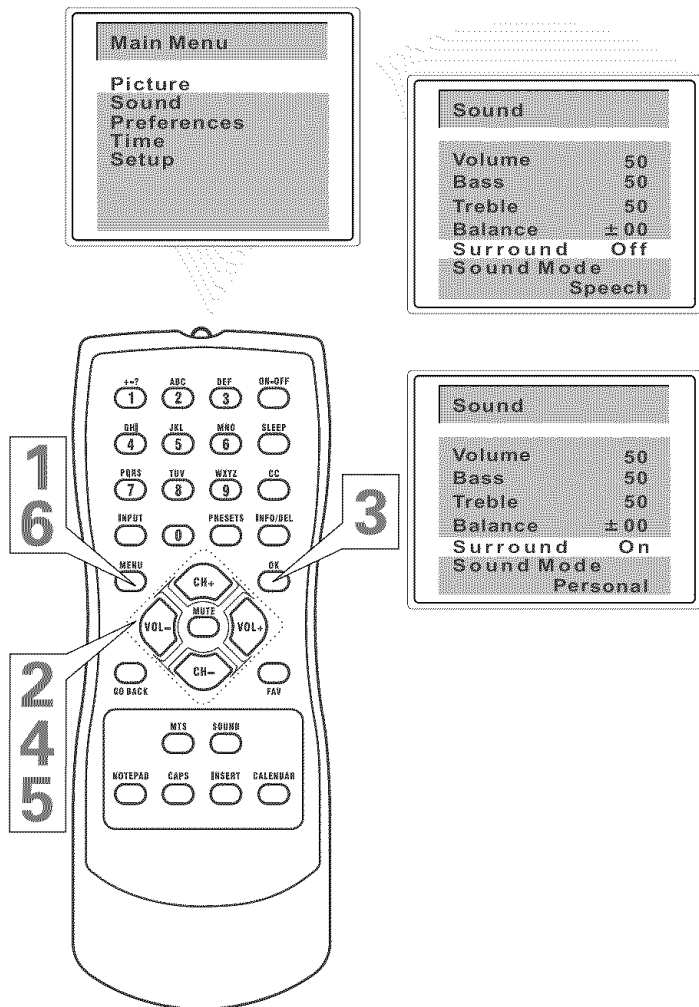

Helpful Hint

Bass: Enhances the low frequency sounds.

Treble: Enhances the high frequency sounds.

Balance: Distributes the sound between the left and right speakers of the TV.

Stereo and Second Audio Program

Model 24V511T: This feature is available with this model only. Multi-channel Sound (MTS) broadcasts enhance TV viewing by bringing you programs with high fidelity stereo sound. MTS also provides an extra channel called the Second Audio Program (SAP), which broadcasters can use to transmit a second language or for other purposes.

1 Press **MTS** on the remote control to select STEREO, MONO or SAP. All the options will be available only when the current TV channel is broadcasting that option. Channels will not always carry programs that have all the MTS options.

If STEREO appears on the screen when you select a channel, stereo broadcasting is available with the current TV program. You can hear sound from the left and right speakers of the TV.

If the broadcast is not strong or clear, stereo sound is not available. Press the MTS button to change to MONO. This should eliminate the noise.

If MONO appears on the screen when you choose a channel, Stereo is not available.

If SAP appears when you select a channel, Second Audio Program broadcasting is available for the current TV program.

Press the MTS button to choose SAP and you may hear the program in a different language or some other audio.

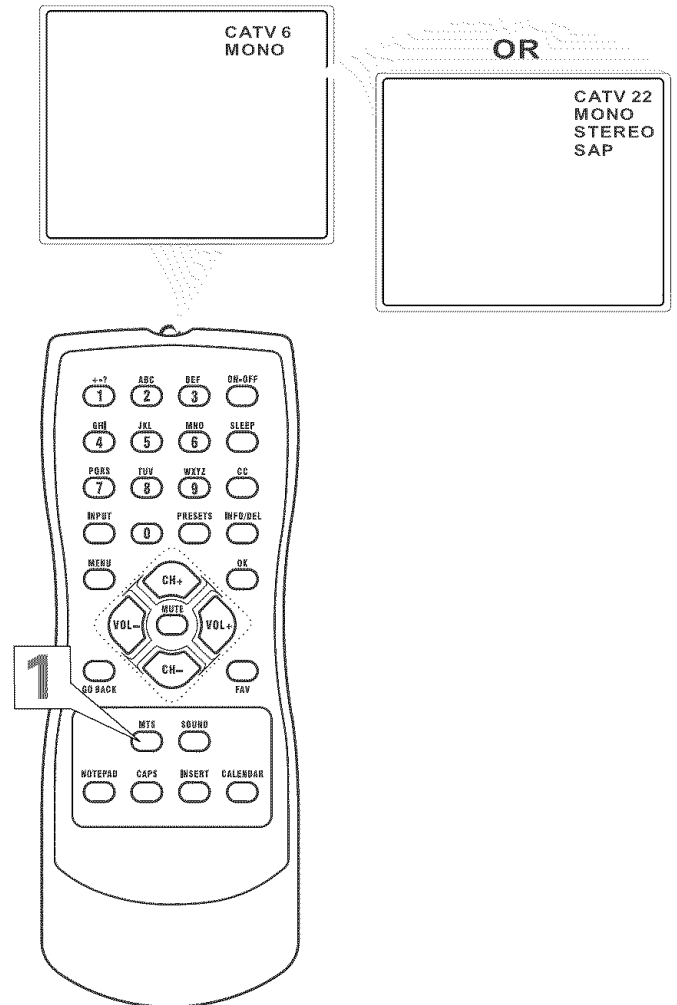







Notebook

This feature enables you to store personal messages and can be used as a reminder.

- 1** Press **NOTEPAD** to display the notebook screen.
- 2** Press **CAPS** repeatedly to toggle the entry mode between uppercase or lowercase letters.
- 3** Use **number buttons** to enter letters, numbers, or some special symbols.
- 4** Press **DEL(ETE)** to delete the unwanted text.
- 5** Press **INS(ERT)** to select **INS(ERT)** or **OVR(overwrite)** on the screen, then use number buttons to insert or overwrite the letter or number in the text.

After finishing message inputting and editing, if you want to display the message when the TV is turned on, proceed with these steps:

- 6** Press **CH+/CH-** and **VOL+/VOL-** to select .
- 7** Press **OK** to turn  into , or vice versa.
 -  If you select this icon, the notebook window with the stored message will be displayed on the screen first when the TV is turned on.
 -  If you select this icon, the notebook window with the stored message will not be displayed on the screen when the TV is turned on.

If you want to display the message at a specified time, select the icon  and proceed with these steps:

- 8** Press **CH+/CH-** and **VOL+/VOL-** to select .
- 9** Press **OK** to turn OFF into AM 12:00.
- 10** Press **CH+** or **CH-** to change the time in minutes. (Press and hold **CH+** or **CH-** to change the time quickly in 10 minute increments.) e.g. AM 7:30, it means that the notebook window with stored message will be displayed on the screen automatically at AM 7:30. If the TV is in standby mode, the TV will be turned on automatically and display the message.
- 11** Press **OK** to save the settings, and "SAVING" appears on the screen. The Notebook screen will disappear automatically.

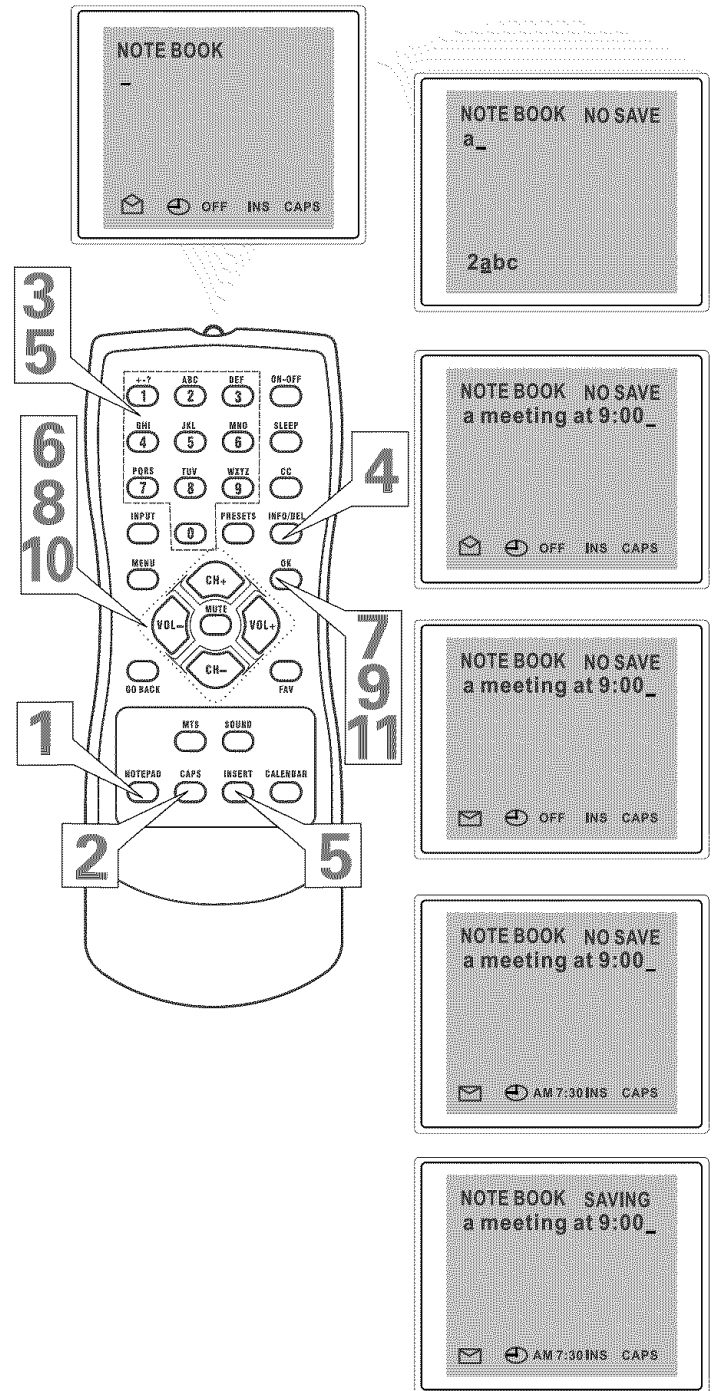

Calendar

Calendar enables you to look up the date easily.

- 1** Press **CALENDAR** to display the calendar.
- 2** Press **VOL+** or **VOL-** to display a previous or future month, e.g. MAY.
- 3** Press **CH+** or **CH-** to to display a previous or future year, e.g. 2004.
- 4** Press **MENU** repeatedly to exit the menu or the menu will automatically disappear within a few seconds if no buttons are pressed on the remote control.

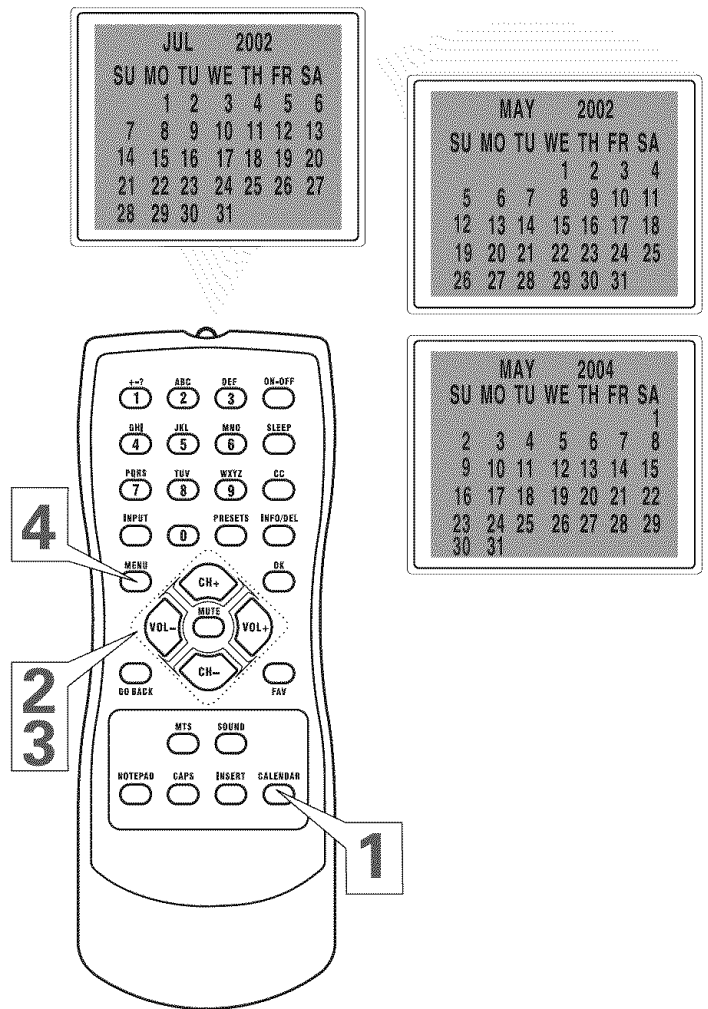

Troubleshooting

Most problems you encounter with your TV can be corrected by consulting the following troubleshooting list.

Note for U.S. customers: If you prefer, we can provide you with the name of an Authorized Service Representative who will visit your home for a fee to install your electronic entertainment system and to instruct you in its operation. For details about this service, call 1-888-206-3359. For additional assistance while using your RCA product, please visit www.rca.com/customersupport.

TV Problems

TV won't turn on

- Make sure the TV is plugged in.
- Check the wall receptacle (or extension cord) to make sure it is "live" by plugging in something else.
- Something might be wrong with your remote control. Press the **ON•OFF** button on the front of the TV. If the TV turns on, check the remote control.
- The Child Lock may be set. Go to page 28 for more information.

Buttons don't work

- The Child Lock may be set. Go to page 28 for more information.

TV turns off unexpectedly

- Sleep timer might have been activated. Go to page 22 for instructions.
- Off-Timer might have been activated. Go to page 20 for instructions.
- Electronic protection circuit may have been activated because of a power surge. If this happens frequently, the voltage in your house may be abnormally high or low.

Blank screen

- You may be on an inactive channel. Try another channel.

No sound, picture okay

- Maybe the sound is muted. Try pressing the volume up button to restore sound.
- If using S-Video remember to also connect the component's left and right audio output jacks to the TV's AUDIO jacks.

Can't select certain channel

- Channel may be blocked or not approved through Parental Controls.
- If using a VCR, check to make sure the TV/VCR button on the VCR is in the correct mode (press the TV/VCR button on your VCR).

Noisy stereo reception

- **Model 24V511T Only:** May be a weak station. Press **MTS** on the remote and choose **Mono** (instructions on page 32).

No picture, no sound but TV is on

- Maybe the signal type is set wrong. Go to the INPUT button description on page 9.

Sound okay, picture poor

- Check antenna connections. Make sure all of the cables are firmly connected to the jacks.
- Try adjusting sharpness to improve weak signals. Go to page 16 for more instructions.

Black box appears on the screen

- Closed caption might be on. Check **CC** in the **Preferences** menu. Go to page 21 for more instructions.

The Remote Control Doesn't Work

- Something might be between the remote and the remote sensor on the component. Make sure there is a clear path.
- Maybe batteries in the remote are weak, dead or installed incorrectly. Put new batteries in the remote.

Problems with Parental Controls

The rating limits don't work

- You must activate the settings. Go to the **MAIN MENU** (press **MENU** on your remote), select **Par. (Parental) Control** in the **Preferences** menu. Enter your password and turn on **Master Enable** (Go to page 27 for instructions).

I don't remember my password and I want to unlock the TV

- If you forget your password you can reset it. Make sure the TV is off. Simultaneously press the VOL+ on the remote and the CHANNEL + button on the front of the TV. The display will appear for you to enter your new password.

The Parental Controls won't let me watch a program even though it's not rated as violent.

- Maybe the movie was given an NR (Not Rated) status. Check to see if **BLOCK NO RATING** is turned on in the **Par. (Parental) Control** menu. Go to page 27 for more instructions.

I don't remember my password and I want to unlock the TV

- If you forget your password you can reset it. Simultaneously press and **VOL+** on the remote and **CHANNEL +** on the TV's front panel at the same time. **Enter New Pwd.** will appear on the screen. Go to page 24 for instructions.

Care and Cleaning

CAUTION: Turn OFF your TV before cleaning.

You can clean the TV as required, using a soft lint-free cloth. Be sure to occasionally dust the ventilation slots in the cabinet to help assure adequate ventilation.

The TV's screen may be cleaned with a soft, lint-free cloth as well. Take care not to scratch or mar the screen. If necessary, you may use a cloth dampened with warm water. Never use strong cleaning agents, such as ammonia-based cleaners, or abrasive powder. These types of cleaners will damage the TV.

While cleaning do not spray liquid directly on the screen, or allow liquid to run down the screen and inside the TV. Also, never place drinks or vases with water on top of the TV. This could increase the risk of fire or shock hazard or damage to the TV.

Caution: Using video games or any external accessory with fixed images for extended periods of time can cause them to be permanently imprinted on the picture tube (or projection TV picture tubes). ALSO, some network/program logos, phone numbers, etc. may cause similar damage. This damage is not covered by your warranty.

Limited Warranty

What your warranty covers:

- Defects in materials or workmanship.

For how long after your purchase:

- 90 days from date of purchase for labor charges.
- One year from date of purchase for parts.
- Two years from date of purchase for the picture tubes.

The warranty period for rental units begins with the first rental or 45 days from date of shipment to the rental firm, whichever comes first.

What we will do:

- Pay any Authorized RCA Television Service Center the labor charges to repair your television.
- Pay any Authorized RCA Television Service Center for the new or, at our option, refurbished replacement parts and picture tubes required to repair your television.

How you get service:

- For screen sizes of 26" and smaller: Take your RCA television to any Authorized RCA Television Service Center and pick up when repairs are complete.
- For screen sizes larger than 26": Request home or pick up, repair, and return service from any Authorized RCA Television Service Center, provided that your television is located within the geographic territory covered by an Authorized RCA Television Service Center. If not, you must take your television to the Service Center location at your own expense, or pay for the cost the Service Center may charge to transport your television to and from your home.
- To identify your nearest Authorized RCA Television Service Center, ask your dealer, visit www.rca.com, look in the Yellow Pages, or call 1-800-336-1900.
- Proof of purchase in the form of a bill of sale or receipted invoice which is evidence that the product is within the warranty period must be presented to obtain warranty service. For rental firms, proof of first rental is also required.

What your warranty does not cover:

- Customer instruction. (Your Owner's Manual describes how to install, adjust, and operate your television. Any additional information should be obtained from your dealer).
- Installation and related adjustments.
- Signal reception problems not caused by your television.
- Damage from misuse or neglect.
- Batteries.
- Customer replacement fuses.

Continued on next page

- 
- Damage from images burnt onto the screen.
 - A television that has been modified or incorporated into other products or is used for institutional or other commercial purposes.
 - A television purchased or serviced outside the U.S.A.
 - Acts of nature, such as but not limited to lightning damage.

Product registration:

- Please complete and mail the Product Registration Card packed with your TV. It will make it easier to contact you should it ever be necessary. The return of the card is not required for warranty coverage.

Limitation of Warranty:

- THE WARRANTY STATED ABOVE IS THE ONLY WARRANTY APPLICABLE TO THIS PRODUCT. ALL OTHER WARRANTIES, EXPRESS OR IMPLIED (INCLUDING ALL IMPLIED WARRANTIES OF MERCHANTABILITY OR FITNESS FOR A PARTICULAR PURPOSE) ARE HEREBY DISCLAIMED. NO VERBAL OR WRITTEN INFORMATION GIVEN BY TTE TECHNOLOGY, INC., ITS AGENTS OR EMPLOYEES SHALL CREATE A WARRANTY OR IN ANY WAY INCREASE THE SCOPE OF THIS WARRANTY.
- REPAIR OR REPLACEMENT AS PROVIDED UNDER THIS WARRANTY IS THE EXCLUSIVE REMEDY OF THE CONSUMER. TTE TECHNOLOGY, INC. SHALL NOT BE LIABLE FOR INCIDENTAL OR CONSEQUENTIAL DAMAGES RESULTING FROM THE USE OF THIS PRODUCT OR ARISING OUT OF ANY BREACH OF ANY EXPRESS OR IMPLIED WARRANTY ON THIS PRODUCT. THIS DISCLAIMER OF WARRANTIES AND LIMITED WARRANTY ARE GOVERNED BY THE LAWS OF THE STATE OF INDIANA. EXCEPT TO THE EXTENT PROHIBITED BY APPLICABLE LAW, ANY IMPLIED WARRANTY OF MERCHANTABILITY OR FITNESS FOR A PARTICULAR PURPOSE ON THIS PRODUCT IS LIMITED TO THE APPLICABLE WARRANTY PERIOD SET FORTH ABOVE.

How state law relates to this warranty:

- Some states do not allow the exclusion nor limitation of incidental or consequential damages, or limitations on how long an implied warranty lasts, so the above limitations or exclusions may not apply to you.
- This warranty gives you specific legal rights, and you also may have other rights that vary from state to state.

If you purchased your television outside the United States:

- This warranty does not apply. Contact your dealer for warranty information.

Service calls which do not involve defective materials or workmanship are not covered by this warranty. Costs of such service calls are the sole responsibility of the purchaser.

Visit the RCA website at www.rca.com

Please do not send any products to the Indianapolis address listed in this manual or on the carton. This will only add delays in service for your product.

TTE Technology, Inc.

10330 North Meridian Street

Indianapolis, IN 46290

©2004 TTE Technology, Inc.

RCA and the RCA logos are trademarks of THOMSON S.A. used under license to TTE Technology, Inc.

Printed in China

TOCOM 1641305A