

Memorex®

Is it live or is it Memorex?™

MVD1402

User's Guide

14" COLOR TV WITH DVD PLAYER

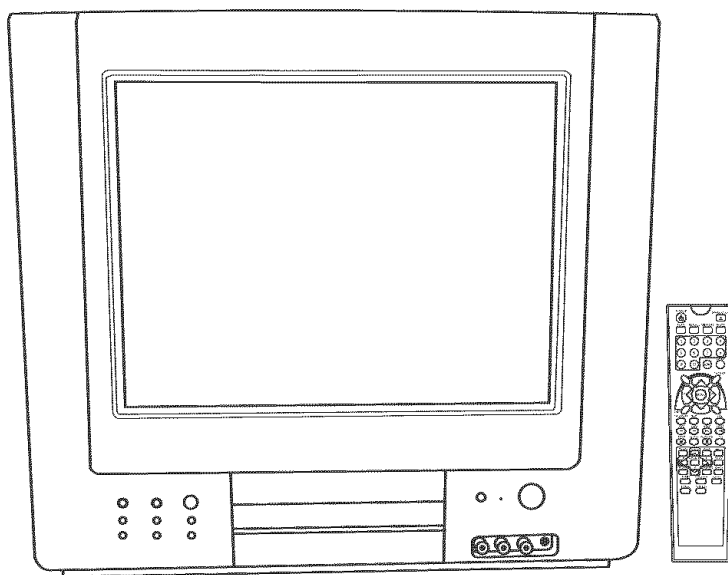

Before operating this product,
please read these instructions completely.

CONTENTS

Contents	1	• P. STD (Picture Standard)	34
Important Safety Instructions	2	• Headphone Jack	34
Precautions	5	• Calendar	35
Power Source	5	• Time	35
Location of Controls	6	• Volume Buttons	35
• Front	6	TV Basic Operation	36
• Rear Panel	6	• Scan	37
• Remote	7	• Recall	37
Remote Control	8	Closed Captions	38
• Battery Installation	8	DVD Basic Operation	39
• Effective Distance of the Remote Control Transmitter	8	• Audio Mode	39
Antenna Connections	9	• DVD Call Button	39
Connection Using the Front A/V In Jacks	9	• Mute	39
Cable (CATV)/Satellite Connections	10	• Playback of a DVD	40
Connection from an External Unit	11	• Skip	41
• Connection Using Coaxial Cable	11	• Fast Search	41
• Connection Using A/V Cables	11	• Slow	41
• Connection Using the Component Y/PB/PR Jacks	12	• Pause/Step	41
Connection to an External Unit	12	• Title/Chapter Search	42
• Connection Using the A/V Out Jacks	12	• Title/Chapter/Time Search	42
• Connection Using the Coaxial Jack	13	• Repeat Playback	42
About Discs	14	• A-B Repeat Playback	42
Setting the TV Menus	16	• Audio Language	43
• Video Setup Menu	16	• Subtitle Menu	43
• Audio Setup Menu	16	• DVD Menu	43
• Timer Setup Menu	17	• Title Menu	43
• Setting the On Timer	18	• Zoom In	43
• Setting the Off Timer	19	• Angle	43
• Setting the Sleep Timer	19	• Programmed Playback	44
• Setting the Remind Timer	20	CD/VCD BASIC OPERATION	45
• Setup Menu	21	• Playback of a CD/VCD	45
• Channel Setup Menu	24	• Selecting tracks using the Skip (⏮) or (⏭) Button (For VCD ONLY)	45
• Setting Channels into Memory	25	• Selecting track using the Number Buttons	45
• Adding and Deleting Channels	26	• Selecting Tracks Using The Navigation Buttons (For CD ONLY)	45
• Calendar Setup Menu	27	• Forward/Reverse	46
TV Parental Control	28	• Play a Single Track/Repeat Play	46
• Parental Control Setup	28	• Repeat A-B Play	46
• TV Rating Setup	29	• PBC (VCD Only)	46
• MPAA Rating Setup	30	• Audio	46
• Lock Menu	31	• Programmed Playback(VCD Only)	47
DVD Setup Menus	32	PICTURE CD BASIC OPERATION	48
• General Setup Menu	32	Troubleshooting Guide	49
• Parental	33	Care and Maintenance	51
Basic Operation	34	Specifications	52
• Display	34		
• Mute	34		
• TV/AV	34		
• TV/DVD	34		

IMPORTANT SAFETY INSTRUCTIONS



CAUTION

**RISK OF ELECTRIC SHOCK
DO NOT OPEN**



The lightning flash with arrowhead symbol within an equilateral triangle is intended to alert the user to the presence of uninsulated dangerous voltage within the product's enclosure that may be of sufficient magnitude to constitute a risk of electric shock to persons.



The exclamation point within an equilateral triangle is intended to alert the user to the presence of important operating and maintenance (servicing) instructions in the literature accompanying the appliance.

CAUTION: TO REDUCE THE RISK OF ELECTRIC SHOCK, DO NOT REMOVE COVER (OR BACK). NO USER-SERVICEABLE PARTS INSIDE. REFER SERVICING TO QUALIFIED SERVICE PERSONNEL.

This Caution Marking was located at the rear enclosure of the apparatus.



DANGER:

Invisible and hazardous laser radiation when open and interlock failed or defeated. Avoid direct exposure to beam.

CAUTION:

THIS DIGITAL VIDEO DISC PLAYER EMPLOYS A LASER SYSTEM.

TO ENSURE PROPER USE OF THIS PRODUCT, PLEASE READ THIS OWNER'S MANUAL CAREFULLY AND RETAIN FOR FUTURE REFERENCE. SHOULD THE UNIT REQUIRE MAINTENANCE, CONTACT AN AUTHORIZED SERVICE LOCATION-SEE SERVICE PROCEDURE.

USE OF CONTROLS, ADJUSTMENTS OR THE PERFORMANCE OF PROCEDURES OTHER THAN THOSE SPECIFIED HEREIN MAY RESULT IN HAZARDOUS RADIATION EXPOSURE.

TO PREVENT DIRECT EXPOSURE TO LASER BEAM, DO NOT TRY TO OPEN THE ENCLOSURE. VISIBLE LASER RADIATION MAY BE PRESENT WHEN THE ENCLOSURE IS OPENED. DO NOT STARE INTO BEAM.

WARNING:

TO REDUCE THE RISK OF FIRE OR ELECTRIC SHOCK, DO NOT EXPOSE THIS PRODUCT TO RAIN OR MOISTURE.

WARNING:

TO REDUCE THE RISK OF FIRE OR ELECTRIC SHOCK, AND ANNOYING INTERFERENCE, USE THE RECOMMENDED ACCESSORIES ONLY.

SURGE PROTECTORS:

It is recommended to use a surge protector for AC connection. Lightning and power surges ARE NOT covered under warranty for this product.



The symbol for class II
(Double Insulation)

FCC NOTICE:

This equipment has been tested and found to comply with the limits for a Class B digital device, pursuant to part 15 of the FCC Rules. These limits are designed to provide reasonable protection against harmful interference in a residential installation. This equipment generates, uses and can radiate radio frequency energy and, if not installed and used in accordance with the instructions, may cause harmful interference to radio communications.

However, there is no guarantee that interference will not occur in a particular installation. If this equipment does cause harmful interference to radio or television reception, which can be determined by turning the equipment off and on, the user is encouraged to try to correct the interference by one or more of the following measures:

- Reorient or relocate the receiving antenna.
- Increase the separation between the equipment and receiver.
- Connect the equipment into an outlet on a circuit different from that to which the receiver is connected.
- Consult the dealer or an experienced radio/TV technician for help.

FCC WARNING:

To assure continued compliance, follow the attached installation instructions and use only shielded cables when connecting to other devices. Modifications not authorized by the manufacturer may void user's authority to operate this device.

ATTENTION:

POUR ÉVITER LES CHOC ÉLECTRIQUES, INTRODUIRE LA LAME LA PLUS LARGE DE LA FICHE DANS LA BORNE CORRESPONDANTE DE LA PRISES ET POUSSER JUSQU'AU FOND.

Manufactured under license from Dolby Laboratories.
"Dolby" and the double-D symbol are trademarks of Dolby Laboratories.

IMPORTANT SAFETY INSTRUCTIONS (CONTINUED)

Before using the unit, be sure to read all operating instructions carefully. Please note that these are general precautions and may not pertain to your unit. For example, this unit may not have the capability to be connected to an outdoor antenna.

1. READ INSTRUCTIONS

All the safety and operating instructions should be read before the product is operated.

2. RETAIN INSTRUCTIONS

The safety and operating instructions should be retained for future reference.

3. HEED WARNINGS

All warnings on the product and in the operating instructions should be adhered to.

4. FOLLOW INSTRUCTIONS

All operating and use instructions should be followed.

5. CLEANING

Unplug this product from the wall outlet before cleaning. Do not use liquid cleaners or aerosol cleaners. Use a dry cloth for cleaning.

6. ATTACHMENTS

Do not use attachments not recommended by the product's manufacturer as they may cause hazards.

7. WATER AND MOISTURE

Do not use this product near water—for example: near a bathtub, washbowl, kitchen sink or laundry tub; in a wet basement; or near a swimming pool.

8. ACCESSORIES

Do not place this product on an unstable cart, stand, tripod, bracket or table. The product may fall, causing serious injury and serious damage to the product. Use only with a cart, stand, tripod, bracket or table recommended by the manufacturer or sold with the product. Any mounting of the product should follow the manufacturer's instructions, and should use a mounting accessory recommended by the manufacturer.

8A. An appliance and cart combination should be moved with care. Quick stops, excessive force and uneven surfaces may cause the appliance and cart combination to overturn.

9. VENTILATION

Slots and openings in the cabinet and in the back or bottom are provided for ventilation, to ensure reliable operation of the product and to protect it from overheating. These openings must not be blocked or covered. The openings should never be blocked by placing the product on a bed, sofa, rug or other similar surface. This product should never be placed near or over a radiator or heat source. This product should not be placed in a built-in installation such as a bookcase or rack unless proper ventilation is provided or the manufacturer's instructions have been adhered to.

10. POWER SOURCES

This product should be operated only from the type of power source indicated on the marking label. If you are not sure of the type of power supply to your home, consult your appliance dealer or local power company. For products intended to operate from battery power, or other sources, refer to the operating instructions.

11. GROUNDING OR POLARIZATION

This product is equipped with a polarized alternating-current line plug (a plug having one blade wider than the other). This plug will fit into the power outlet only one way. This is a safety feature. If you are unable to insert the plug fully into the outlet, try reversing the plug. If the plug should still fail to fit, contact your electrician to replace your obsolete outlet. Do not defeat the safety purpose of the polarized plug.

12. POWER-CORD PROTECTION

Power-supply cords should be routed so that they are not likely to be walked on or pinched by items placed upon or against them, paying particular attention to cords at plugs, convenience receptacles, and the point where they exit from the appliance.

13. LIGHTNING

To protect your product from a lightning storm, or when it is left unattended and unused for long periods of time, unplug it from the wall outlet and disconnect the antenna or cable system. This will prevent damage to the product due to lightning and power-line surges.

14. POWER LINES

An outside antenna system should not be located in the vicinity of overhead power lines or other electric light or power circuits, or where it can fall into such power lines or circuits. When installing an outside antenna system, extreme care should be taken to keep from touching such power lines or circuits as contact with them might be fatal.

15. OVERLOADING

Do not overload wall outlets and extension cords as this can result in a risk of fire or electric shock.

16. OBJECT AND LIQUID ENTRY

Never push objects of any kind into this product through openings as they may touch dangerous voltage points or short out parts that could result in fire or electric shock. Never spill or spray any type of liquid on the product.

PORTABLE CART WARNING
(symbol provided by RETAC)



S3126A

IMPORTANT SAFETY INSTRUCTIONS (CONTINUED)

17. OUTDOOR ANTENNA GROUNDING

If an outside antenna is connected to the product, be sure the antenna system is grounded so as to provide some protection against voltage surges and built-up static charges. Section 810 of the National Electric Code, ANSI/NFPA 70, provides information with respect to proper grounding of the mast and supporting structure, grounding of the lead-in wire to an antenna discharge product, size of grounding conductors, location of antenna discharge product, connection to grounding electrodes and requirements for grounding electrodes.

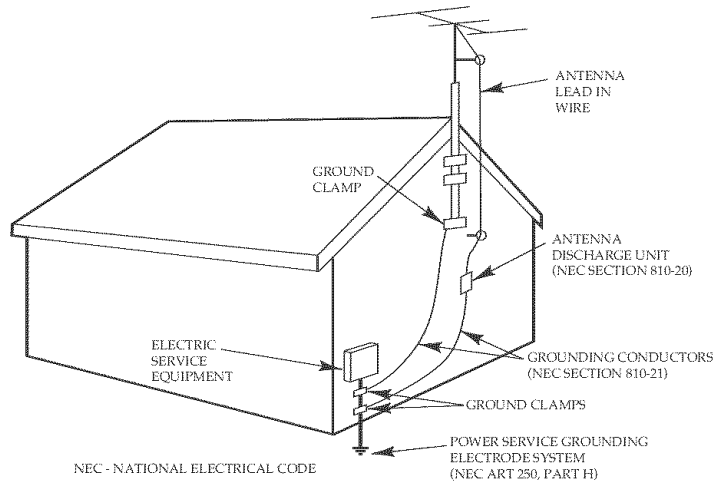

EXAMPLE OF ANTENNA GROUNDING AS PER NATIONAL ELECTRICAL CODE

18. SERVICING

Do not attempt to service this product yourself as opening or removing covers may expose you to dangerous voltage or other hazards. Refer all servicing to qualified service personnel.

19. REPLACEMENT PARTS

When replacement parts are required, be sure the service technician uses replacement parts specified by the manufacturer or those that have the same characteristics as the original part. Unauthorized substitutions may result in fire, electric shock or other hazards.

20. SAFETY CHECK

Upon completion of any service or repairs to this product, ask the service technician to perform safety checks to determine that the product is in proper operating condition.

21. WALL OR CEILING MOUNTING

The product should be mounted to a wall or ceiling only as recommended by the manufacturer.

22. DAMAGE REQUIRING SERVICE

Unplug the product from the wall outlet and refer servicing to qualified service personnel under the following conditions:

- When the power-supply cord or plug is damaged.
- If liquid has been spilled or objects have fallen into the product.
- If the product has been exposed to rain or water.
- If the product does not operate normally by following the operating instructions. Adjust only those controls that are covered by the operating instructions, as an adjustment of other controls may result in damage and will often require extensive work by a qualified technician to restore the product to its normal operation.
- If the product has been dropped or the cabinet has been damaged.
- When the product exhibits a distinct change in performance—this indicates a need for service.

23. HEAT

The product should be situated away from heat sources such as radiators, heat registers, stoves or other products (including amplifiers) that produce heat.

24. NOTE TO CATV SYSTEM INSTALLER

This reminder is provided to call the CATV system installer's attention to Article 820-40 of the NEC that provides guidelines for proper grounding and, in particular, specifies that the cable ground shall be connected to the grounding system of the building, as close to the point of cable entry as practical.

PRECAUTIONS

NOTES ON HANDLING:

- When shipping this unit, always use the original shipping carton and packing materials. For maximum protection, repack the unit as it was originally packed at the factory.
- Do not use volatile liquids, such as insect spray, near the player. Do not leave rubber or plastic products in contact with the DVD player for a long time. They will leave marks on the finish.
- The top and rear panels of the player may become warm after a long period of use. This is normal and not a malfunction.
- When the player is not in use, be sure to remove the disc and turn off the power.
- If you do not use the player for a long period, the unit may not function properly in the future. Turn on and use the player occasionally.

NOTES ON LOCATING THE DVD PLAYER:

- When you place this player near another TV, radio or VCR, the playback picture may become poor and the sound may be distorted. In this case, move the player away from the TV, radio or VCR.

NOTES ON CLEANING:

Use a soft, dry cloth for cleaning.

- For stubborn dirt, soak the cloth in a weak detergent solution, wring well and wipe. Use a dry cloth to wipe it dry. Do not use any type of solvent, such as thinner and benzene, as they may damage the surface of the player.
- If you use a chemical-saturated cloth to clean the unit, follow that product's instructions.

Warning: Cleaning and adjustment of lenses and/or other components of playback mechanism should be performed by a qualified service technician.

TO OBTAIN A CLEAR PICTURE:

The DVD player is a high technology, precision device. If the optical pick-up lens and disc drive parts are dirty or worn down, the picture quality becomes poor. To obtain a clear picture, we recommend regular inspection and maintenance (cleaning or parts replacement) every 1,000 hours of use depending on the operating environment. For details, contact your nearest dealer.

NOTES ON MOISTURE CONDENSATION:

Moisture condensation damages the DVD player. Please read the following carefully.

- Moisture condensation occurs, for example, when you pour a cold drink into a glass on a warm day. Drops of water form on the outside of the glass. In the same way, moisture may condense on the optical pick-up lens inside this unit, one of the most crucial internal parts of the DVD player.

Moisture condensation occurs during the following cases:

- When you bring the DVD player directly from a cold place to a warm place.
- When you use the DVD player in a room where you just turned on the heater, or a place where the cold wind from the air conditioner directly hits the unit.
- In summer, when you use the DVD player in a hot and humid place just after you moved the unit from an air conditioned room.
- When you use the DVD player in a humid place.

Do not use the DVD player when moisture condensation may occur.

- If you use the DVD player in such a situation, it may damage discs and internal parts. Remove the disc, connect the power cord of the DVD player to the wall outlet, turn on the DVD player and leave it "ON" for two or three hours. After two or three hours, the DVD player will have warmed up and evaporated any moisture. Keep the DVD player connected to the wall outlet and moisture condensation will seldom occur.

POWER SOURCE

Insert the AC plug (with the 2 blades) into a conveniently located AC outlet having 120V, 60Hz.

NOTE: The AC plug supplied with the unit is polarized to help minimize the possibility of electric shock. If the AC plug does not fit into a nonpolarized AC outlet, do not file or cut the wide blade. It is the user's responsibility to have an electrician replace the obsolete outlet.

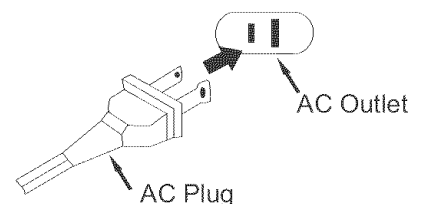

LOCATION OF CONTROLS

FRONT

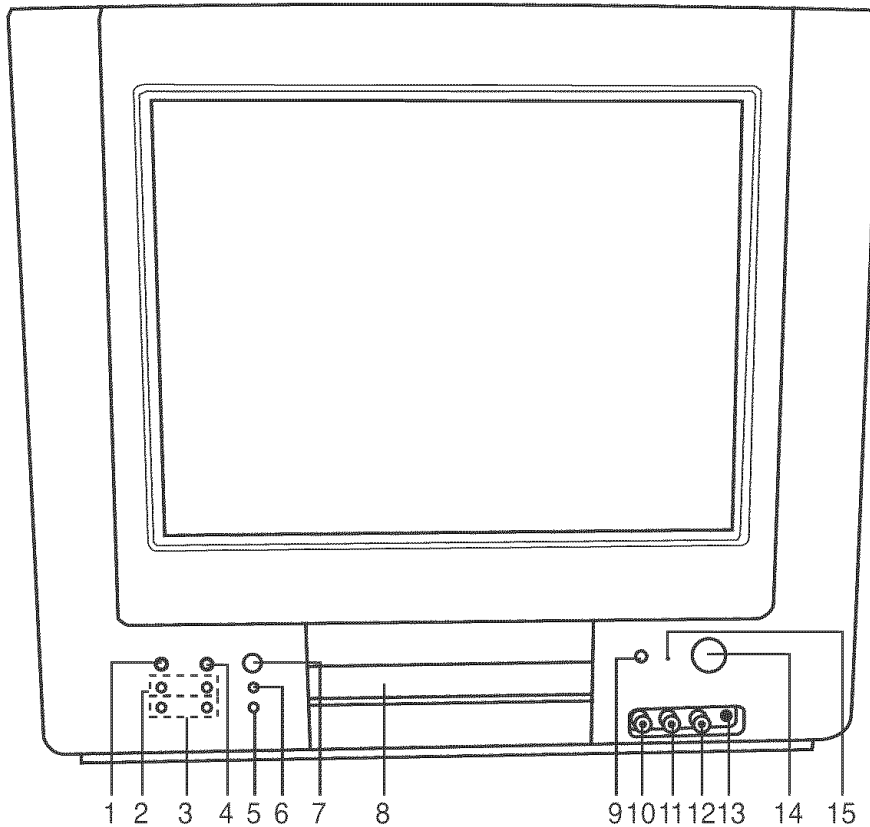

FRONT

1. TV/DVD Button
2. Channel +/- Buttons
3. Volume +/- Buttons
4. STOP Button
5. DVD Tray OPEN/CLOSE Button
6. MENU Button
7. PLAY Button
8. Disc Tray
9. Remote Sensor
10. AUDIO 1 Right IN Jack
11. AUDIO 1 Left (Mono) IN Jack
12. VIDEO 1 IN Jack
13. Headphone Jack
14. POWER Button
15. POWER Indicator

REAR PANEL

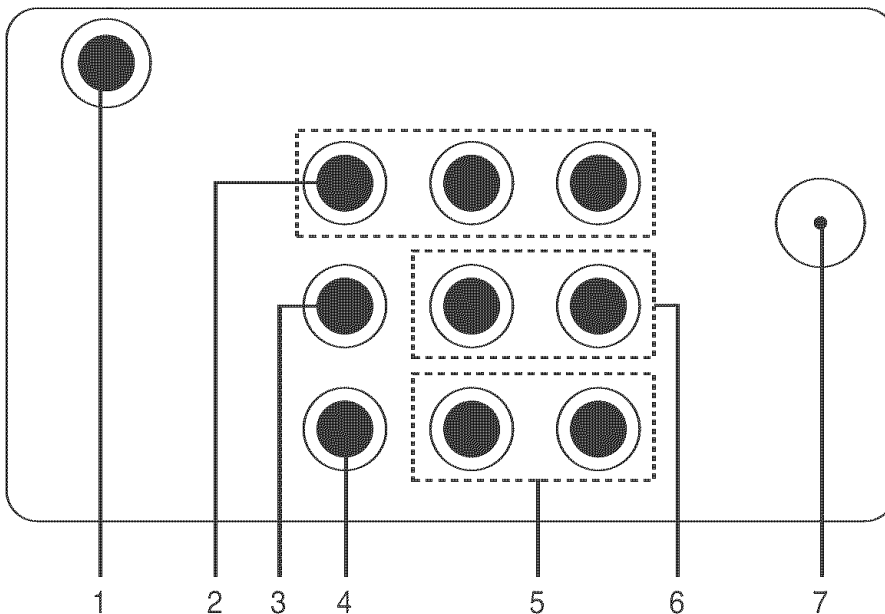

REAR

1. COAXIAL Output Jack
2. COMPONENT IN Jacks (Y/CB/CR)
3. VIDEO Output Jack
4. VIDEO 2 IN Jack
5. Stereo AUDIO 2 Left/Right IN Jacks
6. AUDIO OUT Jacks
7. TV Antenna Jack

LOCATION OF CONTROLS (CONTINUED)

REMOTE

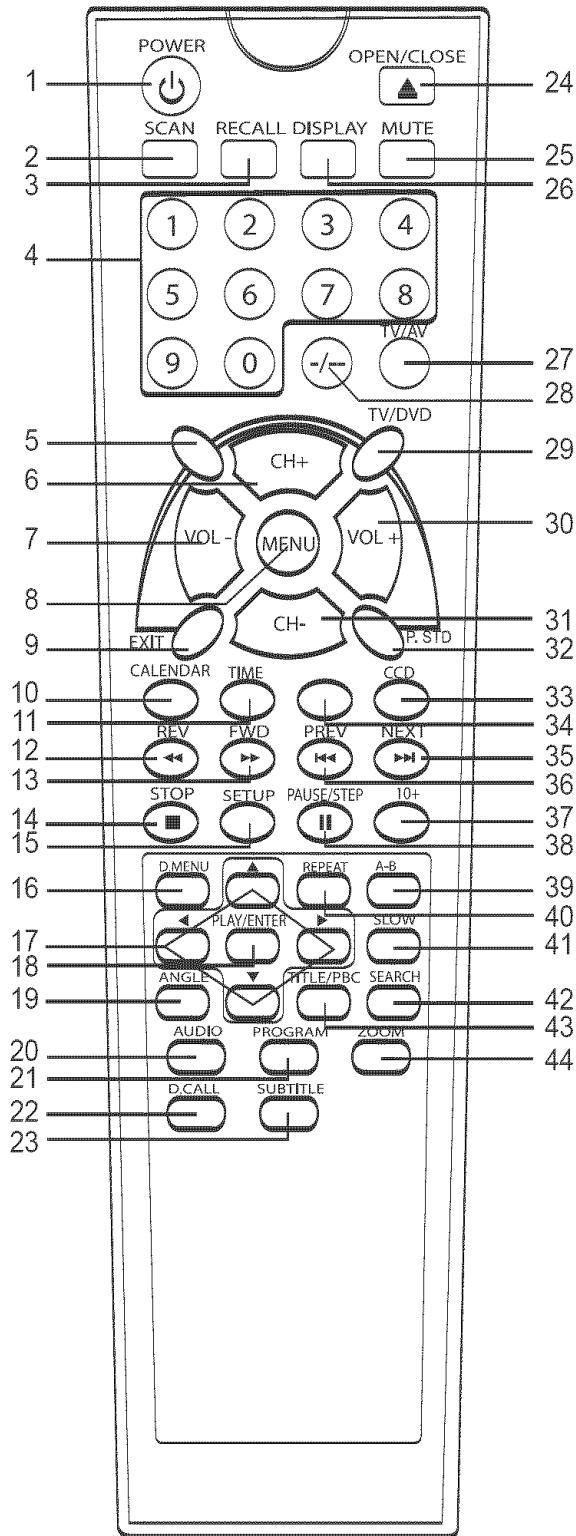

1. POWER Button
2. SCAN Button
3. RECALL Button
4. Direct Channel Selection/Number (0-9) buttons
5. Not Used
6. Channel + Button
7. Volume - Button
8. MENU Button
9. EXIT Button
10. CALENDAR Button
11. TIME Button
12. REV ◀◀ Button
13. FWD ▶▶ Button
14. STOP (■) Button
15. SETUP Button
16. D. MENU (DVD Menu) Button
17. Navigation (◀, ▶, ▲, ▼) Buttons
18. PLAY/ENTER Button
19. ANGLE Button
20. AUDIO Button
21. PROGRAM Button
22. DVD CALL Button
23. SUBTITLE Button
24. DVD Tray OPEN/CLOSE Button
25. MUTE Button
26. DISPLAY Button
27. TV/AV Button
28. -/-- Button
29. TV/DVD Button
30. Volume + Button
31. Channel - Button
32. P. STD (Picture) Button
33. CCD Button
34. Not Used
35. SKIP (▶▶) Button
36. SKIP (◀◀) Button
37. 10+ Button
38. PAUSE/STEP Button
39. Repeat A-B Button
40. REPEAT Button
41. SLOW Button
42. SEARCH Button
43. TITLE/PBC Button
44. ZOOM Button

NOTE: When setting the TV Menus, the Channel +/- buttons are used as Navigation UP/DOWN and the Volume +/- buttons are used as Navigation Right/Left..

REMOTE CONTROL

BATTERY INSTALLATION

1. Remove the battery compartment cover by pushing in on the tab and lifting the compartment off.
2. Install two (2) "AAA" batteries (not included), paying attention to the polarity diagram in the battery compartment.
3. Replace the battery compartment cover.

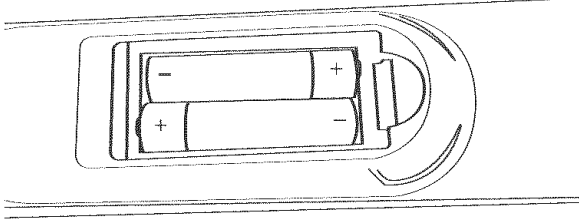

BATTERY PRECAUTIONS

Follow these precautions when using batteries in this device:

1. Use only the size and type of batteries specified.
2. Be sure to follow the correct polarity when installing the batteries as indicated next to the battery compartment. Reversed batteries may cause damage to the device.
3. Do not mix different types of batteries together (e.g. Alkaline, Rechargeable and Carbon-zinc) or old batteries with fresh ones.
4. If the device is not to be used for a long period of time, remove the batteries to prevent damage or injury from possible battery leakage.
5. Do not try to recharge batteries not intended to be recharged; they can overheat and rupture. (Follow battery manufacturer's directions.)

EFFECTIVE DISTANCE OF THE REMOTE CONTROL TRANSMITTER

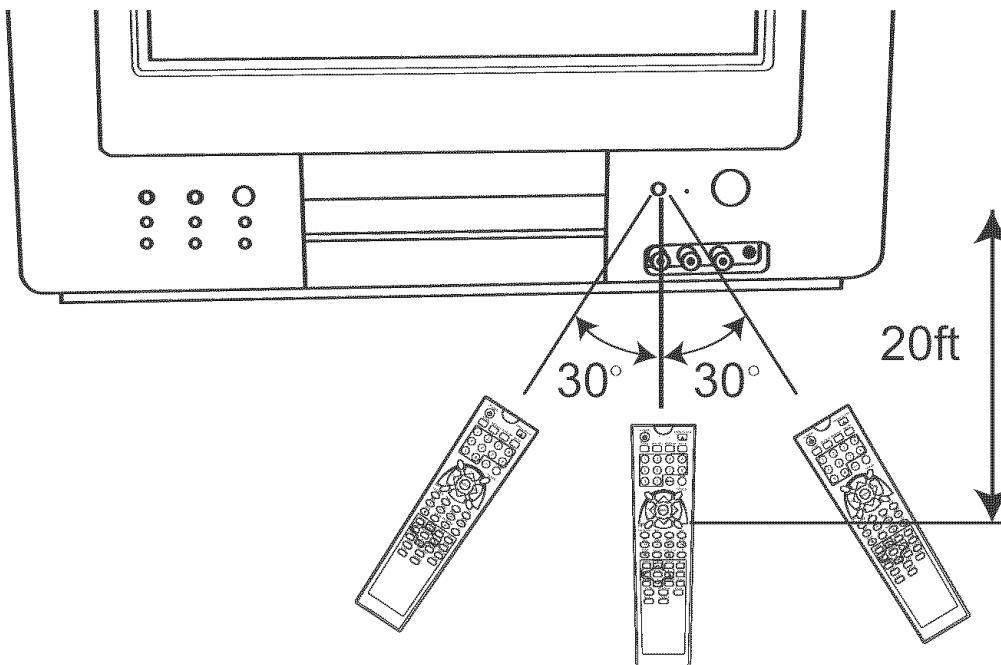

NOTES:

- When there is an obstacle between the unit and the transmitter, the transmitter may not operate.
- When direct sunlight, an incandescent lamp, fluorescent lamp or any other strong light shines on the REMOTE SENSOR of the unit, the remote operation may be unstable.

ANTENNA CONNECTIONS

OUTDOOR VHF/UHF ANTENNA CONNECTION (ANTENNA NOT INCLUDED)

Follow the instructions for the type of antenna system you intend to use. If using Cable or satellite, see the next page.

Combination VHF/UHF Antenna (Single 75 ohm cable or 300 ohm twin-lead wire)

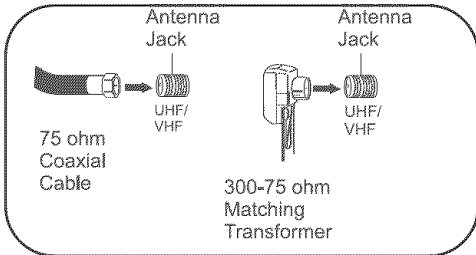

Connect the 75 ohm cable from combination VHF/UHF antenna to the antenna jack.

OR

If your combination antenna has a 300 ohm twin-lead wire, use a 300-75 ohm matching transformer (NOT SUPPLIED).

Combination VHF/UHF Antenna (Separate VHF and UHF 300 ohm twin-leads)

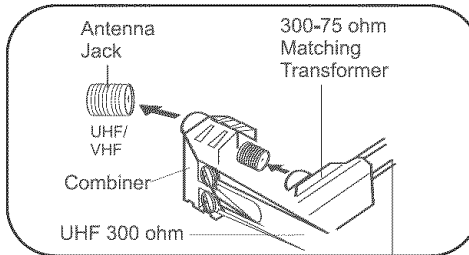

Connect the UHF twin-lead wire to a combiner (NOT SUPPLIED). Connect the VHF twin-lead to a 300-75 ohm matching transformer (NOT SUPPLIED). Attach the transformer to the combiner. Attach the combiner to the antenna jack.

Separate VHF/UHF Antennas

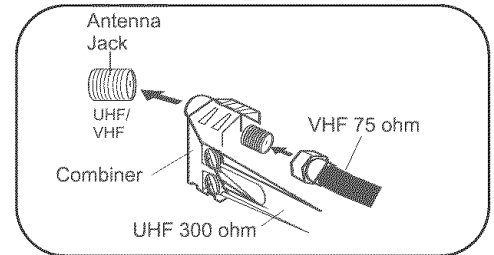

Connect the 75 ohm cable from the VHF antenna and the UHF antenna twin-lead wire to a combiner (NOT SUPPLIED). Attach the combiner to the antenna jack. **NOTE:** If your VHF antenna has a twin-lead wire, use a 300-75 ohm matching transformer, then connect the transformer to the combiner.

CONNECTION USING THE FRONT AUDIO/VIDEO IN JACKS

The optimal use for the front A/V jacks are to connect an A/V component that is used only occasionally, such as a camcorder or video game. Connect the Audio/Video output jacks of the external unit to the Audio Input jacks and the Video Input jack.

To access the unit connected to these jacks, press the TV/AV button so VIDEO1 appears on the screen. To resume normal TV viewing, simply press the TV/AV button again.

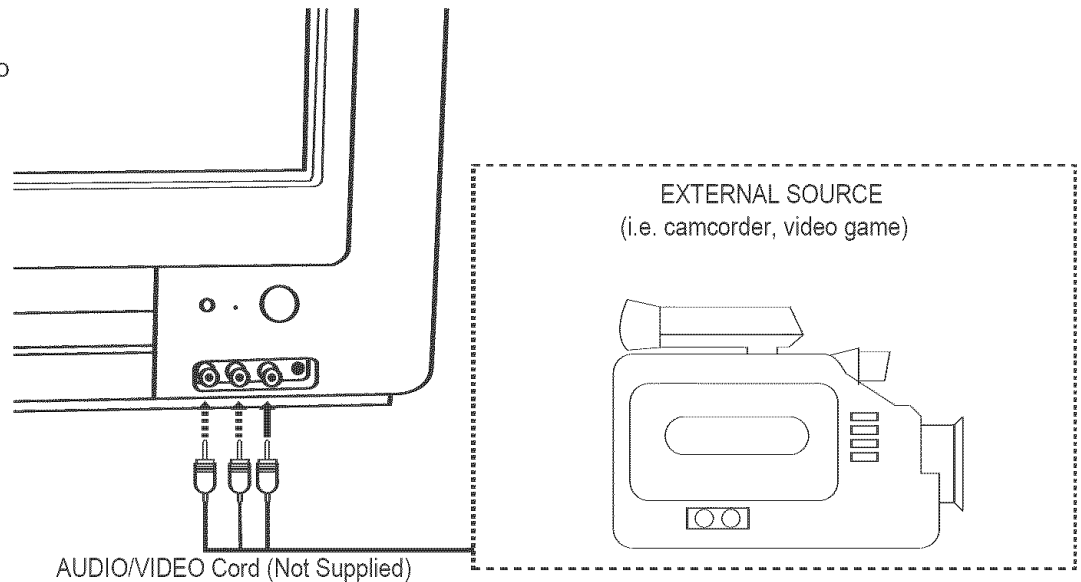

FAQs:

My external unit has only 1 audio jack, but this unit has two Audio Input jacks, how do I connect it?
Simply connect it to the "L (Mono)" Audio Input jack, but the sound will be monaural.

How do I watch the external unit connected to the Audio/Video Input jacks?

Press the TV/AV button so VIDEO1 appears on the screen, then start the external source.

Are the cables included?

No, the cables are sold separately, visit your local electronics store.

CABLE (CATV)/SATELLITE CONNECTIONS

This TV has an extended tuning range and can tune most cable channels without using a Cable TV converter box. Some Cable TV companies offer "premium pay channels" in which the signal is scrambled. Descrambling these signals for normal viewing requires the use of a descrambler device which is generally provided by the cable company.

FOR SUBSCRIBERS TO BASIC CABLE TV SERVICE

For basic cable service not requiring a converter/descrambler box, connect the CATV 75 ohm coaxial cable to the VHF/UHF jack on the rear of the TV.

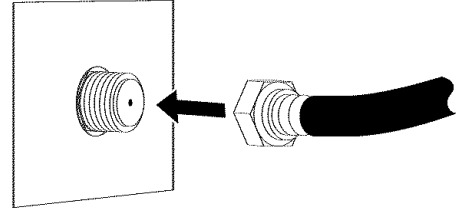

FOR SUBSCRIBERS TO SCRAMBLED CABLE TV SERVICE OR SATELLITE

If you subscribe to a satellite service or a cable TV service which requires the use of a converter/descrambler box, connect the incoming 75 ohm coaxial cable to the converter/descrambler box. Using another 75 ohm cable, connect the output of the converter/descrambler or satellite box to the antenna jack on the TV. Follow the connections shown below. Set the TV/VCR to the output channel of the converter/descrambler or satellite box (usually 3 or 4) and use the converter/descrambler or satellite box to select channels.

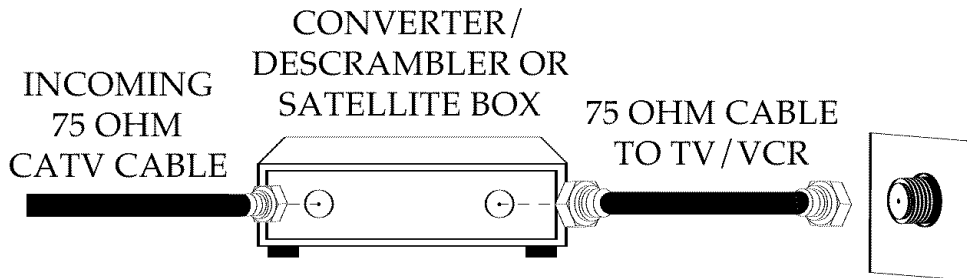

FOR SUBSCRIBERS TO UNSCRAMBLED BASIC CABLE TV SERVICE WITH SCRAMBLED PREMIUM CHANNELS

If you subscribe to a satellite service or a cable TV service in which basic channels are unscrambled and premium channels require the use of a converter/descrambler box, you may wish to use a signal splitter and an A/B switch box (available from the cable company or an electronic supply store). Follow the connections shown below. With the switch in the "B" position, you can directly tune any unscrambled channels on your TV. With the switch in the "A" position, tune your TV to the output of the converter/descrambler box (usually channel 3 or 4) and use the converter/descrambler box to tune scrambled channels.

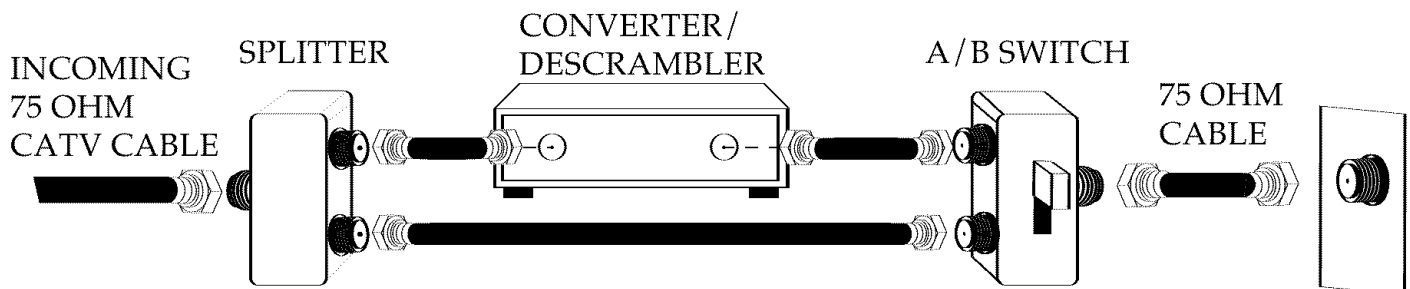

FAQ:

I connected my cable, but why can't I get channels above 69?

Make sure the AIR/CABLE option is set to CABLE, see page 25. Also, make sure your cable company broadcasts channels in the range you are searching.

CONNECTION FROM AN EXTERNAL UNIT

CONNECTION USING COAXIAL CABLE:

Follow the instructions below to connect an external unit, such as a VCR, to your unit using a 75 ohm coaxial cable. (CABLES NOT INCLUDED.)

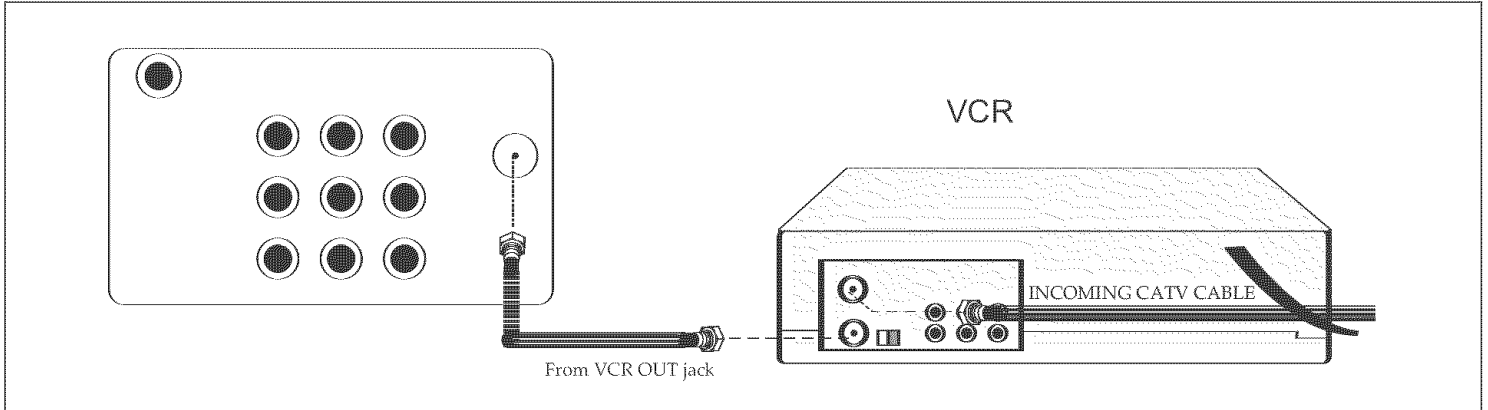

1. Connect the cable, satellite or incoming antenna to the VHF/UHF IN jack on the rear of the external unit.
2. Connect a 75 ohm coaxial cable from the external unit's 75 ohm OUT jack to the TV Antenna jack on the rear of the unit.
3. Press the TV/AV button until regular TV or CATV appears on the TV screen and press PLAY on the external unit to view.

NOTE: If you are in the inner DVD mode, press the TV/DVD button to change to TV/AV mode first.

CONNECTION USING AUDIO/VIDEO CABLES:

Follow the instructions below to connect an external unit, such as a VCR or a second DVD player, to your unit using Audio/Video cables. (CABLES NOT INCLUDED.)

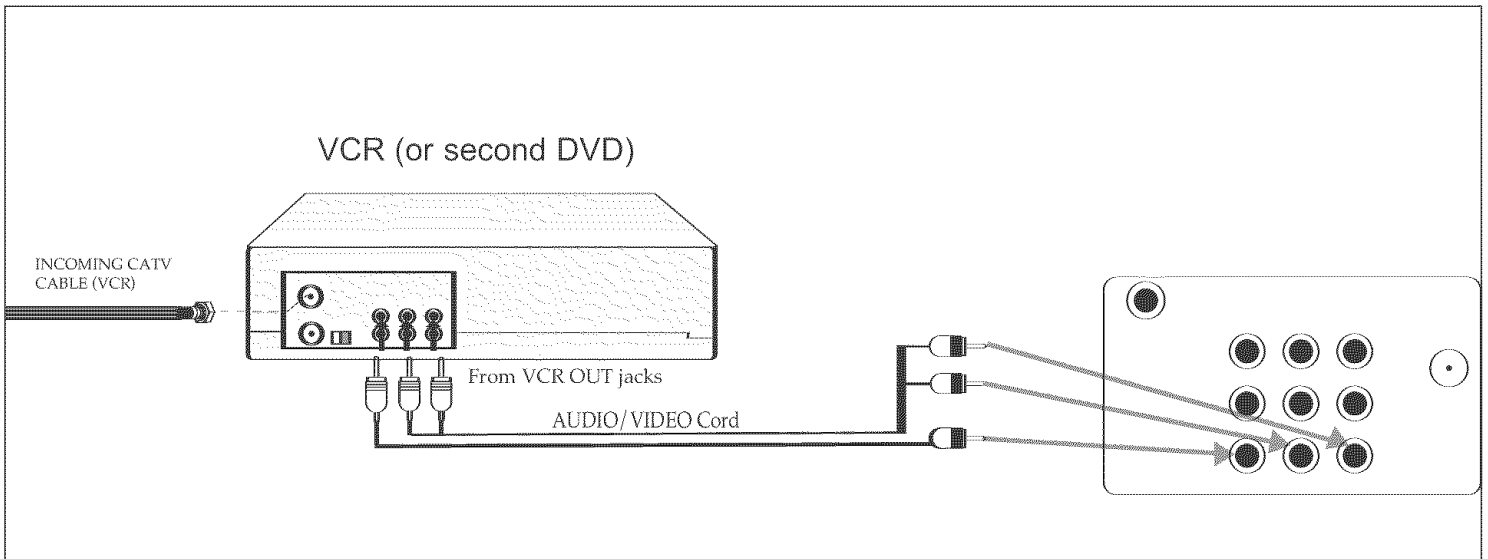

1. Connect the cable, satellite or incoming antenna to the VHF/UHF IN jack on the rear of the VCR.
2. Connect the left and right audio cables from the external unit's Audio OUT jacks to this unit's AUDIO 2 IN jacks. Connect the external unit's Video OUT jack to this unit's VIDEO 2 IN jack.
3. Press the TV/AV button until VIDEO2 appears on the TV screen.

NOTE: If you are in the inner DVD mode, press the TV/DVD button to change to TV/AV mode first.

CONNECTION FROM AN EXTERNAL UNIT (CONTINUED)

CONNECTION USING THE COMPONENT Y/CB/CR JACKS

1. Connect the cable, satellite or incoming antenna to the VHF/UHF IN jack on the rear of the external unit, such as a VCR or a second DVD player.
2. Connect the left and right audio cable from the external unit's Audio OUT jacks to this unit's AUDIO 2 IN jacks.
3. Connect the external unit's Component Video OUT jacks to this unit's COMPONENT IN Jacks (Y/CB/CR).
4. Press the TV/AV button until DVD appears on the TV screen.

NOTE: Connect the DVD player to this unit with the component in jacks for best results, otherwise use the Video 2 in jack.

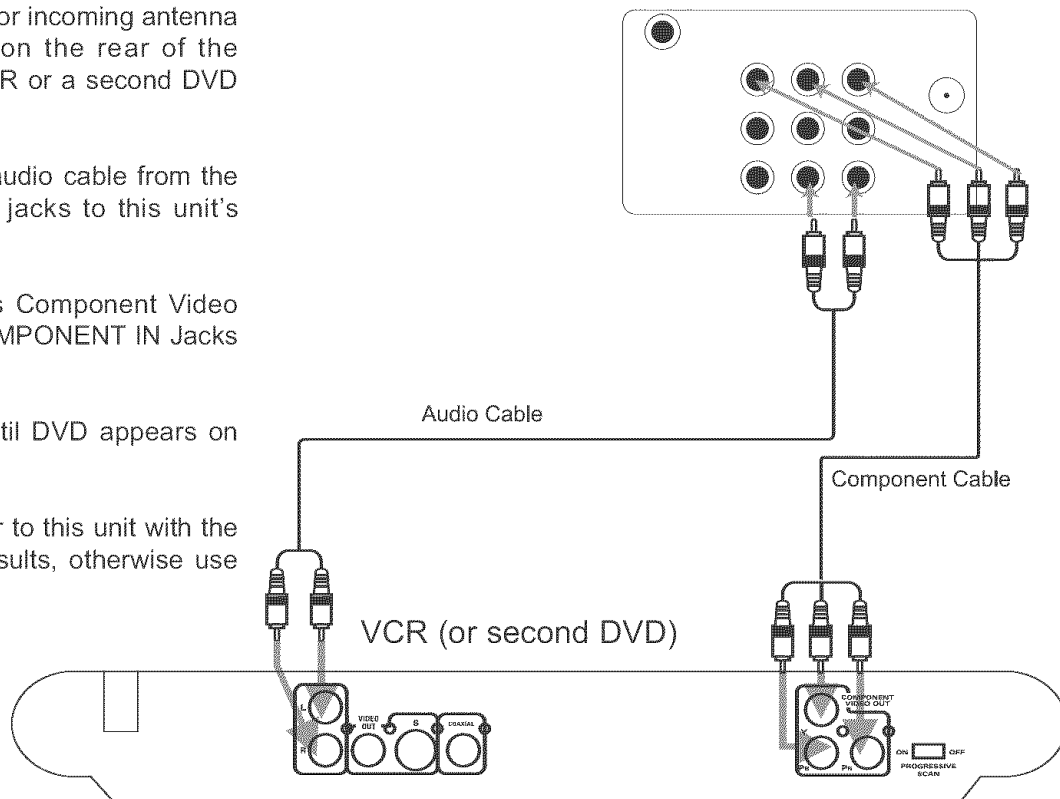

CONNECTION TO AN EXTERNAL UNIT

CONNECTION USING THE AUDIO/VIDEO OUT JACKS:

Follow the instructions below to connect an external audio and video unit. This will output the sound from the unit into the external audio unit's speakers.

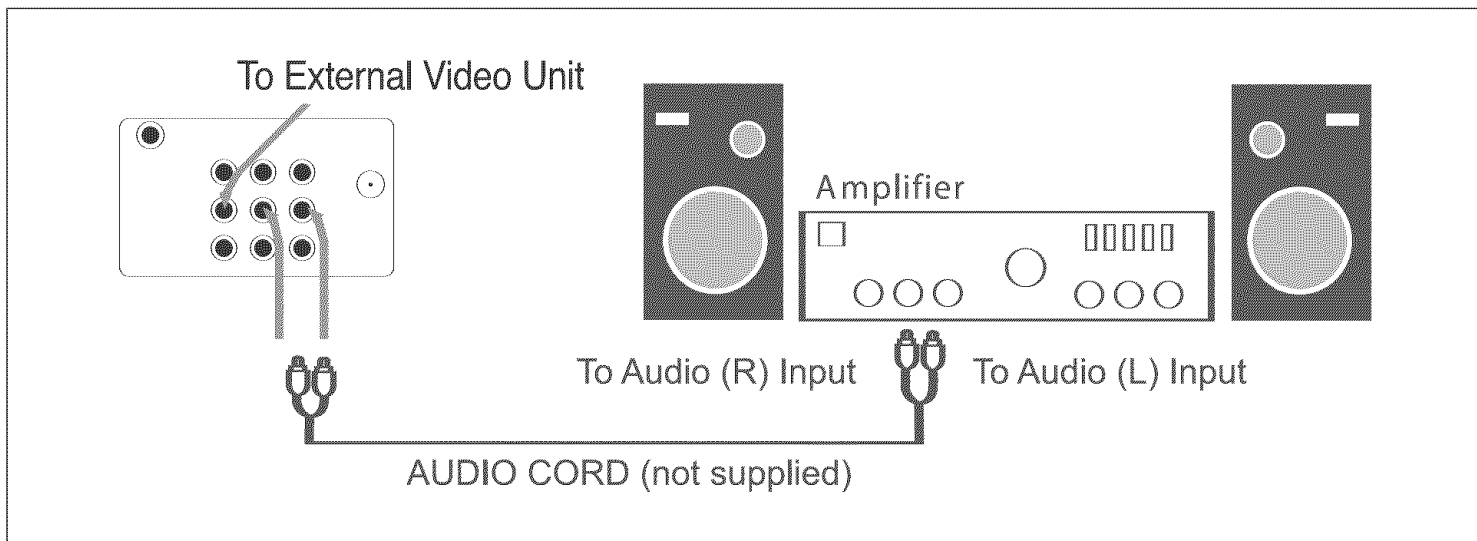

1. Connect the left and right audio cable from the Amplifier's Audio IN jacks to this unit's AUDIO OUT jacks.
2. If desired, connect an external unit's video IN jack to this unit's VIDEO OUT jack.

CONNECTION TO AN EXTERNAL UNIT (CONTINUED)

CONNECTION USING THE COAXIAL JACK

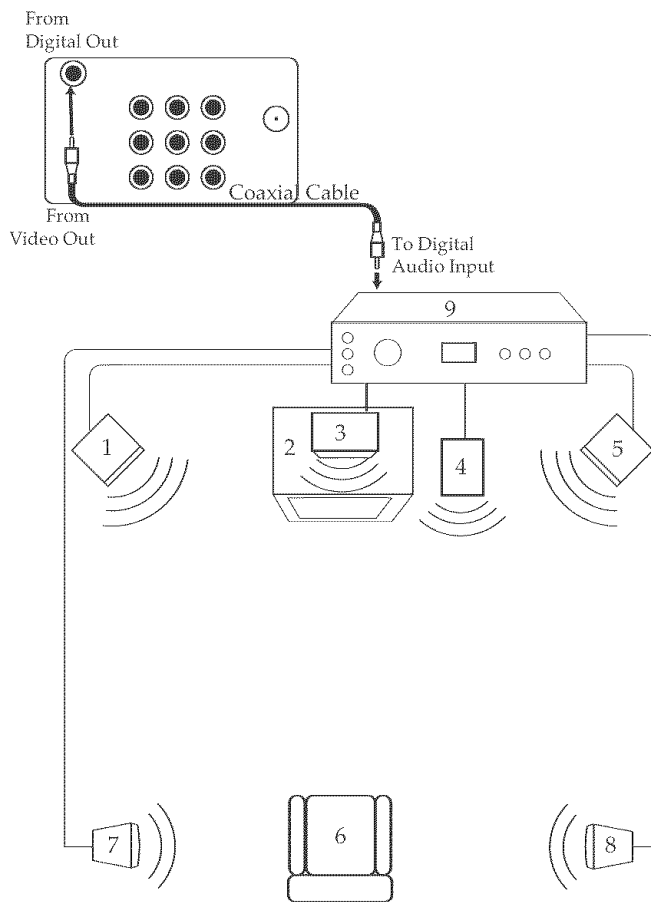

Place the subwoofer, front, rear and center speakers in locations as shown/described here. After correctly positioning the speakers, perform the Tone Test on the AV Amplifier and adjust the volume controls until the desired sound is achieved. For best results, sit in the viewing position and have someone adjust the volumes for you; this will enable you to set the optimal levels.

NOTE:

- The rear speakers can also be located on the side wall facing the viewing position and each other. Make sure the viewing position is located between the two speakers in this case. Experiment to find optimal position.

1. **Front Left Speaker**
2. **This Unit**
3. **Center Speaker**—can be located on top or below the Television.
4. **Sub-woofer**—can be located anywhere in the room.
5. **Front Right Speaker**

6. **Viewing/Listening Position**—The best listening position is obtained by positioning the chair, sofa, etc. in the middle of all the speakers.
7. **Rear Left Speaker**
8. **Rear Right Speaker**
9. **AV Amplifier w/Dolby Digital Decoder/DTS Decoder**

NOTES FOR CONNECTING TO A SUBWOOFER:

- When connecting, make sure the power is off and all units are unplugged before making any connections.

ABOUT DISCS

The region number for this DVD Player is:
See the following page for information regarding region numbers.



PLAYABLE DISCS:

The following discs can be played back on this DVD player:



DISC TYPES:

DVD

Data on most DVDs is divided into sections called “titles” and then into subsections called “chapters”, each of which is given a title or chapter number. Some features of this DVD player will not operate with some DVD discs as they are preset. If a function you selected does not run as desired, refer to the manual accompanying the DVD disc.

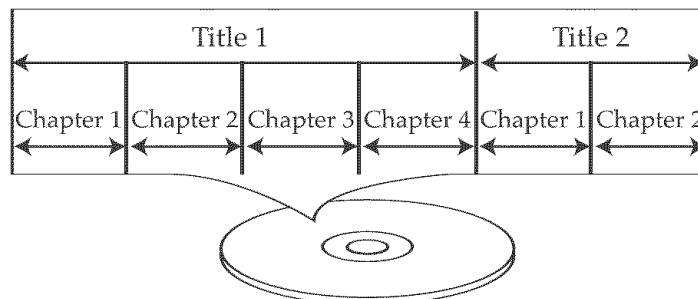

AUDIO CD

Data on an audio CD is divided into sections called “tracks”, each of which is given a track number.

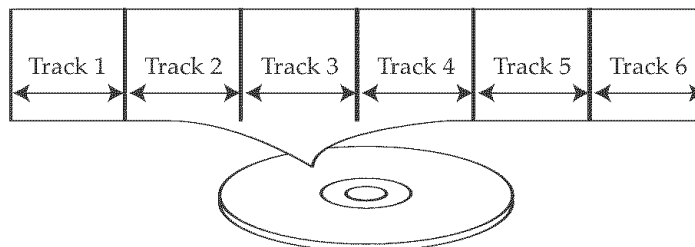

KODAK PICTURE CD

Data on a Kodak picture CD is usually not divided into separate folders, they should appear in the root directory.

IMPORTANT:

It is important that you read the manual that accompanies the DVD disc, as there are features that are on the DVD player that cannot be used with certain DVDs. There are also extra features on the DVD disc that are different for each DVD disc, so they are not explained in this owner's manual.

This player conforms to the NTSC, NTSC 443 and AUTO systems. The default setting is NTSC. However, if you are in the USA, leave this setting on NTSC.

ABOUT DISCS (CONTINUED)

Notes on Copyright:

It is forbidden by law to copy, broadcast, show, broadcast on cable, play in public and rent copyrighted material without permission. DVD video discs are copy protected, and any recordings made from these discs will be distorted. This product incorporates copyright protection technology that is protected by method claims of certain U.S. patents and other intellectual property rights owned by Macrovision Corporation and other rights owners. Use of this copyright protection technology must be authorized by Macrovision Corporation, and is intended for home and other limited viewing uses only, unless otherwise authorized by Macrovision Corporation. Reverse engineering or disassembly is prohibited.

Region Management Information:

This DVD Player is designed and manufactured to respond to the Region Management Information that is recorded on a DVD disc. If the Region number described on the DVD disc does not correspond to the Region number of this DVD player, this DVD player cannot play that disc. You may not be able to play back some DVD video discs on this player if they were purchased from outside your geographic area or made for business purposes. When you try to play back an unauthorized disc, "Wrong Region" appears on the TV screen.

SETTING THE TV MENUS

VIDEO SETUP MENU:

SETTING THE PICTURE

1

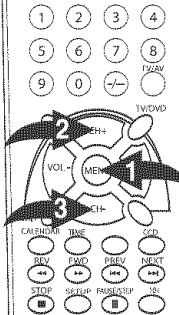

Video	
Picture	85
Brightness	60
Color	60
Sharpness	80
Tint	0
Color Temp.	Cool

Press the MENU button **1** once; the Video menu will appear. Press the CHANNEL Up **2** or Down **3** button until the desired picture setting is selected (PICTURE, BRIGHTNESS, COLOR, SHARPNESS, TINT).

NOTE: Tint option is only available when in the Inner DVD mode.

2

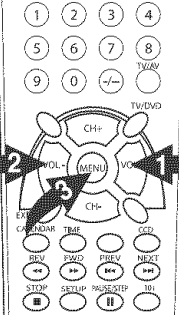

Video	
Picture	85
Brightness	60
Color	60
Sharpness	80
Tint	0
Color Temp.	Cool

Press the VOLUME Up **1** or Down **2** button to adjust the setting.

When done, press the Menu button **3** once to return to the Video menu.

3

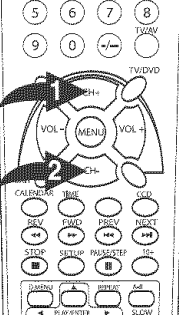

Video	
Picture	85
Brightness	60
Color	60
Sharpness	80
Tint	0
Color Temp.	Cool

Press the CHANNEL Up **1** or Down **2** button until COLOR TEMP is selected.

4

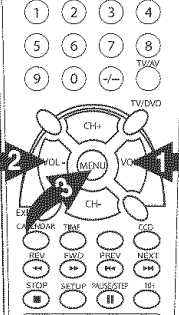

Video	
Picture	85
Brightness	60
Color	60
Sharpness	80
Tint	0
Color Temp.	Cool

Press the VOLUME Up **1** or Down **2** button to set the desired color balance (COOL, NEUTRAL or WARM). When done, press the MENU button **3** twice to exit the menus.

AUDIO SETUP MENU:

1

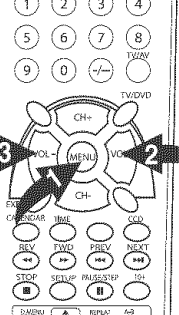

Audio	
Volume	10

Press the MENU button **1** once; the Video menu will appear. Press the VOLUME Up **2** or Down **3** button to select the Audio setting.

2

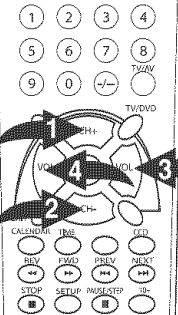

Audio	
Volume	10

Press the CHANNEL Up **1** or Down **2** button until VOLUME is selected; volume will highlighted in red. Press the VOLUME Up **3** or Down **4** button to set the desired volume.

NOTES:

- To exit the menus, press the EXIT button.
- Use the Volume Up/Down buttons to adjust the volume directly while in TV/AV/DVD mode.

SETTING THE TV MENUS (CONTINUED)

TIMER SETUP MENU (CANNOT BE USED WHEN IN DVD MODE):

SETTING THE CLOCK

1

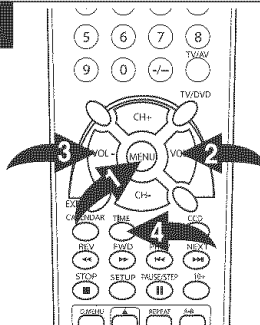

Timer	
Clock	01:13
Time-On	--:--
Ch. Select	1
Time-Off	--:--
Sleep Time	0
Remind Time	--:--
Ch. Switch	1

While in TV/AV mode, press the MENU button **1** once; the Video menu will appear. Press the VOLUME Up **2** or Down **3** button to select the Timer setting.

NOTE: You can press the TIME button **4** to directly enter to Time Setting while in TV/AV mode.

2

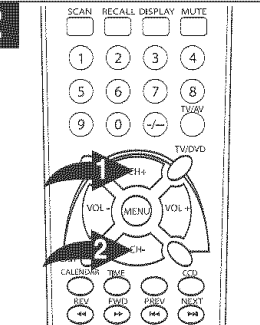

Timer	
Clock	01:13
Time-On	--:--
Ch. Select	1
Time-Off	--:--
Sleep Time	0
Remind Time	--:--
Ch. Switch	1

Press the CHANNEL Up **1** or Down **2** button until CLOCK is selected; the hours will be highlighted in red.

NOTE: The clock is a 24 hour (military time) type clock.

3

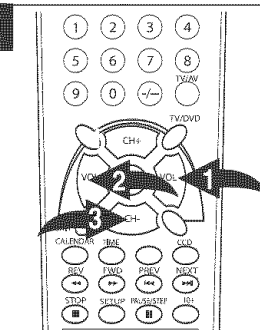

Timer	
Clock	01:13
Time-On	--:--
Ch. Select	1
Time-Off	--:--
Sleep Time	0
Remind Time	--:--
Ch. Switch	1

Press the VOLUME Up **1** or Down **2** button to set the current hour, then press the CHANNEL Down button **3**; the minutes will be highlighted in red.

4

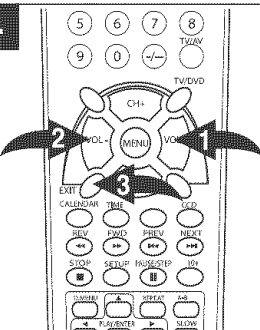

Timer	
Clock	01:13
Time-On	--:--
Ch. Select	1
Time-Off	--:--
Sleep Time	0
Remind Time	--:--
Ch. Switch	1

Press the VOLUME Up **1** or Down **2** button to set the current minute. When done, press the EXIT button **3** to exit the menus.

SETTING THE TV MENUS (CONTINUED)

SETTING THE ON TIMER

1

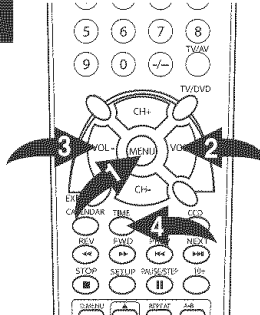

Timer	
Clock	01:13
Time-On	--:--
Ch. Select	1
Time-Off	--:--
Sleep Time	0
Remind Time	--:--
Ch. Switch	1

2

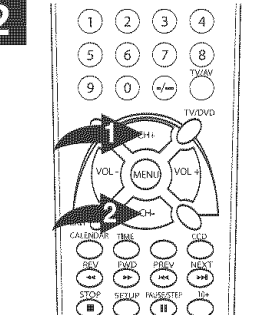

Timer	
Clock	01:13
Time-On	12:--
Ch. Select	1
Time-Off	--:--
Sleep Time	0
Remind Time	--:--
Ch. Switch	1

While in TV/AV mode, press the MENU button ❶ once; the Video menu will appear. Press the VOLUME Up ❷ or Down ❸ button to select the Timer setting.

NOTE: You can press the TIME button ❹ to directly enter to Timer Setting while in TV/AV mode.

Press the CHANNEL Up ❶ or Down ❷ button until TIME ON is selected; the hours will be highlighted in red.

3

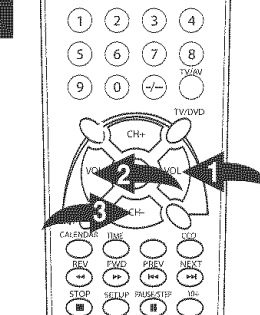

Timer	
Clock	01:13
Time-On	12:--
Ch. Select	1
Time-Off	--:--
Sleep Time	0
Remind Time	--:--
Ch. Switch	1

Press the VOLUME Up ❶ or Down ❷ button to set the desired On hour, then press the CHANNEL Down button ❸; the minutes will be highlighted in red.

4

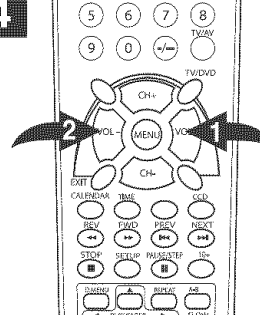

Timer	
Clock	01:13
Time-On	12:30
Ch. Select	1
Time-Off	--:--
Sleep Time	0
Remind Time	--:--
Ch. Switch	1

Press the VOLUME Up ❶ or Down ❷ button to set the desired On minute.

5

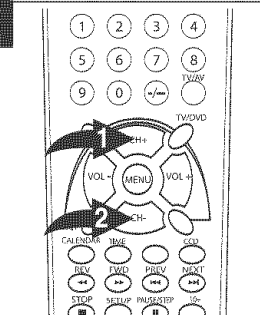

Timer	
Clock	01:13
Time-On	12:30
Ch. Select	5
Time-Off	--:--
Sleep Time	0
Remind Time	--:--
Ch. Switch	1

Press the CHANNEL Up ❶ or Down ❷ button until CH. SELECT is selected.

6

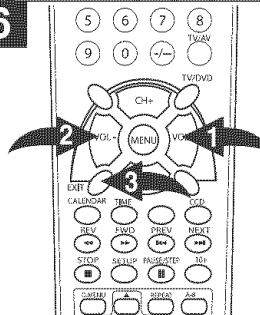

Timer	
Clock	01:13
Time-On	12:30
Ch. Select	5
Time-Off	--:--
Sleep Time	0
Remind Time	--:--
Ch. Switch	1

Press the VOLUME Up ❶ or Down ❷ button to set the desired On Channel (the channel the unit will turn on to). When done, press the EXIT button ❸ to exit the menus.

NOTE:

- When the actual time matches the Timer On time, the unit will automatically turn on.

SETTING THE TV MENUS (CONTINUED)

SETTING THE OFF TIMER

1

Timer	
Clock	01:13
Time-On	--:--
Ch. Select	1
Time-Off	--:--
Sleep Time	0
Remind Time	--:--
Ch. Switch	1

2

Timer	
Clock	01:13
Time-On	12:30
Ch. Select	5
Time-Off	12:--
Sleep Time	0
Remind Time	--:--
Ch. Switch	1

While in TV/AV mode, press the MENU button ❶ once; the Video menu will appear. Press the VOLUME Up ❷ or Down ❸ button to select the Timer setting.

NOTE: You can press the TIME button ❹ to directly enter to Timer Setting while in TV/AV mode.

Press the CHANNEL Up ❶ or Down ❷ button until TIME OFF is selected; the hours will be highlighted in red.

3

Timer	
Clock	01:13
Time-On	12:30
Ch. Select	5
Time-Off	12:45
Sleep Time	0
Remind Time	--:--
Ch. Switch	1

Press the VOLUME Up ❶ or Down ❷ button to set the desired Off hour, then press the CHANNEL Down button ❸; the minutes will be highlighted in red.

4

Timer	
Clock	01:13
Time-On	12:30
Ch. Select	5
Time-Off	12:45
Sleep Time	0
Remind Time	--:--
Ch. Switch	1

Press the VOLUME Up ❶ or Down ❷ button to set the desired Off minute. When done, press the EXIT button ❸ to exit the menus.

NOTE:

- When the actual time matches the Timer Off time, the unit will automatically turn off.

SETTING THE SLEEP TIMER

1

Timer	
Clock	01:13
Time-On	12:30
Ch. Select	5
Time-Off	12:45
Sleep Time	10
Remind Time	--:--
Ch. Switch	1

While in TV/AV mode, press the MENU button ❶ once; the Video menu will appear. Press the VOLUME Up ❷ or Down ❸ button to select the Timer setting. Press the CHANNEL Up ❹ or Down ❺ button until SLEEP TIME is selected.

NOTE: You can press the TIME button ❻ to directly enter to Timer Setting while in TV/AV mode.

2

Timer	
Clock	01:13
Time-On	12:30
Ch. Select	5
Time-Off	12:45
Sleep Time	10
Remind Time	--:--
Ch. Switch	1

Press the VOLUME Up ❶ or Down ❷ button to set the desired Sleep Time. When done, press the EXIT button ❸ to exit the menus. The sleep timer will count down and when it reaches 0, the unit will turn off.

NOTE: For the Sleep Timer, you can select from 0 -180, i.e. set to 10 for the unit turn off automatically after 10 minutes, set to 180 to turn off the unit automatically after 180 minutes.

SETTING THE TV MENUS (CONTINUED)

SETTING THE REMIND TIMER

1

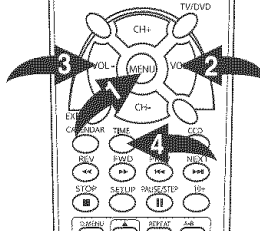

Timer	
Clock	01:13
Time-On	--:--
Ch. Select	1
Time-Off	--:--
Sleep Time	0
Remind Time	--:--
Ch. Switch	1

While in TV/AV mode, press the MENU button ❶ once; the Video menu will appear. Press the VOLUME Up ❷ or Down ❸ button to select the Timer setting.
NOTE: You can press the TIME button ❹ to directly enter to Timer Setting while in TV/AV mode.

2

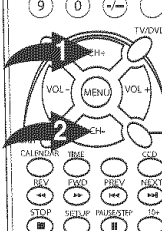

Timer	
Clock	01:13
Time-On	12:30
Ch. Select	5
Time-Off	12:45
Sleep Time	0
Remind Time	16:--
Ch. Switch	1

Press the CHANNEL Up ❶ or Down ❷ button until REMIND TIME is selected; the hours will be highlighted in red.

3

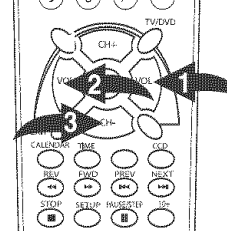

Timer	
Clock	01:13
Time-On	12:30
Ch. Select	5
Time-Off	12:45
Sleep Time	0
Remind Time	16:30
Ch. Switch	1

Press the VOLUME Up ❶ or Down ❷ button to set the desired Remind hour, then press the CHANNEL Down button ❸; the minutes will be highlighted in red.

4

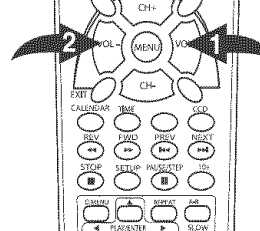

Timer	
Clock	01:13
Time-On	12:30
Ch. Select	5
Time-Off	12:45
Sleep Time	0
Remind Time	16:30
Ch. Switch	1

Press the VOLUME Up ❶ or Down ❷ button to set the desired Remind minute.

5

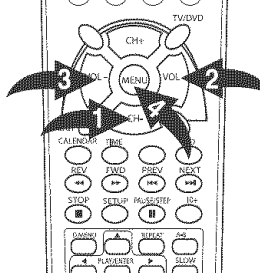

Timer	
Clock	01:13
Time-On	12:30
Ch. Select	5
Time-Off	12:45
Sleep Time	0
Remind Time	--:--
Ch. Switch	7

Press the CHANNEL Down button ❶, the CH.SWITCH will be highlight in red. Press the VOLUME Up ❷ or Down ❸ button to set the desired channel which you want to switch to when the actual time reaches the Remind Time. When done, press the MENU button ❹ repeatedly to exit the menus.

- NOTE:**
- When the actual time reaches matches the Remind time, it will switch to the channel which you set. This is useful for you if you won't miss the favorite TV program while you watching on another program at different TV channel.

SETTING THE TV MENUS (CONTINUED)

SETUP MENU:

SETTING THE LANGUAGE

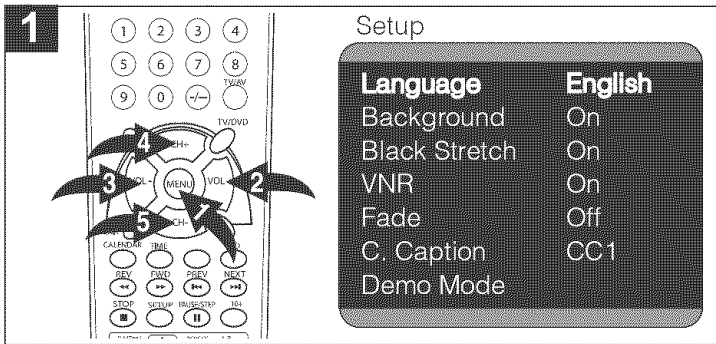

Press the MENU button ❶ once; the Video menu will appear. Press the VOLUME Up ❷ or Down ❸ button to select the Setup setting. Press the CHANNEL Up ❹ or Down ❺ button until LANGUAGE is selected.

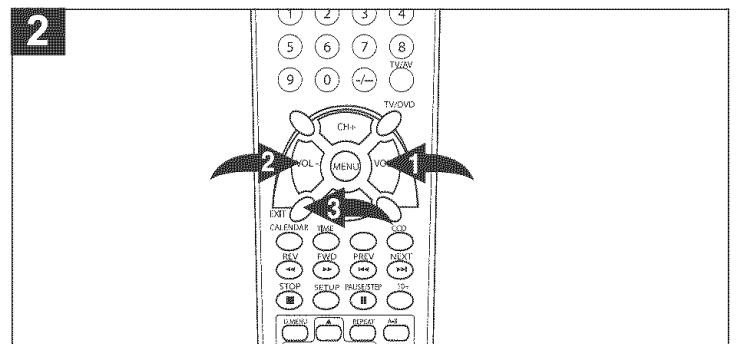

Press the VOLUME Up ❶ or Down ❷ button to set the desired Language (ENGLISH, FRENCH or SPANISH). When done, press the EXIT button ❸ to exit the menus.

SETTING THE BACKGROUND (TV/CATV MODE ONLY)

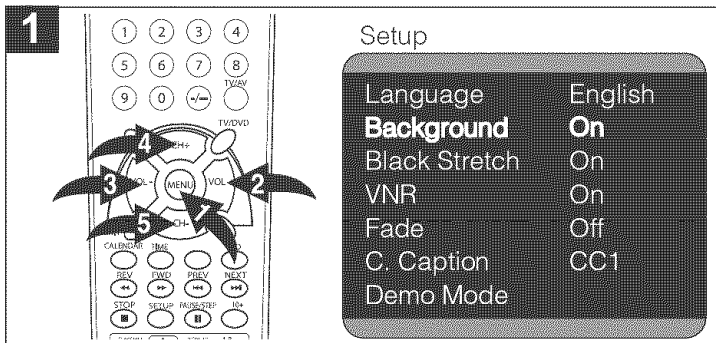

Press the MENU button ❶ once; the Video menu will appear. Press the VOLUME Up ❷ or Down ❸ button to select the Setup setting. Press the CHANNEL Up ❹ or Down ❺ button until BACKGROUND is selected.

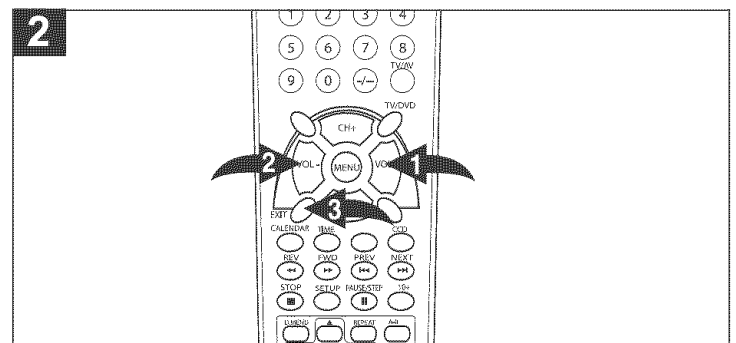

Press the VOLUME Up ❶ or Down ❷ button to turn the Background ON (the background will be blue if no signal is received) or OFF. When done, press the EXIT button ❸ to exit the menus.

SETTING THE BLACK STRETCH

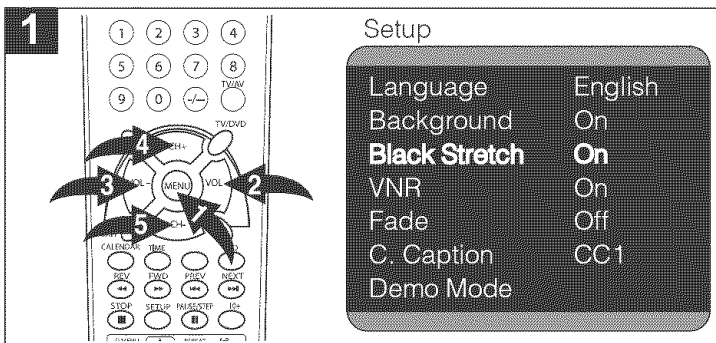

Press the MENU button ❶ once; the Video menu will appear. Press the VOLUME Up ❷ or Down ❸ button to select the Setup setting. Press the CHANNEL Up ❹ or Down ❺ button until BLACK STRETCH is selected.

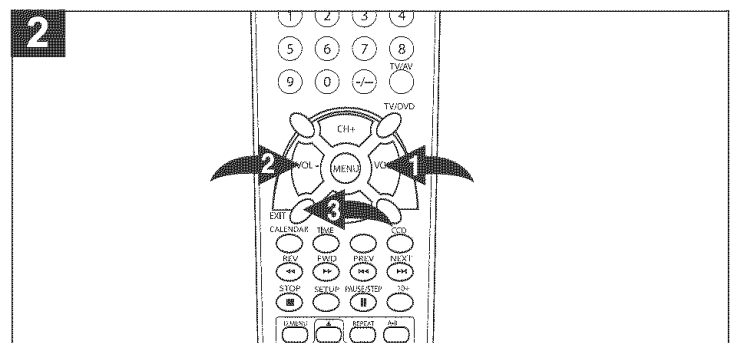

Press the VOLUME Up ❶ or Down ❷ button to turn the Background ON (the contrast range will automatically be increased) or OFF. When done, press the EXIT button ❸ to exit the menus.

SETTING THE TV MENUS (CONTINUED)

SETTING THE VNR (VIDEO NOISE REDUCTION)

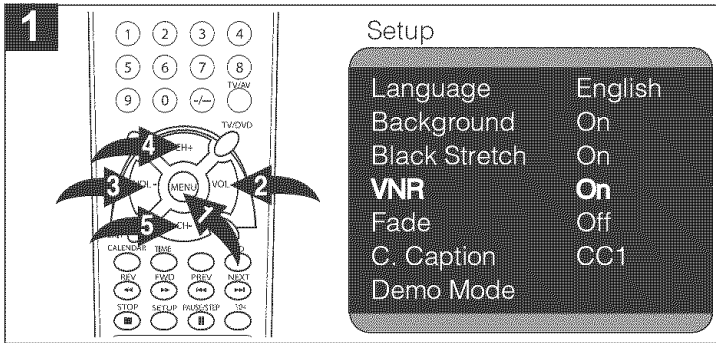

Press the MENU button **1** once; the Video menu will appear. Press the VOLUME Up **2** or Down **3** button to select the Setup setting. Press the CHANNEL Up **4** or Down **5** button until VNR is selected.

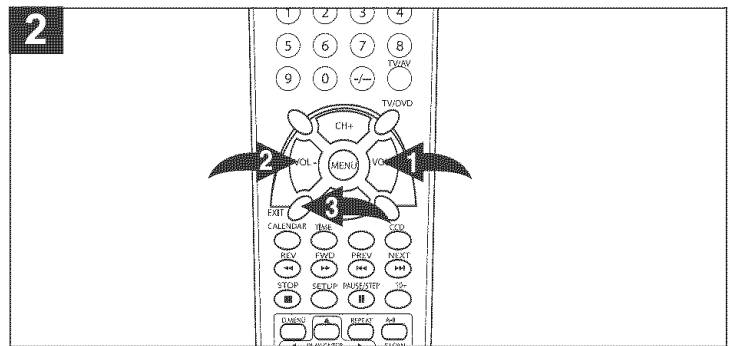

Press the VOLUME Up **1** or Down **2** button to turn the VNR ON (this will allow the picture tube to warm up and gently turn on, thus increasing the life of the picture tube) or OFF. When done, press the EXIT button **3** to exit the menus.

SETTING THE FADE

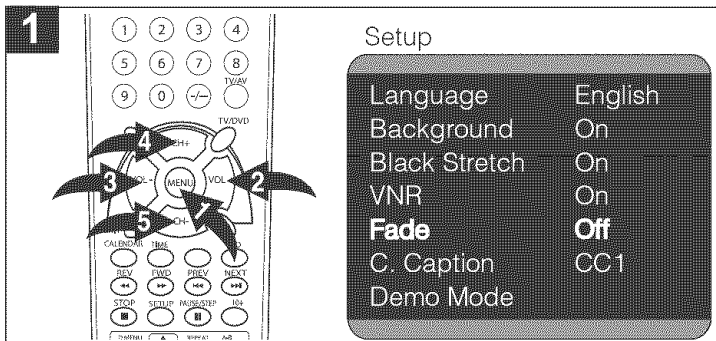

Press the MENU button **1** once; the Video menu will appear. Press the VOLUME Up **2** or Down **3** button to select the Setup setting. Press the CHANNEL Up **4** or Down **5** button until FADE is selected.

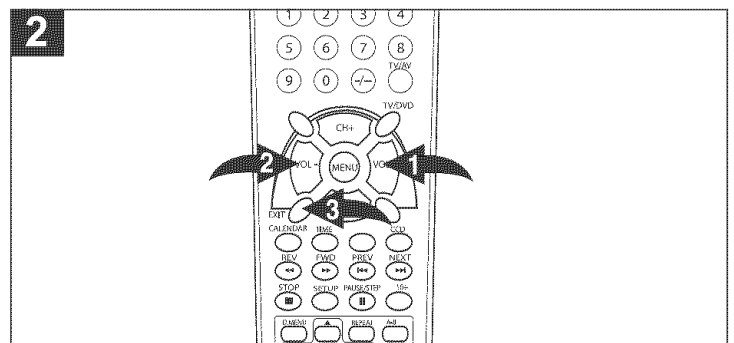

Press the VOLUME Up **1** or Down **2** button to turn the Fade ON (the background will be blue if no signal is received) or OFF. When done, press the EXIT button **3** to exit the menus.

SETTING THE TV MENUS (CONTINUED)

SETTING THE CLOSED CAPTIONS

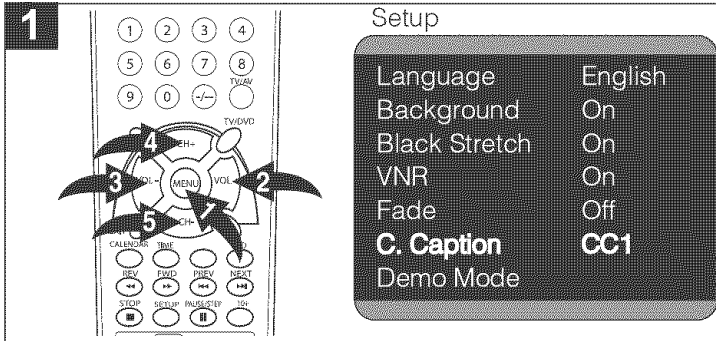

Press the MENU button ❶ once; the Video menu will appear. Press the VOLUME Up ❷ or Down ❸ button to select the Setup setting. Press the CHANNEL Up ❹ or Down ❺ button until C. CAPTION is selected.

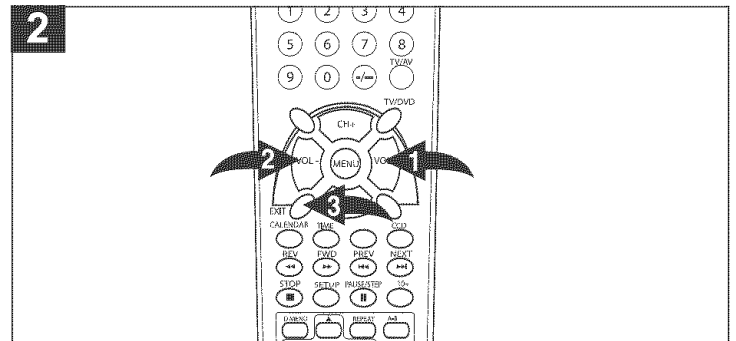

Press the VOLUME Up ❶ or Down ❷ button to turn Closed Captions off or on and select a mode (see page 38 for details). When done, press the EXIT button ❸ to exit the menus.

SETTING THE TV TO DEMO MODE

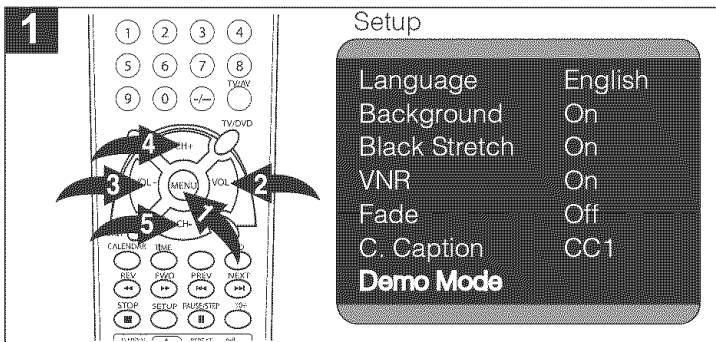

Press the MENU button ❶ once; the Video menu will appear. Press the VOLUME Up ❷ or Down ❸ button to select the Setup setting. Press the CHANNEL Up ❹ or Down ❺ button until DEMO MODE is selected.

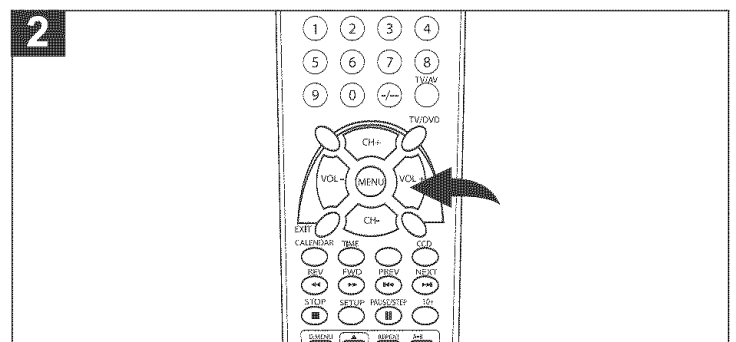

Press the VOLUME Up button to activate the Demo mode; the unit will then enter the Demo mode and the screen will show various features.

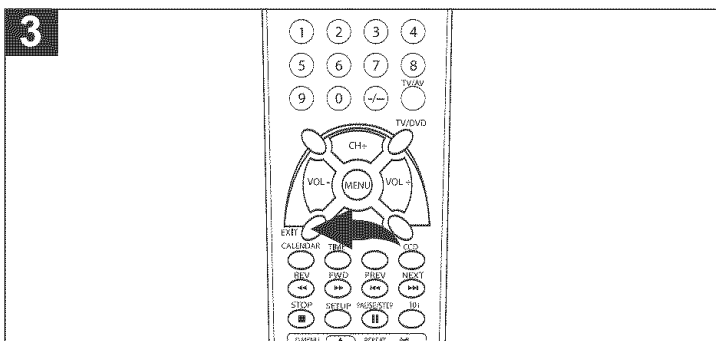

To stop Demo mode, press the EXIT button.

SETTING THE TV MENUS (CONTINUED)

CHANNEL SETUP MENU:

SETTING THE CHANNEL SYSTEM

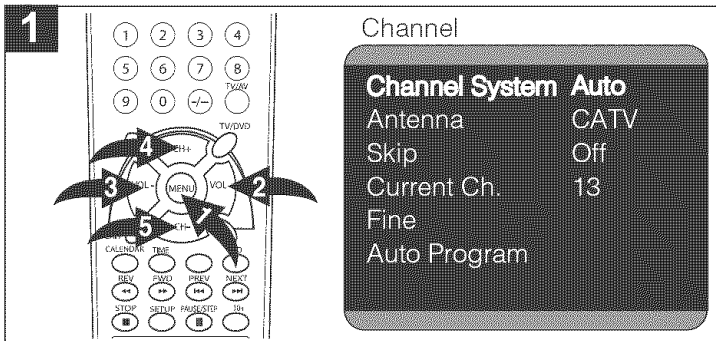

While in the TV mode, press the MENU button ❶ once; the Video menu will appear. Press the VOLUME Up ❷ or Down ❸ button to select the Channel Setting. Press the CHANNEL Up ❹ or Down ❺ button until CHANNEL SYSTEM is selected.

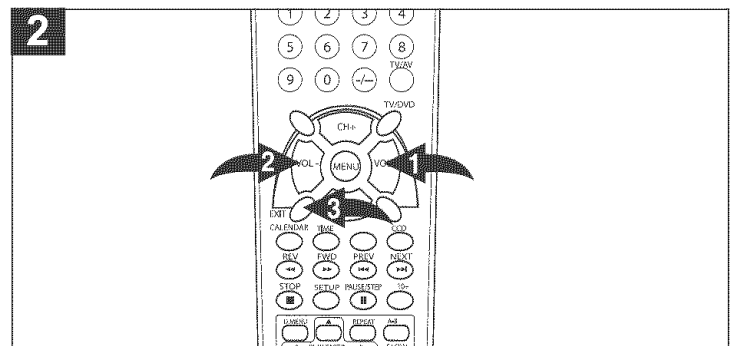

Press the VOLUME Up ❶ or Down ❷ button to set the desired Channel System (AUTO, NTSC or NTSC443). When done, press the EXIT button ❸ to exit the menus.
NOTE: In USA, the system is NTSC.

SETTING THE FINE TUNING

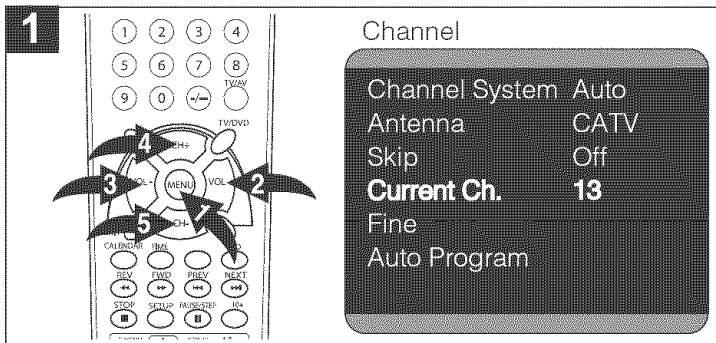

While in the TV mode, press the MENU button ❶ once; the Video menu will appear. Press the VOLUME Up ❷ or Down ❸ button to select the Channel Setting. Press the CHANNEL Up ❹ or Down ❺ button until CURRENT CH. is selected.

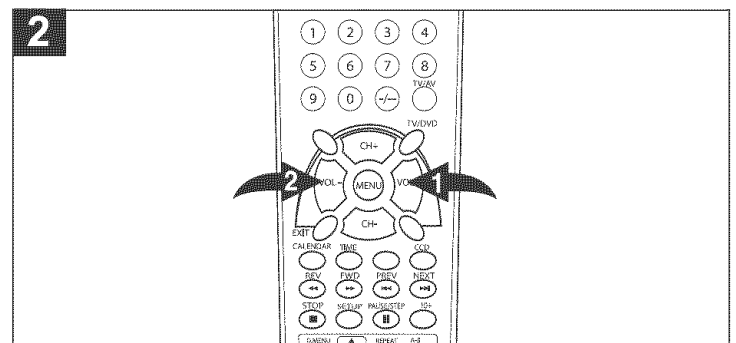

Press the VOLUME Up ❶ or Down ❷ button to select a desired channel to fine tune.

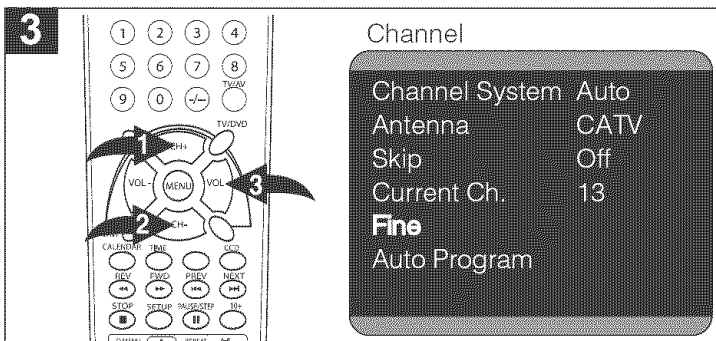

Press the CHANNEL Up ❶ or Down ❷ button until FINE is selected, then press the VOLUME Up button ❸.

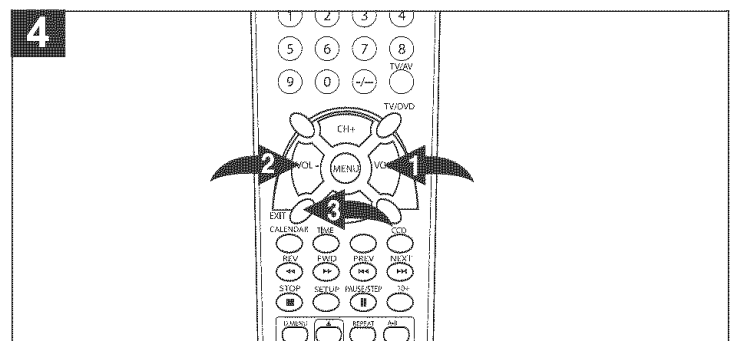

Fine tune the channel using the VOLUME Up ❶ or Down ❷ button. When done, press the EXIT button ❸ to exit the menus.

SETTING THE TV MENUS (CONTINUED)

SETTING CHANNELS INTO MEMORY

This unit is equipped with a channel memory feature which allows channels to skip up or down to the next channels set into memory, skipping over unwanted channels. Before selecting channels, they must be programmed into the unit's memory. In addition to normal VHF/UHF channels, this unit can receive up to 125 Cable TV channels.

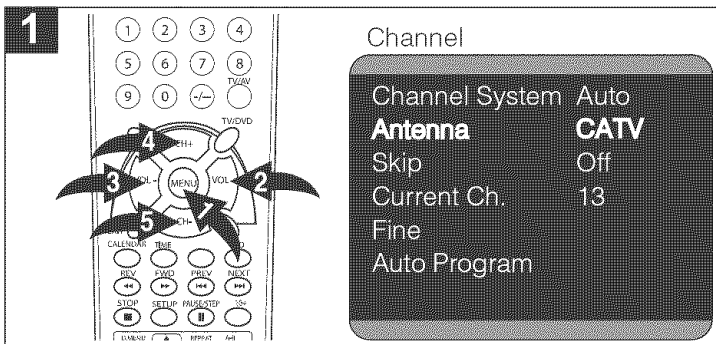

While in the TV mode, press the MENU button ❶ once; the Video menu will appear. Press the VOLUME Up ❷ or Down ❸ button to select the Channel Setting. Press the CHANNEL Up ❹ or Down ❺ button until ANTENNA is selected.

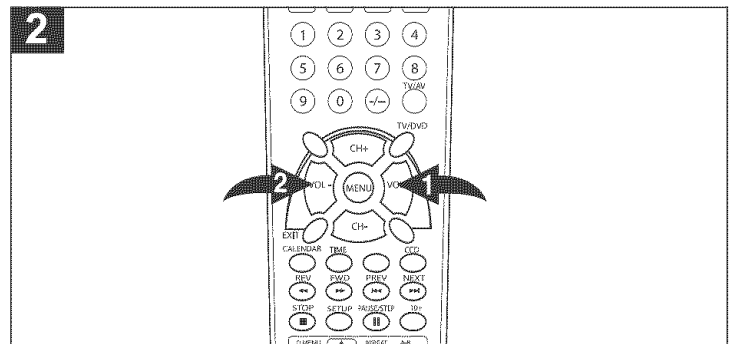

Press the VOLUME Up ❶ or Down ❷ button to select TV (VHF/UHF Channels) or CATV (Cable TV).

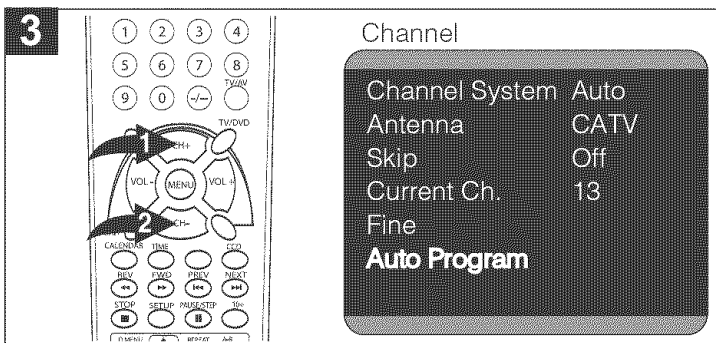

Press the CHANNEL Up ❶ or Down ❷ button until AUTO PROGRAM is selected.

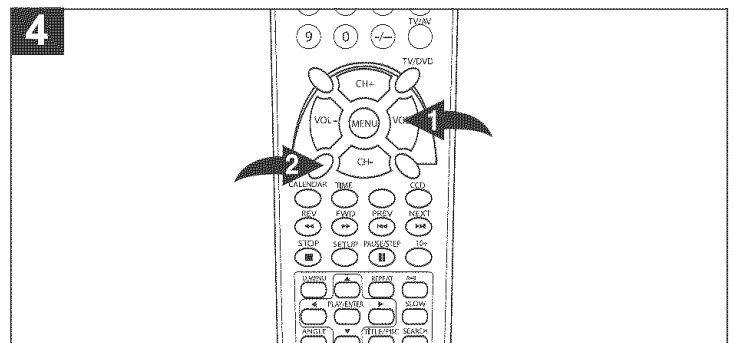

Press the VOLUME Up button ❶ to start Auto Programming and the unit will automatically cycle through all the channels and store active channels into memory. When finished, press the EXIT button ❷ to exit the menu settings.

FAQs:

How many channels will I actually receive?

The actual number of channels that can be received depends on how many channels your cable or satellite company, or local area, provides. Contact your company to determine the number of channels in your area.

SETTING THE TV MENUS (CONTINUED)

ADDING AND DELETING CHANNELS

After setting channels into memory, you can add or delete channels as follows:

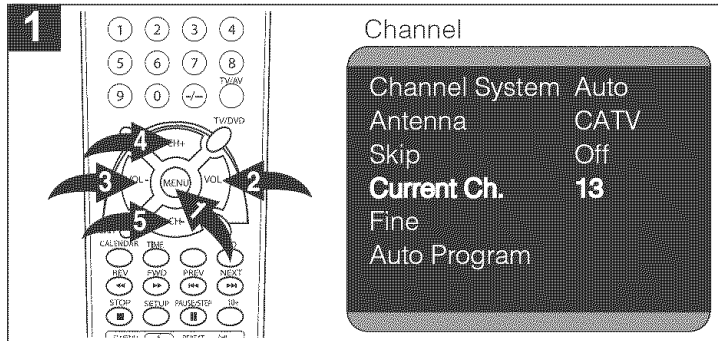

While in the TV mode, press the MENU button ❶ once; the Video menu will appear. Press the VOLUME Up ❷ or Down ❸ button to select the Channel Setting. Press the CHANNEL Up ❹ or Down ❺ button until CURRENT CH. is selected.

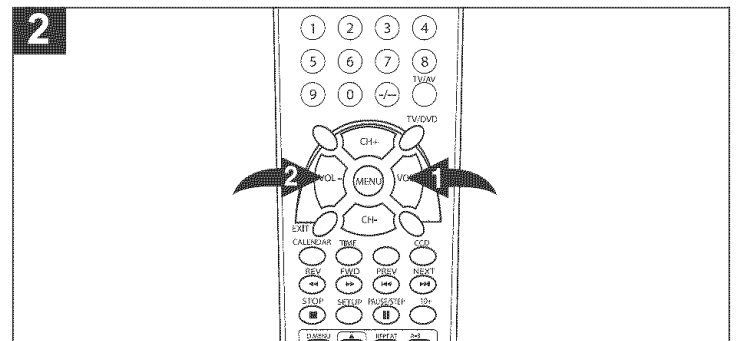

Press the VOLUME Up ❶ or Down ❷ button to select a desired channel to add or delete.

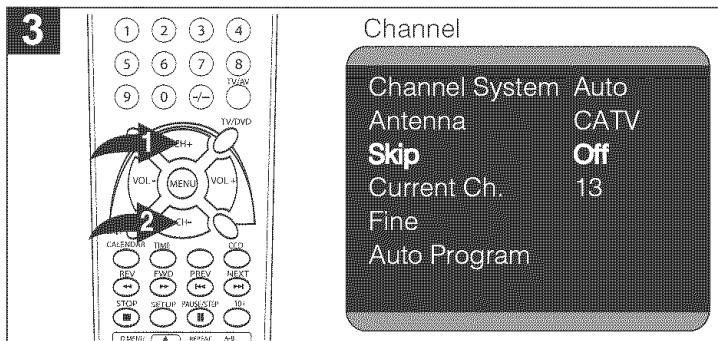

Press the CHANNEL Up ❶ or Down ❷ button until SKIP is selected.

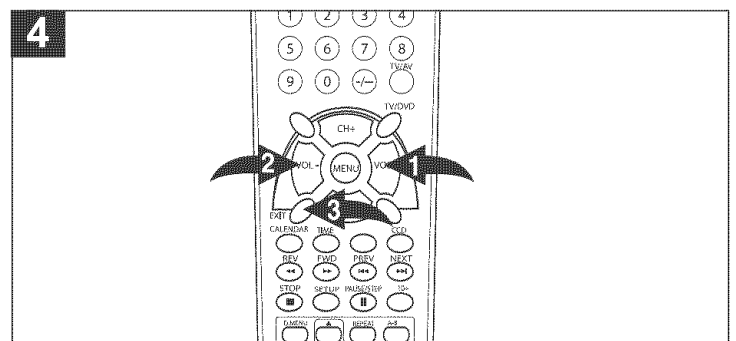

Press the VOLUME Up ❶ or Down ❷ button to turn Skip feature ON (to skip the channel) or OFF (to memorize the channel). When done, press the EXIT button ❸ to exit the menus.

SETTING THE TV MENUS (CONTINUED)

CALENDAR SETUP MENU:

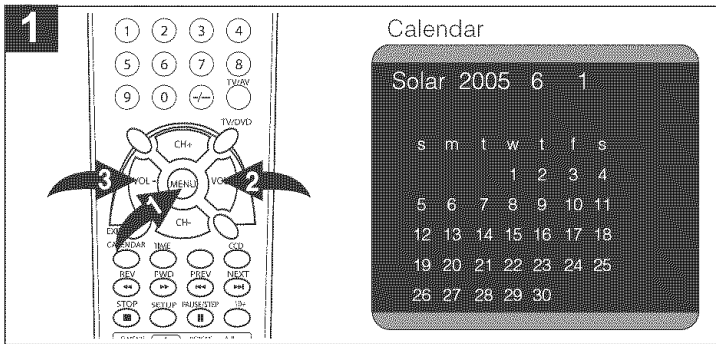

Press the MENU button ❶ once; the Video menu will appear. Press the VOLUME Up ❷ or Down ❸ button to select the Calendar setting.

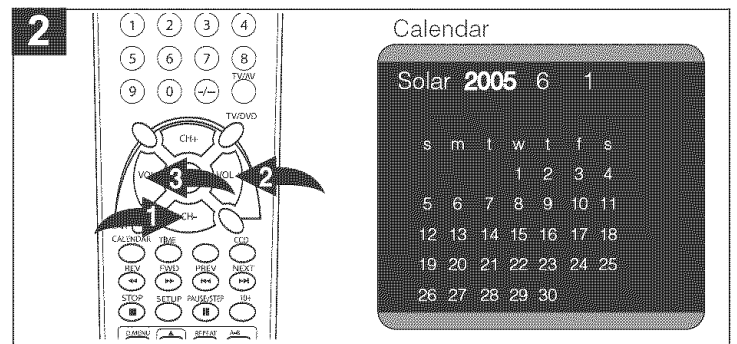

Press the CHANNEL Down button ❶ until the year is selected. Press the VOLUME Up ❷ or Down ❸ button to set the year, then press the CHANNEL Down button ❶; the month will be highlighted.

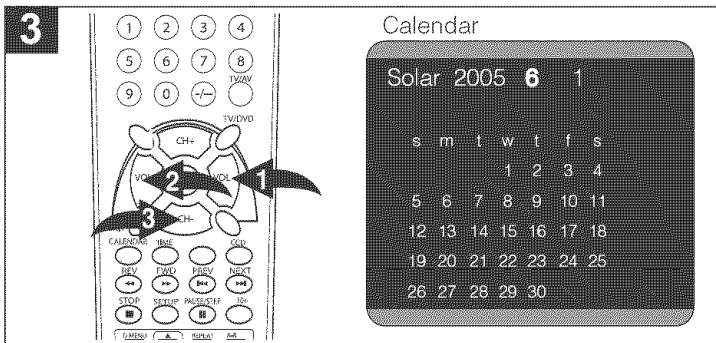

Press the VOLUME Up ❶ or Down ❷ button to set the month, then press the CHANNEL Down button ❸; the day will be highlighted.

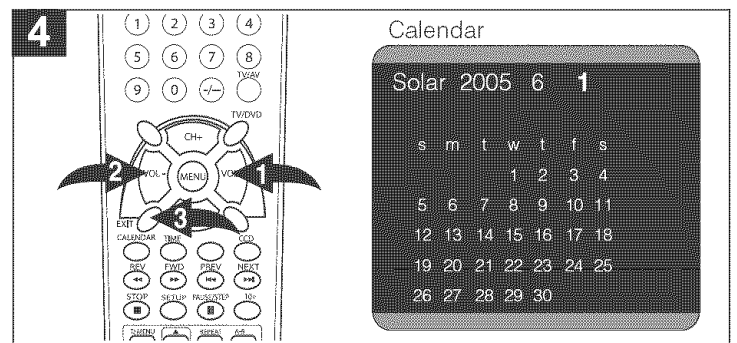

Press the VOLUME Up ❶ or Down ❷ button to set the day. When done, press the EXIT button ❸ to exit the menus.

TV PARENTAL CONTROL

V-Chip enables parents to prevent their children from watching inappropriate material on TV. V-Chip reads the ratings for programming (except for news, sports, unedited movies on premium cable and Emergency System signals), then denies access to programming if the program's rating meets the limitations you select. In this case, the program will be blocked.

PARENTAL CONTROL SET-UP

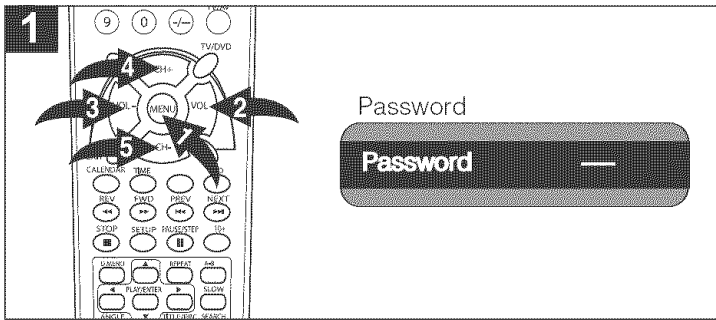

While in the TV/AV mode, press the MENU button ❶ once; the Video menu will appear. Press the VOLUME Up ❷ or Down ❸ button to select the Password. Press the CHANNEL Up ❹ or Down ❺ button until PASSWORD is highlighted in red.

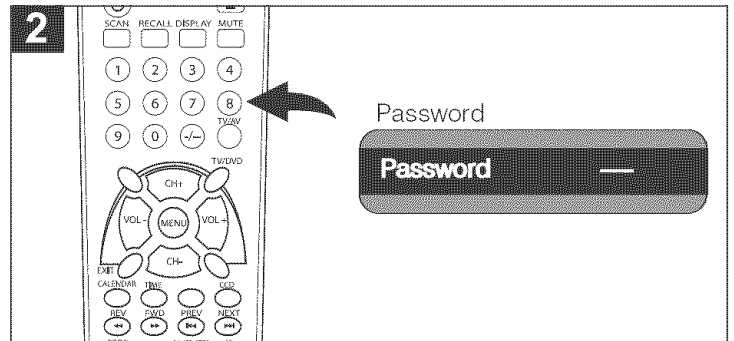

You will be prompted to enter the password to enter this menu. Enter the four digit password (The default password is 1234) using the Direct Channel Selection/Number (0-9) buttons.

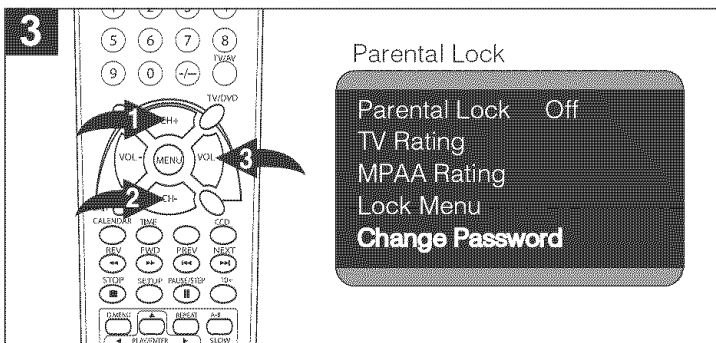

TO CHANGE THE PASSWORD: After entering the menu, press the CHANNEL Up ❶ or Down ❷ button until CHANGE PASSWORD is selected to change the password, then press the VOLUME Up button ❸.

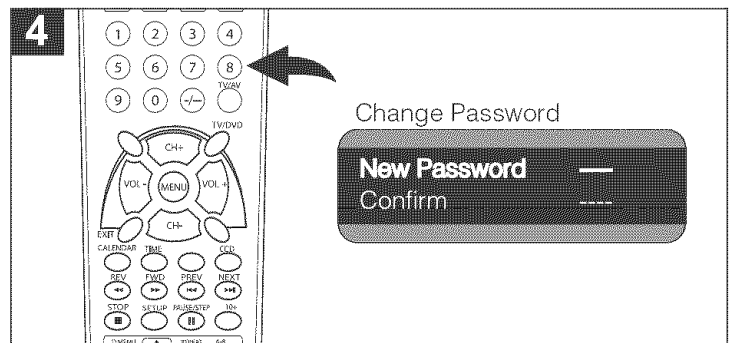

Using the Direct Channel Selection/Number (0-9) buttons (0-9), enter the desired password, then enter again to confirm and make sure to write it down.

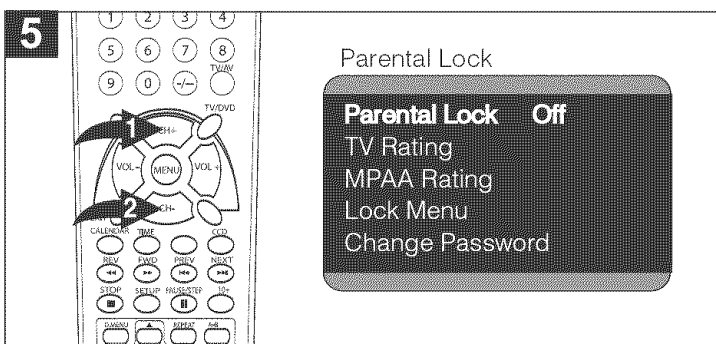

Press the CHANNEL Up ❶ or Down ❷ button until PARENTAL LOCK is selected.

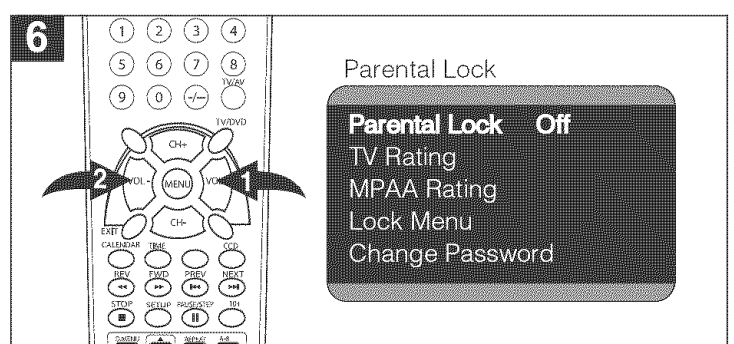

Press the VOLUME Up ❶ or Down ❷ button to turn PARENTAL LOCK option On or Off.

TV PARENTAL CONTROL (CONTINUED)

TV RATING SET-UP

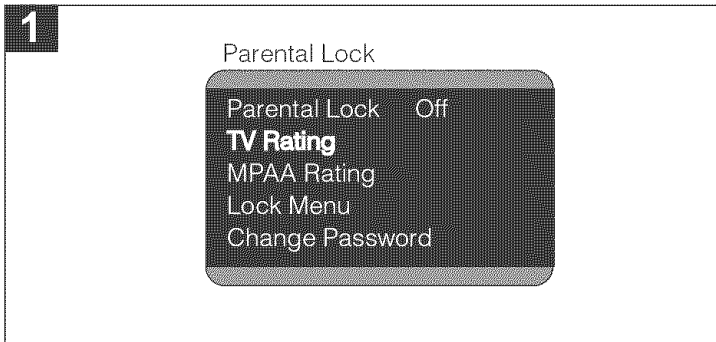

Enter the Parental Lock menu and turn on the V-chip option as described on page 28 (steps 1 and 2).

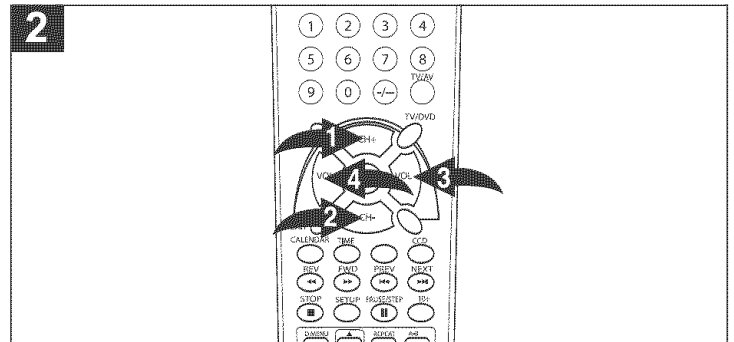

Press the CHANNEL Up ① or Down ② button until TV RATING is selected, then the VOLUME Up ③ or Down ④ button to select it.

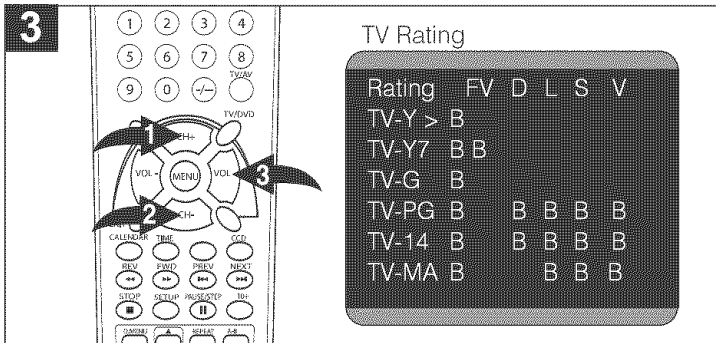

Press the CHANNEL Up ① or Down ② button to select a rating and then the VOLUME Up button ③ to BLOCK (ratings at or above cannot be viewed) or UNBLOCK (ratings at or under can be viewed).

Y: All ages less than 14 years old
Y7: Ages 7 and up old
G: General Audience **MA:** Mature Audiences Only
PG: Parental Guidance
14: Parental Guidance

"B" is blocked and "U" is Unblocked.

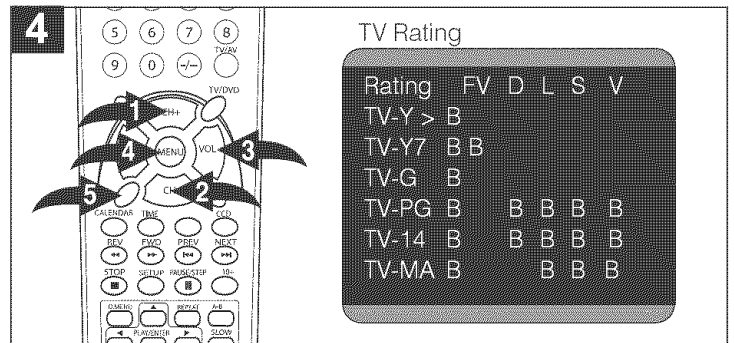

You can also block some or all criteria for each level for Fantasy Violence (FV), Sexual Dialogue (D), Language (L), Sexual Situations (S) or Violence (V).

Using the CHANNEL Up ① or Down ② button, select the desired criteria (to reach the criteria, cycle through the columns using these buttons), then press the VOLUME Up button ③ to turn the option On or Off.

When finished, press the Menu button ④ to return to the Parental Lock menu or press Exit button ⑤ to Exit the menus.

TV PARENTAL CONTROL (CONTINUED)

MPAA RATING SET-UP

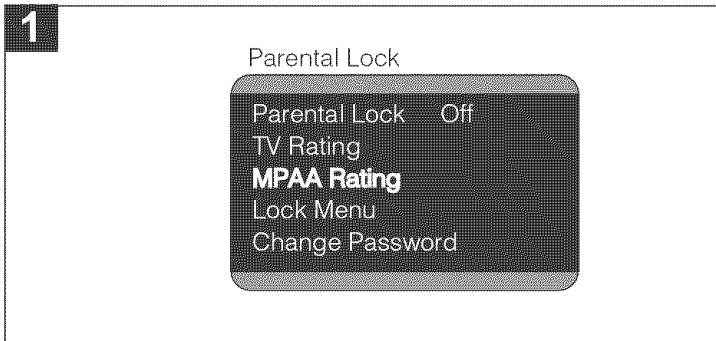

Enter the Parental Lock menu and turn on the V-chip option as described on page 28 (steps 1 and 2).

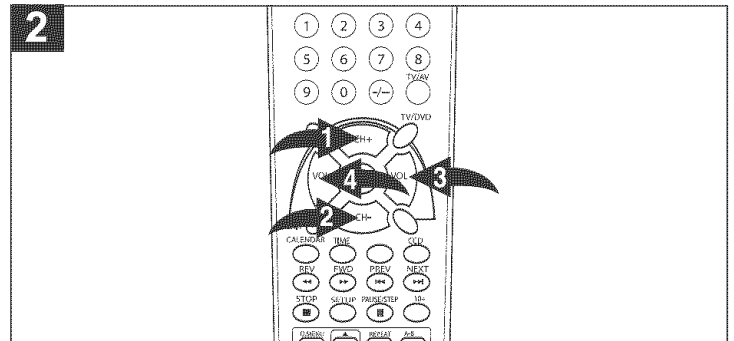

Press the CHANNEL Up **1** or Down **2** button until MPAA RATING is selected, then press the VOLUME Up **3** or Down **4** button to select it.

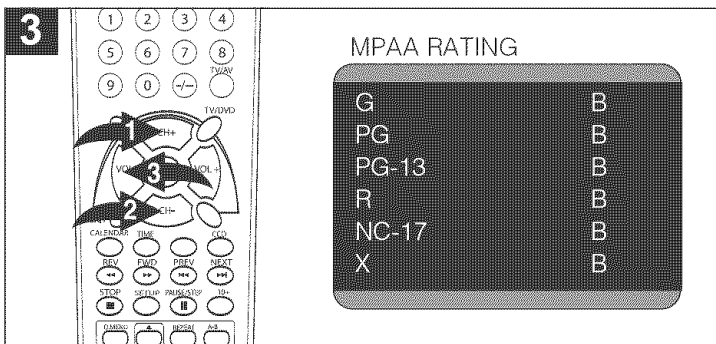

Press the CHANNEL Up **1** or Down **2** button to select a rating and then the VOLUME Down button **3** to BLOCK (ratings at or above cannot be viewed) or UNBLOCK (ratings at or under can be viewed).

G: All ages	R: Under 17 years old,
PG: Parental Guidance	Parental Guidance
PG-13: Parental Guidance	suggested
less than 13 years	NC17: 17 years old and
old	above
	X: Adult only

"B" is blocked and "U" is Unblocked.

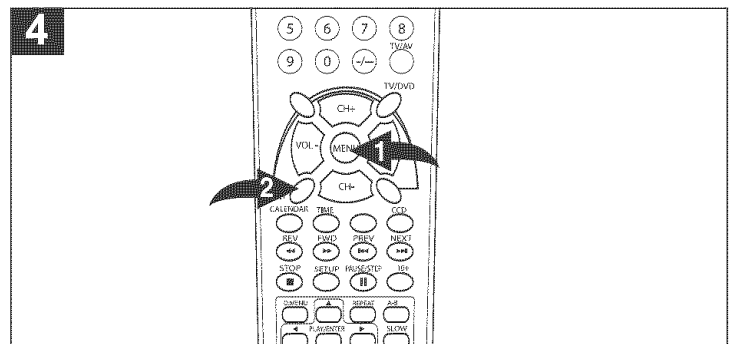

When finished, press the Menu button **1** to return to the Parental Lock menu or press Exit button **2** to Exit the menus.

TV PARENTAL CONTROL (CONTINUED)

LOCK MENU

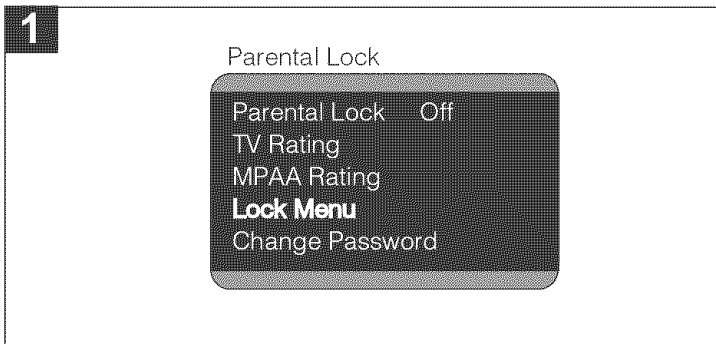

Enter the Parental Lock menu and turn on the V-chip option as described on page 28 (steps 1 and 2).

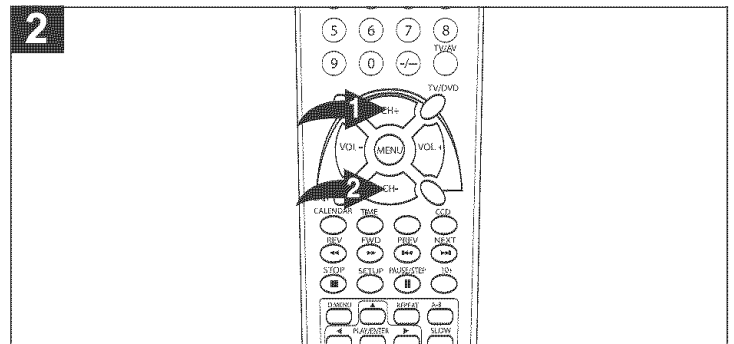

Press the CHANNEL Up **1** or Down **2** button until LOCK MENU is selected.

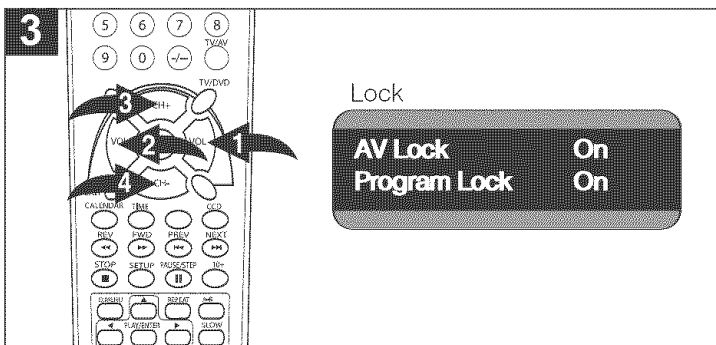

Press the VOLUME Up **1** or Down **2** to enter the Lock menu. Press the CHANNEL Up **3** or Down **4** button to select AV Lock or Program Lock. Press the VOLUME Up **1** or Down **2** to turn the option ON or OFF.

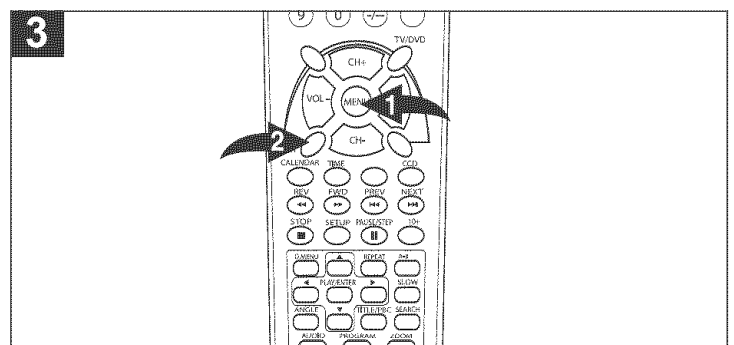

When finished, press the Menu button **1** to return to the Parental Lock menu or press Exit button **2** to Exit the menus.

NOTE: When AV Lock is ON, the Audio/Video 1/Video 2/Component (DVD) IN connections will be locked (cannot be used in this case.).

For the Program Lock, you must select the channel which need to lock before entering the Parental Lock menu in step 1. When Program Lock is ON, the selected channel will be locked.

DVD SETUP MENUS

GENERAL SETUP MENU:

While in the DVD stop mode OR while in DVD mode and without a DVD inserted, press the SETUP button ❶ once to select the GENERAL SETUP Page, select an option below using the Navigation (▲, ▼) buttons ❷, then select using the Navigation (◀, ▶) buttons ❸, then select/change the setup option using the Navigation (▲, ▼) buttons ❷ and the PLAY/ENTER button ❹. To exit the setup menu, press the SETUP button ❶ twice.

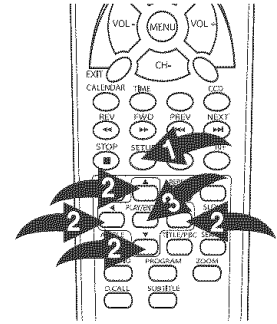

TV DISPLAY

1

General Setup Page..	
TV Display	LB 4: 3:Ps
Angle Mark	On 4: 3:Lb
OSD Lang	ENG 16: 9
Spdif Output	
Caption	On
Screen Saver	Off

4:3/PS: Select when the unit is connected to an external conventional TV. Video material formatted in the Pan Scan style is played back in that style (the left and right edges are cut off).

4:3/LB: Select when the unit is connected to an external normal TV. Wide-screen images are shown on the screen with a black band at the top and bottom.

16:9: Select when the unit is connected to an external wide-screen TV.

ANGLE MARK

1

General Setup Page..	
TV Display	LB
Angle Mark	On On
OSD Lang	ENG Off
Spdif Output	
Captions	On
Screen Saver	Off

Select ON to turn the anglemarks on and OFF to turn them off.

Anglemarks are not available on all DVDs.

OSD LANGUAGE

1

General Setup Page..	
TV Display	LB
Angle Mark	On
OSD Lang	ENG
Spdif Output	
Caption	On
Screen Saver	Off

Select the desired language (ENGLISH, SPANISH) for the On-Screen display to display text. Note that the DVD must have the language included in order to display it.

SPDIF OUTPUT

1

General Setup Page..	
TV Display	LB
Angle Mark	On
OSD Lang	ENG
Spdif Output	Spdif Off
Caption	On Spdif-Raw
Screen Saver	Off Spdif-Pcm

SPDIF OFF: An analog surround sound format is output through the rear connectors for two channel audio out or 5.1 channel audio out.

SPDIF/RAW or PCM: This surround sound format is output to a Dolby Digital/DTS decoder through the coaxial out jack.

CAPTIONS

1

General Setup Page..	
TV Display	LB
Angle Mark	On
OSD Lang	ENG
Spdif Output	
Captions	On On
Screen Saver	Off Off

When this option is set to ON, closed captions will appear on the screen for the hearing impaired (if originally recorded on the DVD). When this option is OFF, the closed captions will not appear.

SCREEN SAVER

1

General Setup Page..	
TV Display	LB
Angle Mark	On
OSD Lang	ENG
Spdif Output	
Caption	On
Screen Saver	Off On
	Off

When this option is set to ON, the screen saver will come on when the unit stops or the image is paused for approximately 3.5 minutes.

When this option is OFF, the screen saver will not come on.

DVD SETUP MENU (CONTINUED)

PARENTAL

The Parental option enables parents to prevent their children from watching inappropriate material on a DVD. It reads the ratings for programming, then denies access to programming if the program's rating meets the limitations you select. In this case, the user will have to enter a password.

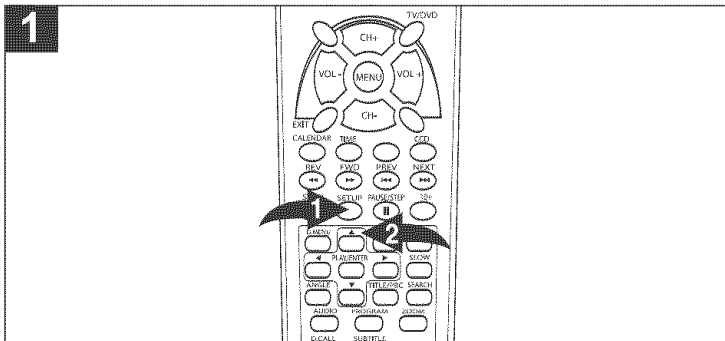

While in the DVD stop mode OR while in DVD mode and without a DVD inserted, press the SETUP button ❶ twice; the Password Page will appear. Use the Navigation (▲, ▼) buttons ❷ to select PARENTAL.

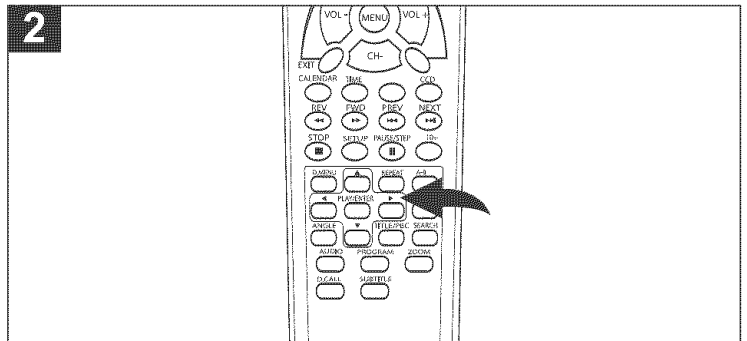

Press the Navigation (▶) button and then select the desired parental setting for the DVD player using the Navigation (▲, ▼) buttons.

- | | | | |
|--------------|-------------------------------------------|------------|-----------------------------------------------------------|
| 1 (KIDSAFE): | Kidsafe. | | suggested. |
| 2 (G): | All ages. | 6 (R): | Under 17 years old, Parental Guidance strongly suggested. |
| 3 (PG): | Parental Guidance. | 7 (NC17): | 17 years old and above. |
| 4 (PG13): | Parental Guidance less than 13 years old. | 8 (ADULT): | Adult only. |
| 5 (PGR): | Under 17 years old, Parental Guidance | OFF: | Allows all programming. |

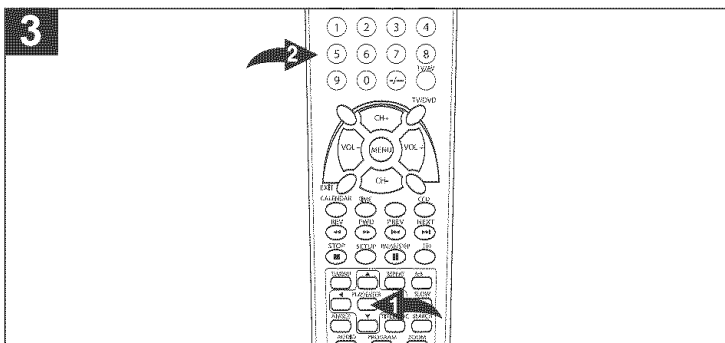

Press the PLAY/ENTER button ❶ and the password screen will appear. Input the 4 digit password using the Direct Channel Selection/Number (0-9) buttons ❷, then press the PLAY/ENTER button ❸.

- NOTE:**
- The default password is 1234.

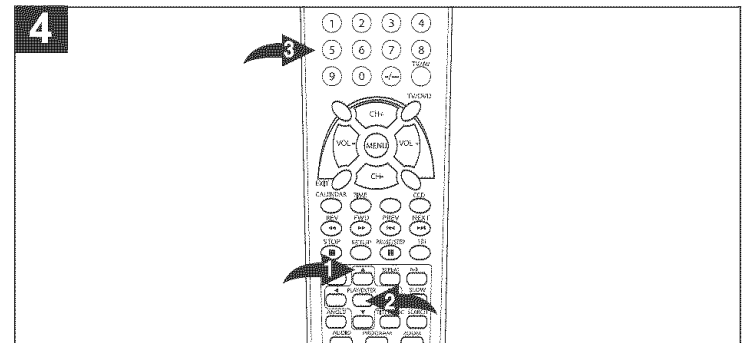

To change the password, select PASSWORD using the Navigation (▲, ▼) buttons ❶, then press the PLAY/ENTER button ❷ twice; the password screen will appear. Enter the Old Password, New Password and then the New Password again using the Direct Channel Selection/Number (0-9) buttons ❸, then press the PLAY/ENTER button ❹ to confirm the change.

DEFAULT: While in DVD stop mode, press the SETUP button twice, then select DEFAULT using the Navigation (▲, ▼) buttons, then press the PLAY/ENTER button twice to change the DVD defaults (except password and parental) to the factory settings.

BASIC OPERATION

DISPLAY

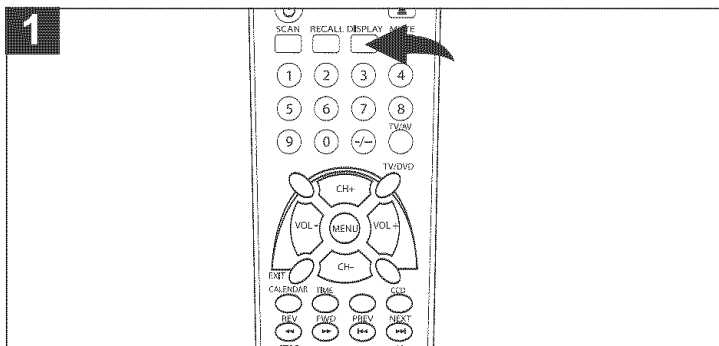

While in the TV mode, press the Display button to show the current channel. If in an AV mode, the mode will appear when pressed. Press again to clear the display.

MUTE

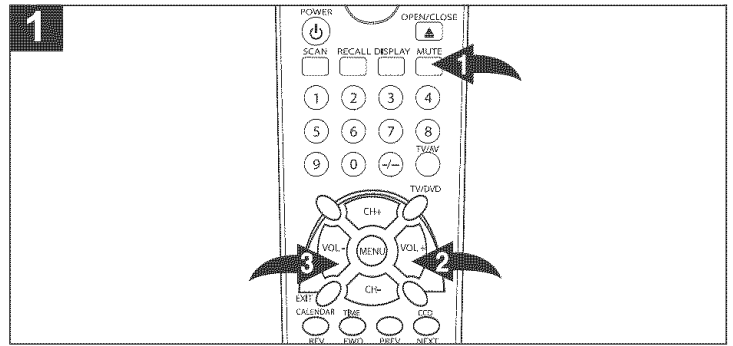

Press the Mute button ① to turn off the sound; the unit's sound will be silenced and "Mute" will appear on the screen. The sound can be turned back on by pressing this button again or one of the VOLUME Up ② or Down ③ buttons.

TV/AV

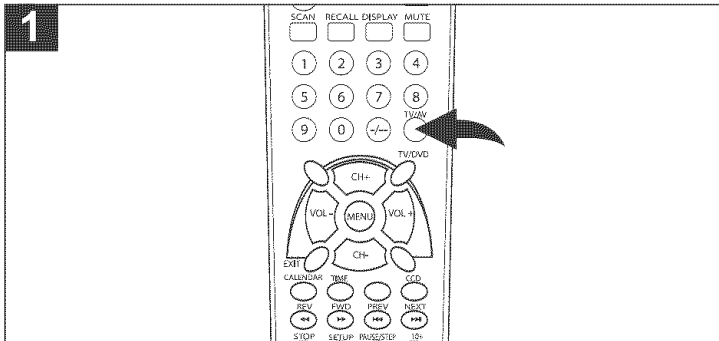

Press to select TV (CATV), VIDEO 1 (Front jacks), VIDEO 2 (Rear jacks) or DVD (Component).

TV/DVD

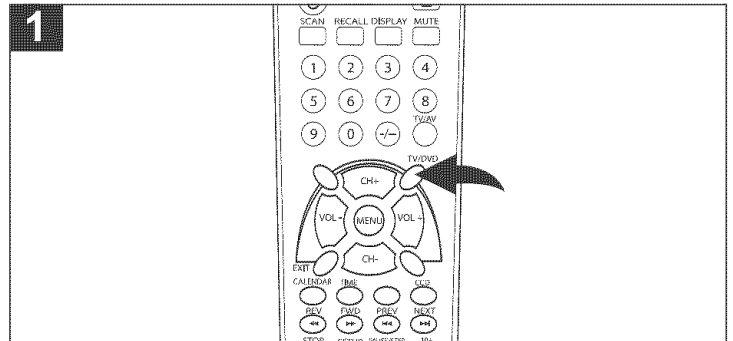

Press to select the TV mode or the INNER DVD mode.

P.STD (Picture Standard)

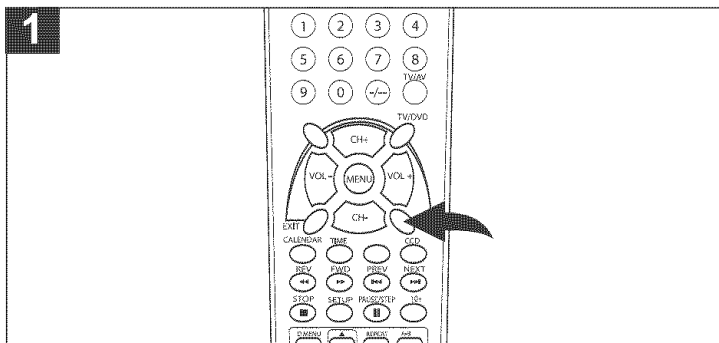

Press to select between the picture modes (Standard, Vivid, Personal, Listen {select just to listen, not to watch}, or Movie).

HEADPHONE JACK

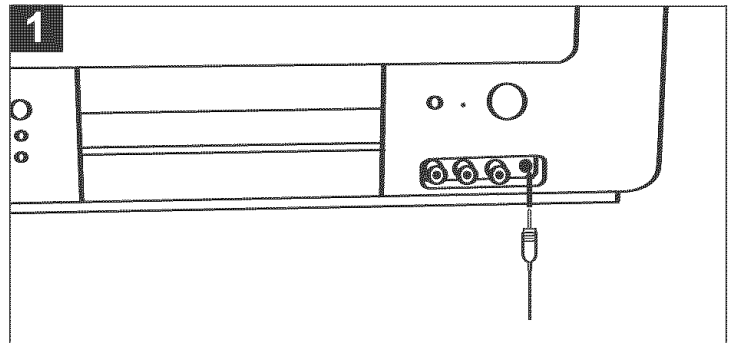

For private listening, plug headphones into this jack. The speakers will be disconnected when a plug is inserted into this jack.

BASIC OPERATION (CONTINUED)

CALENDAR

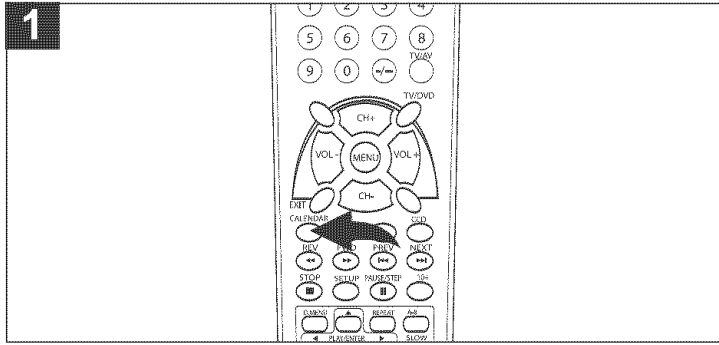

Press to access the Calendar setting menu (see page 27).

TIME

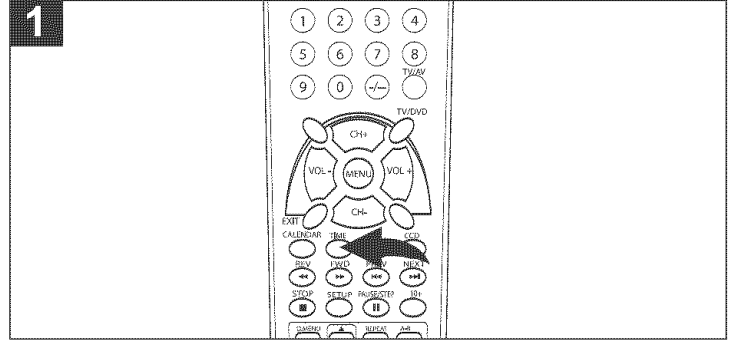

Press to access the Time setting menu (see page 17).

NOTE: This menu cannot be accessed while in the DVD mode.

VOLUME Buttons

Set the sound as follows:

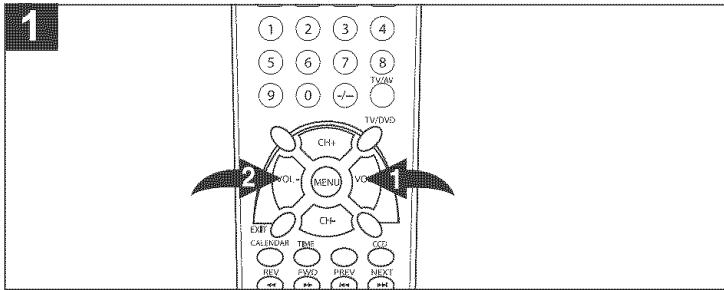

Press the VOLUME Up ①/Down ② buttons to adjust the sound level.

TV BASIC OPERATION

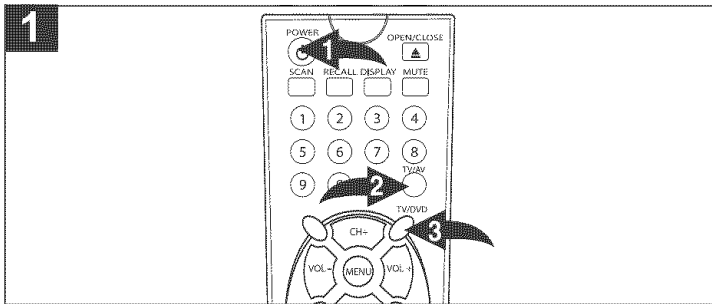

Press the **POWER** button ❶ on the remote, or front of the unit, to turn on the unit; the **POWER** indicator will light yellow. Press the **TV/AV** button ❷ repeatedly to select the TV mode. If the unit is in DVD mode, press the **TV/DVD** button ❸ first, then press the **TV/AV** button repeatedly to select TV mode.

2 OPTIONS

TV: If using a VHF/UHF antenna.

CATV: If using Cable TV.

Change the Antenna option to select between TV or CATV. Select AIR if using VHF/UHF antenna, and select CATV if using Cable TV (see page 25, steps 1 and 2).

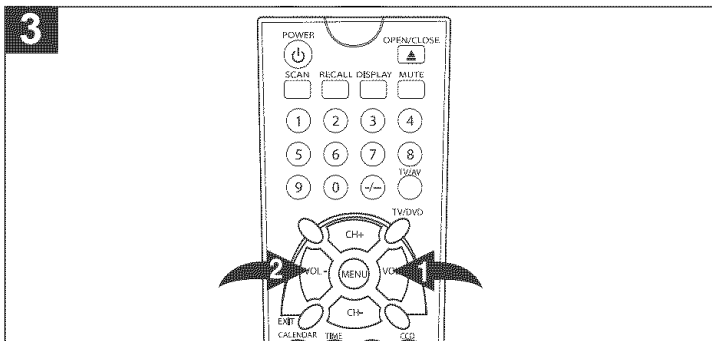

Adjust the volume level by pressing the **VOLUME Up** ❶ or **Down** ❷ button.

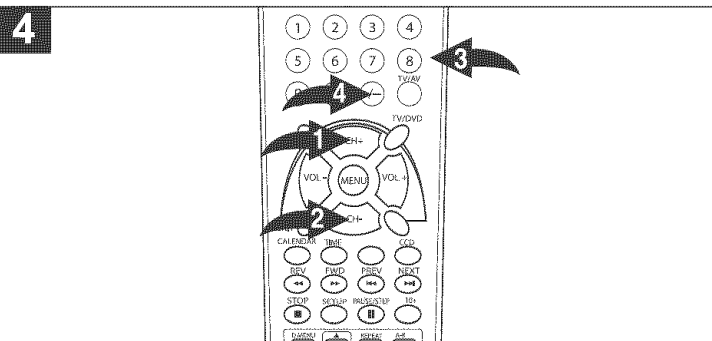

For proper operation, before selecting channels, they must be set into the unit's Program memory, see page 25. Press and release the **CHANNEL Up** ❶ or **Down** ❷ button. The unit automatically stops at the next channel set into memory.

Direct Program Selection/Number buttons (0-9) ❸
Use these buttons to select a channel. The channel number will appear at the top right corner of the screen.

- For Channels 1 through 9, press 1-9 ❸ as desired.
- For Channels 10 through 99, press **-/--** button ❹ once, then enter the 2 digit channel number in order.
- For Channels 100 through 125, press **-/--** button ❹ twice, then enter the 2 digit channel number in order.

NOTES:

- When **ANTENNA** option is set to AIR, only channels up to 69 can be chosen. When set to CABLE, channels up to 125 can be chosen.

FAQs:

Why do I only receive 69 channels, when my cable goes much higher?
The TV/CATV option must be set to CATV when using cable, see step 2 above.

Why are some channels scrambled?
You must subscribe to these channels through your cable company.

TV BASIC OPERATION (CONTINUED)

SCAN

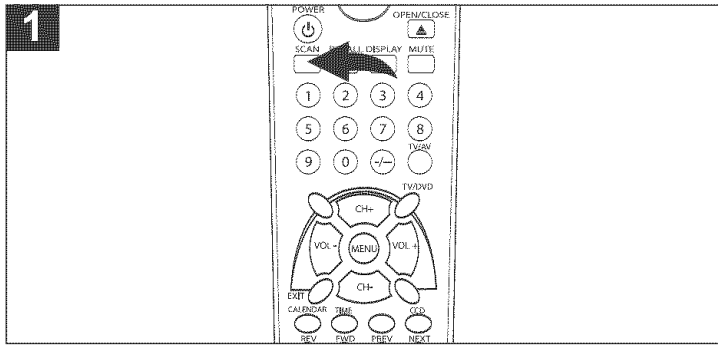

Press the SCAN button and the unit will automatically scan each station. When you see a channel you would like to view, press the SCAN button again.

RECALL

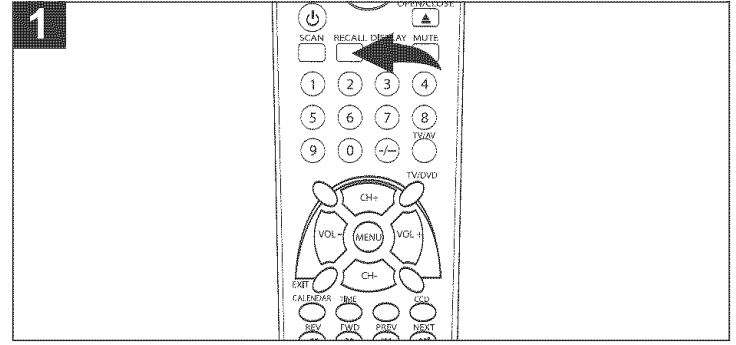

Press the RECALL button to switch between the present channel and the last channel chosen.

CLOSED CAPTIONS

WHAT IS CLOSED CAPTIONING?

This television has the capability to decode and display Closed Captioned television programs. Closed Captioning will display text on the screen for hearing-impaired viewers or it will translate and display text in another language.

CLOSED CAPTIONING WITH A VCR

Closed Captioned programs can be recorded and played back on a VCR with the Closed Captioned text intact. The Closed Captioned text will disappear during Cue (Fast Forward Search), Review (Rewind Search) and Pause Modes or if the VCR tracking is not adjusted properly.

TO VIEW CLOSED CAPTIONS

Select the CC option in the menu to switch between normal TV and the Closed Caption Modes (Captions and Full Screen Text).

C1: This Closed Caption Mode will display text on the screen in English or another language. Generally, Closed Captions in English are transmitted on Captions 1.

C2-C4: These Closed Caption Modes will display text on the screen in English or another language. Generally, Closed

Captions in other languages are transmitted on these channels.

TEXT: The Text Closed Caption Mode will usually fill the screen with a programming schedule or other information. Select between TT1, TT2, TT3 or TT4.

After selecting a Closed Caption Mode, it will stay in effect until it is changed, even if the channel is changed. If the Captions signal is lost due to a commercial or a break in the signal, the Captions will reappear when the signal is received again. If the channels are changed, the Captions will be delayed approximately 10 seconds.

The Captions will appear in places on the screen where they will least interfere with the picture, usually on the bottom of the screen. News programs will usually show three-line Closed Captions which scroll onto the screen. Most other shows provide two or three lined Captions placed near the character who is speaking so the viewer can follow the dialogue.

Words in italics or underlined describe titles, words in foreign languages or words requiring emphasis. Words that are sung usually appear enclosed by musical notes.

For television programs broadcasting with Closed Captions, look in your TV guide for the Closed Captions symbol (CC).

NOTES:

- When selecting Closed Captions, the captioning will be delayed approximately 10 seconds.
- Misspellings or unusual characters may occasionally appear during Closed Captioning. This is normal with Closed Captioning, especially with live programs. This is because during live programs, captions are also entered live. These transmissions do not allow time for editing.
- When Captions are being displayed, on-screen displays, such as Mute, may not be seen or may interfere with Closed Captions.
- Some cable systems and copy protection systems may interfere with the Closed Captioned signal.
- If using an indoor antenna or if TV reception is very poor, the Closed Caption Decoder may not appear or may appear with strange characters or misspelled words. In this case, adjust the antenna for better reception or use an outdoor antenna.

CLOSED CAPTIONS

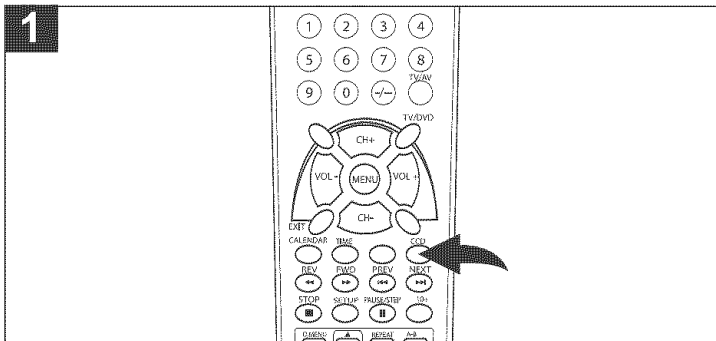

Press the CCD button to turn the Closed Captions on to the setting as set in the Caption's menu (see page 23). Press again to turn off.

Closed Captioning will display text on the screen for the hearing impaired.

FAQs:

When I press the RECALL or MUTE button, the captions do not appear, is this normal?

Yes, this is normal for this unit. Once the display information disappears, the captions will continue.

I entered the Captions mode, but no captions are appearing, why?

If no caption signal is received, no captions will appear, but the television will remain in the Caption mode.

Why is there a big black box on the screen?

Because you are in a Captions mode. Turn the captions off, or select a different Captions mode.

DVD BASIC OPERATION (GENERAL)

IMPORTANT:

When “⊘” appears while pressing a button, this means that the corresponding function cannot be performed either on the disc inserted, or in the selected mode.

AUDIO MODE

You can cycle between the audio modes as follows:

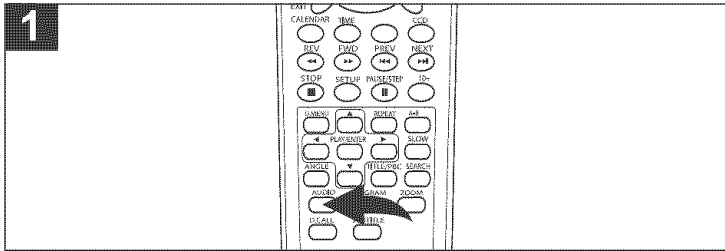

For DVD, Press the AUDIO button repeatedly to cycle through the audio languages available on the playing DVD.
For CD/VCD, Press the AUDIO button repeatedly to cycle through Stereo, Mono Left, Mono Right and Mix-Mono.

DVD CALL BUTTON

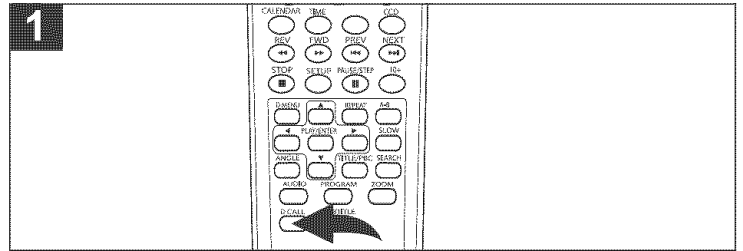

Press the DVD CALL (D. CALL) button to show the elapsed time and remaining time of the playing disc. Each time the DVD CALL button is pressed, the time will change on the screen as follows:

DVD: Title Elapsed, Title Remain, Chapter Elapsed, Chapter Remain, Display Off.

VCD: repeatedly press the button for Single Elapsed, Single Remain, Total Elapsed, Total Remain or Display Off.

MUTE

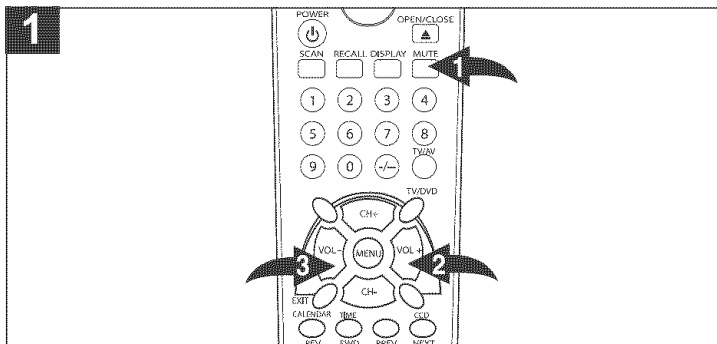

Press the Mute button ① to turn off the sound; the unit's sound will be silenced and "Mute" will appear on the screen. The sound can be turned back on by pressing this button again or one of the VOLUME Up ② or Down ③ buttons.

DVD BASIC OPERATION (GENERAL) (CONTINUED)

IMPORTANT NOTES:

- “” will appear on the TV screen during operation if you try to access a function that is not available on the disc.
- Some discs may take a few seconds to load.
- If a disc is inserted incorrectly, dirty, damaged, or is not present at all, “NO DISC” will appear in the display.
- Always hold the disc without touching either of its surfaces. When inserting a disc, position it with the printed title side facing up, align it with the guides and place it in its proper position.
- It is important that you read the manual that accompanies the DVD disc as there are features that are on this DVD player that cannot be used with certain DVDs. There are also extra features that are different for each DVD disc, so they are not explained in this owner’s manual.

PLAYBACK OF A DVD

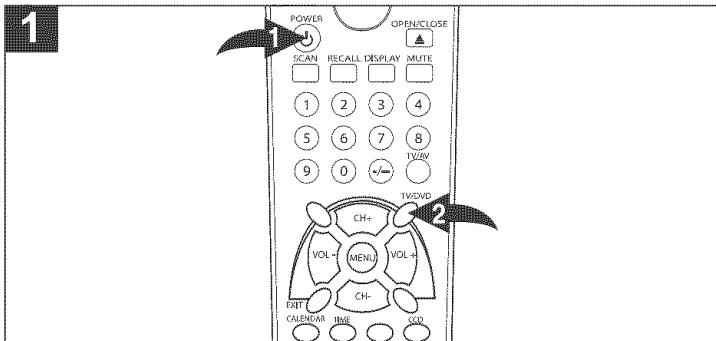

Press the POWER button ❶ to turn on the unit; the POWER indicator will light yellow. Press the TV/DVD button ❷ repeatedly to select the DVD mode.

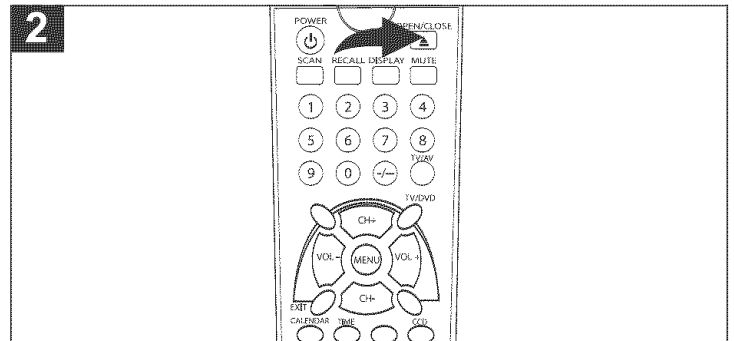

Press the OPEN/CLOSE button to open the disc tray, “OPEN” will appear on the screen. Insert a disc with the label side facing up on the disc tray.

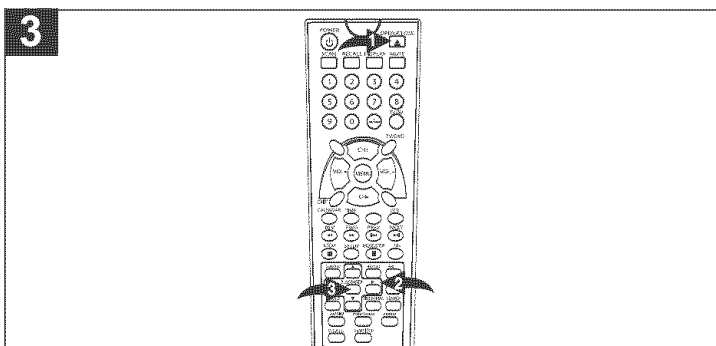

Press the OPEN/CLOSE button ❸ to close the disc tray. “LOADING” will appear on the screen. After loading, the menu screen of the DVD should appear. Use the Navigation (◀, ▶, ▲, ▼) buttons ❹ to select the desired option and the PLAY/ENTER button ❺ to select it. If the password is set and the inserted disc is within the Parental Ratings set, then the Password screen will appear, prompting you to enter the password.

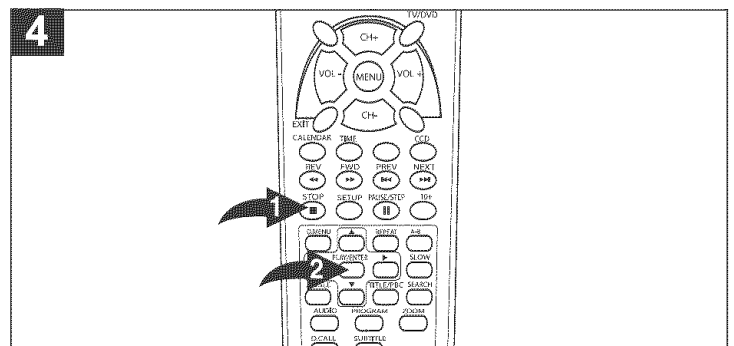

To stop playback, press the Stop button ❶; “PRESS PLAY KEY TO CONTINUE” will appear on the TV screen. Because the unit will remember where you stopped, simply press the PLAY/ENTER button ❷ to resume playback where you left off (resuming playback). If the Stop button ❶ is pressed twice, the unit will stop completely.

NOTES:

- If a MENU appears on the TV screen, press the Navigation (◀, ▶, ▲, ▼) buttons to select the desired option/item, then press the PLAY/ENTER button. Please make sure to refer to the disc’s jacket or case for additional information.
- Resuming playback may not work on all discs.
- When the unit is on and in the Stop mode for 30 minutes, it will revert to the Standby mode automatically.

DVD BASIC OPERATION (GENERAL) (CONTINUED)

SKIP

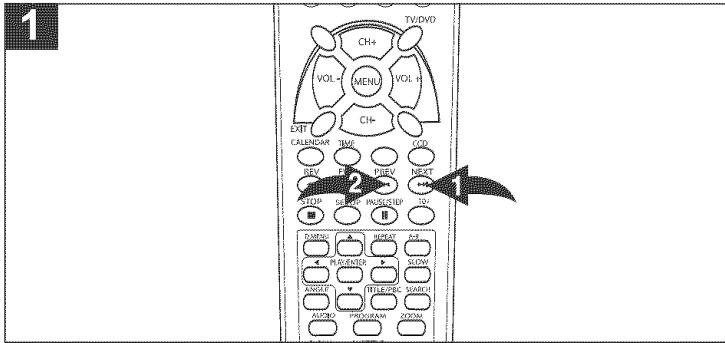

Press the SKIP (▶▶) button ❶ to advance the DVD to the beginning of the next chapter.

Press the SKIP (◀◀) button ❷ to move the DVD to the beginning of the previous chapter.

FAST SEARCH

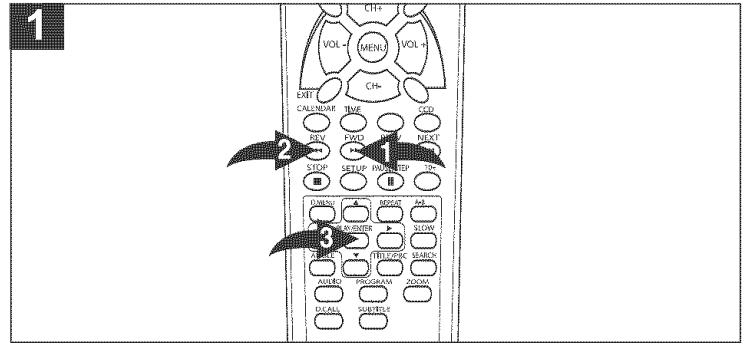

During playback, press either the FWD ▶▶ ❶ or REV ◀◀ ❷ button to move the DVD forward or backward at double (x2) speed to locate a specific section. Repeatedly press these buttons and the speed will increase to x4, x8, x16, x32 (the sound will be muted) and resume normal playback. You can also resume normal playback by pressing the PLAY/ENTER button ❸.

SLOW

Use this feature to move the DVD in slow motion.

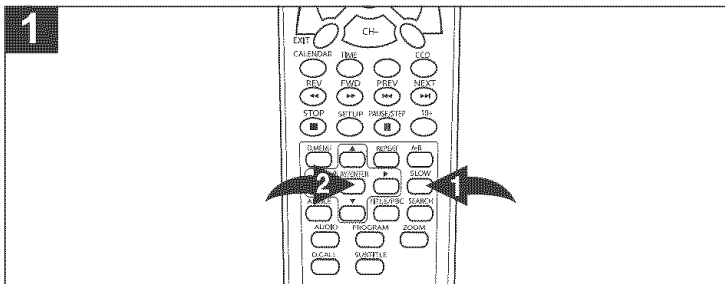

During playback, press the SLOW button ❶ to move the DVD forward in slow motion speeds of 1/2, 1/4, 1/8, 1/16 (the sound will be muted) and resume normal playback. You can also resume normal playback by pressing the PLAY/ENTER button ❷.

PAUSE/STEP

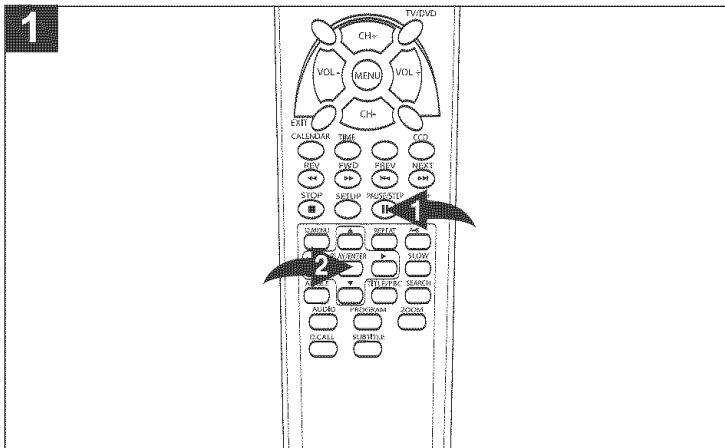

Press the PAUSE/STEP button ❶ to pause the picture.

Repeatedly press the PAUSE/STEP button ❶ to play the DVD one frame at a time.

Press the PLAY/ENTER button ❷ to resume normal playback.

If the Screen Saver option (page 32) is set to ON, the screen saver will appear in approximately 3.5 minutes.

DVD BASIC OPERATION (GENERAL) (CONTINUED)

TITLE/CHAPTER SEARCH

Use this feature to directly go to a specific title and/or chapter.

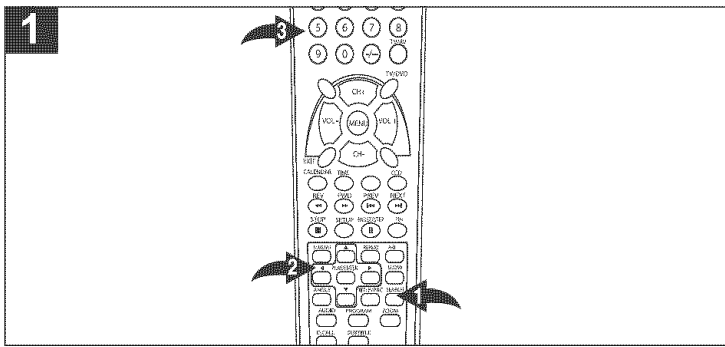

Press the SEARCH button ❶ once. Press the Navigation (◀, ▶) buttons ❷ to select the Title, then use the Direct Channel Selection/Number buttons (0-9) ❸ to select the desired title number. Playback will start immediately.

OR
Press the Navigation (◀, ▶) buttons ❷ to select the Chapter, then use the Direct Channel Selection/Number buttons (0-9) ❸ to select the desired chapter number. Playback will start immediately.

TITLE/CHAPTER/TIME SEARCH

Use this feature to directly go to a specific title and/or time.

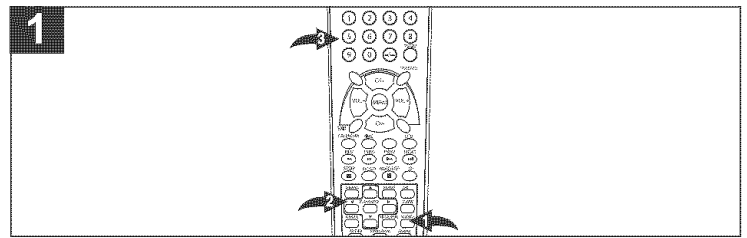

Press the SEARCH button ❶ twice. Press the Navigation (◀, ▶) buttons ❷ to select the Title, then use the Direct Channel Selection/Number buttons (0-9) ❸ to select the desired title number. Playback will start immediately. **OR**

Press the Navigation (◀, ▶) buttons ❷ to select the Time, then use the Direct Channel Selection/Number buttons (0-9) ❸ to select the desired Title Time (Hour/Minutes/Seconds); playback will start immediately.

Press the SEARCH button ❶ a third time. Press the Navigation (◀, ▶) buttons ❷ to select the chapter, then use the Direct Channel Selection/Number buttons (0-9) ❸ to select the desired chapter number. Playback will start immediately. **OR**

Press the Navigation (◀, ▶) buttons ❷ to select the Chapter Time, then use the Direct Channel Selection/Number buttons (0-9) ❸ to select the desired chapter time (Hour/Minutes/Seconds); playback will start immediately.

To enter a title or chapter number larger than 9, press the 10+ button to enter the first digit (i.e. for Title/Chapter 15, press the 10+ button once "1-" will appear, then press the Number 5 button; for Title/Chapter 22, press the 10+ button twice follow by press the Number 2 button, etc.).

REPEAT PLAYBACK

While playing back a DVD, this unit can repeatedly play back a chapter or title.

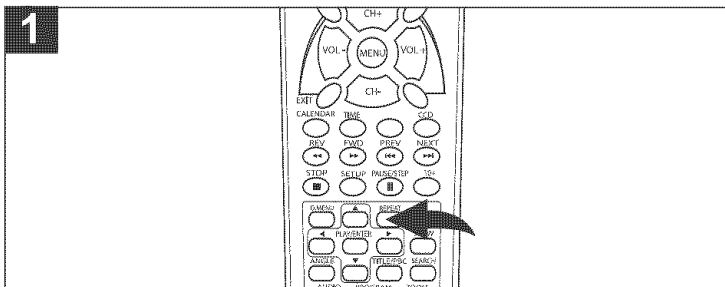

While in the Playback mode, press the REPEAT button once; "◌ CHAPTER" will appear on the TV screen and the currently playing Chapter will repeat continuously.

While in the Playback mode, press the REPEAT button a second time; "◌ TITLE" will appear on the TV screen and the currently playing Title will repeat continuously.

While in the Playback mode, press the REPEAT button a third time; "◌ ALL" will appear on the TV screen and the complete disc will repeat continuously. Press the REPEAT button once more to cancel Repeat mode.

A-B REPEAT PLAYBACK

While playing back a DVD, this unit can repeatedly play back a specific section.

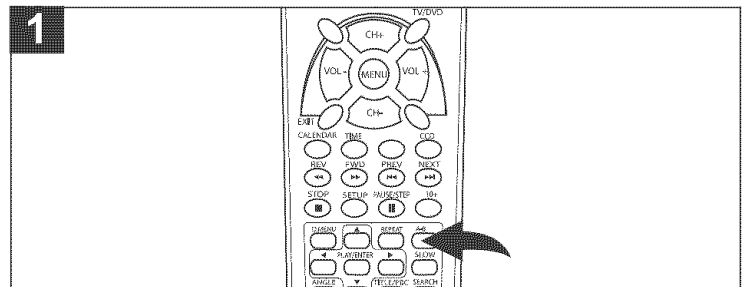

While in the Playback mode, press the Repeat A-B button to define where you want the section to start. Press the Repeat A-B button again to define where you would like the section to end, the unit will then play the selected area continuously. Press the Repeat A-B button again to cancel A-B Repeat mode.

NOTE:

- If you enter a time that exceeds the time limit of the DVD, then "⏏" will appear, and you must try again.
- Repeat may not work properly with some discs.

DVD BASIC OPERATION (GENERAL) (CONTINUED)

AUDIO LANGUAGE

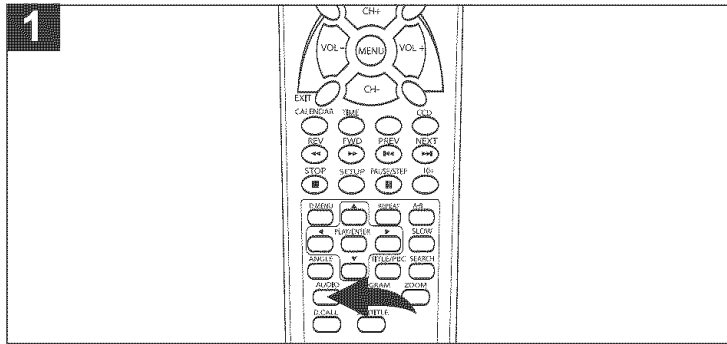

Press the AUDIO button repeatedly to change the audio language. This feature is not available on all discs.

SUBTITLE MENU

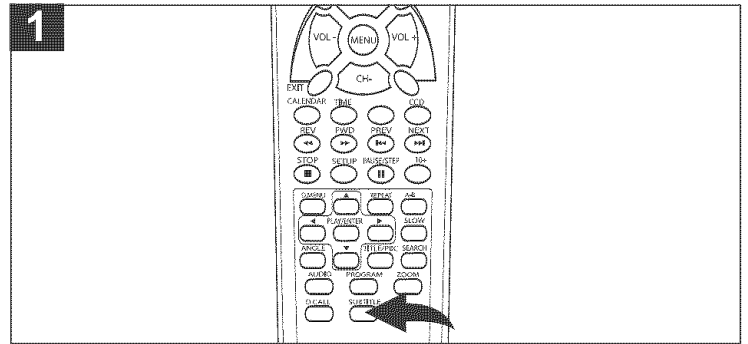

Press the SUBTITLE button repeatedly to select a subtitle language, and to turn the subtitle menu on/off. This feature is not available on all discs.

DVD MENU

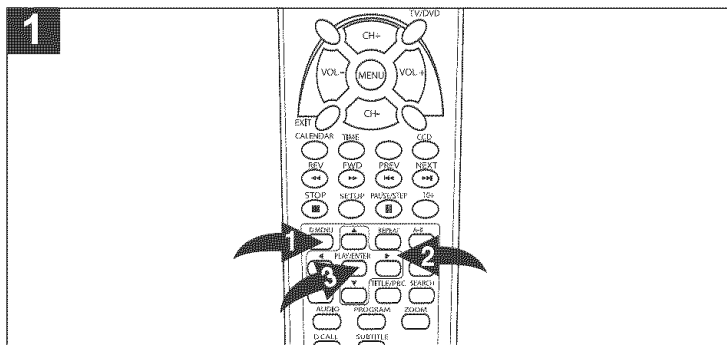

Press the D.MENU button ❶, and the Main Menu of the disc will appear. Use the Navigation (◀, ▶, ▲, ▼) buttons ❷ to select the desired option, and then press the PLAY/ENTER button ❸.

This is not available on all discs.

TITLE MENU

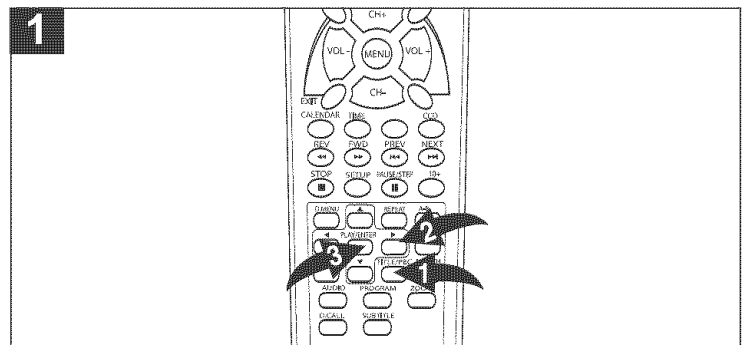

Press the TITLE/PBC button ❶, and the Title Menu of the disc will appear. Use the Navigation (◀, ▶, ▲, ▼) buttons ❷ to select the desired option, and then press the PLAY/ENTER button ❸.

This is not available on all discs.

ZOOM IN

The image on the screen can be magnified as follows:

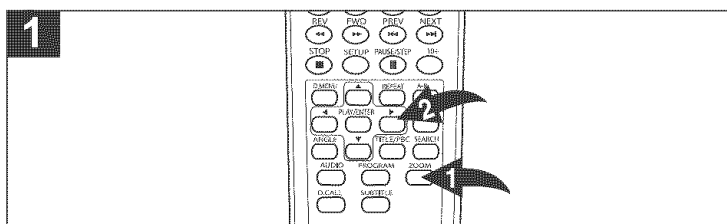

Press the ZOOM button ❶ once during Normal, Slow or Pause playback modes, and the unit will zoom x2. Press once or twice more and the unit will zoom x3/x4. Use the Navigation (◀, ▶, ▲, ▼) buttons ❷ to move the image on the TV screen. Press the ZOOM button ❶ once more to cancel the zoom function.

This is not available on all discs.

ANGLE

Some discs may contain scenes which have been shot simultaneously from a number of different camera angles. This feature only works on discs with more than one camera angle. The jacket will be marked with "◻".

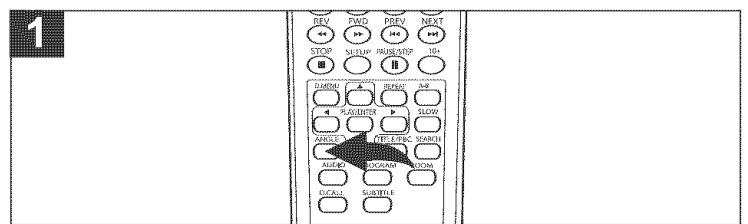

While in the Playback mode, press the ANGLE button; the total number of angles will appear on the screen. Repeatedly press the ANGLE button to select the desired angle; the angle will change in one to two seconds.

This is not available on all discs.

DVD BASIC OPERATION (GENERAL) (CONTINUED)

PROGRAMMED PLAYBACK

The DVD player in this unit has a 20 chapter programmable memory that allows you to program up to 20 chapters on any disc for playback in any desired order. You may program 20 different chapters or you may also program certain chapters to play more than once. To perform programmed playback, proceed as follows:

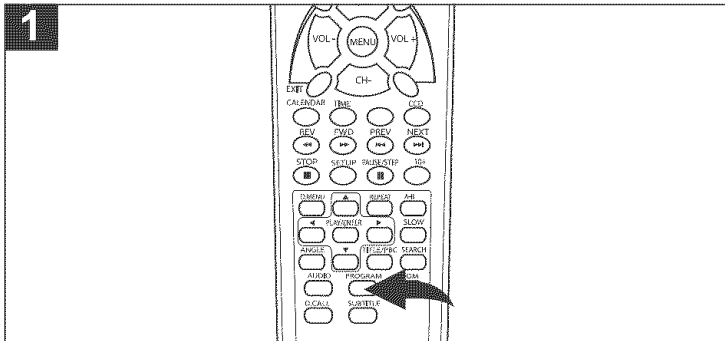

Press the PROGRAM button, the Program menu will appear on the TV screen.

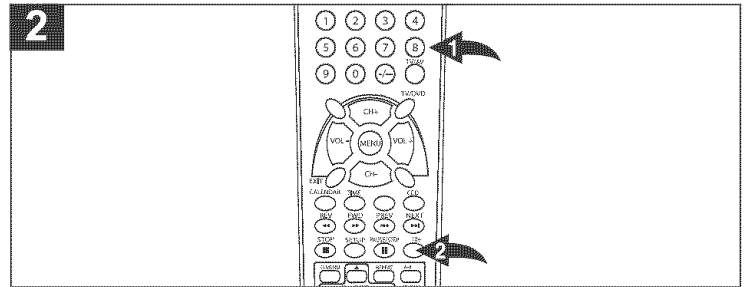

Select the first title and chapter to be played back using the Direct Channel Selection/Number buttons (0-9) ❶; the next program will automatically be highlighted.

To enter a title or chapter number larger than 9, press the 10+ button to enter the first digit (i.e. for Title/Chapter 15, press the 10+ button once "1-" will appear, then press the Number 5 button; for Title/Chapter 22, press the 10+ button twice follow by press the Number 2 button, etc.).

NOTE: If an incorrect title or chapter has been entered, it will remain highlighted and you need to enter the available chapter again.

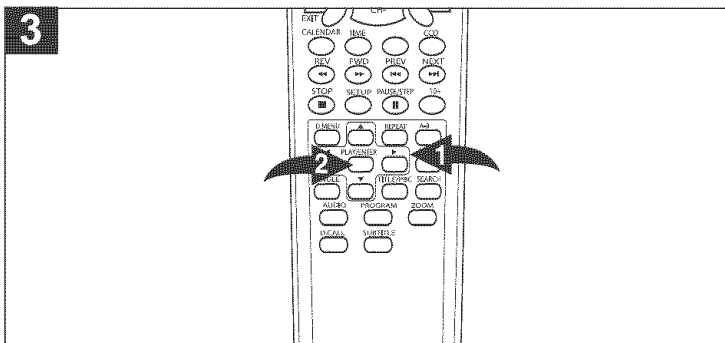

Repeat step 2 until all desired chapters have been programmed. You can repeat a chapter more than once if desired.

To program more than 10 programs, scroll to the ►► symbol at the bottom right of the screen using the Navigation (◀, ▶, ▲, ▼) buttons ❶ and press the PLAY/ENTER button ❷.

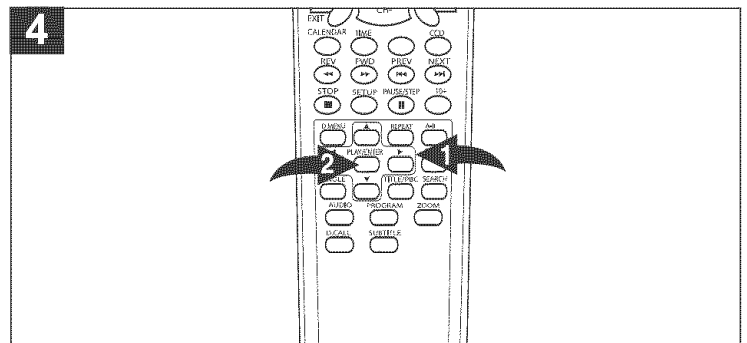

To play, scroll to START using the Navigation (◀, ▶, ▲, ▼) buttons ❶, then press the PLAY/ENTER button ❷. Playback will begin on the first chapter that you programmed and the player will continue to play all of the chapters that you programmed in the order in which you programmed them.

TO CANCEL THE PROGRAM FUNCTION:

Press the PROGRAM button to enter the program menu, then select STOP using the Navigation (◀, ▶, ▲, ▼) buttons, then press the PLAY/ENTER button. To exit the program menu, select EXIT using the Navigation (◀, ▶, ▲, ▼) buttons, then press the PLAY/ENTER button to exit the menu."

CD/VCD BASIC OPERATION

PLAYBACK OF A CD/VCD

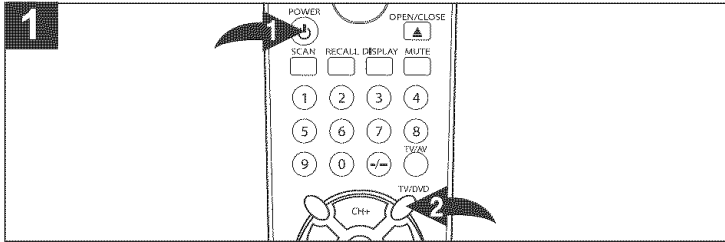

Press the POWER button ❶ to turn on the unit; the POWER indicator will light yellow. Press the TV/DVD button ❷ repeatedly to select the DVD mode.

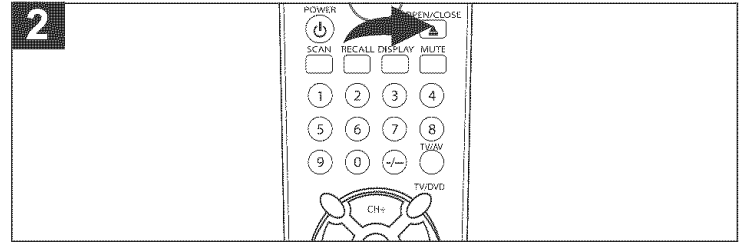

Press the OPEN/CLOSE button to open the disc tray, "OPEN" will appear on the screen. Insert a disc with the label side facing up on the disc tray.

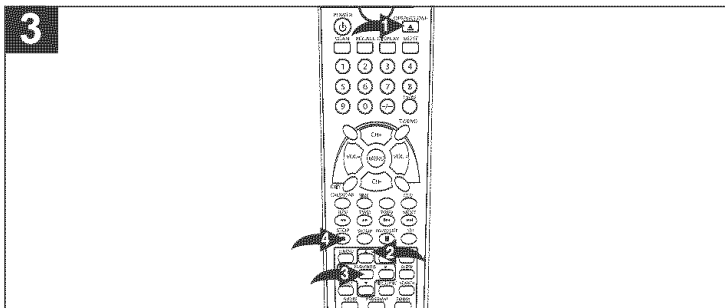

Press the OPEN/CLOSE button ❶ to close the disc tray. "CLOSE" will appear on the screen. **FOR CD:** After loading, the TRACK menu will appear on the TV screen. Press the Navigation (▲, ▼) buttons ❷ to select the desired track. Press the PLAY/ENTER button ❸ to start playback. **For VCD:** after loading, playback will start automatically. Press the STOP (■) button ❹ to stop playback.

SELECTING TRACKS USING THE NUMBER BUTTONS

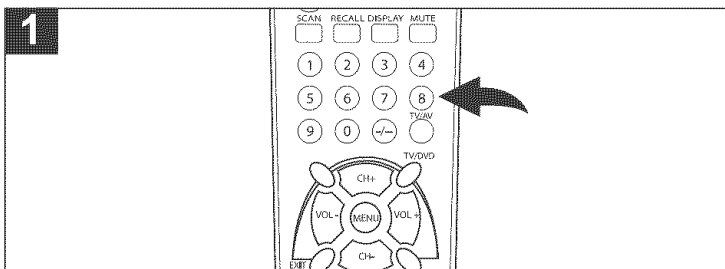

For CD: During playback, press the Number buttons corresponding to the track numbers to select your desired track, and the unit will playback the desired track automatically.

NOTE: For track no. 2, press "0", "0" and "2"; playback will start immediately.

For VCD: during playback, press the number 0-9 button for track 0 to track 9, for numbers larger than 9, press the 10+ button to enter the first digit (i.e. for track 15, press the 10+ button once "1-" will appear, then press the Number 5 button, for track 22, press the 10+ button twice follow by press the Number 2 button, etc.).

SELECTING TRACKS USING THE SKIP (▶▶) OR (◀◀) BUTTON (FOR VCD ONLY)

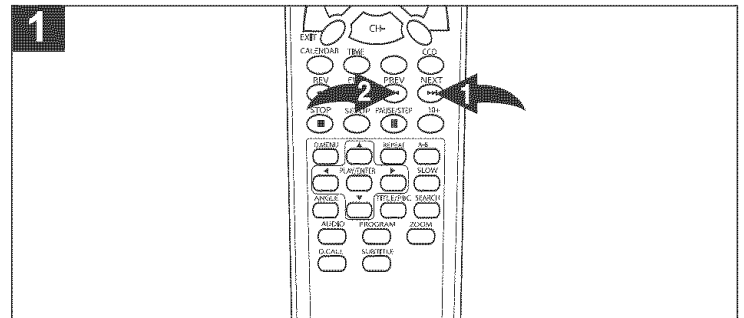

During playback, press the Skip (▶▶) ❶ or (◀◀) ❷ button to select a track to be played.

SELECTING TRACKS USING THE NAVIGATION BUTTONS (FOR CD ONLY)

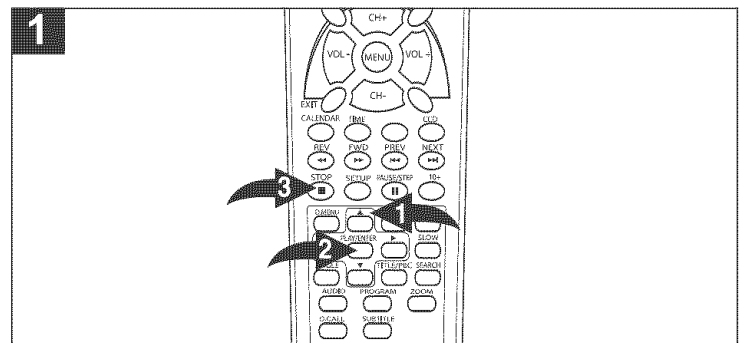

During playback, simply press the Navigation (▲, ▼) buttons ❶ to select the desired track, then press the PLAY/ENTER button ❷ to confirm and play the track. Press the STOP (■) button ❸ to stop playback.

CD/VCD BASIC OPERATION (CONTINUED)

FORWARD ►►/REVERSE ◀◀

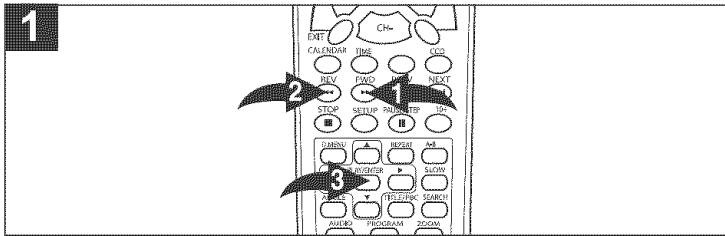

Each press of the FWD ►► ❶ or REV ◀◀ ❷ will increase the search as follows:

- 1st press: x 2
 - 2nd press: x 4
 - 3rd press: x 8
 - 4th press: x 16
 - 5th press: x 32
 - 6th press: Resume Normal Playback
- Press the PLAY/ENTER button ❸ to resume normal playback.

PLAY A SINGLE TRACK/REPEAT PLAY

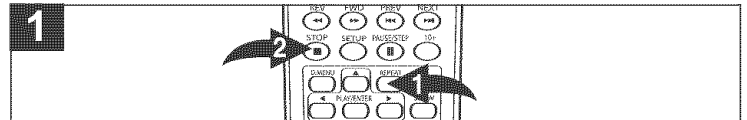

For CD: To play a song and then stop, select the track as described on the previous page, then press the REPEAT button ❶ once; "Single" will appear on the TV screen and the unit will repeat the selected track once.

To Repeat play a track, simply select the track as described on the previous page, then press the REPEAT button ❶ twice; "Repeat One" will appear on the TV screen and the unit will repeat the selected track continuously until the STOP (■) button ❷ is pressed.

Press the REPEAT button ❶ a third time; "Repeat Folder" will appear on the TV screen and the unit will repeat the tracks inside the folder (i.e. on the disc) until the STOP (■) button ❷ is pressed.

Press the REPEAT button ❶ a fourth time; "Folder" will appear on the TV screen and the unit will repeat the tracks inside the folder (i.e. on the disc) once.

For VCD: To Repeat play a track, simply select the track as described on the previous page, then press the REPEAT button ❶ once; "TRACK" will appear on the TV screen and the unit will repeat the selected track continuously until the STOP (■) button ❷ is pressed.

To Repeat all tracks on a CD, press the REPEAT button ❶ a second time; "ALL" will appear on the TV screen and the unit will repeat the CD continuously until the STOP (■) button ❷ is pressed.

To cancel Repeat play, press the REPEAT button until the Repeat indicator disappears from the screen.

REPEAT A-B PLAY

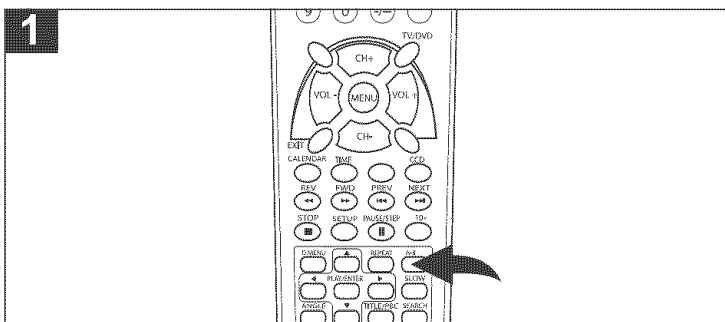

While playing back a CD, this unit can repeatedly play back a specific section.

While in the Playback mode, press the Repeat A-B button to define where you want the section to start. Press the Repeat A-B button again to define where you would like the section to end, the unit will then play the selected area continuously.

Press the Repeat A-B button again to cancel Repeat A-B mode.

PBC (VCD ONLY)

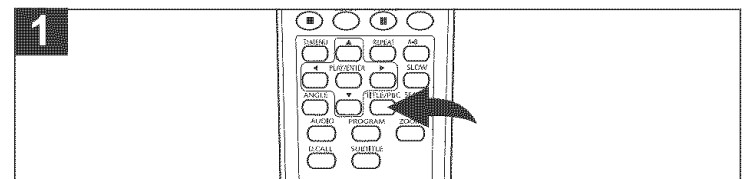

The PBC Function will activate automatically if the VCD has this function. To turn off the PBC, press the TITLE/PBC button once.

NOTE: Some disc may not have the PBC function.

AUDIO

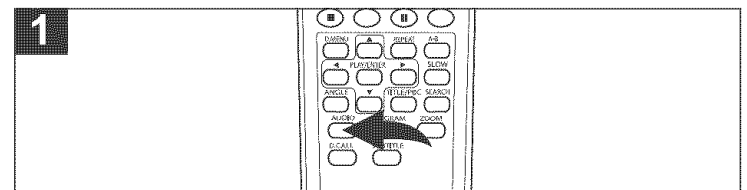

Press the AUDIO button to cycle through the audio modes. The audio modes vary depending on the disc inserted, but include MONO LEFT, MONO RIGHT, MIX-MONO and STEREO.

CD/VCD BASIC OPERATION (CONTINUED)

PROGRAMMED PLAYBACK (VCD ONLY)

The DVD player in this unit has a 20 chapter programmable memory that allows you to program up to 20 chapters on any disc for playback in any desired order. You may program 20 different chapters or you may also program certain chapters to play more than once. To perform programmed playback, proceed as follows:

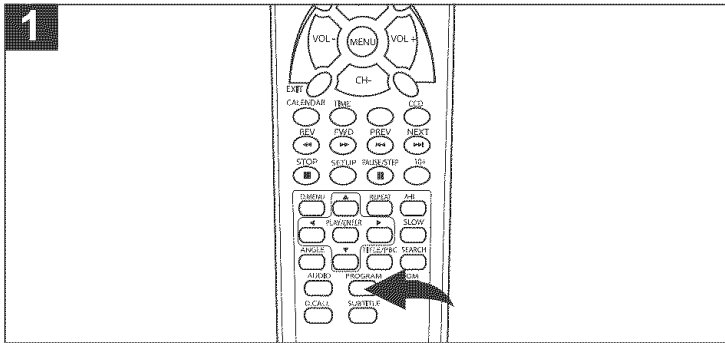

Press the PROGRAM button, the Program menu will appear on the TV screen.

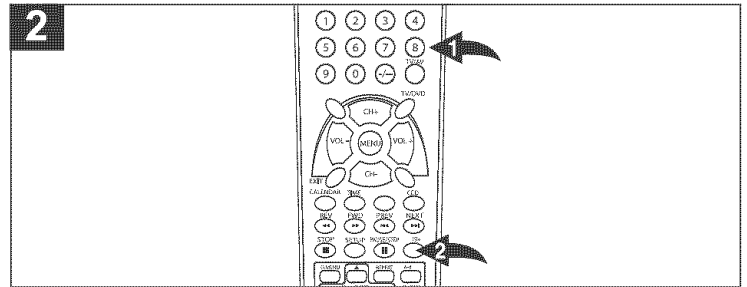

Select the first title and tracks to be played back using the Direct Channel Selection/Number buttons (0-9) ❶; the next program will automatically be highlighted.

To enter a title or track number larger than 9, press the 10+ button to enter the first digit (i.e. for Title/Track 15, press the 10+ button once "1-" will appear, then press the Number 5 button; for Title/Track 22, press the 10+ button twice follow by press the Number 2 button, etc.).

NOTE: If an incorrect title or track has been entered, it will remain highlighted and you need to enter the available track again.

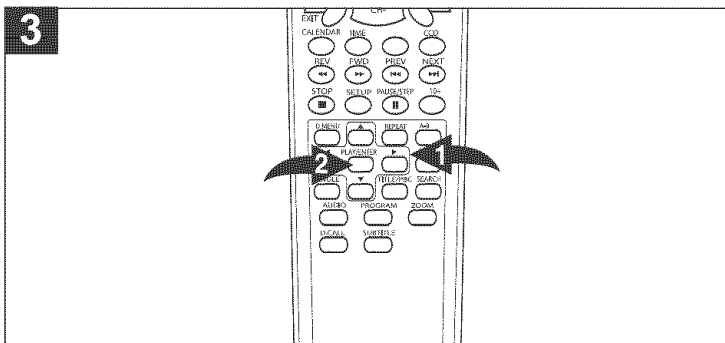

Repeat step 2 until all desired tracks have been programmed. You can repeat a track more than once if desired.

To program more than 10 programs, scroll to the ►► symbol at the bottom right of the screen using the Navigation (◀, ▶, ▲, ▼) buttons ❶ and press the PLAY/ENTER button ❷.

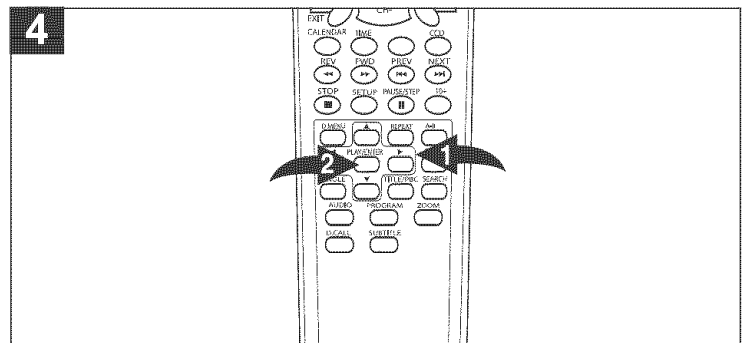

To play, scroll to START using the Navigation (◀, ▶, ▲, ▼) buttons ❶, then press the PLAY/ENTER button ❷. Playback will begin on the first track that you programmed and the player will continue to play all of the tracks that you programmed in the order in which you programmed them.

TO CANCEL THE PROGRAM FUNCTION:

During Program playback, press the PROGRAM button to enter the program menu, then select STOP using the Navigation (◀, ▶, ▲, ▼) buttons, then press the PLAY/ENTER button. To exit the program menu, select EXIT using the Navigation (◀, ▶, ▲, ▼) buttons, then press the PLAY/ENTER button to exit the menu.

PICTURE CD BASIC OPERATION

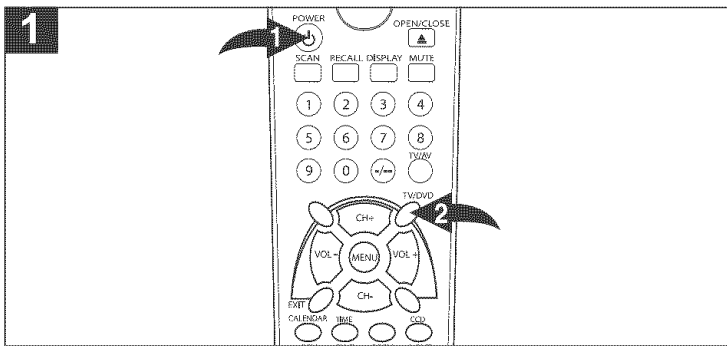

Press the POWER button ❶ to turn on the unit; the POWER indicator will light yellow. Press the TV/DVD button ❷ repeatedly to select the DVD mode.

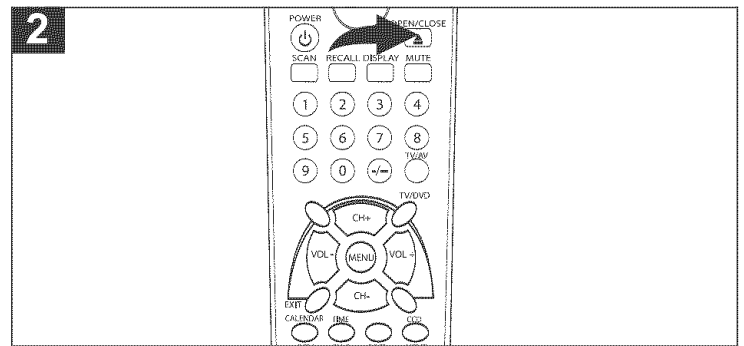

Press the OPEN/CLOSE button to open the disc tray, "OPEN" will appear on the screen. Insert a disc with the label side facing up on the disc tray.

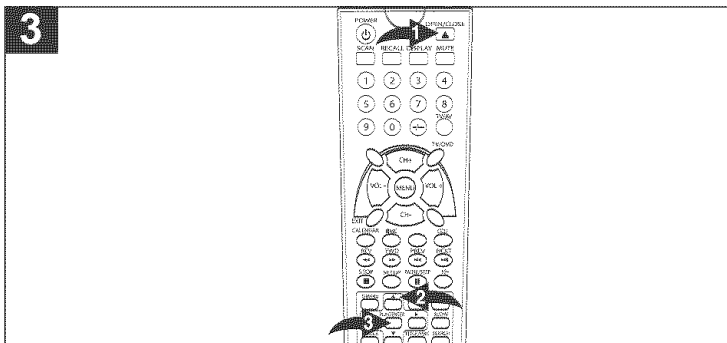

Press the OPEN/CLOSE button ❶ to close the disc tray. "CLOSE" will appear on the screen. After loading, the folder/picture menu will appear on the TV screen. Press the Navigation (▲, ▼) button ❷ to select the desired folder/photo. Press the PLAY/ENTER button ❸ to confirm.

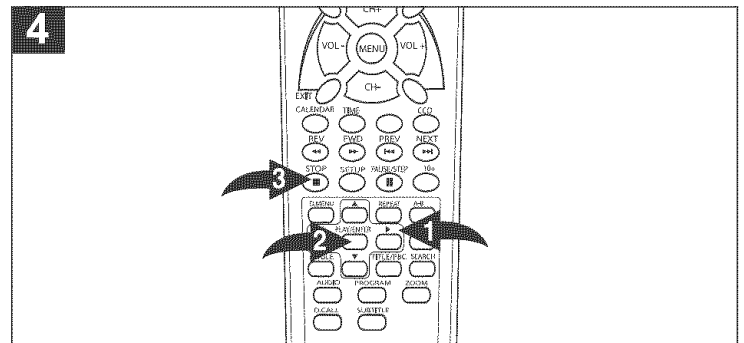

If a folder is selected, press the Navigation (▲, ▼) button ❶ to select the desired picture. Then press the PLAY/ENTER button ❷ to play the picture. Press the STOP button ❸ to stop playback. To select other folders, press the Navigation (◀) button ❶ while in the stop mode to go back to select the folders. Use the Navigation (▲, ▼) button ❶ to select the desired folder again.

TROUBLESHOOTING GUIDE

Check the following before requesting service:

SYMPTOM	POSSIBLE CAUSE	POSSIBLE SOLUTION
GENERAL		
No power.	AC cord unplugged.	Plug in the AC cord to an AC outlet.
Power on, but unit not functioning properly.	Condensation has formed.	Unplug the unit and wait about one to two hours to allow the player to dry.
	Wrong type of disc inserted.	This unit cannot play discs, other than DVD, VCD or standard CDs.
	Unit needs to be reset.	Press the POWER button, then unplug the AC cord. Wait one minute and then plug the unit back in.
	The disc is dirty or inserted incorrectly.	Clean disc and insert label side-up.
	Some features and functions are not available on all discs.	This is normal; try another function.
No picture.	The equipment is not connected properly.	Connect the equipment according to the instructions in this manual.
	The INPUT of the TV is not set to receive the DVD signal output.	Press the TV/DVD button to select TV, then press the TV/AV button to select DVD.
	The video cables (if using an external unit) are not securely connected.	Connect the video cables securely.
	The connected external TV power is off.	Turn the TV on.
No sound.	The equipment is not connected properly.	Connect the equipment according to the instructions in this manual.
	The external equipment connected with the audio cable is not set to receive the DVD signal input.	Select the appropriate audio input mode.
	The audio cables (if using an external unit) are not securely connected.	Connect the audio cables securely.
	The connected receiver's power is off.	Turn the audio receiver on.
Playback picture rolls.	Unit needs to be reset to NTSC.	Set menu option to NTSC.
The playback picture is poor.	The disc is dirty.	Clean the disc.
The Search feature is not working.	Some discs have sections that do not allow searching.	This is normal on some discs.
The picture is not fitting properly.	Wrong menu option is selected in the General Setup Menu.	Select the TV type (4:3PS, 4:3LB, 16:9) which matches the external TV used.
The remote control is not working.	The batteries are weak or dead.	Install fresh batteries.
	The batteries are not installed properly.	Install batteries according to the diagram.
	The remote is not aimed at the sensor.	Aim the remote at the sensor.
	Distance is too far or there is too much light in the room.	Operate within 20ft, or reduce the light in the room.
	There is an obstacle in the path of the beam.	Move obstacle.

TROUBLESHOOTING GUIDE (CONTINUED)

SYMPTOM	POSSIBLE CAUSE	POSSIBLE SOLUTION
DVD		
The unit does not start playback.	Rating level set to block the DVD.	Enter your password, and/or change the rating level.
	DVD not inserted, or inserted upside-down.	Insert DVD correctly.
	DVD is not selected.	Press the TV/DVD button to select the DVD mode.
	The disc is not placed in the guide.	Place the disc on the disc tray correctly inside the guide.
	The disc is dirty.	Clean the disc.
Some functions do not operate as stated.	Some features and functions are not available on all discs.	This is normal; try another function.
Selected language is not being shown in the subtitles, or spoken.	If the audio or subtitle language does not appear on the disc, then the initial setting will not be seen/heard.	This is normal; try another disc.
Subtitles are not working properly.	Subtitles appear only when the discs contain them.	This is normal; try another disc.
	Subtitles not turned on.	Turn the subtitles on.
Angle cannot be changed.	Angles may not be recorded on the disc (see disc jacket/case), or they may only be recorded on certain scenes.	Try another disc, or wait for a scene which allows a different camera angle.
The Rating Level password has been forgotten.	Call the number listed on the warranty to get the information to reset the password.	After receiving the information, reset the password and write it down.
VCD (VIDEO CD)		
No menu playback.	The VCD inserted does not have the playback control.	Press the TITLE/PBC button to turn off the PBC function.

**FOR ADDITIONAL SET-UP OR OPERATING ASSISTANCE, PLEASE VISIT OUR WEBSITE AT
WWW.MEMOREXELECTRONICS.COM OR CONTACT CUSTOMER SERVICE AT
(954) 660-7100**

**PLEASE KEEP ALL PACKAGING MATERIAL FOR AT LEAST 90 DAYS IN CASE YOU NEED TO RETURN
THIS PRODUCT TO YOUR PLACE OF PURCHASE OR MEMOREX.**

FOR PARTS AND ACCESSORIES, CONTACT FOX INTERNATIONAL AT 1-800-321-6993.

CARE AND MAINTENANCE

Caring for Discs

- Treat the disc carefully. Handle the disc only by its edges. Never allow your fingers to come in contact with the shiny, unprinted side of the disc.

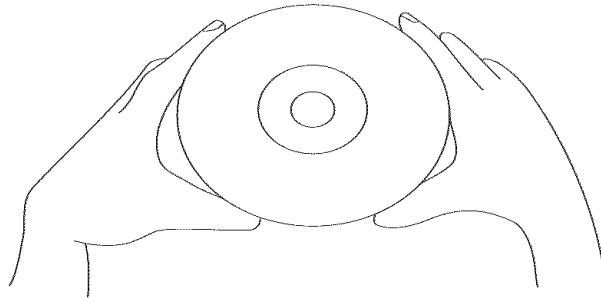

- Do not attach adhesive tape, stickers, etc. to the disc label.
- Clean the disc periodically with a soft, lint-free, dry cloth. Never use detergents or abrasive cleaners to clean the disc. If necessary, use a CD cleaning kit.
- If a disc skips or gets stuck on a section of the disc, it is probably dirty or damaged (scratched).
- When cleaning the disc, wipe in straight lines from the center of the disc to the outer edge of the disc. Never wipe in circular motions.

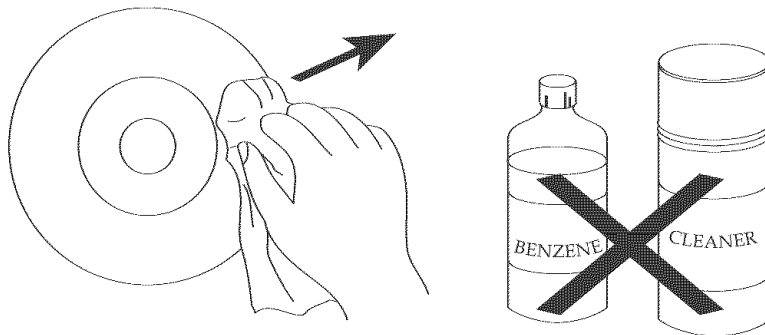

- Discs should be stored in their cases after each use to avoid damage.
- Do not expose discs to direct sunlight, high humidity, high temperatures or dust, etc. Prolonged exposure or extreme temperatures can warp the disc.
- Do not stick or write anything on either side of the disc. Sharp writing instruments, or the ink, may damage the surface.

Cleaning the Unit

- To prevent fire or shock hazard, disconnect your unit from the AC power source when cleaning.
- The finish on your unit may be cleaned with a dust cloth and cared for as other furniture. Use caution when cleaning and wiping the plastic parts.
- Mild soap and a damp cloth may be used on the front panel.

SPECIFICATIONS

Power Requirements.....	AC120V, 60Hz
Power Consumption.....	70W
Weight.....	28.5 Lbs
Dimensions	16.4 (W) x 14.8 (H) x 15.5 (D) inches
Picture Tube	14" Color Picture Tube
Speaker Output Power.....	2 x 2W
Signal System.....	NTSC
TV Tuner	Support Mode: NTSC. Supports both TV (Air) and CATV (Cable TV)
Operating Temperature.....	+5° to +35°C
Operating Humidity Range.....	5% to 90% (no condensation)

Discs Played:

DVD-VIDEO Disc

- 12cm single-sided, single layer
- 12cm single-sided, dual layer
- 12cm double-sided, single layer
- 8cm single-sided, single layer
- 8cm single-sided, dual layer
- 8cm double-sided, single layer

COMPACT DISC (VIDEO CD)

- 12cm disc
- 8cm disc

Video Output Level	1Vp-p
Audio Output Level.....	2Vrms (1KHz, 0dB)

Audio Signal Output Characteristics:

Frequency Responses:

DVD (Linear Audio).....	20Hz-20KHz (48KHz/96KHz sampling)
CD Audio	20Hz-20KHz
S/N Ratio.....	70dB
Wow and Flutter	Below Measurable Level

Pickup:

Wavelength.....	655nm
Laser Power	Class 1

Specifications are subject to change without notice.

Memcorp, Inc.
Weston, FL
Printed in Hong Kong

Visit our website at www.memorexelectronics.com