

**HITACHI**  
Inspire the Next

**PLASMA MONITOR**  
**Operating Guide for 42HDM12**

IMPORTANT SAFETY INSTRUCTIONS .....	1-6
IMAGE RETENTION.....	7
ACCESSORIES.....	8
HOW TO SETUP YOUR NEW HITACHI PLASMA MONITOR .....	9-21
HOW TO USE REMOTE CONTROL TO CONTROL YOUR PLASMA MONITOR .....	22-24
OSD (ON-SCREEN DISPLAY).....	25-29
USEFUL INFORMATION .....	30-37

# IMPORTANT SAFETY INSTRUCTIONS







## SAFETY POINTS YOU SHOULD KNOW ABOUT

### YOUR HITACHI PLASMA MONITOR

Our reputation has been built on the quality, performance, and ease of service of HITACHI Plasma Monitor. Safety is also foremost in our minds in the design of these units. To help you operate these products properly, this section illustrates safety tips which will be of benefit to you. Please read it carefully and apply the knowledge you obtain from it to the proper operation of your HITACHI Plasma Monitor. Please fill out your warranty card and mail it to HITACHI. This will enable HITACHI to notify you promptly in the improbable event that a safety problem should be discovered in your product model.

Follow all warnings and instructions marked on this plasma monitor.

  	 <p>The lightning flash with arrowhead symbol, within an equilateral triangle, is intended to alert the user to the presence of uninsulated "dangerous voltage" within the product's enclosure that may be of a sufficient magnitude to constitute a risk of electric shock to persons.</p>
<p>WARNING: TO REDUCE THE RISK OF FIRE OR ELECTRIC SHOCK, DO NOT EXPOSE THIS APPARATUS TO RAIN OR MOISTURE. CAUTION: NO USER SERVICEABLE PARTS INSIDE. REFER SERVICING TO QUALIFIED SERVICE PERSONNEL.</p>	 <p>The exclamation point within an equilateral triangle, is intended to alert the user to the presence of important operating and maintenance (servicing) instructions in the literature accompanying the appliance.</p>

**WARNING:** • TO PREVENT FIRE OR SHOCK HAZARD, DO NOT EXPOSE THIS PLASMA MONITOR TO RAIN OR MOISTURE.  
• THE PLASMA MONITOR SHOULD NOT BE EXPOSED TO DRIPPING OR SPLASHING AND OBJECTS FILLED WITH LIQUIDS, SUCH AS VASES, SHOULD NOT BE PLACED ON THE MONITOR.

**NOTE:** • Model and serial numbers are indicated on back side of the Plasma Monitor.

**CAUTION:** Adjust only those controls that are covered in the instructions, as improper changes or modifications not expressly approved by HITACHI could void the user's authority to operate the Plasma Monitor.

**MODIFICATIONS:** The FCC requires the user to be notified that any changes or modifications made to this device that are not expressly approved by Hitachi America, Ltd. Home Electronics Division may void the user's authority to operate the equipment.

**POWER SOURCE**  
THIS PLASMA MONITOR IS DESIGNED TO OPERATE ON 120 VOLTS 60Hz, AC CURRENT. INSERT THE PLASMA MONITOR POWER CORD INTO A 120 VOLT 60Hz OUTLET.

TO PREVENT ELECTRIC SHOCK, DO NOT USE THE PLASMA MONITOR'S (POLARIZED) PLUG WITH AN EXTENSION CORD, RECEPTACLE, OR OTHER OUTLET UNLESS THE BLADES AND GROUND TERMINAL CAN BE FULLY INSERTED TO PREVENT BLADE EXPOSURE.

NEVER CONNECT THE PLASMA MONITOR TO 50Hz, DIRECT CURRENT, OR ANYTHING OTHER THAN THE SPECIFIED VOLTAGE.

Apparatus shall not be exposed to dripping or splashing and no objects filled with liquids, such as vases, shall be placed on the apparatus.

 **CAUTION:** Never remove the back cover of the Plasma Monitor as this can expose you to very high voltages and other hazards. If the monitor does not operate properly, unplug the Plasma Monitor and call your authorized dealer or service center.

English



# IMPORTANT SAFETY INSTRUCTIONS



## Read before operating equipment

Follow all warnings and instructions marked on this monitor.

1. Read these instructions.
2. Keep these instructions.
3. Heed all warnings.
4. Follow all instructions.
5. Do not use this apparatus near water.
6. Clean only with a dry cloth.
7. Do not block any ventilation openings. Install in accordance with the manufacturer's instructions.
8. Do not install near any heat sources such as radiators, heat registers, stoves, or other apparatus (including amplifiers) that produce heat.
9. Do not defeat the safety purpose of the polarized or grounding-type plug. A polarized plug has two blades with one wider than the other. A grounding type plug has two blades and a third grounding prong. The wide blade or the third prong are provided for your safety. If the provided plug does not fit into your outlet, consult an electrician for replacement of the obsolete outlet.
10. Protect the power cord from being walked on or pinched particularly at plugs, convenience receptacles, and the point where they exit from the apparatus.
11. Only use the attachments/accessories specified by the manufacturer.
12.  Use only with the cart, stand, tripod, bracket, or table specified by the manufacturer, or sold with the apparatus. When a cart is used, use caution when moving the cart/apparatus combination to avoid injury from tip-over.
13. Unplug this apparatus during lightning storms or when unused for long periods of time.
14. Refer all servicing to qualified service personnel. Servicing is required when the apparatus has been damaged in any way, such as power-supply cord or plug is damaged, liquid has been spilled or objects have fallen into apparatus, the apparatus has been exposed to rain or moisture, does not operate normally, or has been dropped.

15. Monitors are designed to comply with the recommended safety standards for tilt and stability.  
Do not apply excessive pulling force to the front, or top, of the cabinet which could cause the product to overturn resulting in product damage and/or personal injury.
16. Follow instructions for wall, shelf or ceiling mounting as recommended by the manufacturer.
17. Under no circumstances remove the rear cover of your monitor.  
Never guess or take any chances with electrical equipment of any kind - it is better to be safe than sorry!
18. After the monitor has been on for any length of time, you will notice that the screen becomes warm. Please note that this is normal.  
Sometimes the screen might have some tiny bright or dark spots. Please note that this is normal.
19. To prevent scratches or damages to the Plasma screen, do not knock or rub the surface with sharp or hard objects.  
Clean the screen with a soft cloth moistened with warm water and dry with a soft cloth. A mild soap may be used if the screen is extremely dirty. Do not use harsh or abrasive cleaners!
20. Use a soft cloth to clean the cabinet and control panel of the monitor. When excessively soiled dilute a neutral detergent in water, wet and wring out the soft cloth and afterward wipe with a dry soft cloth.  
Never use acid/alkaline detergent, alcoholic detergent, abrasive cleaner, powder soap, OA cleaner, car wax, glass cleaner, etc. especially because they would cause discoloration, scratches or cracks.

This product contains lead. Dispose of this product in accordance with applicable environmental laws. For product recycling and disposal information, contact your local government agency or the Electronic Industries Alliance at [www.eiae.org](http://www.eiae.org) (in the US) or the Electronic Product Stewardship Canada at [www.epsc.ca](http://www.epsc.ca) (in Canada). For more information, call "1-800-HITACHI."

Do not place any objects on the top of the monitor which may fall or cause a child to climb to retrieve the objects.

## PREVENTION OF SCREEN BURN

Continuous on-screen displays such as video games, stock market quotations, computer generated graphics, and other fixed (nonmoving) patterns can cause permanent damage to monitor receivers. Such "SCREEN BURNS" constitute misuse and are **NOT COVERED** by your HITACHI Factory Warranty.

## PUBLIC VIEWING OF COPYRIGHTED MATERIAL

Public viewing of programs broadcast by TV stations and cable companies, as well as programs from other sources, may require prior authorization from the broadcaster or owner of the video program material.

• This product incorporates copyright protection technology that is protected by U.S. patents and other intellectual property rights. Use of this copyright protection technology must be authorized by Macrovision Corporation, and is intended for home and other limited consumer uses only unless otherwise authorized by Macrovision. Reverse engineering or disassembly is prohibited.

## SAFETY INSTRUCTIONS

This PDP (Plasma Display Panel) monitor has been designed and manufactured to meet international safety standards, but like any electrical equipment, care must be taken if you are to obtain the best results and safety is to be assured.

Before using this product, please read and understand the Safety Instructions thoroughly to ensure correct usage, and follow all the instructions.

### About the Symbols

Various symbols are used in this manual, the user's manual and on the product itself to ensure correct usage, to prevent danger to the user and others, and to prevent property damage. The meanings of these symbols are described below. It is important that you read these descriptions thoroughly and fully understand the contents.



This symbol indicates information that, if ignored, could possibly result in personal injury or even death due to incorrect handling.



This symbol indicates information that, if ignored, could result possibly in personal injury or physical damage due to incorrect handling.

#### Typical Symbols



This symbol indicates an additional warning (including cautions). An illustration is provided to clarify the contents.



This symbol indicates a prohibited action. The contents will be clearly indicated in an illustration or nearby (the symbol to the left indicates that disassembly is prohibited).



This symbol indicates a compulsory action. The contents will be clearly indicated in an illustration or nearby (the symbol to the left indicates that the power plug should be disconnected from the power outlet).



#### Never use the Plasma Monitor if a problem should occur.

Abnormal operations such as smoke, strange odor, no image, no sound, excessive sound, damaged casing, elements, cables, penetration of liquids or foreign matter, etc. can cause a fire or electrical shock.

In such case, immediately turn off the power switch and then disconnect the power plug from the power outlet. After making sure that the smoke or odor has stopped, contact your dealer. Never attempt to make repairs yourself because this could be dangerous.



Disconnect the plug from the power outlet.

#### Do not insert liquids or foreign objects.

Penetration of liquids or foreign objects could result in fire or electrical shock. Use special caution in households where children are present. If liquids or foreign objects should enter the projector, immediately turn off the power switch, disconnect the power plug from the power outlet and contact your dealer.

- Do not place the PDP monitor in a bathroom.
- Do not expose the PDP monitor to rain or moisture.
- Do not place flower vases, pots, cups, cosmetics, liquids such as water, etc on or around the PDP monitor.
- Do not place metals, combustibles, etc on or around the PDP monitor.



#### Never disassemble or modify the Plasma Monitor.

The PDP monitor contains high voltage components. Modification could result in fire or electrical shock.

- Never remove any fixed cover.



Do not disassemble.

#### Do not give the Plasma Monitor any shock or impact.

If the PDP monitor should be shocked and/or broken, it could result in an injury, and continued use could result in fire or electrical shock.

If the glass panel is broken or damaged, immediately turn off the power switch, disconnect the power plug from the power outlet and contact your dealer.



#### Do not place the Plasma Monitor on an unstable surface.

If the PDP monitor should be dropped and/or broken, it could result in an injury, and continued use could result in fire or electrical shock.

- Do not place the monitor on an unstable, slant or vibrant surface such as a wobbly or inclined stand.



#### Do not obstruct the ventilation of the Plasma Monitor.

If the ventilation is obstructed during the operation of the monitor or just after switching off the power, it could result in damage and shorten the lifespan of your PDP monitor due to overheating. Make sure there is ample ventilation.

- Keep a space of 100mm (10cm) or more between the sides, rear and top of the PDP monitor and other objects such as walls.
- Do not place anything around ventilation openings of the PDP monitor.
- Never block ventilation openings.
- Do not put the plasma screen side up.
- Do not cover the PDP monitor with a tablecloth, etc.
- Do not place the PDP monitor on a carpet or bedding, or near a curtain.



#### Use only the correct power outlet.

Incorrect power supply could result in fire or electrical shock. Use only the correct power outlet depending on the indication on the PDP monitor and the safety standard.

- The enclosed power cord must be used depending on the power outlet to be used.



## SAFETY INSTRUCTIONS (continued)

### WARNING

#### Be cautious of the power cord connection.

Incorrect connection of the power cord could result in fire or electrical shock.

- Do not touch the power cord with a wet hand.
- Check that the connecting portion of the power cord is clean (with no dust), before using. Use a soft and dry cloth to clean the power plug.
- Insert the power plug into a power outlet firmly. Avoid using a loose, unsound outlet or contact failure.
- Do not cut off the fitted power plug, the removal of which could lead to impaired performance. If you wish to extend the lead, obtain an appropriate extension lead or consult your dealer.
- Should you require replacing the fuse in the molded plug with a new fuse, then please replace with new one of the same value, type and approval as the original. Ensure the fuse cover is returned to its original position.



#### Be sure to keep safety ground connection.

Connect the ground terminal of AC inlet of this PDP monitor with the ground terminal provided at the power outlet using the enclosed power cord. If the provided plug does not fit your outlet, consult an electrician for replacement of the obsolete outlet.



Surely connect the ground wire.

#### Be careful in handling the power cord and external connection cables.

If you keep using a damaged power cord or cables, it can cause a fire or electrical shock. Do not apply too much heat, pressure or tension to the power cord and cables.

If the power cord or cables are damaged (exposed or broken core wires, etc.), contact your dealer.

- Do not place the monitor or heavy objects on the power cord and cables. Also, do not place a spread, cover, etc. over them because this could result in the inadvertent placing of heavy objects on the concealed power cord or cables.
- Do not pull the power cord and cables. When connecting and disconnecting the power cord or cables, do it with your hand holding the plug or connector.
- Do not place the cord near the heater.
- Do not touch the power plug just after disconnecting it from the power outlet to prevent electric shock.
- Do not touch the power plug when lightning is close to you.
- Avoid coiling the power cord and bending it sharply.
- Protect the power cord from being walked on, pinched particularly at plugs, convenience receptacles, and the point where they exit from the apparatus.
- Do not modify the power cord.



#### Be careful in handling the battery of the remote control.

Incorrect handling of the battery could result in fire or personal injury. The battery may explode if not handled properly.

- Keep the battery away from children and pets. If swallowed consult a physician immediately for emergency treatment.
- Do not allow the battery to be exposed to fire or water.
- Avoid fire or high-temperature environment.
- Do not hold the battery with metallic tweezers.
- Keep the battery in a dark, cool and dry place.
- Do not short circuit the battery.
- Do not recharge, disassemble or solder the battery.
- Do not physically impact the battery.
- Use only the battery specified in the manual of this monitor.
- Make sure the plus and minus terminals are correctly aligned when loading the battery.
- If you observe a leakage of the battery, wipe out the liquid and then replace the battery. If the liquid adheres your body or clothes, rinse well with water.
- Obey the local laws on disposing the battery.



## SAFETY INSTRUCTIONS (continued)

### WARNING

#### **Be careful in moving the Plasma Monitor.**

Neglect could result in an injury or damage.

- Do not move the PDP monitor during use. Before moving, disconnect the power plug and all external connections.
- You are advised to move the PDP monitor with two persons.
- Avoid any impact or shock to the PDP monitor; particularly take care of glass screen.

#### **Do not put anything on top of the Plasma Monitor.**

Placing anything on the PDP monitor could result in loss of balance or falling, and cause an injury or damage. Use special caution in households where children are present.

#### **Avoid a humid or dusty place.**

Placing the PDP monitor in a smoke, a highly humid, dusty place, oily soot or corrosive gas could result in fire or electrical shock.

- Do not place near the kitchen, a humidifier or other place where there is oil, smoke or humidity.

#### **Avoid a high temperature environment.**

The heat could have adverse influence on the PDP monitor and other parts, and could result in transformation, melting or fire.

- Do not place the PDP monitor, the remote control and other parts in direct sunlight or near a hot object such as heater, etc.
- Do not put the PDP monitor in a place where the temperature is widely changing.

#### **Remove the power cord for complete separation.**

- For safety purposes, disconnect the power cord if the PDP monitor is not to be used for prolonged periods of time.
- Before cleaning, turn off and unplug the PDP monitor. Neglect could result in fire or electrical shock.

### PRECAUTIONS

#### **• Installation environment**

Do not obstruct a ventilation hole.

Do not put the PDP monitor on carpet or blanket, or near a curtain which has a possibility of obstructing a ventilation hole of the PDP monitor.

Do not put the PDP monitor in the following places.

- Hot places such as near heater, place exposed to the direct rays of the sun.
- A place where the temperature is widely changing.
- Places with soot, dust or high humidity.
- Poor air ventilation place.
- Place near fire.
- A wet place such as bathroom, or shower room.
- Place where you can trip over it.
- Always vibrating or strongly vibrating places.
- Distorted or unstable places.

#### **• How to view the Plasma Monitor.**

If you use the monitor in too dark a room, your eyes may become tired.

Please use it in a reasonably bright room.

Avoid direct rays of the sun to the screen in order to prevent eye fatigue.

Your eyes will get fatigued after viewing the PDP monitor for long period of time.

Relax your eyes by viewing away from the PDP monitor from time to time.

Please watch the PDP monitor in downward direction.

#### **• How to clean the plasma screen panel of the Plasma Monitor.**

Before cleaning the PDP monitor, turn off the monitor and disconnect the power plug from the power outlet.

To prevent scratching or damaging the plasma screen face, do not knock or rub the surface with sharp or hard objects. Clean the screen with a soft cloth moistened with warm water and dry with a soft cloth. If it is not enough, then use a cloth with mild detergent. Do not use harsh or abrasive cleaners.

#### **• How to clean the cabinet of the Plasma Monitor.**

Use a soft cloth to clean the cabinet and control panel of the PDP monitor. When excessively soiled dilute a neutral detergent in water, wet and wring out the soft cloth and afterward wipe with a dry soft cloth.

Never use acid/alkaline detergent, alcoholic detergent, abrasive cleaner, powder soap, OA cleaner, car wax, glass cleaner, etc. especially because they would cause discoloration, scratches or cracks.



English



Disconnect the plug from the power outlet.

## SAFETY INSTRUCTIONS (continued)

### • Prevention of an obstacle to Radio receivers

This PDP monitor has been designed pursuant to the international EMI standards. This is to prevent a problem to Radio receivers.

- Keep the PDP monitor away from Radio.
- Adjust Radio antennas in order for the monitor not to receive interference.
- The antenna cable of Radio should be kept away from the PDP monitor.
- Use a coaxial cable for antenna.

You can check if this PDP monitor influences Radio receivers by turning off all other equipment other than the monitor.

If you find a problem receiving Radio when using the PDP monitor, check the instructions mentioned above.

### • Precautions for the cable connection

- Do ensure that all connections, (including the power plug, extension leads and interconnections between the pieces of equipment), are properly made and in accordance with the manufacturers instructions. Switch off and withdraw the power plug before making or changing connections.
- Confirm the connector is fixed tightly when the signal cable is connected.  
Also confirm the screws on the connector are tightened.
- Plug the power cord of the PDP monitor into a different socket from that for other equipment, such as Radio etc..
- Use a plug with ground terminal and make sure that it connects to the ground.

### • Precaution during transportation

Please pay attention when you transport this PDP monitor because it is heavy.

Furthermore, use the original carton box and its packaging materials when the PDP monitor is transported.

Failure to transport the monitor in any carton except the original carton may result in damage to the PDP monitor.

Save the original carton box and all packing material.

### Do not physically impact the remote control.

A physical impact could cause damage or malfunction of the remote control.

- Take care not to drop the remote control.
- Do not place heavy objects on the remote control.

### Avoid strong rays.

Any strong rays (such as direct sun rays or room lighting) onto the remote control sensors could invalidate the remote control.

### Avoid radio interference.

Any interfering radiation could cause distorted images or noises.

- Avoid radio generator such as a mobile telephone, transceiver, etc. around the PDP monitor.

### Set the sound volume at a suitable level.

It is better to keep the volume level low and close the windows at night to protect the neighborhood environment.

### • Precautions for the installation

- Do not use makeshift stands and NEVER fix legs with wood screws - to ensure complete safety, always fit the manufacturers approved stand or legs with the fixings provided according to the instructions.
- Use only with the cart, stand, tripod, bracket, or table specified by the manufacturer, or sold with the apparatus. When a cart is used, use caution when moving the cart/apparatus combination to avoid injury from tip-over.
- This product is designed to comply with the recommended safety standards for tilt and stability. Do not apply excessive pulling force to the front, or top, of the cabinet that could cause the product to overturn resulting in product damage and/or personal injury.
- Follow instructions for wall, shelf or ceiling mounting as recommended by the manufacturer.
- Only use the attachments/accessories specified by the manufacturer.
- Consult your dealer if you are in any doubt about installation, operation or safety of your equipment.

### • Other precautions

- Do not leave equipment switched on when it is unattended unless it is specifically stated that it is designed for unattended operation or has a stand-by mode. Switch off using the switch on the equipment and show your family how to do this. Make special arrangements for infirm or handicapped people.
- Disposal of this product may require specific instructions pertaining to your resident region.
- Never guess or take any chances with electrical equipment of any kind - it is better to be safe than sorry!



## IMAGE RETENTION

Image Retention can be an issue for any plasma display, and is caused by displaying fixed (non-moving) images for extended periods of time. If you follow the simple guidelines below you will enjoy a high quality picture for many years to come.

### Examples of Image Retention

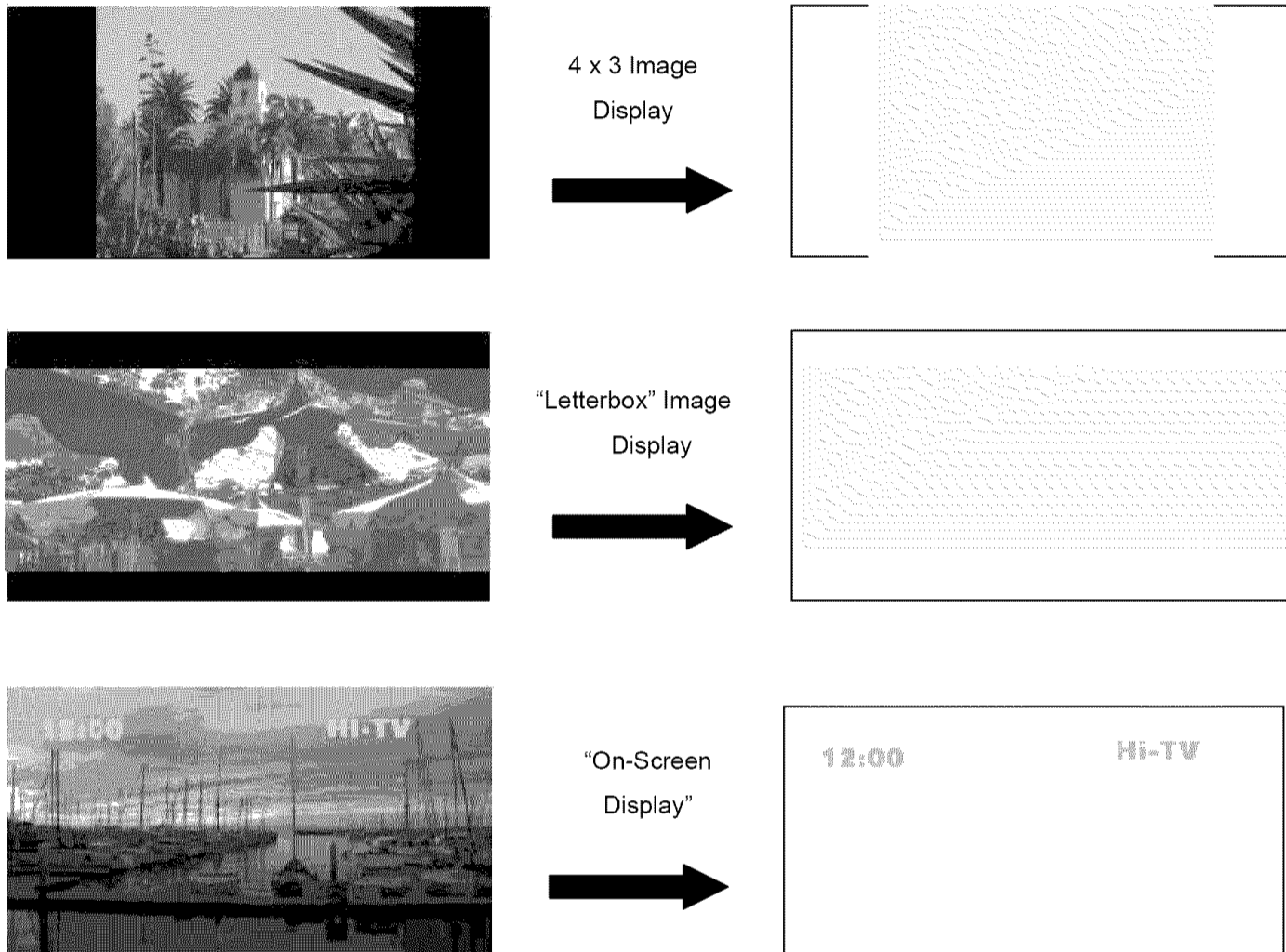

English

Français





Hitachi has included a number of features, which help to reduce image retention. Please refer to the user manual for this model for additional instructions on how to use these features. To avoid image retention, please follow these simple guidelines.

- ∞ Activate the Screen Saver Mode.
- ∞ Use Aspect Ratio modes that completely fill the screen with picture.
  - Make sure 4 x 3 aspect ratio and letterbox images are not displayed more than 15% of total viewing time.
- ∞ Avoid using split screen (PIP) modes for long periods of time.
- ∞ Do not display still images, such as menus from game consoles, PCs or logos, on the monitor Screen for long periods of time.
- ∞ Reduce the "Contrast" level setting to the lowest acceptable setting.

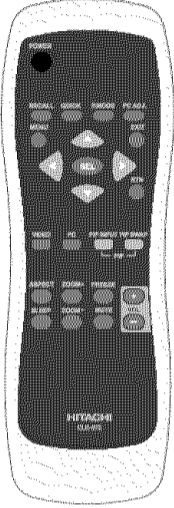
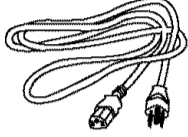

# ACCESSORIES

Check to make sure you have the following accessories before disposing of the packing material.

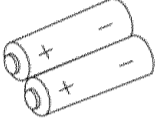
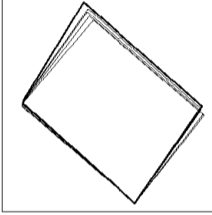
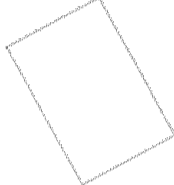
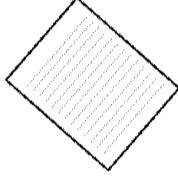
<p><b>REMOTE CONTROL</b></p>  <p>1.</p>	<p><b>POWER CORD</b></p>  <p>2.</p>	<p><b>D-SUB MINI 15-PIN CABLE</b></p>  <p>3.</p>	<p><b>AUDIO/VIDEO CABLE</b></p>  <p>4.</p>	<p><b>S-VIDEO CABLE</b></p>  <p>5.</p>
<p><b>BATTERIES</b></p>  <p>6.</p>	<p><b>USER'S GUIDE</b></p>  <p>7.</p>	<p><b>EASY GRAPHIC GUIDE</b></p>  <p>8.</p>	<p><b>WARRANTY CARD</b></p>  <p>9.</p>	

**CAUTION:** Ceiling mounting is not recommended. Mounting the panel on the ceiling does not provide adequate ventilation for the electronics or proper support for the front glass panel. This plasma monitor product is designed for a maximum tilting angle of 45 degrees from vertical.

- 1. Remote Control Unit
- 2. Power Cord
- 3. D-SUB Mini 15-Pin Cable
- 4. Audio/Video Cable
- 5. S-Video Cables
- 6. Two "AAA" size, 1.5V batteries
- 7. User's Guide
- 8. Easy Graphic Guide
- 9. Warranty Card

## REMOTE CONTROL BATTERY INSTALLATION AND REPLACEMENT

1. Open the battery cover of the remote control by pressing the notched part of the cover with your fingers and pulling the cover off.
2. Insert two new "AAA" size batteries for the remote control. When replacing old batteries, push them towards the springs and lift them out.
3. Match the batteries to the (+) and (-) marks in the battery compartment.
4. Replace the cover.

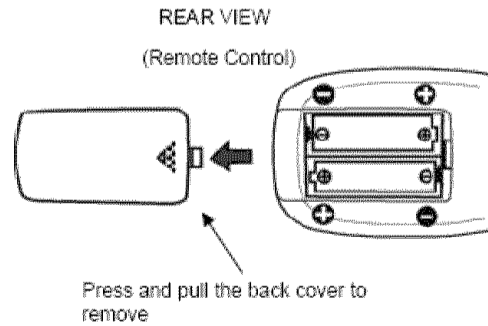

**CAUTION:** Danger of explosion if battery is incorrectly replaced. Replace with the same or equivalent type.

## HOW TO SETUP YOUR NEW HITACHI PLASMA MONITOR

To take measures to prevent the Plasma Monitor from tipping over and prevent possible injury it is important to mount the unit in a stable place.

### Securing to a wall

\*Keep the Plasma Monitor four inches away from the wall except those hung to the wall mount bracket.

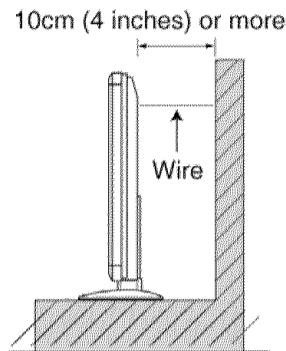

**NOTES:** 1. Do not block the ventilation holes of the Plasma Monitor. Blocking the ventilation holes might cause fire or defect.  
2. If you purchased the wall mount bracket option, please ask for professional installer. Do not install by yourself.

### PRECAUTIONS

Please avoid installing the monitor directly on the wooden floor. Depending on the quality and condition of the floor, the desktop stand may stick to the floor face, and the surface could come off when the monitor is lifted up.

### Caution when moving the main unit

As this product is heavy, whenever it is moved, two people are required to transport it safely. Whenever the unit is moved it should be lifted forward using the top and base on both sides for stability. When moving the Plasma Monitor, lift the top and the bottom frame as shown below.

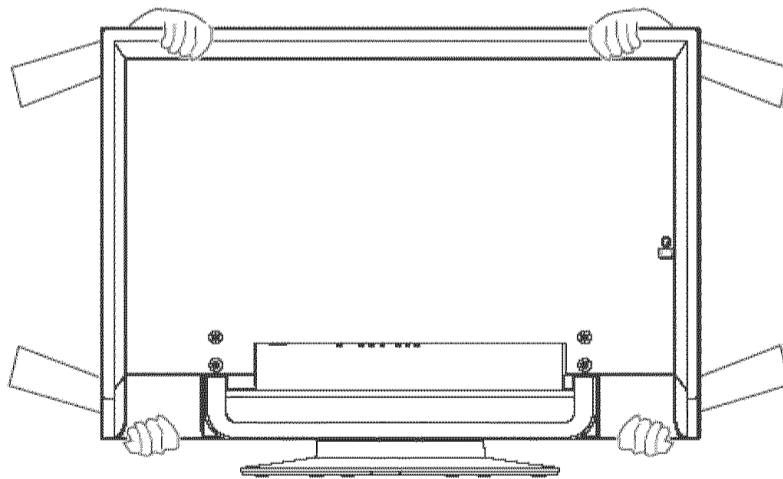

### LOCATION

Select an area where sunlight or bright indoor illumination will not fall directly on the picture screen. Also, be sure that the location selected allows a free flow of air to and from the perforated back cover of the set.

To avoid cabinet warping, cabinet color changes, and increased chance of set failure, do not place the monitor where temperatures can become excessively hot, for example, in direct sunlight or near a heating appliance, etc.

# HOW TO SETUP YOUR NEW HITACHI PLASMA MONITOR

## VIEWING

The major benefit of the HITACHI Plasma Monitor is its large viewing screen. To see this large screen at its best, test various locations in the room to find the optimum spot for viewing. The best picture is seen by sitting directly in front of the monitor and about 8 to 18 feet from the screen.

During daylight hours, reflections from outside light may appear on the screen. If so, drapes or screens can be used to reduce the reflection or the monitor can be located in a different section of the room.

If the monitor's audio output will be connected to a Hi-Fi system's external speakers, the best audio performance will be obtained by placing the speakers equidistant from each side of the receiver cabinet and as close as possible to the height of the picture screen center. For best stereo separation, place the external speakers at least four feet from the side of the monitor, place the surround speakers to the side or behind the viewing area. Differences in room sizes and acoustical environments will require some experimentation with speaker placement for best performance.

## IMPORTANT NOTES

No.	Items	Notes
1	Arching sound from plasma monitor panel.	A buzzing sound might be heard when the plasma monitor is turned on in a very quiet room. This is due to the plasma display panel drive circuit when it is functioning. This arching sound is normal and it is not a malfunction.
2	Interference for infrared equipment.	Some infrared rays are emitted from the plasma monitor's panel that might affect other infrared controlling equipment.
3	Bright and dark spots	High-precision technology is used to manufacture the plasma display panel; But in some cases, there are minor defects in some parts of the screen. Points that do not light, points with brightness different from that of the periphery, points with color different from that of the periphery, etc. Some pixels will always be on or always off. Please note that this is not a malfunction.
4	Picture Image (Spectrum)	When receiving still picture signals, (e.g. channel number indication or clock indication) for a while, you can see image-like when the picture varied. This is not a defect.
5	Plasma display panel surface temperature is too high	The plasma display panel is lighting the phosphors by the discharge of internal radiation. In some cases, this may cause the temperature of the panel surface to increase. Please note that this is not a malfunction. The Plasma monitor surface temperature is higher than a Cathode-ray-tube.
6	Plasma Surface	The plasma display panel is made from glass. Heavy shock on the front panel might damage it.
7	Transportation	When the plasma monitor is transported horizontally, the glass panel has the possibility of being broken or increasing the picture defects. At the time of transportation, horizontal style is prohibited. More-over, please treat the plasma panel with great care because of a precision apparatus. Please instruct transporters so that it should be put into the packing box at the time of shipment. (There is a possibility that breakage of the panel or defects will increase.) Rough transportation might cause damage to the panel and pixel failure.
8	Image retention	The plasma monitor illuminates phosphor to display images. The phosphor has a finite illumination life. After extended periods of illumination, the brightness of the phosphor will be degraded to such extent that stationary images would burn-in that part of the screen as grayed-out images. Tips to prevent such image retention are: - Do not display images having sharp brightness differences or hi-contrast images, such as monochrome characters and graphic patterns, for long. - Do not leave stationary images appearing for long, but try to refresh them at appropriate intervals of time, or try to move them using screen saver function. - Turn down the contrast and brightness controls.
9	Luminosity and contrast	Plasma monitor has luminosity and low contrast compared with CRT monitor.
10	Granular spots	When a screen is seen at point-blank range, a random fine grain may be visible to a dark part.
11	Disturbance to video apparatus	If an apparatus (VCR, etc.) antenna line is arranged near the monitor, the image may shake, or disturbance may be received.
12	Lip Sync	There is some time lag between the picture and the sound. You can see lip motion that is delayed compared to the sound.
13	About the use environment of plasma monitor (temperature)	Electric discharge/luminescence characteristic of the plasma display panel also changes with peripheral temperature. Moreover, since there is also high power consumption value, a specified temperature environment is required.
14	Caution on prolonged storage	Storing the plasma monitor for a period of more than 2 to 3 months without use might cause an unstable picture when the set is turned on.
15	Operating	Operating altitude: 800 to 1,114hPa (6,194ft to -2,484ft). Operating temperature: 41°F to 95°F.
16	Storage	Storage Altitude: 300 to 1,114hPa (31,912ft to -2,484ft). Storage temperature: 5°F to 140°F.
17	Power ON or OFF	Frequent use of the Power ON or OFF might trigger the power protection circuit. If the monitor does not turn ON, please wait a little before turning ON again.

# HOOKUP CABLES

Most video/audio connections between components can be made with shielded video and audio cables that have phono connectors. For best performance, video cables should use 75-Ohm coaxial shielded wire. Cables can be purchased from most stores that sell audio/video products. Below are illustrations and names of common connectors. Before purchasing any cables, be sure of the output and input connector types required by the various components and the length of each cable.



**Phono Connector (Provided)**  
Used on all standard video and audio cables which connect to inputs and outputs located on the rear jack panel.



**S-Video (Super Video) Connector (Provided)**  
This connector is used on camcorders, VCRs and laserdisc players with an S-Video feature in place of the standard video cable to produce a high quality picture.

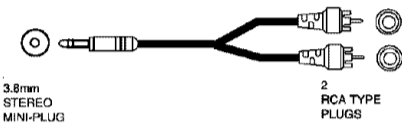

**Stereo Cable**  
This cable is used to connect from external audio out to the audio input of the Plasma monitor (ex. ANALOG RGB/HDMI Audio Input).

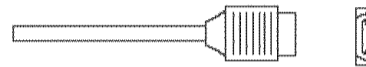

**HDMI Cable**  
This cable is used to connect your external devices such as Set-Top-Boxes or DVD players equipped with an HDMI output connection to the monitor's HDMI input.

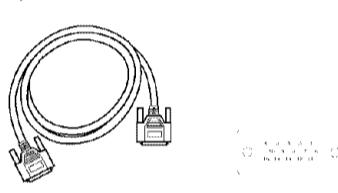

**D-SUB MINI 15-Pin Cable (Provided)**  
This cable is used to connect a computer output to the D-SUB input located on the rear panel of the Plasma monitor. The resolution should be set correctly to display the signal on the Plasma monitor.

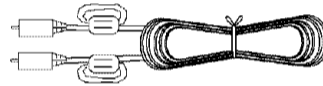

**Subwoofer Cable**  
This cable is used to connect an external audio component input to the subwoofer output of the Plasma monitor.

English

Francia

# FRONT PANEL CONTROLS

FRONT VIEW  
42" PLASMA MONITOR

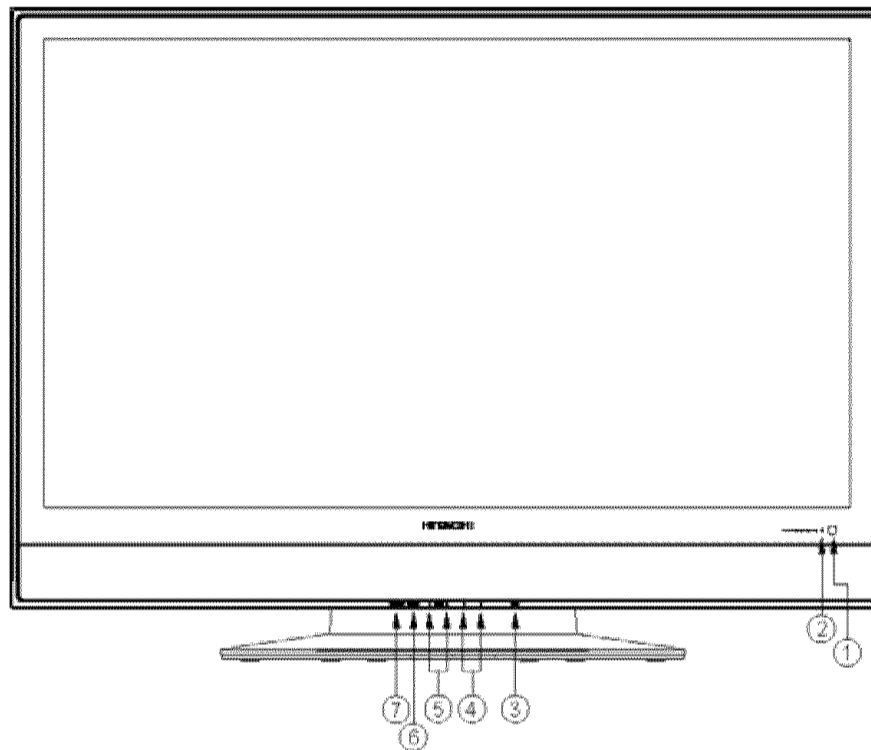

① **REMOTE CONTROL sensor**

Point your remote control at this area when selecting signal, adjusting volume, etc.

② **POWER light indicator**

To turn the PDP MONITOR ON, press the main power button located on the BACK left side of the monitor. A red stand-by indicator lamp located on the lower right corner of the front bezel will illuminate. The PDP monitor is now ready for remote on/off operation.

Indicating Lamp	Power Status	Operating
Off	Off	When the MAIN POWER is set OFF.
Lights Red	Off (Stand-by)	When the MAIN POWER is set ON and the Front Key or Remote Control POWER is OFF.
Lights Orange	Off (Power Saving)	1. When the MAIN POWER is set ON. 2. No signal input (no sync. signal).
Lights Green	On	When the POWER is ON.

③ **POWER button**

This power button is for power on the plasma monitor or change to standby mode.

④ **▼ and ▲ selector**

These buttons serve as the cursor down (▼) and up (▲) buttons when in MENU mode.

⑤ **VOLUME level**

Press these buttons to adjust the sound level. The volume level will be displayed on the monitor screen. These buttons also serve as the cursor left (◀) and right (▶) buttons when in MENU mode.

⑥ **INPUT/EXIT button**

Press this button to select the desired input: Composite-VIDEO, S-VIDEO, YC<sub>B</sub>C<sub>R</sub>, YP<sub>B</sub>P<sub>R</sub>, Analog RGB or HDMI source. This button also serves as the EXIT button when in MENU mode.

⑦ **MENU/SELECT button**

This button allows you to enter the MENU, making it possible to set monitor features to your preference without using the remote. This button also serves as the SELECT button when in MENU mode.

## REAR PANEL MAIN POWER SWITCH & JACKS

**IMPORTANT:** This is a monitor only product. No TV or Cable tuner is included.

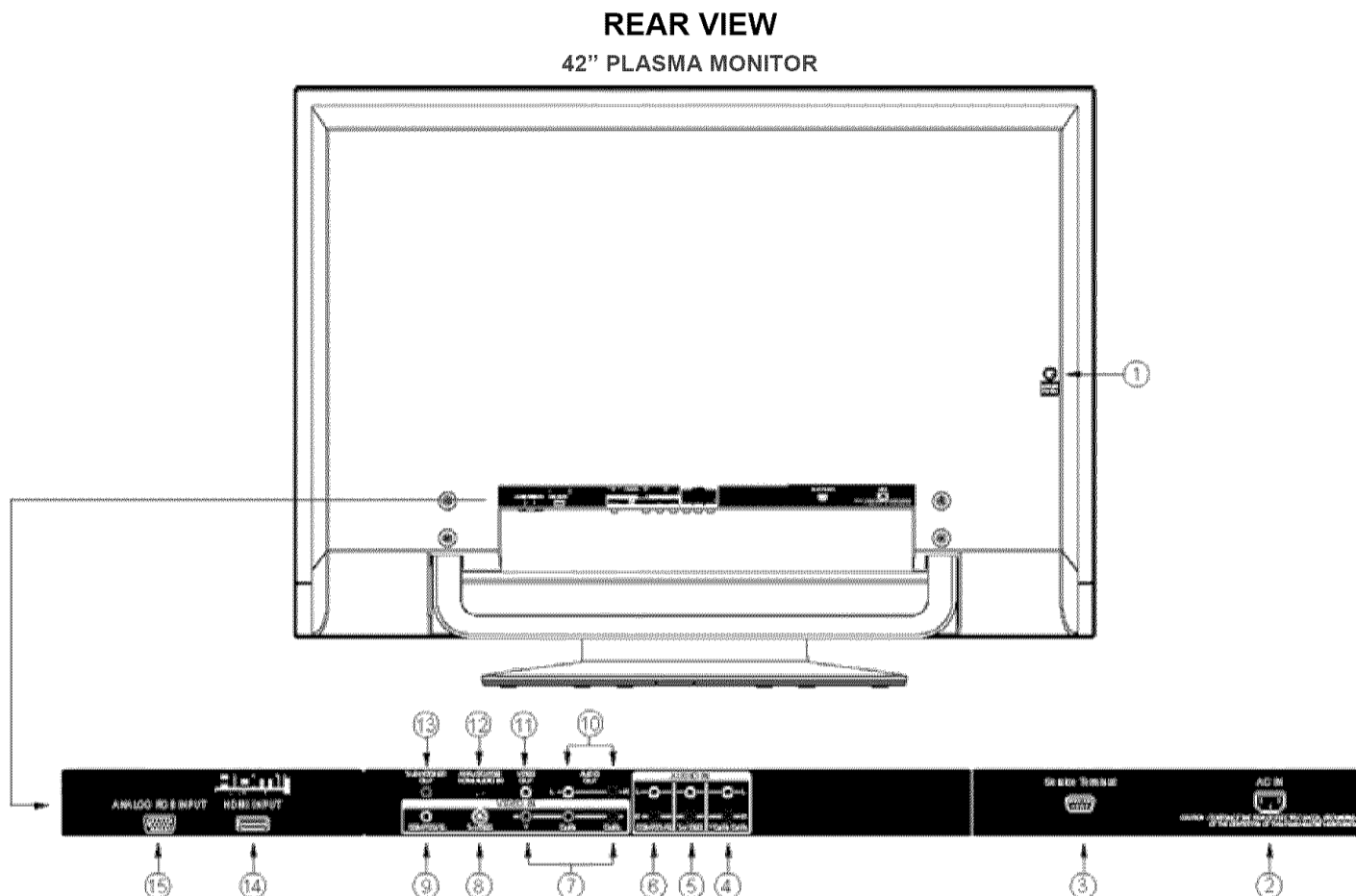

① **MAIN POWER button**

This power button is for the complete system, and must be turned ON/OFF manually. It is recommended to leave the "MAIN POWER" to "ON" condition (lights red) for stand-by mode.

**NOTES:** It is required that there should be at least 5sec. between Main Power button off then on.

② **AC IN input**

This monitor is designed to operate on 120VOLTS 60Hz AC current. Insert the monitor power cord into a 120VOLTS 60Hz outlet.

③ **Service Terminal Input**

For factory adjustment and service, please DO NOT connect here.

④ **Y-PbPr / Y-CbCr - Audio Input**

Connect audio for Component input (if you have mono sound, insert the audio cable into the left(L) audio jack).

⑤ **S-VIDEO - Audio Input**

Connect audio for S-Video input (if you have mono sound, insert the audio cable into the left(L) audio jack).

⑥ **COMPOSITE - Audio Input**

Connect audio for Composite input (if you have mono sound, insert the audio cable into the left(L) audio jack).

⑦ **Y-PbPr / Y-CbCr Inputs**

Provide Y-PbPr / Y-CbCr jacks for connecting equipment with this capability, such as a DVD player or Set Top Box.

⑧ **S-VIDEO Inputs**

Provide S-VIDEO (Super Video) jacks for connecting equipment with S-VIDEO output capability.

English

Português

## REAR PANEL JACKS

### ⑨ COMPOSITE VIDEO Input

By using the VIDEO button of the remote control, you can select Composite video source. Use the audio and video inputs to connect external devices, such as VCRs, camcorders, laserdisc players, DVD players etc.

### ⑩ AUDIO Output

These jacks provide fixed audio signal which are used for recording. (If you have mono sound, insert the audio cable into the left(L) audio jack).

### ⑪ VIDEO Output

This jack provides Composite video signals which are used for recording. S-VIDEO, Component signal, Analog RGB and HDMI inputs do not have VIDEO output.

### ⑫ ANALOG RGB/HDMI Audio Input

Connect audio for ANALOG RGB and HDMI input.

**NOTES:** In case of using analog audio, when connecting with DVI-HDMI transformation connector, use ANALOG RGB/HDMI audio terminal for input.

### ⑬ SUBWOOFER Output

Connect this SUB WOOFER OUT output to the external audio component input.

### ⑭ HDMI - Digital Input

About HDMI

HDMI is the next-generation all digital interface for consumer electronics. HDMI enables the secure distribution of uncompressed high-definition video and multi-channel audio in a single cable. Because digital television (DTV) signals remain in digital format, HDMI assures that pristine high-definition images retain the highest video quality from the source all the way to your monitor screen.

Use the HDMI input for your external devices such as Set-Top-Boxes or DVD players equipped with an HDMI output connection.



HDMI, the HDMI logo and High-Definition Multimedia Interface are trademarks or registered trademarks of HDMI Licensing LLC.

**NOTES:** 1. The HDMI input is not intended for use with personal computers.  
2. Only DTV formats such as 1080i, 720p, 480i and 480p are available for HDMI input.

### ⑮ ANALOG RGB Input

Use this 15-pin D-Sub input for your external devices with RGB output using the D-Sub Mini 15-pin cable provided.



## CONNECTING EXTERNAL SOURCES

**IMPORTANT:** This is a monitor only product. No TV or Cable tuner is included.

The exact arrangement you use to connect the PC, VCR, camcorder, laserdisc player, DVD player, or HDTV Set Top Box to your Plasma monitor is dependent on the model and features of each component. Check the owner's manual of each component for the location of video and audio inputs and outputs.

The following connection diagrams are offered as suggestions. However, you may need to modify them to accommodate your particular assortment of components and features. For best performance, video and audio cables should be made from coaxial shielded wire.

### CONNECTING HDTV SOURCES

HDTV input sources, such as a digital cable box, digital satellite receiver, or digital terrestrial receiver box, can be connected as desired, using the appropriate cable system.

1. Connect the HDTV source device using the appropriate cable pair, in the following order of preference:

HDMI cable OR

Component cable and audio cable

2. Connect all power sources before activating the monitor.

3. Turn on the monitor.

4. Press the button corresponding to the appropriate signal source (HDMI, or Component Video-YC<sub>B</sub>CR/YP<sub>B</sub>PR)

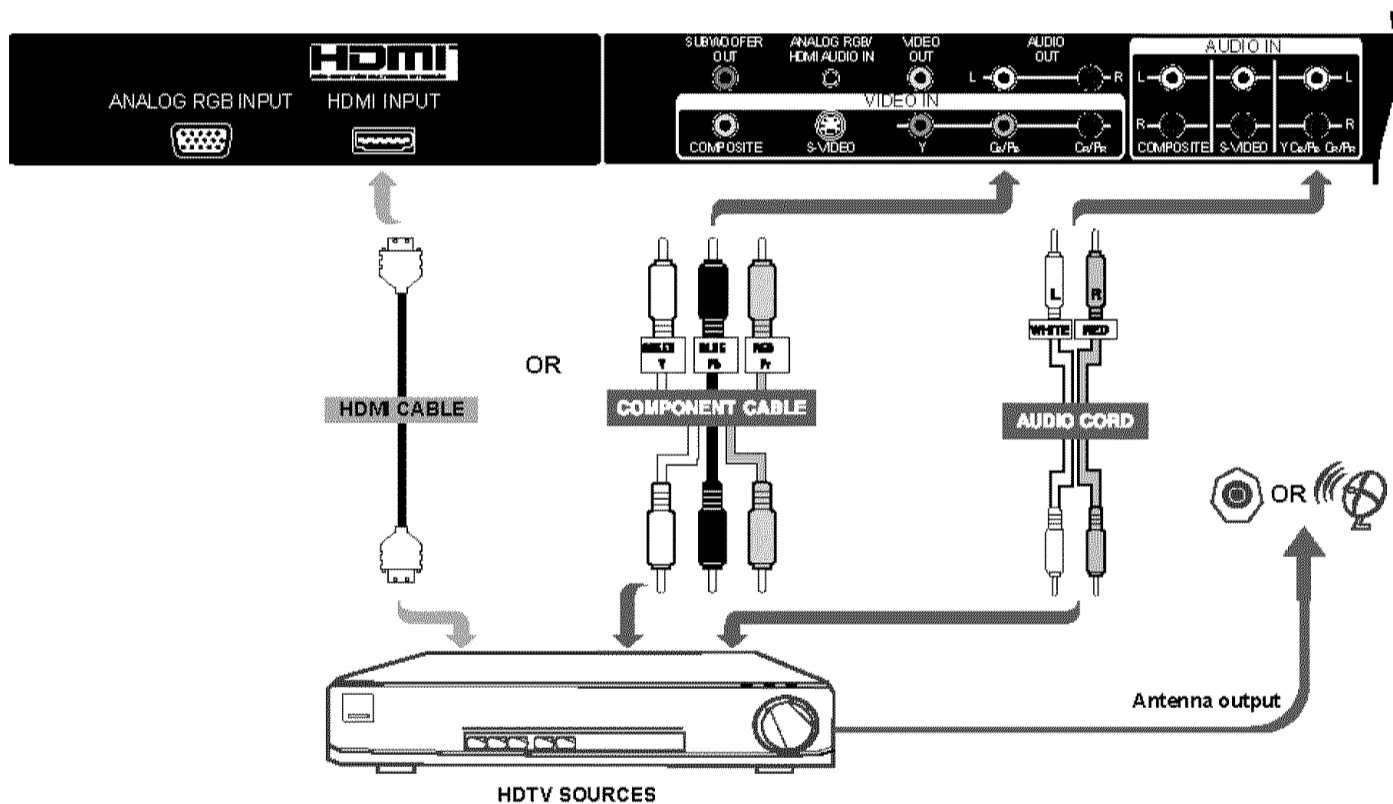

## CONNECTING EXTERNAL SOURCES

### CONNECTING A TV CABLE BOX OR SATELLITE RECEIVER

1. Connect the TV Cable Box or Satellite Receiver device using:

Component cable and Audio cable OR

S-Video cable and Audio cable OR

Composite cable and Audio cable

2. Connect all power sources before activating the monitor.

3. Turn on the monitor.

4. Press the button corresponding to the appropriate signal source (Component Video, YC<sub>B</sub>C<sub>R</sub>/YP<sub>B</sub>P<sub>R</sub>, S-Video or Composite Video)

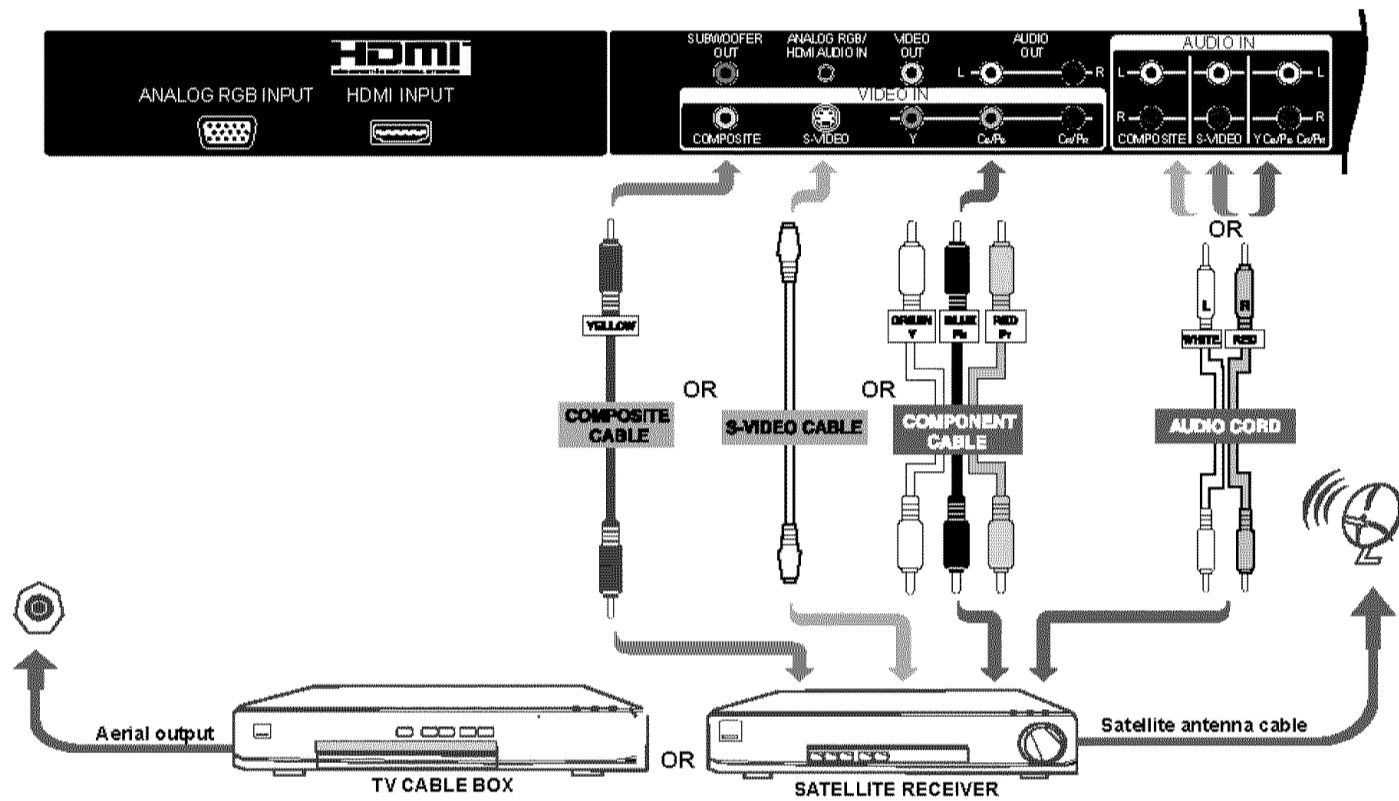

## CONNECTING EXTERNAL SOURCES

### CONNECTING A DVD PLAYER

1. Connect the DVD player using:

HDMI cable OR

Component cable and Audio cable OR

S-Video cable and Audio cable OR

Composite cable and Audio cable

2. Connect all power sources before activating the monitor.

3. Turn on the monitor.

4. Press the button corresponding to the appropriate signal source (HDMI, Component Video, YC<sub>B</sub>Cr/YP<sub>B</sub>P<sub>R</sub>, S-Video or Composite Video)

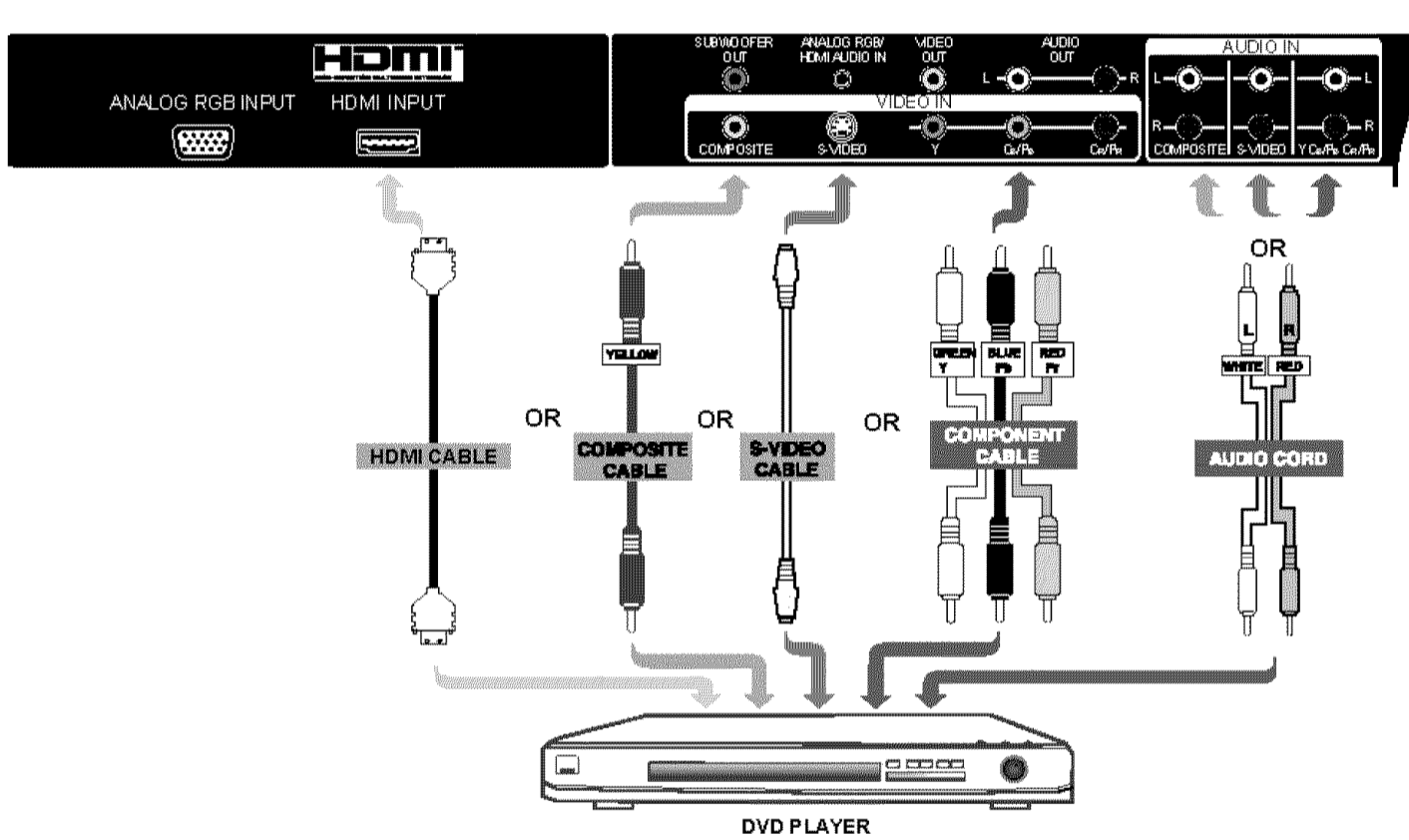

## CONNECTING EXTERNAL SOURCES

### CONNECTING A VCR

1. Connect the VCR player using:
  - S-Video cable and Audio cable OR
  - Composite cable and Audio cable
2. Connect all power sources before activating the monitor.
3. Turn on the monitor.
4. Press the button corresponding to the appropriate signal source (S-Video or Composite Video)

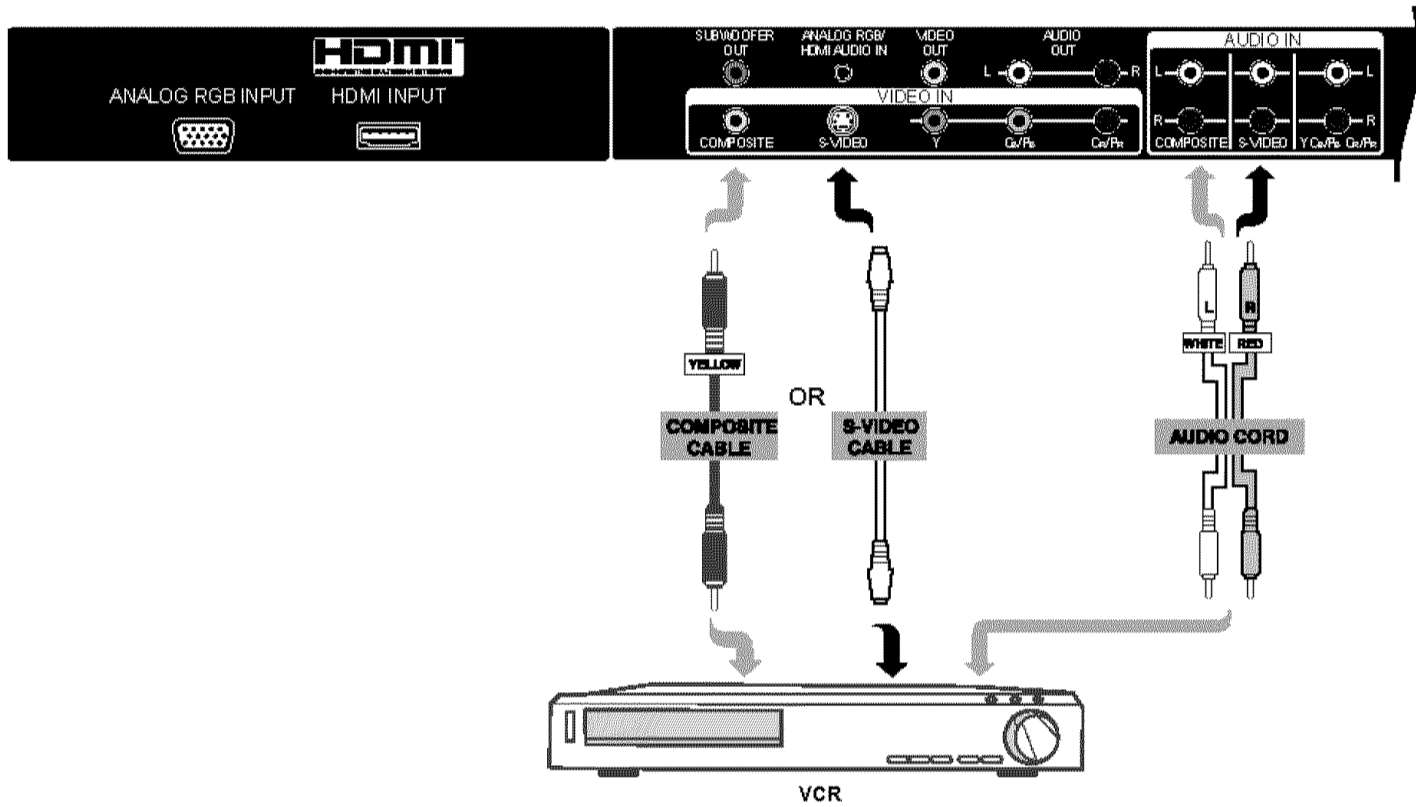

## CONNECTING EXTERNAL SOURCES

### CONNECTING A AUDIO RECEIVER

For improved sound quality, you may want to play the audio of the PDP through your stereo system.

1. Use an audio cable and Subwoofer cable to connect the PDP's audio output jacks to the line input jacks on the A/V receiver.
2. Connect all power sources before activating the monitor.
3. Turn on the monitor.
4. Press the MENU to display the menu, then press ▲ ▼ to select Audio.
5. Press SEL, then press ▲ ▼ to select subwoofer and press ◀ ▶ to select On/Off.

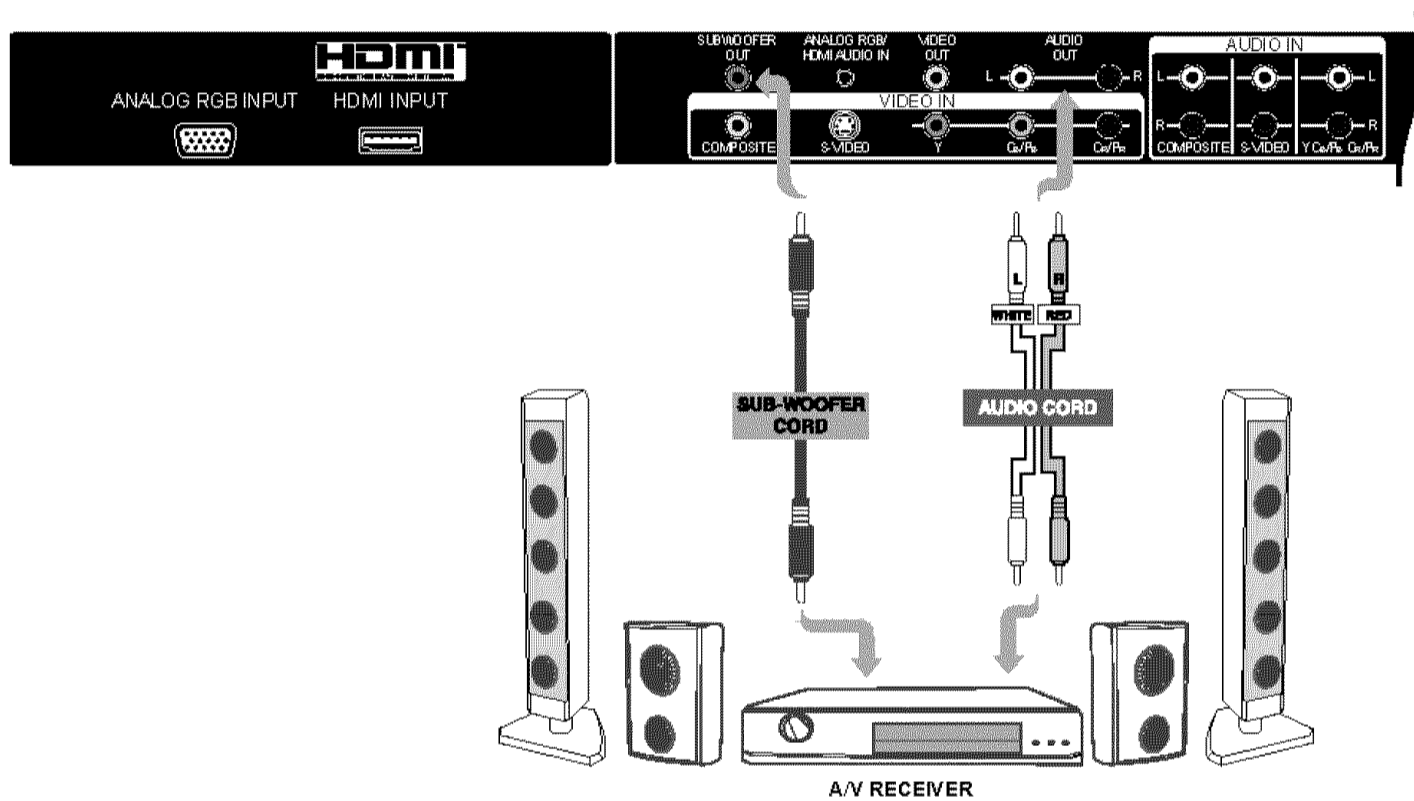

English

Português

# CONNECTING EXTERNAL SOURCES

## CONNECTING PC

1. Connect the PC using:  
D-Sub cable and  $\varnothing$  3.5 mm Audio cable
2. Connect all power sources before activating the monitor.
3. Turn on the monitor.
4. Press the button corresponding to the appropriate signal source (Analog RGB)

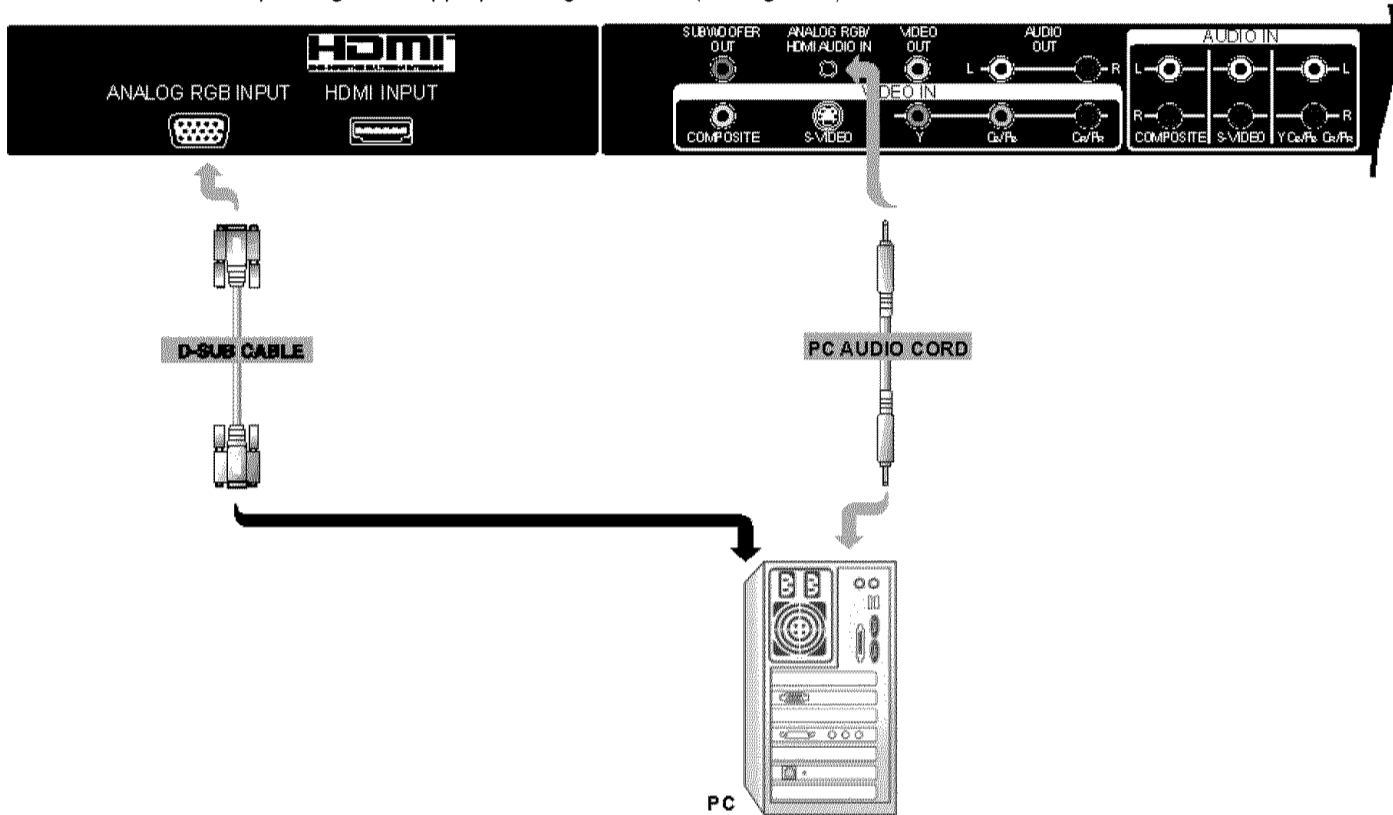

This Plasma monitor can automatically detect and display the signal format below.

### Recommended Signal List

No.	Signal Mode			
	Signal Name	Resolution	Vertical Frequency (Hz)	Horizontal Frequency (kHz)
1	VGA	640 x 400	70.09	31.47
2	VGA	640 x 480	59.94	31.47
3	Macintosh	640 x 480	66.67	35.00
4	VGA	640 x 480	72.81	37.86
5		640 x 480	75.00	37.50
6		640 x 480	85.01	43.27
7		800 x 600	56.25	35.16
8	SVGA	800 x 600	60.32	37.88
9		800 x 600	72.19	48.08
10		800 x 600	75.00	46.88
11		800 x 600	85.06	53.67
12	XGA	1024 x 768	60.00	48.36
13		1024 x 768	70.07	56.48
14		1024 x 768	75.03	60.02
15		1024 x 768	85.00	68.68
16		1280 x 1024	60.02	63.98
17		1280 x 1024	75.03	79.98

## TIPS ON REAR PANEL CONNECTIONS

- S-VIDEO, Y-P<sub>B</sub>P<sub>R</sub> or HDMI connections are provided for high performance laserdisc players etc. that have this feature. Use these connections in place of the standard video connection if your device has this feature.
- If your device has only one audio output (mono sound), connect it to the left(L) audio jack on the monitor.
- Refer to the operating guide of your other electronic equipment for additional information on connecting your hook-up cables.
- Connect only 1 component (VCR, DVD player, camcorder, etc.) to each input jack.
- COMPONENT: Y-P<sub>B</sub>P<sub>R</sub> connections are provided for high performance components, such as DVD players and set-top-boxes. Use these connections in place of the standard video connection if your device has this feature.
- Your component outputs may be labeled Y, B-Y, and R-Y. In this case, connect the components B-Y output to the monitor's P<sub>B</sub> input and the components R-Y output to the monitor's P<sub>R</sub> input.
- Your component outputs may be labeled Y- C<sub>B</sub>C<sub>R</sub>. In this case, connect the components C<sub>B</sub> output to the monitor's P<sub>B</sub> input and the components C<sub>R</sub> output to the monitor's P<sub>R</sub> input.
- It may be necessary to adjust TINT to obtain optimum picture quality when using the Y-P<sub>B</sub>P<sub>R</sub> inputs.
- To ensure no copyright infringement, the VIDEO OUT output will be abnormal, when using the Y-P<sub>B</sub>P<sub>R</sub>, RGB and HDMI input jack.
- VIDEO output may be used for recording only when the input is of Composite Video type.
- When using a HDMI input from a Set-Top-Box, it is recommended to use a 1080i or 720p input signal.



# HOW TO USE THE REMOTE CONTROL TO CONTROL YOUR PLASMA MONITOR

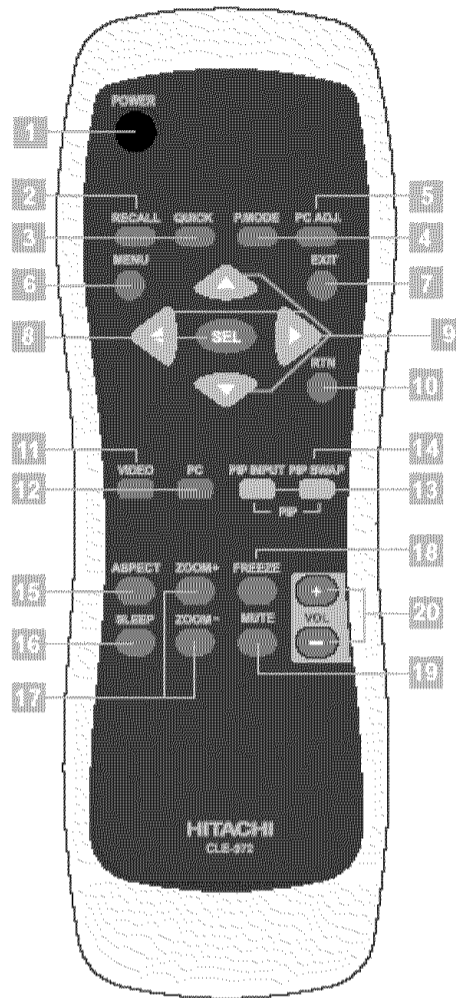

**1. POWER button**

Press this button to turn the monitor set on or standby.

**2. RECALL button**

Press to display source input signal on the display. When the PIP function is working, press to display audio source. Then press ▲ ▼ buttons to select between the sound of your main picture or PIP (Picture in Picture).

**3. QUICK buttons**

Shortcut to access the Brightness, Contrast, Volume, Treble, Bass, and Balance adjustment. Press repeatedly to circle through the selections.

**4. P. MODE button**

Press to select Natural, Cinema and Dynamic picture mode. Press repeatedly to circle through the selections.

**5. PC ADJ. button** (not available for 480p/720p/1080i signals)

When the image is not even or not in the center of the screen under PC mode, press this button for auto adjustment.

**6. MENU button**

The MENU button will start the OSD(On-Screen Display).

**7. EXIT button**

This button will exit all OSD menu.

**8. SEL button**

Press SEL button to select the functions under OSD menu.

# HOW TO USE THE REMOTE CONTROL TO CONTROL YOUR PLASMA MONITOR

## 9. ▲ ▼ ◀ ▶ buttons

Press Up/Down/Left/Right buttons to adjust the options under OSD menu.

## 10. RETURN button

Press this button to jump back to last page of OSD.

## 11. VIDEO button

Shortcut to access the composite video, S-video, Y/C<sub>B</sub>/C<sub>R</sub>, Y/P<sub>B</sub>/P<sub>R</sub> and HDMI mode. Press repeatedly to circle through the selections.

### ATTENTION

Using 480i/576i signals:

When the input signal is 480i or 576i and you select in YP<sub>B</sub>P<sub>R</sub>, the monitor will suggest entering into high quality display mode. If you select yes, the image will display in high quality mode on the screen. Then the monitor will check with again. If you can accept the quality, please choose Yes.

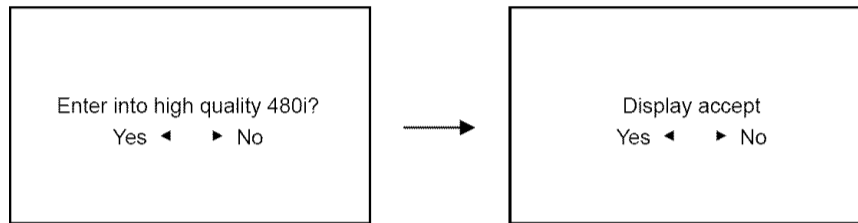

## 12. PC button

Press to switch directly to PC mode.

## 13. PIP INPUT button

Activate PIP by pressing PIP Input button to select desired video input. To turn off PIP by keep pressing PIP Input button until the PIP window disappear. PIP source cannot be the same with main video source. (Analog RGB & Component are not accessible to PIP)

Sub \ Main	Composite	S-Video	Y/C <sub>B</sub> /C <sub>R</sub>	Y/P <sub>B</sub> /P <sub>R</sub>	HDMI	Analog RGB
Composite		○	○	○	○	○
S-Video	○		○	○	○	○
Y/C <sub>B</sub> /C <sub>R</sub>	x	x		x	x	x
Y/P <sub>B</sub> /P <sub>R</sub>	x	x	x		x	x
HDMI	x	x	x	x		x
Analog RGB	x	x	x	x	x	

## 14. PIP SWAP button

Press to exchange the main video signal source with PIP video signal source.

## 15. ASPECT button

Press repeatedly to change image to different aspects. Aspects include 4:3 EXPANDED, 4:3 STANDARD, 4:3 ZOOM1, 4:3 ZOOM2, 16:9 STANDARD, 16:9 ZOOM.

Depending on the input signal format received, the picture format ratio allows you to adjust the images through the following options.

4:3 EXPANDED	Use this aspect mode to display conventional (4:3) sources by linearly increasing image expansion from the center towards the edges of the display area in order to fill it.
4:3 STANDARD	Use this aspect mode to display conventional (4:3) images. Side panels (gray areas) are placed to the left and right of the image to preserve the original aspect ratio of the source. Note: Use this mode for only 15% of your total viewing time to prevent uneven aging of the phosphors. Phosphors in the lighted area of the picture will age more rapidly than the gray areas.
4:3 Zoom1/Zoom2	Use these aspect modes to zoom in on conventional (4:3) sources.
16:9 STANDARD	Use this aspect mode to display 16:9 sources like DVD's preserving the original 16:9 aspect ratio.
16:9 Zoom	Use this aspect to Zoom-in once while in 16:9 aspect.

English

Manuals

# HOW TO USE THE REMOTE CONTROL TO CONTROL YOUR PLASMA MONITOR

(1) 480i/480p/576i/576p/HDMI Input

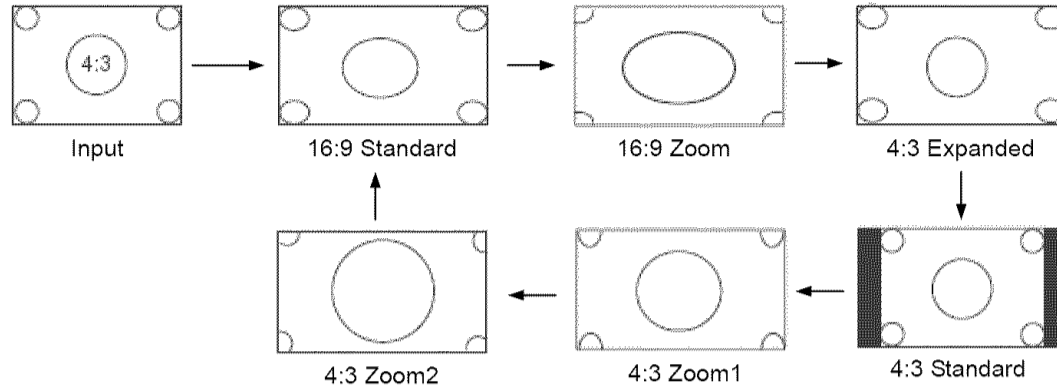

(2) 720p/1080i/HDMI Input

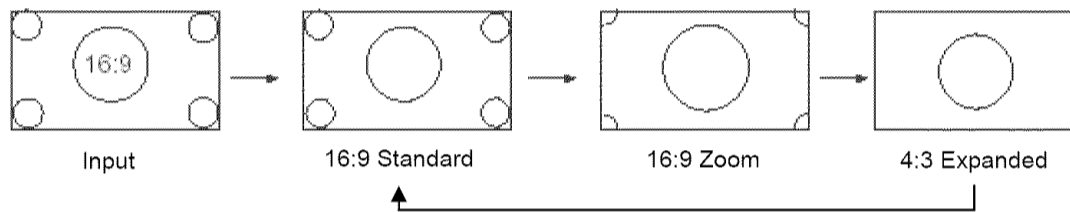

(3) RGB Input

Auto adjust to full size. (Aspect ratio is not changeable.)

## ATTENTION

Using a wide picture size.

- This monitor has a picture size selection feature. If an incompatible size is selected to play certain software, such as a TV program, the image would appear different from original. Take this into consideration when making picture size choices.
- Use of this monitor in its enlarged display mode with the wide feature enabled in coffee shops and other establishments for commercial or public viewing purposes could infringe on the copyright holders right protected by Copyright Law.
- When a normal 4:3 image is displayed over the entire picture in the 4:3 Expanded mode, parts of the periphery of the image may disappear and appear distorted in some cases. Use the 4:3 mode to view image, which were created in 4:3 mode.

## 16. SLEEP button

Press the sleep button repeatedly to set the sleep timer to 30, 60, 90, and 120 minutes.

## 17. ZOOM +/- buttons

Zoom in on the image by pressing Zoom + button and press Zoom – button to zoom out.

## 18. FREEZE button

Freeze button allows user to temporarily pause current image. Press to freeze the image. The picture will restore automatically after 60 seconds or press again to restore the picture.

## 19. MUTE button

Press to mute the volume. Press again to restore the volume.

## 20. VOLUME +/- buttons

Press Vol+ / Vol- buttons to increase and decrease the volume.

## OSD (On-Screen Display)

### USING THE ON-SCREEN DISPLAY (OSD) CONTROLS

1. Press MENU on the remote control to display the different features on your HITACHI Plasma Monitor.
2. Use the ▲▼◀▶ to navigate to different menu item.
3. Use the ◀▶ to adjust functions.
4. Press SEL on the remote control to select functions.
5. Press EXIT on the remote control to quickly exit from a menu.

### THERE ARE TWO DIFFERENT MODES FOR THE OSD ARE THE FOLLOWING:

**Audio/Video Mode:** Displays when the Composite, S-video, Y-CbCr, Y-PbPr or HDMI is selected.

**PC Mode:** Displays when the Analog RGB input is selected.

#### Audio/Video Mode

Video	Picture Mode
	Brightness
	Contrast
	Color
	Tint
	Sharpness
	Color Temperature
	Reset
Image	Aspect
	Border Color Set
	Noise Reduction
	3:2 Pull Down
Audio	Mute
	Volume
	Treble
	Bass
	Balance
	SRS WOW
	Subwoofer
Language	English
	French
	Spanish
System	Signal Format
	Advanced
	PIP Set
	System Reset

#### PC Mode

Video	Brightness
	Contrast
	H Position
	V Position
	Sharpness
	Color Temperature
	Reset
	Image
Clock Phase	
Horizontal Clock	
Audio	Mute
	Volume
	Treble
	Bass
	Balance
	SRS WOW
	Subwoofer
Language	English
	French
	Spanish
System	Signal Format
	Advanced
	PIP Set
	Power Save
	System Reset

English

French

## OSD (On-Screen Display)

<b>Video</b>	Adjusts the picture mode, brightness, contrast, color, tint, sharpness, color temperature and position of your display.
--------------	---

### Audio/Video Mode

Video	Function	Options
Picture Mode	Select a preset customized picture setting.	- Natural - Cinema - Dynamic
Brightness	Adjusts the darkness and lightness of the display.	0 to 100
Contrast	Adjusts the color brightness of the display.	0 to 100
Color	Adjusts the saturation level of color.	0 to 100
Tint	Adjusts the color properties. (Not available for PAL system)	0 to 100
Sharpness	Adjusts the clarity of images.	0 to 31 0 to 7 (For YP <sub>B</sub> P <sub>R</sub> and HDMI signals only)
Color Temperature	Adjusts the level of the color temperature.	- Cool - Natural - Warm - Black & White - User
Reset	Puts all of your display settings back to their default.	

### PC Mode

Video	Function	Options
Brightness	Adjusts the darkness and lightness of the display.	0 to 100
Contrast	Adjusts the color brightness of the display.	0 to 100
H Position	Moves image to the left or right. (Not available for 720p/720p, 50Hz/1080i/1080i, 50Hz signals)	0 to 100
V Position	Moves image up or down. (Not available for 720p/720p, 50Hz/1080i/1080i, 50Hz signals)	0 to 100
Sharpness	Adjusts the clarity of images. (Available for 480p/720p/1080i signals)	0 to 7
Color Temperature	Adjusts the level of the color temperature.	- Cool - Natural - Warm - Black & White - User
Reset	Puts all of your display settings back to their default.	

## OSD (On-Screen Display)

### Image

Adjust scaling, auto adjust, border color set, noise reduction, 3:2 pull down, clock phase and horizontal clock.

#### Audio/Video Mode

Image	Function	Options
Aspect (Please see "ASPECT" on page 23 for more information.)	Select the screen sizes. (Available for 480i/480p/576i/576p/HDMI signals.)	- 4:3 expanded - 4:3 standard - 4:3 Zoom1 - 4:3 Zoom2 - 16:9 standard - 16:9 zoom
	Select the screen sizes. (Available for 720p/1080i/HDMI signals.)	- 4:3 expanded - 16:9 standard - 16:9 zoom
Border Color Set	Select the border color when display 4:3 video.	- Black - Gray
Noise Reduction	Provide 3 models for reducing video noise. (Not available for YP <sub>B</sub> P <sub>R</sub> /HDMI signals)	- Off - Level 1 - Level 2 - Level 3
3:2 Pull Down	Improve the picture quality. (Not available for YP <sub>B</sub> P <sub>R</sub> /HDMI signals)	- Disable - Enable

#### PC Mode

Image	Function	Options
Auto Adjust	Automatically detects video format. (Not available for 480p/576p/720p/1080i signals)	Auto
Clock Phase	Video timing adjustment.	0 to 31
Horizontal Clock	Moves image left and right.	0 to 100

English

Portals

## OSD (On-Screen Display)

**Audio** Adjusts the mute, volume, treble, bass, balance, SRS WOW and Subwoofer of your sound.

Audio	Function	Options
Mute	Turns off the sound.	Enable or disable
Volume	Increases and decreases the level of sound.	0 to 63
Treble	Increases and decreases the level of treble. (When SRS WOW select "On", this function is not available)	-16 to +16
Bass	Increases and decreases the level of bass. (When SRS WOW select "On", this function is not available)	-16 to +16
Balance	Adjusts the left and right sound level.	-16 to +16
SRS WOW	Turns SRS WOW function on and off.	On or Off
Subwoofer	Turns Subwoofer function on and off.	On or Off



SRS WOW is an audio enhancement technology from SRS Labs that provides deep, rich bass on any speaker system without the need for a subwoofer or additional extra physical components. For systems with a subwoofer, SRS WOW complements and enhances the bass performance. This feature can be set to On or Off.

**NOTES:** WOW, SRS and the  symbol are trademarks of SRS Labs, Inc. SRS WOW technology is incorporated under license from SRS Labs, Inc.

**Language** Adjusts the OSD language.

Language	Function	Options
Language	Set the language for the OSD.	- English - French - Spanish



## OSD (On-Screen Display)

<b>System</b>	Adjusts the screen format, and PIP settings.
---------------	--

### Audio/Video Mode

System	Function	Options
Signal Format	Displays video signal information.	
Advanced	Adjusts the gamma and move screen function.	<ul style="list-style-type: none"> <li>- Move Screen Mode: Off, Mode 1 or Mode 2</li> <li>- Move Screen Time: 255~5 sec</li> </ul>
PIP Set	Adjust the PIP source, position, audio source, and display.	<ul style="list-style-type: none"> <li>- Source: AV and SV</li> <li>- Size: PIP Off, Small, Medium, Large.</li> <li>- Position: Nine different positions.</li> <li>- Audio Source: Select between the sound of your main picture or PIP.</li> <li>- PIP Display: Adjust the brightness, contrast and color.</li> <li>- Swap: Switches your main picture and PIP.</li> </ul>
System Reset	Sets OSD back to default settings.	

### PC Mode

System	Function	Options
Signal Format	Displays RGB signal information.	
PIP Set	Adjust the PIP source, position, audio source, and display.	<ul style="list-style-type: none"> <li>- Source: AV and SV</li> <li>- Size: PIP Off, Small, Medium, Large.</li> <li>- Position: Nine different positions.</li> <li>- Audio Source: Select between the sound of your main picture or PIP.</li> <li>- PIP Display: Adjust the brightness, contrast and color.</li> </ul>
Advanced	Adjusts the white pattern and gamma.	<ul style="list-style-type: none"> <li>- Gamma: 0.8, 1.0, 1.2, or 1.4</li> <li>- Move Screen Mode: Off, Mode 1 or Mode 2</li> <li>- Move Screen Time: 255~5 sec</li> </ul>
Power Save	Turns Display Power Management System on and off.	On or Off
System Reset	Sets OSD back to default settings.	

## **USEFUL INFORMATION**

---

### **CARE OF YOUR HITACHI PLASMA MONITOR AND YOUR REMOTE CONTROL**

#### **DO**

Dust the screen and frame with a cleaning cloth from the accessories pack.

Clean the screen and frame with a soft cloth moistened in warm water and dry with a soft cloth. A mild soap may be used if the screen is extremely dirty.

Place your Plasma Monitor away from extreme heat, humidity, and extremely dusty places.

Remove the plug from the wall outlet if your Plasma Monitor will not be used for a long period of time, for instance, when you go on vacation.

#### **DO NOT**

Do not clean your screen with strong cleaners, polishes or a chemically treated cloth.

Do not place rubber or vinyl products or cellophane tape on your Plasma Monitor.

Avoid repeatedly touching the screen.







Do not subject the remote control to shocks such as dropping it on the floor, etc. This may cause physical damage to the precision parts.

Avoid placing the remote control in a high humidity place or getting it wet. Do not leave it on or near a heater. Excessive heat or moisture may cause the remote control unit to fail.

When the batteries run down, remote control operation will become erratic or become unresponsive. Replace the old batteries with two new "AAA" size batteries. Do not use an old battery with a new battery.

Exposing the screen to direct sunlight for a long period of time or heat may cause damage to the plasma screen.

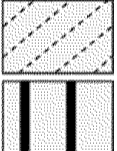
## RECEPTION PROBLEMS

	<ul style="list-style-type: none"> <li>• <b>IGNITION NOISE:</b> Black spots or horizontal streaks may appear, picture may flutter or drift. Usually caused by interference from automobile ignition systems, neon lamps, electrical drills, and other electrical appliances.</li> </ul>
	<ul style="list-style-type: none"> <li>• <b>GHOSTS:</b> Ghosts are caused by the monitor signal following two paths. One is the direct path and the other is reflected from tall buildings, hills or some other objects. Changing the direction or position of the antenna may improve reception. Ghosting may also be caused by defects in the antenna system such as unshielded leads or connecting several sets to the same antenna without using multiple antenna couplers.</li> </ul>
	<ul style="list-style-type: none"> <li>• <b>SNOW:</b> If your receiver is located in the fringe area of a television station where the signal is weak, your picture may be marred by the appearance of small dots. When the signal is extremely weak, it may be necessary to install a special antenna to improve the picture.</li> </ul>
	<ul style="list-style-type: none"> <li>• <b>RADIO FREQUENCY INTERFERENCE:</b> The interference produces moving ripples or diagonal streaks, and in some cases, causes loss of contrast in the picture.</li> <li>• <b>PREVENTION OF AN OBSTACLE TO RADIO RECEIVERS</b> This monitor has been designed pursuant to the FCC class B Rules. This is to prevent a problem to Radio receivers. If this monitor causes a problem to Radio receivers, then take the following steps: <ul style="list-style-type: none"> <li>- Keep the monitor away from Radio.</li> <li>- Adjust Radio antennas in order for the monitor not to receive interference.</li> <li>- The antenna cable of Radio should be kept away from the monitor.</li> <li>- Use a coaxial cable for antenna.</li> </ul> </li> </ul> <p>You can check if this monitor influences Radio receivers by turning off all other equipment other than the monitor. If you find a problem receiving Radio when using the monitor, check the instructions mentioned above.</p>
<ul style="list-style-type: none"> <li>• The display image appears scrolling diagonal.</li> <li>• Text displayed across the screen appears vertically streaked, with the characters in vertical columns blurred.</li> </ul> 	<ul style="list-style-type: none"> <li>• Adjust the horizontal clock and clock phase. (Adjust the horizontal clock first, the clock phase next.) (RGB input)</li> </ul>
<ul style="list-style-type: none"> <li>• Text displayed across the screen appears blurred.</li> <li>• A fine pattern flickers when displayed on the screen.</li> </ul> 	<ul style="list-style-type: none"> <li>• Adjust the clock phase for the clearest viewing. (RGB input)</li> </ul>
<ul style="list-style-type: none"> <li>• Vertical stripes appear, depending on the screen contents.</li> </ul>	<ul style="list-style-type: none"> <li>• The plasma display panel is lighting the phosphors by the discharge of internal radiation. Depending on the screen contents, in rare cases this may cause vertical stripes to appear because of failure to light. Please note that this is not a malfunction.</li> </ul>
<ul style="list-style-type: none"> <li>• Coarse horizontal stripes appear in FULL display.</li> </ul>	<ul style="list-style-type: none"> <li>• Adjusting the clock phase will reduce the horizontal stripes. (RGB input)</li> </ul>
<ul style="list-style-type: none"> <li>• The display dims to make the picture invisible during special playback of a VCR (FF, REW).</li> </ul>	<ul style="list-style-type: none"> <li>• This condition may occur when the unit is connected to a VCR with component output, such as 480i, but it is not a failure. But when it occurs, switch to composite output.</li> </ul>

# USEFUL INFORMATION

SYMPTOMS	CHECK THESE ITEMS AND TRY THESE ADJUSTMENTS									
	Be sure external connection is correct	Be sure power cord is plugged in	Be sure Monitor is switched on	Try another video source	Check for local interference	Adjust Contrast control	Adjust Brightness control	Adjust Color control	Adjust Tint control	Adjust Volume control
No Picture, no sound	●	●	●	●						●
Sound OK, picture poor	●			●	●	●	●			
Picture OK, sound poor	●			●	●					●
Picture blurred	●			●	●					
Lines or streaks in picture				●	●					
Picture rolls vertically				●	●					
No color	●			●				●		
Poor color	●			●				●	●	

## USEFUL INFORMATION

### PLUG and PLAY

This Plasma Monitor complies with VESA DDC2B specifications; Plug & Play is a system with computer, peripherals (including monitors) and operating system. It works when the monitor is connected to a DDC ready computer that is running an operating system software that is capable for the plug & play. When a Plug and Play PC is powered on, it sends a command to the Monitor requesting identification. The Monitor sends back a string of data including its characteristics.

### TRADEMARK ACKNOWLEDGMENT

DDC™ is a trademark of Video Electronics Standard Association.  
IBM PC/AT and VGA are registered trademarks of International Business Machines Corporation of the U.S.A.  
Apple and Macintosh are registered trademarks of Apple Computer, Inc.  
VESA is a trademark of a nonprofit organization, Video Electronics Standard Association.

This Class B digital apparatus meets all requirements of the Canadian Interference-Causing Equipment Regulations.  
This Class B digital apparatus complies with Canadian ICES-003.  
Cet appareil numérique de la classe B est conforme à la norme NMB-003 du Canada.

English

Français

## USEFUL INFORMATION

---

### AGENCY REGULATORY INFORMATION

#### Federal Communications Commission Notice

This equipment has been tested and found to comply with the limits for a Class B digital device, pursuant to Part 15 of the FCC Rules. These limits are designed to provide reasonable protection against harmful interference in a residential installation. This equipment generates, uses and can radiate radio frequency energy and if not installed and used in accordance with the instructions, may cause harmful interference to radio communications. However, there is no guarantee that interference will not occur in a particular installation. If this equipment does cause harmful interference to radio or monitor reception, which can be determined by turning the equipment off and on, the user is encouraged to try to correct the interference by one or more of the following measures:

- Reorient or relocate the receiving antenna.
- Increase the separation between the equipment and the receiver.
- Connect the equipment into an outlet on a circuit different from that to which the receiver is connected.
- Consult the dealer or an experienced radio/television technician for help.

#### Modifications

The FCC requires the user to be notified that any changes or modifications made to this device that are not expressly approved by Hitachi Home Electronics (America), Inc. may void the user's warranty.

#### Cables

Connections to this device must be made with shielded cables with metallic RFI/EMI connector hoods to maintain compliance with FCC Rules and Regulations.

Any cables that are supplied with the system must be replaced with identical cables in order to assure compliance with FCC rules. Order Hitachi spares as replacement cables.

#### Declaration of Conformity

This device complies with Part 15 of the FCC Rules. Operation is subject to the following two conditions: (1) this device may not cause harmful interference and (2) this device must accept any interference received, including interference that may cause undesired operation.

For questions regarding this declaration, contact:

Hitachi America, LTD.  
Home Electronics Division  
900 Hitachi Way  
Chula Vista, CA 91914-3556  
Tel. 1-800-448-2244 (1-800-HITACHI)  
ATTN: CUSTOMER RELATIONS

## USEFUL INFORMATION

### Features:

- New Easy-to-Use On-Screen Menu Control (3 Language)
- Film Mode Process with 3:2 & 2:2 pull down
- Adjustable Color Temperature
- PIP
- Picture Enhancement
- Input Signal Identification
- Noise Reduction
- HDMI (High Definition Multimedia Interface)(High Bandwidth Digital Content Protection V1.1 Compatible)

### Video:

- 1024 x 1024 Display Resolution
- High-Contrast Pure-Color Glass Shield
- Wide Viewing Angle: More than 160°
- 4 Color Temperature Presets: Cool, Natural, Warm, Black& White and User.
- Multiple Screen Fill Modes (4:3 Standard, 4:3 Expanded, 4:3 Zoom1, 4:3 Zoom2, 16:9 Standard, 16:9 Zoom)
- 3D Y/C Comb Filter
- Picture Modes (Natural, Cinema and Dynamic)
- Computer Display: VGA, (SVGA, XGA)

### Inputs:

- Power Input . . . . .AC 120V, 60Hz
- Video . . . . . 1.0Vp-p, 75 Ohm
- S-Video
  - Luminance (Y) . . . . . 1.0Vp-p, 75 Ohm
  - Chrominance (C) . . . . . 0.286Vp-p, 75 Ohm
- Component Video
  - Luminance (Y) . . . . . 1.0Vp-p, 75 Ohm
  - Chrominance (P<sub>B</sub>/P<sub>R</sub>) . . . . . 0.7Vp-p, 75 Ohm
- Audio input Impedance . . . . . 47k Ohm
- Average input level . . . . . 470mVrms
- RGB . . . . . 0.7Vp-p, 75 Ohm
- HDMI . . . . . (19 PIN)

### Outputs:

- Video . . . . . 1.0Vp-p, 75 Ohm
- Audio . . . . . 470mVrms, 1k Ohm
- Subwoofer . . . . . 500mVrms, 3.8k Ohm

### Audio:

- SRS
- 10W+10W
- Mute

### Supplied Accessories:

- Remote Control
- Batteries
- D-Sub Cable
- S-Video Cable
- AV Cable
- Power Cable
- User's Guide
- Easy Graphic Guide
- Warranty Card

### Optional Accessories:

- Wallmount

### INPUTS/OUTPUTS

• Component Y, P <sub>B</sub> , P <sub>R</sub> . . . . .	1
• RGB: Analog Input . . . . .	1
• HDMI . . . . .	1
• Composite Video . . . . .	1
• S-Video . . . . .	1
• Audio Input . . . . .	4
• Audio Output . . . . .	1
• Video Output . . . . .	1
• Subwoofer Output . . . . .	1

### SPECIFICATIONS

- Multi-Scanning: . . . . . 32-70kHz (h), 50-85Hz (v)
- Pixel Pitch . . . . . 0.90(horiz.) x 0.51(vert.) mm
- FCC class: . . . . . B for Consumer Use
- Power Requirements: . . . . . AC 108~132V, 60Hz
- Power Consumption: . . . . . 350W
- at standby . . . . . <1W

### DIMENSIONS

- Width: 1036 mm
- Height: 775 mm (with stand); 713 mm (without stand)
- Depth: 330 mm (with stand); 93 mm (without stand)
- Weight: 42.5Kg (with stand); 35Kg (without stand)

Screen mode availability varies by input format

HDTV Monitors display HDTV when combined with an HDTV Tuner and Source.

All specifications, weights, and dimensions are subject to change without prior notice. Please access [www.hitachi.com/tv](http://www.hitachi.com/tv) for detailed specifications and dimensions for custom installations.

UltraVision Digital is a registered trademark of Hitachi Home Electronics (America), Inc.

WOW, SRS and the  symbol are trademarks of SRS Labs, Inc. WOW technology is incorporated under license from SRS Labs, Inc.

 HDMI, the HDMI logo and High-Definition Multimedia Interface are trademarks or registered trademarks of HDMI Licensing LLC.

English

Accessories



## USEFUL INFORMATION

---

# HITACHI



To locate an authorized  
HITACHI service facility  
in the continental U.S.A.  
and Canada,

**DIAL TOLL FREE**

7 days a week, 24 hours a day

**800 HITACHI**

**(1-800-448-2244)**

### **Hitachi America, LTD. Home Electronics Division**

---

Hitachi has made every effort to assure you hours of trouble free operation from your unit. However, should you require service, a network of Hitachi Authorized Service Facilities has been established in all 50 states and Puerto Rico. Each facility will provide you with convenient and expedient assistance. Our service hotline operator will direct you to the Hitachi Authorized Service Facility nearest you. Just present proof of purchase and/or delivery receipts to the Hitachi Authorized Service Facility, and service will be rendered in accordance with the terms of the limited warranty as stated on your warranty card or operating guide.

---

*Should you have any questions regarding warranty, service, operation, or technical assistance, please contact:*

**Hitachi America, LTD.**  
**Home Electronics Division**  
900 Hitachi Way  
Chula Vista, CA 91914-3556

## **USEFUL INFORMATION**

---

**Hitachi Canada, LTD.  
Digital Media Division**

---

*Should you have any questions regarding warranty, service, operation, or technical assistance, please contact:*

**In Canada:  
1-800-HITACHI  
(1-800-448-2244)**

**Monday - Friday EST 9:00am - 7:00pm  
Saturday EST 9:00am - 5:00pm**

*Look for your French Manual on the outside of the box.*

*If the manual is missing, call*

**1-800-HITACHI  
(1-800-448-2244)**

*for a copy.*

---

*Pour de plus amples renseignements sur le service durant la période couverte par la garantie, sur le fonctionnement ou pour de l'assistance technique communiquez avec:*

**Au Canada:  
1-800-HITACHI  
(1-800-448-2244)**

**Lundi - Vendredi L'EST 9:00am - 7:00pm  
Samedi L'EST 9:00am - 5:00pm**

*La version française de votre manuel se trouve à l'extérieur de la boîte.*

*Si le manuel est manquant, composez le*

**1-800-HITACHI  
(1-800-448-2244)**

*pour obtenir votre copie.*

**HITACHI CANADA, LTD.  
2495 Meadowpine Blvd.  
Mississauga, ON L5N 6C3**

English

Français