

Model MJ 9200W
Separate/Stacking Washer

Owners Manual

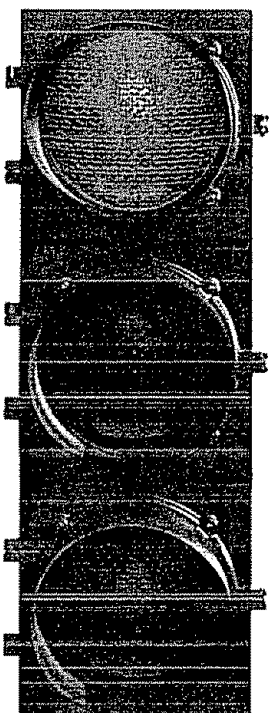

Important Safety Instructions

WARNING- To reduce the risk of fire, electric shocks, or injury to persons when using your appliance, follow the basic precautions, including the following:

1. Read all instructions before using the appliance.
2. Do not wash articles that have been previously cleaned in, washed in, or spotted with gasoline, dry-cleaning solvents, or other flammable and explosive substances such as solvents.
3. Do not add gasoline, dry-cleaning solvents or other flammable or explosive substances to the wash water. These substances give off vapors that could ignite or explode.
4. Under certain conditions, hydrogen gas may be produced in a hot water system that has not been used for 2 weeks or more. If this is the case, before using your washing machine, turn on all hot water faucets and let the water flow from each faucet for several minutes. This will release any accumulated hydrogen gas. Do not smoke or use an open flame during this time.
5. Do not allow children to play on or in the appliance. Close supervision of children is necessary when the appliance is in use.
6. Before the appliance is removed from service or discarded, remove the door.
7. Do not reach into the appliance if the tub or agitator is moving.
8. Do not install or store this appliance where it will be exposed to the weather.
9. Do not tamper with controls.
10. Do not repair or replace any part of the appliance or attempt any servicing unless specifically recommended in the user-maintenance instructions or in published user-repair manual. Also make sure that you understand the instructions completely and have the skills to carry them out.
11. Do not use fabric softeners or products to eliminate static unless recommended by the manufacturer of the fabric softener or product.
12. Do not place items exposed to cooking oils in your dryer. Items contaminated with cooking oils may contribute to a chemical reaction that could cause a load to catch fire.
13. This appliance must be grounded. Refer to the **INSTALLATION INSTRUCTIONS** for grounding details.

SAVE THESE INSTRUCTIONS

Welcome !



Congratulations. Welcome to the growing family of Majestic™ Appliance owners. By choosing a Majestic Appliances model as your laundry appliance you not only found the best in reliable technology, but above all you have found a faithful and untiring convenience appliance.

Your machine is strong, reliable and long lasting. All those qualities which have made the Majestic™ trademark famous the world over.

Above all, Majestic products are easy to use. Read this owner's manual carefully since it contains all the instruction for safe installation, use and maintenance. Remember to keep your owner's manual in a safe place so that you can refer to it whenever you need to.

For addition information and contact with the our staff, we invite you to visit our web site.

<http://www.MajesticAppliances.com>

(Please Register your appliance, on our web site or by returning your registration card via mail and receive a complimentary VHS tape, "Introduction to Majestic")

We offer a wide range of appliance products, some of which might suit your needs. We also offer our revolutionary MajesticAppliances.TV (<http://www.majesticappliances.tv>)web option, where you can view orientation and service movies on the web as well as comments from other users and frequently asked questions. Welcome to our Family!



Table of Contents

Instant help

Page 5

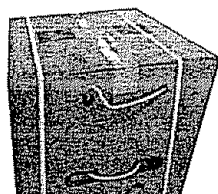

Getting things ready to install your appliance

Unpacking, Inspecting, Electricity, Closets/Alcoves, Plumbing, Venting

Page 8

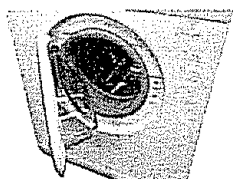

For best results washing

Preparation, sorting, inspecting, pre-wash treatments, helpful laundry hints, simple controls, detergent dispensers

Page 11

Stain removal

Fabrics, methods, tips

Page 13

Troubleshooting



Washing, Drying, Vibration, Optimizing dry time, wrinkles, draining

Page 14

Maintenance tips



Water, exterior, interior, winterizing, detergent, pump, technical specifications, Obtaining Service

Page 16

Warranty Information

Registering your appliance via the internet, Extended Warranty options, ordering maintenance manuals

Installing/Removing Getting things ready to install your appliance

Unpacking, Inspecting, Electricity, Closets/Alcoves, Plumbing, Venting Unpacking

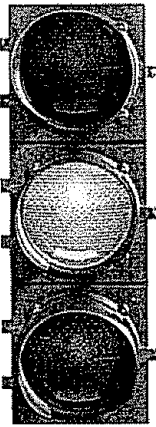

- Check the packing box for external damage. It is your responsibility to register any damage with the freight company delivering the product
- Remove the strapping, then slide the cardboard surround off the machine. Remove the foam protecting material and the plastic bag
- Write down the serial number from the box or the back of the machine
- Destroy the carton, plastic bags and foam parts after appliance has been unpacked.
- Children should never be left alone or unattended in the area where appliances being unpacked.
- If you have any doubts, do not use the appliance and call a qualified technician

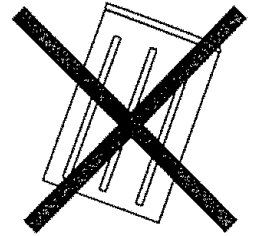

WARNING :
OWNER RESPONSIBLE FOR DAMAGE RESULTING FROM TIPPING MACHINE AFTER REMOVING SHIPPING BOLTS. AVOID TIPPING MACHINE FORWARD AFTER SHIPPING BOLTS ARE REMOVED.

Inspecting WHEN TO REMOVE SHIPPING BOLTS!

WARNING!!! TIPPING THE MACHINE TO POSITION IT FOR USE MUST BE DONE WITH THE SHIPPING BOLTS STILL IN THE MACHINE! TIPPING THE MACHINE WITHOUT SHIPPING BOLTS, CAN CAUSE THE INNER DRUM TO IMPACT OTHER INTERNAL PARTS, THUS DAMAGING THEM. POSITION THE MACHINE AS CLOSE AS POSSIBLE TO IT'S FINAL POSITION AND THEN REMOVE SHIPPING BOLTS.

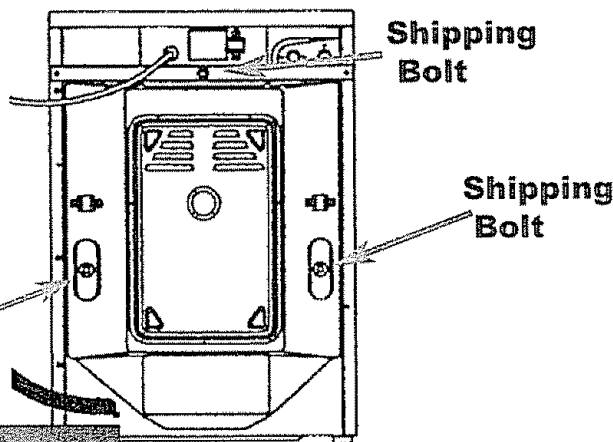

Shipping Bolt

Shipping Bolt

Shipping Bolt

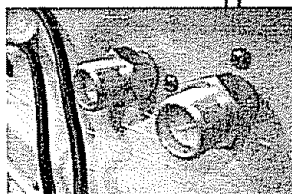

Brass Pressure Regulators installed on back of appliance.

- INSPECT CONTENTS
- Owners Manual
- Brass Pressure Regulators
(Must be installed on hot and cold water inlet. Failure to do so can damage the internal components and cause water damage for which the installer/owner will be responsible!)
- Warranty Registration Card
- Majestic Literature
- Drain Hose U-Clip (Optional)
- Hoses have washers in both ends.

Installing/Removing Getting things ready to install your appliance (continued)

Electricity



Make sure that the voltage and frequency available correspond with the values stated on the data plate located at the back of the machine and that the electric system is dimensioned to withstand the maximum current shown on the data plate. If the socket the machine is connected to does not correspond with the plug, replace the plug with a suitable one and avoid using adapters or shunts since they could cause over heating and burn out.

Grounding

This appliance must be grounded. In the event of malfunction or breakdown, grounding will reduce the risk of electric shock by providing a path of least resistance for electric current. This appliance is equipped with a cord having an equipment-grounding conductor and a grounding plug. The plug must be plugged into an appropriate outlet that is properly installed and grounded in accordance with all local codes and ordinances.

WARNING- Improper connection of the equipment-grounding conductor can result in a risk of electric shock. Check with a qualified service representative or personnel if you are in doubt as to whether the appliance is properly grounded.

Do not modify the plug provided with the appliance: if it will not fit the outlet, have a proper outlet installed by a qualified electrician.

Electrical Specifications:

Voltage/Amperage - 115V, 12 Amp, 60 Hz 3 Prong plug attached to the appliance in the factory

Circuit/Protection - 3 wires single phase, 120V, 60 Hz, AC separate 15 amp circuit or greater.

Recessed, Closet and Alcove Installations

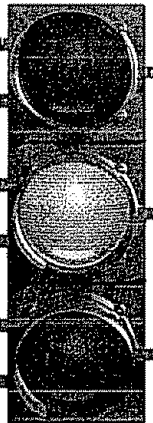

This appliance may be installed in a recessed area, closet or alcove. All measurements are in inches.

- If the appliance is to be installed in a closet with zero clearance on the side of the appliance, a total of 12 square inches of free air space movement to the back of the unit must be allowed into the closet.
- If a door is to be installed that potentially encloses the unit while running, the door must allow for a minimum of 20 square inches of free air movement. There must also be a 1" space from the front of the unit to the closed door and 1" from the back of the unit to the wall. Additional spacing should be considered for easy installation, servicing, removal and compliance with applicable local, state and federal codes.
- The floor must be able to support at least 280 lbs and a surface that is solid and level.
- Installations in RV's or Marine pleasure craft suggest that the machine might best be installed midships in the boat, or over the axles of the RV where movement is at a minimum.

Adequate blocking should prevent extreme movement when installed in an RV or Marine pleasure craft.

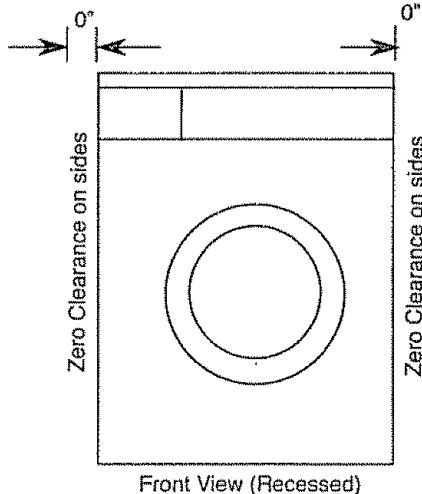

If the appliance is to be installed in a closet, the installation must be completed by a qualified person or service representative.

Additional clearances for floor, wall or door moldings may be required.

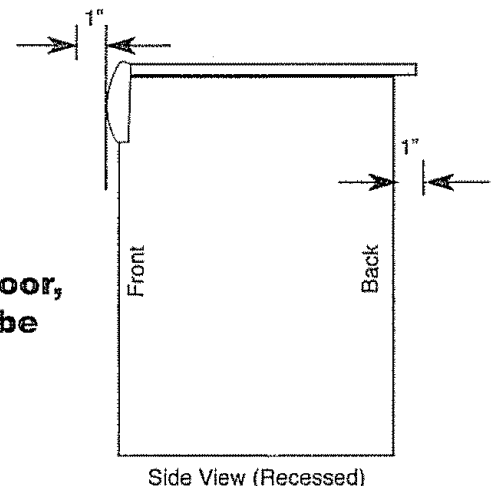

Installing/Removing Getting things ready to install your appliance (continued)

Plumbing - Water, Drains

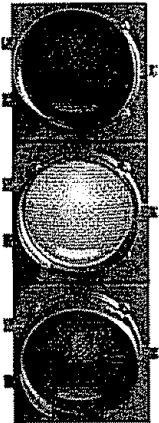

WATER CONNECTION

1. This appliance can be used with either hot/cold or cold/cold connections.
2. The hoses supplied have one straight end and one elbow end
The elbow end is meant to connect to the washer. Be sure to connect the hot hose to the hot side of the appliance itself, the cold side to the cold connection (See picture)
The straight end to the 3/4" BSP standard hose bib thread.
3. **MAKE SURE WASHERS ARE INSTALLED IN EACH END OF THE SUPPLY HOSES.**
4. An optional "F" connector is available where cold only is desired.
5. Ensure that water connections are free from debris or sediment
6. **BRASS PRESSURE REDUCERS MUST BE INSTALLED TO PROTECT COMPONENTS INSIDE THE APPLIANCE.**

Brass pressure reducers and elbow ends of supply hoses.

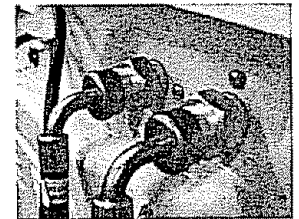

IMPORTANT ! CHECK THREADS ON THE MACHINE, THE BRASS PRESSURE REDUCERS AND THE SUPPLY HOSES TO ENSURE THEY ARE CLEAN. DO NOT USE EXCESSIVE FORCES. TIGHTEN BY HAND. DO NOT USE POWER TOOLS.

Connection of the drain hose to standpipe

- Outlet end of drain hose (See figure 2) must be at least 20" above bottom of washer. An air break must be provided at the standpipe to avoid siphoning.
- Connect the drain hose to a standpipe (with internal diameter of at least 3.2cm or 1 1/4" min. diameter) with a minimum carry away volume of 7 gallons. The top of the standpipe must be 20" minimum from the bottom of the appliance. Place drainhose for drainage into a sink tub or standpipe, ensuring that there are not kinks or bends. The free end must be at a height of 80cm from the floor, the hose must be fixed in the appropriate hook on the upper part of the back panel (fig. 4).

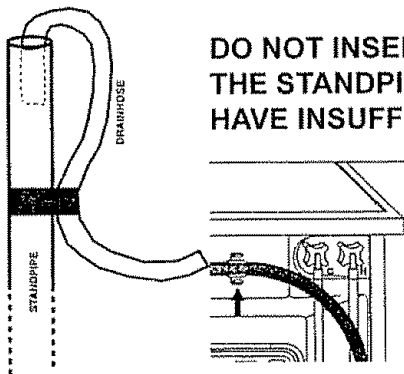

DO NOT INSERT THE END OF THE DRAIN HOSE MORE THAN 6" INTO THE STANDPIPE. INSERTING MORE MAY CAUSE THE APPLIANCE TO HAVE INSUFFICIENT DRAINAGE.

CORRECT LEVELING OF UNIT IS ESSENTIAL

It is important for the machine to be perfectly level. The angle of inclination on the work surface must not be more than 2 degrees. For this reason the machine is fitted with adjustable feet used for leveling the machine before use. In the case of carpeted flooring, remember to check that the ventilation in the support area is not plugged.

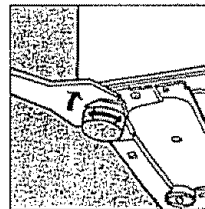

Washing

For best results washing

Preparation, sorting, inspecting, pre-wash treatments, helpful laundry hints, simple controls, detergent dispensers



Preparation

Before you begin washing, taking a few simple steps will help you have a better washing experience and save wear and tear on your clothing as well.

- 1) Read factory labels for washing instructions
- 2) Pre-treating heavily soiled areas will also improve washing results.
- 3) Obtain and use Majestic™ Low Suds Laundry Soap or any other commercial brand that keeps over sudsing in check.
- 4) Your Majestic™ has over 14 different wash cycles that can last as long as 90 minutes or as short as 35. Select the one that is right for the load.

Sorting

Separate laundry according to fabric type, color and how dirty things are. Also consider separating clothing that generate lint from clothes that do not typically generate much lint. Cottons, synthetics, and woolen fabrics for starters. Color fast products vs. those that might bleed and fade on to other clothing. **What size load? A good rule of thumb is that clothes should be visible in the window of the machine from 1/2 to 2/3's full.**

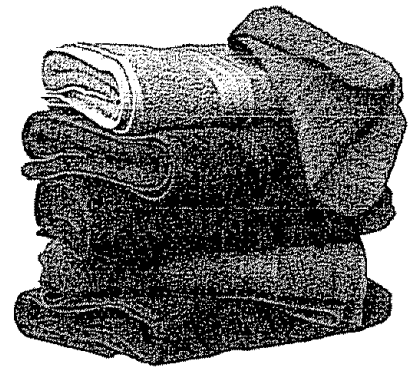

Inspecting

This goes without saying, but check pockets for loose change, and other hidden impediments. Fastening all zippers, hooks, and buttons will prevent damage to garments and to the machine. Turning knit garments inside out will also protect the garment. Using a mesh laundry pouch for delicate items such as tights and stockings, bras, shoulder pads and underwear can prevent tangling. Also, if a garment is torn or damaged, washing and drying will only make it worse. Take a minute and do a bit of mending. It will enhance fabric care in the long run.

Pre-Wash treatments

Your laundry appliance has a built in assistant to take care of your pre-wash feature. Besides individually treating garments as need arises, also consider using a longer wash cycle if necessary including the use of the pre-wash section of the detergent drawer. Often childrens play clothes and men's work clothes take a beating and can use some extra cycles to come clean.

Helpful laundry hints

Detergent - Because this is a front loading machine, your Majestic™ requires less of almost everything, from laundry detergent to fabric softener to bleach. LOW SUDS detergents are even more convenient in a front loader, because of the efficiency of clothes on clothes agitation. FABRIC SOFTENER can actually improve dry times, but NEVER USE SOFTENER SHEETS OR OVERUSE SOFTENER. It could cause damage to your machine. And using bleach can whiten clothes when nothing else will. Use the proper dilution of bleach for your needs. Too much bleach can damage fabrics.

Washing

For best results washing (continued)

Preparation, sorting, inspecting, pre-wash treatments, helpful laundry hints, simple controls, detergent dispenser

Controls, detergent dispenser

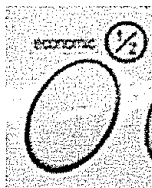
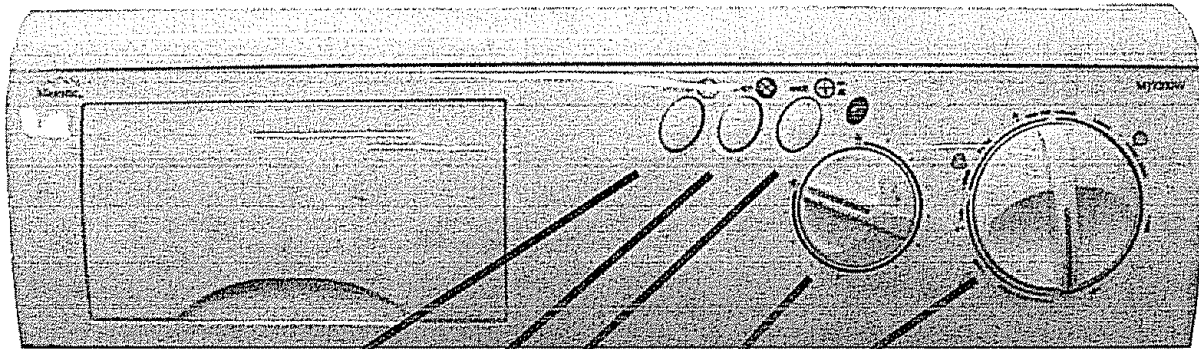

Economic Button
This is a very useful button that will save you a lot of money. It reduces water consumption when rinsing. If you have a

small load, use this button and reduce water usage

No Spin Button

This button allows you the option of excluding the spin phase of the wash cycle when washing delicate fabrics.



ON/OFF Button

This button supplies electrical power to the appliance.



Washer Timer

This control turns clockwise and allows you to select any of 14 wash cycles for any load. It is best to adjust this with the power off. Blue is for Cotton, Green for synthetics and red for wool.

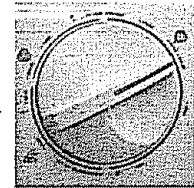

Vari-Spin Control

This control permits the selection of your own desired spin speeds. If you want high performance drying, set the spin speed to 1000+. The blue numbers relate to speeds when in a cottons cycle and the green numbers relates to spin speeds when in a synthetics cycle.

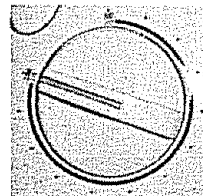

Detergent Drawer

The detergent dispenser is divided into 4 compartments marked 1, 2, A and C.

- 1 Pre-wash detergent
- 2 Wash detergent
- A Softeners, conditioners and perfumes
- C Bleach

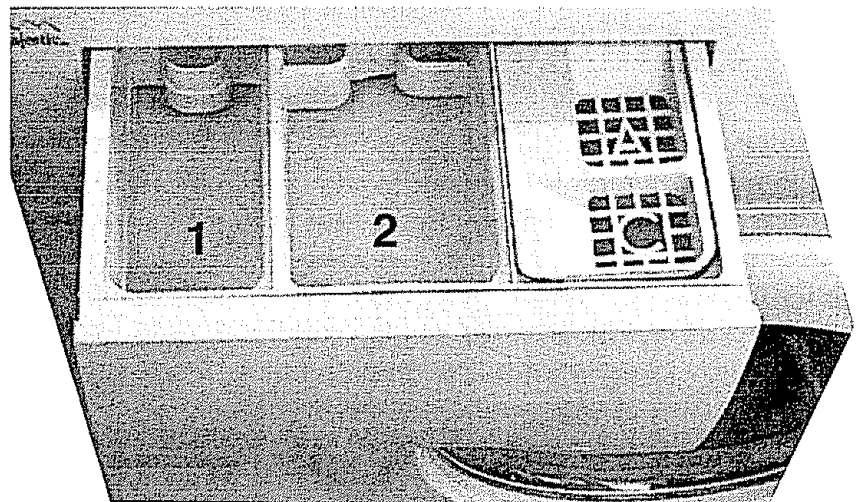

Guide for Selecting Programs

Type of Fabric and degree of dirtiness	Position of Wash Timer	Detergent for pre-wash	Detergent for Wash	Softener	Bleach	Description of wash cycle
Heavily soiled white laundry	1	Yes	Yes	Yes	Yes	Prewash, wash, rinses, extended spin
Heavily soiled white laundry and fast colors	1	Yes	Yes	Yes	Yes	Prewash, wash, rinses extended spin
White and color fast fabrics soiled	2	-	Yes	Yes	-	was, rinses, extended final spin
White and color fast fabrics	3	-	Yes	Yes	-	was, rinses, extended final spin
Mixed cotton + synthetics color fast fabrics	3	-	Yes	Yes	-	was, rinses, extended final spin
Delicate Colors	4	-	Yes	Yes	-	was, rinses, extended final spin
Rinses	5	-	-	Yes	Yes	Rinses, softener, extended final spin
Softeners	6	-	-	Yes	-	Rinses, softener, extended final spin
Spin cycle	7	-	-	-	-	Draining and extended final rinse
Drying cycle for natural fibers	7	-	-	-	-	
Heavily soiled synthetic fabrics /fast colors	8	-	Yes	Yes	-	Wash cycle anti - crease/deleccate spin
Normally soiled synthetic fabrics with fast colors	9	-	Yes	Yes	-	Wash cycle anti - crease/deleccate spin
Synthetic fabrics with delicate colors	10	-	Yes	Yes	-	Wash cycle anti - crease/deleccate spin
Rinses	11	-	-	Yes	-	Wash cycle anti - crease/deleccate spin
Softeners	12	-	-	Yes	-	Wash cycle anti - crease/deleccate spin
Spin Cycle	13	-	-	-	-	Draining , delicate spin
Drying cycle for natural fibers		-	-	-	-	
Woolens	14	-	Yes	Yes	-	Wash cycle/Anti-crease delicate spin
Rinses	15	-	-	Yes	-	Rinse, softener, anti-crease, delicate spin
Softeners	16	-	-	Yes	-	Rinse softener anti-crease, delicate spin
Spin Cycle	17	-	-	-	-	Delicate spin

Stains

Tips on Stain Removal

BALLPOINT INK

Hold stain against towel, spray closely from behind with aerosol hair spray. Ink should transfer to towel

BEVERAGES

Soak in cool water. Re-wash with stain remover. Launder using chlorine bleach (if safe for fabric) or oxygen bleach.

BLOOD

Immediately rinse with cool water. For dried stains, soak in warm water with a product containing enzymes. Launder.

CANDLE WAX

Scrape off as much as possible with dull side of knife, then iron between absorbent paper, changing paper until wax is absorbed.

CHOCOLATE

Pre-wash with product containing enzymes in warm water or treat with pre-wash stain remover. Launder.

COLLAR, CUFF SOIL

Pre-wash with stain remover, liquid laundry detergent or paste of granular detergent and water. Launder.

COSMETICS

Pre-wash with stain remover, liquid laundry detergent or paste of granular detergent and water or rub with bar of soap. Launder.

DAIRY PRODUCTS

Soak in a product containing enzymes for at least 30 minutes (hours for aged stains). Launder.

DEODORANTS & ANTI-PERSPIRANTS

Pre-treat with liquid laundry detergent. Launder. For heavy stains pre-treat with pre-wash stain remover. Allow to stand 5 to 10 minutes. Launder using an oxygen bleach.

EGG

Soak in product containing enzymes. Launder.

FRUIT JUICE

Rinse with cool water.

GRASS

Soak in product containing enzymes. If stains persist, launder using a chlorine bleach (if safe for fabric) or oxygen bleach.

GREASE SPOTS, OIL

Pre-treat with pre-wash stain remover or liquid laundry detergent. For heavy stains, place stain face down on clean paper towels. Apply cleaning agent to back of stain. Replace paper towels under stain frequently. Let dry, rinse and launder using hottest water safe for fabric.

INK

Use ink eradicator on undyed, untreated linen.

LEMON, LIME JUICE, VINEGAR

Rinse immediately with cool water.

LIPSTICK

On pure linen, rub with a little salad oil to dissolve lipstick, then launder to remove oil.

MEAT JUICE

Rinse with cool, never hot, water.

MILDEW

Badly mildewed fabrics may be beyond repair. Launder stained item using chlorine bleach, (if safe for fabric). Or soak in oxygen bleach and hot water. Then launder.

PERSPIRATION

Use pre-wash stain remover or rub with bar of soap. If color of fabric has changed, apply ammonia to fresh stains, white vinegar to old stains and rinse. Launder using hottest water safe for fabric.

RED WINE

Cover with salt if stain is fresh, then rinse with cool water. If stain has dried, try club soda.

SCORCH

Treat same as for mildew (listed above).

TAR

Scrape residue from fabric. Place stain face down on paper towels. Sponge with cleaning fluid. Replace towels frequently. Launder in hottest water safe for fabric.

TOMATO

Rinse with cool water.

WHITE WINE

Use club soda.

Troubleshooting tips

Read here, then call us

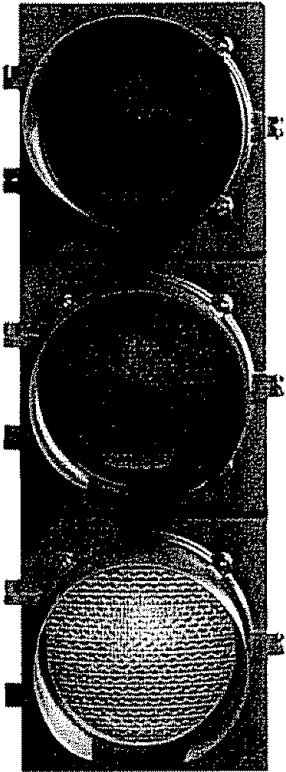

Even though your washer dryer has been carefully designed and constructed, something may still go amiss with your machine. Before rushing to technician, please check that the operations listed below have been carried out. In many cases you will save time, money and a bother. Our statistics show that many calls made to our service representatives could have been solved with a little more attentions to these basic operations.

The washer won't start

Check that:

- the plug is pushed into the main outlet
- the door is closed tight
- the ON/OFF button has been pressed

The washer won't fill with water

Check that:

- the tap is open and properly connected to the inlet pipe
- the inlet pipe is not bent
- the inlet pipe is placed at least 80cm/32in. above ground level

The washer drains continuously

Check that:

- the inlet is not blocked
- the inlet pipe is placed at least 80 cm/32 inches above ground level but not more than 1 metre/40 inches above ground level.
- the drain pump doesn't work, the filter net of the drain pump is blocked

There is too much foam in the tub

Check that:

- the detergent being used is meant for automatic machines and not for washing by hand
- the amount used is correct as stated in this manual and not more

The washer vibrates too much when spinning

Check that:

- the shipping bolts have been removed (see installation manual)
- the machine is level
- the washing load is according to the instructions given in this booklet

The washer fills up with water and won't drain.

Check that:

- The drain hose is only 6" into the stand pipe.
- The drain hose is not clogged

Owner Care Maintenance Tips

Water, exterior, interior, winterizing, detergent, pump, technical specifications

Water Hoses

Periodically check both ends of the water supply hoses to ensure that the washers have no cracks or deterioration and that the hoses themselves have no kinks, bulges or worn spots. Replacing inlet hoses from time to time can prevent hose failure and water damage.

Exterior

Keeping the exterior of the unit clean will preserve the value of your investment. Use a soft cloth and liquid cleanser to clean and maintain the exterior.

Interior

Do not use solvents to clean the machine or to do the wash.

Clean the detergent dispenser ever so often. This is very simple and should be done with water.

Detergent dispenser - Your machine has an extractable dispenser to make it even easier. From time to time, using water and a damp clothes remove excess detergent, softener and any build up of bleach that may have accumulated in the detergent drawer.

Winterizing

To winterize your appliance, follow these steps:

- 1) Turn the power off
- 2) Put 1/2 quart of R V -type potable antifreeze in the machine and close the door
- 3) Turn the program selector knob to Spin. Turn the power on and let the appliance spin for 1-2 minutes
- 4) Turn the power off and unplug the washer.
- 5) Shut off water at both faucets and disconnect water inlet hoses from faucets and drain. DONE!

To put the appliance back into service.

- 1) Make sure the RV Water supply is clear of antifreeze.
- 2) Hook up the power and water as before.
- 3) Run the water through the delicate cycle with 2/3 tablespoon of detergent to clean out appliance.

If you are putting antifreeze in the water lines of an RV or Boat, run the machine until you see pink water introduced into the drum. Then turn the power off and advance the timer to spin. Turn the power back on and spin for 30 seconds to get antifreeze into the entire system. Now turn the power off and continue steps 4 and 5 above.

Pump

Self Cleaning Pump - Your washer dryer is equipped with a self-cleaning pump. It is therefore not necessary to carry out cleaning and maintenance operations. Some objects such as buttons, coins, etc., may sometimes drop into the pump and must be removed. These items become trapped in a special "anti-chamber" which can be reached through the front part of the pump. Open the cover of the filter, loosen the knob in counter-clockwise rotation, then take out the filter and clean it with water. (See fig. 10) Carefully reassemble the filter after cleaning to ensure that it is tight and no water can enter the filter.

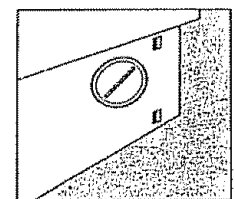

Technical Specifications

Model	MJ9200W
Rated Volts	110V/60Hz
Washing Input Power	330W
Spin Input Power	700W
Wash Capacity	5 kg (11 lbs)
Spin Capacity	5 kg (11 lbs)
Drying capacity	2.5 kg (5.5 lbs)
Spin Rotation Rate	1000-1200 RPM
Wash Programs	16
Water Pressure	.05-a (Mpa)
Outside dimensions H x W x D	33 1/4 x 23 3/8 x 22 inches
Weight	72 kg (159 lbs)

Getting Service



MAJESTIC™ has hundreds of service agents all over the country. Call us on our toll free hotline (1-800-678-8002) and we will serve your needs. Remember that if your service call is the result of component failure we will be happy to cover it under your warranty. If it is not, you will be charged for the time and travel. Our service center is available Monday through Friday from 8:00 am to 5:00 p.m.. You will find our technicians helpful, knowledgeable and friendly.

What if you need help on weekends? Majestic™ appliances has a web site with tons of helpful information, including “**Service knowledge on demand™**”. You can watch a movie that assists in trouble shooting your problem and making the repair. No other company offers such complete service.

Owner Care

Warranty Information

Your Majestic™ appliance is covered by this warranty under normal personal, family, household or RV use in the US and Canada

Warranty

Your Majestic™ Appliance is warranty for 1 full year from the original purchase on the mechanical parts only when installed in accordance with the instructions in the manual. It is the option of the factory to replace or repair any part which become defective in workmanship or material under normal personal, family or household use.

During this one year, Majestic™ Appliance will provide all labor and parts necessary to repair any defect as long as the appliance has been installed and operated in according with the instructions provided. In the case of a tight installation, including RV's or Marine pleasure craft, providing ready access to the appliance is the responsibility of the owner.

In no event, shall Majestic™ Appliances or its parent company, be liable for incidental or consequential damages or for damages resulting from external causes such as abuse, misuse, incorrect voltage or acts of God. This warranty does not cover service calls which do not involve defective workmanship, incorrect installation procedures or materials not provided by Majestic™ appliances. Therefore, service calls, diagnosis, and repair costs for a service call which does not involve defective workmanship or materials will be the responsibility of the consumer/owner. This might include but is not restricted to, improper hookup or leveling, cleaning or air and/or water filters, replacing broken door handles, or excessive movement caused by travel or recreation or installation.

Being fair, most work is covered. If the machine has malfunctioned Majestic™ covers it or if the installer/consumer has omitted or done something to cause the machine to malfunction, they cover it.

You can call us toll free at 1-800-678-8002, 8 am to 5 pm Pacific Time for service. Or you can call any time and leave a message.

Our address is
MSI/Majestic Appliances
2500 Columbia House Blvd.
Vancouver, WA 98661

Extended Warranty Information

Contact us at our office for up-to-date information on extended warranty costs. You can obtain an additional warranty for 1, 3 or 5 years through our exclusive warranty agreement. To be eligible for this warranty you must use the machine for personal use, not in a commercial application, purchase the coverage, register the contract and received your contract number or certificate. The unit must be registered with our approved agency and have a contract number issued within the first year of ownership, to the original owner, or this offer is void.

Owner Care

Accessories

You have a broad selection of installation and owner accessories available. Just ask your local dealer or give us a call.

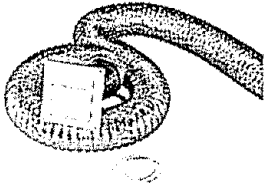

PN 17-1051 Dryer Vent Kit includes:
Louvered Vent Hood
Pipe and Collar
UL Listed Transition Duct
(2) Clamps



PN 17-1054 Deluxe Chrome Outside Vent
Die Cast ZAMAK with chrome finish
Black polypropylene flange
4" hose adapter
Predrilled for #8 screws
Dimensions-- 5.25" tall x 5.8" wide x 2.25" deep
UV Inhibitor added



PN 17-1055 Deluxe Flush Mount Outside Vent
Paintable/Chromable ABS
Melting Point 325 degrees approx.
UV Inhibitor added

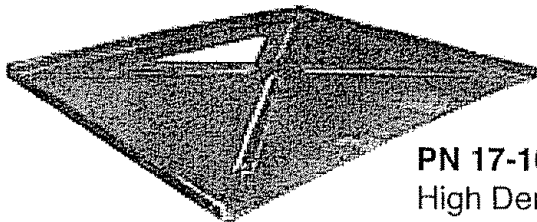

PN 17-1056 Drip Pan
High Density ABS

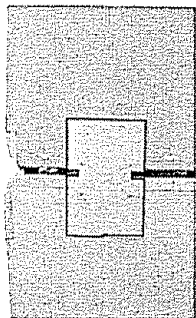

PN 17-1050 Stackable Attaching Kit
Parts for stacking the Washer and Dryer Separates



PN 17-1052 Econo Outside Vent
Calcium Filled Polypropylene
Melting Point 325 degrees approx.
UV Inhibitor added
Opens with ease for maximum exhaust flow
Curved Louvers for quieter operation
Durable Weather Resistant
Dimensions --- 6" wide x 6" tall x 5/8" flange depth
Free Air--4" diameter = 19.5 square inches

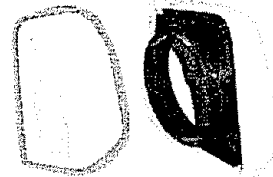

PN 17-1053 White Deluxe Outside Vent
Paintable ABS
Melting Point 325 degrees approx.
UV Inhibitor added
Easy Installation
Rubber Flap quiet when traveling
Durable Weather Resistant
Dimensions --- 5.25" wide x 6" tall x 2.25" deep
Free Air--4" diameter = 19.5 square inches



- Notes -



©2003 Manufacturers Supply, Inc

- Notes -



- Notes -



©2003 Manufacturers Supply, Inc