



Is it live or is it Memorex?TM

MLT1522

User's Guide

15" LCD Stereo
Monitor with Integrated TV Tuner

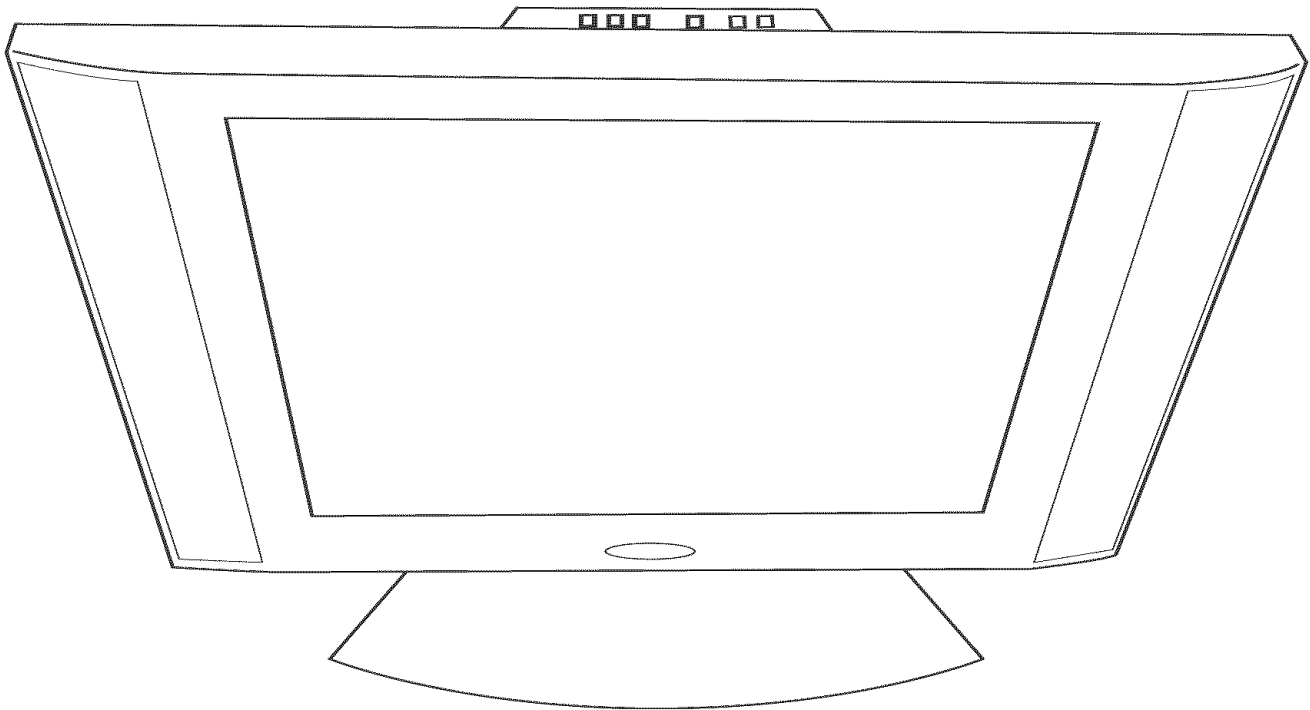

* High Definition (HDTV) monitors require an optional set-top box to receive true digital high definition broadcasts.

Before operating this product,

CONTENTS

Contents	1
Important Safety Instructions	2
Power Source	5
Location of Controls	5
• Front	5
• Rear Panel	6
• Remote	6
Remote Control	7
• Battery Installation	7
• Effective Distance of the Remote Control Transmitter	7
Cable (CATV)/Satellite Connections	8
Outdoor Antenna Connections	9
VCR Connections	10
DVD Connections	11
Computer Connection	13
Viewing Angle Adjustment	13
Setting the Menu	14
• Turning the Main Power On	14
• Setting the Video	14
• Image Setup	15
• Audio Setup	16
• PC Setup	17
Setting the System and Setting the Channels into Memory	19
Adding and Skipping Channels	20
TV Operation	21
• Mute	22
• Jump	22
• TV/Video	22
• Sleep Timer	22
• Info	23
• Earphone	23
Closed Captions	24
Setting V-Chip	25
• V-Chip Set-up	25
• MPAA Rating Set-up	26
• TV Rating (Class Option) Set-up	27
• Changing the Password	28
Troubleshooting Guide	29
Reception Disturbances	30
Specifications	31
Care and Maintenance	32

IMPORTANT SAFETY INSTRUCTIONS

FCC NOTICE:

This equipment has been tested and found to comply with the limits for a Class B digital device, pursuant to part 15 of the FCC Rules. These limits are designed to provide reasonable protection against harmful interference in a residential installation. This equipment generates, uses and can radiate radio frequency energy and, if not installed and used in accordance with the instructions, may cause harmful interference to radio communications.

However, there is no guarantee that interference will not occur in a particular installation. If this equipment does cause harmful interference to radio or television reception, which can be determined by turning the equipment off and on, the user is encouraged to try to correct the interference by one or more of the following measures:

- Reorient or relocate the receiving antenna.
- Increase the separation between the equipment and receiver.
- Connect the equipment into an outlet on a circuit different from that to which the receiver is connected.
- Consult the dealer or an experienced radio/TV technician for help.

WARNING:

TO REDUCE THE RISK OF FIRE OR ELECTRIC SHOCK, DO NOT EXPOSE THIS PRODUCT TO RAIN OR MOISTURE.

WARNING:

TO REDUCE THE RISK OF FIRE OR ELECTRIC SHOCK, AND ANNOYING INTERFERENCE, USE THE RECOMMENDED ACCESSORIES ONLY.

SURGE PROTECTORS:

It is recommended to use a surge protector for AC connection. Lightning and power surges ARE NOT covered under warranty for this product.

ATTENTION:

POUR ÉVITER LES CHOC ÉLECTRIQUES, INTRODUIRE LA LAME LA PLUS LARGE DE LA FICHE DANS LA BORNE CORRESPONDANTE DE LA PRISES ET POUSSER JUSQU'AU FOND.

FCC WARNING:

To assure continued compliance, follow the attached installation instructions and use only shielded cables when connecting to other devices. Modifications not authorized by the manufacturer may void user's authority to operate this device.

IMPORTANT SAFETY INSTRUCTIONS (CONTINUED)

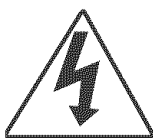

CAUTION

**RISK OF ELECTRIC SHOCK
DO NOT OPEN**

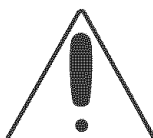

CAUTION: TO REDUCE THE RISK OF ELECTRIC SHOCK, DO NOT REMOVE COVER (OR BACK). NO USER-SERVICEABLE PARTS INSIDE. REFER SERVICING TO QUALIFIED SERVICE PERSONNEL.
(This Caution Marking is located at the rear enclosure of the unit.)



The lightning flash with arrowhead symbol within an equilateral triangle is intended to alert the user to the presence of uninsulated dangerous voltage within the product's enclosure that may be of sufficient magnitude to constitute a risk of electric shock to persons.



The exclamation point within an equilateral triangle is intended to alert the user to the presence of important operating and maintenance (servicing) instructions in the literature accompanying the appliance.

WARNING: TO REDUCE THE RISK OF FIRE OR ELECTRIC SHOCK, DO NOT EXPOSE THIS APPLIANCE TO RAIN OR MOISTURE. TO PREVENT ELECTRIC SHOCK, MATCH THE WIDE BLADE OF THE PLUG TO THE WIDE SLOT AND FULLY INSERT.

Before using the unit, be sure to read all operating instructions carefully. Please note that these are general precautions and may not pertain to your unit. For example, this unit may not have the capability to be connected to an outdoor antenna.

1. READ INSTRUCTIONS

All the safety and operating instructions should be read before the product is operated.

2. RETAIN INSTRUCTIONS

The safety and operating instructions should be retained for future reference.

3. HEED WARNINGS

All warnings on the product and in the operating instructions should be adhered to.

4. FOLLOW INSTRUCTIONS

All operating and use instructions should be followed.

5. CLEANING

Unplug this product from the wall outlet before cleaning. Do not use liquid cleaners or aerosol cleaners. Use a dry cloth for cleaning.

6. ATTACHMENTS

Do not use attachments not recommended by the product's manufacturer as they may cause hazards.

7. WATER AND MOISTURE

Do not use this product near water—for example: near a bathtub, washbowl, kitchen sink or laundry tub; in a wet basement; or near a swimming pool.

8. ACCESSORIES

Do not place this product on an unstable cart, stand, tripod, bracket or table. The product may fall, causing serious injury and serious damage to the product. Use only with a cart, stand, tripod, bracket or table recommended by the manufacturer or sold with the product. Any mounting of the product should follow the manufacturer's instructions, and should use a mounting accessory recommended by the manufacturer.

8A. An appliance and cart combination should be moved with care. Quick stops, excessive force and uneven surfaces may cause the appliance and cart combination to overturn.

9. VENTILATION

Slots and openings in the cabinet and in the back or bottom are provided for ventilation, to ensure reliable operation of the product and to protect it from overheating. These openings must not be blocked or covered. The openings should never be blocked by placing the product on a bed, sofa, rug or other similar surface. This product should never be placed near or over a radiator or heat source. This product should not be placed in a built-in installation such as a bookcase or rack unless proper ventilation is provided or the manufacturer's instructions have been adhered to.

10. POWER SOURCES

This product should be operated only from the type of power source indicated on the marking label. If you are not sure of the type of power supply to your home, consult your appliance dealer or local power company. For products intended to operate from battery power, or other sources, refer to the operating instructions.

11. GROUNDING OR POLARIZATION

This product is equipped with a polarized alternating-current line plug (a plug having one blade wider than the other). This plug will fit into the power outlet only one way. This is a safety feature. If you are unable to insert the plug fully into the outlet, try reversing the plug. If the plug should still fail to fit, contact your electrician to replace your obsolete outlet. Do not defeat the safety purpose of the polarized plug.

12. POWER-CORD PROTECTION

Power-supply cords should be routed so that they are not likely to be walked on or pinched by items placed upon or against them, paying particular attention to cords at plugs, convenience receptacles, and the point where they exit from the appliance.

PORTABLE CART WARNING
(symbol provided by RETAC)



S3126A

IMPORTANT SAFETY INSTRUCTIONS (CONTINUED)

13. LIGHTNING

To protect your product from a lightning storm, or when it is left unattended and unused for long periods of time, unplug it from the wall outlet and disconnect the antenna or cable system. This will prevent damage to the product due to lightning and power-line surges.

14. POWER LINES

An outside antenna system should not be located in the vicinity of overhead power lines or other electric light or power circuits, or where it can fall into such power lines or circuits. When installing an outside antenna system, extreme care should be taken to keep from touching such power lines or circuits as contact with them might be fatal.

15. OVERLOADING

Do not overload wall outlets and extension cords as this can result in a risk of fire or electric shock.

16. OBJECT AND LIQUID ENTRY

Never push objects of any kind into this product through openings as they may touch dangerous voltage points or short out parts that could result in fire or electric shock. Never spill or spray any type of liquid on the product.

17. OUTDOOR ANTENNA GROUNDING

If an outside antenna is connected to the product, be sure the antenna system is grounded so as to provide some protection against voltage surges and built-up static charges. Section 810 of the National Electric Code, ANSI/NFPA 70, provides information with respect to proper grounding of the mast and supporting structure, grounding of the lead-in wire to an antenna discharge product, size of grounding conductors, location of antenna discharge product, connection to grounding electrodes and requirements for grounding electrodes.

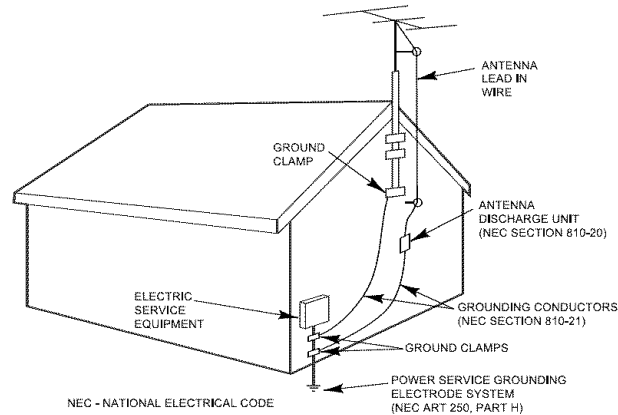

EXAMPLE OF ANTENNA GROUNDING AS PER NATIONAL ELECTRICAL CODE

18. SERVICING

Do not attempt to service this product yourself as opening or removing covers may expose you to dangerous voltage or other hazards. Refer all servicing to qualified service personnel.

19. REPLACEMENT PARTS

When replacement parts are required, be sure the service technician uses replacement parts specified by the manufacturer or those that have the same characteristics as the original part. Unauthorized substitutions may result in fire, electric shock or other hazards.

20. SAFETY CHECK

Upon completion of any service or repairs to this product, ask the service technician to perform safety checks to determine that the product is in proper operating condition.

21. WALL OR CEILING MOUNTING

The product should be mounted to a wall or ceiling only as recommended by the manufacturer.

22. DAMAGE REQUIRING SERVICE

Unplug the product from the wall outlet and refer servicing to qualified service personnel under the following conditions:

- When the power-supply cord or plug is damaged.
- If liquid has been spilled or objects have fallen into the product.
- If the product has been exposed to rain or water.
- If the product does not operate normally by following the operating instructions. Adjust only those controls that are covered by the operating instructions, as an adjustment of other controls may result in damage and will often require extensive work by a qualified technician to restore the product to its normal operation.
- If the product has been dropped or the cabinet has been damaged.
- When the product exhibits a distinct change in performance—this indicates a need for service.

23. HEAT

The product should be situated away from heat sources such as radiators, heat registers, stoves or other products (including amplifiers) that produce heat.

24. NOTE TO CATV SYSTEM INSTALLER

This reminder is provided to call the CATV system installer's attention to Article 820-40 of the NEC that provides guidelines for proper grounding and, in particular, specifies that the cable ground shall be connected to the grounding system of the building, as close to the point of cable entry as practical.

POWER SOURCE

To operate the unit using AC power, connect the AC adapter (included) to the 12V IN jack DC 12V IN jack (⊖⊕) on the rear of the unit. Connect the AC cord to the adapter and connect the other end to a wall outlet having 120V AC, 60Hz only.

NOTE: The AC adapter is located at the rear of the base stand.

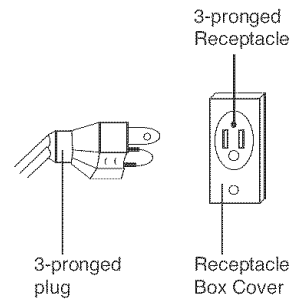

LOCATION OF CONTROLS

FRONT

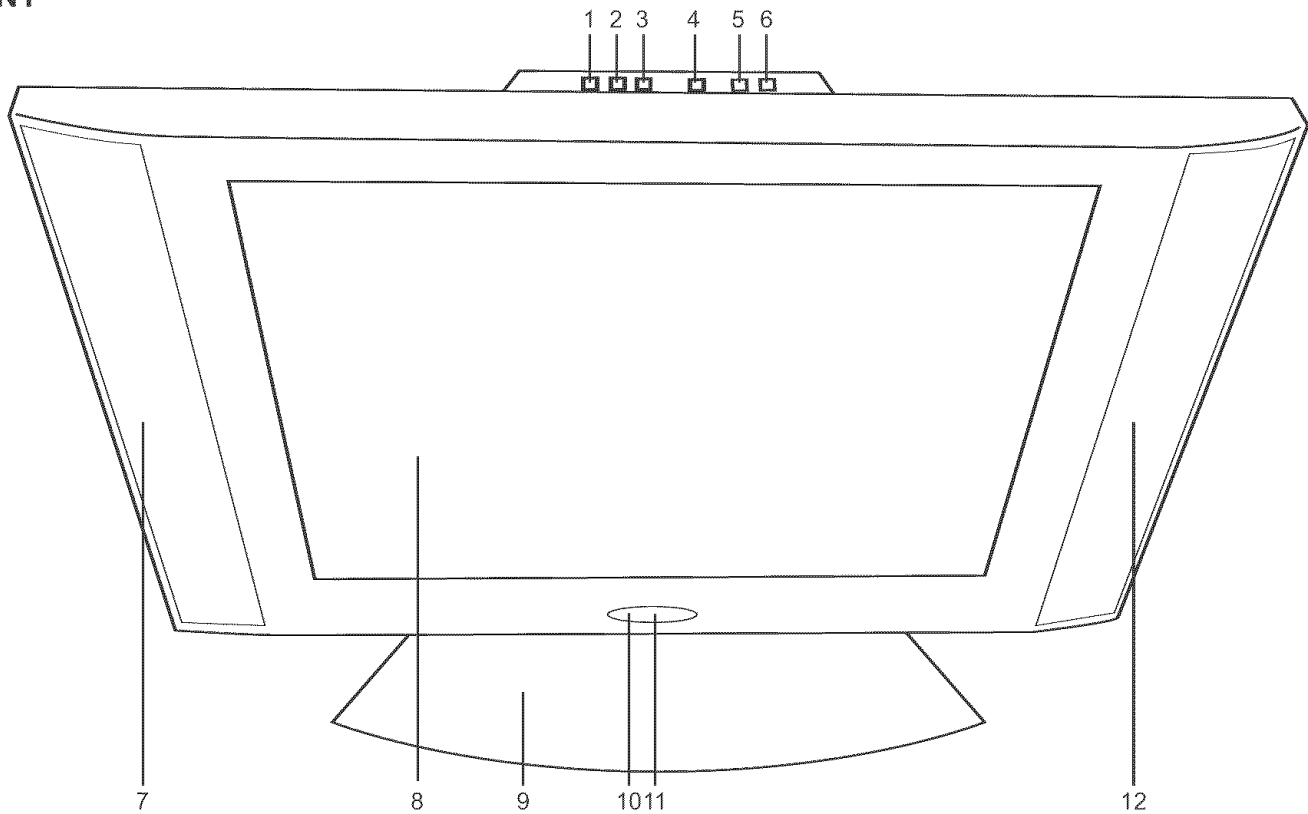

- 1. VOLUME Down/Navigation Left Button**—Press to lower the volume or navigate left in the setting menu.
- 2. MENU/ENTER Button**—Press to access the on-screen menu or press to enter the setting.
- 3. VOLUME UP/Navigation Right Button**—Press to raise the volume or navigate right in the setting menu.
- 4. POWER Button**—Press to turn the TV on; the POWER indicator will light orange. Press again to turn the TV off; the POWER indicator will light red.
- 5. CHANNEL/NAVIGATION Down Button**—Press to select a lower-numbered channel or navigate down in the setting menu.
- 6. CHANNEL/NAVIGATION Up Button**—Press to select a higher-numbered channel or navigate up in the setting menu.
- 7. Left Speaker**
- 8. Screen**
- 9. Base Stand (AC jack at rear of base)**
- 10. REMOTE SENSOR**
- 11. POWER Indicator**—Lights orange when the unit is on, and lights red when the unit is off.
- 12. Right Speaker**

LOCATION OF CONTROLS (CONTINUED)

REAR PANEL

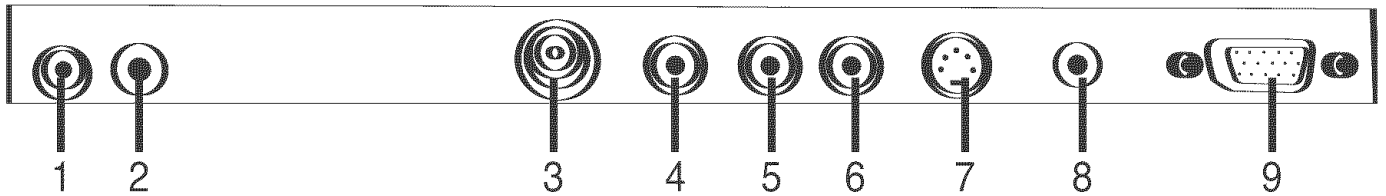

1. DC 12V IN Jack ($\ominus\oplus\oplus$)
2. Earphone Jack
3. UHF/VHF Antenna IN Jack
4. VIDEO IN Jack
5. AUDIO Right IN Jack
6. AUDIO Left IN Jack
7. S-VIDEO IN Jack
8. VGA (PC) AUDIO IN Jack
9. VGA (PC) IN Jack

REMOTE

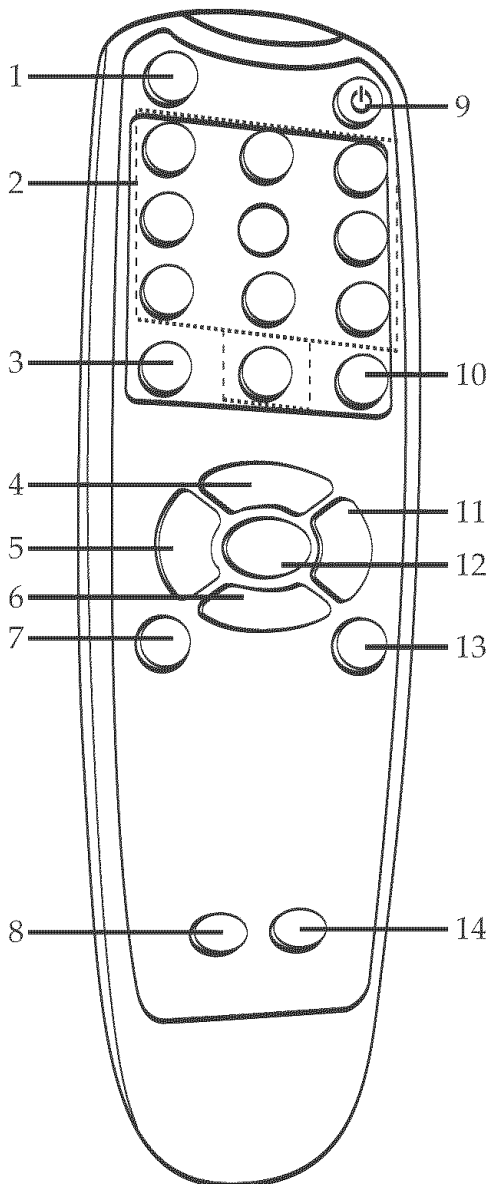

1. MUTE Button
2. Direct Channel Selection/Number (0-9) Buttons
3. 1-- Button
4. CHANNEL/Navigation Up Button
5. VOLUME Down/Navigation Left Button
6. CHANNEL/Navigation Down Button
7. MENU Button
8. INFO Button
9. POWER Button
10. JUMP Button
11. VOLUME UP/Navigation Right Button
12. ENTER Button
13. TV/VIDEO Button
14. SLEEP Button

REMOTE CONTROL

BATTERY INSTALLATION

1

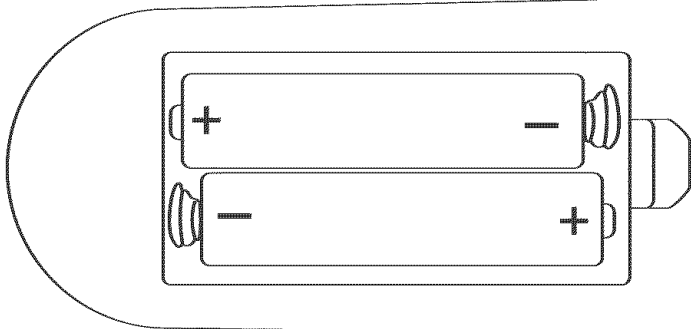

To remove the battery compartment cover, press in on the tab and then lifting it up.

Install two "AAA" batteries (not included), paying attention to the polarity diagram in the battery compartment.

Replace the battery compartment cover.

BATTERY PRECAUTIONS

Follow these precautions when using batteries in this device:

1. Use only the size and type of batteries specified.
2. Be sure to follow the correct polarity when installing the batteries as indicated in the battery compartment. Reversed batteries may cause damage to the device.
3. Do not mix different types of batteries together (e.g. Alkaline, Rechargeable and Carbon-zinc) or old batteries with fresh ones.
4. If the device is not to be used for a long period of time, remove the batteries to prevent damage or injury from possible battery leakage.
5. Do not try to recharge batteries not intended to be recharged; they can overheat and rupture. (Follow battery manufacturer's directions.)

EFFECTIVE DISTANCE OF THE REMOTE CONTROL TRANSMITTER

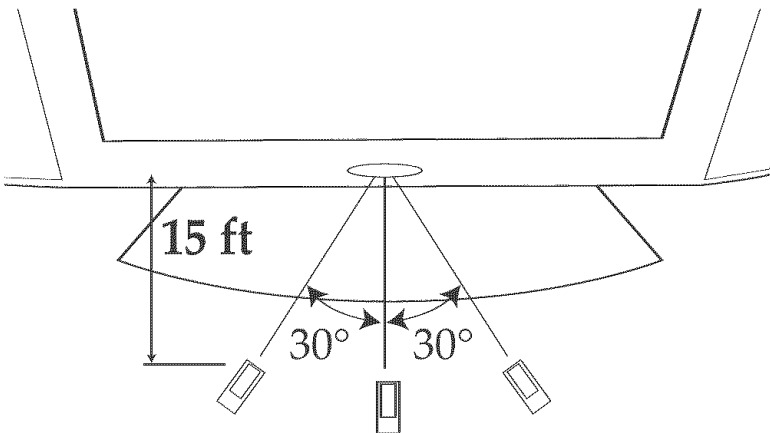

NOTES:

- When there is an obstacle between the TV and the transmitter, the transmitter may not operate.
- When direct sunlight, incandescent lamp, fluorescent lamp or any other strong light shines on the REMOTE SENSOR of the TV, the remote operation may be unstable.

FAQs:

Why is the remote control not working properly?

- The remote control is not aimed at the sensor.
- The remote control is too far away from the remote sensor.
- There is too much light in the room.
- There is an obstacle in the path of the beam.
- The batteries are weak or dead.
- The batteries are inserted incorrectly.
- The TV is not plugged in.
- The TV/Video button is not set to the desired function, see page 22.

CABLE (CATV)/SATELLITE CONNECTIONS

This TV has an extended tuning range and can tune most cable channels without using a Cable TV converter box. Some Cable TV companies offer "premium pay channels" in which the signal is scrambled. Descrambling these signals for normal viewing requires the use of a descrambler device which is generally provided by the cable company.

FOR SUBSCRIBERS TO BASIC CABLE TV SERVICE

For basic cable tv service not requiring a converter/descrambler box, connect the CATV 75 ohm coaxial cable to the VHF/UHF jack on the rear of the TV.

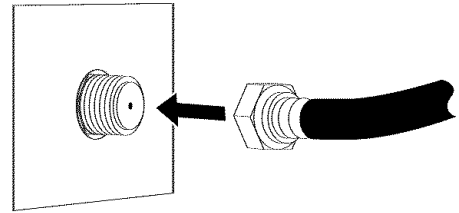

FOR SUBSCRIBERS TO SCRAMBLED CABLE TV SERVICE OR SATELLITE

If you subscribe to a satellite service or a cable TV service which requires the use of a converter/descrambler box, connect the incoming 75 ohm coaxial cable to the converter/descrambler or satellite box. Using another 75 ohm cable, connect the output of the converter/descrambler or satellite box to the antenna jack on the TV. Follow the connections shown below. Set the TV/VCR to the output channel of the converter/descrambler or satellite box (usually 3 or 4) and use the converter/descrambler or satellite box to select channels.

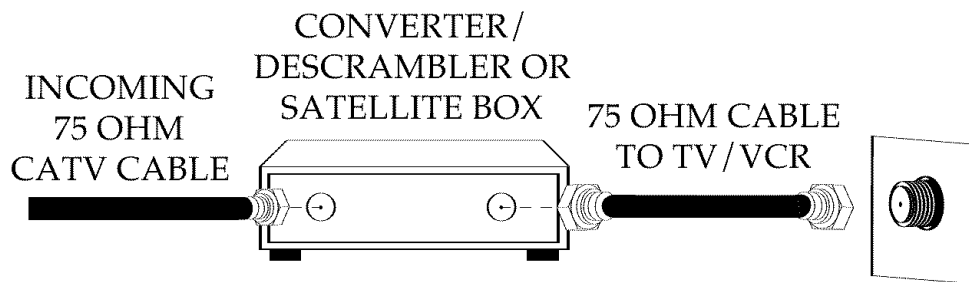

FOR SUBSCRIBERS TO UNSCRAMBLED BASIC CABLE TV SERVICE WITH SCRAMBLED PREMIUM CHANNELS

If you subscribe to a satellite service or a cable TV service in which basic channels are unscrambled and premium channels require the use of a converter/descrambler box, you may wish to use a signal splitter and an A/B switch box (available from the cable company or an electronic supply store). Follow the connections shown below. With the switch in the "B" position, you can directly tune any unscrambled channels on your TV. With the switch in the "A" position, tune your TV to the output of the converter/descrambler box (usually channel 3 or 4) and use the converter/descrambler box to tune scrambled channels.

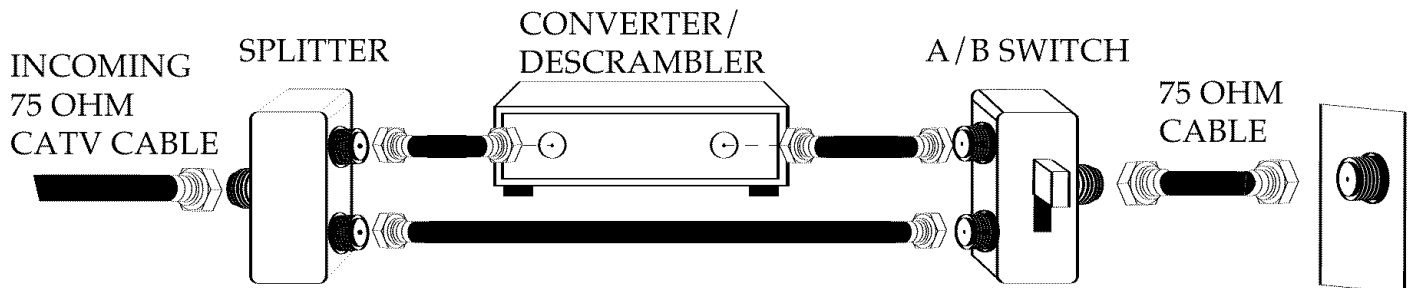

FAQS:

I connected my cable, why can't I get channels above 69?

Make sure AIR/CABLE is set to CABLE, see page 19. Also, make sure your cable company broadcasts channels in the range you are searching.

Are the cables included?

No, the cables are sold separately; visit your local electronics store.

OUTDOOR ANTENNA CONNECTIONS

OUTDOOR VHF/UHF ANTENNA CONNECTION (ANTENNA NOT SUPPLIED)

Follow the instructions for the type of antenna system you intend to use.

Combination VHF/UHF Antenna (Single 75 ohm cable or 300 ohm twin-lead wire)

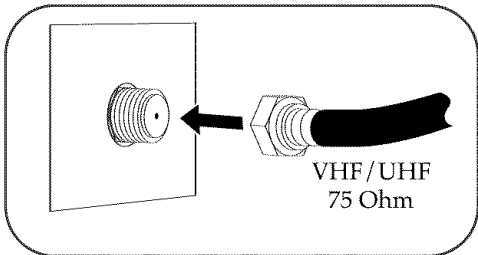

Connect the 75 ohm cable from the combination VHF/UHF antenna to the antenna jack.

OR

If your combination antenna has a 300 ohm twin-lead wire, use a 300-75 ohm matching transformer (NOT SUPPLIED).

Combination VHF/UHF Antenna (Separate VHF and UHF 300 ohm twin-leads)

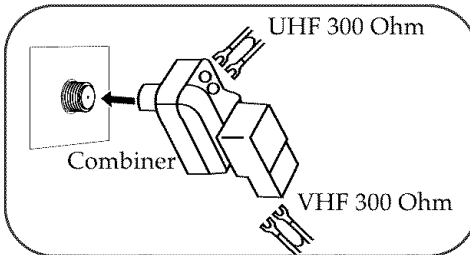

Connect the UHF twin-lead wire to a combiner (NOT SUPPLIED). Connect the VHF twin-lead to a 300-75 ohm matching transformer (NOT SUPPLIED). Attach the transformer to the combiner. Attach the combiner to the antenna jack.

Separate VHF/UHF Antennas

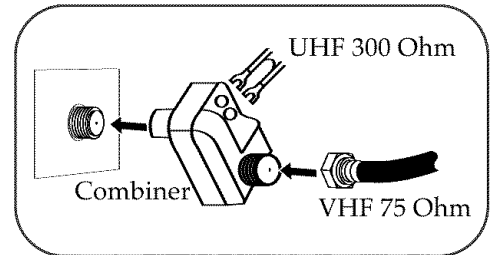

Connect the 75 ohm cable from the VHF antenna and the UHF antenna twin-lead wire to a combiner (NOT SUPPLIED). Attach the combiner to the antenna jack.

NOTE: If your VHF antenna has a twin-lead wire use a 300-75 ohm matching transformer, then connect the transformer to the combiner.

VCR CONNECTIONS

CONNECTION USING COAXIAL CABLE:

Follow the instructions below to connect a VCR to your television using a 75 ohm coaxial cable. (CABLES NOT INCLUDED.)

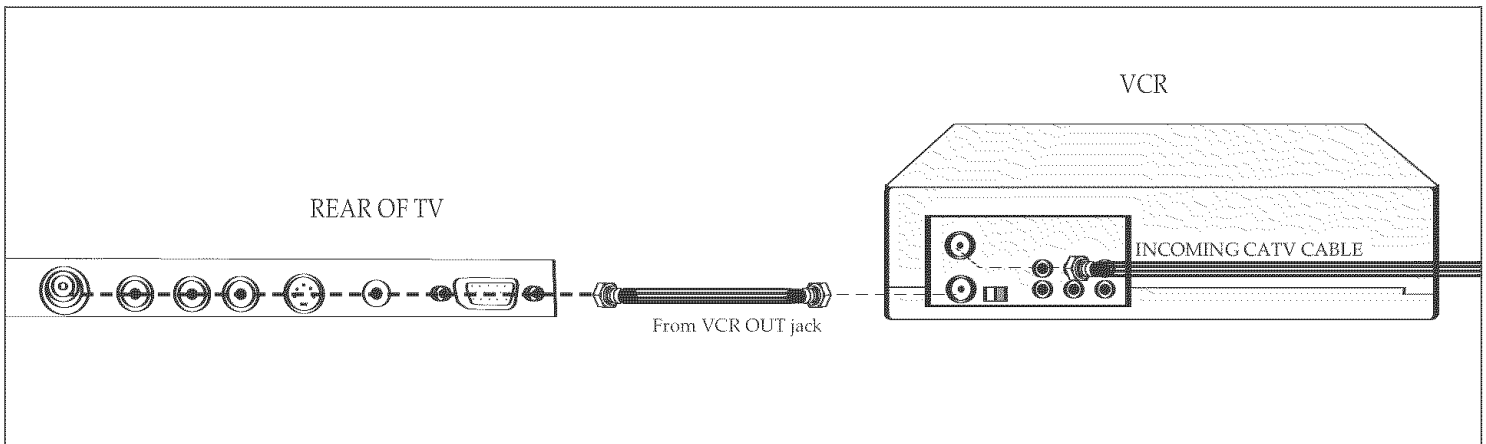

1. Connect the cable, satellite or incoming antenna to the VHF/UHF IN jack on the rear of the VCR.
2. Connect a 75 ohm coaxial cable from the VCR's 75 Ohm OUT jack to the ANT jack on the rear of the TV.
3. Press the TV/VIDEO button until a channel appears on the TV screen and press PLAY on the VCR to watch a tape.

CONNECTION USING AUDIO/VIDEO CABLES:

Follow the instructions below to connect a VCR to your television using Audio/Video cables. (CABLES NOT INCLUDED.)

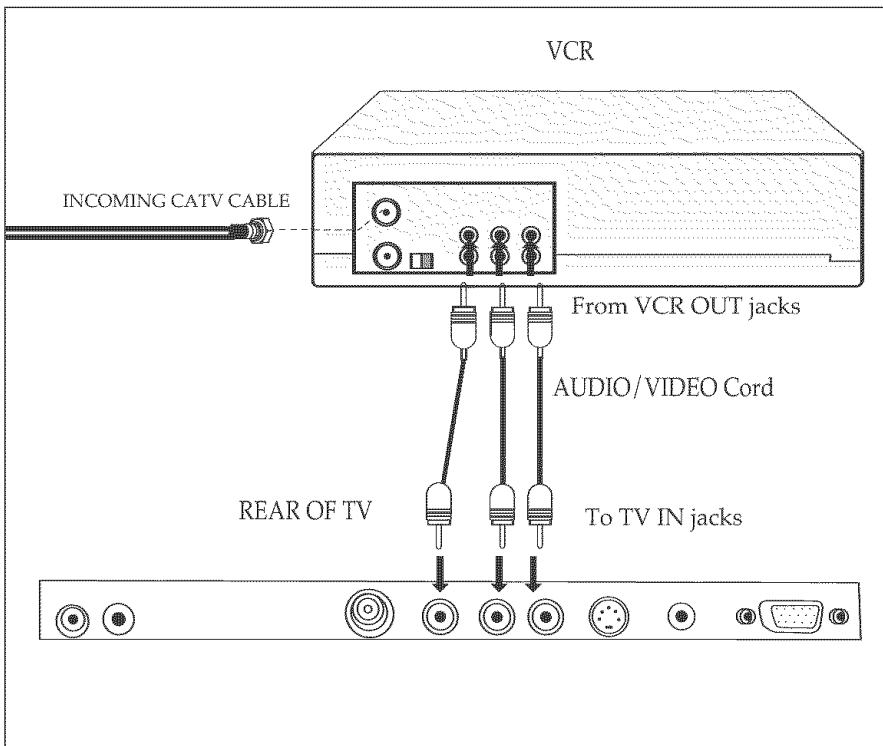

1. Connect the cable, satellite or incoming antenna to the VHF/UHF IN jack on the rear of the VCR.
2. Connect the left and right audio cable from the VCR's Audio OUT jacks to the TV's audio left and right AUDIO IN jacks. Connect the VCR's video OUT jack to the TV's VIDEO IN jack.
3. Press the TV/VIDEO button until AV appears on the TV screen and press PLAY on the VCR to watch a tape.

FAQ:

My VCR has only 1 Audio jack, but this TV has two Audio input jacks, how do I connect it?
Simply connect it to the "L (Mono)" Audio input jack, but the sound will be monaural.

VCR CONNECTIONS (CONTINUED)

CONNECTION USING S-VIDEO CABLE:

Follow the instructions below to connect an S-VIDEO VCR to your television using an S-video cable. (CABLES NOT INCLUDED.)

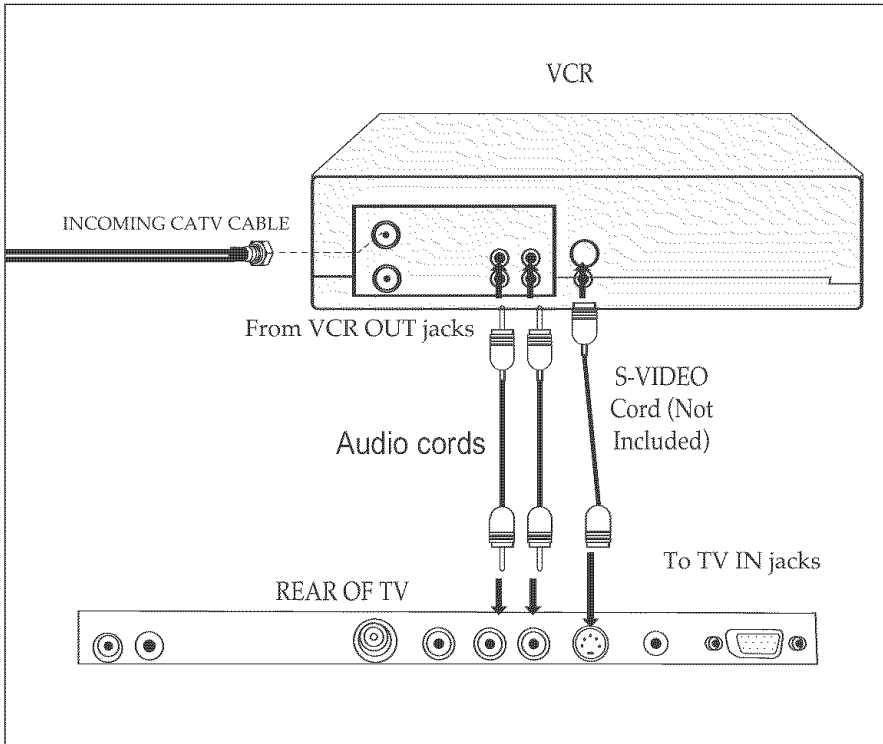

1. Connect the cable, satellite or incoming antenna to the ANT jack on the rear of the VCR.
2. Connect the left and right audio cable from the VCR's Audio OUT jacks to the TV's audio left and right IN jacks.
3. Connect the VCR's S-VIDEO OUT jack to the TV's S-VIDEO IN jack.
4. Press the TV/VIDEO button until S-Video appears on the TV screen and press PLAY on the VCR to watch a tape.

DVD CONNECTIONS

CONNECTION USING AUDIO/VIDEO CABLES:

Follow the instructions below to connect a DVD player to your television using Audio/Video cables. (CABLES NOT INCLUDED.)

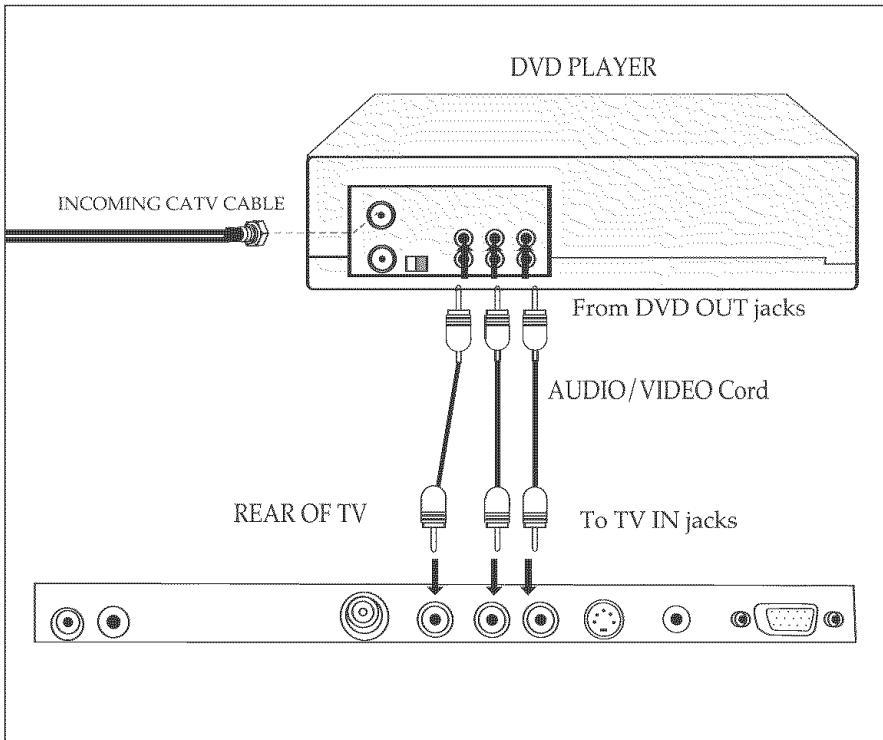

1. Connect the left and right audio cable from the DVD's Audio OUT jacks to the TV's audio left and right AUDIO IN jacks. Connect the DVD's video OUT jack to the TV's VIDEO IN jack.
2. Press the TV/VIDEO button until AV appears on the TV screen and press PLAY on the DVD to watch a DVD.

DVD CONNECTIONS (CONTINUED)

CONNECTION USING S-VIDEO CABLE:

Follow the instructions below to connect a DVD player to your television using the S-Video cable. (CABLES NOT INCLUDED.)

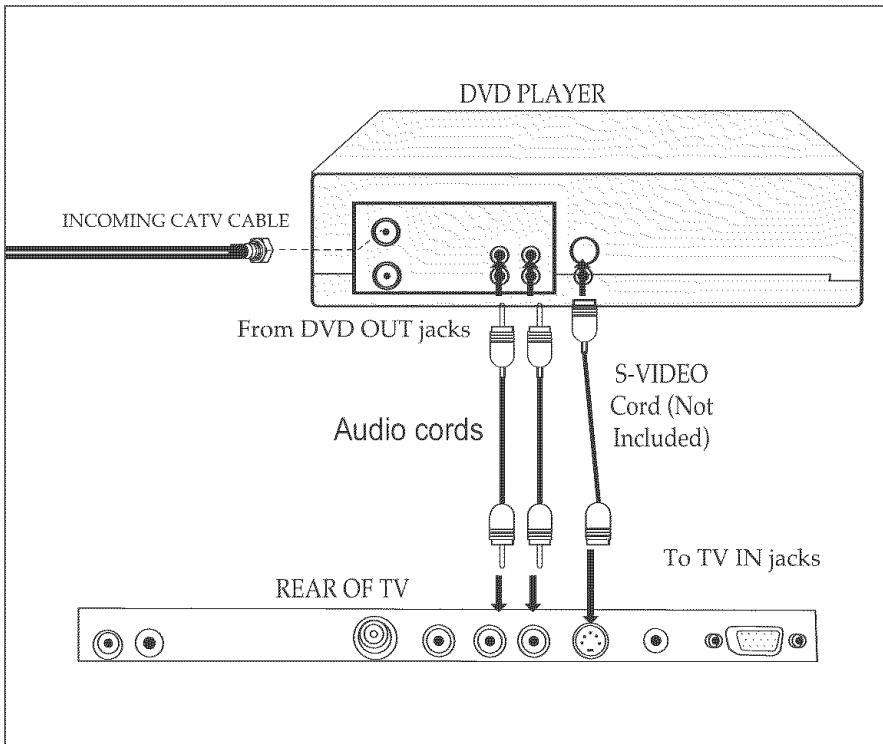

1. Connect the left and right audio cable from the DVD's Audio OUT jacks to the TV's audio left and right AUDIO IN jacks.
2. Connect the DVD's S-VIDEO OUT jack to the TV's S-VIDEO IN jack.
3. Press the TV/VIDEO button until S-Video appears on the TV screen and press PLAY on the DVD to watch the DVD.

CONNECTION USING "VGA TO COMPONENT" CABLE:

Follow the instructions below to connect a DVD player to your television using "VGA to COMPONENT" Cable (CABLES NOT INCLUDED.)

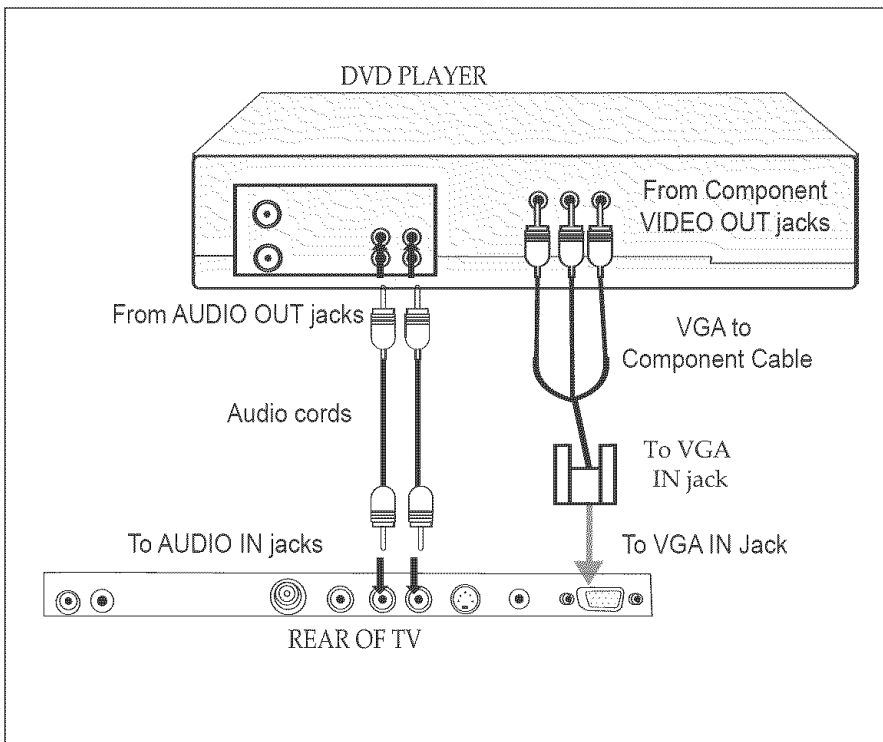

1. Connect the left and right audio cable from the DVD's Audio OUT jacks to the TV's audio left and right AUDIO IN jacks.
2. Connect the "VGA to Component" cable (not included) from the DVD's Y,Cr,Cb OUT jacks to the TV's VGA IN jack as shown.
3. Press the TV/VIDEO button until CVI appears on the TV screen and press PLAY on the DVD player to watch a DVD.

NOTE: Connecting the DVD player to the TV using the "VGA to Component" cable will provide the highest quality picture. Connecting using an S-Video cable will provide the next highest quality picture, followed by standard Audio/Video cable connection.

COMPUTER CONNECTION

Follow the instructions below to connect a computer to your television/monitor. (CABLES NOT INCLUDED.)

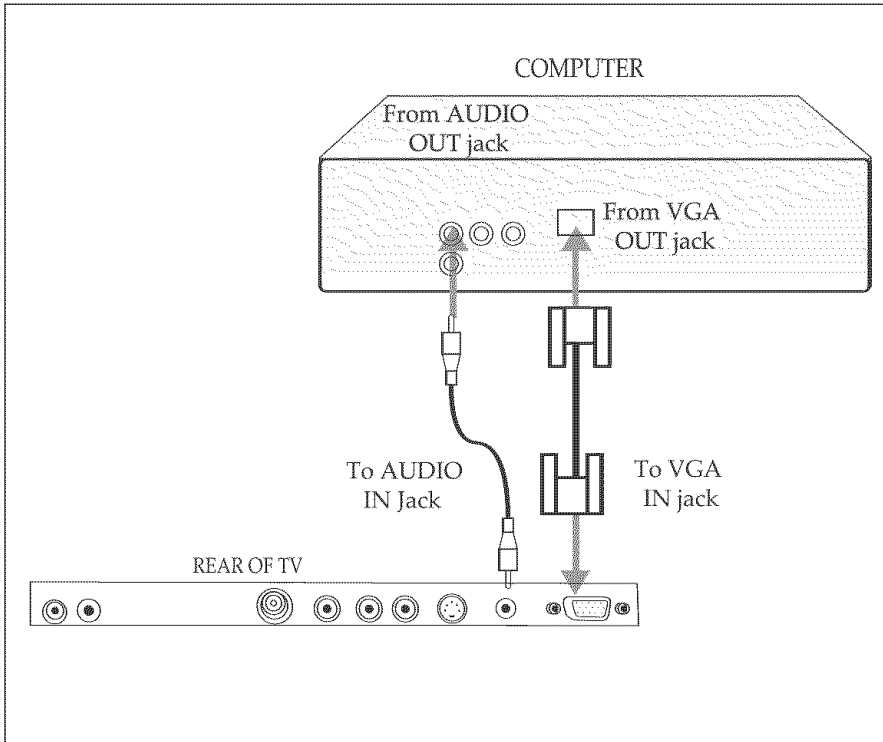

1. Power off the TV and turn off your computer (PC).
2. Connect the audio cable (not included) from the computer's Audio OUT jack to the TV's VGA AUDIO IN jack.
3. Connect a VGA cable from the computer's VGA OUT jack to the TV's VGA IN jack.
4. Turn on the TV and press the TV/VIDEO button until PC appears on the TV screen.
5. Turn on your computer and the computer screen will appear.

NOTES:

1. You must follow the above steps when you connect between the computer and the television for the first time; otherwise, the computer screen may not appear.
2. Refer to the computer's owner's manual for instructions.

VIEWING ANGLE ADJUSTMENT

This unit is designed to allow you to have a comfortable viewing angle, which can be adjusted from -5° to $+25^{\circ}$.

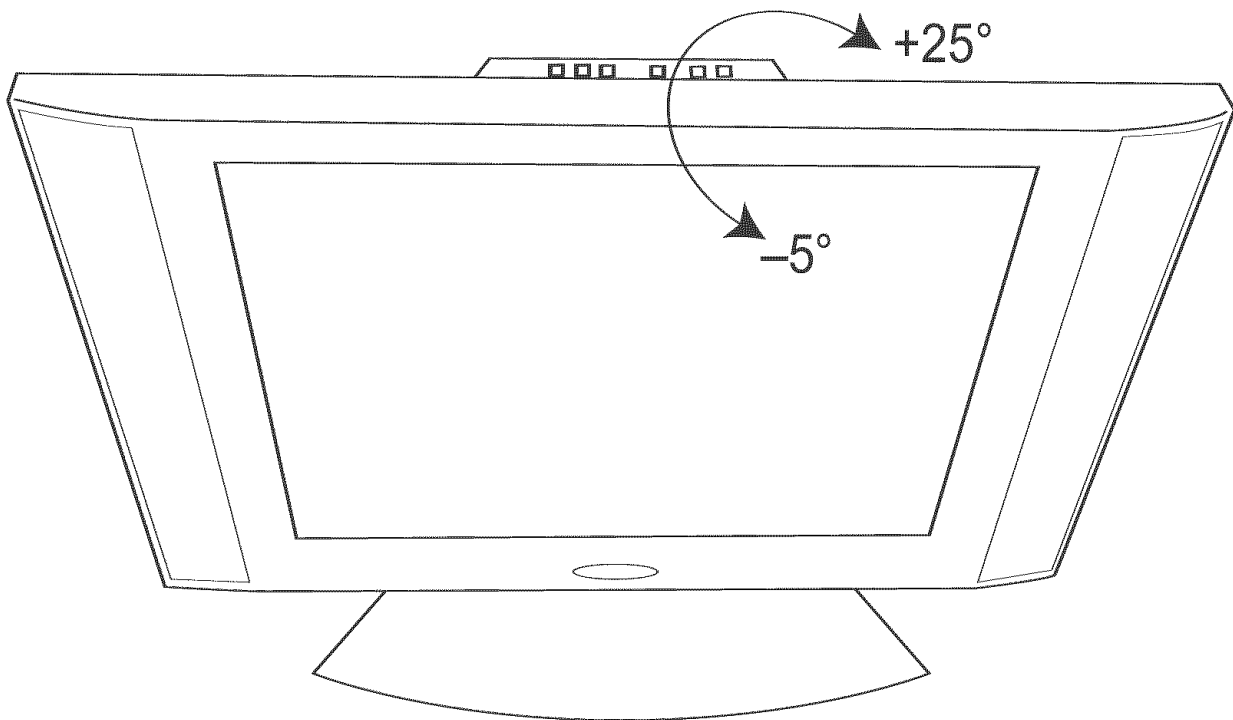

NOTE: Do not force the LCD monitor over its maximum viewing angle settings as stated above. Attempting this will result in damage to the monitor and stand.

SETTING THE MENU

TURNING THE MAIN POWER ON

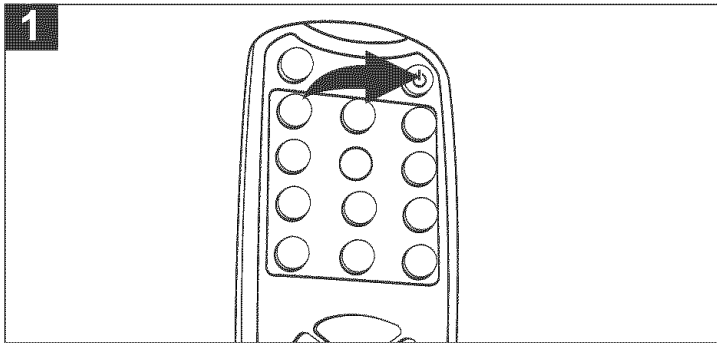

Press the POWER button to turn on the TV; the POWER indicator will light orange.

SETTING THE VIDEO

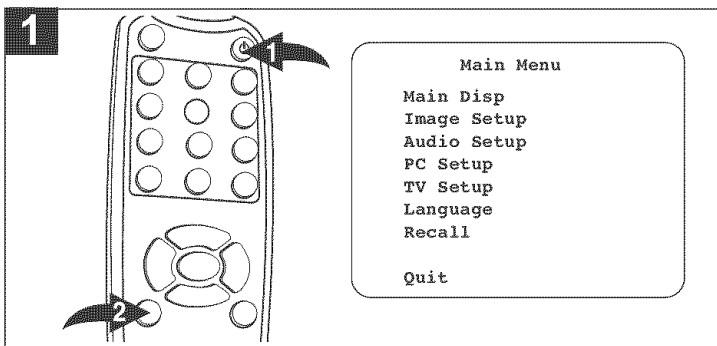

Press the POWER button ❶ to turn on the TV; the POWER indicator will light orange. Press the MENU button ❷; the Main Menu screen will appear.

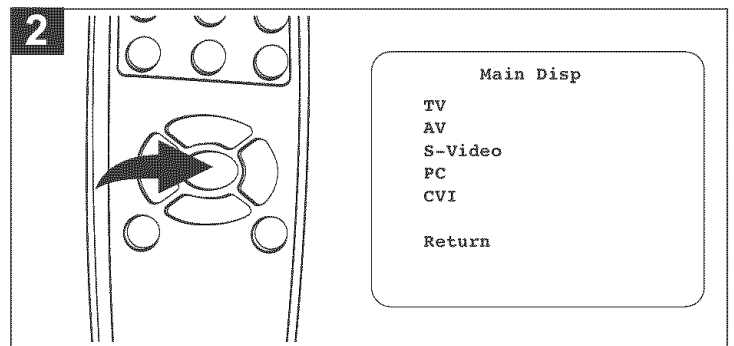

Press the ENTER button to select the Main Display option.

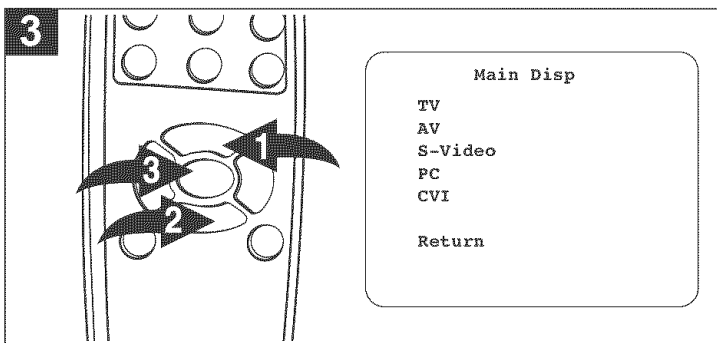

Press the CHANNEL/Navigation UP ❸ or DOWN ❷ button to select the desired Video mode (the jacks that the external unit you want to view is connected to): TV, AV, S-Video, PC or CVI (Component Video Input), then press the ENTER button ❶ to select it.

NOTES:

- If no buttons are pressed for 10 seconds, the menu will disappear automatically.
- To exit the Menu setting, press the MENU button once; the menu will disappear on the TV screen.

NOTES:

- You can also directly press the TV/Video button (on the remote) to select the desired video mode.

SETTING THE MENU (CONTINUED)

IMAGE SETUP

1

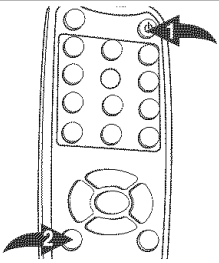

Main Menu

Main Disp
Image Setup
Audio Setup
PC Setup
TV Setup
Language
Recall

Quit

Press the POWER button ❶ to turn on the TV; the POWER indicator will light orange. Press the MENU button ❷; the Main Menu screen will appear.

2

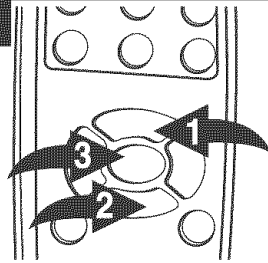

Image Setup

Brightness
Contrast
Sharpness
Tint
Color

Return

Press the CHANNEL/Navigation UP ❶ or DOWN ❷ button to select IMAGE SETUP, then press the ENTER button ❸ to select it.

3

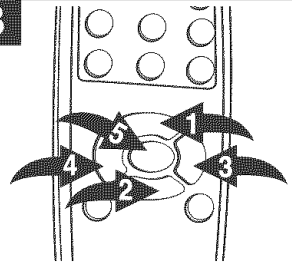

Image Setup

Brightness
Contrast
Sharpness
Tint
Color

Return

Press the CHANNEL/Navigation UP ❶ or DOWN ❷ button until BRIGHTNESS is selected, then press the ENTER button ❸ to select it. Set the desired brightness using the VOLUME UP/Navigation Right ❹ or VOLUME DOWN/Navigation Left ❺ button. When done, press the ENTER button ❸.

4

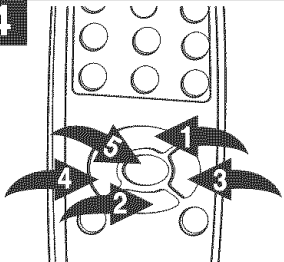

Image Setup

Brightness
Contrast
Sharpness
Tint
Color

Return

Press the CHANNEL/Navigation UP ❶ or DOWN ❷ button until CONTRAST is selected, then press the ENTER button ❸ to select it. Set the desired contrast using the VOLUME UP/Navigation Right ❹ or VOLUME DOWN/Navigation Left ❺ button. When done, press the ENTER button ❸.

5

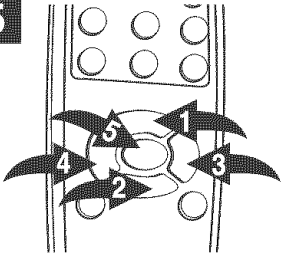

Image Setup

Brightness
Contrast
Sharpness
Tint
Color

Return

Press the CHANNEL/Navigation UP ❶ or DOWN ❷ button until SHARPNESS is selected, then press the ENTER button ❸ to select it. Set the desired sharpness using the VOLUME UP/Navigation Right ❹ or VOLUME DOWN/Navigation Left ❺ button. When done, press the ENTER button ❸.

6

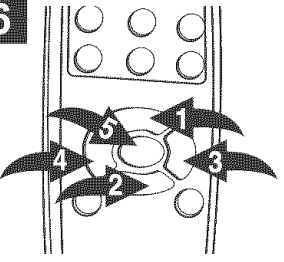

Image Setup

Brightness
Contrast
Sharpness
Tint
Color

Return

Press the CHANNEL/Navigation UP ❶ or DOWN ❷ button until TINT is selected, then press the ENTER button ❸ to select it. Set the desired tint using the VOLUME UP/Navigation Right ❹ or VOLUME DOWN/Navigation Left ❺ button. When done, press the ENTER button ❸.

6

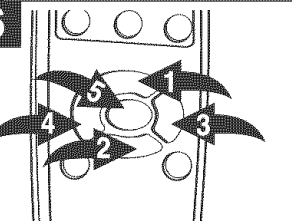

Image Setup

Brightness
Contrast
Sharpness
Tint
Color

Return

Press the CHANNEL/Navigation UP ❶ or DOWN ❷ button until COLOR is selected, then press the ENTER button ❸ to select it. Set the desired color using the VOLUME UP/Navigation Right ❹ or VOLUME DOWN/Navigation Left ❺ button. When done, press the ENTER button ❸.

NOTES:

- The SHARPNESS, TINT and COLOR settings are not available for PC or CVI mode.
- The TINT setting is not available for TV mode.
- **To return to the Main Menu**, select Return using the CHANNEL/Navigation Up/Down button, then press the ENTER button to select another menu option. **To Exit the menu**, press the MENU button.

SETTING THE MENU (CONTINUED)

AUDIO SETUP

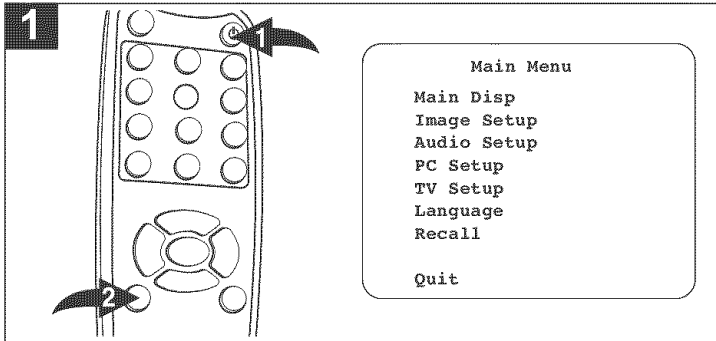

Press the POWER button ❶ to turn on the TV; the POWER indicator will light orange. Press the MENU button ❷; the Main Menu screen will appear.

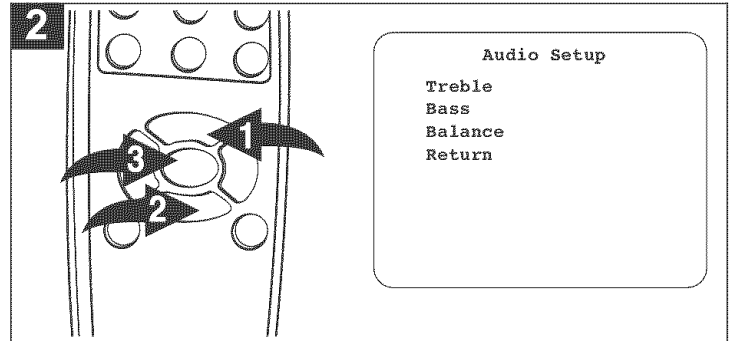

Press the CHANNEL/Navigation UP ❶ or DOWN ❷ button to select AUDIO SETUP, then press the ENTER button ❸ to select it.

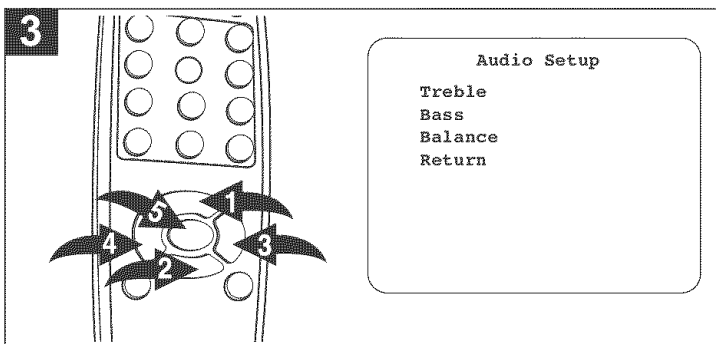

Press the CHANNEL/Navigation UP ❶ or DOWN ❷ button until TREBLE is selected, then press the ENTER button ❸ to select it. Set the desired treble using the VOLUME UP/Navigation Right ❹ or VOLUME DOWN/Navigation Left ❺ button. When done, press the ENTER button ❸.

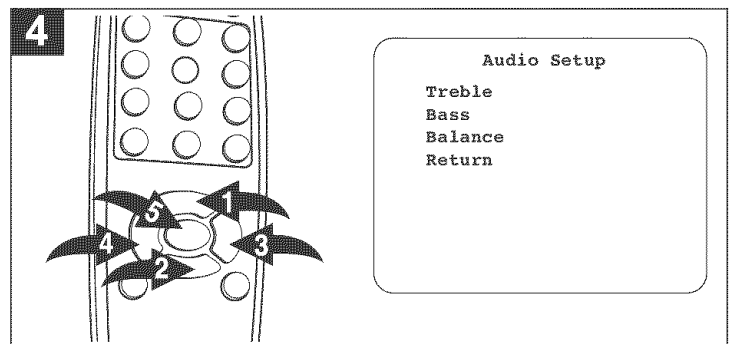

Press the CHANNEL/Navigation UP ❶ or DOWN ❷ button until BASS is selected, then press the ENTER button ❸ to select it. Set the desired bass using the VOLUME UP/Navigation Right ❹ or VOLUME DOWN/Navigation Left ❺ button. When done, press the ENTER button ❸.

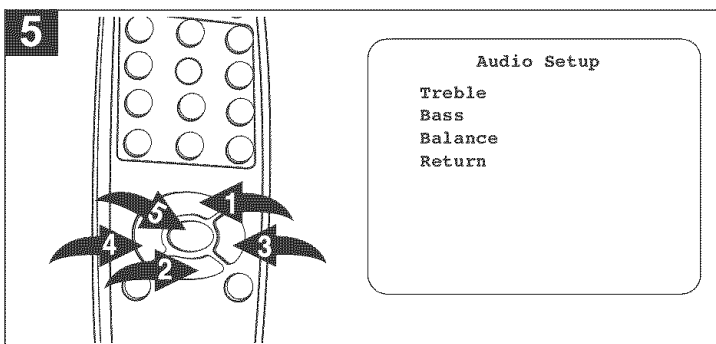

Press the CHANNEL/Navigation UP ❶ or DOWN ❷ button until BALANCE is selected, then press the ENTER button ❸ to select it. Set the desired balance using the VOLUME UP/Navigation Right ❹ or VOLUME DOWN/Navigation Left ❺ button. When done, press the ENTER button ❸.

NOTES:

- To return to the Main Menu, select Return using the CHANNEL/Navigation Up/Down button, then press the ENTER button to select another menu option.
- To Exit the menu, press the MENU button.

SETTING THE MENU (CONTINUED)

PC SETUP (MUST BE SET TO PC MODE)

1

Main Menu

Main Disp
Image Setup
Audio Setup
PC Setup
TV Setup
Language
Recall
Quit

Press the POWER button ① to turn on the TV; the POWER indicator will light orange. Press the TV/VIDEO button ② repeatedly to select PC mode. Press the MENU button ③; the Main Menu screen will appear.

2

PC Setup

Color
H Position
V Position
Phase
Clock
Auto Adjust
Feature
Return

Press the CHANNEL/Navigation UP ① or DOWN ② button to select PC SETUP, then press the ENTER button ③ to select it.

3

Color

6500K
7500K
9300K
User Color
Return

Press the CHANNEL/Navigation UP ① or DOWN ② button until COLOR is selected, then press the ENTER button ③ to select it. Select the desired color (6500K, 7500K, 9300K or User color) using the CHANNEL/Navigation UP ① or DOWN ② button. Press the ENTER button ③ to confirm the Color setting.

4

Red

If you selected User Color, then you can adjust the Red, Green or Blue color as desired using CHANNEL/Navigation UP ① or DOWN ② button, then press the ENTER button ③ to select. Set the desired blue, green or red color as desired using the VOLUME UP/Navigation Right ④ or VOLUME DOWN/Navigation Left ⑤ button. When done press the ENTER button ③. To return to the PC SETUP menu, select Return using the CHANNEL/Navigation UP ① or DOWN ② button; then press the ENTER button ③.

5

H Position

Press the CHANNEL/Navigation UP ① or DOWN ② button until H-Position is selected, then press the ENTER button ③ to select it. Adjust the window's horizontal position using the VOLUME UP/Navigation Right ④ or VOLUME DOWN/Navigation Left ⑤ button. When done, press the ENTER button ③.

6

V Position

Press the CHANNEL/Navigation UP ① or DOWN ② button until V-Position is selected, then press the ENTER button ③ to select it. Adjust the window's Vertical position using the VOLUME UP/Navigation Right ④ or VOLUME DOWN/Navigation Left ⑤ button. When done, press the ENTER button ③.

CONTINUED ON THE NEXT PAGE

SETTING THE MENU (CONTINUED)

PC SETUP (CONTINUED)

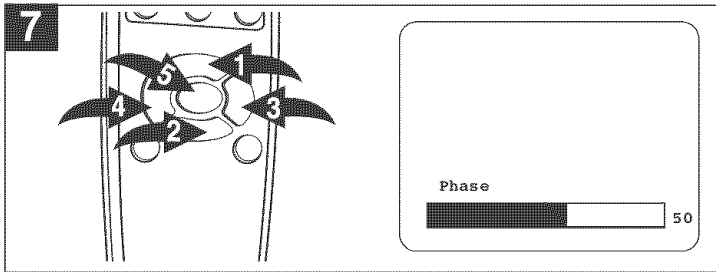

Press the CHANNEL/Navigation UP **1** or DOWN **2** button until Phase is selected, then press the ENTER button **5** to select it. Set the desired phase using the VOLUME UP/Navigation Right **3** or VOLUME DOWN/Navigation Left **4** button. When done, press the ENTER button **5**.

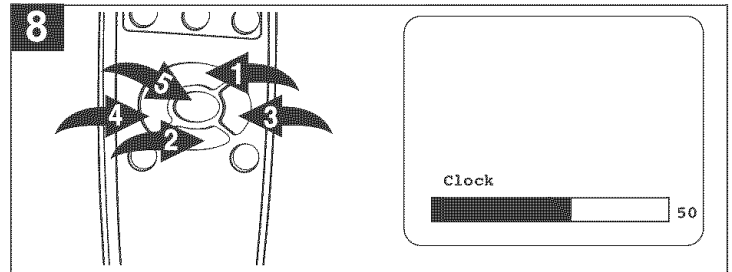

Press the CHANNEL/Navigation UP **1** or DOWN **2** button until Clock is selected, then press the ENTER button **5** to select it. Adjust the window's width using the VOLUME UP/Navigation Right **3** or VOLUME DOWN/Navigation Left **4** button. When done, press the ENTER button **5**.

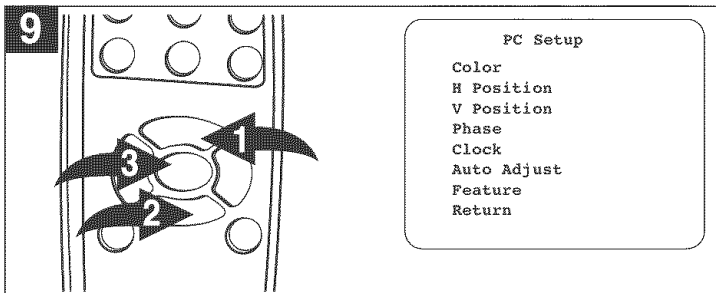

Press the CHANNEL/Navigation UP **1** or DOWN **2** button until Auto Adjust is selected. Press the ENTER button **3**, then the unit will automatically adjust the PC window to fully fit with the display screen.

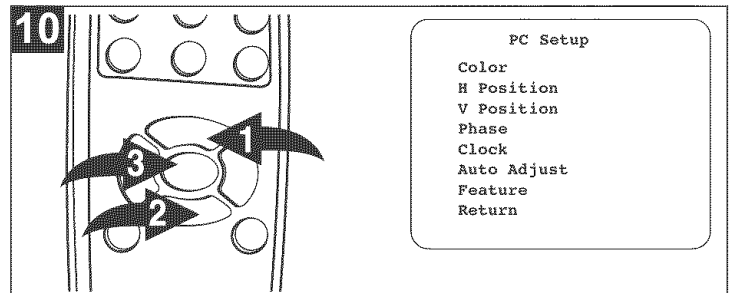

Press the CHANNEL/Navigation UP **1** or DOWN **2** button until Feature is selected; the PC screen resolution, PC screen refresh rate, Horizontal and Vertical settings will appear. (NOTE: You can only view for these information) Press the ENTER button **3** to return to PC Setup menu.

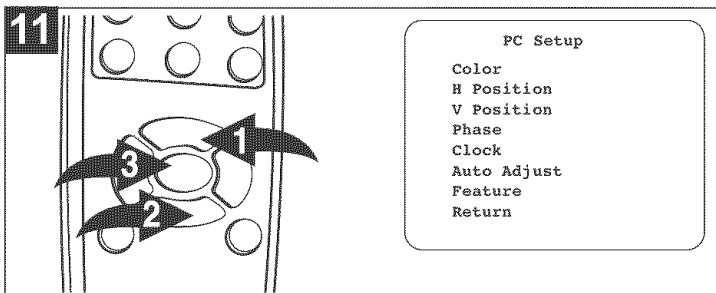

Press the CHANNEL/Navigation UP **1** or DOWN **2** button until Feature is selected; the Horizontal and Vertical settings will appear. When done, press the ENTER button **3**.

NOTES:

- **To return to the Main Menu**, select Return using the CHANNEL/Navigation Up/Down button, then press the ENTER button to select another menu option.
- **To Exit the menu**, press the MENU button.

SETTING THE SYSTEM AND SETTING THE CHANNELS INTO MEMORY

1

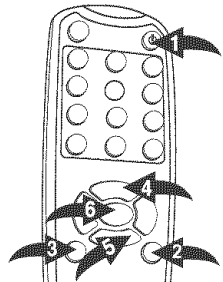

Main Menu

Main Disp
Image Setup
Audio Setup
PC Setup
TV Setup
Language
Recall

Quit

Press the POWER button ❶ to turn on the TV; the POWER indicator will light orange. Press the TV/VIDEO button ❷ repeatedly to select TV mode. Press the MENU button ❸; the Main Menu screen will appear. Press the CHANNEL/Navigation UP ❹ or DOWN ❺ button to select TV SETUP, then press the ENTER button ❻ to select it.

2

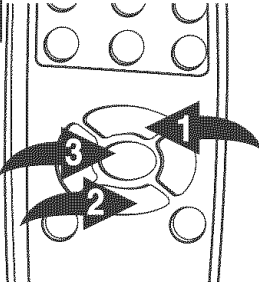

TV Setup

AIR CATV
Auto Program
Add Erase CH
Close Caption
VChip Control
System Setup
Return

Press the CHANNEL/Navigation UP ❶ or DOWN ❷ button until AIR CATV is selected, then press the ENTER button ❸ to select it.

3

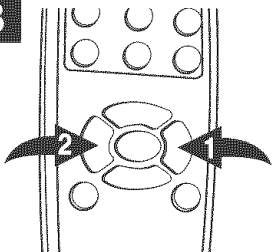

AIR CATV
AirTV CATV

Press the VOLUME UP/Navigation Right ❶ or VOLUME DOWN/Navigation Left ❷ button to select between AirTV and CATV (Cable TV).

4

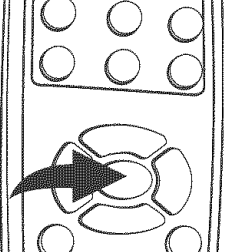

Then press the ENTER button to select it.

5

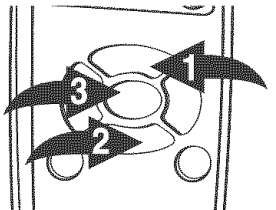

System Setup

STD
HRC
IRC
Auto

Return

Enter the TV SETUP menu as described in step 1 above. If you select cable, press the CHANNEL/Navigation UP ❶ or DOWN ❷ button until SYSTEM SETUP is selected, then press the ENTER button ❸ to select it. Press the CHANNEL/Navigation UP ❶ or DOWN ❷ button to select the cable system (STD, HRC, IRC or Auto) in your area, then press the ENTER button ❹ to select it. To return to the TV SETUP Menu, select Return using the CHANNEL/Navigation UP ❶ or DOWN ❷, then press the ENTER button ❸.

6

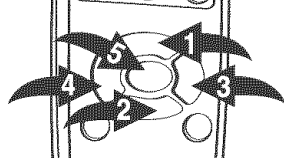

Enter the TV SETUP menu as described in step 1 above. Press the CHANNEL/Navigation UP ❶ or DOWN ❷ button until Auto Program is selected, then press the ENTER button ❸. To start automatic scanning (the TV will automatically cycle through all the channels and store active channels into memory) select "YES" using the VOLUME UP/Navigation Right ❹ or VOLUME DOWN/Navigation Left ❺ button, then pressing the ENTER button ❸. (Otherwise, select "NO" to cancel Auto Program function and return to the TV SETUP menu.) When completed, the TV will be on the first available channel.

NOTES:

- **To return to the Main Menu**, select Return using the CHANNEL/Navigation Up/Down button, then press the ENTER button to select another menu option.
- **To Exit the menu**, press the MENU button.

FAQs:

How many channels will I actually receive?

The actual number of channels that can be received depends on how many channels your cable or satellite company, or local area, provides. Contact your company to determine the number of channels in your area.

Do channels need to be set into memory before using the CHANNEL/Navigation UP or DOWN button?

Yes, the channels must be programmed into memory.

ADDING AND SKIPPING CHANNELS

After setting channels into memory, you can add or delete channels as follows:

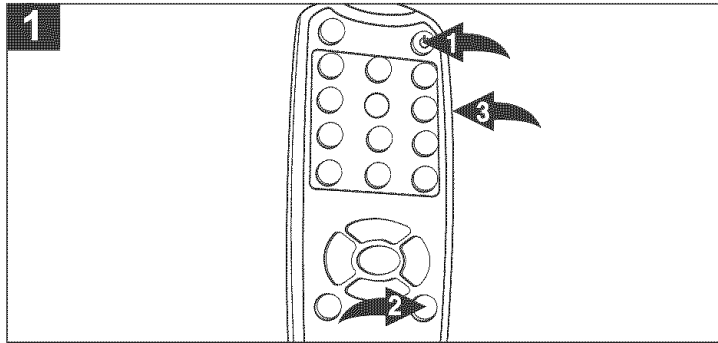

Press the POWER button ❶ to turn on the TV; the POWER indicator will light orange. Press the TV/VIDEO button ❷ repeatedly to select the TV mode. Select a channel to erase or add using the Direct Channel Selection/Number (0-9) buttons ❸.

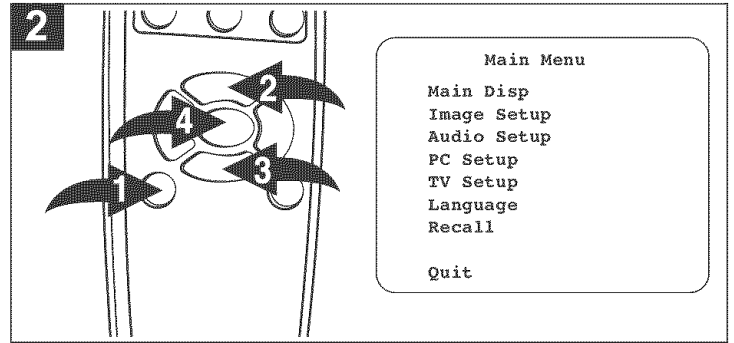

Press the MENU button ❶; the Main Menu screen will appear. Press the CHANNEL/Navigation UP ❷ or DOWN ❸ button to select TV SETUP, then press the ENTER button ❹ to select it.

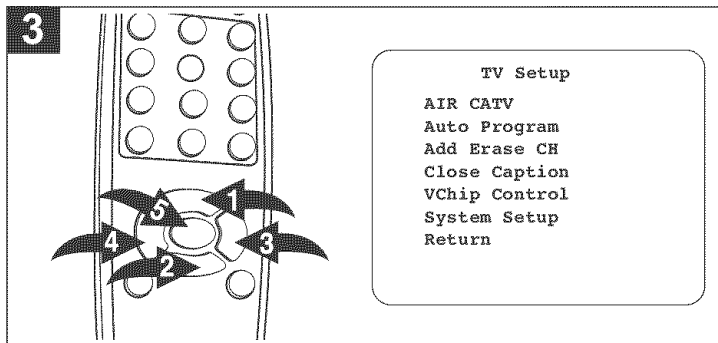

Press the CHANNEL/Navigation UP ❶ or DOWN ❷ button until ADD ERASE CH is selected, then press the ENTER button ❸ to select it. Select ADD, ERASE or EXIT using the VOLUME UP/Navigation Right ❹ or VOLUME DOWN/Navigation Left ❺ button. Press the ENTER button ❸ to confirm and exit the menu. If ERASE is selected, the channel will be skipped when using the CHANNEL/Navigation UP ❶ or DOWN ❷ button to select a TV channel while in TV mode. If you select EXIT, it will return to the TV Setup menu.

NOTE: If a channel is erased, you cannot use the Channel/Navigation UP or Down button to select that channel. You can only use the Direct Channel Selection/Number (0-9) buttons to select that channel. Add the channel again so you can select that channel using the Channel/Navigation UP or Down button.

TV OPERATION

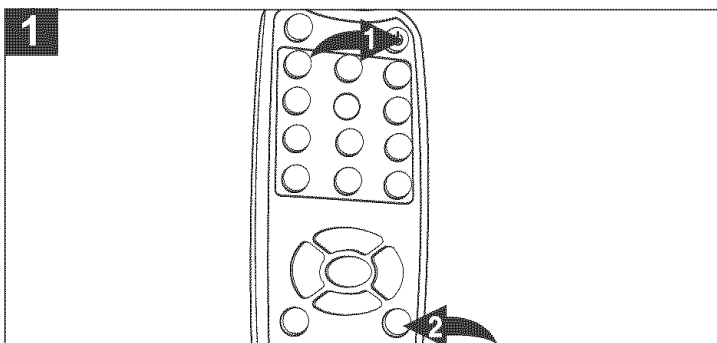

Press the POWER button ❶ to turn on the TV; the POWER indicator will light orange. Press the TV/VIDEO button ❷ repeatedly to select the TV mode.

2

OPTIONS

AirTV: If using a VHF/UHF antenna.

CATV: If using Cable TV.

Set the AirTV/CATV (CABLE) option and set the channels into memory as described on pages 19 and 20.

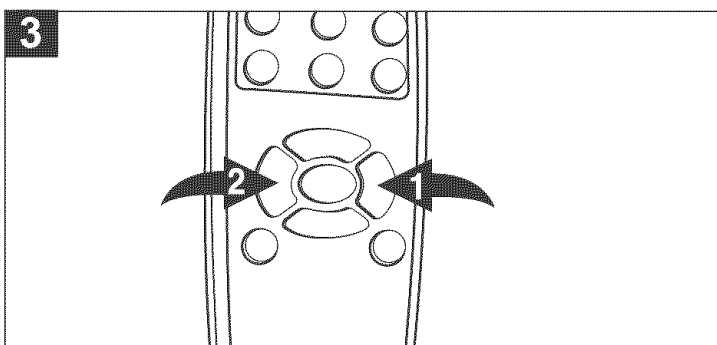

Adjust the volume level by pressing the VOLUME UP/Navigation Right ❶ or VOLUME DOWN/Navigation Left ❷ button. The volume level will be indicated on the screen by a green bar.

4

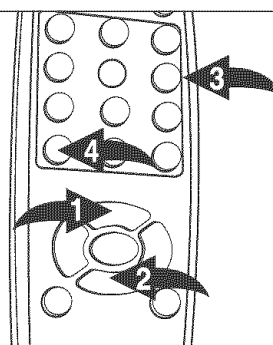

For proper operation, before selecting channels, they must be set into the TV's program memory, see page 19-20. Press and release the CHANNEL/Navigation UP ❶ or DOWN ❷ button. The TV automatically stops at the next channel set into memory. This will not operate if channels are not set into memory.

Direct Program Selection buttons (0-9) ❸.

Use these buttons to select a channel. The channel number will appear at the top right corner of the screen.

- For Channels 01 through 99, press the two digits in order.
- For Channels 100 through 125, press the 1-- button ❹, then the remaining two digits.

NOTES:

- When AIR/CATV is set to AIR, only channels up to 69 can be selected. When set to CATV, channels up to 125 can be selected.
- If an invalid channel is selected, the display will revert to the original channel.

FAQs:

Why do I only receive 69 channels, when my cable goes much higher?
TV SETUP option must be set to CATV when using cable, see page 19.

Why are some channels scrambled?

You must subscribe to these channels through your cable company.

TV OPERATION (CONTINUED)

MUTE

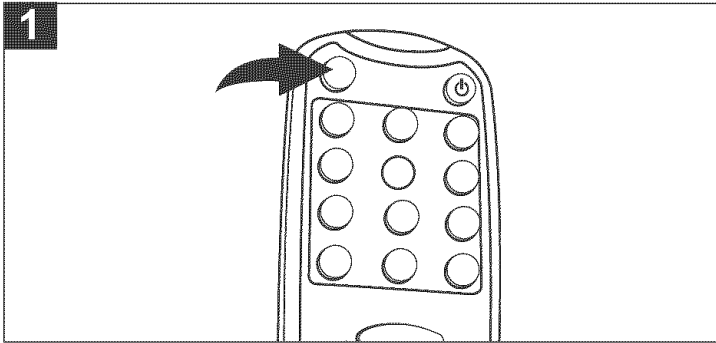

Press the MUTE button to turn off the sound. The TV's sound will be silenced and "MUTE" will appear on the screen. The sound can be turned back on by pressing this button again; "MUTE" will disappear from the screen.

JUMP

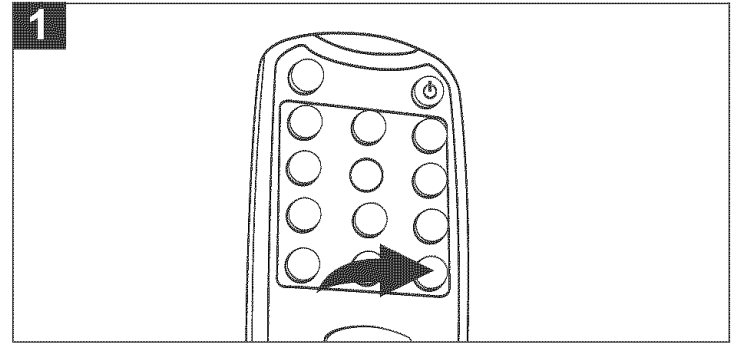

While in TV mode, press the JUMP button to go back to the previous channel selected. Press the JUMP button again to return to the channel you were watching.

TV/VIDEO

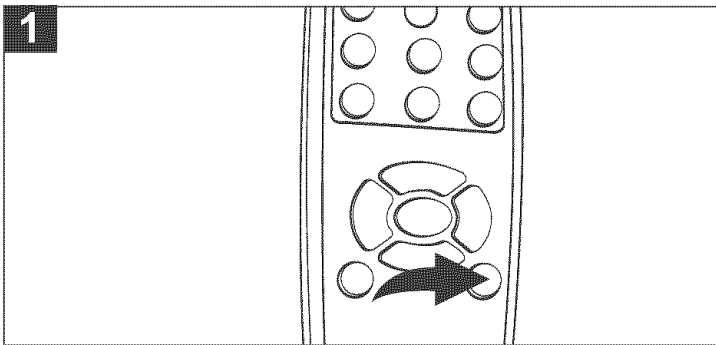

Repeatedly press this button to cycle through the device(s) connected to the INPUT jacks (TV/CATV, AV, S-Video, PC or CVI).

NOTE:

- For PC mode, if "No Signal" appears on the screen, please refer to "COMPUTER CONNECTION" (see page 13).

SLEEP TIMER

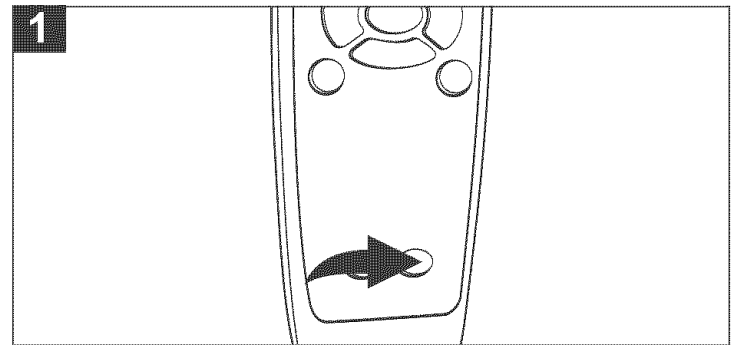

Press the SLEEP button to set the sleep time between 30 to 120 minutes (i.e. Sleep OFF - the sleep time will be off, Sleep 30 - the TV will automatically turn off after 30 minutes, Sleep 60 - the unit TV will automatically turn off after 60 minutes, etc.).

TV OPERATION (CONTINUED)

INFO

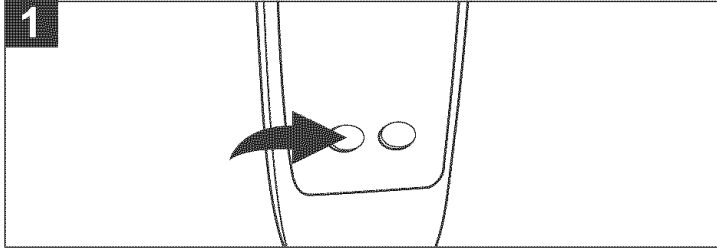

Press the INFO button once to show the mode (channel number if in TV/CATV mode). Press a second time to clear the screen or wait three seconds and the screen will clear automatically.

EARPHONE

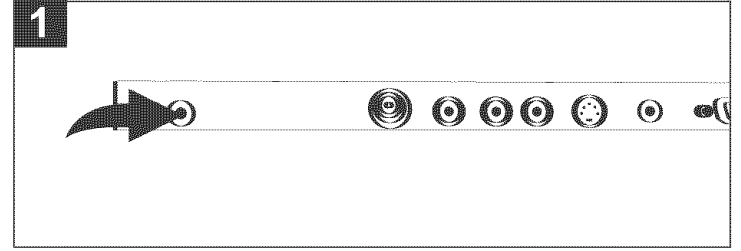

For private listening, insert an earphone into the EARPHONE jack on the rear of the unit. The speakers will be disconnected when the plug is inserted.

CLOSED CAPTIONS

WHAT IS CLOSED CAPTIONING?

This television has the capability to decode and display Closed Captioned television programs. Closed Captioning will display text on the screen for hearing-impaired viewers or it will translate and display text in another language.

CLOSED CAPTIONING WITH A VCR

Closed Captioned programs can be recorded and played back on a VCR with the Closed Captioned text intact. The Closed Captioned text will disappear during Cue (Fast Forward Search), Review (Rewind Search) and Pause modes or if the VCR tracking is not adjusted properly.

TO VIEW CLOSED CAPTIONS

While in TV mode, press the MENU button and select TV SETUP using the CHANNEL/Navigation UP or DOWN button; then press the ENTER button to confirm. Select the Closed Caption option using the CHANNEL/Navigation UP or DOWN button; then press the ENTER button to confirm. Select the desired Closed Caption option using the VOLUME UP/Navigation Right or VOLUME DOWN/Navigation Left button; then press the ENTER button to confirm and return to TV Setup menu. Press the Menu button to exit the menu.

CAPTIONS (CC1-4): This Closed Caption Mode will display text on the screen in English or another language. Generally,

Closed Captions in English are transmitted on Captions 1 and Closed Captions in other languages are transmitted on Captions 2 through 4.

TEXT (TT1-4): The Text Closed Caption Mode will usually fill the screen with a programming schedule or other information. Select between Text 1 through 4.

OFF: Turns Closed Captions off.

After selecting a Closed Caption Mode, it will stay in effect until it is changed, even if the channel is changed. If the Captions signal is lost due to a commercial or a break in the signal, the Captions will reappear when the signal is received again. If the channels are changed, the Captions will be delayed approximately 10 seconds.

The Captions will appear in places on the screen where they will least interfere with the picture, usually on the bottom of the screen. News programs will usually show three-line Closed Captions which scroll onto the screen. Most other shows provide two or three lined Captions placed near the character who is speaking so the viewer can follow the dialogue.

Words in italics or underlined describe titles, words in foreign languages or words requiring emphasis. Words that are sung usually appear enclosed by musical notes.

For television programs broadcasting with Closed Captions, look in your TV guide for the Closed Captions symbol (CC).

NOTES:

- When selecting Closed Captions, the captioning will be delayed approximately 10 seconds.
- Misspellings or unusual characters may occasionally appear during Closed Captioning. This is normal with Closed Captioning, especially with live programs. This is because during live programs, captions are also entered live. These transmissions do not allow time for editing.
- When Captions are being displayed, on-screen displays, such as volume and mute may not be seen or may interfere with Closed Captions.
- Some cable systems and copy protection systems may interfere with the Closed Caption signal.
- If using an indoor antenna or if TV reception is very poor, the Closed Caption decoder may not appear or may appear with strange characters or misspelled words. In this case, adjust the antenna for better reception or use an outdoor antenna.

FAQs:

When I press the INFO or MUTE button, the captions do not appear, is this normal?

Yes, this is normal for this unit. Once the display information disappears, the captions will continue.

I entered the Captions mode, but no captions are appearing, why?

If no caption signal is received, no captions will appear, but the television will remain in the Caption mode.

Why is there a big black box on the screen?

Because you are in a Captions mode. Turn the captions off, or select a different Captions mode.

SETTING V-CHIP

V-Chip enables parents to prevent their children from watching inappropriate material on TV. V-Chip reads the ratings for programming (except for news, sports, unedited movies on premium cable and Emergency System signals), then denies access to programming if the program's rating meets the limitations you select. In this case, the program will be blocked.

V-CHIP SET-UP

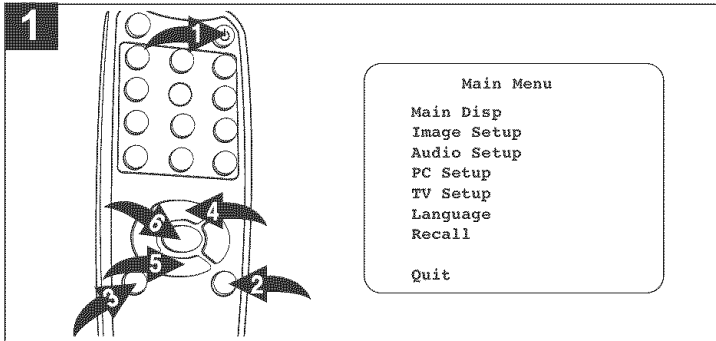

Press the POWER button ❶ to turn on the TV; the POWER indicator will light orange. Press the TV/VIDEO button ❷ repeatedly to select the TV mode. Press the MENU button ❸; the Main Menu screen will appear. Press the CHANNEL/Navigation UP ❹ or DOWN ❺ button to select TV SETUP, then press the ENTER button ❻ to select it.

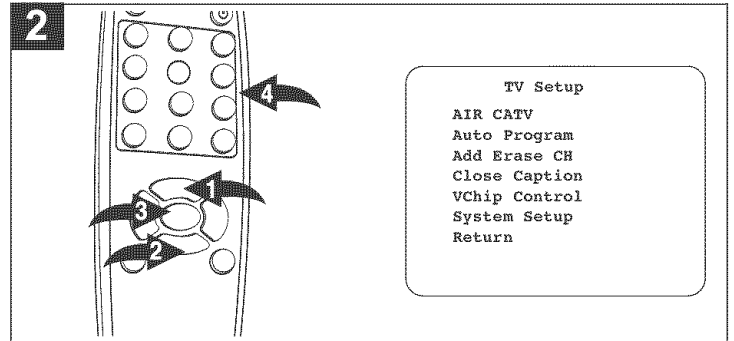

Press the CHANNEL/Navigation UP ❶ or DOWN ❷ button until VCHIP CONTROL is selected, then press the ENTER button ❸ to select it. Using the Direct Channel Selection /Number buttons (0-9) ❹, enter the password ("3308" is the preset/default password if you have not changed it). This password can be changed to consist of different numbers (i.e. 1467, 3732) after the original password is entered. See page 28 to change the password.

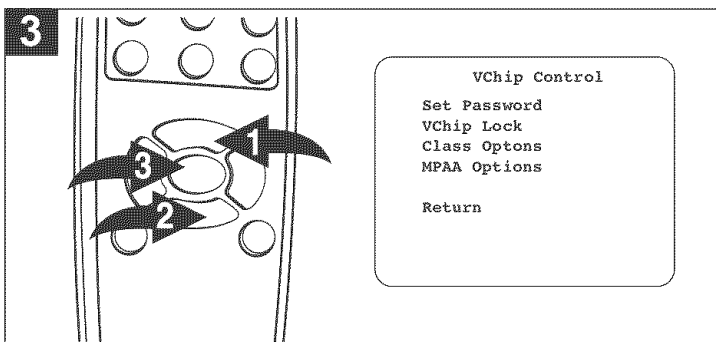

Once in the V-CHIP Control Menu, press the CHANNEL/Navigation UP ❶ or DOWN ❷ button to select V-CHIP, then press the ENTER button ❸ to select it.

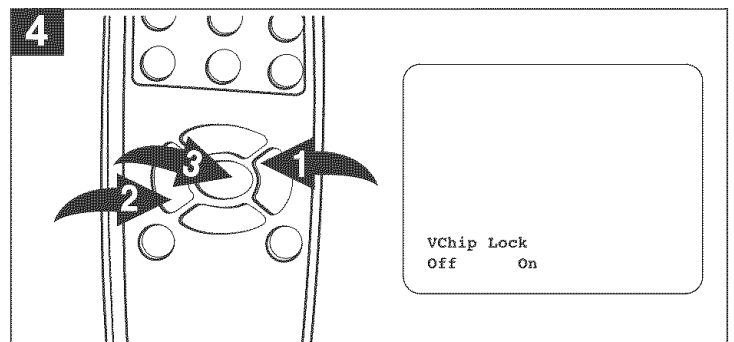

In the Vchip Lock Menu, select Off (Unlock) or On (Lock) using the VOLUME UP/Navigation Right ❶ or VOLUME DOWN/Navigation Left ❷ button. Then, press the ENTER button ❸ to confirm the setting and return to the VCHIP Control Menu.

SETTING V-CHIP (CONTINUED)

MPAA RATING SET-UP

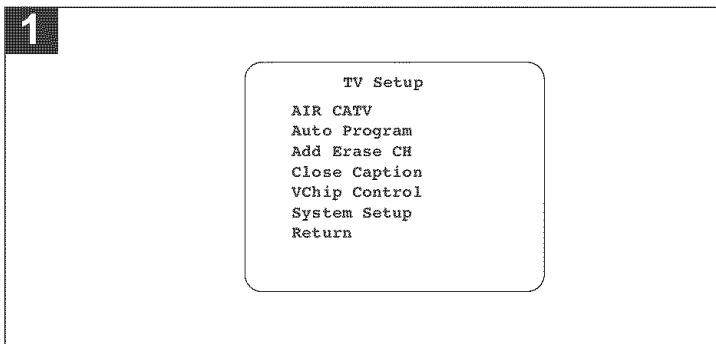

Enter the V-CHIP menu screen as described on page 25 (Steps 1 & 2).

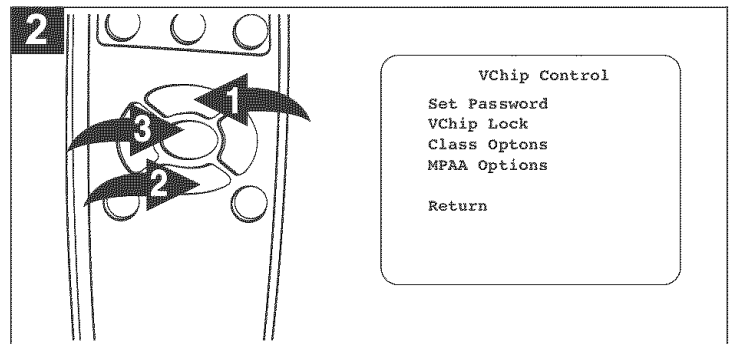

Press the CHANNEL/Navigation UP **1** or DOWN **2** button to select a rating (see below). Then press ENTER button **3** to block or unblock the rating.

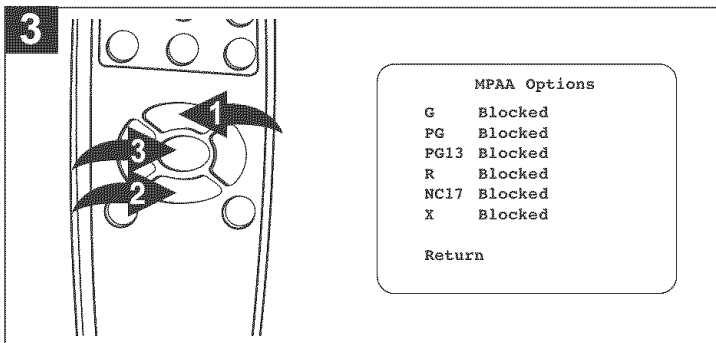

Press the CHANNEL/Navigation UP **1** or DOWN **2** button to select a rating (see below). Then press the ENTER button **3** to blocked or unblocked the rating.

G: All ages. **NC17:** 17 years old and above.
PG: Parental Guidance.
PG-13: Parental Guidance, less than 13 years old.
R: Under 17 years old, Parental Guidance suggested.

All programs with a higher rating than the one selected will also be blocked.

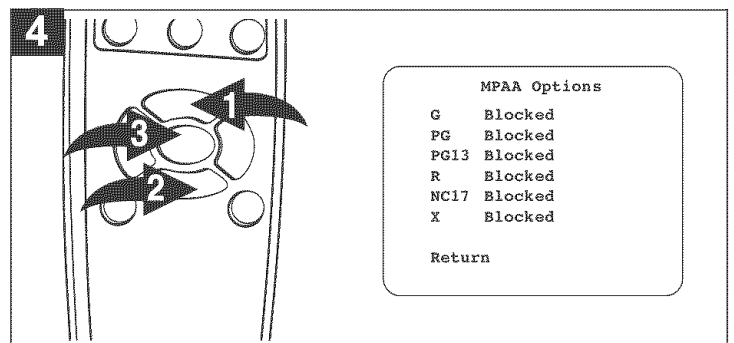

Select "Return" by using the CHANNEL/Navigation UP **1** or DOWN **2** button, then press the ENTER button **3** to confirm the setting and return to the VChip Control menu.

SETTING V-CHIP (CONTINUED)

TV RATING (CLASS OPTION) SET-UP

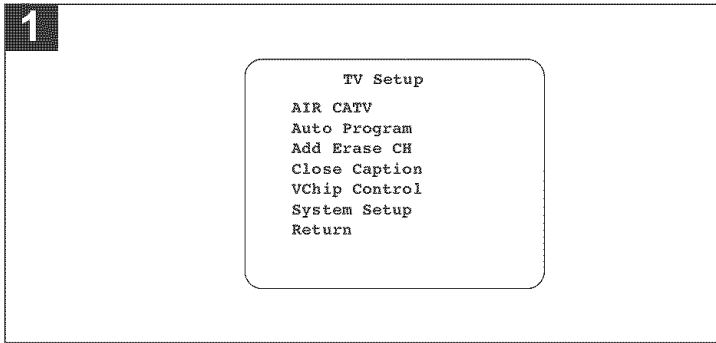

Enter the V-CHIP menu screen as described on page 25 (Steps 1 & 2).

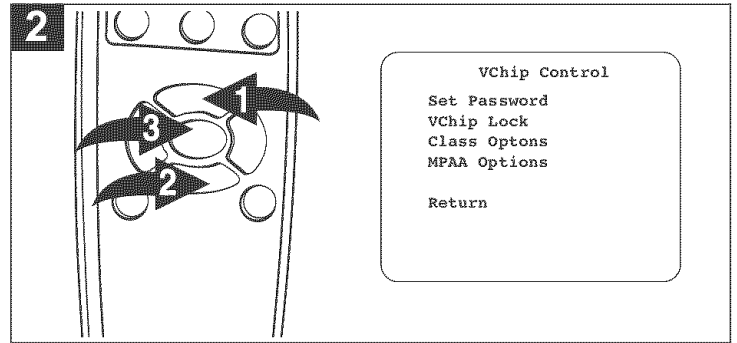

Press the CHANNEL/Navigation UP **1** or DOWN **2** button until Class Option is selected and press the ENTER button **3**, the Class Option menu.

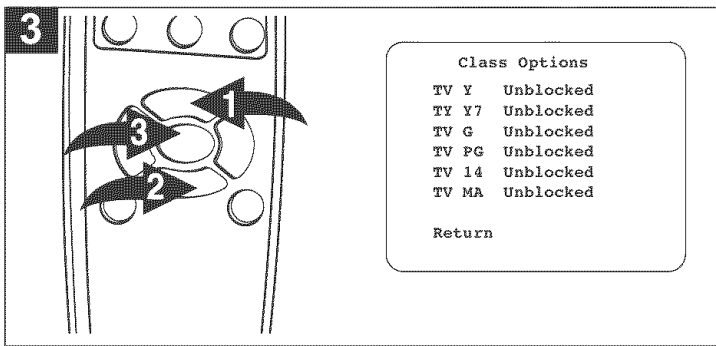

Press the CHANNEL/Navigation UP **1** or DOWN **2** button to select a rating (see below). Then press the ENTER button **3** to blocked or unblocked the rating.

- TV Y: Young
- TV Y7: 7 and older
- TV G: All ages
- TV PG: Parental Guidance
- TV 14: Parental Guidance less than 14 years old
- TV MA: Mature Audiences

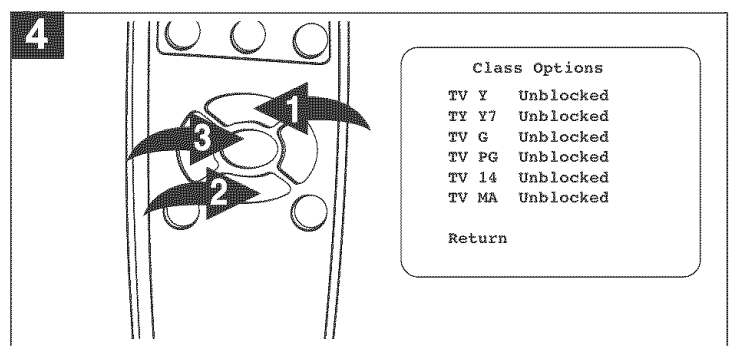

Select "Return" by using the CHANNEL/Navigation UP **1** or DOWN **2** button, then press the ENTER button **3** to confirm the setting and return to the VChip Control menu.

SETTING V-CHIP (CONTINUED)

CHANGING THE PASSWORD

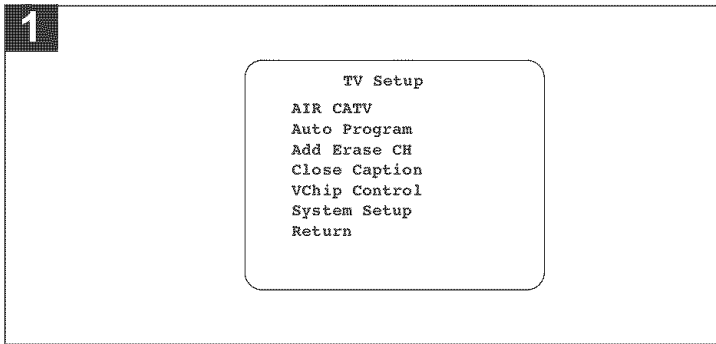

Enter the V-CHIP menu screen as described on page 25 (Steps 1 & 2).

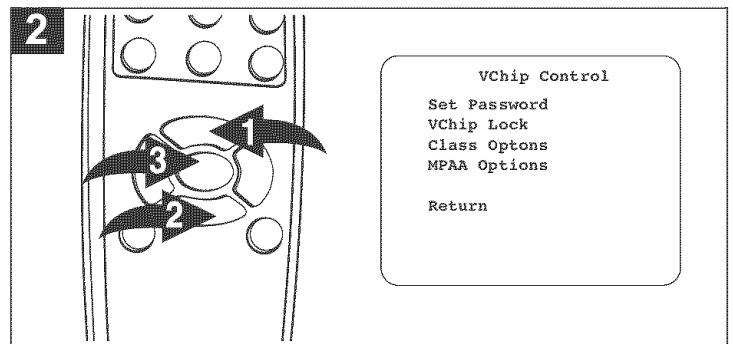

Press the CHANNEL/Navigation UP **1** or DOWN **2** button until Set Password Option is selected and press the ENTER button **3**.

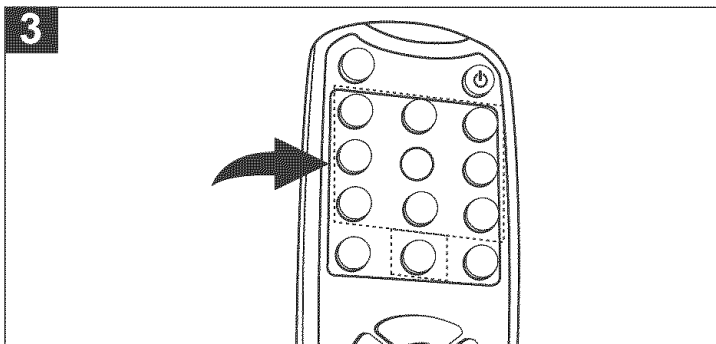

Use the Direct Channel Selection/Number Buttons (0-9) to enter the new (4-digit) password. After you have enter the 4 digit password, the password will be changed and it will return to the VChip Control menu.

NOTE: Once you have enter the password, the password will be changed, make sure to write down the password in a safe place.

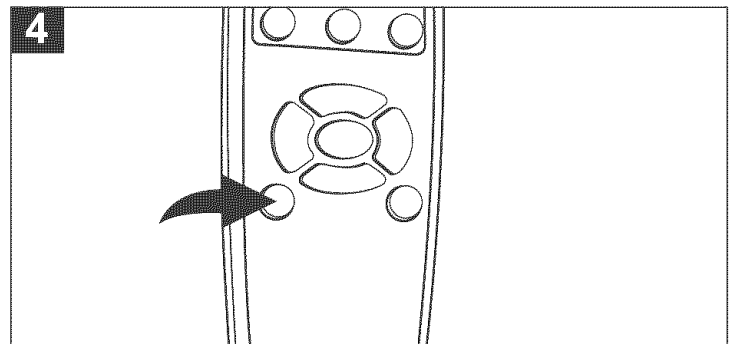

To Exit the VChip Control menu, press the MENU button..

TROUBLESHOOTING GUIDE

Check the following before requesting service:

SYMPTOM	POSSIBLE CAUSE	POSSIBLE SOLUTION
POWER		
No power.	The AC cord is not connected.	Connect the AC cord properly.
TV BROADCAST RECEPTION		
Poor or no picture.	TV station experiencing problems.	Try another channel.
	Antenna/CATV connector is not connected.	Check CATV connection or VHF/UHF antenna.
	Possible local interference.	Check for source of reception disturbance.
Picture wobbles or drifts.	TV station experiencing problems.	Try another channel.
	Cable TV channel is scrambled.	A Cable box needs to be used (if desired).
	Possible local interference.	Check for source of reception disturbance.
No CATV reception.	CATV connected improperly or not connected.	Check all CATV connections.
	TV AIR/CATV setup option set to AirTV.	Set TV AIR/CATV setup option to CATV.
	Cable TV service interrupted.	Contact your Cable TV company.
No reception above ch69.	TV Setup option set to AIR.	Set TV Setup option to CATV.
Poor or no sound.	TV station experiencing problems.	Try another channel.
	MUTE button is pressed.	Press MUTE button again.
	Possible local interference.	Check for source of reception disturbance.
	Antenna/CATV connector is not connected.	Check CATV connection or VHF/UHF antenna.
	Volume is set to minimum.	Increase volume.
TV shuts off.	TV station stopped broadcasting.	Tune to a new channel.
	Sleep Timer is set.	Set Sleep Timer to Off.
Closed Captioning not working.	TV signal is weak.	Check CATV or VHF/UHF antenna connection.
	TV station experiencing problems or program tuned is not closed captioned.	Try another channel.
	Closed Captioning not turned on.	Turn Closed Captioning on.
REMOTE CONTROL		
Remote control does not operate.	Distance is too far or too much light in the room.	Operate within 15 feet or reduce the light in the room.
	There is an obstacle in the path of the beam or remote is not aimed at the sensor.	Clear the path of the beam and/or aim the remote at the sensor.
	The batteries are weak or installed incorrectly.	Replace the batteries or install correctly.
PARENTAL CONTROL (V-CHIP)		
Parental control protection is not working properly.	V-Chip setting is turned off.	Turn V-Chip setting on.
	News or sports event being broadcast.	Parental Control does not work with news or sporting events.
	Ratings not set.	Set ratings as desired.

RECEPTION DISTURBANCES

Most types of television interference can be remedied by adjusting the height and position of the VHF/UHF antenna. Outdoor antennas are recommended for best results if not using cable or a satellite. The most common types of television interference are shown below. If one of these symptoms appear when the TV is connected to a Cable TV system, the disturbance may be caused by the local cable company broadcast.

IGNITION:

Black spots or horizontal streaks may appear, picture may flutter or drift. Usually caused by interference from automobile ignition systems, neon lamps, electric drills and other electric appliances.



GHOSTS:

Ghosts are caused by the television signal following two paths. One is the direct path and the other is reflected from tall buildings, hills or other objects. Changing the direction or position of the antenna may improve the reception.

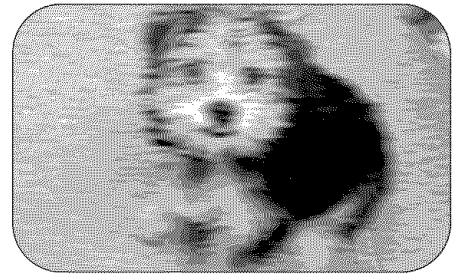

SNOW:

If your receiver is located in the fringe area of a television station where the signal is weak, your picture may be marred by the appearance of small dots. When the signal is extremely weak, it may be necessary to install an external antenna to improve the picture.

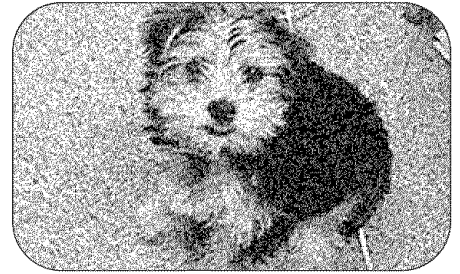

RADIO FREQUENCY INTERFERENCE:

This interference produces moving ripples or diagonal streaks, and in some cases, causes loss of contrast in the picture.

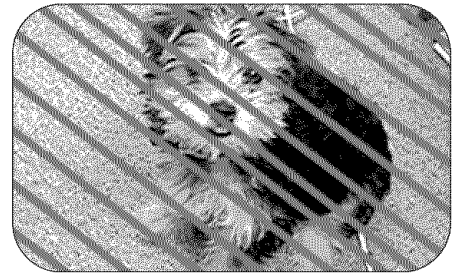

PICTURE SIZE VARIATION:

A slight picture size variation is quite normal when you adjust the CONTRAST or BRIGHTNESS setting.

SPECIFICATIONS

Power Source	AC 120V, 60Hz
Max. Power Consumption.....	36W
LCD Monitor	15" LCD Panel
Viewing Angle.....	H: 170° V: 170°
Screen Ratio	4:3
Resolution	1028 x 768
Contrast Ratio	500:1
Brightness.....	250 nits
Speaker Output Power	2W x 2
HDTV Ready supported	(480i/480p/1080i/720p)
TV Tuner.	Support Mode NTSC M/N Support both TV and CATV (Cable TV)
Dimension	19" (W) x 14.3" (H) x 7.2" (D)
Weight.....	10.5lbs

Specifications are subject to change without notice.

CARE AND MAINTENANCE

To prevent fire or shock hazard, disconnect your unit from the AC power source when cleaning. The finish on the receiver may be cleaned with a dust cloth and cared for as other furniture. Use caution when cleaning and wiping the plastic parts. Mild soap and a soft, damp cloth may be used.

**FOR ADDITIONAL SET-UP OR OPERATING ASSISTANCE, PLEASE VISIT OUR WEBSITE AT
WWW.MEMOREXELECTRONICS.COM
OR CONTACT CUSTOMER SERVICE AT (954) 660-7100.**

**PLEASE KEEP ALL PACKAGING MATERIAL FOR AT LEAST 90 DAYS IN CASE YOU NEED TO RETURN THIS
PRODUCT TO YOUR PLACE OF PURCHASE OR TO MEMOREX.**

FOR PARTS AND ACCESSORIES, CONTACT FOX INTERNATIONAL AT 1-800-321-6993.

Memcorp, Inc.
Weston, FL
Printed in Taiwan

Visit our website at www.memorexelectronics.com