

TOSHIBA



COMBINATION LCD TELEVISION AND DVD VIDEO PLAYER

SD-P7000

OWNER'S MANUAL

Introduction 3

Connections 15

TV Operation 20

DVD&VCD Operation 35

MP3/WMA files Operation 43

Audio CD Operation 44

JPEG file Operation 46

Others 47

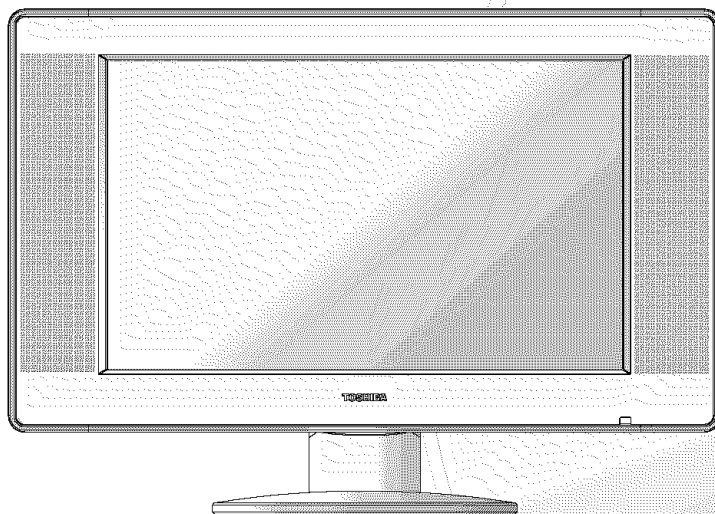

©2004 Toshiba Corporation
Before operating the unit, please read this manual thoroughly.

Regulatory compliance statements

United States of America

Federal Communications Commission (FCC) Unintentional emitter per FCC Part 15

This device has been tested and found to comply with the limits for a Class B digital device, pursuant to Part 15 of the FCC rules. These limits are designed to provide reasonable protection against harmful interference in a residential installation. This equipment generates, uses, and can radiate radio frequency energy and, if not installed and used in accordance with the instructions, may cause harmful interference to radio or television reception. However, there is no guarantee that interference will not occur in a particular installation. If this equipment does cause interference to radio and television reception, which can be determined by turning the equipment off and on, the user is encouraged to try to correct the interference by one or more of the following measures:

- Reorient or relocate the receiving antenna
- Increase the separation between the equipment and receiver
- Connect the equipment to an outlet on a different circuit from that to which the receiver is connected
- Consult the dealer or an experienced radio/TV technician for help.

FCC declaration of conformity

This device complies with Part 15 of the FCC Rules. Operation of this device is subject to the following two conditions: (1) this device may not cause harmful interference, and (2) this device must accept any interference received, including interference that may cause undesired operation.

Changes or modifications not expressly approved by Toshiba could void the FCC compliance and negate your authority to operate the product.

Canada

Industry Canada (IC) Unintentional emitter per ICES-003

This digital apparatus does not exceed the Class B limits for radio noise emissions from digital apparatus as set out in the radio interference regulations of Industry Canada.

Le présent appareil numérique n'émet pas de bruits radioélectriques dépassant les limites applicables aux appareils numériques de Classe B prescrites dans le règlement sur le brouillage radioélectrique édicté par Industrie Canada.

California Law Proposition 65 Warning

▲ WARNING

Handling the cord on this product or cords associated with accessories sold with this product, will expose you to lead, a chemical known to the State of California to cause birth defects or other reproductive harm.
Wash hands after handling.

Vermont and Connecticut Mercury Warning

▲ WARNING

This LCD TV/DVD Combination contains mercury. Disposal of mercury may be regulated due to environmental considerations. For disposal or recycling information, please contact your local authorities or the Electronic Industries Alliance: www.eiae.org.

IMPORTANT SAFEGUARDS



WARNING:

TO REDUCE THE RISK OF ELECTRIC SHOCK DO NOT REMOVE COVER (OR BACK). NO USER SERVICEABLE PARTS INSIDE. REFER TO QUALIFIED SERVICE PERSONNEL.



The lightning flash with arrowhead symbol, within an equilateral triangle, is intended to alert the user to the presence of uninsulated "dangerous voltage" within the product's enclosure that may be of sufficient magnitude to constitute a risk of electric shock to persons.



The exclamation point within an equilateral triangle is intended to alert the user to the presence of important operating and maintenance (servicing) instructions in the literature accompanying the appliance.

NOTE TO CABLE/TV INSTALLER:

This reminder is provided to call the CATV system installer's attention to Article 820-40 of the National Electric Code (U.S.A.). The code provides guidelines for proper grounding and, in particular, specifies that the cable ground shall be connected to the grounding system of the building, as close to the point of the cable entry as practical. For additional antenna grounding information, see items 25 and 26 on page 5.

CAUTION:

Do not attempt to modify this product in any way without written authorization from Toshiba Corporation. Unauthorized modification could void the user's authority to operate this product.

This LCD TV employs a Laser System.

To ensure proper use of this product, please read this owner's manual carefully and retain for future reference should the unit require maintenance, contact an authorized service location.

Use of controls, adjustments, or the performance of procedures other than those specified herein may result in hazardous radiation exposure.

To prevent direct exposure to laser beam, do not try to open the enclosure. Visible laser radiation when open. DO NOT STARE INTO BEAM.

IMPORTANT SAFEGUARDS

(Continued)

WARNING :

To Reduce The Risk Of Fire Or Electric Shock, Do Not Expose This Apparatus To Rain Or Moisture.

Apparatus shall not be exposed to dripping or splashing and no objects filled with liquids, such as vases, shall be placed on the apparatus.

CAUTION :

To reduce the risk of electric shock, do not perform any servicing other than that contained in the operating instructions unless you are qualified to do so.

Important Safety Instructions

1. Read these instructions.
2. Keep these instructions.
3. Heed all warnings.
4. Follow all instructions.
5. Do not use this apparatus near water.
6. Clean only with dry cloth.
7. Do not block any of the ventilation openings. Install in accordance with the manufacturer's instructions.
8. Do not install near any heat sources such as radiators, heat registers, stoves, or other apparatus (including amplifiers) that produce heat.
9. Do not defeat the safety purpose of the polarized or grounding type plug. A polarized plug has two blades with one wider than the other. A grounding type plug has two blades and a third grounding prong. The wide blade or the third prong is provided for your safety. When the provided plug does not fit into your outlet, consult an electrician for replacement of the obsolete outlet.
10. Protect the power cord from being walked on or pinched particularly at plugs, convenience receptacles, and the point where they exit from the apparatus.
11. Only use the attachments / accessories specified by the manufacturer.
12. Use only with a cart, stand, tripod, bracket, or table specified by the manufacturer, or sold with the apparatus. When a cart is used, use caution when moving the cart / apparatus combination to avoid injury from tip-over.



13. Unplug this apparatus during lightning storms or when unused for long periods of time.
14. Refer all servicing to qualified service personnel. Servicing is required when the apparatus has been damaged in any way, such as power supply cord or plug is damaged, liquid has been spilled or objects have fallen into the apparatus, the apparatus has been exposed to rain or moisture, does not operate normally, or has been dropped.
15. **CAUTION:** To reduce the risk of electric shock, do not use the polarized plug with an extension cord, receptacle, or other outlet unless the blades can be inserted completely to prevent blade exposure.

Installation, Care, and Service

Installation

Follow these recommendations and precautions and heed all warnings when installing your TV:

16. Never modify this equipment. Changes or modifications may void: a) the warranty, and b) the user's authority to operate this equipment under the rules of the Federal Communications Commission.
17.  **DANGER: RISK OF SERIOUS PERSONAL INJURY, DEATH, OR EQUIPMENT DAMAGE!** Never place the TV on an unstable cart, stand, or table. The TV may fall, causing serious personal injury, death, or serious damage to the TV.
18. Never place or store the TV in direct sunlight; hot, humid areas; areas subject to excessive dust or vibration; or locations with temperatures at or below 41 °F (5 °C).
19. Always place the TV on the floor or a sturdy, level, stable surface that can support the weight of the unit.
20. Never place items such as vases, aquariums, or candles on top of the TV.
21. Never block or cover the slots or openings in the TV cabinet back, bottom, and sides. Never place the TV:
 - on a bed, sofa, rug, or similar surface;
 - too close to drapes, curtains, or walls; or
 - in a confined space such as a bookcase, built-in cabinet, or any other place with poor ventilation.
 The slots and openings are provided to protect the TV from overheating and to help maintain reliable operation of the TV.
22. Never allow anything to rest on or roll over the power cord, and never place the TV where the power cord is subject to wear or abuse.
23. Never overload wall outlets and extension cords.
24. Always operate this equipment from a 120 VAC, 60 Hz power source only.
25. Always make sure the antenna system is properly grounded to provide adequate protection against voltage surges and built-up static charges (see Section 810 of the National Electric Code).

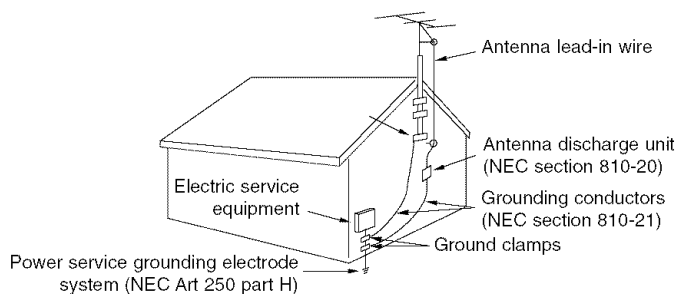

26.  **DANGER: RISK OF SERIOUS PERSONAL INJURY OR DEATH!**
 - Use extreme care to make sure you are never in a position where your body (or any item you are in contact with, such as a ladder or screwdriver) can accidentally touch overhead power lines. Never locate the antenna near overhead power lines or other electrical circuits.
 - Never attempt to install any of the following during lightning activity:
 - a) an antenna system; or b) cables, wires, or any home theater component connected to an antenna or phone system.

IMPORTANT SAFEGUARDS

(Continued)

Care

For better performance and safer operation of your TOSHIBA TV, follow these recommendations and precautions:

27. Always sit approximately 10 –25 feet away from the TV and as directly in front of it as possible. The picture can appear dull if you sit too far to the left or right of the TV, or if sunlight or room lights reflect on the screen. Turn the TV off to check for reflections on the screen, and then remove the source of reflections while viewing the TV.
28. Always unplug the TV before cleaning. Never use liquid or aerosol cleaners.
29.  **WARNING: RISK OF ELECTRIC SHOCK!**
Never spill liquids or push objects of any kind into the TV cabinet slots.
30. For added protection of your TV from lightning and power surges, always unplug the power cord and disconnect the antenna from the TV if you leave the TV unattended or unused for long periods of time.
31. During normal use, the TV may make occasional snapping or popping sounds. This is normal, especially when the unit is being turned on or off. If these sounds become frequent or continuous, unplug the power cord and contact a Toshiba Authorized Service Center.

Service

32.  **WARNING: RISK OF ELECTRIC SHOCK!** Never attempt to service the TV yourself. Opening and removing the covers may expose you to dangerous voltage or other hazards. Refer all servicing to a Toshiba Authorized Service Center.
33. If you have the TV serviced:
 - Ask the service technician to use only replacement parts specified by the manufacturer.
 - Upon completion of service, ask the service technician to perform routine safety checks to determine that the TV is in safe operating condition.
34. When the TV reaches the end of its useful life, ask a qualified service technician to properly dispose of the TV. The fluorescent lamp in the LCD panel contains a small amount of mercury.

Precautions

Notes on handling

- When shipping the unit, the original shipping carton and packing materials come in handy. For maximum protection, repack the unit as it was originally packed at the factory.
- Do not use volatile liquids, such as insect spray, near the unit. Do not leave rubber or plastic products in contact with the unit for a prolonged period. They will leave marks on the finish.
- The top and rear panels of the unit may become warm after a long period of use. This is not a malfunction.
- When the unit is not in use, be sure to remove any discs and turn off the power.
- The unit may not function properly if you do not use it for a long period of time. It is recommended that you turn the unit on occasionally to prevent potential problems in operation.

Notes on locating

- Place the unit on a level surface. Do not use it on a shaky or unstable surface such as a wobbling table or inclined stand. The loaded disc may become disaligned and damage the unit.
- When you place this unit near a TV, radio, or VCR, the playback picture may become poor and the sound may be distorted. In this case, place the unit away from the TV, radio, or VCR.

Notes on cleaning

Use a soft, dry cloth for cleaning.

- Do not use any type of solvent, such as thinner and benzene, as they may damage the surface of the unit.
- If you use a chemical saturated cloth to clean the unit, follow that product's instructions.

Notes on moisture condensation

Moisture condensation damages the unit. Please read the following carefully.

Moisture condensation occurs, for example, when you pour a cold drink into a glass on a warm day. Drops of water form on the outside of the glass. In the same way, moisture may condense on the optical pick-up lens inside this unit, one of the most crucial internal parts of the unit.

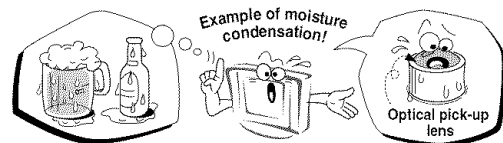

■ **Moisture condensation may occur in the following cases.**

- When you bring the unit directly from a cold place to a warm place.
- When you use the unit in a room where you just turned on the heater, or a place where the cold wind from the air conditioner directly hits the unit.
- In summer, when you use the unit in a hot and humid place just after you move the unit from an air conditioned room.
- When you use the unit in a humid place.

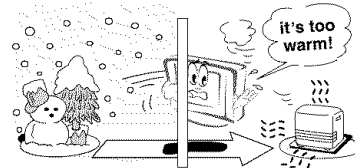

■ **Do not use the unit when moisture condensation may occur.**

If you use the unit in such a situation, it may damage discs and internal parts. Remove the disc, connect the power cord of the unit to the wall outlet, turn on the unit, and leave it for two or three hours. After two or three hours, the unit will have warmed up and evaporated any moisture. Keep the unit connected to the wall outlet and moisture condensation will seldom occur.

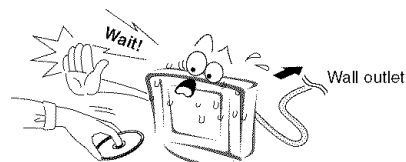

Notes on discs

On handling discs

- Do not touch the playback side of the disc.

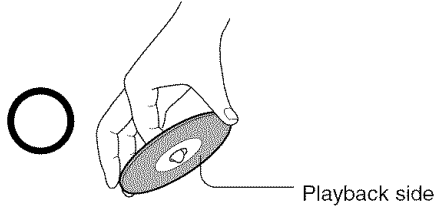

- Do not attach paper or tape to discs.



On cleaning discs

- Fingerprints and dust on the disc cause picture and sound deterioration. Wipe the disc from the center outwards with a soft cloth. Always keep the disc clean.

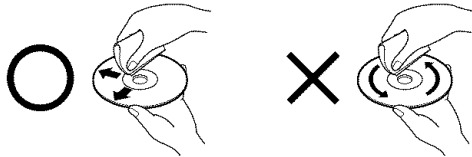

- Do not use any type of solvent such as thinner, benzene, commercially available cleaners or antistatic spray for vinyl LPs. It may damage the disc.

On storing discs

- Do not store discs in a place subject to direct sunlight or near heat sources.
- Do not store discs in places subject to moisture and dust such as a bathroom or near a humidifier.
- Store discs vertically in a case. Stacking or placing objects on discs outside of their case may cause warping.

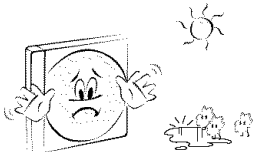

Structure of disc contents

Normally, DVD video discs are divided into titles, and the titles are sub-divided into chapters. Video CDs and Audio CDs are divided into tracks.

DVD video disc

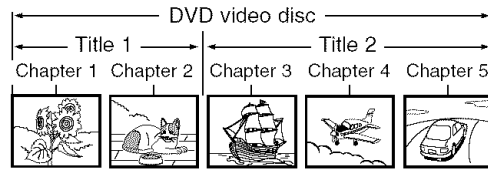

Video CD/Audio CD

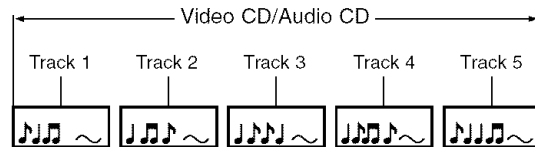

Each title, chapter or track is assigned a number, which is called "title number", "chapter number" or "track number" respectively.

There may be discs that do not have these numbers.

Notes

- If an MP3 or JPEG file CD is created using an incorrect method, the player may not be able to recognize it. If this happens, try reburning another CD after setting up the disc writing parameters correctly on your PC.
- Manufactured under license from Dolby Laboratories. Dolby and the double-D symbol are trademarks of Dolby Laboratories.
- DTS and DTS Digital Out are trademarks of Digital Theater Systems, Inc.

Notes on copyright

It is forbidden by law to copy, broadcast, show, broadcast on cable, play in public, and rent copyrighted material without permission.

DVD video discs are copy protected, and any recordings made from these discs will be distorted.

This product incorporates copyright protection technology that is protected by method claims of certain U.S. patents and other intellectual property rights owned by Macrovision Corporation and other rights owners.

Use of this copyright protection technology must be authorized by Macrovision Corporation, and is intended for home and other limited viewing uses only unless otherwise authorized by Macrovision Corporation. Reverse engineering or disassembly is prohibited.

Notes on region numbers

This DVD player is designed and manufactured for playback of region "1" encoded DVD software. The region code on the labels of some DVD discs indicates which type of player can play those discs. This unit can play only DVD discs labeled "1" or "ALL". If you try to play any other discs, the message "Check Regional Code" will appear on the TV screen. Some DVD discs may not have a region code label even though their playback is prohibited by area limits.



On Video CDs

This DVD supports Video CDs equipped with the PBC (Version 2.0) function. (PBC is the abbreviation of Playback Control.) You can enjoy two playback variations depending on types of discs.

- **Video CD not equipped with PBC function (Version 1.1)**

Sound and movie can be played on this DVD in the same way as an audio CD.

- **Video CD equipped with PBC function (Version 2.0)**

In addition to operation of a Video CD not equipped with the PBC function, you can enjoy playback of interactive software with search function by using the menu displayed on the TV screen (Menu Playback). Some of the functions described in this owner's manual may not work with some discs.

About this owner's manual

This owner's manual explains the basic instructions of this unit. Some DVD video discs are produced in a manner that allows specific or limited operation during playback. As such, the unit may not respond to all operating commands. This is not a defect in the unit. Refer to instruction notes of discs.

"⊗" may appear on the TV screen during operation. A "⊗" means that the operation is not permitted by the unit or the disc.

For example, sometimes it is unable to stop the playback of copyright message of the disc when the **STOP** button is pressed. Alternatively, the "⊗" may also indicate that the feature is not available for the disc.

Playable discs

This unit can play the following discs.

	Disc Mark	Contents	Disc Size	Maximum playback time
DVD video discs		Audio + Video (moving pictures)	12 cm	Approx. 4 hours (single sided disc)
				Approx. 8 hours (double sided disc)
			8 cm	Approx. 80 minutes (single sided disc)
				Approx. 160 minutes (double sided disc)
Video CDs		Audio + Video (moving pictures)	12 cm	Approx. 74 minutes
			8 cm	Approx. 20 minutes
Audio CDs		Audio	12 cm	Approx. 74 minutes
			8 cm (CD single)	Approx. 20 minutes

The following discs are also available.

- CD-R/CD-RW discs of CD-DA, Video CD, MP3, WMA or JPEG format
- Kodak Picture CD and FUJICOLOR CD format. Some of these discs may be incompatible.

- You cannot play discs other than those listed above.
- You cannot play discs of DVD-RAM, DVD-ROM, Photo CD, etc., or non standardized discs even if they may be labeled as above.
- Some CD-R/RWs can not be played back depending on the recording conditions.
- This unit uses the NTSC color system, and cannot play DVD video discs recorded in any other color system (PAL, SECAM, etc).

Because of problems and errors that can occur during the creation of DVD software and/or the manufacture of DVD discs, Toshiba America Consumer Products, Inc., and Toshiba of Canada, Ltd. cannot guarantee that this unit will play every feature of every DVD bearing the DVD logo. As one of the creators of DVD technology, this unit is manufactured to the highest standards of quality and, as a result, such incompatibilities are very rare. If you happen to experience and difficulty playing a DVD on this unit, please feel free to call our Contact listed in "How to Obtain Warranty Services" (page 51).

Contents

Introduction

IMPORTANT SAFEGUARDS.....	3
Precautions	5
Notes on discs.....	8
Contents	10
Identification of controls	11

Connections

External equipment connections	15
Antenna Connection & Cable without a Cable box	15
VCR Setup	16
Cable TV Setup	16
External A/V Source Setup.....	17
External DVD Setup.....	17
DTV Setup.....	18
Using Headphones.....	18
DVD Output Setup.....	18
PC Setup.....	19

TV operation

TV operation	20
Channel Menu Options.....	22
Picture Menu Options	24
Sound Menu Options	25
Time Menu Options	27
Special Menu Options	29
PC Menu Options	34

Antenna Connection & Cable without a Cable box

DVD&VCD operation

DVD&VCD operation	35
DVD Menu Options	39

MP3/WMA files Playback Options43

Audio CD Playback Options44

JPEG file viewing Options46

Others

Troubleshooting	47
Specifications	49
Limited warranty	50

Identification of controls

Front

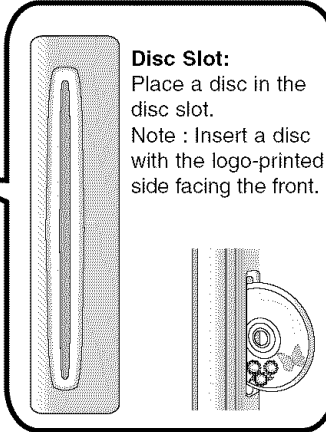
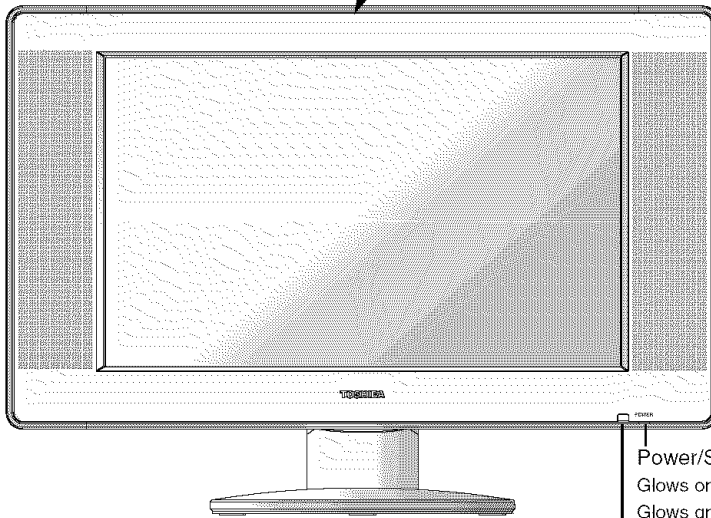
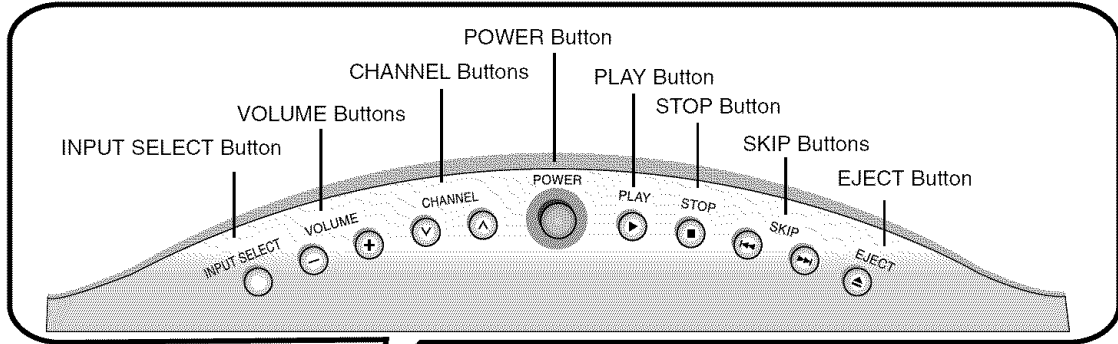

Power/Standby Indicator
Glow orange in Standby mode,
Glow green when the TV is turned on.

Remote Control Sensor

Side

Left Side

Right Side

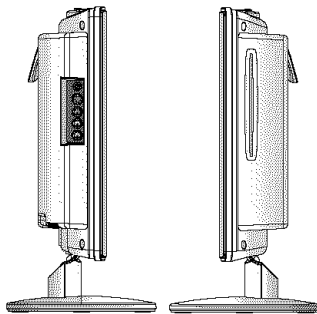

Adjusting the angle of the base

Approx. 10° 0° Approx. 3°

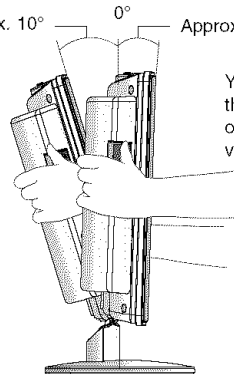

You can adjust the angle of the TV-screen by 3° forward or by 10° backward from vertical angle.

Identification of controls (Continued)

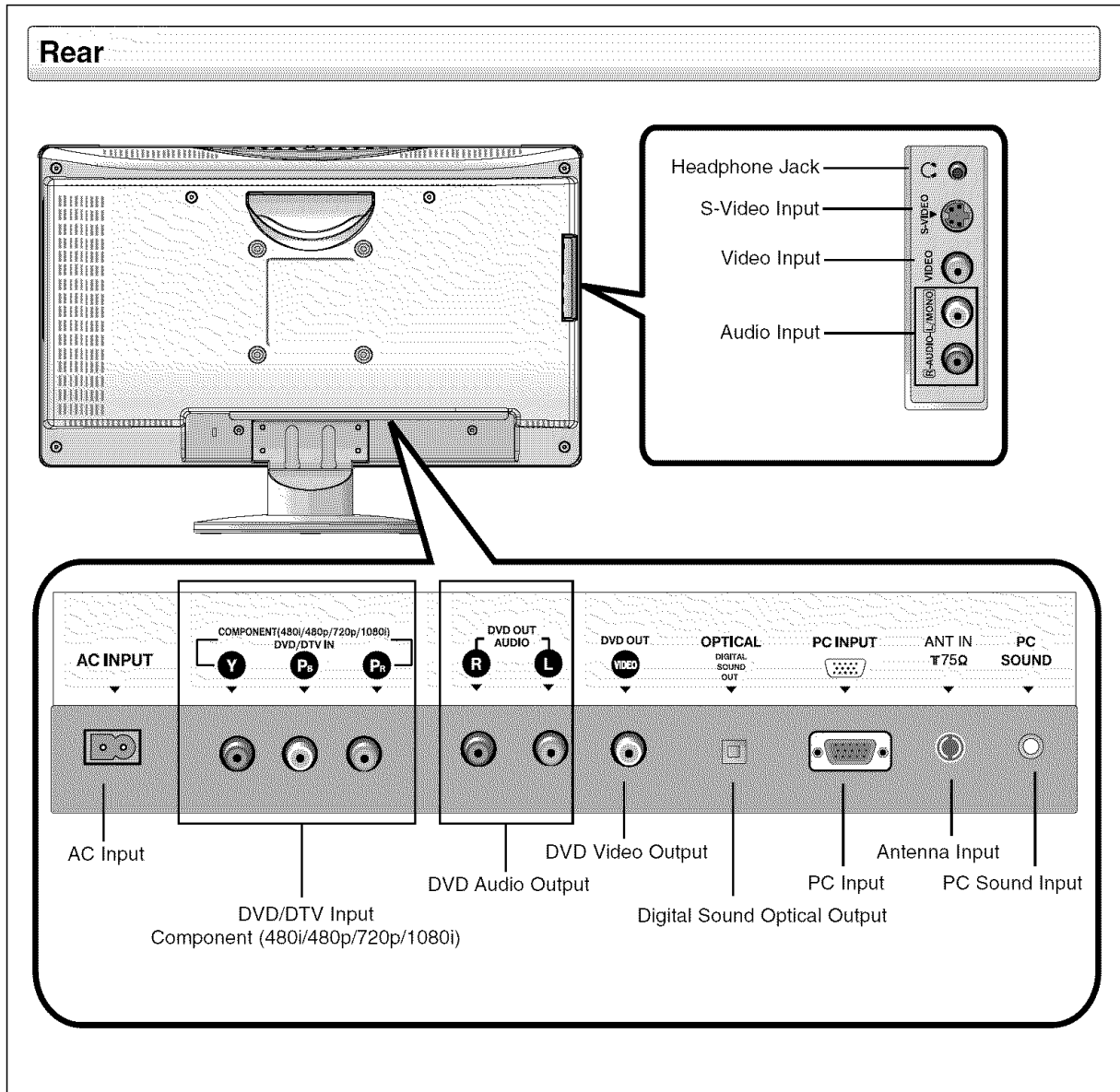

Remote control

The instructions in this manual describe the function on the remote control. See the page in  for details.

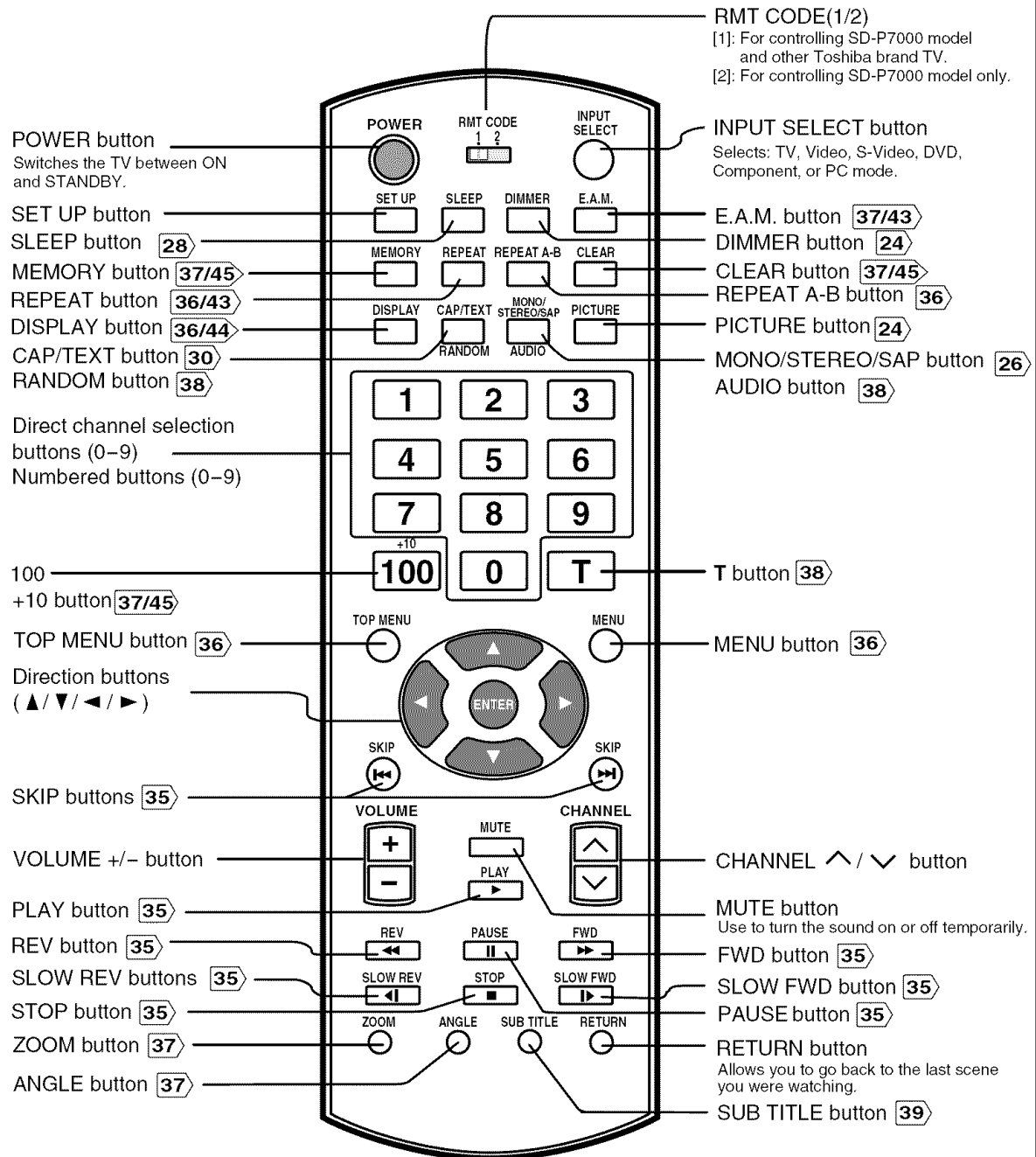

Inserting batteries

- 1** Slide the battery compartment cover in the direction of the arrow.

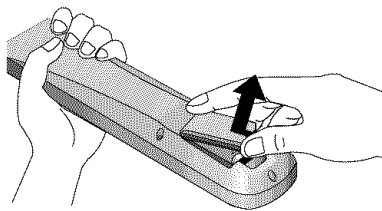

- 2** Install two “AA” batteries (supplied), paying attention to the polarity diagram in the battery compartment.

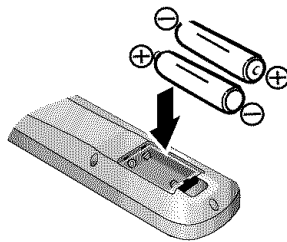

- 3** Replace the compartment cover.

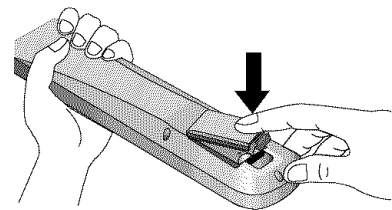

Operation

- Aim the remote control at the remote sensor and press control buttons to operate.
- Operate the remote control within 30° angle on either side of the remote sensor, up to a distance of approx. 7 meters (Approx. 21 feet).

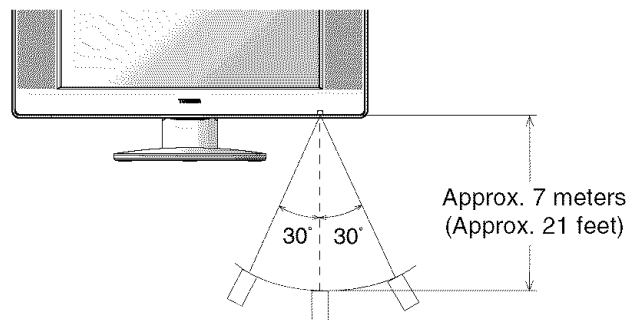

The precautions below should be followed when using batteries in this device:

1. Use only the size and type of batteries specified (AA type).
2. Be sure to follow the correct polarity when installing the batteries as indicated in the battery compartment. Reversed batteries may cause damage to the device.
3. Do not mix different types of batteries together (e.g. Alkaline and Carbon-zinc) or old batteries with fresh ones.
4. If the device is not to be used for a long period of time, remove the batteries to prevent damage or injury from possible battery leakage.
5. Do not try to recharge batteries not intended to be recharged; they can overheat and rupture (follow battery manufacturer's directions).
6. Dispose of used batteries in a designated disposal area. Do not throw batteries into a fire. Attention should be drawn to the environmental aspects of battery disposal.

External equipment connections

To prevent the equipment damage, never plug in any power cords until you have finished connecting all equipment.

Antenna Connection & Cable without a Cable box

- For optimum picture quality, adjust antenna direction.
- An antenna cable and converter are not supplied.

Connecting to an Inside Antenna Setup

- Typical wall antenna jack used in apartment buildings, connect the antenna cable as shown below. (Use the correct type of antenna cable for the type of wall antenna jack.)

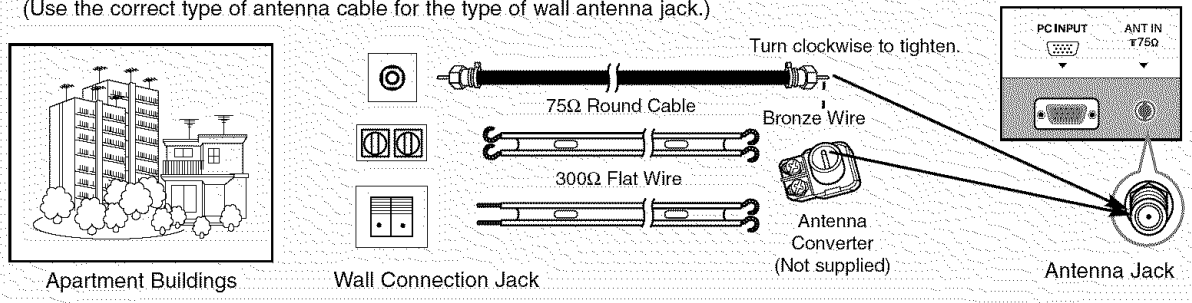

- If you have a 75Ω round cable, insert the bronze wire and then tighten the connection nut. If you have a 300Ω flat wire, connect the twisted wire to the antenna converter and then connect the converter to the antenna jack on the TV.
- If using 75Ω round cable, do not bend the bronze wire. It may cause poor picture quality.

Connecting to an Outside Antenna Setup

- This type of antenna is commonly used in single family dwellings.

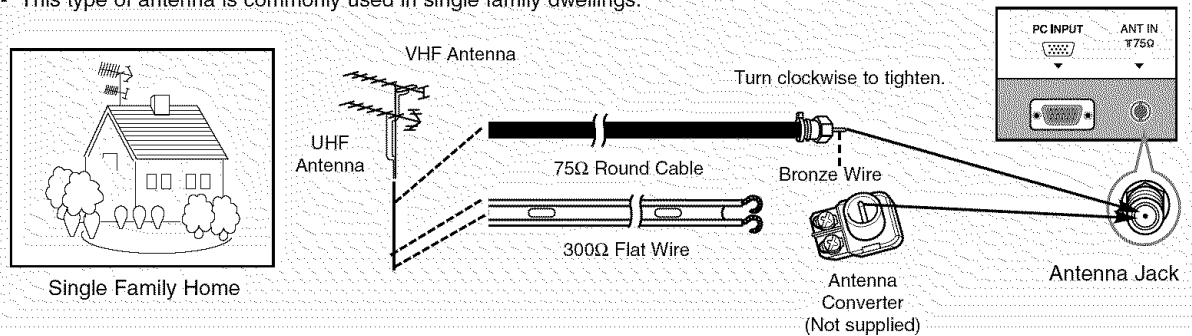

- In poor signal areas, to get better picture quality, install a signal amplifier to the antenna as shown to the right.
- If signal needs to be split for two TVs, use an antenna signal splitter for connection.

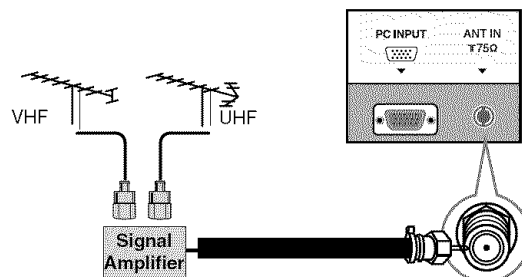

External equipment connections (Continued)

The connection cables are not supplied.

VCR Setup

Connection 1

Set VCR CH switch to 3 or 4 and then tune TV to the same channel number.

Connection 2

1. Connect the audio/video output jacks on the VCR to the corresponding input jacks on the TV. When connecting the TV to a VCR, match the jack colors (Video = yellow, Audio Left = white, and Audio Right = red).
2. Insert a video tape into the VCR and press PLAY on the VCR. (Refer to the VCR owner's manual.)
3. Use the **INPUT SELECT** button on the remote control to select **Video**. (If connected to S-VIDEO on the side panel, select the **S-Video** external input source.)

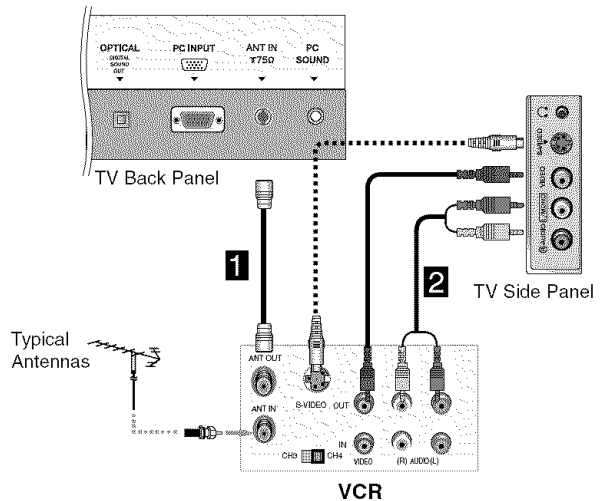

Cable TV Setup

- After subscribing to a local cable TV service and installing a converter, you can watch cable TV programming.
- For further cable TV information, contact your local cable service provider.

Connection 1

1. Select channel 3 or 4 with the channel switch on the cable box.
2. Tune the TV channel to the same selected output channel of the cable box.
3. Select channels at the cable box or with the cable box remote control.

Connection 2

1. Connect the audio/video output jacks on the Cable Box to the corresponding input jacks on the TV. When connecting the TV to the Cable Box, match the jack colors (Video = yellow, Audio Left = white, and Audio Right = red).
2. Use the **INPUT SELECT** button on the remote control to select **Video**.
3. Select channels using the cable box remote control.

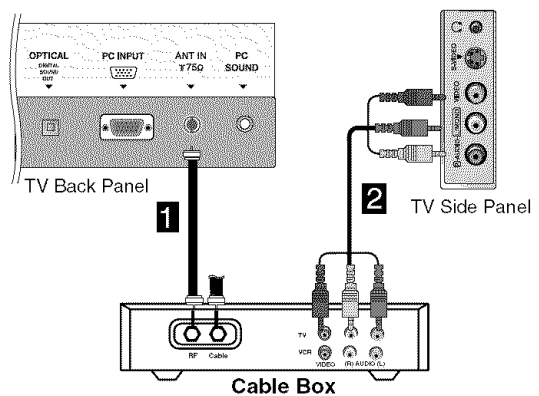

External A/V Source Setup

Connections

Connect the audio/video output jacks on the external A/V equipment to the corresponding input jacks on the TV. When connecting the TV to external A/V equipment, match the jack colors (Video = yellow, Audio Left = white, and Audio Right = red).

Viewing Setup

1. Turn on the external A/V equipment.
2. Use the **INPUT SELECT** button on the remote control to select **Video**.
3. Operate the corresponding external equipment. Refer to the external equipment operating guide.

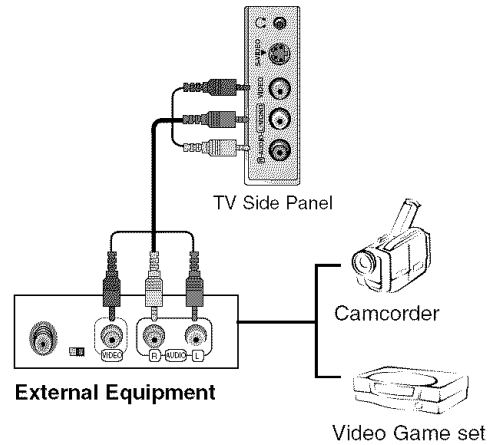

Connections

External DVD Setup

- This TV can play a DVD without a separate DVD player. However, if you want to watch a DVD from a separate DVD player, refer to the figure as shown on the right.

Connections

Connect the DVD video outputs to the COMPONENT (Y, Pb, Pr) jacks and connect the DVD audio outputs to the AUDIO jacks.

Viewing Setup

1. Turn on the DVD player, insert a DVD disc.
2. Use the **INPUT SELECT** button on the remote control to select **Component**.
3. Refer to the DVD player's manual for operating instructions.

• Component Input ports

To get better picture quality, connect a DVD player to the component input ports as shown below.

Component ports of the TV	Y	Pb	Pr
---------------------------	---	----	----

Video output ports of DVD player	Y	Pb	Pr
	Y	B-Y	R-Y
	Y	Cb	Cr
	Y	PB	PR

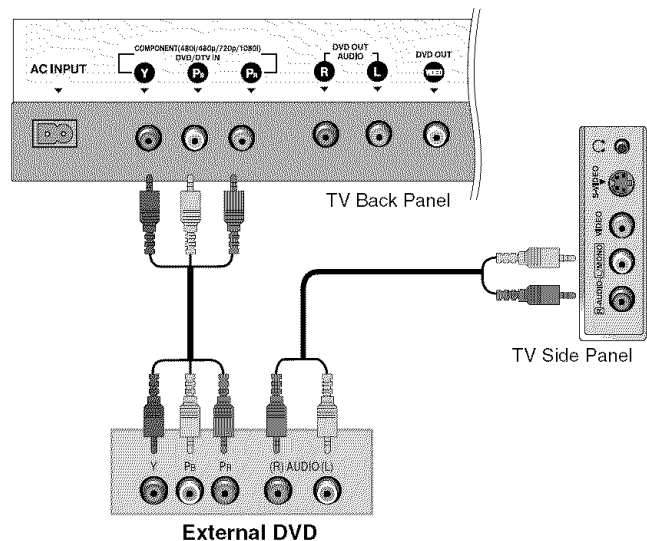

Connecting to optional equipment (Continued)

DTV Setup

- To watch digitally broadcast programs, purchase and connect a digital set-top box.

Connections

Connect the digital set-top box video outputs to the COMPONENT (Y, PB, PR) jacks and connect the digital set-top box audio outputs to the AUDIO jacks.

Viewing Setup

1. Turn on the digital set-top box. (Refer to the owner's manual for the digital set-top box.)
2. Use the **INPUT SELECT** button on the remote control to select **Component**.

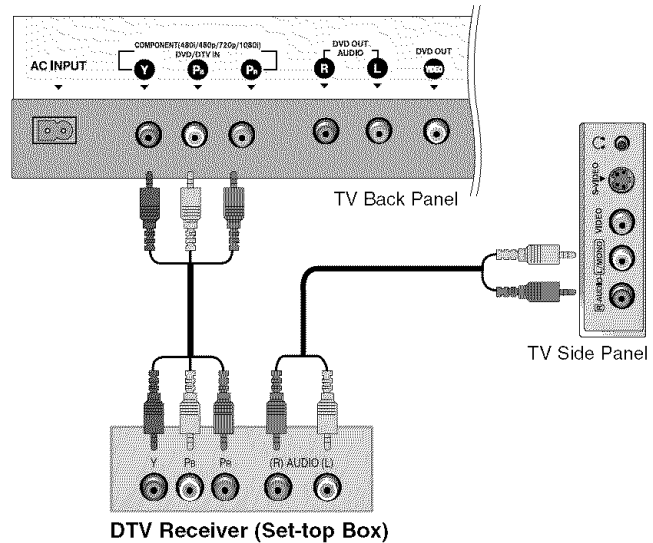

Using Headphones

- Plug headphones into the H/P jack as shown.
- Adjust the sound level of the headphone using the VOLUME (+, -) buttons. While you are listening through a headphone(s), TV speakers will not be heard.

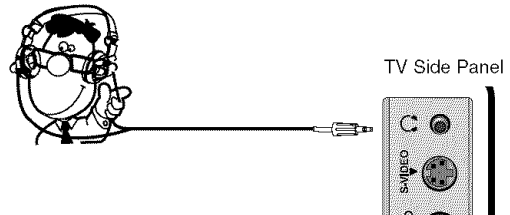

DVD Output Setup

The TV has a special signal output capability which allows you to hook up a second TV or monitor.

Connect the second TV or monitor to the TV's DVD OUTPUT and OPTICAL DIGITAL SOUND OUT jack. (See the Operating Manual of the second TV or monitor for further details regarding that device's input settings.)

- Notes:
- If your second TV or monitor has no optical digital audio input jack, it's impossible to use DVD digital sound output.
 - Do not look into the optical output port. Looking at the laser beam may damage your vision.
 - If your external audio equipment has a digital audio input optical port, you can connect it to your TV.

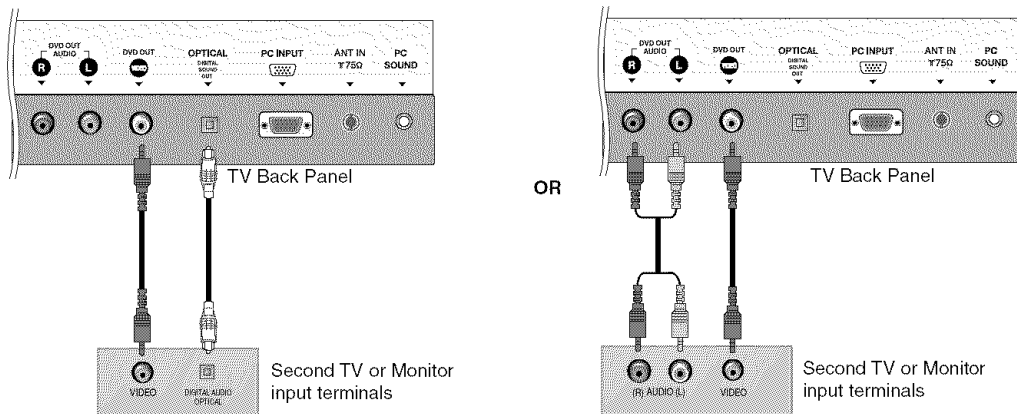

PC Setup

- After setup, be sure to select RGB-PC source on TV.

Connections

1. Set the monitor output resolution on the PC before connecting to the TV.
2. Connect the TV to the PC with the PC cable.
3. Connect the PC audio output to the TV's PC SOUND input.

Viewing Setup

1. Turn on the PC.
2. Use the **INPUT SELECT** button on the remote control to select **PC**.

Monitor Display Specifications

Resolution	Horizontal Frequency(kHz)	Vertical Frequency(Hz)
640x480	31.47	60
	35.00	66.67
	37.50	75
800x600	35.16	56.25
	37.88	60
	48.08	72.19
	46.88	75
1024x768	48.36	60
	56.48	70
	60.02	75
1280x768	47.78	60

NOTES

- a. For optimum picture quality, use standard WXGA (1280x768) computer output at a 60Hz refresh rate. Using other formats (VGA, SVGA, etc.) or refresh rates may result in reduced picture quality. (To change the computer video output format, please refer to the operating manual for the computer you are using).
- b. If the message "**Out of range**" appears on the screen, adjust the PC output to a format listed in the 'Displayable Monitor Output Format Specifications' chart above.
- c. The synchronization input form for Horizontal and Vertical frequencies is separate.

DPM (Display Power Management) mode

If the PC goes to power saving mode, the monitor automatically switches to DPM mode.

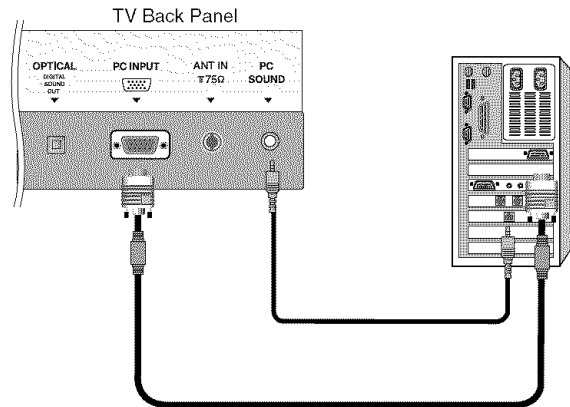

TV Operation

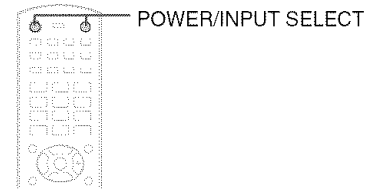

TV Operation Overview

1 First, make all equipment connections. Connect the AC power cord into the TV, then plug the power cord into a wall outlet. Press the **POWER** button located on the TV to turn on the TV. The power indicator will light.

- In the standby mode, press the **POWER**, **CHANNEL**, **INPUT SELECT** or number buttons on the remote control to turn on the TV.

2 Select the viewing source by pressing **INPUT SELECT** repeatedly.

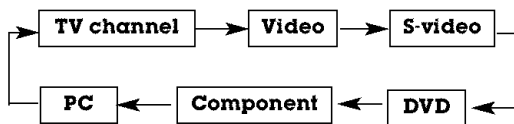

Note:
See page 22 if you have not auto programmed the TV to receive channels in your local broadcast area.

3 After viewing, press the **POWER** button on the remote control. The TV reverts to standby mode.

Note:
If you want to turn the TV off, press the **POWER** button located on the remote control. If you intend to be away on vacation, disconnect the plug from the wall outlet.

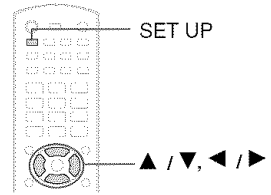

Menu Language Selection

- 1 Press the **SET UP** button and then use the **▲ / ▼** buttons to select the **Special** menu.

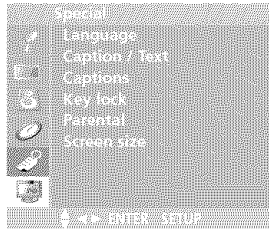

- 2 Press the **▶** button and then use the **▲ / ▼** buttons to select **Language**.

- 3 Press the **▶** button and then use the **▲ / ▼** buttons to select your desired language from **English**, **Español** or **Français**.
From this point on, the on-screen menus will be shown in the language of your choice.

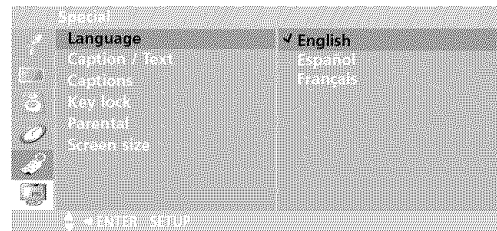

- 4 Press the **SET UP** button to save and return to TV viewing.

Channel Menu Options

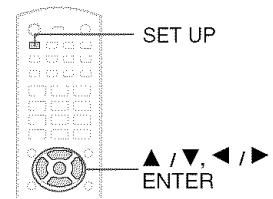

Antenna Setup

1 Press the **SET UP** button and then use the **▲/▼** buttons to select the **Channel** menu.

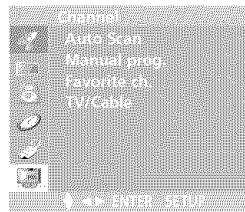

2 Press the **▶** button and then use the **▲/▼** buttons to select **TV/Cable**.

3 Press the **▶** button and then use the **▲/▼** buttons to select **TV** or **CATV**.

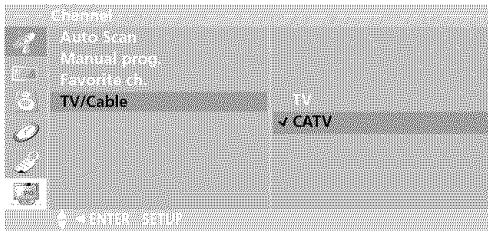

4 Press the **ENTER** button to save.

Memorizing the Channels with Auto Scan

- For Auto program to work, the programming source must be connected to the TV and the TV must be receiving programming signals either over-the-air or from a cable-type service provider.

1 Press the **SET UP** button and then use the **▲/▼** buttons to select the **Channel** menu.

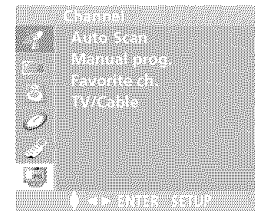

2 Press the **▶** button and then use the **▲/▼** buttons to select **Auto Scan**.

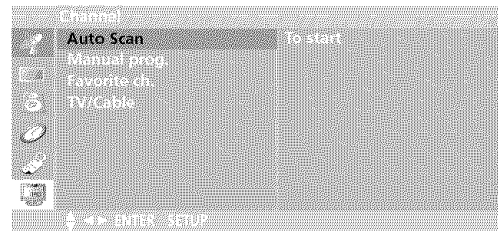

3 Press the **▶** button to begin the channel search.

- Wait for auto program to complete the channel search cycle before choosing a channel. The TV scans for over-the-air channels and then channels provided by a cable service.

Note:

- When the channel search is complete, use the **▲/▼** buttons to review the memorized channels.
- If you press the **ENTER** button in auto programming, the function will stop and only channels programmed up to that time will remain.
- Auto program function can memorize only the channels which are being received at that time.

Add/Delete Channels with Manual Program

- You can manually include or erase individual channels.

- 1 Press the **SET UP** button and then use the **▲ / ▼** buttons to select the **Channel** menu.



- 2 Press the **▶** button and then use the **▲ / ▼** buttons to select **Manual prog.**

- 3 Press the **▶** button and then use the **◀ / ▶** buttons to select a channel you want to add to memory or erase.

The current channel number is displayed.

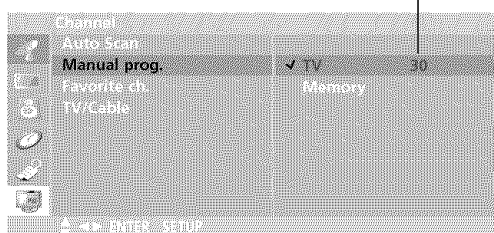

- 4 Press the **▼** button and then use the **◀ / ▶** buttons to select **Memory** (add) or **Erase** (delete).

- 5 Press the **ENTER** button to save. The current channel is added to Memory or Erased from the channel list.

Favorite Channels Setup

- Favorite Channel lets you quickly tune in up to 8 of your choice without having to wait for the TV to scan through all the in-between channels.

- 1 Press the **SET UP** button and then use the **▲ / ▼** buttons to select the **Channel** menu.

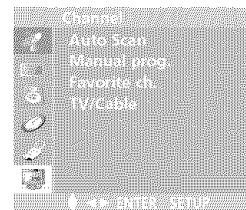

- 2 Press the **▶** button and then use the **▲ / ▼** buttons to select **Favorite ch.**

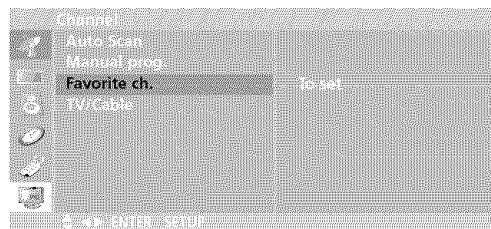

- 3 Press the **▶** button and then use the **▲ / ▼** buttons to select the first favorite channel position.

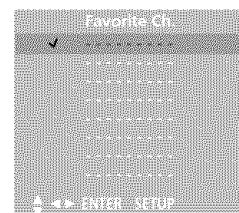

- 4 Use the **◀ / ▶** buttons to set the desired channel number for the first favorite channel.

- 5 Repeat steps 3 to 4 to memorize other channels.

- 6 Press the **ENTER** button to save.

Picture Menu Options

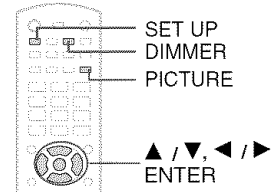

Dimmer

Press the **DIMMER** button repeatedly to select the brightness setup option as shown below.

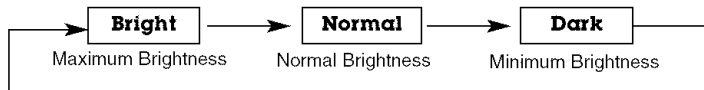

Manual Picture Control (User option)

- You can adjust picture contrast, brightness, color, sharpness and tint to the levels you prefer.

- 1 Press the **SET UP** button and then use the **▲ / ▼** buttons to select the **Picture** menu.

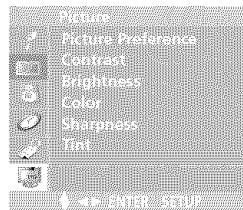

- 2 Press the **▶** button and then use the **▲ / ▼** buttons to select the desired picture option (**Contrast**, **Brightness**, **Color**, **Sharpness**, **Tint**).

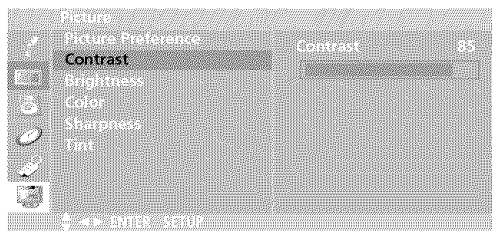

- Press the **PICTURE** button and you can also adjust these picture options.

- 3 Use the **◀ / ▶** buttons to make appropriate adjustments.

- Contrast, Brightness, Color, and Sharpness are adjustable from 0 to 100.
- Tint is adjustable from Red 50 to Green 50.

- 4 Press the **ENTER** button to save.

Sound Menu Options

Preset Equalizer

- This function lets you enjoy the high quality sound by simply selecting the sound format that matches the program content.

- 1 Press the **SET UP** button and then use the **▲ / ▼** buttons to select the **Sound** menu.

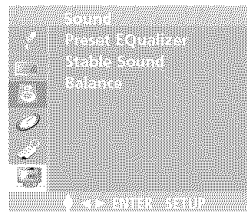

- 2 Press the **▶** button and then use the **▲ / ▼** buttons to select **Preset Equalizer**.

- 3 Press the **▶** button and then use the **▲ / ▼** buttons to select the appropriate sound option; **Flat, Music, Movie, Sports**.

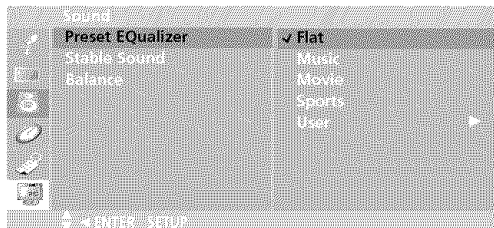

- 4 Press the **ENTER** button to save.

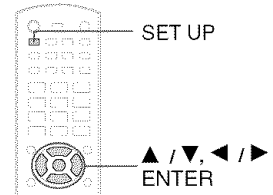

Equalizer Adjustments

- 1 Press the **SET UP** button and then use the **▲ / ▼** buttons to select the **Sound** menu.



- 2 Press the **▶** button and then use the **▲ / ▼** buttons to select **Preset Equalizer**.

- 3 Press the **▶** button and then use the **▲ / ▼** buttons to select **User**.

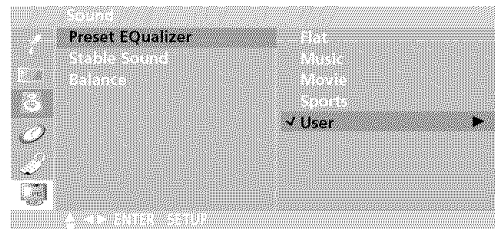

- 4 Press the **▶** button and then use the **◀ / ▶** buttons to select the band you want to adjust. Then, use the **▲ / ▼** buttons to adjust the band level.

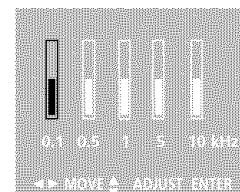

- 5 Press the **ENTER** button to save.

Sound Menu Options (Continued)

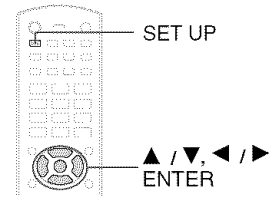

StableSound™

- **StableSound™** maintains an equal volume level automatically even if the channel is changed.

1 Press the **SET UP** button and then use the **▲ / ▼** buttons to select the **Sound** menu.

2 Press the **▶** button and then use the **▲ / ▼** buttons to select **Stable Sound**.

3 Press the **▶** button and then use the **▲ / ▼** buttons to select **On** or **Off**.

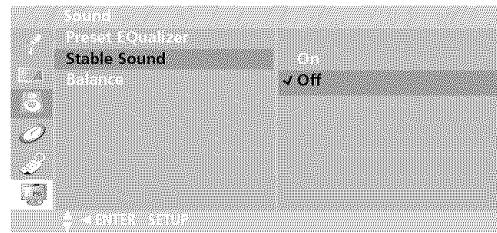

4 Press the **ENTER** button to save.

Sound Balance

1 Press the **SET UP** button and then use the **▲ / ▼** buttons to select the **Sound** menu.

2 Press the **▶** button and then use the **▲ / ▼** buttons to select **Balance**.

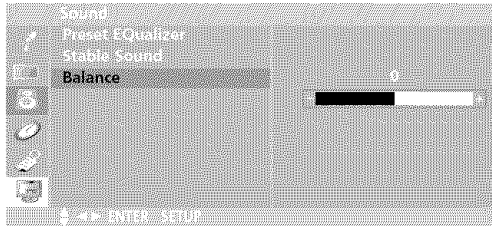

3 Press the **▶** button and then use the **◀ / ▶** buttons to adjust the sound balance.

- Balance is adjustable from Left 50 to Right 50.

4 Press the **ENTER** button to save.

MONO/STEREO/SAP

- The TV can receive MTS stereo programs and any SAP (Secondary Audio Program) that accompanies the stereo program, if the broadcaster transmits an additional sound signal as well as the original one.
- Mono: The primary language is heard from left and right speakers. Signal mode is mono.
- Stereo: The primary language is heard from left and right speakers. Signal mode is stereo.
- SAP: The secondary language is heard from left and right speakers.

1. Press the **MONO/STEREO/SAP** button repeatedly.

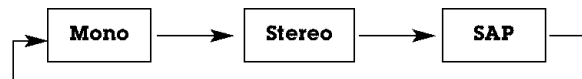

- Select mono sound mode if the signal is not clear or in poor signal reception areas.
- **Stereo**, **SAP** mode are available only if included on the broadcast signal.

Time Menu Options

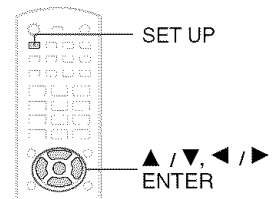

Auto Clock Setup

- The time is set automatically through from a PBS broadcast signal.
- The PBS channel signal includes information for the correct time and daylight saving time.

1 Press the **SET UP** button and then use the **▲ / ▼** buttons to select the **Timer** menu.

2 Press the **▶** button and then use the **▲ / ▼** buttons to select **Clock**

3 Press the **▶** button and then use the **▲ / ▼** buttons to select **Auto**.

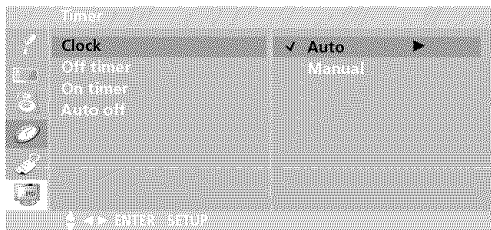

4 Press the **▶** button and then use the **▲ / ▼** buttons to select the time zone for your viewing area. Your choices are: **Auto**, **E.S.T.** (Eastern Standard Time), **C.S.T.** (Central Standard Time), **M.S.T.** (Mountain Standard Time), **P.S.T.** (Pacific Standard Time), **Alaska**, and **Hawaii**.

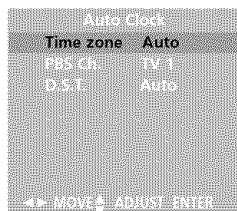

5 Press the **▶** button and then use the **▲ / ▼** buttons to set **PBS channel**.

6 Press the **▶** button and then use the **▲ / ▼** buttons to set **D.S.T.** (Daylight Savings Time) **Auto**, **Off** or **On**, depending on whether or not your viewing area observes Daylight Savings Time.

7 Press the **ENTER** button to save.

Manual Clock Setup

- If the time on the clock is incorrect, reset the clock manually.

1 Press the **SET UP** button and then use the **▲ / ▼** buttons to select the **Timer** menu.

2 Press the **▶** button and then use the **▲ / ▼** buttons to select **Clock**

3 Press the **▶** button and then use the **▲ / ▼** buttons to select **Manual**.

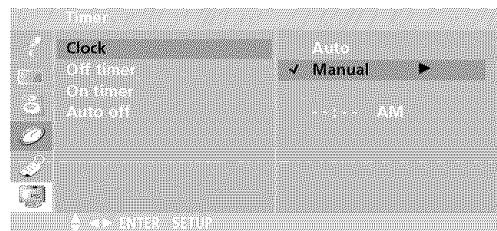

4 Press the **▶** button and then use the **▲ / ▼** buttons to set the hour.

5 Press the **▶** button and then use the **▲ / ▼** buttons to set the minutes.

6 Press the **ENTER** button to save.

Time Menu Options (Continued)

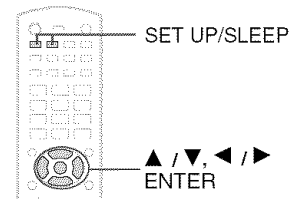

On/Off Timer Setup

- Timer function operates only if the current time is set.
- Off-Timer function overrides On-Timer function if they are set to the same time.
- The TV must be in standby mode for the On-Timer to work.
- If you don't press any button within 2 hours after turning on the TV with the On-Timer function, the TV will automatically revert to standby mode.

1 Press the **SET UP** button and then use the **▲/▼** buttons to select the **Timer** menu.

2 Press the **▶** button and then use the **▲/▼** buttons to select **Off timer** or **On timer**.

3 Press the **▶** button and then use the **▲/▼** buttons to set the hour.

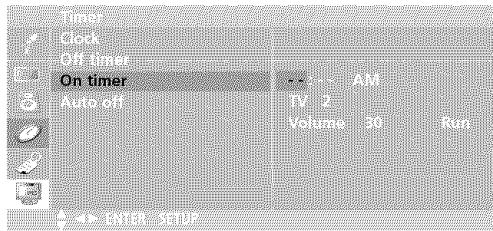

4 Press the **▶** button and then use the **▲/▼** buttons to set the minutes.

5 **For On timer function only:** Press the **▶** button and then use the **▲/▼** buttons to set the channel at turn-on. Then, press the **▶** button and then use the **▲/▼** buttons to set the turn-on sound level.

6 Press the **▶** button and then use the **▲/▼** buttons to select **Run** or **Hold**.

- **Hold:** **Off timer/On timer** will not work.
- **Run:** **Off timer/On timer** are active.

You need to select **Run** to activate **Timer** setup.

7 Press the **ENTER** button to save.

Auto Off

- If Auto Off is active and there is no input signal, the TV switches to Standby mode automatically after 10 minutes.

1 Press the **SET UP** button and then use the **▲/▼** buttons to select the **Timer** menu.

2 Press the **▶** button and then use the **▲/▼** buttons to select **Auto off**.

3 Press the **▶** button and then use the **▲/▼** buttons to select **On** or **Off**.

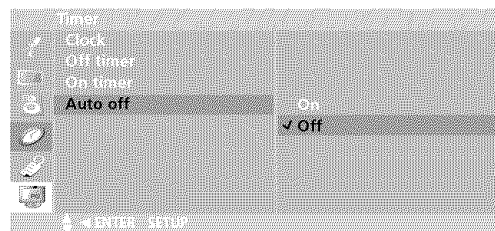

4 Press the **ENTER** button to save.

Sleep Timer Setup

- The Sleep Timer turns the TV off at a preset time.
- The Sleep Timer do not function in PC mode.

1 Press the **SLEEP** button repeatedly to select the number of minutes. First the **Sleep ---** option appears on the screen, followed by the following sleep timer options: 10, 20, 30, 60, 90, 120, 180, and 240 minutes.

2 When the number of minutes you want is displayed on the screen, press the **ENTER** button. The timer begins to count down from the number of minutes selected.

3 To check the remaining minutes before the TV turns off, press the **SLEEP** button once.

4 To cancel the Sleep Timer, press the **SLEEP** button repeatedly until **Sleep ---** appears.

Special Menu Options

Closed Captions

Closed captioning is a process which converts the audio portion of a television program into written words which then appear as subtitles on the television screen. Closed captions allow viewers to read the dialogue and narration of television programs.

Using Closed Captions

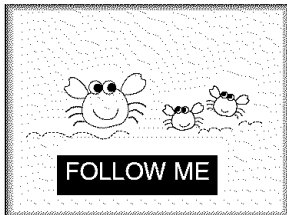

Captions are the subtitles of the dialogue and narration of television programs. For prerecorded programs, program dialogue can be arranged into captions in advance. Its possible to caption a live program by using a process called real-time captioning, which creates captions instantly. Real-time captioning is normally done by professional reporters using a machine shorthand system and computer for translation into English.

Captioning is an effective system for the hearing-impaired, and it can also aid in teaching language skills.

- The picture at left shows a typical caption.

Caption Tips

- Not all TV broadcasts include closed caption signals.
- Sometimes TV stations broadcast four different caption signals on the same channel. By selecting **From CC 1 to CC 4**, you can choose which signal you view. **CC 1** is usually the signal with the captions, while **Another mode** might show demonstration or programming information.
- Your TV might not receive caption signals normally in the following situations.

1. Poor reception conditions are encountered:



- **IGNITION:**
Picture may flutter, drift, suffer from black spots, or horizontal streaking. Usually caused by interference from automobile ignition systems, neon lamps, electrical drills, and other electrical appliances.



- **GHOSTS:**
Ghosts are caused when the TV signal splits and follows two paths. One is the direct path and the other is reflected off tall buildings, hills or other objects. Changing the direction or position of the antenna may improve reception.



- **SNOW:**
If your receiver is located at the weak, fringe area of a TV signal, your picture may be marred by small dots. It may be necessary to install a special antenna to improve the picture.

2. An old, bad, or illegally recorded tape is being played.
3. Strong, random signals from a car or airplane interfere with the TV signal.
4. The signal from the antenna is weak.
5. The program wasn't captioned when it was produced, transmitted, or taped.

Special Menu Options (Continued)

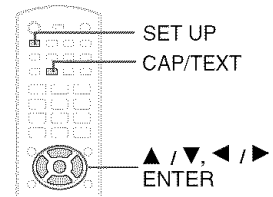

Caption/Text

1 Press the **SET UP** button and then use the **▲ / ▼** buttons to select the **Special** menu.

2 Press the **▶** button and then use the **▲ / ▼** buttons to select **Caption / Text**.

3 Press the **▶** button and then use the **▲ / ▼** buttons to select caption: **CC1**, **CC2**, **CC3**, **CC4**, **Text1**, **Text2**, **Text3**, or **Text4**.

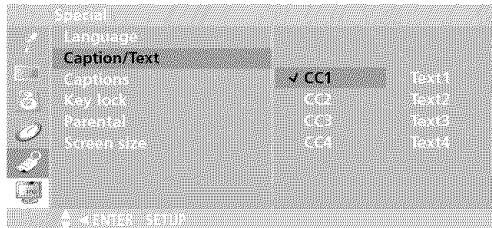

• CAPTION

The term for the words that scroll across the bottom of the TV screen; usually the audio portion of the program provided for the hearing impaired.

• TEXT

The term for the words that appear in a large black frame and almost cover the entire screen; usually messages provided by the broadcaster.

4 Press the **ENTER** button to save.

Captions

1 Press the **SET UP** button and then use the **▲ / ▼** buttons to select the **Special** menu.

2 Press the **▶** button and then use the **▲ / ▼** buttons to select **Captions**.

3 Press the **▶** button and then use the **▲ / ▼** buttons to select Caption **On**, **Closed Caption Mute**, or **Off**.

• **Closed Caption Mute** shows the selected captions option (if available on program) when the TV sound is muted.

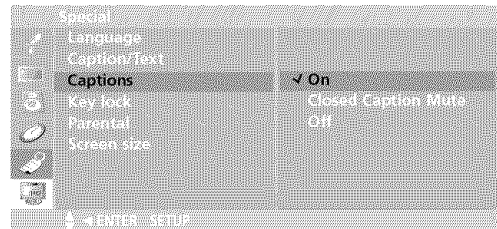

You can also press the **CAP/TEXT** button repeatedly to select Caption **On**, **Closed Caption Mute**, or **Off**.

4 Press the **ENTER** button to save.

Key Lock

- The TV can be set up so that it can only be used with the remote control.
- This feature can prevent unauthorized viewing.

1 Press the **SET UP** button and then use the **▲ / ▼** buttons to select the **Special** menu.

2 Press the **▶** button and then use the **▲ / ▼** buttons to select **Key lock**

3 Press the **▶** button and then use the **▲ / ▼** buttons to select **On** or **Off**.

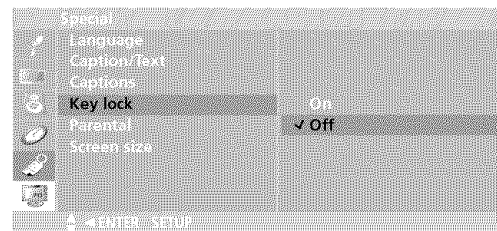

4 Press the **ENTER** button to save.

Lock options

Parental Control can be used to block specific channels, ratings and other viewing sources.

The Parental Control Function (V-Chip) is used to block program viewing based on the ratings sent by the broadcast station. The default setting is to allow all programs to be viewed. Viewing can be blocked by the type of program and by the categories chosen to be blocked. It is also possible to block all program viewing for a time period. To use this function, the following must be set :

1. Ratings and categories to be blocked.
2. Set a password
3. Enable the lock

V-Chip rating and categories

Rating guidelines are provided by broadcast stations. Most television programs and television movies can be blocked by TV Rating and/or Individual Categories. Movies that have been shown at the theaters or direct-to-video movies use the Movie Rating System (MPAA) only.

For Movies previously shown in theaters :

Movie Ratings :

- Unblocked
- G and Above (general audience)
- PG and Above (parental guidance suggested)
- PG-13 and Above (13 years and older)
- R and above (restricted)
- NC-17 and Above (18 years and older)
- X (adult)

If you set PG-13 and Above : G and PG movies will be available , PG-13, R, NC-17 and X will be blocked.

For Television programs including made-for-TV movies:

General TV Ratings:

- Unblocked
- TV-G and Above (general audience) (individual categories do not apply)
- TV-PG and Above (parental guidance suggested)
- TV-14 and Above (14 years and older)
- TV-MA (mature audience)

Children TV Ratings:

- Unblocked
- TV-Y and Above (youth) (individual content categories do not apply)
- TV-Y7 (youth, 7 years and up)

Content Categories:

- Dialog - sexual dialogue (applies to TV-PG and Above, TV-14)
- Language - adult language (applies to TV-PG and Above, TV-14 and Above, TV-MA)
- Sex scenes - sexual situations (applies to TV-PG and Above, TV-14 and Above, TV-MA)
- Violence (applies to TV-PG and Above, TV-14 and Above, TV-MA)
- F Violence - fantasy violence (applies only to TV-Y7)

For Canadian English/French language rating system:

Canadian English language rating system:

- C and Above (Children)
- C8+ (8 years and older)
- G and Above (General programming. Suitable for all audiences.)
- PG and Above (Parental guidance suggested)
- 14+ (Viewer 14 years and older)
- 18+ (Adult programming)

Canadian French language rating system:

- G and Above (General)
- 8 ans+ (8 years and older)
- 13 ans+ (13 years and older)
- 16 ans+ (16 years and older)
- 18 ans+ (Adults only)

Special Menu Options (Continued)

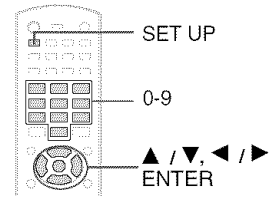

Lock Menu Setup

1 Press the **SET UP** button and then use the **▲ / ▼** buttons to select the **Special** menu.

2 Press the **▶** button and then use the **▲ / ▼** buttons to select **Parental**. Then, press the **▶** button.

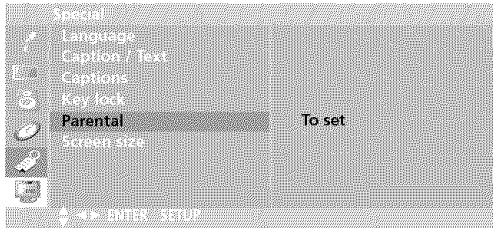

- If **Lock** is already set, enter the password requested.
- The TV is set with the initial password "0-0-0-0".

3 **Setting Lock on/off:**
 Press the **▲ / ▼** buttons to select **Lock on/off**. Press the **▶** button and then use the **▲ / ▼** buttons to select **on** or **off**.

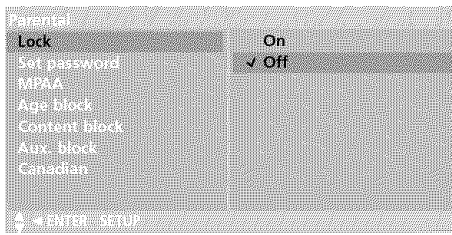

4 **Set password:**
 Press the **▲ / ▼** buttons to select **Set password**. Press the **▶** button and then enter a four digit password. Enter it again when requested.

5 Press the **▲ / ▼** buttons to select type of blocking to be set .

6 Press the **▶** button and then use the **▲ / ▼** buttons to select type of ratings to block .

- **Age block**, and **Content block**, and **Canadian** menus, also have sub menus. So, repeat steps 4 and 5 in the sub menu, to set the types of blocking and ratings.

Note:
 If you ever forget your password, key in '7', '7', '7', '7' on the remote control.

Screen Size Setup

- You can watch TV in various picture formats; **4:3, Wide**.

• **4:3**

This is the format 4 measure to 3 measures (square) of most general TV content.

• **Wide**

You can enjoy widescreen formatted movies or general TV programs with the 16:9 mode. The screen itself is 16:9 (16 measure to 9 measures), and content that is not formatted in the widescreen format, will be stretched on the left and right to fill the entire screen.



• **4:3**

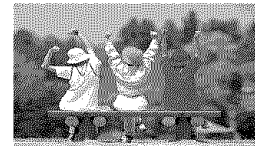

• **Wide**

- 1** Press the **SET UP** button and then use the **▲ / ▼** buttons to select the **Special** menu.

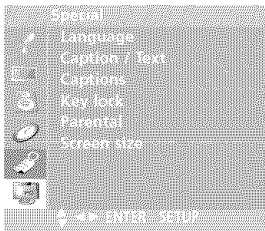

- 2** Press the **▶** button and then use the **▲ / ▼** buttons to select **Screen size**.

- 3** Press the **▶** button and then use the **▲ / ▼** buttons to select **4:3** or **Wide**.

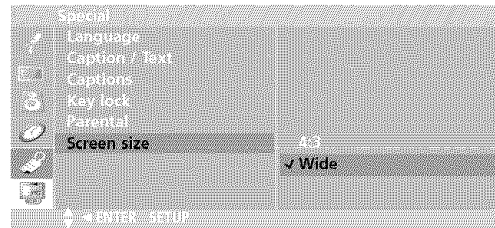

- 4** Press the **ENTER** button to save.

PC Menu Options

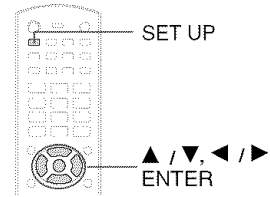

PC menu

- After setup, be sure to select PC source to see the PC image the on TV screen.

1 Press the **SET UP** button and then use the **▲/▼** buttons to select the **PC** menu.

2 Press the **▶** button and then use the **▲/▼** buttons to select desired item.

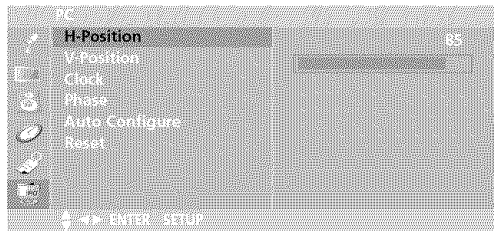

3 Use the **◀/▶** buttons to make appropriate adjustments.

- H-position/V-position
Adjusts picture left/right and up/down. The adjustment ranges of H-Position is 0~100. (Based on the input mode, the adjustable range may change.)
- Clock
Minimizes any vertical bars or stripes appearing on the screen background. The adjustment range is 0~100. (Based on the input mode, the adjustable range may change.)
- Phase
Reduces (or Minimizes) any horizontal noise and clear up or sharpen the character images. The range adjustment is 0~100. (Based on the input mode, the adjustable range may change.)
- Auto-configure
Automatically adjusts the screen position, clock, and clock phase. (The displayed image will disappear for a few seconds while Auto-configuration is in progress.)
- Reset
Returns to the default settings programmed at the factory; default settings cannot be changed.

4 Press the **ENTER** button to save.

Note:

Depending on the specification of the PC you are playing the DVD VIDEO on, and the DVD's title, some scenes may be skipped, or you may not be able to pause during multi-angle scenes.

DVD&VCD Operation

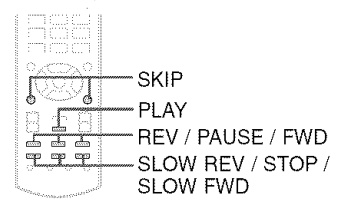

Basic Playback

- 1** Press the **POWER** button on the TV to turn the unit on.
- 2** Insert your chosen disc into the disc slot on the side panel. Be sure to face the top of the disc (with title etc.) toward the front of the screen. Playback starts.
- 3** Press the **EJECT** button on the TV to remove the disc.

Stop Playback

- 1** Press the **STOP** button to stop playback. At this time the DVD video player stops playback temporarily and maintains the current playback position.
 - If you **PLAY** button is pressed, playback will resume from the location where you stopped playback.
- 2** Press the **STOP** button again to stop playback fully. (At this time if you press **PLAY** button, the disc playback starts from the beginning.)

Pause Playback (Still mode)

- 1** Press the **PAUSE (II)** button during playback.
- 2** Press the **PLAY** button again to return to normal playback.

Note :

- a. Press the **PLAY** button to return to the DVD mode from the TV, Video or PC mode.
- b. If you have a disc problem during playback, remove the disc by pressing and holding down the **EJECT** button on the top panel for more than 4 seconds.

Fast Forward/Backward

- 1** Press the **FWD (▶▶)** or **REV (◀◀)** button during playback. Each time you press the **FWD (▶▶)** or **REV (◀◀)** button, the playback speed changes as shown.
 - **FWD (▶▶)**: ▶▶ 2x → ▶▶ 4x → ▶▶ 8x → ▶▶ 16x → ▶▶ 32x → 1x.
 - **REV (◀◀)**: ◀◀ 2x → ◀◀ 4x → ◀◀ 8x → ◀◀ 16x → ◀◀ 32x → 1x.
- 2** Press the **PLAY** button to resume normal playback.

Slow Forward/Backward

- 1** Press the **SLOW FWD (▶|)** or **SLOW REV (◀|)** button during playback. Each time you press the **SLOW FWD (▶|)** or **SLOW REV (◀|)** button, the playback speed changes as shown:
 - **SLOW FWD (▶|)**: ▶| 1/2 → ▶| 1/4 → ▶| 1/8 → ▶| 1/16 → 1x.
 - **SLOW REV (◀|)**: ◀| 1/2 → ◀| 1/4 → ◀| 1/8 → ◀| 1/16 → 1x. (DVD only)
- 2** Press the **PLAY** button to resume normal playback.

Note :

There is no sound during fast or slow playback for DVDs or Video CDs.

Skip a Chapter or a Track

- 1** Press the **SKIP (▶▶|)** button or **SKIP (|◀◀)** button to locate a desired chapter during playback. Each time you press the button, a chapter or track is skipped.
 - Press the **SKIP (▶▶|)** button to locate succeeding chapters or tracks.
 - Press the **SKIP (|◀◀)** button to go back to the beginning of the current chapter or track.
 - Press the **SKIP (|◀◀)** button twice in quick succession, playback will start from the beginning of the preceding chapter or track.

DVD&VCD Operation (Continued)

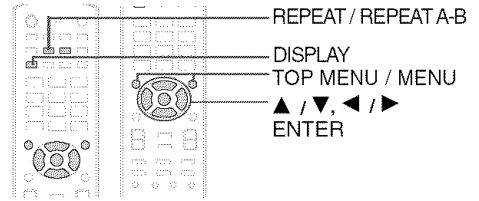

Frame by Frame Playback (II▶)

- 1 Press **PAUSE (II)** button during still playback. Each time you press the **PAUSE (II)** button, the picture advances one frame.

OSD (On-Screen Display)

You can display the playback status on the TV screen as follows: Title, Chapter number, Playing time.

- 1 Press the **DISPLAY** button during DVD playback. Title and Chapter information appears on the screen. Each time you press the **DISPLAY** button, the OSD changes as follows.

- DVD: Title Elapsed → Title Remain → Chapter Elapsed → Chapter Remain → Display off
- VCD: Single Elapsed → Single Remain → Total Elapsed → Total Remain → Display off

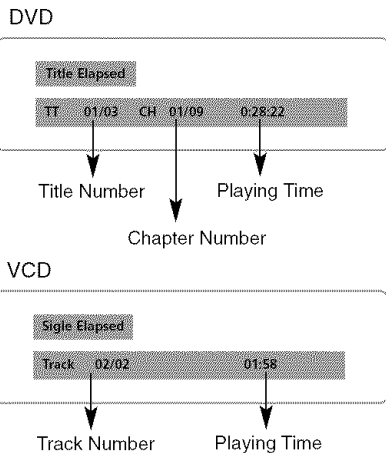

Note :
The OSD display may be different depending on the type of DVD disc.

Selecting the disc menu

- 1 Press the **MENU** button during playback.
- 2 Use the **▲ / ▼, ◀ / ▶**, or **ENTER** button to select the desired menu option.

Selecting the title menu

- 1 Press the **TOP MENU** button during playback.
- 2 Use the **▲ / ▼, ◀ / ▶**, or **ENTER** button to select the desired item.

Note :
The unit may not be able to select the disc or title menu depending on the type of DVD disc.

Repeat playback

You can play a specific title, chapter, track, or segment repeatedly.

- 1 Press the **REPEAT** button during playback. Each time you press the **REPEAT** button, the repeat mode changes as follows.
 - DVD : Chapter → Title → ALL → Repeat Off
 - VCD : Track → ALL → Repeat Off

A-B repeat playback

- A-B repeat playback allows you to repeat material between two selected points.

- 1 Press the **REPEAT A-B** button to select the start point during playback. " A" is displayed on the TV screen and the starting point of your selected segment is set up.
- 2 Press the **REPEAT A-B** button again to select the end point. " AB" is displayed on the TV screen and the ending point is set up. Playback starts at the point that you selected. Playback stops at the end point, returns to Point A automatically, then starts again.
- 3 Repeatedly press the **REPEAT A-B** button again to resume normal playback. "Off" appears on the screen.

Note :

- a. Some discs may not permit A-B repeat operation.
- b. You cannot set the A-B repeat function for a segment that includes multiple camera angles.
- c. You can specify a segment only within the current title or track (VIDEO CD).
- d. There may be a slight difference between point A and the location where playback actually resumes depending on the disc.

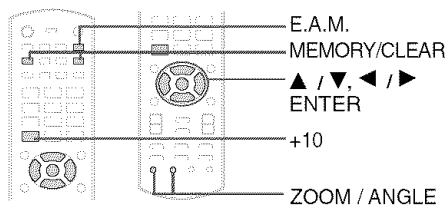

Programmed Playback

- You can arrange the playback order of tracks on the disc.

- 1** Press the **MEMORY** button in the stop mode or during playback.
- 2** Use the **▲ / ▼** buttons to select the program position.
- 3** Use the **+10** button and the number buttons to enter the desired Title(TT)/Chapter(CH) numbers.
Each time you press the **+10** button, it increases by 10. When you input a two-digit number, input the digit of ten with **+10** button and then input the digit of one with the number buttons (0-9).

To program others, repeat Steps 2 and 3.

- If you input a wrong number, press **CLEAR**.
- Depending on the disc, Programmed playback menu may look different from the example shown.

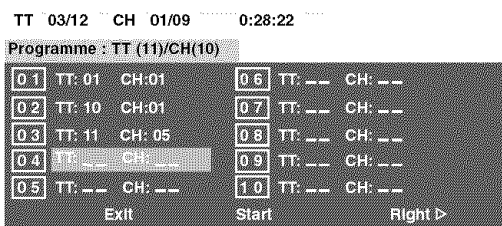

- 4** Press the **▲ / ▼ / ◀ / ▶** buttons to select **Start** and then press the **ENTER** button.
 - The programs you selected will start to playback in the order.
 - To resume normal playback, select **Stop** in step 3.
 - Select **Exit** to quit the programmed playback menu.

Note:
Depending on the disc, programmed playback may not be possible.

Selecting camera angles

If the scene was recorded from multiple angles, you can easily change the camera angle of the scene you are currently watching.

- 1** Press the **ANGLE** button during playback.
- 2** Repeatedly press the **ANGLE** button to select the desired angle.

Note:

- a. You can only change the angle for DVDs that provide multiple angles of scenes.
- b. The angle function will not work on DVD video discs that do not contain scenes recorded at different angles.
- c. The number of angles varies from disc to disc.

E.A.M. (Enhanced Audio Mode)

Used to simulate multi-channel sound from just two speakers without the need to add extra speakers or equipment.

- 1** Press the **E.A.M.** button during playback.
- 2** Each press of the **E.A.M.** button changes the sound display as indicated below:
: Off → Concert → Living room → Hall → Shower → Arena.

Picture Size Zoom

When enlarging or reducing the picture, it may become distorted.

- 1** Press the **ZOOM** button during playback.
- 2** Each press of the **ZOOM** button changes the screen display as indicated below:
: 2x, 3x, 4x, 1/2, 1/3, 1/4, (Zoom off)
- 3** Adjust the main picture position using the **▲ / ▼ / ◀ / ▶** buttons while in the enlarged picture mode.

DVD&VCD Operation (Continued)

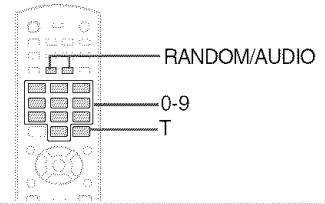

Random

- 1** Press the **RANDOM** button during playback.
- 2** Each time you press the **RANDOM** button, the random mode changes in the following order: Random → Shuffle → Off
 - Random: Begins random playback from the beginning.
 - Shuffle : Begins random playback from the current playback position.

Audio

- 1** Used to change the audio-related setting during DVD playback. Each time you press it, the set value is changed.

Audio 1/3: DDD 5.1CH English

Note :
Depending on the disc, Audio setup may not be possible.

Locating a desired section by entering its corresponding number (T)

- 1** Press the **T** button during playback.
- 2** Use the number buttons to enter the time counter (hour:minutes:seconds) of the desired location. Playback begins from the time location designated on the current title or track .

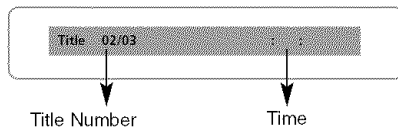



About DVD Screen Saver

If you pause or stop a picture of a DVD video disc and leave it still for approximately 5 minutes, the screen saver of the player automatically appears.

To turn off the screen saver, press any button related DVD on the remote control.

DVD Menu options

While in the DVD input, if you press **SET UP** button in the stop ( / ) mode, the DVD menu is displayed, and in the play or pause mode, the TV setup menu is displayed.

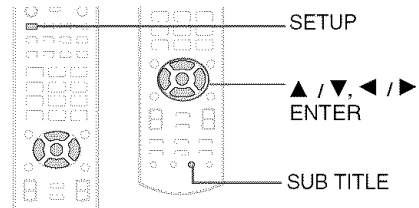

Selecting an audio language

- Select your preferred audio language. If an audio language is selected, the selected audio language is played whenever you start a new disc playback. (The disc must contain the selected language.)

Selecting a subtitle language

- Select your preferred subtitle language. If a subtitle language is selected, the selected subtitle language is played whenever you start a new disc playback. (The disc must contain the selected language.)
- You can also select another available subtitle language during playback with the **SUB TITLE** button on the remote control during playback.

1 Press the **SET UP** button in the stop mode and then use the **▲ / ▼** buttons to select **Audio Language**.

2 Press the **▶** button and then use **▲ / ▼** buttons to select your desired language.

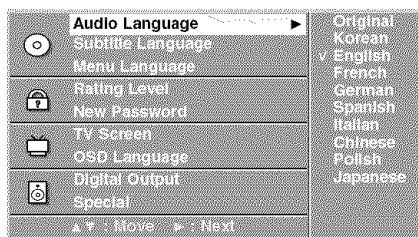

3 Press the **ENTER** button.

4 Press the **SET UP** button to resume normal playback.

1 Press the **SET UP** button in the stop mode and then use the **▲ / ▼** buttons to select **Subtitle Language**.

2 Press the **▶** button and then use the **▲ / ▼** buttons to select your desired language.

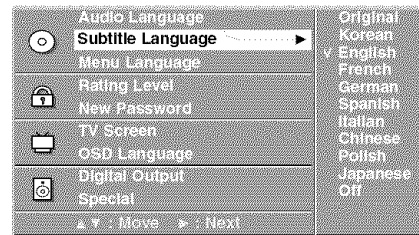

3 Press the **ENTER** button.

4 Press the **SET UP** button to resume normal playback.

DVD Menu options (Continued)

Disc menu language selection

- Select your preferred language for the disc menus and DVD messages. (The disc must contain the selected language)

1 Press the **SET UP** button in the stop mode and then use the **▲ / ▼** buttons to select **Menu Language**.

2 Press the **▶** button and then the **▲ / ▼** buttons to select your desired language.

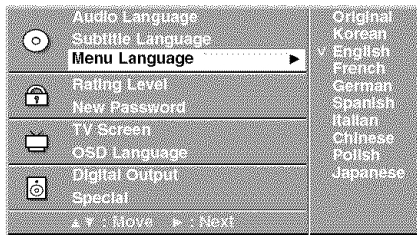

3 Press the **ENTER** button. The menus and on screen displays will appear in the selected language.

4 Press the **SET UP** button to resume normal playback.

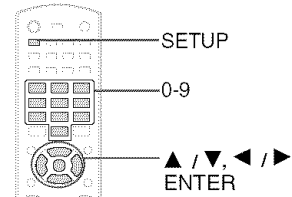

Parental Control Setup

- Use to block viewing of unsuitable discs.

1 Press the **SET UP** button in the stop mode and then use the **▲ / ▼** buttons to select **Rating Level**.

2 Press the **▶** button and then use number buttons to key in a 4-digit password. Be sure to remember the password! If you key in an incorrect number, press the **SETUP** button and start over.

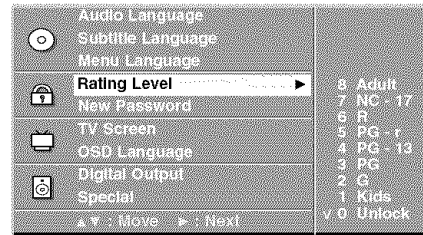

3 Use the **▲ / ▼** buttons to set the restriction level from 0 to 8. Viewing becomes more restricted as the number decreases.

- 0: Unlock
- 1: Kids
- 2: G (General audience)
- 3: PG (Parental guidance suggested)
- 4: PG-13 (13 years and older)
- 5: PG-r
- 6: R (Restricted)
- 7: NC-17 (18 years and older)
- 8: Adult (Adults only)

4 Press the **SET UP** button to resume normal playback.

Note:

If you ever forget your password, key in '7', '7', '7', '7' on the remote control.

Changing the password

1 Press the **SET UP** button in the stop mode and then use the **▲ / ▼** buttons to select **Rating Level**.

2 Press the **▶** button and then use number buttons to key in a 4-digit password.

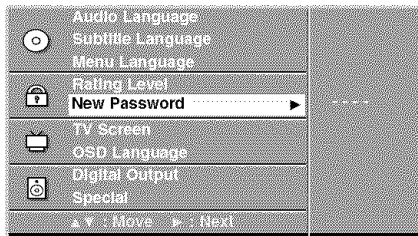

3 Press the **◀** button and then use the **▲ / ▼** buttons to select **New password**.

4 Press the **▶** button and then enter a 4 digit password. Enter it again when requested.

5 Press the **SET UP** button to resume normal playback.

TV Screen

- You can watch TV in various picture formats.

1 Press the **SET UP** button in the stop mode and then use the **▲ / ▼** buttons to select **TV Screen**.

2 Press the **▶** button and then the **▲ / ▼** buttons to select **4 : 3 LB**, **4 : 3 PS**, or **16 : 9 Wide**.

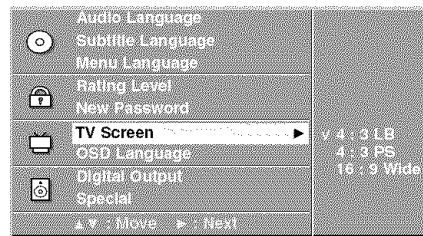

Letter Box (4:3 LB)



Pan & Scan (4:3 PS)



16:9 Wide

3 Press the **ENTER** button

4 Press the **SET UP** button to resume normal playback.

Note :
Depending on the disc, the TV screen feature may not be available.

DVD Menu options (Continued)

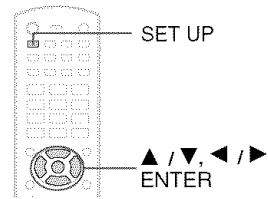

Disc OSD language selection

- The onscreen display can be shown on the screen in your specified language.

1 Press the **SET UP** button in the stop mode and then use the **▲ / ▼** buttons to select **OSD Language**.

2 Press the **▶** button and then use the **▲ / ▼** buttons to select your desired language. All the on screen displays will appear in the selected language.

3 Press the **SET UP** button to resume normal playback.

Digital audio output

- You can select the output for SPDIF (Sony/Philips Digital Interface).

1 Press the **SET UP** button in the stop mode and then use the **▲ / ▼** buttons to select **Digital Output**.

2 Press the **▶** button and then use the **▲ / ▼** buttons to select **OFF, RAW** (Original SPDIF signal), or **PCM** (Pulse Code Modulation: Encodes SPDIF signal to PCM).

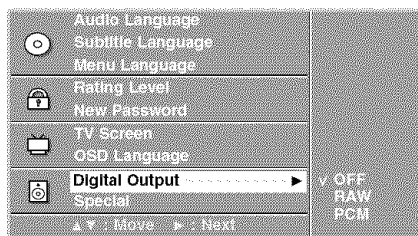

3 Press the **ENTER** button.

4 Press the **SET UP** button to resume normal playback.

DRC (Dynamic Range Compression)

- Confines the audio range to prevent excessively loud sound yet allows you to hear the low sounds clearly.

1 Press the **SET UP** button in the stop mode and then use the **▲ / ▼** buttons to select **Special**.

2 Press the **▶** button and then use the **▲ / ▼** buttons to select **DRC Off** (Decrease the DRC range) or **DRC On** (Reset the DRC range to original values).

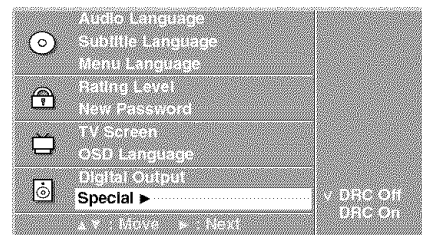

3 Press the **ENTER** button.

4 Press the **SET UP** button to resume normal playback.

MP3/WMA files Playback options

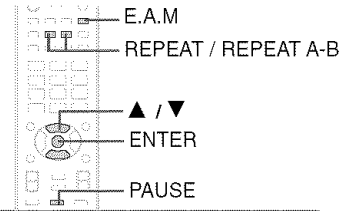

MP3/WMA Files Playback

- 1 When inserted, the MP3 menu screen appears automatically depending on the MP3 disc's folder (directory) structure as shown to the below.

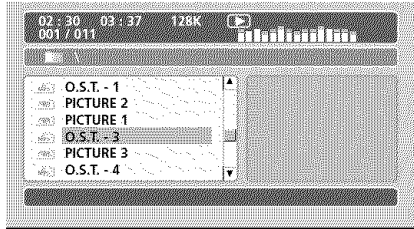

- 2 Use the ▲ / ▼ buttons to find desired folder and then press the **ENTER** button.

- 3 Use the ▲ / ▼ buttons to find the desired MP3 title and then press the **ENTER** button.

Stop/Pause Playback

Stop Playback

Press the **STOP** button to stop playback.

Pause Playback

- 1 Press the **PAUSE (II)** button during playback.
- 2 Press the **PLAY** button again to return to normal playback.

E.A.M. (Enhanced Audio Mode)

- Used to simulate multi-channel sound from just two speakers without the need to add extra speakers or equipment

- 1 Press the **E.A.M.** button during playback.
- 2 Each press of the **E.A.M.** button changes the sound option as indicated below:
: Off → Concert → Living room → Hall → Shower → Arena.

Repeat playback

- You can play a specific track repeatedly.

- 1 Press the **REPEAT** button during playback. Each time you press the **REPEAT** button, the repeat mode changes in the following order:
: Repeat Track → Repeat Directory → Off

A-B repeat playback

- A-B repeat playback allows you to repeat material between two selected points.

- 1 Press the **REPEAT A-B** button to select the start point during playback. "⌚ A" is displayed on the TV screen and the starting point of your selected segment is set up.

- 2 Press the **REPEAT A-B** button again to select the end point. "⌚ AB" is displayed on the TV screen and the ending point is set up. Playback starts at the point that you selected. Playback stops at the end point, returns to Point A automatically, then starts again.

- 3 Repeatedly press the **REPEAT A-B** button until "Off" appears on the screen to resume normal playback.

Playable files

MP3/WMA disc compatibility with this player is limited as follows:

- Playable discs: CD-ROM, CD-R, CD-RW
- Sampling Frequency: MP3: 11 kHz, 16 kHz, 32 kHz, 44,1 kHz, 48 kHz
WMA: 44,1 kHz, 48 kHz
- Bit rate: MP3: 32 kbps - 320 kbps (CBR)
WMA: 64 kbps - 192 kbps(CBR)
- CD physical format: Mode 1
- File system: ISO9660, UDF without interleave
- File name: File names are limited to eight characters or less and must incorporate "MP3" or "WMA" extension. e.g. "*****.MP3", "*****.WMA"
File names cannot contain special characters such as "?!><+*}{[@]:\ /.," etc.
Less than 50 bytes
- Total number of files: Less than 650
- WMA codec version: V2, V7, V8, V9 (Stereo sound only)

Audio CD Playback options

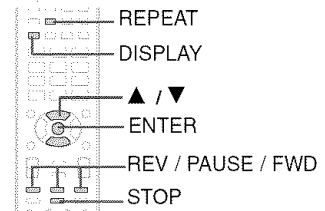

OSD (On-Screen Display)

- You can display the Track, and Playback time status on the TV screen.

- 1 Press the **DISPLAY** button during CD playback. Track information appear on the screen. Each time you press the **DISPLAY** button, the OSD changes as follows:
Single Elapsed → Single Remain → Total Elapsed → Total Remain

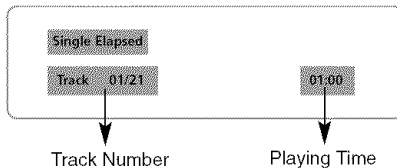

Stop Playback

- 1 Press the **STOP** button to stop playback. At this time the DVD video player stops playback temporarily and maintains the current playback position.
 - If the **PLAY** button is pressed, playback will resume from the location where you stopped playback.
- 2 Press the **STOP** button again to stop playback fully. (At this time if you press the **PLAY** button, disc playback starts from the beginning.)

Pause Playback (Still mode)

- 1 Press the **PAUSE (II)** button during playback.
- 2 Press the **PLAY** button again to return to normal playback.

Fast Forward/Backward

- 1 Press the **FWD (▶▶)** or **REV (◀◀)** button during playback. Each time you press the **FWD (▶▶)** or **REV (◀◀)** button, the playback speed changes as shown.
 - **FWD (▶▶)** : ▶▶ 2x → ▶▶ 4x → ▶▶ 8x → ▶▶ 16x → ▶▶ 32x.
 - **REV (◀◀)** : ◀◀ 2x → ◀◀ 4x → ◀◀ 8x → ◀◀ 16x → ◀◀ 32x.

- 2 Press the **PLAY** button to resume normal playback.

Repeat playback

- You can play a specific track repeatedly.

- 1 Press the **REPEAT** button during playback. Each time you press the **REPEAT** button, the repeat mode changes as indicated: Track → ALL → Repeat Off

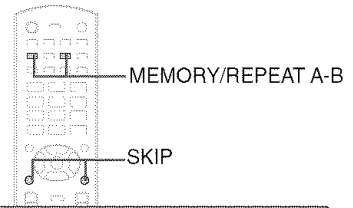

Programmed Playback

- You can arrange the playback order of tracks on the disc.

1 Press the **MEMORY** button in the stop mode or during playback.

2 Use the **▲ / ▼** buttons to select the program position.

3 Use the **+10** button and the number buttons to enter the desired Track(TT) numbers.
Each time you press the **+10** button, it increases by 10. When you input a two-digit number, input the digit of ten with **+10** button and then input the digit of one with the number buttons (0-9).

To program others, repeat Steps 2 and 3.

- If you input a wrong number, press **CLEAR**.

Track 14/21 00:03

Programme: Track (01 - 21)

01	03	06	---
02	06	07	---
03	01	08	---
04	---	09	---
05	---	10	---

Exit Start Right

4 Press the **▲ / ▼ / ◀ / ▶** buttons to select **Start** and then press the **ENTER** button.

- The programs you selected will start to playback in the order.
- To resume normal playback, select **Stop** in step 3.
- Select **Exit** to quit the programmed playback menu.

Skip Tracks

1 Use the **SKIP (▶▶)** or **SKIP (◀◀)** button to locate a desired track during playback. Each time you press the button, the unit skips to the next/previous track.

A-B repeat playback

- A-B repeat playback allows you to repeat material between two selected points.

1 Press the **REPEAT A-B** button to select the start point during playback. "⌚ A" is displayed on the TV screen and the starting point of your selected segment is set up.

2 Press the **REPEAT A-B** button again to select the end point. "⌚ AB" is displayed on the TV screen and the ending point is set up. Playback starts at the point that you selected. Playback stops at the end point, returns to Point A automatically, then starts again.

3 Repeatedly press the **REPEAT A-B** button again to resume normal playback. "Off" appears on the screen.

JPEG file viewing options

- As a JPEG file is loaded, the table of contents appears on the TV screen. 16 slide show transition modes are available.

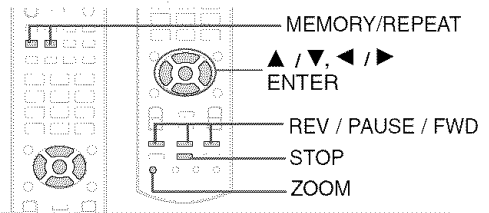

Picture Selection

- 1 Use the **▲ / ▼** buttons to select the desired picture. The selected JPEG file appears on the right side of the screen.

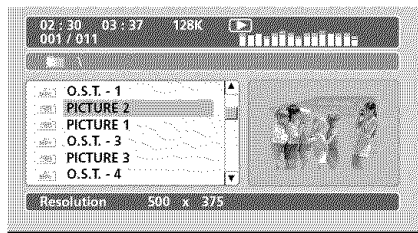

- 2 Press the **ENTER** button to enlarge the JPEG file to fill the screen.

- 3 Press the **PLAY** button again to start the slide show mode. Press the **STOP** button to return to the menu.

Note:

If you press the **ENTER** button while playing a JPEG disc, the picture slide show starts.

Picture transition modes

- 1 Use the **MEMORY** button to change the slide show transition mode as shown below:
 Wipe Top → Wipe Bottom → Wipe Left → Wipe Right → Diagonal Wipe Left Top → Diagonal Wipe Right Top → Diagonal Wipe Left Bottom → Diagonal Wipe Right Bottom → Extend From Center H → Extend From Center V → Compress To Center H → Compress To Center V → Window H → Window V → Wipe From Edge To Center → Move in From Top → None

Image Rotation

Use the **▲ / ▼** buttons to rotate a picture. There are 2 modes to rotate picture:

- **▲** button: invert.
- **▼** button: mirror

Image Zoom

- 1 Press the **ZOOM** button and use the **FWD (▶▶)** or **REV (◀◀)** button to see the zoom mode at 50% ~ 200%.

- 2 Adjust the picture position using the **▲ / ▼ / ◀ / ▶** buttons while in the enlarged picture mode. To exit Zoom mode, press the **ZOOM** button one more time.

- 3 Press the **STOP** button to return to the menu.

Repeat playback

- You can show JPEG files repeatedly.

- 1 Press the **REPEAT** button during playback. Each time you press the **REPEAT** button, the repeat mode changes as indicated: Repeat One → Repeat All → Repeat Off

JPEG files compatibility

Discs and pixels whose compatibility with this player has been confirmed by TOSHIBA are as follows.

Kodak Picture CD

JPEG disc compatibility with this player is limited as follows:

- Playable discs: CD-ROM, CD-R, CD-RW
- File system: ISO9660, UDF without interleave
- File name: File names are limited to eight characters or less and must incorporate "JPG" extension.
 e.g. "*****.JPG"
 File names cannot contain special characters such as "?!><+}{[@]:; \ / , ." etc.
- File size: 3.3 M bytes
- File format: BASELINE, PROGRESSIVE
- Resolution: Baseline JPG: 3072x2048
 Progressive JPG: 2000x1500

Troubleshooting

Use the following check list for troubleshooting when you have problems with your unit. Consult your local dealer or Toshiba Authorized Service Center if problems persist.

Be sure all connections are properly made when using with other units.

SYMPTOMS	POSSIBLE SOLUTIONS
POWER	
TV/DVD does not operate.	<ul style="list-style-type: none"> • Make sure the power cord is plugged in. • Try another Wall outlet.
TV BROADCAST RECEPTION	
Poor sound or No sound.	<ul style="list-style-type: none"> • Station or Cable TV experiencing problems, tune to another station. • Check Volume adjustments. • Check for sources of possible interference.
Poor picture or No picture.	<ul style="list-style-type: none"> • Station or Cable TV experiencing problems, tune to another station. • Check antenna or Cable TV connections, reorient antenna. • Check for sources of possible interference. • Check picture control adjustments.
Poor reception on some channels.	<ul style="list-style-type: none"> • Station or Cable TV experiencing problems, tune to another station. • Station signal is weak, reorient antenna to receive weaker station. • Check for sources of possible interference.
Poor color or no color.	<ul style="list-style-type: none"> • Station or Cable TV experiencing problems, tune to another station. • Make sure channels are set into memory. • Check picture control adjustments. • Check antenna or Cable TV connections, reorient antenna. • Check for sources of possible interference.
Picture wobbles or drifts.	<ul style="list-style-type: none"> • Station or Cable TV experiencing problems, tune to another station. • Make sure channels are set into memory. • Cable TV company is scrambling signal. • Check antenna orientation.
No CATV reception.	<ul style="list-style-type: none"> • Check all Cable TV connections.
Horizontal or diagonal bars on screen.	<ul style="list-style-type: none"> • Check antenna connections, reorient antenna. • Check for sources of possible interference.
No reception above channel 13.	<ul style="list-style-type: none"> • If using antenna, check UHF antenna connections.
TV shuts off.	<ul style="list-style-type: none"> • No broadcast on station tuned with Auto off activated. • Sleep Timer is set. • Power interrupted.
Display is not shown in your language.	<ul style="list-style-type: none"> • Select proper language in the menu options.

Troubleshooting (Continued)

SYMPTOMS	POSSIBLE SOLUTIONS
DVD	
Playback doesn't start.	<ul style="list-style-type: none"> • No disc is inserted. • The disc may be dirty. Clean up the disc. • The unit cannot play CD-ROMs, etc.
No picture.	<ul style="list-style-type: none"> • INPUT SELECT is not set correctly.
No sound.	<ul style="list-style-type: none"> • Check that the input selector of the amplifier is set properly. • The unit is in the special playback mode.
Picture is distorted during fast reverse/forward playback.	<ul style="list-style-type: none"> • The picture will be distorted occasionally. This is not a defect of the unit.
Stopping playback, search, slow-motion play, repeat play, or program play, etc. cannot be performed.	<ul style="list-style-type: none"> • Some discs may not do some of the functions.
No 4:3 (Wide) picture.	<ul style="list-style-type: none"> • Select appropriate screen size.
No surround sound.	<ul style="list-style-type: none"> • The setup does not match your stereo system.
The unit or remote operation key is not functioning.	<ul style="list-style-type: none"> • Turn off the unit and unplug the AC power cord for several minutes, then replug it.
Audio soundtrack and/or subtitle language is not changed when you play back a DVD.	<ul style="list-style-type: none"> • Multilingual language is not recorded on the DVD disc.
No subtitle.	<ul style="list-style-type: none"> • Some discs have no subtitles. • Subtitles are cleared. Press the SUB TITLE button.
Angle cannot be changed.	<ul style="list-style-type: none"> • Multi-angles are not recorded on the DVD disc.
REMOTE CONTROL	
The remote control does not function.	<ul style="list-style-type: none"> • Aim the remote control at the remote sensor. • Operate within approx. 7 meters or reduce the light in the room. • Clear the path of the beam. • The batteries are weak. Replace the batteries. • Check the batteries are inserted correctly.

Specifications

General

Power supply	AC 120V~ 60 Hz 1.2A
Power consumption	Operation: 65 W, Stand by: 2 W
Speaker	2.68 x 1.61 inches (68 x 41 mm), 4 ohm x 2
Audio output power	3 W + 3 W
Weight	16.8 lbs (7.62 kg)
Dimensions	Width: 20.24 inches (514.0 mm) Height: 14.47 inches (367.5 mm) Depth: 7.09 inches (180.0 mm)
Tuner	VHF 2~13 UHF 14~69 Cable 01~125
Antenna input	UHF/VHF: 75Ω coaxial
Applicable disc	DVD (12 cm, 8 cm), CD (12 cm, 8 cm)
Frequency range	DVD: 4 Hz-22 kHz, CD: 4 Hz-20 kHz
Operating conditions	Temperature: 0°C-35°C

Input/Output

Video input	1.0 V (p-p), 75Ω, negative sync., RCA jack x 1
Audio input	400mVrms, 470 kΩ, RCA jack (L/R) x 1
S-Video input	(Y) 1.0 V (p-p), 75Ω, negative sync., Mini DIN 4-pin x 1 (C) 0.286 V (p-p), 75Ω
Component input	(Y) 1.0 V (p-p), 75Ω (Pb) 0.7 V (p-p), 75Ω (Pr) 0.7 V (p-p), 75Ω
PC input	15-pin D-Sub
PC sound input	800mVrms, 470 kΩ, Stereo Mini jack x 1
DVD video output	1.0 V (p-p), 75Ω, negative sync., RCA jack x 1
DVD audio output	400mVrms, RCA jack(L/R)x1
Audio output (SPDIF)	Optical connector 2.4V/10pF
Headphone output	∅ 3.5mm stereo mini jackx1

Supplied accessories

Remote control	1
Batteries (AA)	2
Power cord	1
Owner's Manual (This booklet)	1

- This model complies with the above specifications.
- Designs and specifications are subject to change without notice.
- This model may not be compatible with features and/or specifications that may be added in the future.

Limited United States Warranty **LCD TV/DVD Combination—Repair Warranty**

Toshiba America Consumer Products, L.L.C. ("TACP") makes the following limited warranties to original consumers in the United States. THESE LIMITED WARRANTIES EXTEND TO THE ORIGINAL CONSUMER PURCHASER OR ANY PERSON RECEIVING THIS DVD PLAYER AS A GIFT FROM THE ORIGINAL CONSUMER PURCHASER AND TO NO OTHER PURCHASER OR TRANSFEREE. PRODUCTS PURCHASED IN THE U.S.A. AND USED IN CANADA ARE NOT COVERED BY THESE WARRANTIES. PRODUCTS PURCHASED IN CANADA AND USED IN THE U.S.A. ARE NOT COVERED BY THESE WARRANTIES.

Limited One (1) Year Warranty on Parts and Labor*

TACP warrants this LCD TV/DVD Combination and its parts against defects in materials or workmanship for a period of one (1) year after the date of original retail purchase. DURING THIS PERIOD, TACP WILL, AT TACP'S OPTION, REPAIR OR REPLACE A DEFECTIVE PART, WITH A NEW OR REFURBISHED PART, WITHOUT CHARGE TO YOU. YOU MUST CONTACT TOSHIBA'S CONSUMER SOLUTIONS CENTER FOR INSTRUCTIONS ON HOW TO PROCESS YOUR IN WARRANTY REPAIR REQUEST. THE CONSUMER IS RESPONSIBLE FOR ALL INBOUND TRANSPORTATION AND INSURANCE CHARGES FOR THE LCD TV/DVD COMBINATION TO THE REPAIR CENTER.

***Rental Units**

The warranty for rental units begins on the date of the first rental or thirty (30) days from the date of shipment to the rental firm, whichever comes first.

***Commercial Units**

LCD TV/DVD Combination units sold and used for commercial purposes have a limited warranty for all parts and labor, which warranty begins on the date of original retail purchase and ends on the date that is ninety (90) days thereafter.

Owner's Manual and Demographic Card

Read this owner's manual thoroughly before operating this LCD TV/DVD Combination. Complete and mail the enclosed Product Registration Card or register your product on-line at www.tacp.toshiba.com/service as soon as possible. By registering your product you will enable TACP to bring you new products specifically designed to meet your needs and help us contact you in the unlikely event a safety notification is required under the Consumer Product Safety Act. Failure to complete and return the Product Registration Card does not diminish your warranty rights.

Your Responsibility

THE ABOVE WARRANTIES ARE SUBJECT TO THE FOLLOWING CONDITIONS:

- (1) You must provide your bill of sale or other proof of purchase.
- (2) All warranty servicing of this LCD TV/DVD COMBINATION must be made by an Authorized TACP Service Station.
- (3) These warranties from TACP are effective only if the LCD TV/DVD COMBINATION is purchased and operated in the U.S.A. or Puerto Rico.
- (4) Labor service charges for set installation, set up, adjustment of customer controls and installation or repair of antenna systems are not covered by these warranties. Reception problems caused by inadequate antenna systems are your responsibility.
- (5) Warranties extend only to defects in materials or workmanship as limited above and do not extend to any LCD TV/DVD COMBINATION or parts which have been lost or discarded by you or to damage to LCD TV/DVD COMBINATION or parts caused by fires, misuse, accident, Acts of God, such as lightning or fluctuations in electric power, improper installation, improper maintenance or use in violation of instructions furnished by TACP; use or malfunction through simultaneous use of this product and connected equipment; or to units which have been modified or had the serial number removed, altered, defaced or rendered illegible.

Limited United States Warranty (Continued)

How to Obtain Warranty Services

If, after following all of the operating instructions in this manual and checking the section "Troubleshooting", you find that service is needed:

- (1) For instructions on how to obtain warranty service, contact TACP'S toll free Call Center at 1-866-583-7353.
- (2) Include your bill of sale or other proof of purchase along with the LCD TV/DVD COMBINATION, when sending it to the Authorized TACP Service Station SPECIFIED by TACP'S Call Center. You must pay for all transportation and insurance charges for the LCD TV/DVD Combination to and from the Service Station.

For additional information, visit TACP's web site:

www.tacp.toshiba.com

ALL WARRANTIES IMPLIED BY THE LAW OF ANY STATE OF THE U.S.A., INCLUDING THE IMPLIED WARRANTIES OF MERCHANTABILITY AND FITNESS FOR A PARTICULAR PURPOSE, ARE EXPRESSLY LIMITED TO THE DURATION OF THE LIMITED WARRANTIES SET FORTH ABOVE. WITH THE EXCEPTION OF ANY WARRANTIES IMPLIED BY THE LAW OF ANY STATE OF THE U.S.A. AS HEREBY LIMITED, THE FOREGOING WARRANTY IS EXCLUSIVE AND IN LIEU OF ALL OTHER WARRANTIES, GUARANTEES, AGREEMENTS AND SIMILAR OBLIGATIONS OF TACP WITH RESPECT TO THE REPAIR OR REPLACEMENT OF ANY PARTS. IN NO EVENT SHALL TACP BE LIABLE FOR CONSEQUENTIAL OR INCIDENTAL DAMAGES (INCLUDING, BUT NOT LIMITED TO, LOST PROFITS, BUSINESS INTERRUPTION, MODIFICATION OR ERASURE OF RECORDED DATA CAUSED BY USE, MISUSE OR INABILITY TO USE THIS PRODUCT).

No person, agent, distributor, dealer or company is authorized to change, modify or extend the terms of these warranties in any manner whatsoever. The time within which action must be commenced to enforce any obligation of TACP arising under this warranty or under any law of the United States or of any state thereof is hereby limited to three hundred sixty five (365) days from the date you discovered or should have discovered, the defect. This limitation does not apply to implied warranties arising under the law of any state of the U.S.A.

THIS WARRANTY GIVES YOU SPECIFIC LEGAL RIGHTS, AND YOU MAY ALSO HAVE OTHER RIGHTS WHICH MAY VARY FROM STATE TO STATE IN THE U.S.A. SOME STATES OF THE U.S.A. DO NOT ALLOW LIMITATIONS ON HOW LONG AN IMPLIED WARRANTY LASTS, WHEN AN ACTION MAY BE BROUGHT, OR THE EXCLUSION OR LIMITATION OF INCIDENTAL OR CONSEQUENTIAL DAMAGES, SO THE ABOVE LIMITATIONS OR EXCLUSIONS MAY NOT APPLY TO YOU UNDER SUCH CIRCUMSTANCES.



Others



- IMPORTANT -
CANADIAN WARRANTY INFORMATION
GARANTIE CANADIENNE

STANDARD WARRANTY
TYPE OF SET

DVD Player
DVD/VCR Combination
Home Theatre in a Box
DVD Recorder
Portable DVD
DVD/LCD Television Combination

GARANTIE NORMALE
TYPE D'APPAREIL

Lecteur DVD
DVD/magnétoscope combo
Cinéma maison dans une boîte
Enregistreur DVD
DVD Portatif
Combo téléviseur ACL / DVD

WARRANTY PERIOD

12 MONTHS

DURÉE DE LA GARANTIE: 12 MOIS

CANADIAN WARRANTY

Toshiba of Canada Limited (TCL) makes the following limited warranties to original consumers in Canada.
Please retain your "Bill of Sale" as proof of purchase.
To obtain a "Canadian Warranty" please register online at www.toshiba.ca.

GARANTIE CANADIENNE

1) Toshiba du Canada Limitée (TCL) offre au Canada les garanties limitées suivantes aux consommateurs originaux.
Veuillez conserver votre « facture » comme preuve d'achat.
Pour obtenir une garantie canadienne, veuillez vous inscrire en ligne à www.toshiba.ca

Canadian Warranty Information

Should service be required on this unit during the one year warranty period, TCL's option will be to repair or exchange the defective unit. It will be necessary to follow this procedure:

Contact: Toshiba of Canada Limited at the Consumer Electronics Group, customer support line.

Phone: 1-800-268-3404

Email: ceg_customer_support@toshiba.ca

All in-warranty repairs must be made by an authorized TCL service centre.

For service exchange TCL will arrange to have the unit picked up by courier and a replacement unit will be returned via same courier. (Note: A major credit card number will be required as a charge of \$25.00 will apply if no fault is found with the unit.)

During the first 3 months of ownership, a new unit will be supplied as a replacement. During the remainder of the warranty period a service-renewed unit will be supplied.

The original "Bill of Sale" must be provided as proof of purchase (it will be returned with the replacement unit.)

This 12-month warranty will be strictly adhered to.

Out of warranty units should be repaired by a TCL authorized service centre.

Note: It is the responsibility of the owner to ensure proper packaging. Should damage in shipping occur, due to poor packaging, a charge back for the repair will result.

This warranty applies to the original purchaser only and is not transferable.

This warranty does not apply to sets that have been subjected to misuse, neglect, accident, physical damage or acts of nature.

Sets with the serial number removed, altered, replaced or defaced will not be covered by this warranty.

The warranties from TCL are effective only if the product is purchased in Canada from an authorized TCL dealer and operated in Canada.

Products utilized for rental or commercial purposes are not covered by this warranty.

This warranty is in lieu of all other warranties, guarantees or agreements, whether expressed or implied, and no person, agent distributor, dealer, service centre or company is authorized to change, modify or extend its terms in any manner whatsoever.

Information sur la garantie Canadienne

Si vous avez besoin de service sur cet appareil au cours de l'année de garantie, Toshiba du Canada Limitée aura l'option de réparer ou d'échanger l'appareil défectueux. Vous devrez suivre la procédure suivante:

Contact: Toshiba du Canada Limitée au Groupe Électronique aux consommateurs, service à la clientèle.

Tél: 1-800-268-3404

Courriel: ceg_customer_support@toshiba.ca

Toutes les réparations au cours de la garantie doivent être faites par un centre de service autorisé Toshiba.

Pour un échange TCL s'assurera qu'un service de courrier ramassera l'unité et qu'un appareil de remplacement soit expédié par le même service de courrier.

(Note: Un numéro de carte de crédit sera requis car une charge de 25,00\$ sera appliquée si toutefois l'appareil n'avait aucun problème de fonctionnement.)

Une nouvelle unité sera fournie comme remplacement durant les premiers 3 mois de propriété. Par contre durant la balance de la garantie une unité remise à neuf sera fournie.

La «facture» originale doit être fournie comme preuve d'achat (elle vous sera retournée avec l'unité de remplacement.)

Cette garantie de 12 mois sera strictement adhéree.

Les unités hors de garantie devraient être réparées par un centre de service autorisé Toshiba.

Note: C'est la responsabilité du propriétaire de s'assurer que l'emballage est adéquat. Vous serez facturé pour toutes réparations causées par des dommages encourus à cause d'un emballage non adéquat.

Cette garantie est octroyée à l'acheteur initial et n'est pas transférable.

Cette garantie ne s'applique pas aux appareils qui ont été sujets aux abus, négligences, accidents, dommages physiques ou actes naturels.

Les appareils dont le numéro de série a été enlevé, altéré, remplacé ou barbouillé ne sont pas couverts par cette garantie.

Les garanties de TCL sont valides seulement sur les unités sont achetées et utilisées au Canada d'un marchand autorisé TCL.

Cette garantie ne couvre pas les produits de location ou à usage commercial. Cette garantie remplace toutes autres garanties ou ententes exprimées ou sous-entendues. Aucune personne, agent, distributeur, concessionnaire ou compagnie n'est autorisé à changer, modifier ou prolonger les termes de cette garantie de quelque façon que ce soit.

Toshiba of Canada Limited 191 McNabb Street Markham, Ontario L3R 8H2

TOSHIBA

Dolby and the double-D symbol are trademarks of Dolby Laboratories.
DTS and DTS Digital Out are trademarks of Digital Theater Systems, Inc.
StableSound is a trademark of Toshiba America Consumer Products, LLC.