



UCA

**DVD HOME THEATER SOUND SYSTEM
SYSTEME HOME CINEMA DVD**

DVX-C300

(DVR-C300+NX-SW300+NX-F300+NX-C300 +NX-S300)

DVX-C300SW

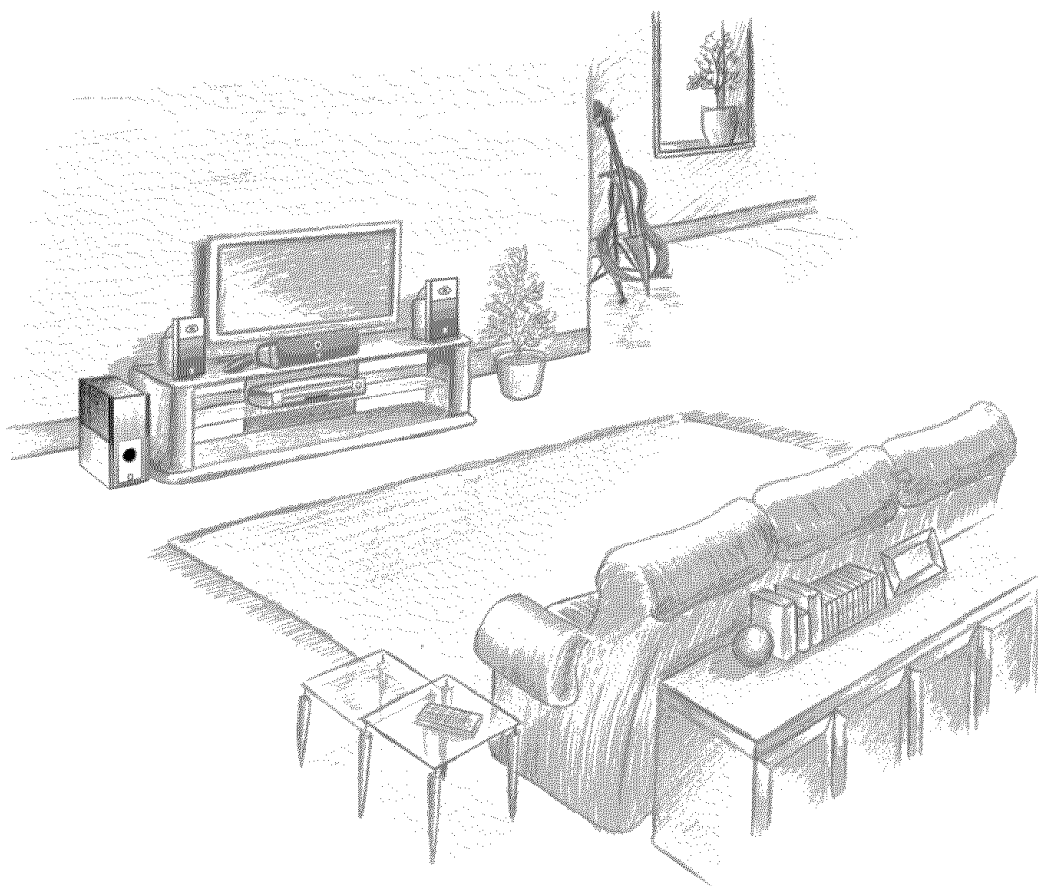

(DVR-C300+NX-SW300)

CinemaStation



**OWNER'S MANUAL
MODE D'EMPLOI**

IMPORTANT SAFETY INSTRUCTIONS

	CAUTION RISK OF ELECTRIC SHOCK DO NOT OPEN	
CAUTION: TO REDUCE THE RISK OF ELECTRIC SHOCK, DO NOT REMOVE COVER (OR BACK). NO USER-SERVICEABLE PARTS INSIDE. REFER SERVICING TO QUALIFIED SERVICE PERSONNEL.		

• Explanation of Graphical Symbols



The lightning flash with arrowhead symbol, within an equilateral triangle, is intended to alert you to the presence of uninsulated "dangerous voltage" within the product's enclosure that may be of sufficient magnitude to constitute a risk of electric shock to persons.



The exclamation point within an equilateral triangle is intended to alert you to the presence of important operating and maintenance (servicing) instructions in the literature accompanying the appliance.

<p>IMPORTANT Please record the serial number of this unit in the space below.</p> <p>MODEL:</p> <p>Serial No.:</p> <p>The serial number is located on the rear of the unit. Retain this Owner's Manual in a safe place for future reference.</p>

- 1 Read these instructions.
- 2 Keep these instructions.
- 3 Heed all warnings.
- 4 Follow all instructions.
- 5 Do not use this apparatus near water.
- 6 Clean only with dry cloth.
- 7 Do not block any ventilation openings. Install in accordance with the manufacturer's instructions.
- 8 Do not install near any heat sources such as radiators, heat registers, stoves, or other apparatus (including amplifiers) that produce heat.
- 9 Do not defeat the safety purpose of the polarized or grounding-type plug. A polarized plug has two blades with one wider than the other. A grounding type plug has two blades and a third grounding prong. The wide blade or the third prong are provided for your safety. If the provided plug does not fit into your outlet, consult an electrician for replacement of the obsolete outlet. 
- 10 Protect the power cord from being walked on or pinched particularly at the plugs, convenience receptacles, and the point where they exit from the apparatus.
- 11 Only use attachments/accessories specified by the manufacturer.
- 12 Use only with the cart, stand, tripod, bracket, or table specified by the manufacturer, or sold with the apparatus. When a cart is used, use caution when moving the cart/apparatus combination to avoid injury from tip-over.
- 13 Unplug this apparatus during lightning storms or when unused for a long periods of time.
- 14 Refer all servicing to qualified service personnel. Servicing is required when the apparatus has been damaged in any way, such as power-supply cord or plug is damaged, liquid has been spilled or objects have fallen into the apparatus, the apparatus has been exposed to rain or moisture, does not operate normally, or has been dropped.
- 15 Be sure to allow spaces of at least 10 cm above, behind and on both sides of DVR-C300, and at least 1m above, 30cm behind and on both sides of NX-SW300.
- 16 Do not place the following objects on this unit:
A vessel with water in it.
If the vessel falls by vibrations and water spills, it may cause damage to the unit, and/or you may get an electric shock.
Apparatus shall not be exposed to dripping or splashing.

FCC INFORMATION (for US customers)

1. **IMPORTANT NOTICE: DO NOT MODIFY THIS UNIT!**
This product, when installed as indicated in the instructions contained in this manual, meets FCC requirements. Modifications not expressly approved by Yamaha may void your authority, granted by the FCC, to use the product.

2. **IMPORTANT:**When connecting this product to accessories and/or another product use only high quality shielded cables. Cable/s supplied with this product **MUST** be used. Follow all installation instructions. Failure to follow instructions could void your FCC authorization to use this product in the USA.

3. **NOTE:**This product has been tested and found to comply with the requirements listed in FCC Regulations, Part 15 for Class "B" digital devices.
Compliance with these requirements provides a reasonable level of assurance that your use of this product in a residential environment will not result in harmful interference with other electronic devices. This equipment generates/uses radio frequencies and, if not installed and used according to the instructions found in the users manual, may cause interference harmful to the operation of other electronic devices. Compliance with FCC regulations does not guarantee that interference will not occur in all installations. If this product is found to be the source of interference, which can be determined by turning the product "OFF" and "ON", please try to eliminate the problem by using one of the following measures:
Relocate either this product or the device that is being affected by the interference.
Utilize power outlets that are on different branch (circuit breaker or fuse) circuits or install AC line filter/s.
In the case of radio or TV interference, relocate/reorient the antenna. If the antenna lead-in is 300 ohm ribbon lead, change the lead-in to coaxial type cable.
If these corrective measures do not produce satisfactory results, please contact the local retailer authorized to distribute this type of product. If you can not locate the appropriate retailer, please contact Yamaha Electronics Corp., 6660 Orangethorpe Ave. Buena Park, CA90622.
The above statements apply **ONLY** to those products distributed by Yamaha Corporation of America or its subsidiaries.

We Want You Listening For A Lifetime

YAMAHA and the Electronic Industries Association's Consumer Electronics Group want you to get the most out of your equipment by playing it at a safe level. One that lets the sound come through loud and clear without annoying blaring or distortion - and, most importantly, without affecting your sensitive hearing. Since hearing damage from loud sounds is often undetectable until it is too late, YAMAHA and the Electronic Industries Association's Consumer Electronics Group recommend you to avoid prolonged exposure from excessive volume levels.



CAUTION VISIBLE AND INVISIBLE LASER RADIATION WHEN OPEN. AVOID EXPOSURE TO BEAM
ADVARSEL SYNLIG OG USYNLIG LASERSTRÅLING VED ÅBNING
UNDGÅ UDSÆTTELSE FOR STRÅLING
ADVARSEL SYNLIG OG USYNLIG LASERSTRÅLING NÅR DEKSEL
ÅPNES UNNGÅ EKSPONERING FOR STRÅLEN
VARNING SYNLIG OCH OSYNLIG LASERSTRÅLNING NÅR
DENNA DEL ÄR ÖPPNAD BETRÄKTA EJ STRÅLEN
VARO ! AVAHTAESSA OLET ALTTIINA NÄKYVÄLLE JA
NÄKYMÄTTÖMÄLLE LASER SÄTEILYLLE. ÄLÄ KATSO SÄTEESEEN
VORSICHT SICHTBARE UND UNSICHTBARE LASERSTRAHLUNG
WENN ABDECKUNG GEÖFFNET NICHT DEM STRAHL AUSSETZEN
DANGER VISIBLE AND INVISIBLE LASER RADIATION WHEN
OPEN AVOID DIRECT EXPOSURE TO BEAM
ATTENTION RAYONNEMENT LASER VISIBLE ET INVISIBLE EN
CAS D'OUVERTURE EXPOSITION DANGEREUSE AU FAISCEAU

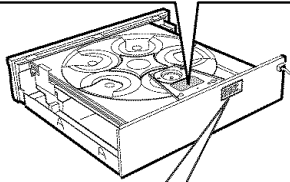

CLASS 1 LASER PRODUCT
LASER KLASSE 1 PRODUKT
LUOKAN 1 LASERLAITE
KLASS 1 LASER APPARAT
PRODUIT LASER DE CLASSE 1

This unit is not disconnected from the AC power source as long as it is connected to the wall outlet, even if this unit itself is turned off. This state is called the standby mode. In this state, this unit is designed to consume a very small quantity of power.

FOR CANADIAN CUSTOMERS
To prevent electric shock, match wide blade of plug to wide slot and fully insert.
This Class B digital apparatus complies with Canadian ICES-003.

Laser component in this product is capable of emitting radiation exceeding the limit for Class 1.

CAUTION
Danger of explosion if battery is incorrectly replaced. Replace only with the same or equivalent type.

CAUTION: READ THIS BEFORE OPERATING YOUR UNIT.

- 1 To assure the finest performance, please read this manual carefully. Keep it in a safe place for future reference.
- 2 Install this sound system in a well ventilated, cool, dry, clean place — away from direct sunlight, heat sources, vibration, dust, moisture, or cold. In a cabinet, allow at least 10 cm of free space all around DVR-C300 and at least 1 m above, 30 cm behind and on both sides of NX-SW300 for adequate ventilation.
- 3 Locate this unit away from other electrical appliances, motors, or transformers to avoid humming sounds.
- 4 Do not expose this unit to sudden temperature changes from cold to hot, nor locate this unit in an environment with high humidity (i.e., a room with a humidifier) to prevent condensation inside this unit, which may cause an electrical shock, fire, damage to this unit, and/or personal injury.
- 5 Avoid installing this unit in a location where foreign objects may fall onto this unit or where this unit may be exposed to liquid dripping or splashing. On the top of this unit, do not place:
 - Other components, as they may cause damage and/or discoloration on the surface of this unit.
 - Burning objects (i.e., candles), as they may cause fire, damage to this unit, and/or personal injury.
 - Containers with liquid in them, as they may fall, spilling the liquid and causing an electrical shock to the user and/or damage to this unit.
- 6 Do not cover this unit with a newspaper, tablecloth, curtain, etc. in order not to obstruct heat radiation. If the temperature inside this unit rises, it may cause fire, damage to this unit, and/or personal injury.
- 7 Do not plug in this unit to a wall outlet until all connections are complete.
- 8 Do not operate this unit upside-down. It may overheat, possibly causing damage.
- 9 Do not use excessive force on switches, knobs and/or cords.
- 10 When disconnecting the power cord from the wall outlet, grasp the plug; do not pull the cord.
- 11 Do not clean this unit with chemical solvents; this might damage the finish. Use a clean, dry cloth.
- 12 Use only the voltage specified on this unit. Using this unit with a higher voltage than specified is dangerous and may cause fire, damage to this unit, and/or personal injury. YAMAHA will not be held responsible for any damage resulting from use of this unit with a voltage other than as specified.
- 13 To prevent damage by lightning, disconnect the power cord from the wall outlet during an electrical storm.
- 14 Do not attempt to modify or fix this unit. Contact qualified YAMAHA service personnel when any service is needed. The cabinet should never be opened for any reason.
- 15 When not planning to use this unit for long periods of time (i.e., vacation), disconnect the AC power plug from the wall outlet.
- 16 Be sure to read the “Troubleshooting” section on common operating errors before concluding that this unit is faulty.
- 17 Before moving this unit, press STANDBY/ON to set the unit in standby mode, then disconnect the AC power plug from the wall outlet.

WARNING

TO REDUCE THE RISK OF FIRE OR ELECTRIC SHOCK, DO NOT EXPOSE THIS UNIT TO RAIN OR MOISTURE.

When playing DTS encoded CDs, excessive noise will be heard from the analog stereo outputs. To avoid possible damage to the audio system, the consumer should take proper precautions when the analog stereo outputs of the player are connected to an amplification system. To enjoy DTS Digital Surround™ playback, an external 5.1-channel DTS Digital Surround™ decoder system must be connected to the digital output of the player.

LASER SAFETY

This unit employs a laser. Due to possible eye injury, only a qualified service person should remove the cover or attempt to service this device.

DANGER

This unit emits visible laser radiation when open. Avoid direct eye exposure to beam.
When this unit is plugged into a wall outlet, do not place your eyes close to the opening of the disc tray and other openings or look inside.

Be sure to place this unit on a level surface.

If you do not do so, this unit's PLAYXCHANGE operation will not function correctly, and may damage the disc(s) and/or this unit itself.

LASER

Type	Semiconductor laser GaAlAs
Wave length	650 nm (DVD) 784 nm (VCD/CD)
Output Power	7 mW (DVD/VCD/CD)
Beam divergence	60 degrees

PLAYXCHANGE

Capable of changing discs without interrupting current disc playback.
Pressing PLAYXCHANGE on the front panel to open the disc tray and reload or unload discs during playback.



Active Servo Processing Subwoofer System with a built-in power amplifier.
This subwoofer system (NX-SW300) employs Advanced Yamaha Active Servo Technology which YAMAHA has developed for reproducing higher quality super-bass sound. This super-bass sound adds a more realistic, theater-in-the-home effect to your stereo system.

Patent Information

Manufactured under license from Dolby Laboratories. "Dolby", "Pro Logic" and the double-D symbol are trademarks of Dolby Laboratories.



"DTS" and "DTS Digital Surround" are registered trademarks of Digital Theater Systems, Inc.



"DivX", "DivX Certified", and associated logos are trademarks of DivX Networks, Inc and are used under license.

This product incorporates copyright protection technology that is protected by method claims of certain U.S. patents and other intellectual property rights owned by Macrovision Corporation and other rights owners. Use of this copyright protection technology must be authorized by Macrovision Corporation, and is intended for home and other limited viewing uses only unless otherwise authorized by Macrovision Corporation. Reverse engineering or disassembly is prohibited.

Playable disc formats

This receiver can play the disc types associated with the logos shown below. (Do not attempt to load any other type of disc into the receiver, or the receiver may be damaged.)



Contents

Features	1
Contents	2
Introduction	4
General Information	
About the main unit	5
Supplied accessories	5
Functional Overview	
Remote control	6
Front panel (DVR-C300)	8
Rear panel (DVR-C300)	9
Connections	
Placing the speakers	10
Placing the center speaker	10
Hanging on a wall	10
Attaching to a wall	10
Connecting the DVD receiver and speakers to the subwoofer	11
Connecting a TV	13
Using S-video output	13
Using the composite video output	13
Connecting a progressive scanTV	14
Using component video output (Y PB PR)	14
Placing the speakers and subwoofer	14
Connecting FM/AM antennas	15
Connecting the power cord	15
Connecting external AV components	16
Connecting a VCR or Cassette Deck	16
Viewing and listening to playback	16
Using the VCR for recording DVD playback	16
Connecting digital audio components	17
Listening to playback	17
Getting Started	
Inserting batteries into the remote control	18
Using the remote control	18
Setting the TV	19
Selecting the color system that matches your TV	19
Setting the TV display	19
Setting language preferences	20
On-Screen Display (OSD) language	20
Audio, Subtitle and Disc menu languages	20
Setting speaker channels	21

Disc Operations	
Playing discs	22
Auto Eco Power standby mode	22
Basic playback controls	22
Selecting various repeat/shuffle functions	22
Repeat play mode	22
Repeating a section within a chapter/ track	23
Shuffle (except DVD/DVD-Audio/VCD/SVCD/DivX)	23
Other operations for video playback (DVD/VCD/SVCD)	24
Using the disc menu	24
Displaying disc information and the current status	24
Zooming in	24
Resuming playback from the last stopped point	25
Advancing by frame	25
Changing sound track language	25
Changing subtitle language (DVD only)	25
Viewing from another angle (DVD only)	25
Selecting a title (DVD only)	25
Playback Control (PBC) (VCD only)	25
Preview Function	26
Playing MP3/JPEG/DivX® discs	27
Playing MP3 music and a JPEG picture simultaneously	27
Playing Super Audio CDs (SA-CDs)	27
Special features for picture disc playback	28
Preview Function	28
Zooming pictures	28
Multi-angle playback	28
Scan Effect	28
DVD Setup Menu Options	
General Setup Menu	29
Selecting DVD-Audio/Video mode	29
Locking/Unlocking disc for viewing	29
Programming disc tracks (except for Picture CD/MP3/SA-CD discs)	29
OSD language	30
Screen Saver – (on/off)	30
DivX®VOD registration code	30
Audio Setup Menu	31
Speaker Setup	31
CD upsampling	31
Night Lighting Mode – (on/off)	31

Video Setup Menu	31
TV Type	31
TV Display	31
Progressive function – (on/off)	32
Pictures settings	32
Selecting the black level (U.S.A. model only)	32
Closed Caption (U.S.A. model only)	33
Preference Setup Menu	33
Audio, subtitle and disc menus	33
Restricting playback with Parental Control	33
PBC	34
MP3/JPEG Menu – (on/off)	34
Changing the password	34
Restoring to original settings	34

Tuner Operations

Tuning radio stations	35
Presetting radio stations	35
Using Plug and Play	35
Automatic presetting	35
Manual presetting	35
Selecting a preset radio station	36
Deleting a preset radio station	36
Setting frequency step (Australia model only)	36

Sound Controls

Selecting surround sound	37
Selecting digital sound effects	37
Adjusting the treble/bass level	37

Volume Control and Other Functions

Adjusting the volume level	38
Switching to active mode	38
Switching to eco power standby mode	38
Setting remote control codes	38

Other Functions

Controlling other components	39
TV operations	39
Cable and satellite tuner operations	39
Dimming the display screen	40
Setting the sleep timer	40
Recording on an external AV component	40

Troubleshooting	41
------------------------------	----

Glossary	44
-----------------------	----







Specifications	45
-----------------------------	----

Introduction

Thank you for purchasing this unit. This Owner's Manual explains the basic operation of this unit.

Region Codes

The unit is designed to support the Region Management System. Check the regional code number on the disc package. If the number does not match the unit's region number (see table below, or see back of unit), the unit may be unable to play the disc.

Model	Region number of the unit	Playable discs
U. S. A. and Canada models		 
Australia model		 

Notes About Discs

- This receiver is designed for use with the following discs: Super Audio CD (SA-CD), DVD-Video, Video CD, Super Video CD, Audio CD, CD-R, CD-RW, DVD-Audio, DVD+RW, DVD+R, DVD-R and DVD-RW.

This receiver can play:

- MP3 and picture (Kodak, JPEG) files recorded on CD-R(W).
 - JPEG/ISO 9660 format
 - Maximum 30 character display
- DivX® disc on CD-R[W]/DVD+R[W]/DVD-R[W](3.11, 4.x and 5.x)
- CD-R and CD-RW cannot be played unless finalized.
- Some discs cannot be played depending on the recording conditions, such as the PC environment and application software. The characteristics and application software. The characteristics and condition of some discs; materials, scratches, curvature, etc., may result in playback failure.
- Be sure to use only CD-R and CD-RW discs made by reliable manufacturers.
- Do not use any non-standard shaped discs (heart-shaped, etc.).
- Do not use discs with tape, seals, or paste on their surface. Doing so may damage this receiver.
- Do not use discs affixed with labels printed by a commercially available label printer.

Cleaning Discs

- When a disc becomes dirty, clean it with a cleaning cloth. Wipe the disc from the center out. Do not wipe in a circular motion.
- Do not use solvents such as benzine, thinner, commercially available cleaners, or antistatic spray intended for analog records.

Avoid high temperatures, moisture, water and dust

- Do not expose the system, batteries or discs to humidity, rain, sand or excessive heat (caused by heating equipment or direct sunlight). Always keep the disc tray closed to avoid getting dust on the lens.

Avoid condensation problem

- The lens may cloud over when the receiver is suddenly moved from cold to warm surroundings, making it impossible to play a disc. Leave the receiver in the warm environment until the moisture evaporates.

Disc care

- Write only on the printed side of a CD-R/CD-RW and only with a soft felt-tipped pen.
- Handle the disc by its edge; do not touch the surface.

Cabinet care

- Use a soft cloth slightly moistened with a mild detergent solution. Do not use a solution containing alcohol, spirits, ammonia, or abrasives.

Choosing a suitable location

- Place the receiver on a flat, hard, and stable surface.

About the main unit

DVD Receiver
(DVR-C300)



Subwoofer
(NX-SW300)

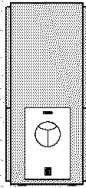

Front Speakers
(NX-F300)
(DVX-C300 only)

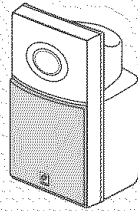

(x2)

Center Speaker
(NX-C300)
(DVX-C300 only)

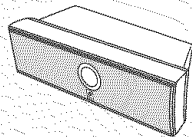

Surround
Speakers
(NX-S300)
(DVX-C300 only)

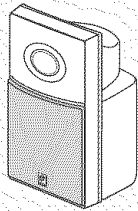

(x2)

Supplied accessories

FM Wire Antenna

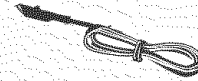

AM Loop Antenna

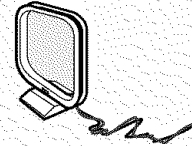

Remote Control
and Batteries

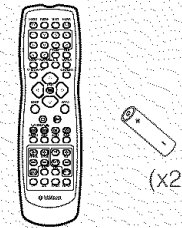

(x2)

Video Pin Cable

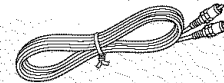

System Control
Cable

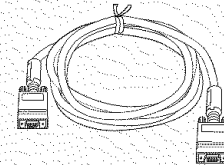

Speaker Cables
(12m x2, 5m x3)
(DVX-C300 only)

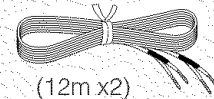

(12m x2)



(5m x3)

Fasteners (2 Sets)
(DVX-C300 only)

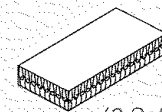

(2 Sets)

Functional Overview

Remote control

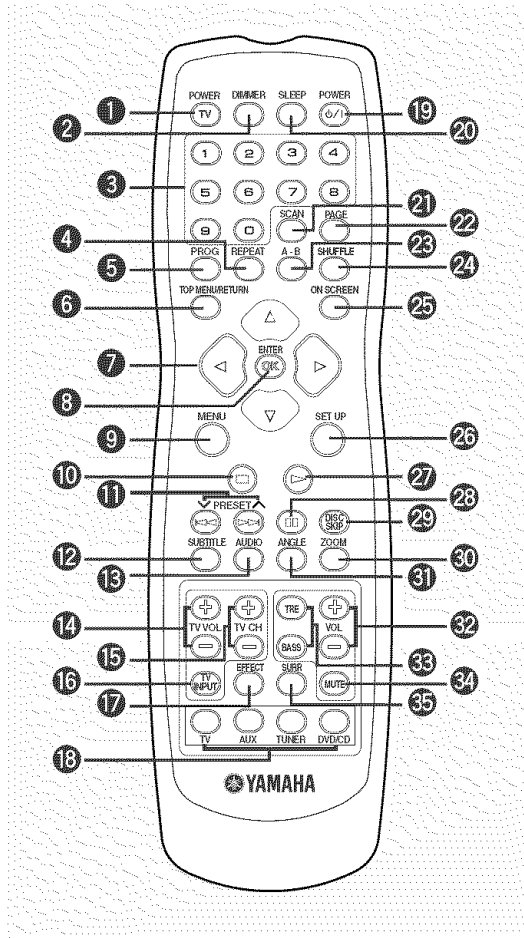

1 POWER (TV)

- Turns the TV on, or sets it to the standby mode.

2 DIMMER

- Selects different levels of brightness for the display panel.

3 Numeric keypad (0-9)

- Enters a track/title number of the disc.
- Enters a number of a preset radio station.

4 REPEAT

- Selects various repeat modes.

5 PROG

- DVD/CD: starts programming.
- TUNER: starts *automatic/manual preset programming.

6 TOP MENU/RETURN

- Returns to the previous menu.
- Displays the top-level disc menu (if available).

7 Cursor (◀ / ▶ / ▲ / ▼)

- Selects movement direction in the menu.
- TUNER: press left or right to tune the radio frequency.
- TUNER: press up or down to select auto tuning.

8 ENTER (OK)

- Confirms a selection.

9 MENU

- Enters or exits the disc contents menu.
- For VCD version 2.0 only; In stop mode, turns on/off playback control (PBC) mode. During playback, returns to the main menu.

10 ■

- Exits an operation.
- DVD/CD: stops playback.
- DVD/CD: holding down the button will open and close the disc tray.
- TUNER: erases a preset radio station.*

11 ∨ PRESET ∧ (◀◀ / ▶▶)

- DVD/CD: searches backward/forward* or moves to the start of a disc track.
- TUNER: press to select a preset radio station.

* = Press and hold the button for more than two seconds.

12 SUBTITLE

- Selects a subtitle language.

13 AUDIO

- Selects an audio language (DVD) or an audio channel (VCD).

14 TV VOL (+ / -)

- Adjusts the TV volume.

15 TV CH (+ / -)

- Switches the TV channel.

16 TV INPUT

- Switches the TV input.

17 EFFECT

- Selects a sound effect.

18 Input selection buttons

- Selects the appropriate active source mode.
- TV: switches to TV input.
- AUX: switches to AUX ANALOG/AUX DIGITAL input.
- TUNER: switches tuner (FM/AM) input.
- DVD/CD: switches to DVD/CD mode.

19 POWER (⏻/⏻)

- Turns the DVD receiver on, or set it to the standby mode.

20 SLEEP

- Sets the sleep timer.

21 SCAN

- Plays the first 6 seconds or less of each track/ chapter on the disc.

22 PAGE

- Turns the pages of DVD-Audio still pictures.

23 A-B

- Repeats a specific section on a disc.

24 SHUFFLE

- Plays tracks in random order.

25 ON SCREEN

- Displays the current status or disc information.

26 SET UP

- Enters or exits the system setup menu.

27 ▶

- DVD/CD: starts playback.

28 ||

- DVD/CD: pauses playback.

29 DISC SKIP

- Selects another disc.

30 ZOOM

- Enlarges or reduces the TV screen picture.

31 ANGLE

- Selects a DVD disc camera angle (if available).

32 VOL (+ / -)

- Adjusts the volume level.

33 TRE/BASS

- Selects the TREBLE (high tone) or BASS (low tone) sound mode.
Use the VOLUME control to change the tone level.

34 MUTE

- Mutes or restores the volume.

35 SURR

- Selects multi-channel surround or stereo mode.

Functional Overview

Front panel (DVR-C300)

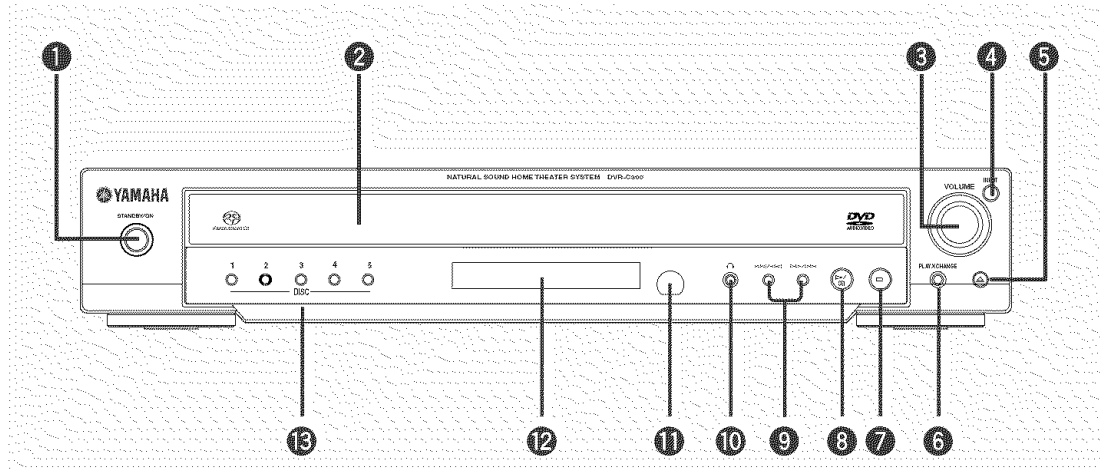

1 STANDBY/ON

- Turns the DVD receiver on, or set it to the standby mode.

2 Disc tray

- Load up to 5 discs in the disc tray.

3 VOLUME

- Adjusts the volume level.

4 INPUT

- Selects an input source or sets the priority level for the audio input signals.

5 ▲

- Opens/closes the disc tray.

6 PLAYXCHANGE

- Use to change discs not being played during playback.

7 ■

- Exits an operation.
- DVD/CD: stops playback.
- TUNER: erases a preset radio station.*

8 ▶ / ||

- DVD/CD: starts/pauses playback.
- TUNER: starts preset radio station installation in Plug & Play mode.

9 ◀◀ / ▶▶, ◀◀ / ▶▶

- DVD/CD: searches backward/forward* or moves to the start of a disc track
- TUNER: tunes the radio preset up/down.

10 🎧 Head phone jack

- Connects headphones.

11 Remote control sensor

- Point the remote control towards this sensor.

12 System display panel

13 DISC (1, 2, 3, 4, 5)/LEDs

- Use to select and directly playback the preferred disc.
- Each LED flashes green when the button is selected.

* = Press and hold the button for more than two seconds.

Rear panel (DVR-C300)

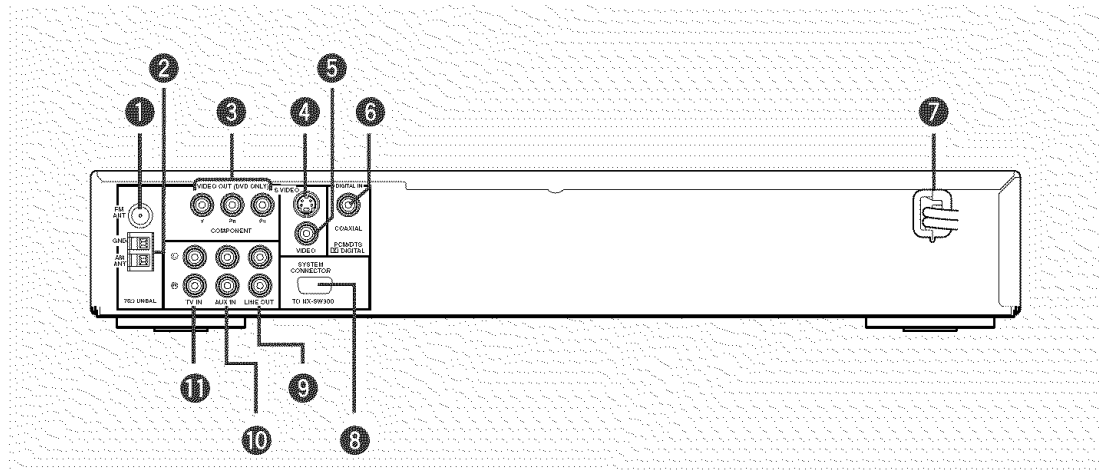

1 FM ANT terminal

- Connect the FM antenna.

2 GND and AM ANT terminals

- Connect the AM loop antenna.

3 COMPONENT VIDEO OUT

- Connect the the Y PB/CB PR/CR jacks on your TV.

4 S VIDEO output

- Connect to the S-video jack on your TV/VCR.

5 VIDEO output

- Connect to the video (composite) jack on your TV.

6 DIGITAL IN

- Connect to the DIGITAL OUT jack on your digital audio component.

7 AC power cord

- Connect to a standard AC outlet.

8 TO NX-SW300 terminal

- Connect the subwoofer.

9 LINE OUT

- Connect to the AUDIO IN jacks on your VCR.

10 AUX IN

- Connect to the AUDIO OUT jacks on your VCR or cassette deck.

11 TV IN

- Connect to the corresponding AUDIO OUT jacks on your TV.

Connections

This section provides information on installation and connection methods for DVX-C300 speakers. For DVX-C300SW, refer to the manual provided with your speakers.

Placing the speakers

Placing the center speaker

When placing the center speaker on top of the TV, use the supplied fasteners to secure the speaker.

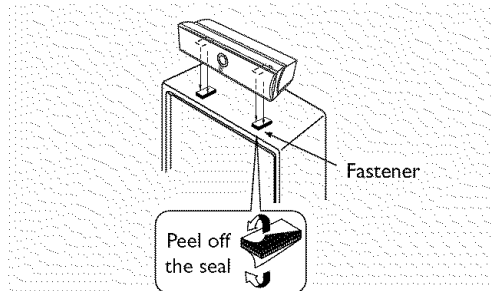

- 1 Peel off the seals on one side of the fasteners and attach them to the bottom of the center speaker.
- 2 Peel off the seals on the other side of the fasteners and attach them to the top of the TV.

Notes:

- Do not place the speaker on the TV if the top of the TV is not level or if it is narrower than the bottom surface of the speaker. Doing so may cause the speaker to fall. In this case, place the speaker inside a TV rack or on a level floor.
- Before attaching the fasteners to the TV, clean the surface with a dry cloth. A dirty or wet surface may weaken the adhesive force and cause the speaker to fall.
- Do not touch the bonding surfaces of the fasteners after peeling off the seals. Doing so may weaken the adhesive force and cause the speaker to fall.

Hanging on a wall

You can hang the speakers (front and surround only) on a wall using a commercially available bracket and screws (Diameter: 6 mm). Attach a bracket firmly to the rear of the speakers using screws. Then mount a screw on the wall where the speaker is to be hung and hook the speaker securely onto the mounted screw.

Note:

- Do not use screw threads measured in inches for this installation. Use metric screw threads only.

Attaching to a wall

You can attach the speakers (front and surround only) to a wall using commercially available screws (Diameter: 3.5 to 4 mm (1/8" to 5/32"), Length: 20 mm (25/32") or more). One speaker requires two screws. To attach all speakers to a wall, you need to prepare eight screws.

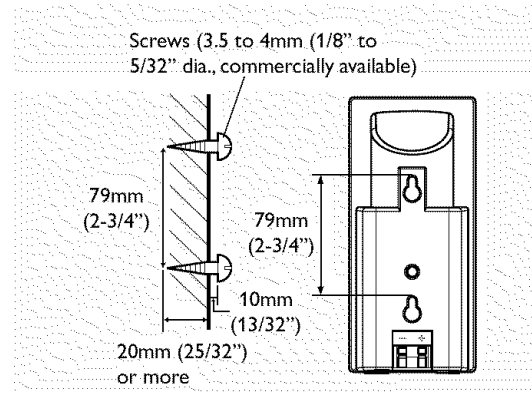

- 1 Install two screws in the wall where you want to place the speaker.
- 2 Hang the speaker on the screws using the holes in the back of the speaker.

Note:

- After attaching each speaker, check that the speaker is fixed securely. YAMAHA will bear no responsibility for any accidents caused by improper installations.

Connecting the DVD receiver and speakers to the subwoofer

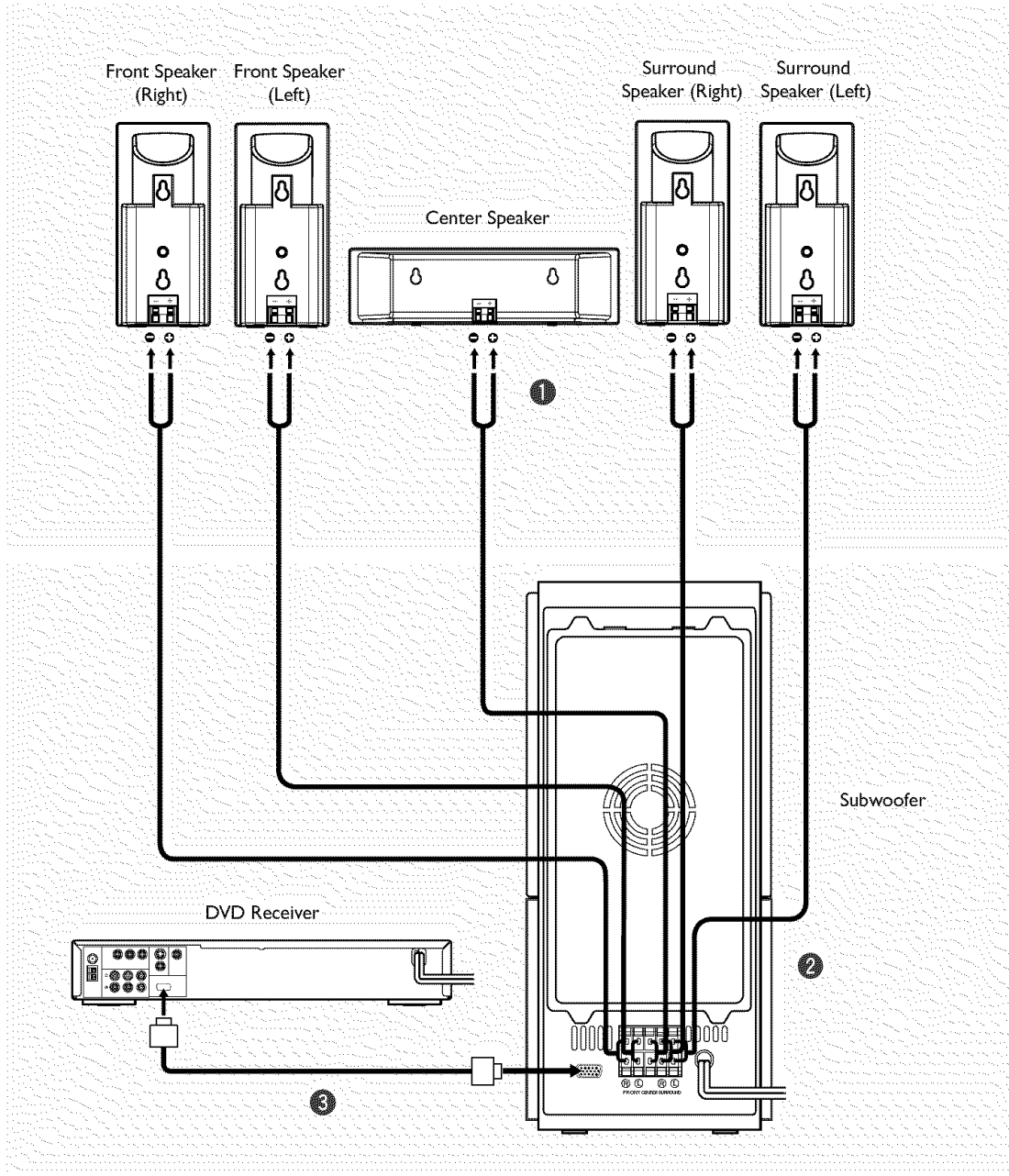

Connections

- 1 Connect the speaker cable with the white line to the + connector on the front/center/surround speaker and with the black band to the - connector:

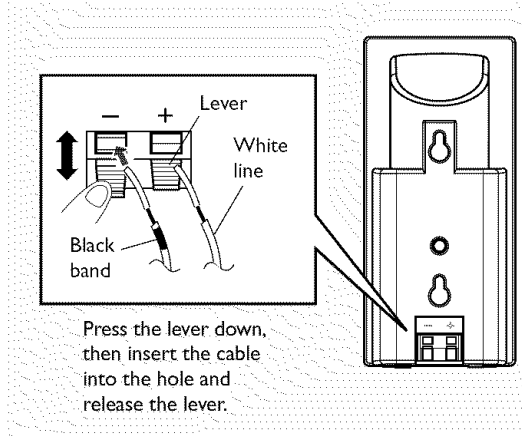

- 2 Connect the speaker cable with the white line to the + connector of each terminal on the subwoofer and with the black band to the - connector:

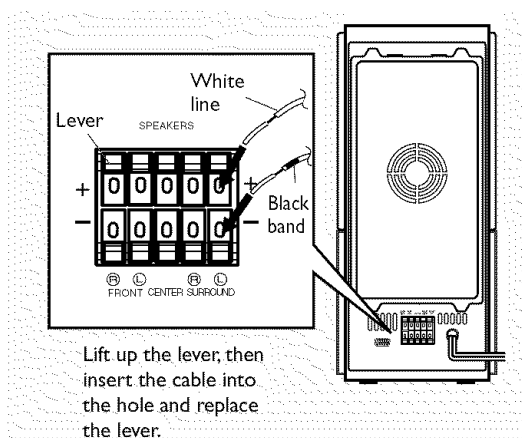

- 3 Connect the subwoofer to the DVD receiver using the system control cable from the subwoofer to the **TO NX-SW300** terminal at the rear of the DVD receiver:

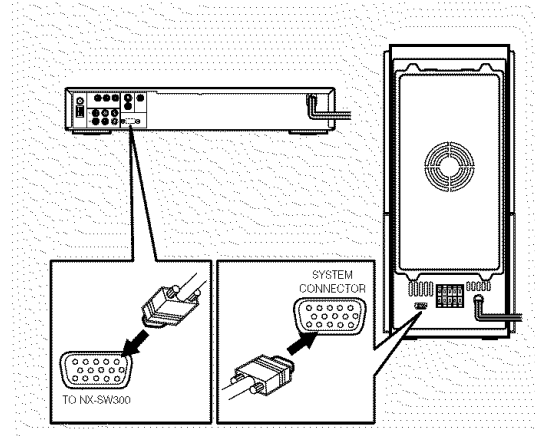

Notes:

- Ensure that the speaker cables are correctly connected. Improper connections may damage the system due to a short-circuit.
- When connecting the speakers, fix the speaker cables in place so that cables do not loosen. If your foot or hand accidentally gets caught on a loose speaker cable, the speaker may fall.
- To prevent unwanted noise, do not place the subwoofer too close to the DVD receiver, AC power adaptor, TV or other sources of radiation.

Connecting a TV

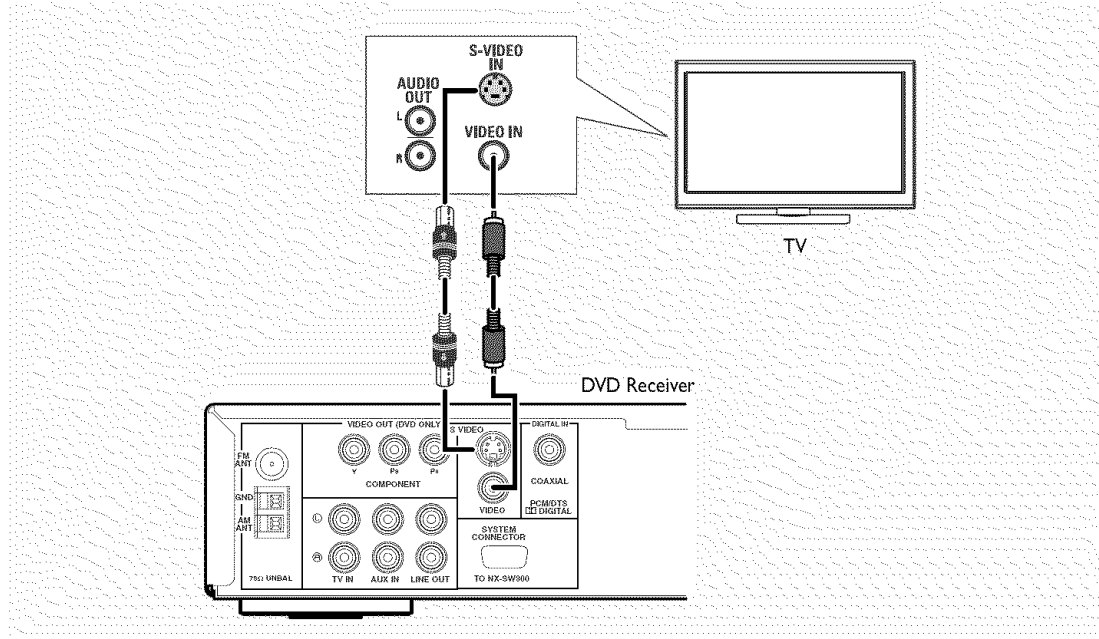

IMPORTANT!

- You only need to make one video connection from the following options, depending on the capabilities of your TV.
- Connect the DVD receiver directly to the TV.

Note:

- To hear the TV channels through this DVD receiver, use the audio cables (white/red - not supplied) to connect TV IN jacks to the corresponding AUDIO OUT jacks on the TV.

Using S-video output

- S-(separate)video connections achieve a clearer picture than composite video connections. Use an S-video cable (not supplied) to connect the DVD receiver's **SVIDEO** output to the S-video input jack (or Y/C or S-VHS jack) on the TV.

Using the composite video output

- Use a composite video cable (yellow -supplied) to connect the DVD receiver's **VIDEO** output to the video input jack (or A/V In/Video In/Composite/Baseband jack) on the TV.

Connections

Connecting a progressive scan TV

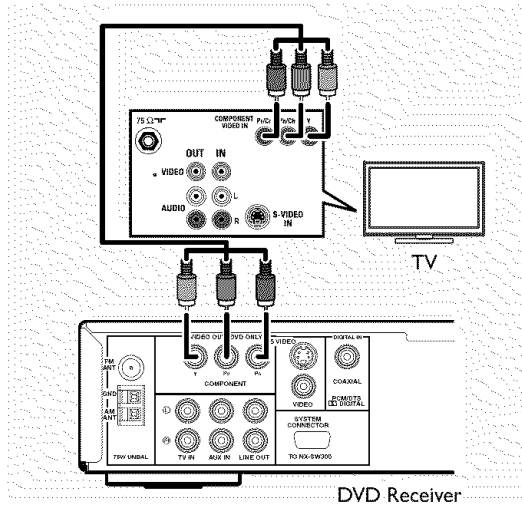

IMPORTANT!

- Progressive scan video quality is only available when using **Y Pb Pr** in conjunction with a progressive scan TV.

Using component video output (Y Pb Pr)

- 1 Use the component video cables (red/blue/green - not supplied) to connect the DVD receiver's **Y Pb Pr** jacks to the corresponding component video input jacks (or Y Pb/Cb Pr/Cr/YUV jacks) on the TV.
- 2 Activate the progressive scan function (see "Progressive function-(on/off)" on page 32).

Placing the speakers and subwoofer

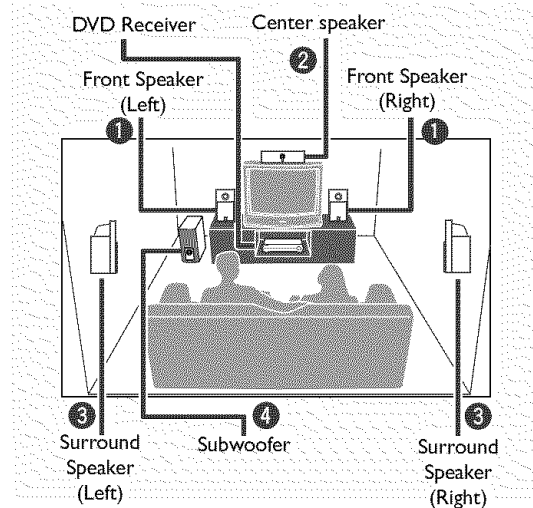

For the best possible surround sound, all of the speakers (except the subwoofer) should be placed at the same distance from the listening position.

- 1 Place the front left and right speakers at equal distances from the TV.
- 2 Place the center speaker above the TV so that the center channel's sound is localized.
- 3 Place the surround speakers at normal listening ear level facing each other or hang on the wall.
- 4 Place the subwoofer on the floor near the TV.

Notes:

- To avoid magnetic interference, do not position the front speakers too close to your TV.
- Allow adequate ventilation around the DVD receiver and subwoofer.

Connecting FM/AM antennas

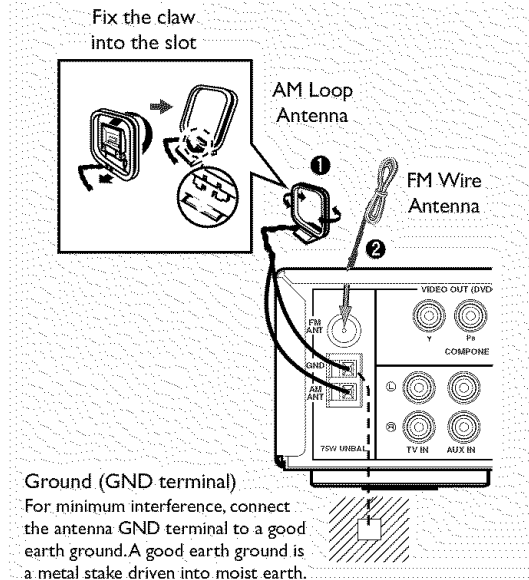

- 1 Connect the supplied AM loop antenna to the **AM ANT** terminal. Place the AM loop antenna on a shelf or attach it to a stand or wall.
- 2 Connect the supplied FM wire antenna to the **FM ANT** terminal. Extend the FM wire antenna and fix its ends to the wall.
For better FM stereo reception, connect an external FM antenna (not supplied).

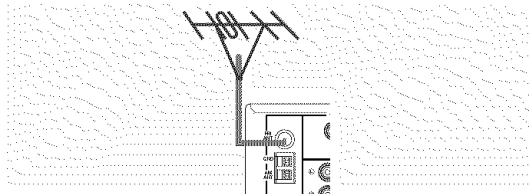

Notes:

- Adjust the position of the antennas for optimal reception.
- Position the antennas as far as possible from your TV, VCR or other sources of radiation to prevent unwanted interference.

Connecting the power cord

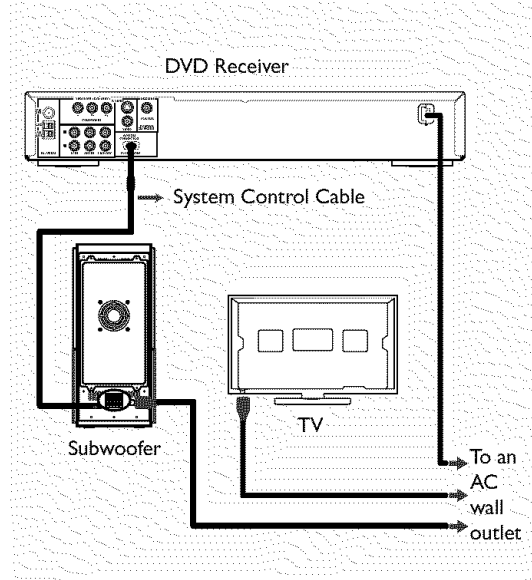

After everything is connected properly, plug the AC power cord into the power outlet. Never make or change any connections with the power switched on.

Note:

- Refer to the type plate on the rear of the DVD receiver and subwoofer for identification and supply ratings.

Connections

Connecting external AV components

If you connect external AV equipment such as a VCR, cassette deck or digital audio component to the following AV jacks on the DVD receiver, you can enjoy those AV sources with the DVD receiver. Also, you can record AV sources played on the DVD receiver using the recording equipment. This section provides some examples of other AV equipment connections. For information on your AV equipment, refer to the manual for it.

Connecting a VCR or Cassette Deck

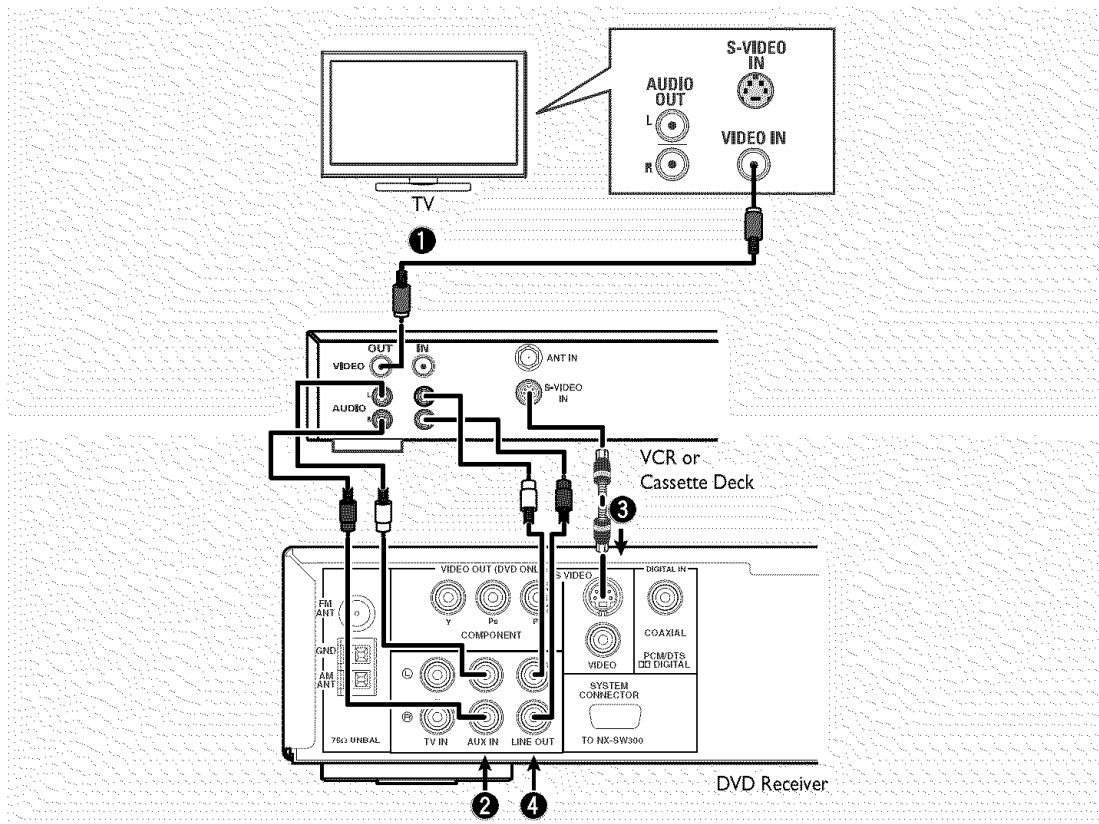

Viewing and listening to playback

- 1 Connect the VCR or cassette deck to the TV as shown.
- 2 Connect the DVD receiver's **AUX IN** to the **AUDIO OUT** jacks on the VCR or cassette deck.

Before starting operation, press **AUX** to select "AUX/ANALOG" in order to activate the input source.

Using the VCR for recording DVD playback

Some DVDs are copy-protected. You cannot record or dub protected discs using a VCR.

- 3 Connect the DVD receiver's **S VIDEO** output to the **S-VIDEO IN** jack on the VCR.
- 4 Connect the DVD receiver's **LINE OUT** to the **AUDIO IN** jacks on the VCR. This will allow you to make analog stereo (two channels, right and left) recordings.

Connecting digital audio components

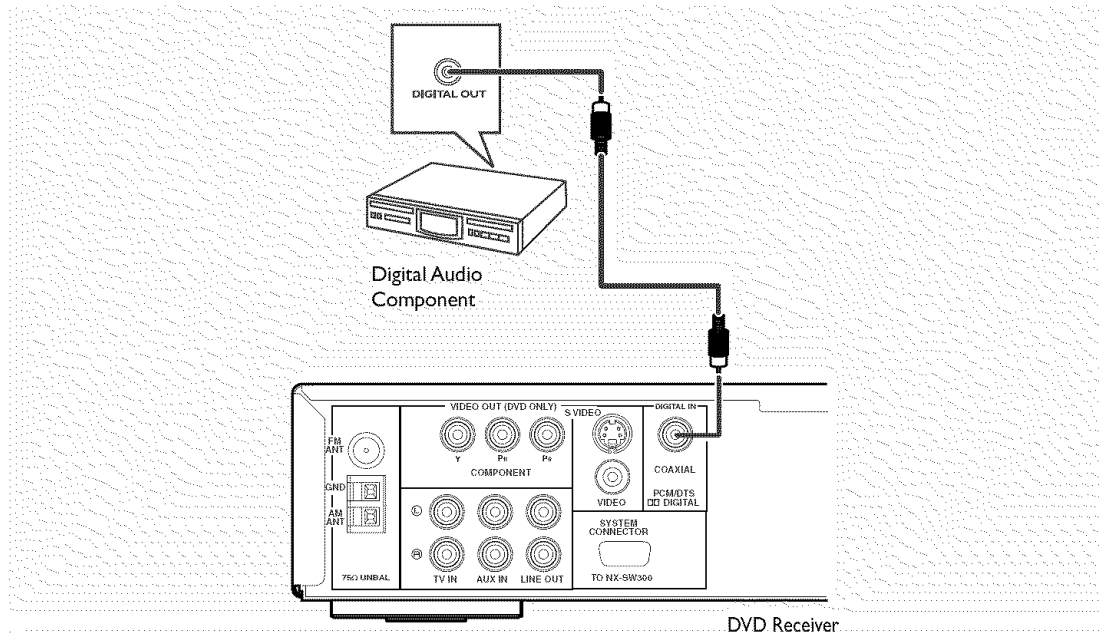

Listening to playback

- Connect the DVD receiver's **DIGITAL IN** to the **DIGITAL OUT** jack on a digital audio component.

Before starting operation, press **AUX** repeatedly to select "AUX/DIGITAL" in order to activate the input source.

Notes:

- You cannot hear or record the SA-CD or MP3-CD playback if you use a digital connection.
- For playback through a digital connection, set the digital output of that player to PCM format.
- Always refer to the owner's manual of the connected component for complete connection and usage details.

Getting Started

Inserting batteries into the remote control

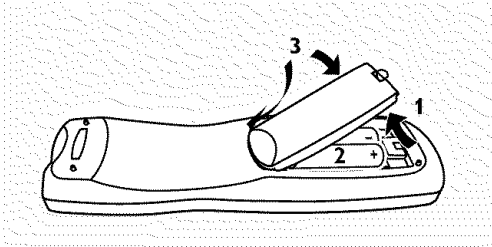

- 1 Open the battery compartment.
- 2 Insert two batteries type R06 or AA, following the indications (+/-) inside the compartment.
- 3 Close the cover.

To replace the batteries

If the batteries grow old, the effective operation distance of the remote control decreases considerably. If this happens, replace the batteries with two new ones as soon as possible.

Notes:

- Do not use an old battery together with new one.
- Do not use different types of batteries (for example, alkaline and manganese) together. Each type of battery has its own characteristics even if they are similar in shape.
- If the batteries run out, immediately remove them from the remote control to prevent an explosion or acid leak.
- Dispose of the batteries according to the regional regulations.
- If a battery starts leaking, dispose of it immediately. Be careful not to let leaking battery acid come into contact with your skin or clothing. Before inserting new batteries, wipe the compartment clean.
- Replace the batteries within two minutes to preserve the memory in the remote control.

Using the remote control

- 1 Use the Remote Control within 6 m (20 feet) of the DVD receiver and point it toward the Remote control sensor.

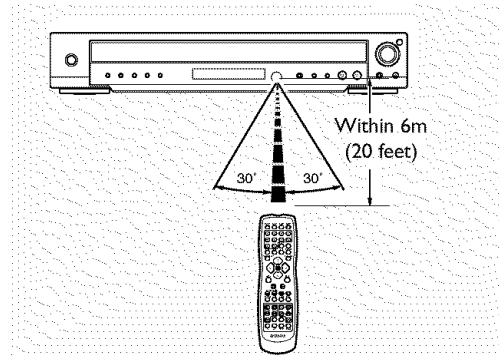

- 2 Press **Input selection buttons** on the remote control to select the mode you wish to control (for example TV, DVD/CD).
→ The selected source mode appears in the display panel.
- 3 Then select the desired function (for example ►/◄◄ / ►►).

The remote control can also operate a television, cable TV or satellite connected to the DVD receiver. However, it is first necessary to enter the remote control code for the equipment in the remote control's memory (see "Setting remote control codes" on page 38).

Notes:

- Be careful not to spill liquid on the remote control.
- Be careful not to drop the remote control.
- Do not leave the remote control in the following places:
 - hot or humid places, such as near a heater or in a bathroom
 - extremely cold places
 - dusty places

Setting the TV

IMPORTANT!

Make sure you have completed all the necessary connections. (See “Connecting a TV” on page 13)

- 1 Press **DVD/CD**.
→ “**DVD/CD**” appears on the display panel.
- 2 Turn on the TV and set to the correct video-in channel. You should see the background screen on the TV.
→ Usually this channel is between the lowest and highest channels and may be called **FRONT**, **A/V IN** or **VIDEO**. See your TV manual for more details.
→ Or, you may go to channel 1 on your TV, then press the Channel down button repeatedly until you see the Video In channel.
→ Or, the TV remote control may have a button or switch that chooses different video modes.

Selecting the color system that matches your TV

In order for a DVD to play on this DVD receiver, the color system of the DVD, the TV and the DVD receiver should match. Before changing the TV system, determine the color system of your TV.

- 1 In DVD/CD mode, press **SET UP**.
- 2 Press **▶** repeatedly to select [VIDEO SETUP PAGE].
- 3 Press **▲▼** to highlight [TV TYPE], then press **▶**.

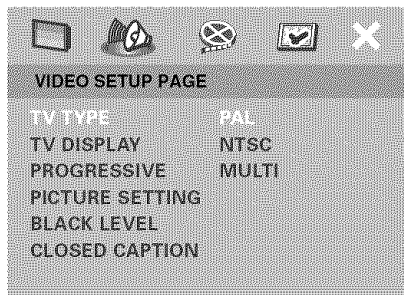

- 4 Press **▲▼** to highlight one of the options below:

PAL – Select this if the connected TV has the PAL color system. It will change the video signal of an NTSC disc and output it to PAL format.

NTSC – Select this if the connected TV has the NTSC color system. It will change the video signal of a PAL disc and output it to NTSC format.

MULTI – Select this if the connected TV is compatible with both NTSC and PAL (multi-system). The output format will be in accordance with the video signal of the disc.

- 5 Select a setting and press **ENTER (OK)**.
→ Follow the instructions shown on the TV to confirm the selection (if any).
→ If a blank/distorted TV screen appears, wait for 15 seconds for auto recovery to activate.

Setting the TV display

Set the aspect ratio of the DVD receiver according to the TV you have connected. The format you select must be available on the disc. If it is not, the TV display setting will not affect the picture during playback.

- 1 In DVD/CD mode, press **SET UP**.
- 2 Press **▶** repeatedly to select [VIDEO SETUP PAGE].
- 3 Press **▲▼** to highlight [TV DISPLAY], then press **▶**.

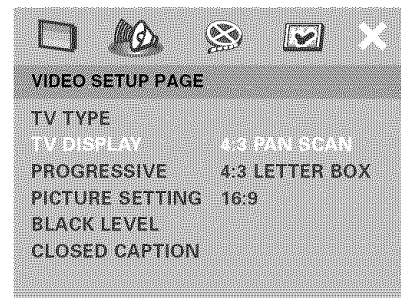

- 4 Press **▲▼** to highlight one of the options below:

4:3 PAN SCAN – Select this if you have a conventional TV and want both sides of the picture to be trimmed or formatted to fit your TV screen.

4:3 LETTER BOX – Select this if you have a conventional TV. In this case, a wide picture with black bands on the upper and lower portions of the TV screen will be displayed.

16:9 – Select this if you have a wide-screen TV.

- 5 Select a setting and press **ENTER (OK)**.

TIPS: To return to the previous menu, press **◀**.
To clear the menu, press **SET UP**.

Getting Started

Setting language preferences

You can select your preferred language settings so that this receiver will automatically switch to your preferred language for you whenever you load a disc. If the language selected is not available on the disc, the disc's default setting language will be used instead. The OSD (on-screen display) language for the system menu will remain as you set it, regardless of various disc languages.

On-screen display (OSD) language

- 1 In DVD/CD mode, press **SET UP**.
- 2 Press **▶** to select [GENERAL SETUP PAGE].
- 3 Press **▲▼** to highlight [OSD LANGUAGE], then press **▶**.

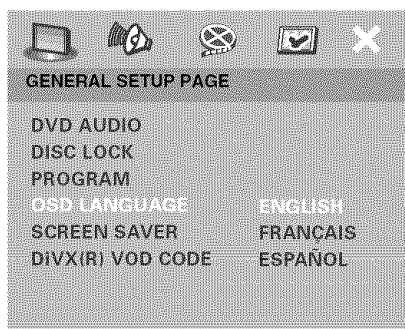

- 4 Press **▲▼** to select a language and press **ENTER (OK)** to confirm.

Audio, Subtitle and Disc menu languages

- 1 Press **■** twice to stop playback (if any), then press **SET UP**.
- 2 Press **▶** repeatedly to select [PREFERENCE PAGE].
- 3 Press **▲▼** to highlight one of the options below at a time, then press **▶**.
 - [AUDIO] (disc's soundtrack)
 - [SUBTITLE] (disc's subtitles)
 - [DISC MENU] (disc's menu)



- 4 Press **▲▼** to select a language and press **ENTER (OK)** to confirm.

If the language you want is not in the list, then select [OTHERS].

Use the **numeric keypad (0-9)** on the remote control to enter the 4-digit language code 'XXXX' (see "Language Codes" at the end of this manual) and press **ENTER (OK)** to confirm.

- 5 Repeat steps 3~4 for other settings.

TIPS: To return to the previous menu, press **◀**.
To clear the menu, press **SET UP**.

Setting speaker channels

You can adjust the delay times (for center and surround speakers only) and volume level for individual speakers. These adjustments let you optimize the sound of your system to best suit your surroundings and setup.

IMPORTANT!

Press the **SURR** button on the remote control to select the multi-channel surround mode before adjusting the speaker settings.

- 1 Press **■** to stop playback, then press **SET UP**.
- 2 Press **▶** repeatedly to select [AUDIO SETUP PAGE].
- 3 Press **▲▼** to highlight [SPEAKER SETUP], then press **▶**.

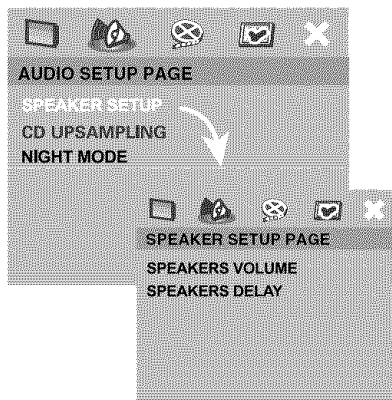

- 4 Press **▲▼** to select a language and press **ENTER (OK)** to confirm.
- 5 Press **▲▼** to highlight one of the options below, then press **▶**.

[SPEAKERS VOLUME] – Volume level setting for individual speakers (–6dB ~ +6dB).

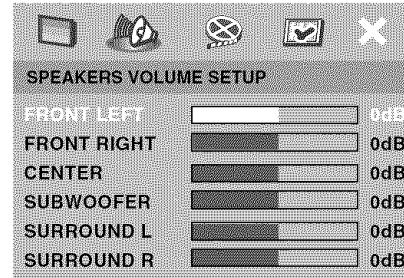

[SPEAKERS DELAY] – Delay time settings is in relation to the listening position/distance for center and surround speakers (0MS ~ 15MS).

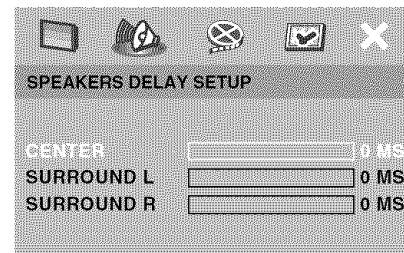

- 6 Press **◀▶** to adjust the setting that best suit your surround sound needs.
- 7 Press **ENTER (OK)** to confirm.

Notes:

- Use a longer delay time settings when the surround speakers are closer to the listener than the front speakers.
- A test tone will be automatically generated to help you judge the sound level of each speaker.

TIPS: To return to the previous menu, press **◀**.
To clear the menu, press **SET UP**.

Disc Operations

IMPORTANT!

- If the inhibit icon (Ⓞ or X) appears on the TV screen when a button is pressed, the function for that button is not available on the current disc or at the current time.
- DVD discs and players are designed with regional restrictions. Before playing a disc, make sure the disc is for the same zone as your receiver.
- Do not push on the disc tray or put any objects other than discs on the disc tray. Doing so may cause the disc player to malfunction.

Playing discs

- 1 Press **DVD/CD** until "DVD/CD" appears on the display panel.
- 2 Turn on the TV power and set to the correct Video In channel (see "Setting the TV" on page 19).
→ You should see the background screen on the TV.
- 3 Press **▲** once to open the disc tray and load a disc, then press the same button again to close the disc tray.

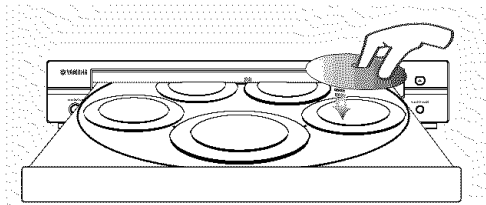

→ Make sure the disc label is facing up.

- 4 Playback will start automatically.
→ To playback a specific disc directly, press **DISC SKIP** repeatedly on the remote control or press **DISC (1, 2, 3, 4, 5)** on the front panel.
→ Press **PLAYXCHANGE** on the front panel to open the disc tray and reload or unload discs without interrupting current disc playback.
→ Playback will stop after all discs have been played.
→ If a disc menu shows on the TV, see "Using the disc menu" on page 24.
→ If the disc is locked by parental control, you must enter your six-digit password (see "Restricting playback with Parental Control" on page 33).

Auto Eco Power standby mode

This is a power-saving feature. The receiver will automatically switch to Eco Power standby mode if you do not press any buttons for 30 minutes after a disc has stopped playing.

Basic playback controls

Pausing playback

- During playback, press **II (▶II)**.
→ To resume normal playback, press **▶** (or **▶II**).

Selecting another track/chapter

- Press **◀◀ / ▶▶** or use the **numeric keypad (0-9)** to enter a track/chapter number.
→ During repeat playback of a track/chapter, pressing **◀◀ / ▶▶** will replay the same track/chapter.

Searching backward/forward

- Press and hold **◀◀ / ▶▶**. To resume normal playback, press **▶** (or **▶II**).
→ While searching, pressing **◀◀ / ▶▶** again will increase the search speed.

Stopping playback

- Press **■**.

Selecting various repeat/shuffle functions

Repeat play mode

Repeat chapter/title/disc (DVD-V)

Each time you press **REPEAT**, the front display changes as follows:

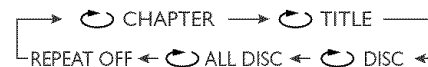

- ◻ CHAPTER*: repeats the current chapter
- ◻ TITLE: repeats the current title
- ◻ DISC*: repeats the entire disc
- ◻ ALL DISC: repeats all discs loaded in the tray
- ◻ REPEAT OFF: exits repeat mode

* This feature may not be available with some discs.

TIPS: The operating features described here might not be possible for certain discs. Always refer to the instructions supplied with the disc.

Repeat track/disc (except DVD-V/DVD-A)

Each time you press **REPEAT**, the front display changes as follows;

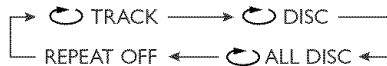

- ↻ TRACK: repeats the current track
- ↻ DISC: repeats the entire disc
- ↻ ALL DISC: repeats all discs loaded in the tray
- REPEAT OFF: exits repeat mode

Repeat track/group/disc (DVD-A)

Each time you press **REPEAT**, the front display changes as follows;



- ↻ TRACK: repeats the current track
- ↻ GROUP: repeats the current group
- ↻ DISC: repeats the entire disc
- ↻ ALL DISC: repeats all discs loaded in the tray
- REPEAT OFF: exits repeat mode

Notes:

- When only one disc is available in the disc tray, it will be continuously played when ↻ ALL DISC is selected.
- For VCD, repeat playback is not possible if the PBC mode is selected.

Repeating a section within a chapter/track

- 1 While playing a disc, press **A-B** at your chosen starting point.
- 2 Press **A-B** again at your chosen end point.
 - A and B can only be set within the same chapter/track.
 - The section will now repeat continuously.
- 3 To exit the sequence, press **A-B**.

Shuffle (except DVD/DVD-Audio/VCD/SVCD/DivX)

With the Shuffle function, you can play tracks in random order.

- 1 During playback, press **SHUFFLE** repeatedly to select between SHUFFLE DISC, SHUFFLE ALL DISC and SHUFFLE OFF.
 - The selected mode appears in the display for several seconds.
- In SHUFFLE DISC mode, all tracks on the disc currently playing are played in random order. For Hybrid SA-CDs, tracks on the SA-CD layer are played by default (see "Playing Super Audio CDs (SA-CDs)" on page 27).
- In SHUFFLE ALL DISC, tracks from all discs are played in random order:
 - If the disc currently playing is a CD, only tracks from CDs and the CD layer of SA-CDs will be played.
 - If the disc currently playing is in SA-CD (SA-CD layer), MP3, WMA, tracks on the disc currently playing are played in random order. When all the tracks on that disc have been played, shuffle playback continues with the next disc.

TIPS: The operating features described here might not be possible for certain discs. Always refer to the instructions supplied with the disc.

Disc Operations

Other operations for video playback (DVD/VCD/SVCD)

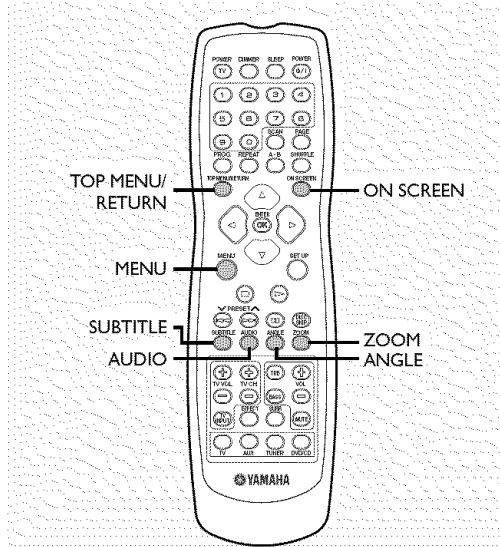

Using the disc menu

Depending on the disc, a menu may appear on the TV screen once you load the disc.

To select a playback feature or item

- Use ◀▶▲▼ keys or **numeric keypad (0-9)** on the remote control, then press **ENTER (OK)** to start playback.

To access or remove the menu

- Press **MENU** on the remote control.

Displaying disc information and the current status

You can display disc information and the disc's current status (for example, title or chapter number, elapsed playing time, audio/subtitle language). A number of operations can be performed without interrupting disc playback.

- 1 During playback, press **ON SCREEN**.
→ A list of available disc information appears on the TV screen.

MENU	
TITLE	02/02
CHAPTER	02/14
AUDIO	5.1CH
SUBTITLE	OFF
BITRATE 16	TITLE ELAPSED 0:02:25

MENU	
TRACK	02/14
DISC TIME	0:49:17
TRACK TIME	0:03:43
REPEAT	OFF
BITRATE 16	TOTAL ELAPSED 0:02:25

- 2 Press ▲▼ to view the information and press **ENTER (OK)** to access.
- 3 Use the **numeric keypad (0-9)** to enter the number/time or press ▲▼ to make the selection, then press **ENTER (OK)** to confirm.
→ Playback will change to the chosen time or to the selected title/chapter/track.

Zooming in

This function allows you to enlarge the picture on the TV screen and pan through the enlarged picture.

- 1 During playback, press **ZOOM** repeatedly to select a different zoom factor.
→ Use ◀▶▲▼ keys to move through the zoomed image.
→ Playback continues.
- 2 Press **ZOOM** repeatedly to return to the original size.

TIPS: The operating features described here might not be possible for certain discs. Always refer to the instructions supplied with the disc.

Resuming playback from the last stopped point

You can resume playback of the last 10 discs, even if the disc was ejected or this receiver's power switched off.

- 1 Load one of the last played 10 discs.
→ "LAST X" (X=1~5) appears.
- 2 Press ► (or ►||) and the disc will be played back from the last stop point.

To cancel the resume mode

- In stop mode, press ■ again.

Advancing by frame

- 1 During playback, press || on the remote.
→ Play will pause and sound will be mute.
- 2 Press || again to select the next picture frame.
- 3 To resume normal playback, press ► (or ►||).

Changing sound track language

This operation works only on DVDs with multiple soundtrack language, you can change the language you want while playing a DVD.

- Press **AUDIO** repeatedly to select the available audio languages.

For VCD - changing the audio channel

- Press **AUDIO** repeatedly to select the available audio channels provided by the disc (STEREO, LEFT MONO, RIGHT MONO or MIX MONO).

Changing subtitle language (DVD only)

This operation works only on DVDs with multiple subtitle languages, you can change the language you want while playing a DVD.

- Press **SUBTITLE** repeatedly to select from the various subtitle languages.

Viewing from another angle (DVD only)

If the disc contains sequences recorded from different camera angles, this function allows you to view the picture from a number of different angles.

- Press **ANGLE** repeatedly to select the desired angle.
→ Playback changes to the selected angle.

Selecting a title (DVD only)

Some DVDs may contain several titles. If the disc has been recorded with a title menu recorded on it, you can start playback from the selected movie title.

- 1 Press **TOP MENU/RETURN**.
→ The disc title menu appears on the TV screen.
- 2 Use ◀▶▲▼ keys or **numeric keypad (0-9)** to select a play option.
- 3 Press **ENTER (OK)** to confirm.

Playback Control (PBC) (VCD only)

PBC playback allows you to play Video CDs interactively, following the menu on the display. This function can also be accessed via the 'PREFERENCE PAGE' menu (see "PBC" on page 34).

For VCDs with Playback Control (PBC) feature (version 2.0 only)

- With playback stopped, press **MENU** to toggle between 'PBC ON' and 'PBC OFF'.
→ If you select 'PBC ON', the disc menu (if available) will appear on the TV. Use ◀◀ / ▶▶ or **numeric keypad (0-9)** to select a play option and press **ENTER (OK)** to confirm.
→ If you select 'PBC OFF', the VCD will skip the index menu and playback directly from the beginning.

TIPS: The operating features described here might not be possible for certain discs. Always refer to the instructions supplied with the disc.

Disc Operations

Preview Function

Preview track/disc (DVD)

- 1 Press **SCAN**.
→ The menu appears on the TV screen.

```
SELECT DIGEST TYPE:
TITLE DIGEST
CHAPTER DIGEST
TITLE INTERVAL
CHAPTER INTERVAL
```

- 2 Press **▲ ▼** to highlight [TITLE DIGEST], [CHAPTER DIGEST], [TITLE INTERVAL] or [CHAPTER INTERVAL].
- 3 Press **ENTER (OK)** to open one option.

TITLE DIGEST

This function displays a thumbnail for the title to help you preview the the title of the disc.

CHAPTER DIGEST

This function displays a thumbnail for each chapter to help you preview the chapters on the disc.

TITLE INTERVAL

This function divides the disc into several sections at regular intervals, and displays them on one page to help you preview the entire disc.

CHAPTER INTERVAL

This function divides a single chapter into several sections at regular intervals, and displays them on one page to help you preview the selected chapter.

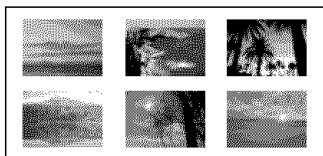

(Example of 6 thumbnails in the display)

- 4 Use **◀ ▶ ▲ ▼** to select a title/chapter or use the **numeric keypad (0-9)** to input the selected title/chapter number next to [SELECT].
- 5 Use **◀◀ / ▶▶** to open the previous or next page.
- 6 Press **ENTER/OK** to open confirm.

Preview group/track (VCD/SVCD)

- 1 Press **SCAN**.
→ The menu appears on the TV screen.

```
GROUP DIGEST TYPE:
GROUP DIGEST
TRACK DIGEST
GROUP INTERVAL
TRACK INTERVAL
```

- 2 Press **▲ ▼** to highlight [GROUP DIGEST], [TRACK DIGEST], [GROUP INTERVAL] or [TRACK INTERVAL].
- 3 Press **ENTER (OK)** to open one option.

GROUP DIGEST

This function displays a thumbnail for each group to help you preview the groups on the disc.

TRACK DIGEST

This function displays a thumbnail for each track to help you preview the tracks on the disc.

GROUP INTERVAL

This function divides a group into several sections at regular intervals, and displays them on one page to help you preview the selected group.

TRACK INTERVAL

This function divides a single track into several sections at regular intervals, and displays them on one page to help you preview the selected track.

- 4 Use **◀ ▶ ▲ ▼** to select a group/track or use the **numeric keypad (0-9)** to input the selected group/track number next to [SELECT].
- 5 Use **◀◀ / ▶▶** to open the previous or next page.
- 6 Press **ENTER/OK** to open confirm.

To quit the preview function

→ Use **◀ ▶ ▲ ▼** to highlight [EXIT] and press **ENTER/OK** to confirm.

To return to the preview menu

→ Use **◀ ▶ ▲ ▼** to highlight [MENU] and press **ENTER/OK** to confirm.

TIPS: The operating features described here might not be possible for certain discs. Always refer to the instructions supplied with the disc.

Playing MP3/JPEG/DivX® discs

This receiver can play DivX, MP3, JPEG, VCD and SVCD files on a personally recorded CD-R/RW disc or commercial CD.

IMPORTANT!

You have to turn on your TV and set to the correct Video In channel (see “Setting the TV” on page 19).

- 1 Load the disc.
 - The disc reading time may exceed 30 seconds due to the complexity of the directory/file configuration.
 - The disc menu appears on the TV screen.



- 2 Press ▲▼ to select a desired folder and press **ENTER (OK)** to open the folder.
- 3 Press ▲▼ to select a track/file.
- 4 Press **ENTER (OK)** to confirm.
 - Playback will start from the selected file to the end of the folder.

While the disc menu is displayed, you can:

- Press ◀▶ to select another track/file in the current folder.
- To select another folder from the current disc, press ◀ to return to the root menu, then press ▲▼ to make your selection and press **ENTER (OK)** to confirm.
- Press || to pause or ▶ (or ▶||) to resume playback.

Note:

- If you press ◀▶▲▼ during playback of JPEG images, the picture rotates.

Playing MP3 music and a JPEG picture simultaneously

- 1 Load an MP3 disc containing both music and picture data.
 - The disc menu appears on the TV screen.
- 2 Select an MP3 track and press ▶ (or ▶||) to start playback.
- 3 During MP3 music playback, select a picture folder from the TV screen and press ▶ (or ▶||).
 - The picture files will be played back until end of the folder.
- 4 To quit simultaneous playback, press **MENU** followed by ■.

Notes:

- It may not be possible to play certain MP3/JPEG/DivX discs due to the configuration and characteristics of the disc or condition of the recording.
- It is normal to experience an occasional “skip” while listening to your MP3 disc.
- It is normal to experience an occasional pixelation during DivX playback due to poor clarity of digital contents during internet downloading.
- For multi-session discs with different formats, only the first session will be available.

Playing Super Audio CDs (SA-CDs)

There are three types of SA-CD discs: single layer, double layer and hybrid discs.

Each type may contain up to two areas of recorded information: a High Quality Stereo area and a High Quality Multi-channel area.

- A single layer disc can contain both information areas.
- A dual layer disc can contain both information areas. Double the information can be stored on the disc, thanks to the second layer.
- A hybrid disc can contain both information areas, and also a second, standard CD layer, making it playable on standard CD players.

TIPS: The operating features described here might not be possible for certain discs. Always refer to the instructions supplied with the disc.

Disc Operations

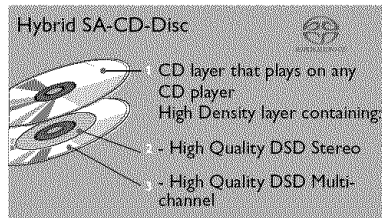
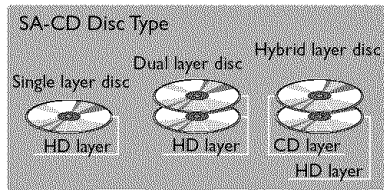

- 1 Load the SA-CD.
→ The disc menu appears on the TV screen.
- 2 Playback will start automatically.
→ If the SA-CD consists of multi-channel and stereo tracks, multi-channel tracks will have the priority for playback.
→ To playback stereo tracks, use ▲▼ to make your selection from the disc menu, then press ► (or ►II).

Note:
– Programming SA-CD tracks is not possible.

Special features for picture disc playback

IMPORTANT!

You have to turn on your TV and set to the correct Video In channel (see “Setting the TV” on page 19).

- Load a picture disc (Kodak Picture CD/JPEG).
→ For Kodak discs, the slide show begins.
→ For JPEG discs, the picture menu appears on the TV screen. Press ► (or ►II) to start the slide-show.

Preview Function

This function shows the content of the current folder or the entire disc.

- 1 During playback, press ■.
→ 12 thumbnail pictures will appear on the TV screen.

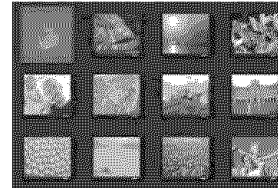

- 2 Press I◀◀ / ▶▶I to display the other pictures on the previous/next page.
- 3 Use ◀▶▲▼ to highlight one of the picture and press ENTER (OK) to start playback.
- 4 Press MENU to return to the picture CD menu.

Zooming pictures

- 1 During playback, press ZOOM repeatedly to select a different zoom factor.
- 2 Use ◀▶▲▼ keys to move through the zoomed image.

Multi-angle playback

- During playback, use ◀▶▲▼ to rotate/flip the picture on the TV screen.
 - ▲ : flips the picture vertically
 - ▼ : flips the picture horizontally
 - ◀ : rotates the picture anti-clockwise
 - ▶ : rotates the picture clockwise

Scan Effect

- Press ANGLE repeatedly to choose a different scan effect.
→ Various scan effects appear in the top left corner of the TV screen.

TIPS: The operating features described here might not be possible for certain discs. Always refer to the instructions supplied with the disc.

DVD Setup Menu Options

This setup is carried out via the TV, enabling you to customize the DVD receiver to suit your particular requirements.

General Setup menu

- 1 In DVD/CD mode, press **SET UP**.
- 2 Press **◀▶** to select the 'General Setup' icon.
- 3 Press **ENTER (OK)** to confirm.

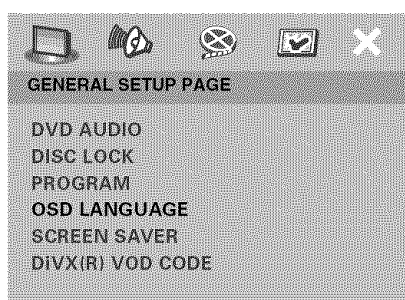

Selecting DVD-Audio/Video mode

- 1 In 'GENERAL SETUP PAGE', press **▲▼** to highlight [DVD-AUDIO], then press **▶**.

DVD-AUDIO MODE

Select this for normal playback.

DVD-VIDEO MODE

Select this to playback the contents of the DVD-Video.

- 2 Press **▲▼** to select a setting, then press **ENTER (OK)** to confirm your selection.

Notes:

- The DVD-AUDIO indicator lights up when a DVD-Audio disc is playing.
- When you select DVD-VIDEO MODE, the DVD-AUDIO indicator goes out.

Locking/Unlocking discs for viewing

Not all discs are rated or coded by the manufacturer of the disc. You can prevent playback of a specific disc by locking the disc. You can lock up to 40 discs on this unit.

- 1 In 'GENERAL SETUP PAGE', press **▲▼** to highlight [DISC LOCK], then press **▶**.

UNLOCK

Select this to unlock the disc and allow future playback.

LOCK

Select this to block playback of the current disc. Subsequent access to a locked disc requires a six-digit password. The default password is '000 000' (see "Changing the password" on page 34).

- 2 Press **▲▼** to select a setting and press **ENTER (OK)** to confirm.

Programming disc tracks (except for Picture CD/MP3/SA-CD discs)

You can playback the contents of a disc in the order you want by programming the tracks to be played. You can store up to 20 tracks.

Program:Track (except for Picture CD/MP3/WMA/DivX®)

- 1 Press **PROG** on the remote control.
OR
In 'GENERAL SETUP PAGE', press **▲▼** to highlight [PROGRAM], then press **▶** to select [FTS].
- 2 Press **ENTER (OK)** to confirm.

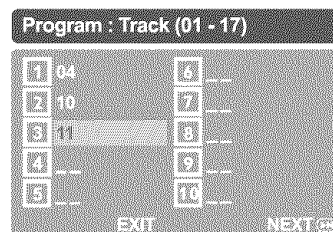

To program your favorite tracks/chapters

- 3 Use the **numeric keypad (0-9)** to enter a valid track/chapter number.

TIPS: To return to the previous menu, press **◀**.
To clear the menu, press **SET UP**.

DVD Setup Menu Options

- Use ◀▶▲▼ to move the cursor to the next position.
→ If the track number is more than ten, press ▶▶ to open the next page and proceed with programming,
OR
→ Use ◀▶▲▼ to highlight [NEXT] on the program menu, then press **ENTER (OK)**.
- Repeat steps 3~4 to input another track/chapter number.

If you want to remove a track

- Use ◀▶▲▼ keys to move the cursor to the track you want to remove.
- Press **ENTER (OK)** to remove this track from the program menu.
Program: Disc
You can playback discs in the order you want by programming the discs to be played. You can store up to 5 discs.
- In 'GENERAL SETUP PAGE', press ▲▼ to highlight [PROGRAM], then press ▶ to select [FDS].
- Press **ENTER (OK)** to confirm.

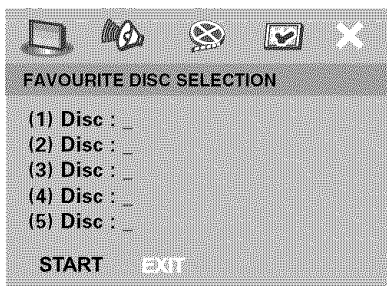

To input your favorite discs

- Use the **numeric keypad (0-9)** to enter a valid disc number.
- Use ◀▶▲▼ to move the cursor to the next position.
- Repeat steps 3~4 to input another disc number.

If you want to remove a disc

- Use ◀▶▲▼ to move the cursor to the disc you want to remove.
- Press **0** on the **numeric keypad (0-9)** to remove this disc from the program menu.

TIPS: To return to the previous menu, press ◀.
To clear the menu, press **SET UP**.

To start program playback

- Use ◀▶▲▼ to highlight [START] on the program menu, then press **ENTER (OK)**.
→ Playback starts for the selected tracks in the programmed sequence.

To exit program playback

- Use ◀▶▲▼ to highlight [EXIT] on the program menu, then press **ENTER (OK)**.

OSD Language

This menu contains various language options for displaying languages on the screen. For details, see "On-screen display (OSD) language" on page 20.

Screen Saver - (on/off)

The screen saver helps prevent your TV display from becoming damaged.

- In 'GENERAL SETUP PAGE', press ▲▼ to highlight [SCREEN SAVER], then press ▶.

ON

Select this if you wish to turn off the TV screen when play is stopped or paused for more than 15 minutes.

OFF

Select this to disable the screen saver function.

- Press ▲▼ to select a setting and press **ENTER (OK)** to confirm.

DivX® VOD registration code

Yamaha provides you with the DivX® VOD (Video On Demand) registration code that allows you to rent and purchase videos using the DivX® VOD service. For more information, visit us at www.divx.com/vod.

- In 'GENERAL SETUP PAGE', press ▲▼ to highlight [DIVX(R) VOD CODE], then press ▶.
→ The registration code appears.
- Press **ENTER (OK)** to exit.
- Use the registration code to purchase or rent the videos from DivX® VOD service at www.divx.com/vod. Follow the instructions and download the video onto a CD-R/RW for playback on this receiver.

Notes:

- All the videos downloaded from DivX® VOD can only be played back on this receiver.
- The time search function is not available during DivX® movie playback.

DVD Setup Menu Options

Audio Setup Menu

- 1 In DVD/CD mode, press **SET UP**.
- 2 Press ◀▶ to select 'Audio Setup' icon.
- 3 Press **ENTER (OK)** to confirm.

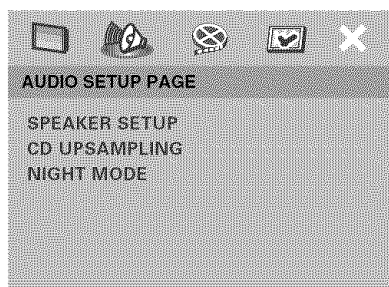

Speaker Setup

This menu contains setup options for audio output so that you can set your speakers to reproduce high quality surround sound. For details, see "Setting speaker channels" on page 21.

CD upsampling

This feature allows you to convert your music CD to a higher sampling rate using sophisticated digital signal processing for better sound quality.

If you have activated the upsampling function, the receiver will automatically switch to stereo mode.

- 1 In 'AUDIO SETUP PAGE', press ▲▼ to highlight [CD UPSAMPLING], then press ▶.

OFF

Select this to disable CD-upsampling.

88.2 kHz (X2)

Select this to convert the sampling rate of CDs to twice that of the original.

- 2 Press ▲▼ to select a setting and press **ENTER (OK)** to confirm.

Note:

- If you select "Multi-Channel" mode, the CD upsampling feature will be cancelled.

Night Listening Mode - (on/off)

When night listening mode is activated, high volume output is softened and low volume output brought upward to an audible level (for DVD only). It is useful for watching your favourite action movie without disturbing others at night. This function is only available for Dolby Digital.

- 1 In 'AUDIO SETUP PAGE', press ▲▼ to highlight [NIGHT LISTENING MODE], then press ▶.

OFF

Select this when you want to enjoy the full dynamic range of surround sound.

ON

Select this to level out the volume.

- 2 Press ▲▼ to select a setting and press **ENTER (OK)** to confirm.

Video Setup Menu

- 1 In DVD/CD mode, press **SET UP**.
- 2 Press ◀▶ to select 'Video Setup' icon.
- 3 Press **ENTER (OK)** to confirm.

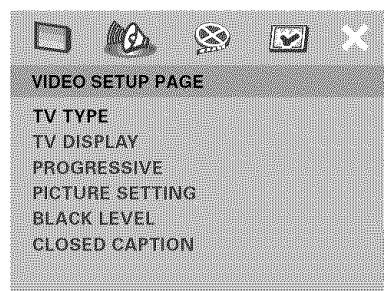

TV Type

This menu contains the options for selecting the color system that matches the connected TV. For details, see "Selecting the color system that matches your TV" on page 19.

TV Display

This menu contains options for matching the aspect ratio of the receiver to the connected TV. For details, see "Setting the TV display" on page 19.

TIPS: To return to the previous menu, press ◀.
To clear the menu, press **SET UP**.

DVD Setup Menu Options

Progressive function - (on/off)

The progressive scan display present 60 complete frames per seconds, rather than 30 frames per second of interlaced scanning (ordinary normal TV system). With nearly double the number of lines, progressive scan offers higher picture resolution and eliminates bothersome motion artifacts those jagged edge on moving objects.

IMPORTANT!

Before enabling the progressive scan function, you must ensure:

- 1) Turn on your TV progressive scan function (refer to your TV owner's manual).
- 2) You have connected the DVD receiver to your TV using Y Pb Pr (see "Connecting a Progressive Scan TV" on page 14).

- 1 In 'VIDEO SETUP PAGE', press ▲▼ to highlight [PROGRESSIVE], then press ►.

OFF

Select this to disable progressive scan function.

ON

Select this to enable progressive scan function.

- 2 Press ▲▼ to select a setting and press **ENTER (OK)** to confirm.
→ Follow the instructions shown on the TV to confirm the selection (if any).
→ If a blank/distorted TV screen appears, wait for 15 seconds for auto recovery to activate.

Picture settings

This receiver comes with three predefined sets of picture color settings and one personal setting that you can define yourself.

- 1 In 'VIDEO SETUP PAGE', press ▲▼ to highlight [PICTURE SETTING], then press ►.

STANDARD

Select this for the standard picture setting.

BRIGHT

Select this to make the TV picture brighter.

SOFT

Select this to make the TV picture softer.

PERSONAL

Select this to personalise your picture color by adjusting the brightness, contrast, tint and color (saturation).

- 2 Press ▲▼ to select a setting and press **ENTER (OK)** to confirm.

- 3 If you select [PERSONAL], proceed to steps 4-7.
→ The 'PERSONAL PICTURE SETUP' menu appears.

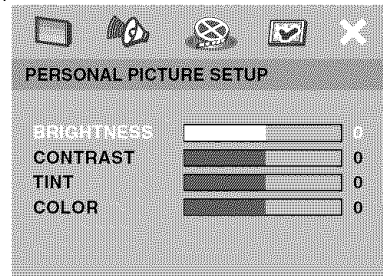

- 4 Press ▲▼ to highlight one of the following options.

BRIGHTNESS

Increase the value to brighten the picture or vice versa. Zero (0) is the average setting value.

CONTRAST

Increase the value to sharpen the picture or vice versa. Zero (0) is the average contrast.

TINT

Increase or decrease the value to change the color phase of the picture. Zero (0) is the average setting value.

COLOR

Increase the value to enhance the color in your picture or vice versa. Zero (0) is the average color setting value.

- 5 Press ◀▶ to adjust the setting that best suits your personal preference.
- 6 Repeat steps 4-5 to adjust other color features if desired.
- 7 Press **ENTER (OK)** to confirm.

Selecting the black level (U.S.A. model only)

If you set the TV type to NTSC, set Black level shift to ON. This will improve the color contrast during playback. The black level setting has no effect if the TV type is set to PAL.

ON

Select this to enhance the black level.

OFF

Select this for the standard black level setting.

TIPS: To return to the previous menu, press ◀.
To clear the menu, press **SET UP**.

Closed Caption (U.S.A. model only)

Closed captions are data hidden in the video signals of specific discs, and are invisible without the use of a special decoder. The difference between subtitles and captions is that subtitles are intended for hearing persons and captions are for the hearing impaired. Subtitles rarely show all of the audio. For example, captions show sound effects (e.g., “phone ringing” and “footsteps”), while subtitles do not. Before you select this function, please ensure that the disc contains closed caption information and your TV set also supports this function.

- 1 In 'VIDEO SETUP PAGE', press ▲▼ to highlight [CLOSED CAPTION], then press ►.

ON

To enable the closed caption function.

OFF

To disable the closed caption function.

- 1 Press ▲▼ to select a setting, then press **ENTER (OK)** to confirm your selection.

Preference Setup Menu

- 1 Press ■ twice to stop playback (if necessary), then press **SET UP**.
- 2 Press ◀▶ to select the 'Preference Setup' icon.
- 3 Press **ENTER (OK)** to confirm.

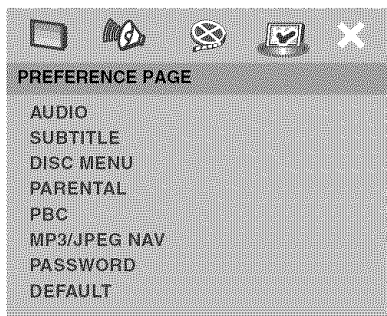

Audio, subtitle and disc menus

These menus contain various language options for the audio, subtitle and disc menus recorded on the DVD. For details, see “Audio, Subtitle and Disc menu languages” on page 20.

Restricting playback with Parental Control

Some DVDs may have a parental level assigned to the complete disc or to certain scenes on the disc. This feature lets you set a playback limitation level. The rating levels are from 1 to 8 and are country dependent. You can prohibit the playing of certain discs that are not suitable for your children, or play alternative scenes for certain discs.

- 1 In 'PREFERENCE PAGE', press ▲▼ to highlight [PARENTAL], then press ►.

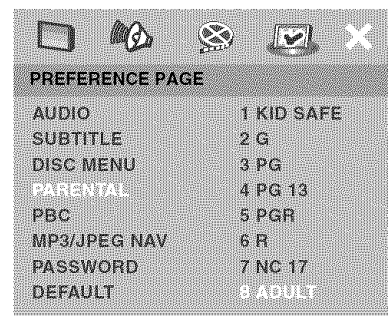

- 2 Press ▲▼ to highlight a rating level for the disc inserted and press **ENTER (OK)**.
- 3 Use the **numeric keypad (0-9)** to enter the six-digit password (see “Changing the password” on page 34).
→ DVDs that are rated above the level you select will not play unless you enter the six-digit password.

Rating explanations

1 KID SAFE – 2 G

– General audience; recommended as acceptable for viewers of all ages.

3 PG

– Parental guidance suggested.

4 PG 13

– Material is unsuitable for children under age 13.

5 PGR – 6 R

– Parental guidance - restricted; recommended that parents restrict children under 17 from viewing, or allow to view only when supervised by a parent or adult guardian.

TIPS: To return to the previous menu, press ◀.
To clear the menu, press **SET UP**.

DVD Setup Menu Options

7 NC-17

- Not for children under age 17; not recommended viewing for children under age 17.

8 ADULT

- Mature material; should be viewed only by adults due to the inclusion of graphic sexual material, violence or language.

Notes:

- VCD, SVCD, CD have no level indication, so the parental control function has no effect with these types of discs. This also applies to most illegal DVDs.
- Some DVDs are not encoded with a rating though the movie rating may be printed on the disc cover. The rating level feature does not prohibit play of such discs.

PBC

You can set PBC to ON or OFF. This feature is available only on Video CD 2.0 with the playback control (PBC) feature. For details, see “Playback Control (PBC) (VCD only)” on page 25.

MP3/JPEG Menu - (on/off)

MP3/JPEG Navigator can be set only if the disc was recorded with a menu. It allows you to select different display menus for easy navigation.

- 1 In 'PREFERENCE PAGE', press ▲▼ to highlight [MP3/JPEG NAV], then press ►.

WITH MENU

Select this to display only the folder menu of the MP3/Picture CD.

WITHOUT MENU

Select this to display all the files contained in the MP3/Picture CD.

- 2 Press ▲▼ to select a setting, then press **ENTER (OK)** to confirm.

Changing the password

The same password is used for both Parental Control and Disc Lock. Enter your six-digit password to play a prohibited disc or if prompted for a password. The default password is '000 000'.

- 1 In 'PREFERENCE PAGE', press ▲▼ to highlight [PASSWORD], then press ► to select [CHANGE].

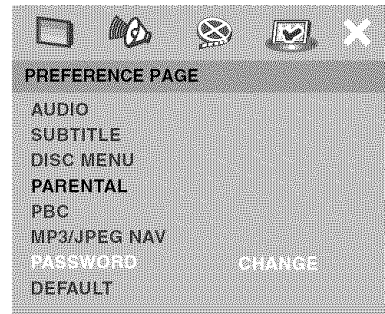

- 2 Press **ENTER (OK)** to enter the 'Password Change Page'.

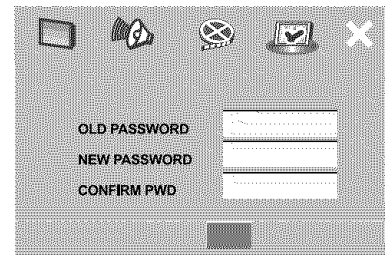

- 3 Use the **numeric keypad (0-9)** to enter your old six-digit password.
→ When doing this for the first time, enter '000 000'.
→ If you forget your old six-digit password, enter '000 000'.
- 4 Enter the new six-digit password.
- 5 Enter the new six-digit password a second time to confirm.
→ The new six-digit password is now valid.
- 6 Press **ENTER (OK)** to confirm.

Restoring to original settings

Setting the DEFAULT function will reset all options and your personal settings to the factory defaults, except your password for Parental Control and Disc Lock.

- 1 In 'PREFERENCE PAGE', press ▲▼ to highlight [DEFAULT], then press ► to select [RESET].
- 2 Press **ENTER (OK)** to confirm.
→ All settings are reset to the factory defaults.

TIPS: To return to the previous menu, press ◀.
To clear the menu, press **SET UP**.

IMPORTANT!
Make sure the **FM** and **AM** antennas are connected to this receiver.

Tuning radio stations

- 1 Press **TUNER** to select "TUNER/FM" or "TUNER/AM".
- 2 Press **▲▼** briefly on the remote control.
→ "SEARCH" appears.
→ The next radio station is tuned automatically.
- 3 Repeat step 2 (if necessary) until you find the desired radio station.
- 4 To tune weak stations, press **◀▶** briefly and repeatedly until the optimal reception is found.
- If the FM station reception is weak, you can switch the FM mode from stereo to mono. Press **SURR** to toggle through:
 - DOLBY PL II FM STEREO
 - DOLBY PL II FM MONO
 - STEREO FM MONO
 - STEREO FM STEREO

Presetting radio stations

You can store up to 20 FM and 10 AM preset radio stations in this receiver's memory.

Notes:

- The receiver will exit presetting mode if no button is pressed within 20 seconds.
- If no valid frequency is detected during Plug and Play, "CHECK ANTENNA" appears.

Using Plug and Play

Plug and Play allows you to store all available radio stations automatically.

- 1 Press **TUNER**.
→ "AUTO PRESET" and "PRESS PLAY" appear one after the other if installation was not completed after you purchased the DVD receiver.
- 2 Press **▶** on the front panel to start installation.
→ "AUTO PRESET" appears.
→ Once complete, the last tuned radio station will play.
→ All available FM stations are stored, followed by all available AM stations.

To stop installation, press **■**.

Automatic presetting

You can start automatic presetting by pressing a selected preset number.

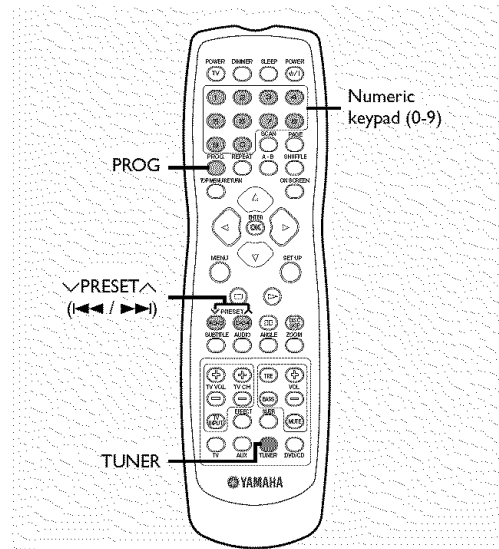

- 1 Press **TUNER** to select "TUNER/FM" or "TUNER/AM".
- 2 Press **◀▶** or use the **numeric keypad (0-9)** to select a preset number to begin.
- 3 Press and hold **PROG** until "AUTO PRESET" appears.
→ If a radio station is stored in one of the earlier presets, the same radio station will not store under another preset number.
→ If no preset number is selected, automatic preset will begin from preset (1) and all former presets will be overridden.

Manual presetting

You can choose to store only your favourite radio stations.

- 1 Tune the desired radio station (see "Tuning radio stations").
- 2 Press **PROG**.
- 3 Press **◀▶** to select a preset number.
- 4 Press **PROG** again to store.

Tuner Operations

Selecting a preset radio station

- Press **◀◀ / ▶▶** or use the **numeric keypad (0-9)** to select a preset number.
→ The waveband, preset number, then radio frequency will appear.

Deleting a preset radio station

- Press and hold **■** on the front panel until “**FMXX BELT**” or “**FMXX BELT**” (XX = preset number) appears.
→ The current preset radio station is deleted.

Setting frequency step (Australia model only)

The inter-station frequency spacing differs depending on the areas. Set the frequency step according to the frequency spacing in your area.

Choices: AM9kHz/FM50kHz
 AM10kHz/FM100kHz

Default setting: AM9/FM50

To change the AM band to 10kHz and the FM band to 100kHz

- ① Unplug the AC power cord from the DVD receiver.
- ② While pressing and holding **INPUT** and **◀◀** on the front panel, plug the AC power cord to the DVD receiver.

IMPORTANT!

For proper surround sound, make sure the speakers and subwoofer are connected to this receiver (see “Connecting the DVD receiver and speakers to the subwoofer” on page 11).

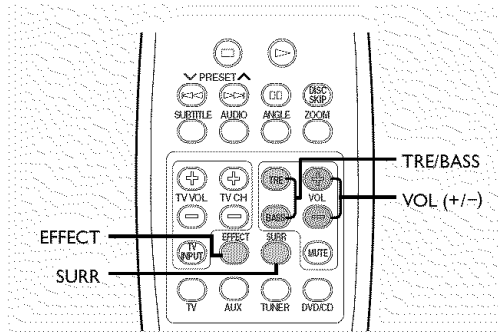

Selecting surround sound

- Press **SURR** on the remote control to select: MULTI-CHANNEL or STEREO.
 - The availability of the various surround sound modes depends on the number of speakers used and the sound available on the disc.
 - The center and surround speakers operate only in multi-channel surround mode.
 - The available output modes for multi-channel include: Dolby Digital, DTS (Digital Theatre Systems) Surround and Dolby Pro Logic II.
 - Stereo broadcasts or recordings produce some surround channel effects when played in a surround mode. However, mono (single channel sound) sources do not produce any sound from the surround speakers.

Notes:

- The **SURR** button is not functional for SA-CD playback. You must access the disc menu in order to select between multi-channel and stereo tracks, (see “Playing Super Audio CDs (SA-CDs)” on page 27).
- The surround sound mode cannot be selected if the system setup menu is selected.

Selecting digital sound effects

You can select preset digital sound effects that match the content of your disc, or that optimize the sound of the musical style you are playing.

- Press **EFFECT** to select from the available sound effects.

When playing movie discs or while in TV mode, you can select:

CONCERT, DRAMA, ACTION or SCI-FI.

When playing music discs or while in TUNER or AUX mode, you can select:

ROCK, DIGITAL, CLASSIC or JAZZ.

Notes:

- Digital sound effects and the treble/bass features cannot be activated at the same time.
- For flat sound output, select **CONCERT** or **CLASSIC**.

Adjusting the treble/bass level

The **TREBLE** (high tone) and **BASS** (low tone) features enable you to define the sound-processor settings.

- 1 Press **TRE** or **BASS** on the remote control.
- 2 Within five seconds, press **VOL (+/-)** to adjust the treble or bass level (MIN, -2, -1, 0, +1, +2 or MAX).
 - If the volume control is not used within five seconds, it will resume its normal volume control function.

Volume Control and Other Functions

Adjusting the volume level

- Use the **VOLUME** control (or press **VOL (+/-)** on the remote control) to increase or decrease the volume level.
→ “VOL MIN” is the minimum volume level and “VOL MAX” is the maximum volume level.

To mute the volume temporarily

- Press **MUTE** on the remote control.
→ Playback will continue without sound and “MUTE” appears.
→ To restore the volume, press **MUTE** again or increase/decrease the volume level.

Switching to active mode

- Press **TUNER** repeatedly on the remote control to select the appropriate active mode. Each time you press **TUNER**, the front display changes as follows;

TUNER/FM
↕
TUNER/AM

- Press **AUX** repeatedly on the remote control to select the appropriate active mode. Each time you press **AUX**, the front display changes as follows;

AUX/ANALOG
↕
AUX/DIGITAL

Switching to eco power standby mode

- Press **STANDBY/ON** on the front panel or **POWER** (⏻/⏻) on the remote control.
→ The display screen goes blank.

Setting remote control codes

Once you set the appropriate remote control codes, you can use this remote to control your other components. The remote control automatically switches to the appropriate control mode for that component.

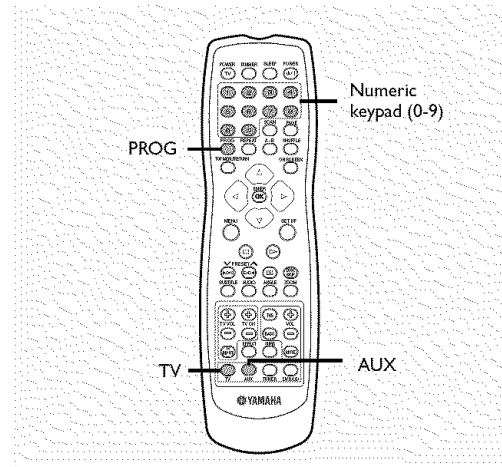

For the **TV** button you can set a TV remote control code and for the **AUX** button you can set a cable or satellite tuner remote control code.

- 1 Press and hold **TV** or **AUX**.
- 2 Press **PROG**, then release both keys.
- 3 Press the **numeric keypad (0~9)** to enter the 4 digit remote control codes (see “Remote Control Codes” at the end of this manual).
- 4 Press **PROG** again to store.

Controlling other components

You can operate other components if you have set the remote control code for your component in the remote control. Note that some buttons may not correctly operate the selected component.

TV operations

Press **TV** for TV operations

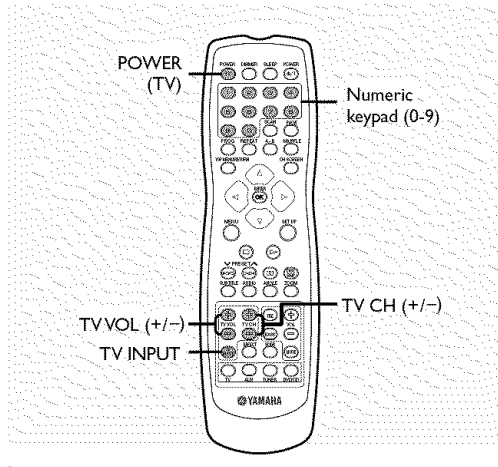

Functions for TV operation

POWER (TV)*

Turn the TV on, or set it to the standby mode.

TV VOL (+/-) *

Adjust the TV volume level.

TV INPUT*

Switches the TV inputs.

Numeric keypad (0-9)

Enters a number of a TV channel.

TV CH (+/-) *

Switches the TV channels.

* : You can also operate these functions in DVD/CD or TUNER mode.

Cable and satellite tuner operations

Press **AUX** for the cable and satellite tuner operations.

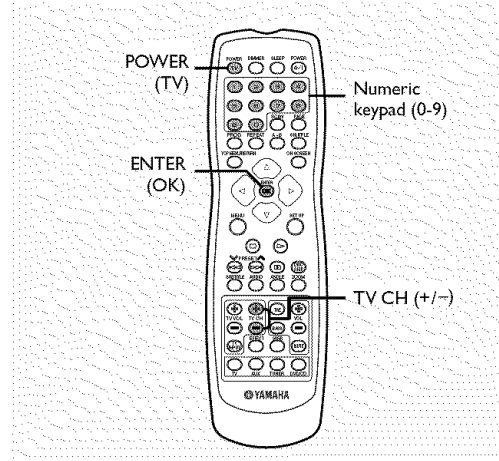

Functions for cable and satellite tuners

POWER (TV)

Turn the cable and satellite tuner on, or set them to the standby mode.

ENTER (OK)

Confirm a selection.

Numeric keypad (0-9)

Cable: enters a number of a cable channel.

Satellite tuner: enters a number of a preset radio station.

TV CH (+/-)

Switches the cable or satellite tuner channel.

Other Functions

Dimming the display screen

- In any active mode, press **DIMMER** on the remote control to select the desired brightness:

DIM 1: 70% brightness
DIM 2: 40% brightness
DIM OFF: normal brightness

Setting the sleep timer

The sleep timer switches the receiver to Eco Power standby mode automatically at the preset time.

- ① Press **SLEEP** on the remote control until "SLEEP XX" appear on the display panel (XX = 15, 30, 45, 60 or OFF).
- ② To select the next sleep timer value, continue pressing **SLEEP** while in sleep timer mode until the desired turn-off time is displayed.
 - **SLEEP** appears on the display panel, except when "SLEEP OFF" is selected.
 - Before the receiver switches to Eco Power standby mode, a countdown of 10 seconds is displayed.
"SLEEP 10" → "SLEEP 9".... →
"SLEEP 2" → "SLEEP 1"

To cancel the sleep timer

- Press **SLEEP** until "SLEEP OFF" appears.

Recording on an external AV component

- ① Connect the external recording component to **LINE OUT** (See "Connecting external AV components" on page 16).
- ② Select the source to record from this DVD receiver (DVD/CD, TUNER, TV or AUX) and start playback (if necessary).
- ③ Start recording on the external recording device.

Note:

- Refer to the owner's manual of the connected equipment for details.

WARNING

Under no circumstances should you try to repair the system yourself, as this will invalidate your warranty. Do not open the system to avoid the risk of electric shock.

If a fault occurs, check the following before taking the system to be repaired. If you are unable to remedy a problem by following the hints below, consult your dealer or Yamaha for help.

Problem	Solution
No power	Check if the AC power cord is properly connected.
	Press STANDBY/ON on the front of the receiver to turn on the power.
No picture	Refer to your TV's manual for correct Video In channel selection. Change the TV channel until you see the DVD screen.
	Press DVD/CD on the remote control in order to switch to DVD/CD mode.
Completely distorted picture or black/white picture	If this happens when you are changing the setting of the 'TV TYPE', wait for 15 seconds for auto recovery.
	If this happens when you are turning on the progressive scan feature, wait for 15 seconds for auto recovery.
	Check the video connection.
	Sometimes a small amount of picture distortion may appear. This is not a malfunction.
The aspect ratio of the screen cannot be changed even though you have set the TV display.	Clean the disc.
	The aspect ratio is fixed on the DVD disc.
No sound or distorted sound.	Depending on the TV, it may not be possible to change the aspect ratio.
	Adjust the volume.
	Check if the system cable is properly connected.
	Check if all speaker cables are properly connected.
	Make sure that the audio cables are connected and press the Input selection buttons to select the correct input source (TV or AUX, for example) to choose the equipment that you want to hear through the DVD receiver.
	Check if the AC power cord of the subwoofer is properly connected.
Sound is too low on one side.	Make sure that you use a disc supported by the DVD player.
	Check if all cables are properly connected.
Cannot activate some features such as Angles, Subtitles, or multi-language Audio.	The features may not be available on the DVD.
	Changing the language for the sound or subtitle is prohibited on the DVD.
DVD videos cannot be copied with the VCR.	Most commercially available DVDs include copy protect features. You cannot make a copy of these DVDs.
The disc is ejected without an operation.	Make sure that you use a disc supported by the DVD receiver.

NOTE: When sending the product for servicing, both the DVD receiver and the subwoofer are required.

Troubleshooting

Problem	Solution
Not able to select some Items in the setup/system menu.	Press STOP button twice before selecting the setup/system menu.
	Depending on the disc availability, some menu items cannot be selected.
The DVD receiver does not start playback.	Insert a readable disc with the playback side facing down. The DVD-R/DVD+R/DVD-RW/DVD+RW/CD-R/CD-RW must be finalized.
	Check the disc type, color system (PAL or NTSC) and region code.
	Check for any scratches or smudges on the disc.
	Press SET UP to turn off the setup menu screen.
	You may need to enter the password in order to change the parental control rating level or to unlock the disc for playback.
	Moisture has condensed inside the player. Remove the disc and leave the receiver turned on for about an hour.
Sound played on the DVD receiver cannot be recorded with an external recorder.	Use proper audio sources.
Sounds played on the AV equipment connected to the DVD receiver cannot be recorded with external recording equipment.	Connect those equipment to the DVD receiver with analog connections.
The volume does not increase or sounds are distorted.	Turn on the power of the component connected to the DVD receiver.
There is no sound from the center, surround speakers and subwoofer.	Make sure the center, surround speakers and subwoofer are connected correctly.
	Adjust the volume level in the setup menu.
	Press SURR button to select a correct surround sound setting.
	Make sure the source you are playing is recorded or broadcast in surround sound (DTS, Dolby Digital, etc.).
“SPEAKER ERR” appears in the display panel.	Unplug the subwoofer, then make sure the front, center and surround speakers are connected correctly.
	Set the DVD receiver to the standby mode, then disconnect the power cord. Wait for about 30 seconds, then reconnect the power cord and turn on the DVD receiver.
Radio reception is poor.	If the signal is too weak, adjust the antenna or connect an external antenna for better reception.
	Increase the distance between the receiver and your TV or VCR.
	Tune in to the correct frequency.
	Place the antenna farther away from any equipment that may be causing the noise.

NOTE: When sending the product for servicing, both the DVD receiver and the subwoofer are required.

Troubleshooting

English

Problem	Solution
The remote control does not function properly.	Select the source (DVD/CD or TUNER, for example) before pressing the function button (▶, ◀◀ / ▶▶).
	Reduce the distance between the remote control and the receiver.
	Replace the batteries with new ones.
	Point the remote control directly toward the remote control sensor.
	Check that the batteries are loaded correctly.
The remote control does not work for operating other equipment.	Set the correct remote control code. Depending on the model and year of the product, the DVD receiver's remote control may not be able to operate it partly or wholly. In this case, use the remote control supplied with each product.
Unable to play DivX movies.	Check that the DivX file was encoded in 'Home Theater' mode with a DivX 5.x encoder.
The DVD receiver does not work.	Disconnect the power cord from the power outlet for a few minutes. Reconnect the power cord and try to operate again as usual.

NOTE: When sending the product for servicing, both the DVD receiver and the subwoofer are required.

Glossary

Analog: Sound that has not been turned into numbers. Analog sound varies, while digital sound has specific numerical values. These jacks send audio through two channels, the left and right.

Aspect ratio: The ratio of vertical and horizontal sizes of a displayed image. The horizontal vs. vertical ratio of conventional TVs is 4:3, and that of wide-screens is 16:9.

AUDIO output: Red and white jacks on the back of the DVD receiver that send audio to another system (TV, Stereo, etc.).

Bit rate: The amount of data used to hold a given length of music; measured in kilobits per second, or kbps. Also, the speed at which you record. Generally, the higher the bit rate, or recording speed, the better the sound quality. However, higher bit rates use more space on a Disc.

Chapter: Sections of a picture or a music piece on a DVD that are smaller than titles. A title is composed of several chapters. Each chapter is assigned a chapter number enabling you to locate the chapter you want.

COMPONENT VIDEO OUT: Jacks on the back of the DVD receiver that send high-quality video to a TV that has Component Video In jacks (R/G/B, Y/Pb/Pr; etc.).

Disc menu: A screen display prepared for allowing selection of images, sounds, subtitles, multi-angles, etc recorded on a DVD.

DivX 3.11/4.x/5.x: The DivX code is a patent-pending, MPEG-4 based video compression technology, developed by DivX Networks, Inc., that can shrink digital video to sizes small enough to be transported over the internet, while maintaining high visual quality.

Dolby Digital: A surround sound system developed by Dolby Laboratories containing up to six channels of digital audio (front left and right, surround left and right, center and subwoofer).

Dolby Surround Pro Logic II: It is an improved matrix decoding technology that provides better spatiality and directionality on Dolby Surround programme material; provides a convincing three-dimensional soundfield on conventional stereo music recordings; and is ideally suited to bring the surround experience to automotive sound. While conventional surround programming is fully compatible with Dolby Surround Pro Logic II decoders, soundtracks will be able to be encoded specifically to take full advantage of Pro Logic II playback, including separate left and right surround channels. (Such material is also compatible with conventional Pro Logic decoders).

DTS: Digital Theater Systems. This is a surround sound system, but it is different from Dolby Digital. The formats were developed by different companies.

JPEG: A very common digital still picture format. A still-picture data compression system proposed by the Joint Photographic Expert Group, which features small decrease in image quality in spite of its high compression ratio.

MP3: A file format with a sound data compression system. "MP3" is the abbreviation of Motion Picture Experts Group 1 (or MPEG-1) Audio Layer 3. By using the MP3 format. One CD-R or CD-RW can contain about 10 times more data than a regular CD.

Multi-channel: DVDs are formatted to have each sound track constitute one sound field. Multichannel refers to a structure of sound tracks having three or more channels.

Parental control: Limits Disc play according to the age of the users or the limitation level in each country. The limitation varies from disc to disc; when it is activated, playback will be prohibited if the software's level is higher than the user-set level.

Playback control (PBC): Refers to the signal recorded on video CDs or SVCDs for controlling playback. By using menu screens recorded on a Video CD or SVCD that supports PBC, you can enjoy interactive playback and searching. Glossary

Plug and Play: When Tuner mode is selected for the first time, the receiver will prompt the user to proceed with the automatic installation of radio stations by simply pressing the PLAY button on the main unit.

Progressive Scan: It displays all the horizontal lines of a picture at one time, as a signal frame. This receiver can convert the interlaced video from DVD into progressive format for connection to a progressive display. It dramatically increases the vertical resolution.

Region code: A receiver allowing discs to be played only in the region designated. This unit will only play discs that have compatible region codes. You can find the region code of your unit by looking on the product label. Some discs are compatible with more than one region (or ALL regions).

S-video: Produces a clear picture by sending separate signals for the luminance and the color. You can use S-video only if your TV has an S-video In jack.

Super Audio CD (SA-CD): This audio format is based upon the current CD standards but includes a greater amount of information that provides higher quality sound. There are three types of discs: single layer, double layer and hybrid discs. The hybrid disc contains both standard audio CD and Super Audio CD information.

Surround: A receiver for creating realistic three-dimensional sound fields full of realism by arranging multiple speakers around the listener.

Title: The longest section of a movie or music feature on DVD. Each title is assigned a title number, enabling you to locate the title you want.

VIDEO output: Yellow jack on the back of the DVD receiver that sends the DVD picture video to a TV.

Specifications

English

AMPLIFIER SECTION

Output Power	
- Front	150 W RMS (10% THD, 1 kHz) / channel
- Surround	150 W RMS (10% THD, 1 kHz) / channel
- Center	150 W RMS (10% THD, 1 kHz)
- Subwoofer	150 W RMS (10% THD, 100 Hz)
Frequency Response	20 Hz – 20 kHz / –3 dB
Signal-to-Noise Ratio	> 100 dB
Input Sensitivity	
- AUX In, TV In	300 mV

TUNER SECTION

FM Tuning Range	87.50 – 108.00 MHz
AM Tuning Range	
- U.S.A and Canada	
Models	530 – 1700 kHz
- Australia Model	531 – 1602 kHz

DISC SECTION

Laser Type	Semiconductor
Disc Diameter	12cm / 8cm
Video Decoding	MPEG-1 / MPEG-2 / DivX 3.11, 4.x & 5.x
Video DAC	12 Bits/108 MHz
Signal System	PAL / NTSC
Video Format	4:3 / 16:9
Composite Video Output	1.0 Vp-p, 75 Ω
S-video Output	Y - 1.0 Vp-p, 75 Ω C - 0.3 Vp-p, 75 Ω
Audio DAC	24 Bits / 192 kHz
Frequency Response	4 Hz – 20 kHz (44.1 kHz) 4 Hz – 22 kHz (48 kHz) 4 Hz – 44 kHz (96 kHz)
PCM	IEC 60958
Dolby Digital	IEC 60958, IEC 61937
DTS	IEC 60958, IEC 61937
Component Video Output	Y - 1.0 Vp-p, 75 Ω Pb/Cb Pr/Cr - 0.7 Vp-p, 75 Ω
Audio S/N	105 dB
Distortion	0.0035 %
Dynamic Range	95 dB

AUDIO FORMAT

Digital	Dolby Digital/DTS/MPEG/Compressed Digital
PCM	16, 20, 24 bits fs 44.1, 48, 96 kHz
MP3 (ISO 9660)	24, 32, 56, 64, 96, 128, 256 kbps fs 16, 22.05, 24, 32, 44.1, 48 kHz
WMA	32 – 192 kbps, mono, stereo
Full decoding of Dolby Digital and DTS multi-channel sound Analog Sound Stereo	
Dolby Surround Compatible Downmix from Dolby Digital multi-channel sound	
Dolby Pro Logic II	

DVD RECEIVER (DVR-C300)

Power Supply Rating	
- U.S.A. and Canada	
Models	120 V, 60 Hz
- Australia Model	240 V, 50 Hz
Power Consumption	20 W
Dimensions (W x H x D)	435 x 75 x 434 mm
Weight	5.6 kg

FRONT SPEAKER (NX-F300)

System	2-way, Bass Reflex System
Impedance	6 Ω
Speaker Drivers	6.5 cm (2.5") woofer + 2.5cm (1")
Frequency Response	150 Hz – 20 kHz
Dimensions (W x H x D)	83 x 181 x 78 mm
Weight	0.7 kg/speaker

CENTER SPEAKER (NX-C300)

System	2-way, Bass Reflex System
Impedance	6 Ω
Speaker Drivers	6.5 cm (2.5") Full range x 2 + Piezo
Frequency Response	150 Hz – 20 kHz
Dimensions (W x H x D)	298 x 84 x 78 mm
Weight	1.1 kg

SURROUND SPEAKER (NX-S300)

System	2-Way, Bass Reflex System
Impedance	6 Ω
Speaker Drivers	6.5 cm (2.5") Full Range + Piezo
Frequency Response	150 Hz - 20 kHz
Dimensions (W x H x D)	83 x 181 x 78 mm
Weight	0.6 kg/speaker

SUBWOOFER (NX-SW300)

Power Supply Rating	
- U.S.A. and Canada	
Models	120 V, 60 Hz
- Australia Model	240 V, 50 Hz
Power Consumption	360 W
System	Bass Reflex System
Impedance	6 Ω
Speaker Driver	16 cm (6 1/2") woofer
Frequency Response	40 Hz – 150 Hz
Dimensions (W x H x D)	178x 402 x 461 mm
Weight	12 kg

Specifications subject to change without prior notice.

Language Codes / Codes de Langue

These codes can be used to select other languages. This does not affect the options in "AUDIO", "SUBTITLE" or "DISC MENU".

Ces pages permettent de choisir d'autres langues. Ce réglage n'affecte pas les options choisies avec "AUDIO", "S-TITRES" ou "MENU DISQUE".

Abkhazian	6566	Ido	7379	Oromo	7977
Afar	6565	Indonesian	7368	Ossetian; Ossetic	7983
Afrikaans	6570	Interlingua (International)	7365	Ossetic; Ossetian	7983
Albanian	8381	Interlingue	7369	Pali	8073
Amharic	6577	Inuktitut	7385	Panjabi	8065
Arabic	6582	Inupiaq	7375	Persian	7065
Armenian	7289	Irish	7165	Polish	8076
Assamese	6583	Italian	7384	Portuguese	8084
Avestan	6569	Japanese	7465	Provençal; Occitan (post)	7967
Aymara	6589	Javanese	7486	Pushto	8083
Azerbaijani	6590	Kalaallisut	7576	Quechua	8185
Bashkir	6665	Kannada	7578	Raeto-Romance	8277
Basque	6985	Kashmiri	7583	Romanian	8279
Belarusian	6669	Kazakh	7575	Rundi	8278
Bengali	6678	Khmer	7577	Russian	8285
Bihari	6672	Kikuyu; Gikuyu	7573	Samoan	8377
Bislama	6673	Kinyarwanda	8287	Sango	8371
Bokmål, Norwegian	7866	Kirghiz	7589	Sanskrit	8365
Bosnian	6683	Komi	7586	Sardinian	8367
Breton	6682	Korean	7579	Scottish Gaelic; Gaelic	7168
Bulgarian	6671	Kuanyama; Kwanyama	7574	Serbian	8382
Burmese	7789	Kurdish	7585	Shona	8378
Castilian, Spanish	6983	Kwanyama; Kuanyama	7574	Shindi	8368
Catalan	6765	Lao	7679	Sinhalese	8373
Chamorro	6772	Latin	7665	Slovak	8375
Chechen	6769	Latvian	7686	Slovenian	8376
Chewa; Chichewa; Nyanja	7889	Letzeburgesch;	7666	Somali	8379
Chichewa; Chewa; Nyanja	7889	Limburgan; Limburger	7673	Sotho, Southern	8384
Chinese	9072	Limburger; Limburgan	7673	South Ndebele	7882
Chuang; Zhuang	9065	Limburgish; Limburger	7673	Spanish; Castilian	6983
Church Slav; Slavonic	6785	Lingala	7678	Sundanese	8385
Church Slavonic; Church	6785	Lithuanian	7684	Swahili	8387
Chuvash	6786	Luxembourgish	7666	Swati	8383
Cornish	7587	Macedonian	7775	Swedish	8386
Corsican	6779	Malagasy	7771	Tagalog	8476
Croatian	7282	Malay	7783	Tahitian	8489
Czech	6783	Malayalam	7776	Tajik	8471
Danish	6865	Maltese	7784	Tamil	8465
Dutch	7876	Manx	7186	Tatar	8484
Dzongkha	6890	Maori	7773	Telugu	8469
English	6978	Marathi	7782	Thai	8472
Esperanto	6979	Marshallese	7772	Tibetan	6679
Estonian	6984	Moldavian	7779	Tigrinya	8473
Faroese	7079	Mongolian	7778	Tonga (Tonga Islands)	8479
Fijian	7074	Nauru	7865	Tsonga	8483
Finnish	7073	Navaho, Navajo	7886	Tswana	8478
French	7082	Navajo; Navaho	7886	Turkish	8482
Frisian	7089	Ndebele, North	7868	Turkmen	8475
Gaelic; Scottish Gaelic	7168	Ndebele, South	7882	Twí	8487
Gallegan	7176	Ndonga	7871	Uighur	8571
Georgian	7565	Nepali	7869	Ukrainian	8575
German	6869	Northern Sami	8369	Urdu	8582
Gikuyu; Kikuyu	7573	North Ndebele	7868	Uzbek	8590
Greek	6976	Norwegian	7879	Vietnamese	8673
Guarani	7178	Norwegian Bokmål; Bokmål	7866	Volapük	8679
Gujarati	7185	Norwegian Nynorsk	7878	Walloon	8765
Hausa	7265	Nyanja; Chichewa; Chewa	7889	Welsh	6789
Hebrew	7269	Nynorsk, Norwegian	7878	Wolof	8779
Herero	7290	Occitan (post 1500); Proven	7967	Xhosa	8872
Hindi	7273	Old Bulgarian; Old Slavonic	6785	Yiddish	8973
Hiri Motu	7279	Old Church Slavonic; Old	6785	Yoruba	8979
Hungarian	7285	Old Slavonic; Church	6785	Zhuang; Chuang	9065
Icelandic	7383	Oriya	7982	Zulu	9085

Remote Control Codes / Codes de Commande

TV

Yamaha 1009, 1011, 1036, 1068
 Admiral 1033, 1080
 Aiko 1032
 Akai 1011
 Alba 1005, 1013, 1014, 1064, 1076
 AOC 1009, 1011
 Audiovox 1032, 1053, 1079, 1083
 Belcor 1009
 Bell & Howell 1007, 1039
 Blaupunkt 1055, 1056, 1059, 1082
 Blue sky 1064
 Bradford 1053
 Brandt 1035, 1057, 1058
 Brokwood 1009
 Bush 1005, 1013, 1014, 1064, 1070, 1072, 1076, 1077
 Candle 1011, 1021
 Clatronic 1030, 1067, 1075
 Contec 1053
 Craig 1043, 1053
 Croslex 1020
 Crown 1016, 1053, 1078
 Curtis Mathis 1007, 1011, 1016, 1017, 1018, 1020, 1021, 1022, 1053
 CXC 1053
 Daewoo 1009, 1016, 1023, 1032, 1039, 1079, 1083, 1084
 Daytron 1009
 Dual 1063
 Dumont 1008, 1009
 Emerson 1009, 1015, 1016, 1039, 1050, 1051, 1052, 1053, 1065, 1070, 1080, 1083, 1084
 Envision 1011
 Ferguson 1004, 1014, 1028, 1035, 1054, 1066, 1071
 First line 1005, 1062, 1063, 1067, 1072, 1074
 Fisher 1039
 Funai 1048, 1052, 1053, 1069
 Futuretec 1053
 GE 1010, 1017, 1018, 1033, 1051, 1070, 1079, 1088, 1090
 Gibraltar 1008, 1009, 1011
 LG/Goldstar 1002, 1003, 1009, 1011, 1014, 1016, 1021, 1052
 Goodmans 1013, 1014, 1027, 1063, 1076, 1077
 Grundig 1026, 1055, 1056, 1082
 Harvard 1024, 1053
 Hitachi 1015, 1021, 1036
 ICE 1063, 1069, 1076
 Itr/Nokia 1044
 JC Penny 1003, 1009, 1010, 1011, 1016, 1017, 1018, 1021, 1022, 1040, 1051, 1090
 JVC (Victor) 1013, 1019, 1025, 1042
 Kendo 1014
 Kenwood 1009, 1011
 KTV 1011, 1016, 1053
 Loewe 1029
 Magnavox 1011, 1013, 1020, 1052
 Marantz 1011, 1014, 1020
 Matsui 1005, 1012, 1013, 1014, 1027, 1060, 1063, 1072, 1076
 MGA 1009, 1011, 1037, 1049
 Mitsubishi 1009, 1033, 1034, 1038, 1081
 MTC 1009, 1011, 1021, 1022, 1062, 1081
 Multitec 1053
 NEC 1009, 1011, 1013, 1021, 1047
 Nikko 1011, 1032, 1051
 Nokia 1044
 Nordmende 1035, 1057, 1058, 1071
 NTC 1062
 Oceanic 1044, 1061
 Onwa 1053
 Panasonic 1018, 1043, 1068, 1086
 Philco 1009, 1011, 1020, 1036, 1080
 Philips 1014, 1020
 Pilot 1009, 1011, 1016
 Pioneer 1015, 1046, 1049, 1085, 1086
 Portland 1009, 1016, 1032
 Quasar 1018, 1045, 1068
 Radio Shack 1009, 1011, 1016, 1017, 1021, 1038, 1044, 1049, 1051
 RCA 1009, 1015, 1017, 1018, 1031, 1033, 1087, 1088, 1089, 1090, 1091

Realistic 1009, 1011, 1016, 1021, 1039, 1045, 1051, 1053
 SABA 1029, 1035, 1044, 1057, 1058, 1071
 Sampo 1011, 1016
 Samsung 1009, 1011, 1014, 1021, 1022, 1031, 1051
 Sanyo 1039, 1060, 1079
 Schneider 1014, 1064, 1067, 1073, 1076
 Scott 1009, 1051, 1052, 1053, 1065
 Sharp 1016, 1033, 1045
 Shogun 1009
 Siemens 1014, 1041, 1055, 1056, 1059, 1082
 Signature 1007
 Sony 1001, 1006
 Soundesign 1051, 1052, 1053
 Starlite 1053
 Sylvania 1011, 1020
 Telefunken 1021
 Thomson 1035, 1057, 1058, 1071
 Toshiba 1012, 1013, 1022, 1039, 1040
 Videch 1009, 1013, 1051
 Wards 1007, 1009, 1010, 1011, 1020, 1021, 1045, 1051, 1052

CABLE

ABC 3002, 3003, 3004, 3006, 3008
 Andover 3037
 Bell & Howell 3006
 Birgmingham Cable Communication 3020
 British Telecom 3002, 3012
 Cabletime 3016, 3019, 3025, 3029
 Contec 3009
 Clyde 3011
 Cryptovision 3038
 Daehan 3043
 Daeryung 3003
 Decsat 3027
 Everquesst 3007
 Filmnet 3028
 France Telecom 3030
 GEC 3011
 Gemini 3007
 General Instrument 3004, 3020, 3031, 3046
 Goldstar 3014, 3047
 Grundig 3035
 Hamlin 3052, 3067, 3050, 3057, 3068
 Hitachi 3004
 Jasco 3007
 Jerrold 3002, 3004, 3005, 3006, 3007, 3020, 3031, 3046
 LG Alps 3044
 Magnavox 3055, 3071
 Memorex 3001
 Mnet 3009, 3028
 Motorola 3074, 3075, 3076, 3077, 3078, 3079, 3080, 3081, 3082, 3083, 3084, 3085, 3086, 3087, 3088, 3089, 3090, 3091
 Now 3041
 Oak 3009
 Pacific 3039
 Panasonic 3001, 3013
 Paragon 3001
 Philips 3061, 3054, 3055, 3056, 3065, 3069, 3071
 Pulsar 3001
 Pioneer 3010, 3014, 3018, 3036
 PVP Stereo Visual Matrix 3002
 Quasar 3001
 Radio Shack 3051, 3070, 3072, 3073
 Rembrandt 3004
 Runco 3001
 Salora 3026
 Samsung 3014, 3040
 Satbox 3024
 Scientific 3003, 3032, 3049
 Scientific Atlanta 3003, 3008, 3021
 Seawoo 3045
 Signal 3007
 Signature 3004
 Starcom 3002, 3007
 Stargate 3007
 Starquest 3007

Remote Control Codes / Codes de Commande

STS 3015
 Taihan 3043
 Teleservice 3022
 Tele+1 3028
 Tudi 3023
 Tusa 3007
 Tocom 3005
 Tongkook 3042, 3048
 Toshiba 3001
 United Cable 3002
 Universal 3061, 3053, 3060, 3062, 3063
 Videoway 3017
 Viewstar 3059, 3055, 3058, 3064, 3066
 Visicable+ 3033
 Westminster 3012
 Wolsey Gene 3037
 Zenith 3001, 3034

SATELLITE TUNER

Absat 4006
 AST 4027
 Alba 4029, 4034, 4037, 4052
 Aldes 4019
 Amstrad 4003, 4016, 4025, 4038, 4039, 4042
 Ankard 4013, 4019, 4030, 4044
 Anttron 4009, 4034
 Armstrong 4015
 Astra 4005
 Astro 4008, 4039, 4045
 Avalon 4031
 Axis 4030, 4046
 Beko 4010
 Best 4030
 Blaupunkt 4008
 Boca 4015, 4043
 Brain Wave 4022
 British Sky Broadcasting 4058
 BT 4053
 Bush 4002
 CNT 4045
 Cambridge 4024
 Canal Satellite 4059
 Canal+ 4059
 Channel Master 4029
 Comlink 4019
 Connexions 4031
 Crown 4015
 Cyrus 4011
 D-Box 4054
 DDC 4029
 DNT 4011, 4031
 EchoStar 4031, 4036, 4061
 Emanon 4034
 Ferguson 4002, 4009, 4010, 4023
 Fidelity 4016
 Finlux 4005, 4024, 4032, 4037
 Fracarro 4061
 Freecom 4034
 Fujitsu 4094, 4012
 FTE Humax 4060
 Fube 4030, 4031, 4034
 G-sat 4009
 Galaxis 4019, 4057, 4060
 General Instrument 4085, 4080, 4069, 4082, 4083, 4092
 Gold Box 4059
 Gooding 4048
 Goodmans 4010
 Grundig 4008, 4010, 4048
 Hinari 4009
 Hirschmann 4008, 4032, 4039, 4040, 4049
 Hitachi 4037
 Houston 4053
 Hughes 4088
 Huth 4013, 4015, 4019, 4026
 ITT 4005
 Invideo 4061
 Intervision 4050
 Johansson 4022
 JVC 4048
 Kathrein 4004, 4006, 4008, 4011, 4035, 4041
 Kreiselmeyer 4008
 Kyostar 4034
 La Sat 4043, 4045

Lenco 4034
 Lennox 4050
 Lupus 4030
 Luxor 4005, 4049
 Magnavox 4087
 Manhattan 4037, 4045, 4050
 Marantz 4011
 Maspro 4004, 4023
 Matsui 4024, 4048
 Mediasat 4059
 Mediamarkt 4015
 Minerva 4048
 Morgan's 4015, 4043
 Navex 4022
 Neuhaus 4039
 Neusat 4057
 Newhaus 4013
 Nikko 4028
 Nokia 4005, 4032, 4037, 4049, 4054, 4063
 Nordmende 4029
 Orbitech 4039
 Oxford 4024
 Pace 4002, 4009, 4014, 4023, 4037, 4055, 4058
 Palladium 4048
 Palsat 4039
 Panda 4037
 Panasonic 4086, 4077
 Philips 4007, 4011, 4020, 4037, 4048, 4059
 Phonotrend 4019, 4050
 Pioneer 4021, 4059
 Planet 4061
 Promax 4037
 Prosat 4019
 Quadral 4029, 4044
 Radio shack 4083
 Radiola 4011
 Radix 4031, 4064
 RCA 4084, 4076, 4090
 RFT 4011, 4013, 4019
 Saba 4023, 4045
 Sabre 4037
 Sagem 4056
 Salora 4005
 Samsung 4066, 4067, 4068
 SAT 4027, 4038
 Satcom 4026, 4051
 Satec 4009
 Satmaster 4026
 Satpartner 4022, 4034, 4040, 4045
 Schwaiger 4009, 4041
 Seemann 4031, 4046
 SEG 4030, 4034
 Siemens 4008
 Skymaster 4019, 4044, 4051
 Sony 4017, 4018
 Strong 4062
 Sunstar 4043
 Tantec 4023, 4037
 Technisat 4001, 4039
 Techniland 4026
 Telefunken 4034
 Teleka 4015, 4052
 Telesat 4051
 Thomson 4037, 4059
 Tonna 4026, 4053
 Toshiba 4089, 4071, 4075
 TPS 4056
 Triad 4027
 Triasat 4040
 Uniden 4093, 4070, 4073, 4074, 4078, 4079, 4081, 4083
 Uonor 4022
 Universum 4008, 4049
 Ventana 4011
 Vortec 4034
 Vtech 4027
 Winersat 4022
 Wisi 4008, 4027, 4031, 4037
 Xsat 4006, 4065
 Xcom Multimedia 4065
 Zehnder 4033, 4045, 4047
 Zenith 4071, 4072, 4091



This product mainly uses lead-free solder.
Cet appareil utilise principalement de la soudure sans plomb.

© 2005 YAMAHA CORPORATION All rights reserved.

YAMAHA ELECTRONICS CORPORATION, USA 6660 ORANGETHORPE AVE., BUENA PARK, CALIF. 90620, U.S.A.
YAMAHA CANADA MUSIC LTD. 135 MILNER AVE., SCARBOROUGH, ONTARIO M1S 3R1, CANADA
YAMAHA ELECTRONIK EUROPA G.m.b.H. SIEMENSSTR. 22-34, 25462 RELLINGEN BEI HAMBURG, GERMANY
YAMAHA ELECTRONIQUE FRANCE S.A. RUE AMBROISE CROIZAT BP70 CROISSY-BEAUBOURG 77312 MARNE-LA-VALLEE CEDEX02, FRANCE
YAMAHA ELECTRONICS (UK) LTD. YAMAHA HOUSE, 200 RICKMANSWORTH ROAD WATFORD, HERTS WD18 7GQ, ENGLAND
YAMAHA SCANDINAVIA A.B. J A WETTERGRENS GATA 1, BOX 30053, 400 43 VÄSTRA FRÖLUNDA, SWEDEN
YAMAHA MUSIC AUSTRALIA PTY. LTD. 17-33 MARKET ST., SOUTH MELBOURNE, 3205 VIC., AUSTRALIA

YAMAHA CORPORATION
Printed in China © 3139 246 14711