

# **HOOVER®** **FoldAway™ Upright**

***Thank you for  
your purchase!***

## **Owner's Manual**

**ENGLISH → pp. 1-12**

ESPAÑOL → pág. 15-21

FRANÇAIS → p. 22-28

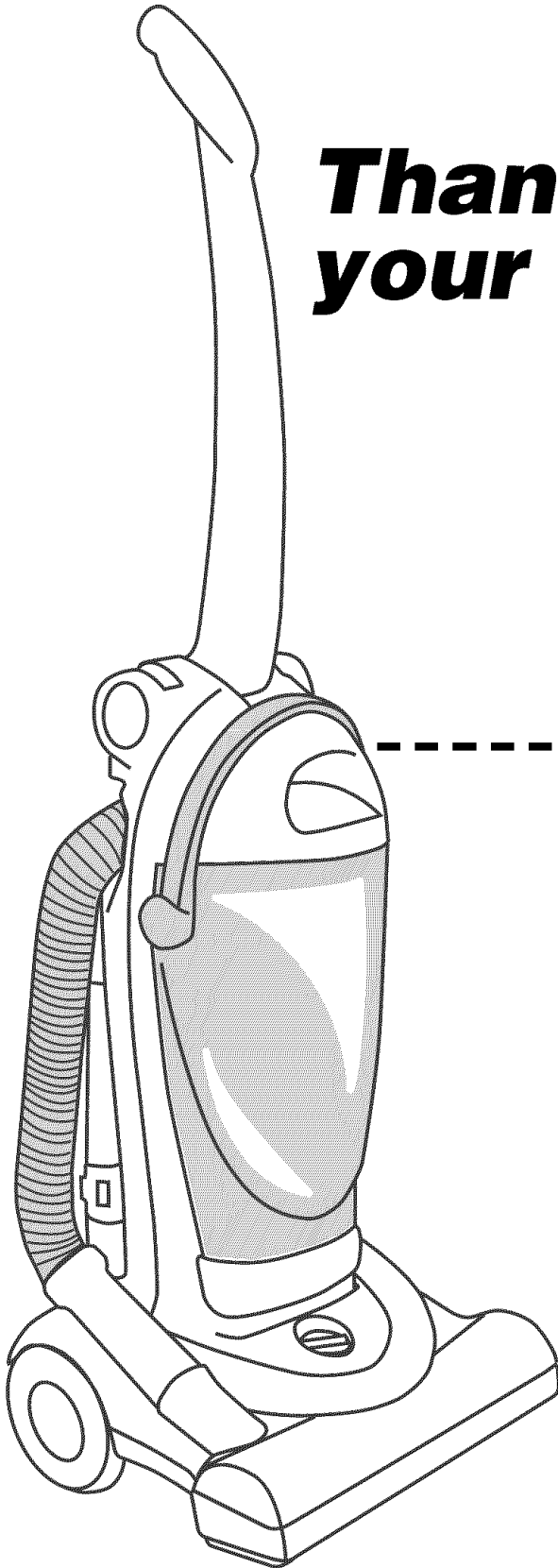

# Review this manual before operating cleaner

## Thank you for choosing a HOOVER® product.

Please enter the COMPLETE model and serial numbers in the spaces provided. The numbers are located on the bottom of your cleaner.

Model \_\_\_\_\_

Serial number \_\_\_\_\_

Hint: Attach your sales receipt to this owner's manual. Verification of date of purchase may be required for warranty service of your HOOVER product.

Be sure to fill out and return the product registration card included with your cleaner (see back cover).

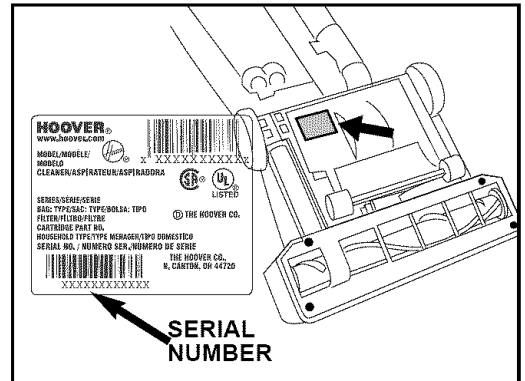

### Contents

- Getting Started .....3
- How to use .....4
  - Cleaner Description .....4
  - Cleaning Tools .....6
- If You Have a Problem .....11
  - Clearing Blockages .....11-12
- Important Safeguards .....2
- Maintenance
  - Authorized Service .....11
  - Cleaning Filters .....7-8
  - Emptying Dirt Cup .....7
  - Lubrication .....10
  - Replacing Agitator Brush Roll .....10
  - Replacing Belt .....9-10
  - Replacing Headlight.....8
  - Thermal Protector .....10
  - Warranty .....12

## Important Safeguards

When using an electrical appliance, always follow basic precautions, including the following:

**READ ALL INSTRUCTIONS BEFORE USING THIS APPLIANCE**

### Warning:

To reduce the risk of fire, electric shock, or injury:

- Do not use outdoors or on wet surfaces.
- Close supervision is necessary when any appliance is used by or near children. Do not allow vacuum cleaner to be used as a toy or to run unattended at any time.
- Keep hair, loose clothing, fingers, feet and all parts of body away from openings, rotating agitator and other moving parts. Do not operate cleaner in bare feet or when wearing open toe shoes or sandals.
- Do not pick up anything that is burning or smoking, such as cigarettes, matches, or hot ashes.
- Do not use to pick up flammable or combustible materials such as gasoline or fine wood sandings or use in areas where they may be present.
- Avoid picking up hard, sharp objects with the cleaner. They may damage the cleaner.
- Always turn off this appliance before connecting or disconnecting hose.
- Do not use without dirt cup or filters in place. Empty dirt cup and clean filters frequently when picking up very fine materials such as powder.
- Use extra care when cleaning on stairs.
- Do not put any object into openings. Do not use with any opening blocked; keep free of dust, lint, hair, or anything that may reduce air flow.
- Do not pull or carry by cord, use cord as a handle, close door on cord or pull cord around sharp edges or corners. Do not run appliance over cord. Keep cord away from heated surfaces.
- Always disconnect cord from electrical outlet before servicing the cleaner.
- Unplug cleaner when not in use. Turn off all controls before unplugging.
- Do not unplug by pulling on cord. To unplug, grasp the plug, not the cord. Never handle plug or appliance with wet hands.
- The use of an extension cord is not recommended.
- Do not use with damaged cord or plug. If appliance is not working as it should, has been dropped, damaged, left outdoors, or dropped into water, take it to a Hoover Factory Service Center or Authorized Hoover Warranty Service Dealer (Depot).
- Use vacuum cleaner only for its intended use as described in the instructions. Use only attachments recommended by The Hoover Company; others may cause hazards.



© 2003 The Hoover Company  
www.hoover.com

## Save these instructions!

## If you need any assistance:

Visit our website at [www.hoover.com](http://www.hoover.com). Click on the "Service" button to find the service outlet nearest you OR

Call **1-800-944-9200** for an automated referral of service outlet locations (U.S. only) OR

Call 1-330-499-9499 to speak with a representative in our Consumer Response Center.

**Please do not return this product to the store.**

## 1. Getting started

### Carton contents

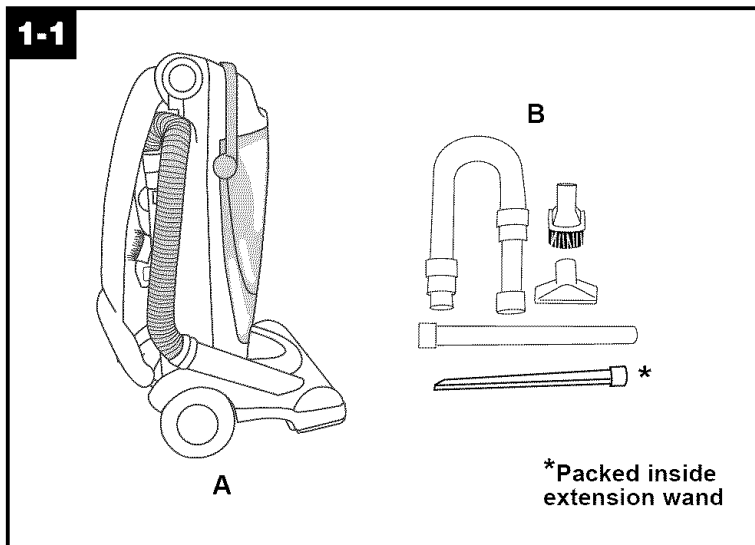

**Your cleaner comes fully assembled with the tools and hose stored on board.**

Remove any tape or packing material from the cleaner.

**A. Cleaner**

**B. Hose, cleaning tools and wands (packed on cleaner)**

### Using fold down handle

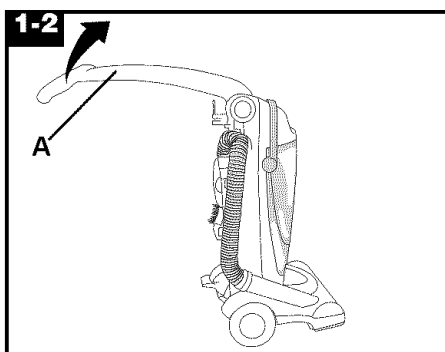

Raise upper handle (A) to upright position until it locks in place.

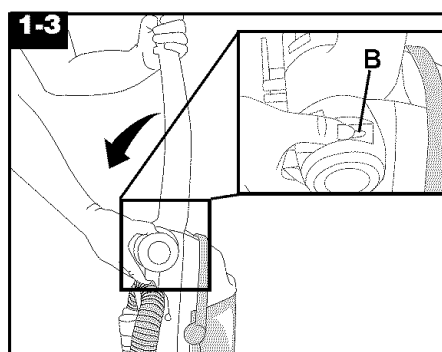

Press upper handle release button (B) back to fold handle to storage position.

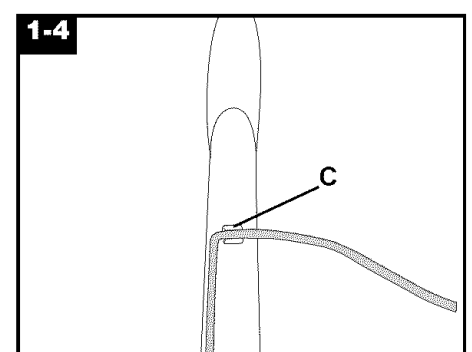

### **Cord clip**

To help keep the cord out of the way while cleaning, position cord into cord clip (C).

## 2. How to use

### Cleaner description

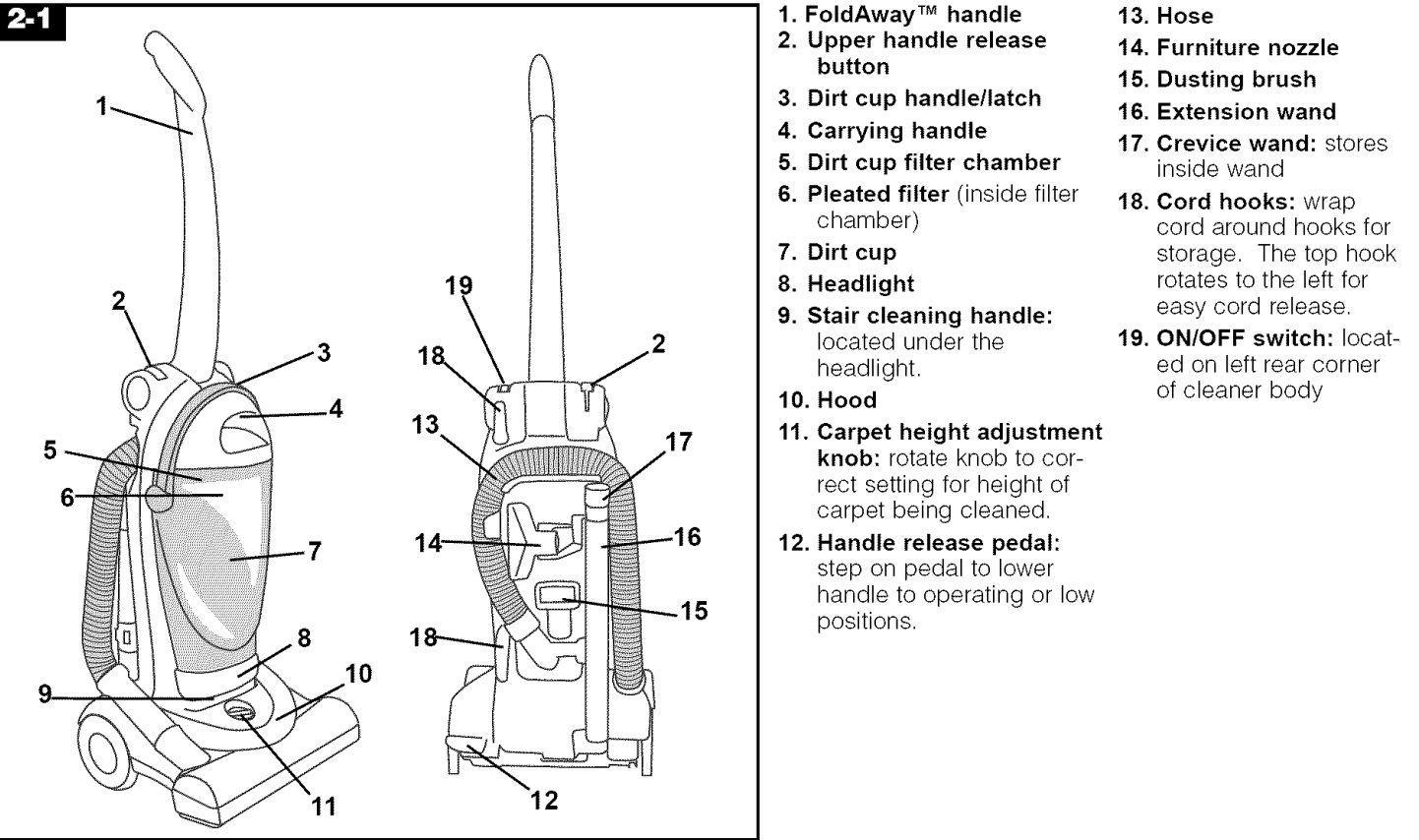

Operate cleaner only at voltage specified on data plate on bottom of cleaner.

This cleaner is intended for household use.

### Polarized plug

To reduce the risk of electric shock, this appliance has a polarized plug (one blade is wider than the other). This plug will fit in a polarized outlet only one way. If the plug does not fit fully in the outlet, reverse the plug. If it still does not fit, contact a qualified electrician to install the proper outlet. Do not change the plug in any way.

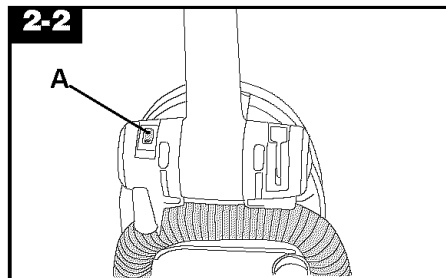

### ON-OFF switch

Plug cord into electrical outlet.

To turn cleaner ON, push switch (A) toward front of cleaner.

To turn cleaner OFF, push toward back of cleaner.

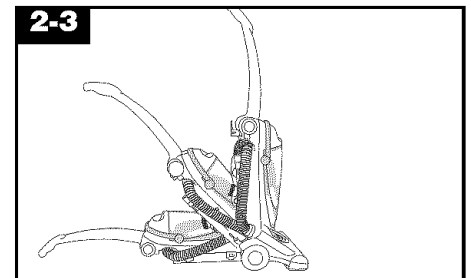

### Handle positions

The handle of your cleaner has three positions; **upright** when using cleaning tools; **operating position** for general operation on carpet and floors; **low** for reaching under low furniture. Step on handle release pedal to lower handle.

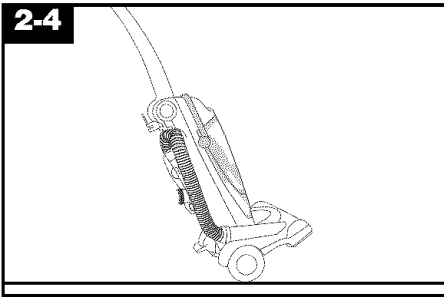

## 2-4 Transporting cleaner

Put handle in upright position. Tilt cleaner back on rear wheels. Push forward.

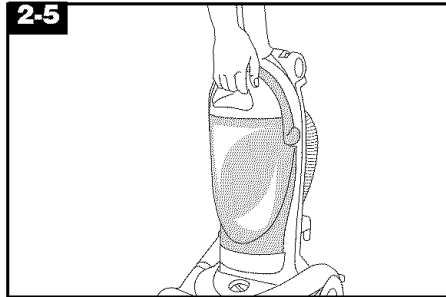

## 2-5 Carrying handle

Use the carrying handle to lift the cleaner.

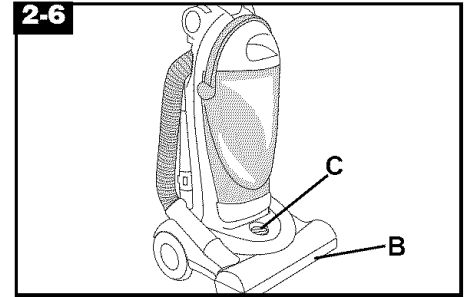

## 2-6 Carpet height adjustment

The cleaning of carpet and rugs takes place at the nozzle (B).

When it is necessary to raise and lower the nozzle for various carpet pile heights, turn the carpet height adjustment knob (C) to the desired setting.

For ease in turning the knob, place handle in upright position and tilt cleaner back slightly.

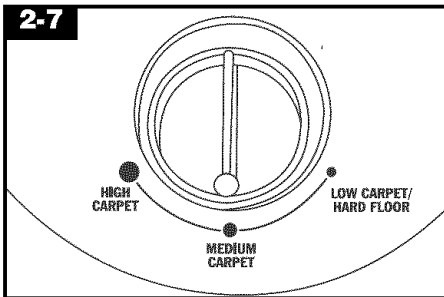

## 2-7 Settings

For maximum cleaning performance, the following carpet height settings are recommended.

- **Low setting:** for all types of carpet and hard floors.

**Note:** If the cleaner is difficult to push, rotate knob to the next higher setting.

- **Medium and High settings:** for deeper pile carpet where easier pushing effort is desired, while maintaining good cleaning performance.

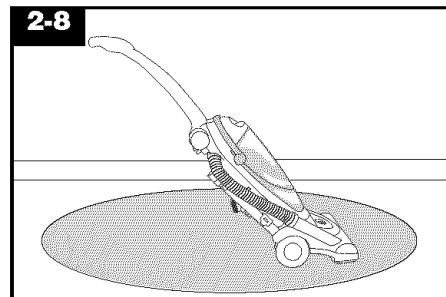

## 2-8 Cleaning lightweight flexible rugs

Stand on one end of rug and move cleaner toward other end or edge. Before reaching edge, push down on handle. This will lift up the nozzle (front of cleaner) as shown and will prevent rug from clinging to cleaner. Continue to lift up nozzle so that when you have reached the edge, it is completely off the rug. Move cleaner back to start again, lower nozzle, and use only forward strokes.

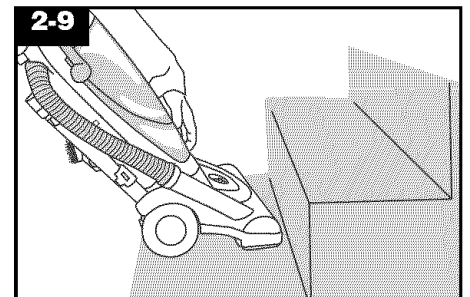

## 2-9 Stair cleaning

A stair cleaning handle has been designed for ease in using your cleaner on stairs. With handle in operating position, place fingers under edge of stair cleaning handle and guide cleaner with other hand on upper handle.

As an alternative, you may use the hose and furniture nozzle for stair cleaning. Clean from bottom to top.

**When using cleaning tools, the agitator will continue to rotate.**

**CAUTION:** To avoid personal injury or unnecessary wear to carpet, and to prevent the cleaner from falling, always place it at the bottom of the stairs.

## Cleaning tools

Tools allow for cleaning surfaces above the floor and for reaching hard to clean areas.

The cleaner is ready for tool use when handle is in upright position.

**CAUTION: Agitator continues to rotate while cleaner handle is in upright position. Avoid tipping cleaner or setting it on furniture, fringed area rugs or carpeted stairs during tool use.**

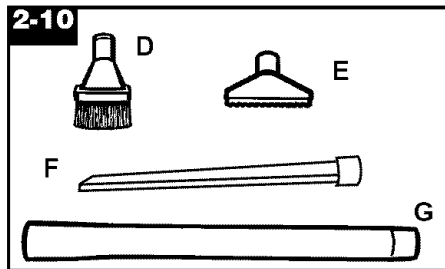

### Select proper tool

**D. Dusting brush** may be used for carved furniture, table tops, books, lamps, lighting fixtures, venetian blinds, baseboards, shutters, and registers.

**E. Furniture nozzle** may be used for upholstered furniture, draperies, mattresses, clothing, automobile interiors, and carpeted stairs.

**F. Crevice wand** (stores inside extension wand) can be used in tight spaces, corners and along edges in such places as dresser drawers, upholstered furniture, stairs and baseboards. It can also be used for extra reach with the dusting brush and/or extension wand.

**G. Extension wand** is used to give extra length to your hose. Use it with any of the above tools.

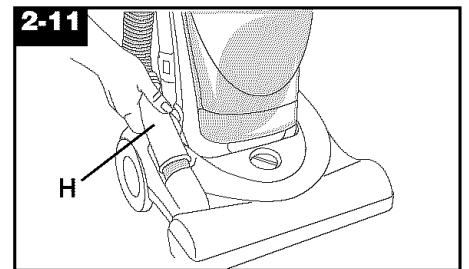

### Remove hose

When using cleaning tools, **cleaner handle should be in the upright position**. Also, **turn cleaner OFF before disconnecting and connecting the hose (H)**.

Remove hose end from cleaner base.

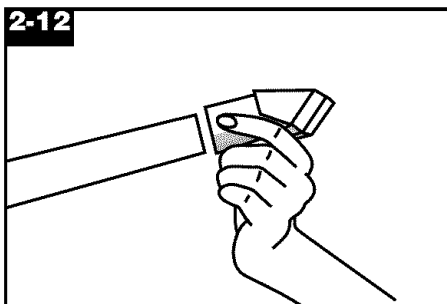

### Attach wand and tools

The tools are attached to the hose or the wand in the same manner.

Push tool firmly onto hose; twist tool slightly to tighten or loosen connection.

Attach second wand or tool to the wand in the same manner.

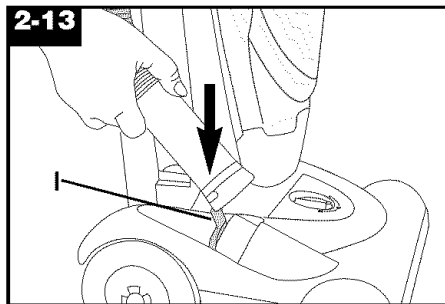

### Replacing hose

When you are finished cleaning with the tools, use the end of the hose to push the cover (I) down and push hose onto opening.

Twist hose end slightly to tighten the connector.

### Extra reach hose

(available at additional cost)

The extra reach hose provides easier cleaning of stairs and hard to reach places. Follow the steps below for attaching and detaching hose.

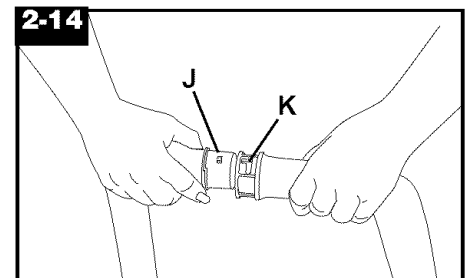

**Turn cleaner OFF before disconnecting and connecting hose.**

Remove hose end from cleaner base.

Align end of extra reach hose with projections (J) with slots (K) on end of attached hose.

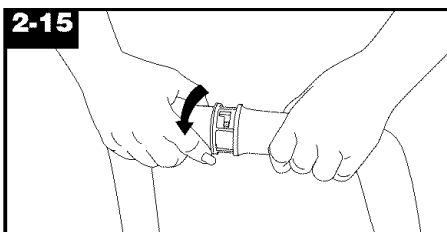

Slide hose into slots and twist hose to lock it into place. (To detach hose, reverse procedure.)

Attach wands or tools to the other end of hose.

### How to clean tools

To clean the hose, wipe off dirt with a cloth dampened in a mild detergent. Rinse with a damp cloth.

Cleaning tools may be washed in warm water with a detergent. Rinse and air dry before using.

## 3. Maintenance

Familiarize yourself with these home maintenance tasks as proper use and care of your cleaner will ensure continued cleaning effectiveness.

### Dirt cup

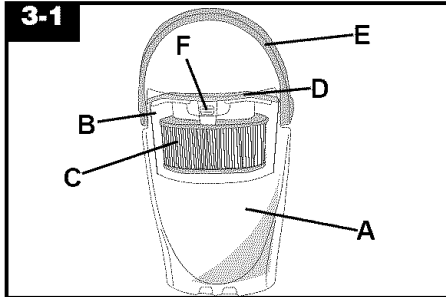

The dirt cup assembly consists of the following parts:

- Dirt cup (A)
- Filter chamber (B)
- Pleated filter (C)
- Lid (D)
- Dirt cup carry handle/latch (E)
- Filter chamber release latch (F)

While the cleaner is in operation, the screen at the bottom of the filter chamber will stop larger debris from entering the pleated filter chamber. This larger debris will be seen collecting in the dirt cup. The pleated filter will collect fine particles that have passed through the screen.

### When to empty

It is recommended that the dirt cup be emptied before the dirt reaches the dirt opening on back of dirt cup (Fig. 4-2) or after every use if preferred.

**CAUTION:** Very fine materials, such as face powder or cornstarch, may seal the filter and cause loss of suction. When using the cleaner for this type of dust, empty the cup and clean the filters often.

### How to empty

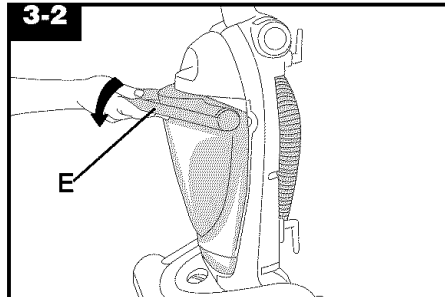

**Disconnect cleaner from electrical outlet. Do not use the cleaner without dirt cup or filters in place.**

Pull dirt cup handle (E) down. Remove dirt cup.

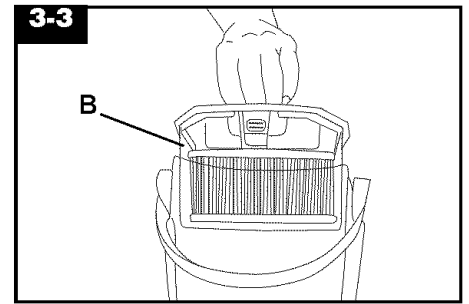

Remove filter chamber (B) from dirt cup.

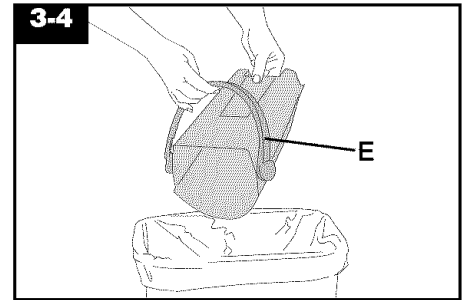

Holding the carry handle (E), empty dirt cup into wastebasket.

### Filter assembly How to clean filter assembly

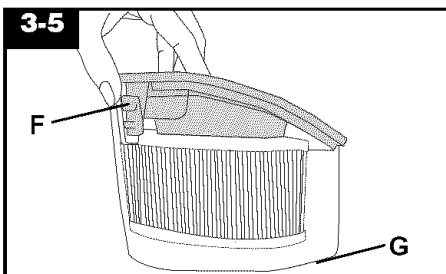

Press latch (F) on front of filter chamber and remove lid. The pleated filter is attached to the lid.

The screen (G) on the bottom of the chamber can be cleaned with a soft brush.

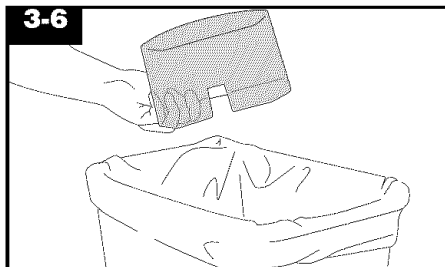

Empty filter chamber.

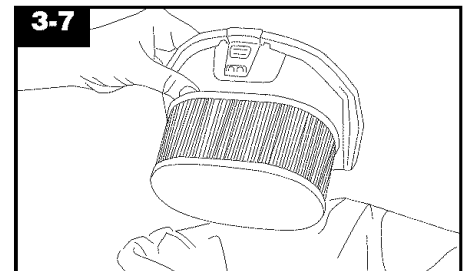

Holding lid, tap bottom of filter against edge of wastebasket until dust particles stop falling from filter.

**Do not tap the soft, pleated part of the filter. It could damage the filter.**

**Do not rinse or wash the filter.**

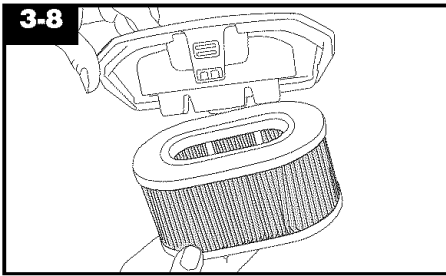

Although not necessary, the filter can be removed from the lid for cleaning. Pull filter off lid and tap bottom of filter. To replace, firmly press filter onto lid until it stops.

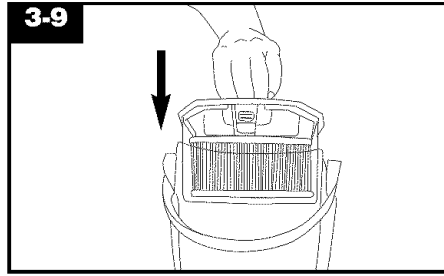

Replace lid and filter on filter chamber. Replace chamber on dirt cup.

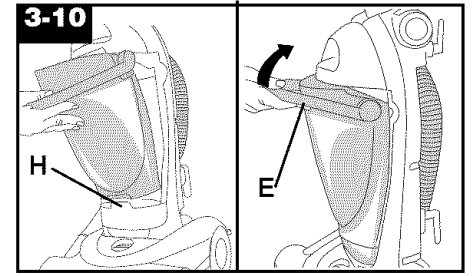

Place bottom of cup behind tab (H) and press cup into cleaner. Rotate dirt cup handle (E) up to lock cup in place.

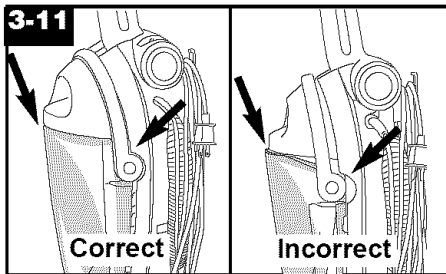

Be certain that the dirt cup is locked in the correct position.

## Final filter

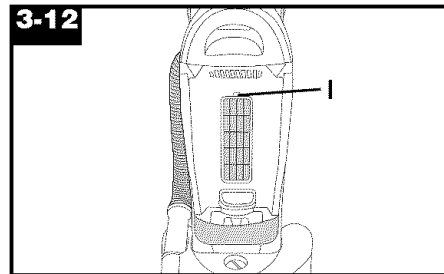

### Cleaning final filter

The **final filter** assists in returning clean air to the room. Remove dirt cup. Press latch (I) and remove filter grid.

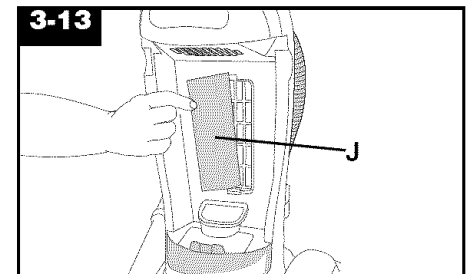

Lift out filter (J) and hand wash in cold water with a mild detergent. Let filter air dry then reposition. Replace filter grid and dirt cup. Should you want to replace this filter, ask for **HOOVER part no. 40110004**. **Do not operate cleaner without any of the filters in place.**

## Headlight replacement

### What to buy

This cleaner uses a 12 volt, wedge base type 912 bulb, **HOOVER part No. 27313107**.

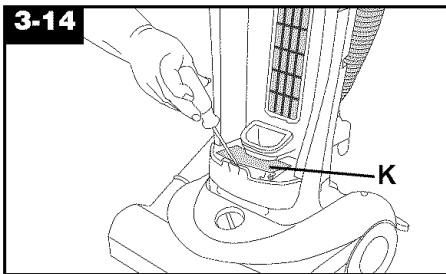

**Disconnect cleaner from electrical outlet.**

Remove dirt cup as described in Fig. 3-2.

Insert a flat screwdriver into slot and remove the access door (K).

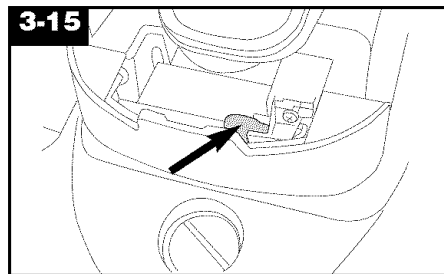

Pull old bulb straight out of socket. Push new bulb straight into socket until locked in place.

**Excessive force is not required.**

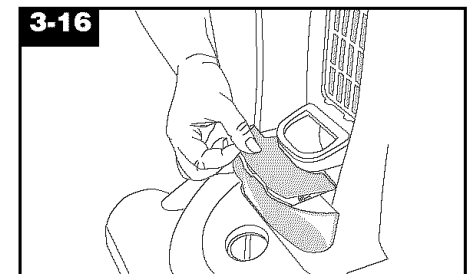

Snap access door into place. Reposition dirt cup (Fig. 3-10).



## Belt replacement

The belt on your Hoover cleaner causes the agitator to rotate and is important for the effective operation of the cleaner. The belt is located under the hood of the cleaner and should be checked from time to time to be sure it is in good condition.

### When to replace

#### Disconnect cleaner from electrical outlet.

To check belt, remove hood and agitator cover as shown in Figs. 3-17 through 3-19. Replace belt if it is stretched, cut or broken.

### What to buy

To assure effective operation, use only genuine HOOVER belts with your cleaner. When purchasing a new belt, ask for **HOOVER part No. 40201190**.

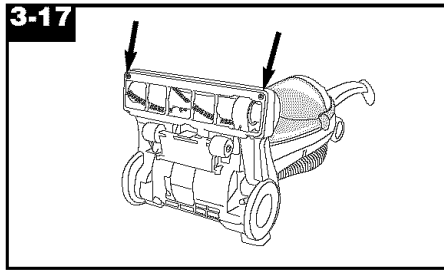

### How to replace

#### Disconnect cleaner from electrical outlet.

With the handle in the upright position, tilt cleaner back until it rests on floor.

Remove the 2 screws near the front of the brush roll cavity.

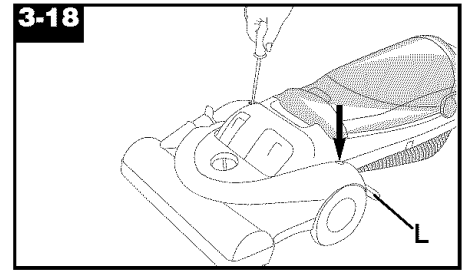

Press on handle release pedal (L) and lower the nozzle so it is flat.

Remove hose end (Fig. 2-11).

Remove 2 screws at rear of hood.

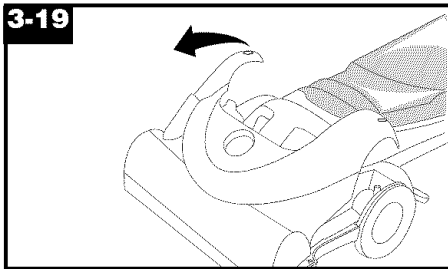

Lift hood off cleaner.

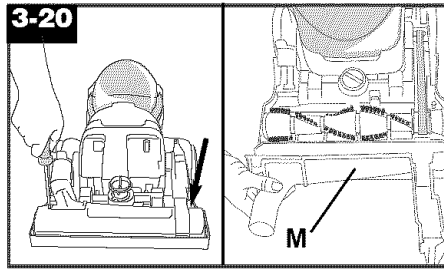

Remove the 2 screws behind the agitator cover.

Remove agitator cover (M).

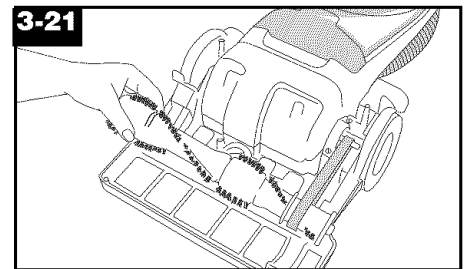

Remove agitator and used belt.

Discard used belt.

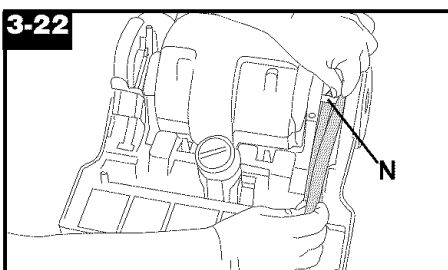

With lettering to the outside of belt, slide new belt along side of cleaner cavity and over motor pulley (N).

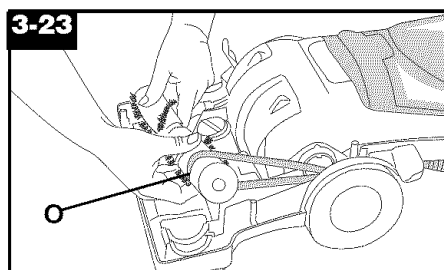

Insert agitator through belt and place belt in belt guide (O).

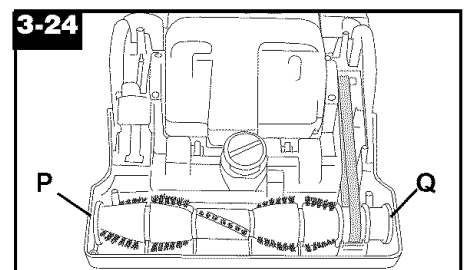

Grasp agitator firmly and fit it into position by first sliding end opposite the belt into the rectangular slot (P) on side of cleaner.

Pull other side of agitator (Q) into place.

Turn agitator, making sure belt is not pinched between agitator and cleaner body. The belt must rotate freely inside the belt guide. If the agitator does not turn, reposition belt in the belt guide.

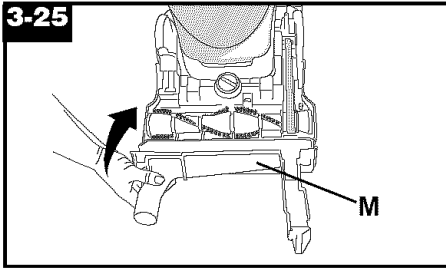

Replace agitator cover (M) and 2 screws.

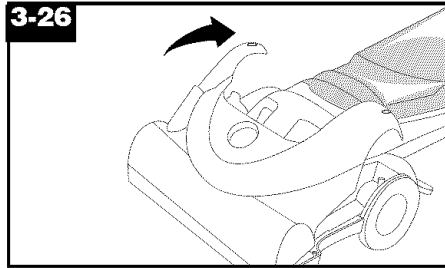

Replace hood, 2 screws and hose.

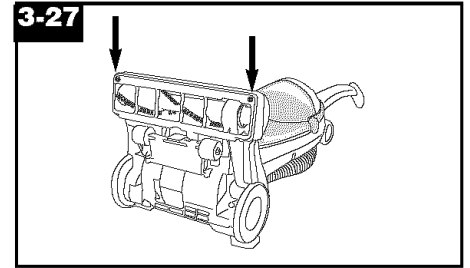

Raise nozzle up and replace the 2 screws on the bottom.

## The agitator brush roll

### When to replace

When agitator brushes are worn, the agitator should be replaced.

To check condition of brushes, **disconnect cleaner from electrical outlet.**

Move edge of a card across bottom plate while turning agitator. To maintain cleaning effectiveness, replace agitator if brushes do not touch card.

### What to buy

When purchasing a new agitator, ask for

13" - HOOVER part no. 48414110

15" - HOOVER part no. 48414115.

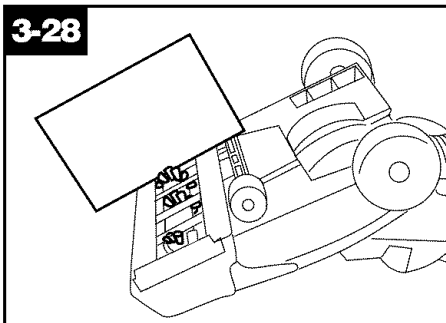

## How to replace

### Disconnect cleaner from electrical outlet.

Remove hood and agitator cover as described in the "Belt replacement" section.

Discard old agitator.

Continue following the directions in the "Belt replacement" section to replace belt, new agitator, agitator cover and hood.

## Lubrication

The motor is equipped with bearings that contain sufficient lubrication for the life of the motor. The addition of lubricant could cause damage. **Therefore, do not add lubricant to motor bearings.**

The agitator brush roll is equipped with two ball bearings that should be lubricated periodically by a Hoover Factory Service Center or an Authorized Hoover Warranty Service Dealer (Depot).

## Thermal protector

An internal thermal protector has been designed into your cleaner to protect it from overheating.

**When the thermal protector activates, the cleaner will stop running.** If this happens, proceed as follows:

1. **Turn the cleaner OFF and disconnect it from the electrical outlet.**
2. Check filters for dirt accumulation.
3. Refer to "Clearing blockages" section.

4. **When cleaner is unplugged and the motor cools for 30 minutes,** the thermal protector automatically resets and cleaning may continue.

If the thermal protector continues to activate after following the above steps, your cleaner may need servicing (see "Service" section).

## Service

To obtain approved HOOVER service and genuine HOOVER parts, locate the nearest **Hoover Factory Service Center or Authorized Hoover Warranty Service Dealer (Depot)** by:

- checking the Yellow Pages under "Vacuum Cleaners - Household" OR -
- checking the list of Factory Service Centers provided with this cleaner OR -
- checking the Service section of The Hoover Company on-line at **www.hoover.com** OR -
- calling **1-800-944-9200** for an automated referral of authorized service outlet locations (U.S. only).

**Do not** send your cleaner to The Hoover Company in North Canton for service, this will only result in delay.

If further assistance is needed, contact The Hoover Company Consumer Response Center, North Canton, Ohio 44720, Phone: 330-499-9499.

**In Canada**, contact Hoover Canada, Burlington, Ontario L7R 4A8, Phone: 1-800-263-6376.

Always identify your cleaner by the **complete** model number when requesting information or ordering parts. (The model number appears on the bottom of the cleaner.)

## Hoover cleaning performance

This Hoover Cleaning Performance System is for comparing the relative progressive performance of **Hoover uprights only** and not for comparison with any other brands. The majority of this rating is based upon the ASTM International Carpet Cleaning Effectiveness Test (ASTM Test F608). Other performance factors include Hose Power (ASTM Test F558), Surface Litter Cleaning, Hard Floor Cleaning, Edge Cleaning, Cleaning Width, and Air Filtration.

## 4. If you have a problem

If a minor problem occurs, it usually can be solved quite easily when the cause is found by using the check list below.

### Problem: Cleaner won't run

**Possible cause**  
*Possible solution*

- **Not firmly plugged in**
  - Plug unit in firmly
- **No voltage in wall plug**
  - Check fuse or breaker
- **Blown fuse or tripped breaker**
  - Replace fuse or reset breaker
- **Thermal protector activated**
  - Allow cleaner to cool for 30 minutes (this will reset the thermal protector) (see pg. 10).

### Problem: Cleaner won't pick up

**Possible cause**  
*Possible solution*

- **Broken or worn belt**
  - Replace belt
- **Agitator brush roll worn**
  - Replace brush roll
- **Dirt cup full**
  - Empty cup
- **Incorrect carpet height setting**
  - Move nozzle control knob to lower setting
- **Blockage in air flow passage**
  - Clear blockage
- **Pleated filter clogged**
  - Clean pleated filter as described in the "Filter assembly" section
- **Dirt cup not properly installed**
  - Position dirt cup properly and lock in place (Fig. 3-10)
- **Filter chamber lid not positioned properly or missing**
  - Ensure that filter chamber lid is properly positioned
- **Filter assembly not installed properly**
  - Ensure that the filter assembly is positioned properly (Fig. 3-9)

### Problem: Cleaner hard to push

**Possible cause**  
*Possible solution*

- **Incorrect carpet height setting**
  - Move nozzle control knob to a higher setting

### Problem: Cleaning tools won't pick up

**Possible cause**  
*Possible solution*

- **Dirt cup not properly installed**
  - Position dirt cup properly and lock in place (Fig. 3-10)
- **Blockage in hose**
  - Clear blockage

### Problem: Smoky/burning smell detected

**Possible cause**  
*Possible solution*

- **Belt broken or stretched**
  - Replace agitator brush roll belt as described in Figs. 3-17 through 3-27 in the Maintenance section.

## Clearing blockages

**Disconnect cleaner from electrical outlet.**

Low suction or pick up may be due to a blockage in the system. Refer to the following steps to check for blockages **continuing with each step until the blockage is found:**

**Turn cleaner OFF and disconnect from electrical outlet.**

1. Check fullness of dirt cup and filter assembly; empty cup and clean filters if needed.

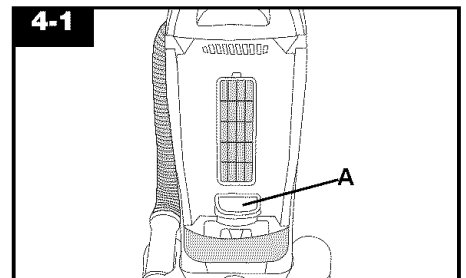

### Check dirt path

2. Remove dirt cup, look in duct (A).
3. Clear blockage from dirt duct.

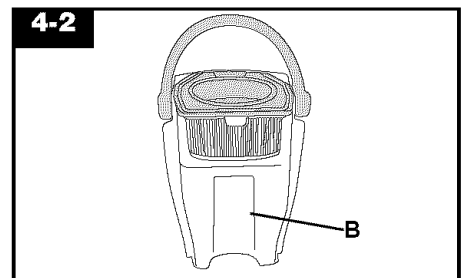

### Check intake opening

4. Remove dirt cup and look in duct (B).
5. Clear blockage from duct.

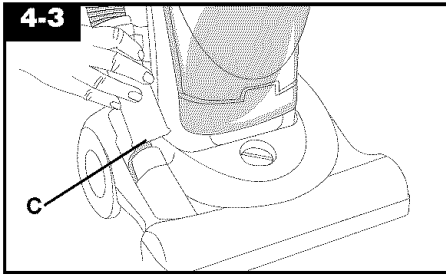

**4-3**

**Check airflow path**

6. Remove hose end from cleaner.
7. Plug cleaner in and turn ON. Check for suction at end of hose (C).
  - a. If there is **suction**, continue with step 8.
  - b. If there is **no suction**, check for blockage in hose. Clear out hose.

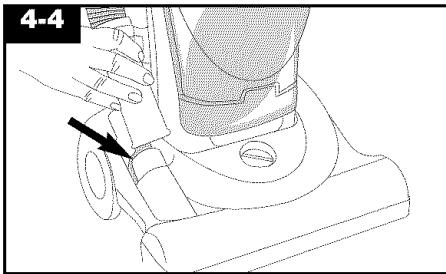

**4-4**

**Check hose inlet**

8. Turn cleaner OFF and unplug.
9. Remove hose end from cleaner.
10. Press hose inlet door open and clear any blockages.

**Full One Year  
Warranty  
(Domestic Use)**

Your HOOVER® appliance is warranted in normal household use, in accordance with the Owner's Manual against original defects in material and workmanship for a period of one full year from date of purchase. This warranty provides, at no cost to you, all labor and parts to place this appliance in correct operating condition during the warranted period. This warranty applies when the appliance is purchased in the United States including its territories and possessions, or in Canada or from a U.S. Military Exchange. Appliances purchased elsewhere are covered by a limited one year warranty which covers the cost of parts only. This warranty does not apply if the appliance is used in a commercial or rental application.

Warranty service can only be obtained by presenting the appliance to one of the following Authorized Warranty Service outlets. Proof of purchase will be required before service is rendered.

1. Hoover Factory Service Centers
2. Hoover Authorized Warranty Service Dealers (Depots)

**For an automated referral of authorized service outlets in the U.S.A., phone 1-800-944-9200 OR visit The Hoover Company on-line at [www.hoover.com](http://www.hoover.com)**

This warranty does not cover pick up, delivery, or house calls; however, if you mail your appliance to a Hoover Factory Service Center for warranty service, transportation will be paid one way.

While this warranty gives you specific legal rights, you may also have other rights which vary from state to state (or province).

If further assistance is needed, or if there are questions concerning this warranty or the availability of warranty service outlets, write or phone the Consumer Response Center, The Hoover Company, 101 East Maple St., North Canton, Ohio 44720. Phone 330-499-9499.

In Canada, contact Hoover Canada, Burlington, Ontario, L7R 4A8. Phone 1-800-263-6376.