

OPERATION MANUAL

MODEL
KB-3300J

Followed by indicating color: K = black, W = white, S = stainless steel

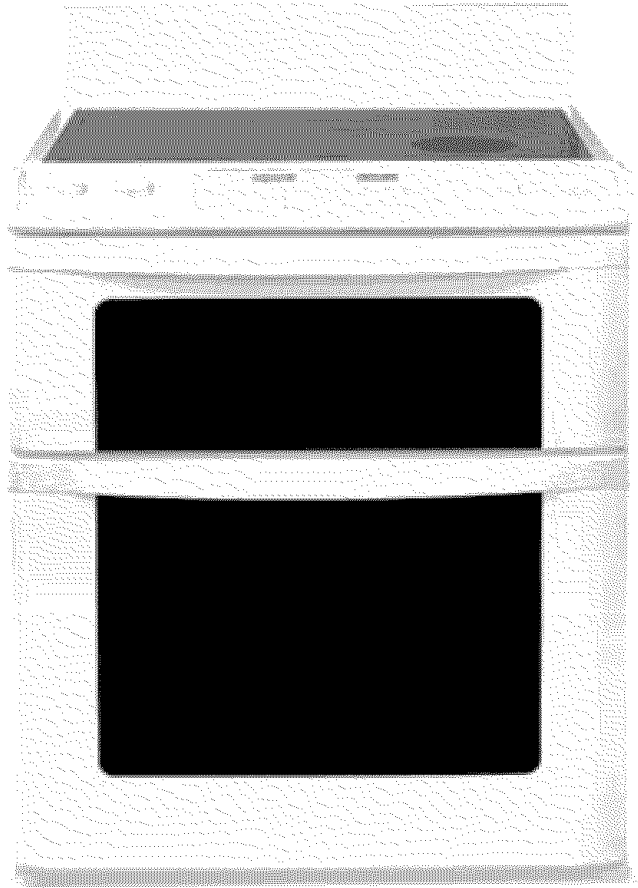

CONTENTS	2	BEFORE OPERATING	11
CUSTOMER ASSISTANCE	3	COOKTOP USE	12-13
PRECAUTIONS TO AVOID POSSIBLE EXPOSURE TO EXCESSIVE MICROWAVE ENERGY	3	MICROWAVE DRAWER™ COOKING	14-20
CONSUMER LIMITED WARRANTY	4	OVEN COOKING	21-24
IMPORTANT SAFETY INSTRUCTIONS	5-7	OTHER FEATURES	24-26
PARTS	8-10	CLEANING AND CARE	26-28
		BEFORE YOU CALL FOR SERVICE	29-30

SHARP®

Insight™

ELECTRIC RANGE WITH MICROWAVE DRAWER

CONTENTS

CONTENTS	2	MICRO WARM	19
CUSTOMER ASSISTANCE	3	TIMER	19
PRECAUTIONS TO AVOID POSSIBLE EXPOSURE TO EXCESSIVE MICROWAVE ENERGY	3	MULTIPLE SEQUENCE COOKING	20
CONSUMER LIMITED WARRANTY	4	HELP	20
PRODUCT INFORMATION CARD	4	MINUTE PLUS	20
IMPORTANT SAFETY INSTRUCTIONS	5-7	MORE OR LESS TIME ADJUSTMENT	20
IMPORTANT SAFETY NOTICE AND WARNING	5	AUTO START	20
SAFETY PRECAUTIONS	5	AUDIBLE SIGNAL ELIMINATION	20
RADIANT SURFACE UNITS	6	END OF COOKING REMINDER	20
MICROWAVE DRAWER™	6-7	CONTROL LOCK	25
OVEN	7	OVEN COOKING	21-24
SELF-CLEANING OVEN	7	INFORMATION YOU NEED TO KNOW	21
PARTS	8-10	BEFORE USING OVEN	21
ADJUSTABLE HEIGHT BACKSPLASH	9	HOW TO SET OVEN TEMPERATURE	22
BEFORE OPERATING	11	HOW TO PROOF	22
TO SET THE CLOCK	11	HOW TO SET TIMED COOK	22
TIMERS	11	HOW TO SET DELAY START	22
STOP/CLEAR	11	HOW TO SET BROIL	22
COOKTOP USE	12-13	BROILING GUIDE	23-24
INFORMATION YOU NEED TO KNOW	12	OTHER FEATURES	24-26
RADIANT SURFACE UNITS	13	HOW TO START SELF-CLEAN	24
SUGGESTED HEAT SETTINGS	13	OVEN LIGHT	24
MICROWAVE DRAWER COOKING	14-20	TIMER	24
INFORMATION YOU NEED TO KNOW	14	3 MINUTE PLUS	24
TIME COOKING	16	CONTROL LOCK	25
TO SET POWER LEVEL	16	SETUP/CUSTOM HELP	25-26
SENSOR SETTINGS	16	CLEANING AND CARE	26-28
SENSOR POPCORN / SENSOR REHEAT	17	NON-COOKTOP SURFACES	26
SENSOR COOKING	17	COOKTOP	26
DEFROST	18	MICROWAVE DRAWER	27
MANUAL DEFROST	19	OVEN	27
REHEAT	19	REMOVE AND REPLACE OVEN DOOR	27
		OVEN LIGHT REPLACEMENT	28
		OVEN RACKS	28
		BROILER PAN AND GRID	28
		BEFORE YOU CALL FOR SERVICE	29-30
		AUTO-TOUCH GUIDE	31-32

CUSTOMER ASSISTANCE

To aid in reporting this electric range, please record below the model number and serial number located on the unit. We also suggest you record all the information listed and retain for future reference.

MODEL NUMBER _____ SERIAL NUMBER _____

DATE OF PURCHASE ____/____/____

DEALER _____ TELEPHONE _____

SERVICER _____ TELEPHONE _____

TO PHONE:

DIAL 1-800-BE-SHARP (237-4277) for:
SERVICE (for your nearest Sharp Authorized Servicer)
PARTS (for your authorized parts distributor)
ADDITIONAL CUSTOMER INFORMATION

DIAL 1-800-642-2122 for:
ADDITIONAL OVEN RACKS

TO WRITE:

Sharp Electronics Corporation
Customer Assistance Center
1300 Naperville Drive
Romeoville, IL 60446-1091

Please provide the following information when you write or call: model number, serial number, date of purchase, your complete mailing address (including zip code), your daytime telephone number (including area code) and description of the problem.

TO ACCESS INTERNET: www.sharppusa.com

PRECAUTIONS TO AVOID POSSIBLE EXPOSURE TO EXCESSIVE MICROWAVE ENERGY

- (a)** Do not attempt to operate this oven with the door open since open-door operation can result in harmful exposure to microwave energy. It is important not to defeat or tamper with the safety interlocks.
- (b)** Do not place any object between the oven front face and the door or allow soil or cleaner residue to accumulate on sealing surfaces.
- (c)** Do not operate the oven if it is damaged. It is particularly important that the oven door close properly and that there is no damage to the: (1) door (bent), (2) hinges and latches (broken or loosened), (3) door seals and sealing surfaces.
- (d)** The oven should not be adjusted or repaired by anyone except properly qualified service personnel.

These precautions apply to the Microwave Drawer only.

CONSUMER LIMITED WARRANTY

SHARP ELECTRONICS CORPORATION warrants to the first consumer purchaser that this Sharp brand product (the "Product"), when shipped in its original container, will be free from defective workmanship and materials, and agrees that it will, at its option, either repair the defect or replace the defective Product or part thereof with a new or remanufactured equivalent at no charge to the purchaser for parts or labor for the period(s) set forth below.

This warranty does not apply to any appearance items of the Product nor to the additional excluded item(s) set forth below nor to any Product the exterior of which has been damaged or defaced, which has been subjected to misuse, abnormal service or handling, or which has been altered or modified in design or construction.

In order to enforce the rights under this limited warranty, the purchaser should follow the steps set forth below and provide proof of purchase to the servicer.

The limited warranty described herein is in addition to whatever implied warranties may be granted to purchasers by law. ALL IMPLIED WARRANTIES INCLUDING THE WARRANTIES OF MERCHANTABILITY AND FITNESS FOR USE ARE LIMITED TO THE PERIOD(S) FROM THE DATE OF PURCHASE SET FORTH BELOW. Some states do not allow limitations on how long an implied warranty lasts, so the above limitation may not apply to you.

Neither the sales personnel of the seller nor any other person is authorized to make any warranties other than those described herein, or to extend the duration of any warranties beyond the time period described above on behalf of Sharp.

The warranties described herein shall be the sole and exclusive warranties granted by Sharp and shall be the sole and exclusive remedy available to the purchaser. Correction of defects, in the manner and for the period of time described herein, shall constitute complete fulfillment of all liabilities and responsibilities of Sharp to the purchaser with respect to the Product, and shall constitute full satisfaction of all claims, whether based on contract, negligence, strict liability or otherwise. In no event shall Sharp be liable, or in any way responsible, for any damages or defects in the Product which were caused by repairs or attempted repairs performed by anyone other than an authorized servicer. Nor shall Sharp be liable or in any way responsible for any incident or consequential economic or property damage. Some states do not allow the exclusion of incidental or consequential damages, so the above exclusion may not apply to you.

THIS WARRANTY GIVES YOU SPECIFIC LEGAL RIGHTS. YOU MAY ALSO HAVE OTHER RIGHTS WHICH VARY FROM STATE TO STATE.

Your product model number & description	KB-3300J Home Use Electric Range with Microwave Drawer. (Be sure to have this information available when you need service for your Product.)
Warranty period for this product:	One (1) year parts and labor including in-home service. The warranty period continues for an additional four (4) years, for a total of five (5) years, with respect to the glass ceramic cooktop, radiant surface units and magnetron tube in the Product for parts only; labor and service are not provided free of charge for this additional period.
Additional item(s) excluded from warranty coverage (if any):	Non-functional accessories and light bulbs.
Where to obtain service:	From a Sharp Authorized Servicer located in the United States. To find the location of the nearest Sharp Authorized Servicer, call Sharp toll free at 1-800-BE-SHARP (1-800-237-3277).
What to do to obtain service:	In-home service is provided for one year from date of purchase. In-home service can be arranged by calling 1-800-BE-SHARP. Be sure to have Proof of Purchase available.

TO OBTAIN SUPPLY, ACCESSORY OR PRODUCT INFORMATION, CALL 1-800-BE-SHARP or visit www.sharpsusa.com. SAVE THE PROOF OF PURCHASE AS IT IS NEEDED SHOULD YOUR OVEN EVER REQUIRE WARRANTY SERVICE.

PRODUCT INFORMATION CARD

The Product Information Card should be completed within ten days of purchase and returned. We will keep it on file and help you access the information if needed. This will also enable us to contact you in the unlikely event that any adjustments or modifications are ever required for your range.

IMPORTANT SAFETY INSTRUCTIONS

READ ALL INSTRUCTIONS BEFORE USING

IMPORTANT SAFETY NOTICE AND WARNING

The California Safe Drinking Water and Toxic Enforcement Act of 1986 (Proposition 65) requires the Governor of California to publish a list of substances known to the State of California to cause cancer or reproductive harm and requires businesses to warn customer of potential exposures to such substances.

Users of this appliance are hereby warned that when it is engaged in the self-clean cycle, there may be low level exposure to carbon monoxide, a chemical known to the State of California to cause reproductive harm. Exposure can be minimized by properly venting the oven to the outdoors during the self-clean cycle, by opening a window and/or door in the room where the appliance is located.



WARNING All ranges can tip and injury could result. To reduce the risk of tipping of the appliance from abnormal usage by excessive loading of the oven door, the appliance must be secured to wall and floor by installing the Anti-Tip device supplied. If it is not, there is a possible risk of the range tipping over and causing injury if you or a child stand, sit or lean on an open door. Please refer to the Anti-Tip device information in the Installation Manual.



To check if the device is properly installed and engaged, look underneath the range with a flashlight to make sure one of the rear leveling legs is properly engaged in the bracket slot. The Anti-Tip device secures the rear leveling leg to the floor when properly engaged. You should check this anytime the range has been moved.

SAFETY PRECAUTIONS

When using electrical appliances, basic safety precautions should be followed, including the following:

- 1 Use this appliance only for its intended purpose as described in this manual.
- 2 Be sure your appliance is properly installed and grounded by a qualified technician in accordance with the provided installation instructions.
- 3 Never use appliance for warming or heating the room.
- 4 Children should not be left alone or unattended in area where appliance is in use. They should never be allowed to sit or stand on any part of the appliance.
- 5 Never wear loose-fitting or hanging garments while using the appliance. Be careful when reaching for items stored over the range. Flammable material could be ignited if brought in contact with hot surface units or heating elements and may cause severe burns.

- 6 Do not repair or replace any part of appliance unless specifically recommended in this manual. All other servicing should be referred to a qualified technician.
- 7 Do not store flammable materials in an oven, Microwave Drawer or near surface units. Do not store or use combustible materials, gasoline or other flammable vapors and liquids in the vicinity of this appliance.
- 8 Do not use water on grease fires. Smother a flame or use a dry chemical or foam-type extinguisher. Flaming grease outside a pan can be put out by covering it with baking soda or, if available, by a multi-purpose dry chemical or foam-type fire extinguisher.
- 9 Use only dry potholders - a moist or damp potholder on hot surfaces may result in burns from steam. Do not let potholders touch hot surfaces, radiant surface units or heating elements. Do not use a towel or other bulky cloth.
- 10 **CAUTION** Do not store items of interest to children in cabinets above a range or on the backsplash of a range. Children climbing on the range to reach items could be seriously injured.
- 11 Do not touch the surface units, heating elements or the interior surface of the oven. These surfaces may be hot even though they are dark in color. These surfaces may become hot enough to cause burns. During and after use, do not touch or let clothing or other flammable materials contact surface units, heating elements or interior surfaces of oven until they have had sufficient time to cool. Other potentially hot surfaces include: cooktop, areas facing the cooktop, oven vent opening, surfaces near the vent opening, oven door and window and area around the door.
- 12 Have the installer show you the location of the circuit breaker or fuse. Mark it for easy reference.
- 13 Before performing any service, disconnect the range power supply at the household distribution panel by removing the fuse or switching off the circuit breaker.
- 14 Do not allow anyone to climb, stand or hang on the door, Microwave Drawer or cooktop. They could damage the range and even tip it over, causing severe personal injury.
- 15 Teach children not to play with the controls or any other part of the range.
- 16 Always keep wooden and plastic utensils and canned food a safe distance from your range.
- 17 Always keep combustible wall coverings, curtains or drapes a safe distance from your range.

IMPORTANT SAFETY INSTRUCTIONS

RADIANT SURFACE UNITS

- 1 Use proper pan size — this appliance has different size surface units. Select utensils having flat bottoms large enough to cover the surface unit heating element. The use of undersized utensils will expose a portion of surface unit heating element to direct contact and may result in ignition of clothing. Proper relationship of utensils to heating element will also improve efficiency.
- 2 Never leave surface units unattended at high heat settings. Boilovers cause smoking and greasy spillovers that may catch on fire.
- 3 Only certain types of glass, glass/ceramic, ceramic, earthenware or other glazed utensils are suitable for cooktop service without breaking due to the sudden change in temperature.
- 4 To reduce the risk of burns, ignition of flammable materials and spillage due to unintentional contact with utensils, the handle of a utensil should be positioned so that it is turned inward and does not extend over adjacent surface units.
- 5 Do not cook on broken cooktop. If cooktop should break, cleaning solutions and spillovers may penetrate the broken cooktop and create a risk of electric shock. Contact a qualified technician immediately.
- 6 Clean cooktop with caution. If a wet sponge or cloth is used to wipe spills on a hot surface unit, be careful to avoid steam burn. Some cleaners can produce noxious fumes if applied to a hot surface. Please see cleaning the glass cooktop section.
- 7 Clean ventilating hoods frequently. Grease should not be allowed to accumulate on hood or filter.
- 8 When flaming foods under the hood, turn the fan on.
- 9 Deep fat fryers - use extreme caution when moving the grease kettle or disposing of hot grease.
- 10 Always turn the surface units off before removing cookware.
- 11 Keep an eye on foods being fried at high or medium high heat settings.
- 12 Food for frying should be as dry as possible. Frost on frozen foods or moisture on fresh foods can cause hot fat to bubble up and over the sides of the pan.
- 13 Use little fat for effective shallow or deep fat frying. Filling the pan too full of fat can cause spillovers when food is added.

If a combination of oils or fats will be used in frying, stir together before heating or as fats melt slowly.
- 14 Always heat fat slowly and watch as it heats.
- 15 Use a deep fat thermometer whenever possible to prevent heating fat beyond the smoking point.

- 16 Avoid scratching the glass cooktop. The cooktop can be scratched with items such as sharp instruments, rings or other jewelry and rivets on clothing.
- 17 Large scratches or impacts to glass doors or cooktop can lead to broken or shattered glass.
- 18 Never use the glass cooktop surface as cutting board.
- 19 Do not place or store items that can melt or catch fire on the glass cooktop, even when it is not being used.
- 20 Be careful when placing spoons or other stirring utensils on glass cooktop surface when it is in use. They may become hot and could cause burns.

MICROWAVE DRAWER

When using the Microwave Drawer, basic safety precautions should be followed, including the following:

WARNING *To reduce the risk of burns, electric shock, fire, injury to persons or exposure to excessive microwave energy:*

- 1 Read all instructions before using the appliance.
- 2 Read and follow the specific “PRECAUTIONS TO AVOID POSSIBLE EXPOSURE TO EXCESSIVE MICROWAVE ENERGY” on page 3.
- 3 This appliance must be properly grounded. See Installation Instructions for grounding instructions.
- 4 Install or locate this appliance only in accordance with the provided Installation Manual.
- 5 Some products such as whole eggs and sealed containers - for example, closed glass jars—are able to explode and should not be heated in the Microwave Drawer.
- 6 Use this appliance only for its intended use as described in this manual. Do not use corrosive chemicals or vapors in this appliance. This Microwave Drawer is specifically designed to heat, cook or dry food. It is not designed for industrial or laboratory use.
- 7 As with any appliance, close supervision is necessary when used by children.
- 8 Do not operate this appliance if it has a damaged cord or plug, if it is not working properly or if it has been damaged or dropped.
- 9 This appliance should be serviced only by qualified service personnel. Contact nearest Sharp Authorized Servicer for examination, repair or adjustment.
- 10 Do not cover or block any openings on the appliance.
- 11 Do not store or use this appliance outdoors. Do not use this product near water—for example, in a wet basement, near a swimming pool or similar locations.
- 12 Do not immerse cord or plug in water. Keep cord away from heated surfaces.
- 13 Do not climb or sit on the Microwave Drawer. The range could tip and cause injuries to persons.

IMPORTANT SAFETY INSTRUCTIONS

- 14** Be sure that fingers or other objects or materials are not around the Microwave Drawer opening when the Microwave Drawer is closed.
- 15** Do not put fingers or clothes around the drawer guides when the Microwave Drawer is opened or closed. They could be caught in the guides when the Microwave Drawer is closed.
- 16** Be sure that the food and container are shorter than the Microwave Drawer before closing it. You can refer to the height of the side walls of the Microwave Drawer.
- 17** When cleaning Microwave Drawer sealing surfaces that come together on closing the drawer, use only mild, nonabrasive soaps or detergents applied with a sponge or soft cloth. See cleaning instructions on page 27.
- 18** To reduce the risk of fire in the Microwave Drawer cavity:
 - a** Do not overcook food. Carefully attend appliance when paper, plastic or other combustible materials are placed inside the Microwave Drawer to facilitate cooking.
 - b** Remove wire twist-ties from paper or plastic bags before placing bag in Microwave Drawer.
 - c** If materials inside the Microwave Drawer ignite, keep Microwave Drawer door closed, turn microwave off and shut off power at the fuse or circuit breaker panel.
 - d** Do not use the Microwave Drawer for storage purposes. Do not leave paper products, cooking utensils, or food in the Microwave Drawer when not in use.
- 19** Liquids, such as water, coffee or tea are able to be overheated beyond the boiling point without appearing to be boiling. Visible bubbling or boiling when the container is removed from the Microwave Drawer is not always present. **THIS COULD RESULT IN VERY HOT LIQUIDS SUDDENLY BOILING OVER WHEN A SPOON OR OTHER UTENSIL IS INSERTED INTO THE LIQUID.**

To reduce the risk of injury to persons:

 - a** Do not overheat the liquid.
 - b** Stir the liquid both before and halfway through heating it.
 - c** Do not use straight-sided containers with narrow necks. Use a wide-mouthed container.
 - d** After heating, allow the container to stand in the Microwave Drawer at least for 20 seconds before removing the container.
 - e** Use extreme care when inserting a spoon or other utensil into the container.

OVEN

- 1** Use care when opening door—let hot air or steam escape before removing or replacing food.
- 2** Do not heat unopened food containers. Build-up of pressure may cause container to burst and result in injury.
- 3** Keep oven vent unobstructed.
- 4** Always place oven racks in desired locations while oven is cool. If rack must be moved while oven is hot, do not let potholder contact hot heating element.
- 5** Do not use aluminum foil to line oven bottom, as use may result in a risk of electric shock or fire.
- 6** Keep the oven free from grease buildup.
- 7** When using cooking or roasting bags in the oven, follow the manufacturer's directions.
- 8** Pulling out the rack to the stop-lock is a convenience in lifting heavy foods. It is also a precaution against burns from touching hot surfaces of the door or oven walls.
- 9** Do not use the oven to dry newspapers. If overheated, they can catch fire.
- 10** Do not use the oven for a storage area. Items stored in oven can ignite.
- 11** Do not leave paper products, cooking utensils or food in the oven when not in use.

SELF-CLEANING OVEN

- 1** Do not clean door gasket. The door gasket is essential for a good seal. Care should be taken not to rub, damage or move the gasket.
- 2** Do not use oven cleaners. No commercial oven cleaner or oven liner protective coating of any kind should be used in or around any part of the oven. Residue from oven cleaners will damage the inside of the oven when the self-clean cycle is used.
- 3** Clean only parts listed in this manual.
- 4** Before self-cleaning the oven, remove broiler pan, racks, and other utensils.
- 5** If the self-cleaning mode malfunctions, turn the oven off and disconnect the power supply. Have it serviced by a qualified technician.

SAVE THESE INSTRUCTIONS

PARTS NAME

ELECTRIC RANGE WITH MICROWAVE DRAWER

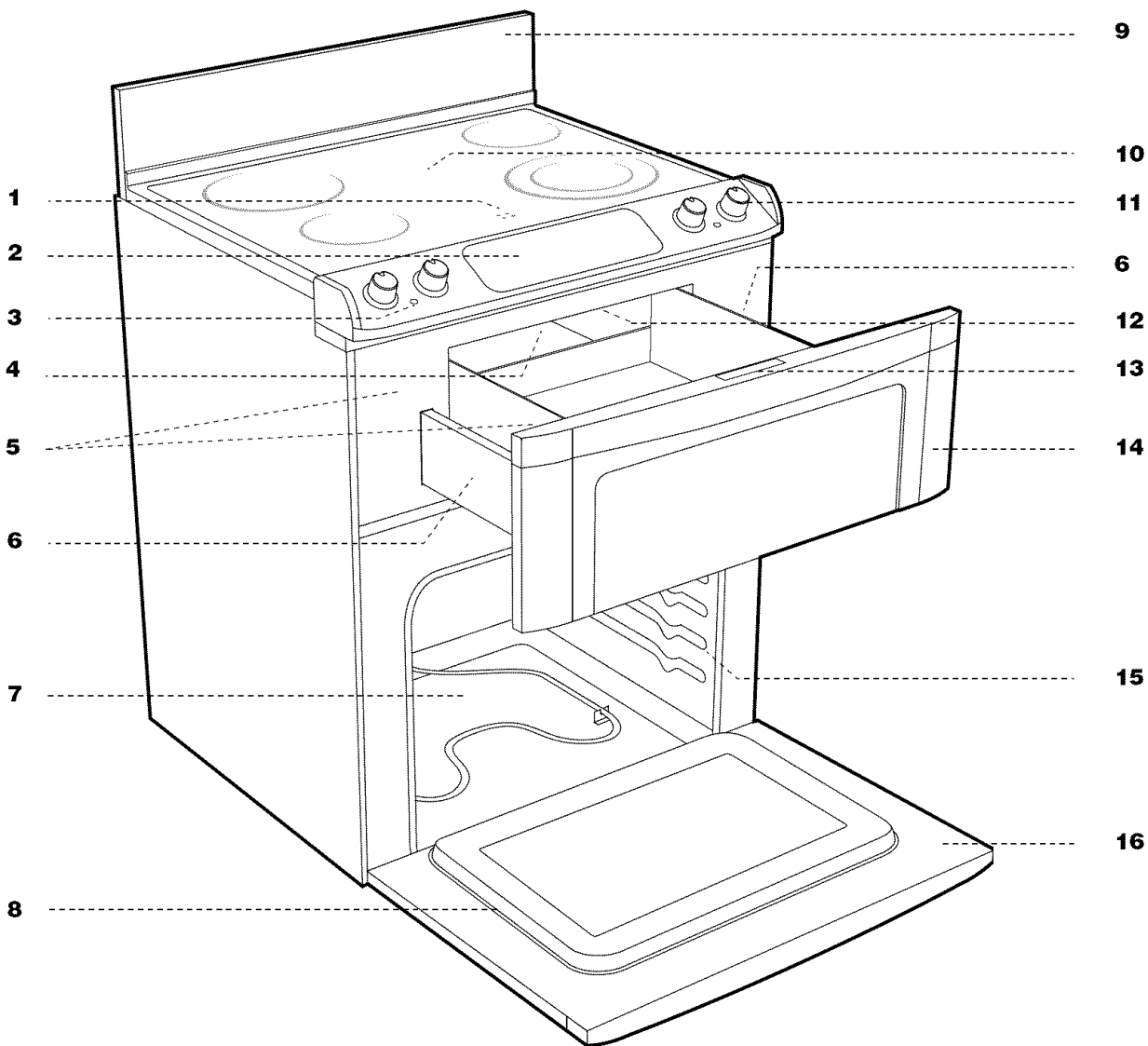

- | | |
|--|---------------------------------------|
| 1 Hot surface indicator | 13 Microwave Drawer Menu Label |
| 2 Control panel | 14 Microwave Drawer™ |
| 3 Cooktop-on indicator | 15 Rack supports |
| 4 Waveguide cover DO NOT REMOVE | 16 Oven door |
| 5 Drawer sealing surfaces | 17 Top heating element |
| 6 Microwave Drawer guides | 18 Oven door lock |
| 7 Oven | 19 Oven light |
| 8 Gasket | 20 Bottom heating element |
| 9 Adjustable backsplash | 21 Broiler pan grid |
| 10 Glass ceramic cooktop | 22 Broiler pan |
| 11 Control knobs | 23 Standard rack |
| 12 Drawer light | 24 EZ Pull rack |

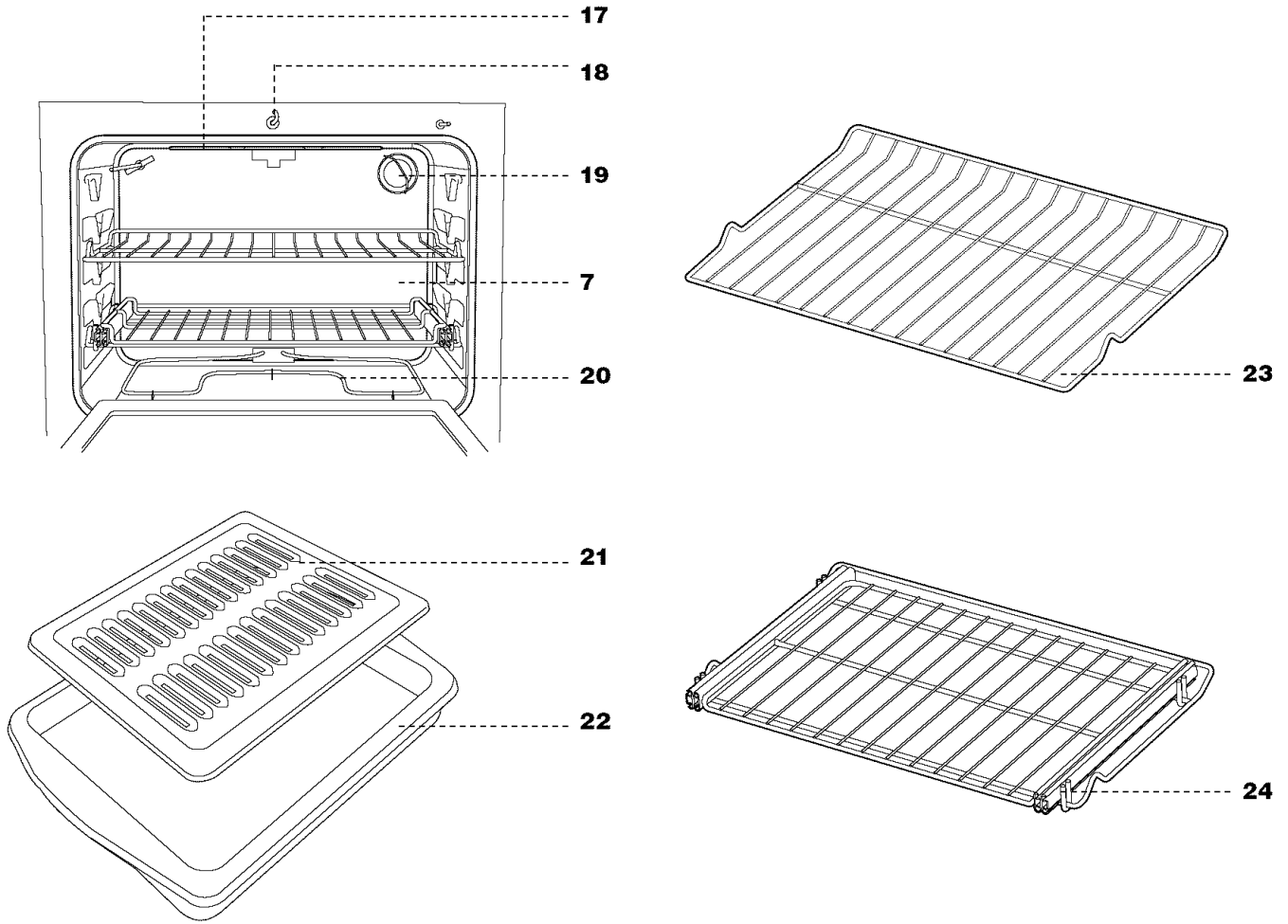

ADJUSTABLE HEIGHT BACKSPLASH

The range backsplash is adjustable so that you can customize it for your particular kitchen situation. The height can be adjusted from the low position (6-inches high) to the highest position (12-inches high) in one-inch increments. See Installation Instructions for directions (packed separately). The height of the backsplash should be adjusted before the unit is moved into place.

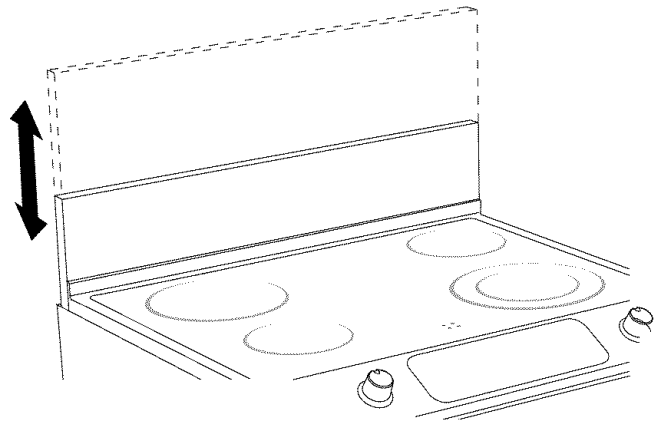

PARTS NAME

GLASS CERAMIC COOKTOP

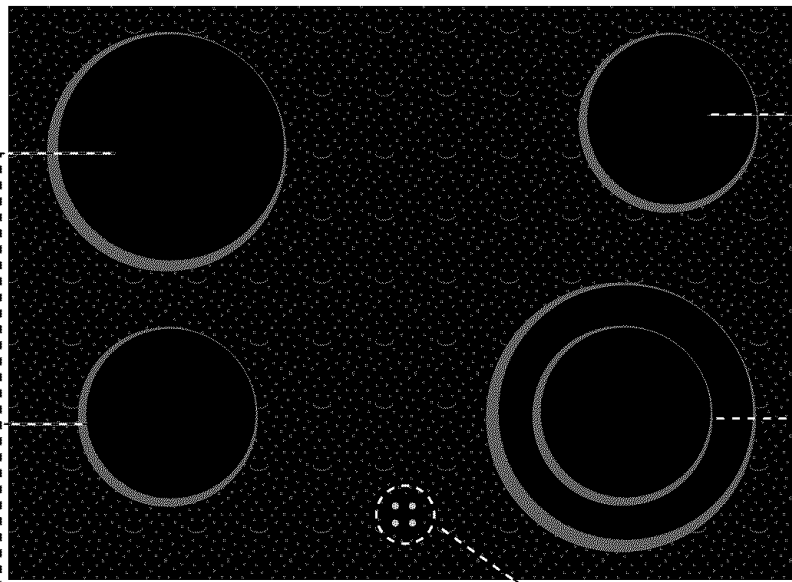

HOT SURFACE INDICATOR LIGHTS

CONTROL KNOBS

CONTROL KNOBS

CONTROL PANEL



13

13

13

13

OVEN

KEYSHEET

MICROWAVE

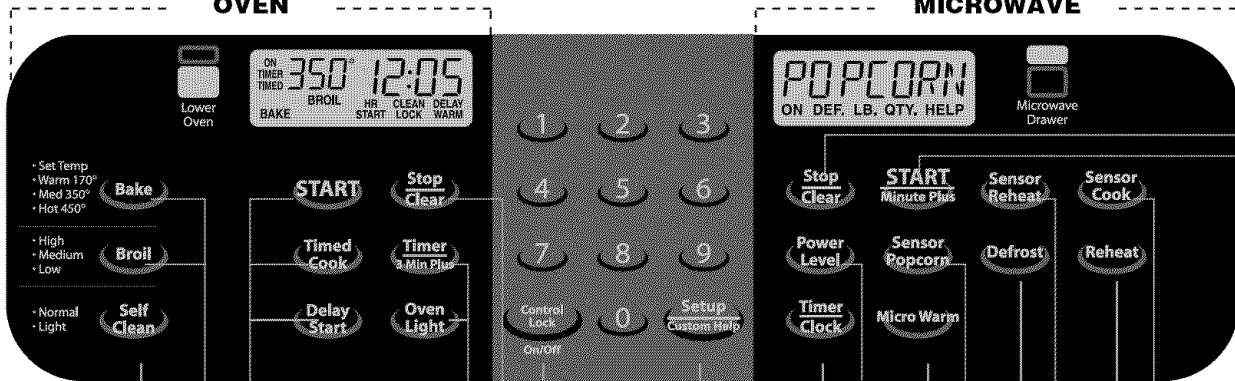

24

22

22

24

11

24

20,

24,

25

11,

19

19

17

18

17

19

17

11

20

Numbers next to the keysheet illustration indicate pages on which there are feature descriptions and usage information.

When you wish to use both the Microwave Drawer and the Oven, complete one setting and touch **START** before programming the other setting.

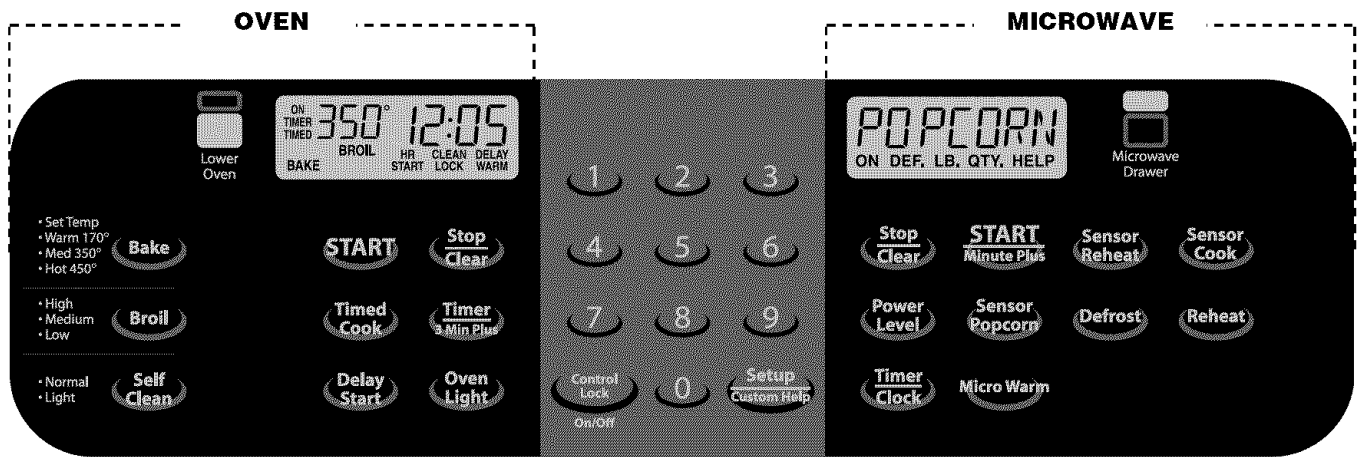

Before operating your new range make sure you read and understand this operation manual completely.

- Before the range can be used, follow these steps:

1 Plug in the range. The Microwave Drawer display will show **ENJOY YOUR RANGE TOUCH CLEAR AND TOUCH CLOCK**.

2 Touch the **STOP/CLEAR** pad. **:** will appear.

3 Set clock.

Note:

- Please do not open or close the lower oven door for 30 seconds after plugged in.

TO SET THE CLOCK

1 Touch **Timer/Clock** pad and number **2**.

2 Touch number pads for correct time of day and touch **Timer/Clock** pad again.

This is a 12 hour clock. If you attempt to enter an incorrect clock time, **ERROR** will appear in the display. Touch the **Stop/Clear** pad and re-enter the time.

- If the electrical power supply to your range should be interrupted, the display will intermittently show **ENJOY YOUR RANGE TOUCH CLEAR AND TOUCH CLOCK** after the power is reinstated. If this occurs during cooking, the program will be erased. The time of day will also be erased. Simply touch **Stop/Clear** pad and reset the clock for the correct time of day.

Note:

- The Microwave Drawer can be programmed with the drawer open except for **START/Minute Plus**. The Oven can be started with the door open except for self-cleaning.

TIMERS

Your Insight Range features two separate independent Kitchen Timers.

The timer on the Oven side (left) of the control panel is labeled **Timer/3 Min Plus**. The maximum length of this timer is 9 hours, 99 minutes. **You set this timer in hours and minutes.** For example, one hour 30 minutes is entered as 130. 1:30 will appear. For times over one hour, the time will count down in hours and minutes. When the timer reaches 60 minutes, the timer will begin counting down in minutes and seconds. **To cancel Timer/3 Min Plus, you must touch and hold the Timer/3 Min Plus pad for 3 seconds.**

The timer on the Microwave side (right) of the control panel is labeled **Timer/Clock**. The maximum length of this timer is 99 minutes, 99 seconds. **This timer is set in minutes and seconds.** It will always count down in minutes and seconds. To cancel this timer, simply touch **Stop/Clear**.

See page 19.

STOP/CLEAR

Touch the **Stop/Clear** pad to:

- 1** Erase if you make a mistake during programming.
- 2** Cancel timer on Microwave side.
- 3** Stop the Oven or Microwave Drawer temporarily during timed cooking.
- 4** Return the time of day to the display.
- 5** Cancel a program during cooking, touch twice for timed cooking.

COOKTOP USE

INFORMATION YOU NEED TO KNOW

ABOUT THE COOKTOP

- **Glass ceramic cooktop** - Make sure the surface and the pan bottom are clean before turning on. Do not use the cooktop if the glass is broken or if metal melts on it.
- **Radiant surface units** - The radiant surface heating units are beneath the smooth glass ceramic cooktop. The design on the cooktop outlines the area of the surface unit underneath. When the cooktop is on, the cooktop-on indicator, next to the surface cooking control knob, comes on even if the cooktop unit doesn't look red. The areas around the units may become hot enough to cause burns.
- **Hot surface indicator** - An indicator light, on the cooktop, comes on when the surface unit is turned on and the cooktop temperature increases. The indicator will remain on until the surface has cooled below 150°F even after the unit is turned off.
- **Temperature limiter** - The radiant surface units have a temperature limiter that allows the unit to cycle on and off, even at the HI setting. It protects the glass ceramic cooktop from damage. Cycling at the HI setting can occur when improper cookware is used.

Note:

- Never leave any items on the cooktop. Hot units may ignite flammable items, melt or soften plastics or increase pressure in closed containers causing them to burst.
- Don't store heavy items above the cooktop as they can cause damage if they drop on to the cooktop.
- Never cook directly on the cooktop. Always use cookware.

ABOUT COOKING UTENSILS

For best results and energy conservation, choose cooking utensils as below.

- **Bottom of pan**- Pans should have flat bottoms that make good contact with the entire surface unit. Check for flatness by using a straight edge. Pans with curved or warped bottoms are not recommended.
- **Size of pan** - Pan size should match the amount of food and the size of the surface unit. Do not use canners or frypans that exceed the width of the radiant surface units.
- **Material of pan** - Always use a utensil for its intended purpose. Follow manufacturer's instructions. Some utensils were not made to be used on the cooktop.
- **Position of pan** - Always place the pan in the center of the surface unit you are using.
- **Wok Cooking** - Only a flat-bottomed wok is recommended. Do not use round-bottom wok or a wok with a support ring.

Note:

- Do not slide cookware across the cooktop surface because it can scratch the glass or may leave marks which need to be removed promptly.
- Never allow a pan to boil dry. This could damage the pan and the countertop.
- Do not use aluminum foil on the cooktop surface.
- Do not use cooktop as a cutting board.

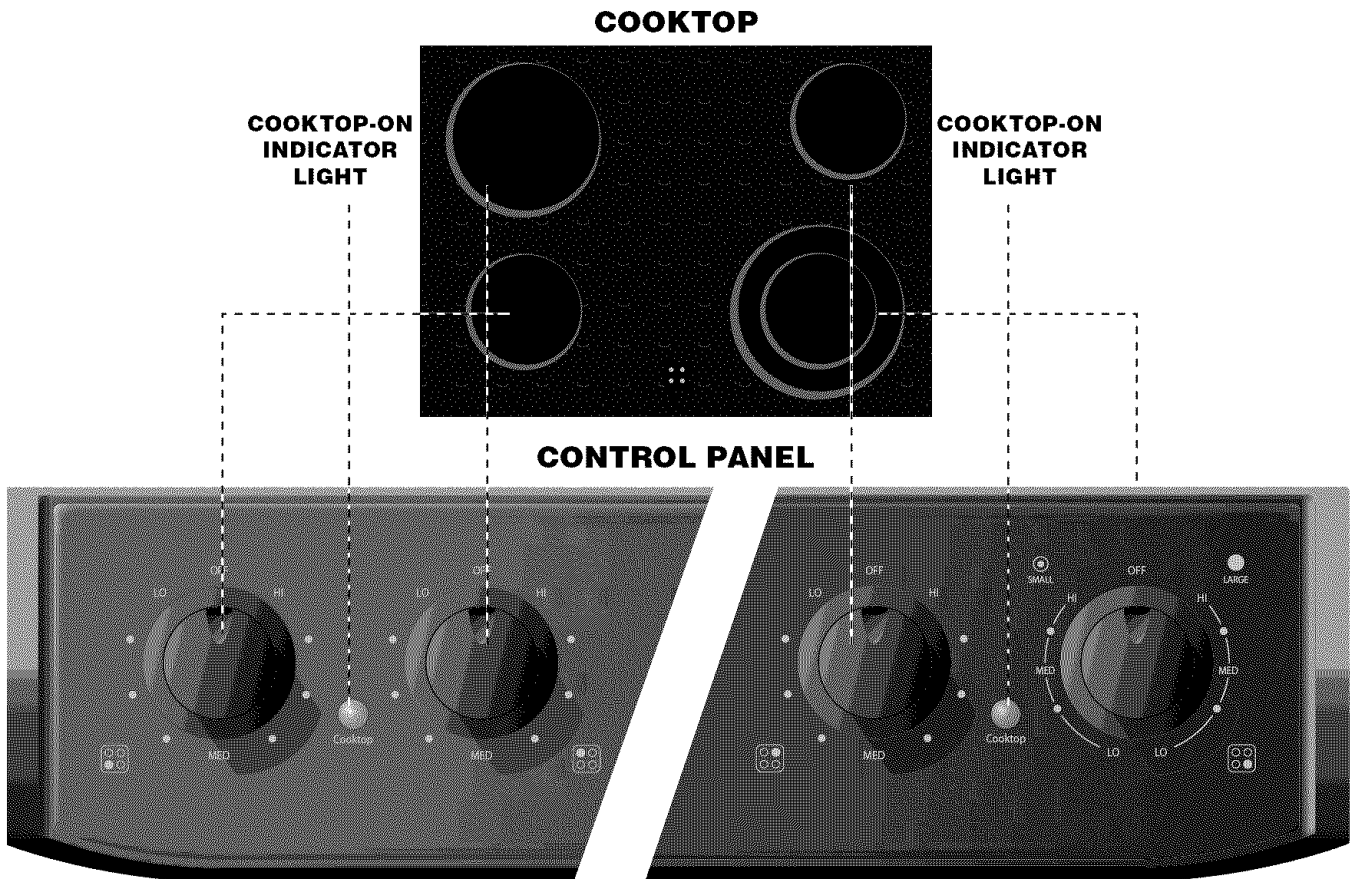

RADIANT SURFACE UNITS

Surface units are turned on and adjusted using the control knobs.

HOW TO SET SINGLE SURFACE UNIT

- 1** Place correctly sized cookware on the radiant surface unit.
- 2** Push the knob in and turn in either direction to the desired heat setting.
- 3** When cooking is completed, turn the knob to OFF. Remove pan.

HOW TO SET DUAL SURFACE UNIT

The right front surface unit has 2 cooking sizes so that you can choose either to match the diameter of the cookware you are using.

- 1** Place correct size cookware on the radiant surface unit.
- 2** To use the small surface unit, push the knob in and turn it to the left, counter clockwise.

To use the large surface unit, push the knob in and turn it to the right, clockwise.

- 3** When cooking is completed, turn the knob to OFF. Remove pan.

Note for surface unit: A hot surface indicator light in the center of the cooktop, will glow when a radiant unit is turned on. It will remain on until the surface is cooled to about

150°F. Be sure the knob is turned to OFF when you have finished cooking.

The glass ceramic cooktop retains heat after the radiant surface units have been turned to OFF. If possible, turn the units off and allow foods to finish cooking with the retained heat. It may be necessary to remove the pan from the unit to prevent further cooking, also.

SUGGESTED HEAT SETTINGS

Setting	Type of cooking
High	Bring liquid to a boil. Always reduce setting to a lower heat when liquids begin to boil or foods begin to cook.
Medium High	Brown meat, heat oil for deep fat frying or to continue a rapid boil.
Medium	Maintain a slow boil, thicken sauces and gravies
Medium Low	Continue cooking covered foods or steam foods.
Low	Melt or simmer.

Note: The size and type of cookware used will influence the setting needed.

MICROWAVE DRAWER COOKING

INFORMATION YOU NEED TO KNOW

ALWAYS have food in the Microwave Drawer when it is on to absorb the microwave energy.

When using the Microwave Drawer at power levels below 100%, you may hear the magnetron cycling on and off. It is normal for the exterior of the Microwave Drawer to be warm to the touch when cooking or reheating.

Condensation is a normal part of microwave cooking. Room humidity and the moisture in food will influence the amount of moisture that condenses in the Microwave Drawer. Generally, covered foods will not cause as much condensation as uncovered ones. Vents between Microwave Drawer and oven must not be blocked.

The Microwave Drawer is for food preparation only. It should not be used to dry clothes or newspapers.

Your Microwave Drawer is rated 1000 watts by using the IEC Test Procedure. In using recipes or package directions, check food a minute or two before the minimum time and add time accordingly.

When opening or closing the Microwave Drawer quickly, food in the Microwave Drawer may be spilled. To clean, please refer to the Cleaning and Care section on page 27.

RADIO OR TV INTERFERENCE

Should there be any interference caused by the Microwave Drawer to your radio or TV, relocate the radio or TV as far away from the range as feasible or check position and signal of receiving antenna.

ABOUT MICROWAVE COOKING

- Arrange food carefully. Place thickest areas towards outside of dish.
- Watch cooking time. Cook for the shortest amount of time indicated and add more as needed. Food severely overcooked can smoke or ignite.
- Cover foods while cooking. Check recipe or cookbook for suggestions: paper towels, wax paper, microwave plastic wrap or a lid. Covers prevent spattering and help foods to cook evenly.
- Shield with small flat pieces of aluminum foil any thin areas of meat or poultry to prevent overcooking before dense, thick areas are cooked thoroughly.
- Stir foods from outside to center of dish once or twice during cooking, if possible.
- Turn foods over once during microwaving to speed cooking of such foods as chicken and hamburgers. Large items like roasts must be turned over at least once.
- Rearrange foods such as meatballs halfway through cooking both from top to bottom and from right to left.
- Add standing time. Remove food from Microwave Drawer and stir, if possible. Cover for standing time which allows the food to finish cooking without overcooking.

- Check for doneness. Look for signs indicating that cooking temperatures have been reached.

Doneness signs include:

- Food steams throughout, not just at edge.
- Center bottom of dish is very hot to the touch.
- Poultry thigh joints move easily.
- Meat and poultry show no pinkness.
- Fish is opaque and flakes easily with a fork.

ABOUT UTENSILS AND COVERINGS

It is not necessary to buy all new cookware. Many pieces already in your kitchen can be used successfully in your new Microwave Drawer. Make sure the utensil does not touch the interior walls during cooking.

Use these utensils for safe microwave cooking and reheating:

- glass ceramic (Pyroceram[®]), such as Corningware[®].
- heat-resistant glass (Pyrex[®])
- microwave-safe plastics
- microwave-safe paper plates
- microwave-safe pottery, stoneware and porcelain
- browning dish (Do not exceed recommended preheating time. Follow manufacturer's directions.)

These items can be used for short time reheating of foods that have little fat or sugar in them:

- wood, straw, wicker

DO NOT USE

- metal pans and bakeware
- dishes with metallic trim
- non-heat-resistant glass
- non-microwave-safe plastics (margarine tubs)
- recycled paper products
- brown paper bags
- food storage bags
- metal twist-ties

Should you wish to check if a dish is safe for microwaving, place the empty dish in the oven and microwave on HIGH for 30 seconds. A dish which becomes very hot should not be used.

The following coverings are ideal:

- Paper towels are good for covering foods for reheating and absorbing fat while cooking bacon.
- Wax paper can be used for cooking and reheating.
- Plastic wrap that is specially marked for microwave use can be used for cooking and reheating. **DO NOT** allow plastic wrap to touch food. Vent so steam can escape.
- Lids that are microwave-safe are a good choice because heat is kept near the food to hasten cooking.
- Oven cooking bags are good for large meats or foods that

MICROWAVE DRAWER COOKING

need tenderizing. DO NOT use metal twist ties. Remember to slit bag so steam can escape.

How to use aluminum foil in your Microwave Drawer:

- Small flat pieces of aluminum foil placed smoothly on the food can be used to shield areas that are either defrosting or cooking too quickly.
- Foil should not come closer than one inch to any surface of the Microwave Drawer.

Should you have questions about utensils or coverings, check a good microwave cookbook or follow recipe suggestions.

ACCESSORIES There are many microwave accessories available for purchase. Evaluate carefully before you purchase so that they meet your needs. A microwave-safe thermometer will assist you in determining correct doneness and assure you that foods have been cooked to safe temperatures. Sharp is not responsible for any damage to the Microwave Drawer when accessories are used.

ABOUT CHILDREN AND THE MICROWAVE

Children below the age of 7 should use the Microwave Drawer with a supervising person very near to them. Between the ages of 7 and 12, the supervising person should be in the same room.

The child must be able to reach the Microwave Drawer comfortably.

At no time should anyone be allowed to lean or swing on the Microwave Drawer.

Children should be taught all safety precautions: use potholders, remove coverings carefully, pay special attention to packages that crisp food because they may be extra hot.

Don't assume that because a child has mastered one cooking skill he/she can cook everything.

Children need to learn that the Microwave Drawer is not a toy. See page 25 for Control Lock feature.

ABOUT SAFETY

- Check foods to see that they are cooked to the United States Department of Agriculture's recommended temperatures.

160°F - For fresh pork, ground meat, boneless white poultry, fish, seafood, egg dishes and frozen prepared food.

165°F - For leftover, ready-to-reheat refrigerated, and deli and carry-out "fresh" food.

170°F - White meat of poultry.

180°F - Dark meat of poultry.

To test for doneness, insert a meat thermometer in a thick or dense area away from fat or bone. NEVER leave the thermometer in the food during cooking, unless it is approved for microwave use.

- ALWAYS use potholders to prevent burns when handling utensils that are in contact with hot food. Enough heat from the food can transfer through utensils to cause skin burns.

- Avoid steam burns by directing steam away from the face and hands. Slowly lift the farthest edge of a dish's covering and carefully open popcorn and oven cooking bags away from the face.

- Stay near the Microwave Drawer while it's in use and check cooking progress frequently so that there is no chance of overcooking food.

- NEVER use the Microwave Drawer for storing cookbooks or other items.

- Select, store and handle food carefully to preserve its high quality and minimize the spread of foodborne bacteria.

- Keep waveguide cover clean. Food residue can cause arcing and/or fires. See page 27.

ABOUT FOODS

FOOD	DO	DON'T
Eggs, sausages, fruits & vegetables	<ul style="list-style-type: none"> • Puncture egg yolks before cooking to prevent "explosion". • Pierce skins of potatoes, apples, squash, hot dogs and sausages so that steam escapes. 	<ul style="list-style-type: none"> • Cook eggs in shells. • Reheat whole eggs. • Dry nuts or seeds in shells.
Popcorn	<ul style="list-style-type: none"> • Use specially bagged popcorn for the microwave. • Listen while popping corn for the popping to slow to 1 or 2 seconds or use special Sensor Popcorn pad. 	<ul style="list-style-type: none"> • Pop popcorn in regular brown bags or glass bowls. • Exceed maximum time on popcorn package.
Baby food	<ul style="list-style-type: none"> • Transfer baby food to small dish and heat carefully, stirring often. Check temperature before serving. • Put nipples on bottles after heating and shake thoroughly. "Wrist" test before feeding. 	<ul style="list-style-type: none"> • Heat disposable bottles. • Heat bottles with nipples on. • Heat baby food in original jars.
General	<ul style="list-style-type: none"> • Cut baked goods with filling after heating to release steam and avoid burns. • Stir liquids briskly before and after heating to avoid "eruption". • Use deep bowl, when cooking liquids or cereals, to prevent boilovers. • Food should be shorter than the Microwave Drawer. Please refer to the height of side walls of the drawer. 	<ul style="list-style-type: none"> • Heat or cook in closed glass jars or airtight containers. • Can in the microwave as harmful bacteria may not be destroyed. • Deep fat fry. • Drywood, gourds, herbs or wet papers.

MICROWAVE DRAWER COOKING



TIME COOKING

Your Microwave Drawer can be programmed for 99 minutes 99 seconds (99.99). Always enter the seconds after the minutes, even if they are both zeros.

- Suppose you want to cook for 5 minutes at 100%.

1 Enter cooking time **5 0 0**. **5.00** TOUCH
START **OR** **TOUCH** **POWER** **LEVEL**

2 To cook at 100% power (High), touch **START/Minute Plus** pad.

TO SET POWER LEVEL

There are eleven preset power levels.

Using lower power levels increases the cooking time, which is recommended for foods such as cheese, milk and long slow cooking of meats. Consult a microwave cookbook or recipes for specific recommendations.

TOUCH POWER LEVEL PAD NUMBER OF TIMES FOR DESIRED POWER	APPROXIMATE PERCENTAGE OF POWER	COMMON WORDS FOR POWER LEVELS
Power Level x 1	100%	High
Power Level x 2	90%	
Power Level x 3	80%	
Power Level x 4	70%	Medium High
Power Level x 5	60%	
Power Level x 6	50%	Medium
Power Level x 7	40%	
Power Level x 8	30%	Med Low/Defrost
Power Level x 9	20%	
Power Level x 10	10%	Low
Power Level x 11	0%	

- Suppose you want to defrost for 5 minutes at 30%.

1 Enter defrost time **5 0 0**. **5.00**

2 Touch **POWER LEVEL** pad 8 times.

3 Touch **START/Minute Plus** pad.

SENSOR SETTINGS

Sharp's Sensor is a semi-conductor device that detects the vapor (moisture and humidity) emitted from the food as it heats. The sensor adjusts the cooking times and power levels for various foods and quantities.

USING SENSOR SETTINGS:

- 1 After the range is plugged in, wait 2 minutes before using any sensor setting.
- 2 Be sure the exterior of the cooking container and the interior of the Microwave Drawer are dry. Wipe off any moisture with a dry cloth or paper towel.
- 3 The sensor works with foods at normal storage temperature. For example, popcorn would be at room temperature.
- 4 Any sensor selection can be programmed with More or Less Time Adjustment. See page 20.
- 5 More or less food than the quantity listed in the charts should be cooked following the guidelines in any microwave cookbook.
- 6 During the first part of sensor use, the food name will appear on the display. Do not open the Microwave Drawer or touch **Stop/Clear** during this part of the cycle. The measurement of vapor will be interrupted. If this occurs, an error message will appear. To continue cooking, touch the **Stop/Clear** pad and cook manually.

When the sensor detects the vapor emitted from the food, the remainder of cooking/reheating time will appear. The Microwave Drawer may be opened when the remaining time appears on the display. At this time, you may stir or season food, as desired.

- 7 If the sensor does not detect vapor properly when popping popcorn, the oven will turn off, and the time of day will be displayed. If the sensor does not detect vapor properly when cooking other foods, **ERROR** will be displayed, and the microwave will turn off.
- 8 Check food temperature after cooking. If additional time is needed, continue to cook manually.
- 9 Each food has a cooking hint. Touch the **Custom Help** pad when the **HELP** indicator is lighted in the display.

MICROWAVE DRAWER COOKING

COVERING FOODS:

Some foods work best when covered. Use the cover recommended in the charts for these foods. You may refer to the hints by touching the **Custom Help** pad. See page 20.

- 1 Casserole lid.
- 2 Plastic wrap: Use plastic wrap recommended for microwave cooking. Cover dish loosely; allow approximately 1/2 inch to remain uncovered to allow steam to escape. Plastic wrap should not touch food.
- 3 Wax paper: Cover dish completely; fold excess wrap under dish to secure. If dish is wider than paper, overlap two pieces at least one inch to cover.

Be careful when removing any covering to allow steam to escape away from you.

SENSOR POPCORN / SENSOR REHEAT

You can pop popcorn and reheat many foods and don't need to calculate cooking time or power level.

Touch **Sensor Reheat** or **Sensor Popcorn** and **START/Minute Plus** pad.

When the sensor detects the vapor emitted from the food, the remainder of cooking/reheating time will appear.

Note:

- The Sensor Popcorn setting has 2 choices. Follow directions in the display to choose desired option.

SENSOR POPCORN / SENSOR REHEAT CHART

FOOD	AMOUNT	PROCEDURE
Sensor Popcorn	Only 1 package at a time	Use only popcorn packaged for the microwave. Try several brands to decide which you like. Do not try to pop unpopped kernels.
	2.85 - 3.5 oz. (Regular / Regular light)	Touch Sensor Popcorn pad once.
	1.2 - 1.75 oz. (Mini / Snack)	Touch Sensor Popcorn pad twice.
Sensor Reheat	4 - 36 oz.	Place in dish or casserole slightly larger than amount to be reheated. Flatten, if possible. Cover with lid, plastic wrap or wax paper. Use covers such as plastic wrap or lids with larger quantities of more dense foods such as stews. After reheating, stir well, if possible. Re-cover and allow to stand 2 to 3 minutes. Foods should be very hot. If not, continue to heat with variable power and time.

SENSOR COOKING

1 Touch **Sensor Cook** pad once.

2 See Menu Label. Select desired food by touching number pad. Ex: Touch for baked potatoes.

3 Touch **START/Minute Plus** pad.

Note:

- To heat or cook other foods or foods above or below the quantity allowed on the SENSOR COOK CHART, cook manually.

SENSOR COOK CHART

FOOD	AMOUNT	PROCEDURE
1 Fresh vegetables: soft		Wash and place in casserole. Add no water if vegetables have just been washed.
Broccoli	.25 - 2.0 lb.	Cover with lid for tender vegetables. Use plastic wrap for tender-crisp vegetables.
Brussels sprouts	.25 - 2.0 lb.	After cooking, stir, if possible. Let stand, covered, for 2 to 5 minutes.
Cabbage	.25 - 2.0 lb.	
Cauliflower (flowerets)	.25 - 2.0 lb.	
Cauliflower (whole)	1 med.	
Spinach	.25 - 1.0 lb.	
Zucchini	.25 - 2.0 lb.	
Baked apples	2 - 4 med.	
2 Fresh vegetables: hard		Place in casserole. Add 1 - 4 tablespoons water. Cover with lid for tender vegetables.
Carrots, sliced	.25 - 1.5 lb.	Use plastic wrap cover for tender-crisp vegetables. After cooking, stir, if possible.
Corn on the cob	2 - 4	Let stand, covered, for 2 to 5 minutes.
Green beans	.25 - 1.5 lb.	
Winter squash:		
diced	.25 - 1.5 lb.	
halves	1 - 2	

MICROWAVE DRAWER COOKING

SENSOR COOK CHART (CONT.)

FOOD	AMOUNT	PROCEDURE															
3 Frozen vegetables	.25 - 1.25 lb.	Add no water. Cover with lid or plastic wrap. After cooking, stir and let stand, covered, for 3 minutes.															
4 Frozen entrees	6 - 17 oz.	Use this pad for frozen convenience foods. It will give satisfactory results for most brands. You may wish to try several and choose your favorite. Remove package from outer wrapping and follow package directions for covering. After cooking, let stand, covered, for 1-3 minutes															
5 Baked potatoes	1 - 6 med.	Pierce. Place on paper-towel-lined Microwave Drawer. After cooking, remove from microwave, wrap in aluminum foil and let stand 5 to 10 minutes.															
6 Ground meat	.25 - 2.0 lb.	Use this setting to cook ground beef or turkey as patties or in a casserole to be added to other ingredients. Place patties on a microwave-safe rack and cover with wax paper. Place ground meat in a casserole and cover with wax paper or plastic wrap. When microwave stops, turn patties over or stir meat in casserole to break up large pieces. Re-cover and touch START/Minute Plus . After cooking, let stand, covered, for 2 to 3 minutes.															
7 Fish/seafood	.25 - 2.0 lb.	Arrange in ring around shallow glass dish (roll fillet with edges underneath). Cover with vented plastic wrap. After cooking, let stand, covered for 3 minutes.															
8 Rice	.5 - 2.0 cups	Place rice into a deep casserole and add double quantity of water. Cover with lid or plastic wrap. After cooking, stir, cover and let stand 3 to 5 minutes or until all liquid has been absorbed.															
		<table border="0"> <thead> <tr> <th>Rice</th> <th>Water</th> <th>Size of casserole</th> </tr> </thead> <tbody> <tr> <td>.5 cup</td> <td>1 cup</td> <td>1.5 quart</td> </tr> <tr> <td>1 cup</td> <td>2 cups.....</td> <td>2 quart</td> </tr> <tr> <td>1.5 cups.....</td> <td>3 cups.....</td> <td>2.5 or 3 quart</td> </tr> <tr> <td>2 cups.....</td> <td>4 cups.....</td> <td>3 quart or larger</td> </tr> </tbody> </table>	Rice	Water	Size of casserole	.5 cup	1 cup	1.5 quart	1 cup	2 cups.....	2 quart	1.5 cups.....	3 cups.....	2.5 or 3 quart	2 cups.....	4 cups.....	3 quart or larger
Rice	Water	Size of casserole															
.5 cup	1 cup	1.5 quart															
1 cup	2 cups.....	2 quart															
1.5 cups.....	3 cups.....	2.5 or 3 quart															
2 cups.....	4 cups.....	3 quart or larger															

DEFROST

Use this feature to defrost the foods shown in the DEFROST CHART below.

1 Touch **Defrost** pad.

SEE LABEL SELECT FOOD NUMBER

2 See Menu Label. Select desired food by touching the number pad. Ex: Touch **2** for steaks/chops.

STEAKS CHOPS ENTER WEIGHT

3 Enter weight by touching number pads. 1.0

4 Touch **START/Minute Plus** pad.

The oven will stop so that the food can be checked.

5 After the first stage, open the Microwave Drawer. Turn steak over and shield any warm portions. Close the Microwave Drawer. Touch **START/Minute Plus** pad.

6 After the second stage, open the Microwave Drawer. Shield

any warm portions. Close the Microwave Drawer. Touch **START/Minute Plus** pad.

7 After defrost cycle ends, cover and let stand as indicated in the chart below.

Note:

- Defrost can be programmed with More or Less Time Adjustment. See page 20.
- To defrost other foods or foods above or below the weights allowed on the DEFROST CHART, see MANUAL DEFROST on next page.
- Check foods when oven signals. After final stage, small sections may still be icy. Let stand to continue thawing. Do not defrost until all ice crystals are thawed.
- Shielding prevents cooking from occurring before the center of the food is defrosted. Use small smooth strips of aluminum foil to cover edges and thinner sections of the food.

DEFROST CHART

FOOD	AMOUNT	PROCEDURE
1 Ground meat	.5 - 2.0 lb.	Remove any thawed pieces after each audible signal. Let stand, covered, for 5 to 10 minutes.
2 Steaks/chops	.5 - 3.0 lb.	After each audible signal, rearrange and if there are warm or thawed portions, shield with small flat pieces of aluminum foil. Remove any meat or fish that is almost defrosted. Let stand, covered, for 10 to 20 minutes.
3 Boneless poultry	.5 - 2.0 lb.	After each audible signal, if there are warm or thawed portions, rearrange or remove. Let stand, covered, for 10 to 20 minutes.
4 Bone-in poultry	.5 - 3.0 lb.	After each audible signal, rearrange pieces or remove portions should they become warm or thawed. Let stand, covered, for 10 to 20 minutes.
5 Casserole/soup	1 - 6 cups	After each audible signal, break apart and remove any defrosted part. At end, stir well and let stand, covered, for 5 to 10 minutes.

MICROWAVE DRAWER COOKING

MANUAL DEFROST

If the food that you wish to defrost is not listed on the DEFROST CHART or is above or below the limits in the AMOUNT column on the DEFROST CHART on the previous page, you need to defrost manually.

You can defrost any frozen food, either raw or previously cooked, by using Power Level at 30%. Follow the exact 3-step procedure found under TO SET POWER LEVEL on page 16. Estimate defrosting time and press **Power Level** pad eight times for 30% power.

For either raw or previously cooked frozen food the rule of thumb is approximately 4 minutes per pound. For example, defrost 4 minutes for 1 pound of frozen spaghetti sauce.

Always stop the oven periodically to remove or separate the portions that are defrosted. If food is not defrosted at the end of the estimated defrosting time, program the oven in 1 minute increments on Power Level 30% until totally defrosted.

When using plastic containers from the freezer, defrost only long enough to remove from the plastic in order to place in a microwave-safe dish.

REHEAT CHART

FOOD	AMOUNT	PROCEDURE
1 Fresh rolls/muffins	1 - 8 pcs	Use this pad to warm rolls, muffins, biscuits, bagels etc. Large items should be considered as 2 or 3 regular size. Arrange on plate; cover with paper towel. For refrigerated rolls or muffins, it may be necessary to double the entered amount to ensure the proper serving temperature. For example, enter quantity of 2 for 1 refrigerated muffin.
2 Frozen rolls/muffins	1 - 8 pcs	Use this pad to warm frozen rolls, muffins, biscuits, bagels etc. Large items should be considered as 2 or 3 regular size. Arrange on plate; cover with paper towel.
3 Beverage	.5 - 2.0 cups	This setting is good for restoring cooled beverage to a better drinking temperature. Stir liquid briskly before and after heating to avoid "eruption".

MICRO WARM

Micro Warm allows you to keep food warm up to 30 minutes.

DIRECT USE

1 Touch **Micro Warm** pad.

2 Enter desired time by touching the number pads. To enter 30 minutes, touch .

3 Touch **START/Minute Plus** pad.

The oven will start. The display will show and count down. will be displayed intermittently during the count down.

WITH MANUAL COOKING

1 Enter desired cooking time and power level.

2 Touch **Micro Warm** pad.

3 Enter desired warming time up to 30 minutes.

REHEAT

Reheat automatically computes the correct warming time and microwave power level for foods shown in the chart below.

1 Touch **Reheat** pad once.

2 See Menu Label. Select desired food by touching number pad. Ex: Touch for frozen rolls or muffins.

3 Touch the number pad to select quantity. Ex: Touch for 2 rolls or muffins.

4 Touch **START/Minute Plus** pad.

Note:

- Reheat can be programmed with More or Less Time Adjustment. See page 20.
- To reheat other foods or foods above or below the quantity allowed on the REHEAT CHART, heat manually.

4 Touch **START/Minute Plus** pad.

The operation will start. When the cooking time is complete, a long tone will sound and Micro Warm will start. The display will count down. will be displayed intermittently during the count down.

Note:

- If you attempt to enter more than 30 minutes for Micro Warm, an error message will appear in the display.
- Micro Warm cannot be programmed with Sensor Popcorn, Sensor Reheat, Sensor Cook, Defrost or Reheat.

TIMER

See page 11.

1 Touch **Timer/Clock** pad and number .

2 Enter time.

3 Touch **Timer/Clock** pad again.

To cancel timer, touch **STOP/Clear**.

MICROWAVE DRAWER COOKING

MULTIPLE SEQUENCE COOKING

Your Microwave Drawer can be programmed for up to 4 automatic cooking sequences, switching from one power level setting to another automatically.

Sometimes cooking directions tell you to start on one power level and then change to a different power level. Your Microwave Drawer can do this automatically.

1 First enter cooking time. Then touch **Power Level** pad once for 100% cooking or repeat touching **Power Level** pad for a lower power level.

2 Enter second cooking time. Repeat touching **Power Level** pad for desired level. You can follow this procedure up to 4 times. TOUCH START

3 Touch **START/Minute Plus** pad.

Note:

- If **Power Level** pad is touched once, HIGH will be displayed.
- If 100% is selected as the final sequence, it is not necessary to touch the **Power Level** pad.
- If you wish to know power level during cooking, simply touch the **Power Level** pad. As long as your finger is touching the **Power Level** pad, the power level will be displayed.
- Micro Warm can be programmed even if 4 cooking sequences have been set.

HELP

Each setting of Sensor Reheat, Sensor Cook, Sensor Popcorn, Micro Warm, Reheat and Defrost has a cooking hint. If you wish to check, touch **Custom Help** whenever HELP is lighted in the Interactive Display for these and other manual operation hints.

MINUTE PLUS™

Minute Plus allows you to cook for a minute at 100% by simply touching the **Minute Plus** pad. You can also extend cooking time in multiples of 1 minute by repeatedly touching the **Minute Plus** pad during manual cooking.

Note:

- To use **Minute Plus**, touch pad within 3 minutes after cooking, closing the door or touching the **Stop/Clear** pad.
- **Minute Plus** cannot be used with Sensor settings, Reheat or Defrost.

MORE OR LESS TIME ADJUSTMENT

Should you discover that you like any of the Sensor, Reheat or Defrost settings slightly more done, touch the **Power Level** pad once after touching your selection. The display will show MORE.

For slightly less done, touch the **Power Level** pad twice after touching your selection. The display will show LESS.

AUTO START

If you wish to program the Microwave Drawer to begin cooking automatically at a designated time of day, follow this procedure.

1 Touch **Setup/Custom Help** pad 4 times. The display shows

AUTO START MICRO TOUCH START

2 Touch **START/Minute Plus** pad.

ENTER START TIME

3 Enter start time. 4:30 TOUCH CLOCK

4 Touch **Timer/Clock** pad. ENTER COOKING TIME

5 Touch the number pads to enter cooking time. 20.00

TOUCH START OR TOUCH POWER LEVEL

Touch **Power Level** pad repeatedly until the desired power level is reached. TOUCH START

6 Touch **START/Minute Plus** pad.

AUDIBLE SIGNAL ELIMINATION

If you wish to have the Microwave Drawer operate with no audible signals, see page 25.

END OF COOKING REMINDER

At end of cooking, the Microwave Drawer will signal every 10 seconds for the first minute; then every 3 minutes until the **Stop/Clear** pad is touched, the Microwave Drawer is opened or up to 1 hour. This can be canceled. See page 25.

INFORMATION YOU NEED TO KNOW

- Be sure all packing material is removed from oven before turning on.
- **Oven vent location** - The oven vent is located at the right side of the front panel between the Microwave Drawer and oven. This area could become hot during oven use. It is normal for steam to come out of the vent. The vent is important for proper air circulation in the oven and good baking results. Never block this vent.
- Do not use oven for storing food or cookware.

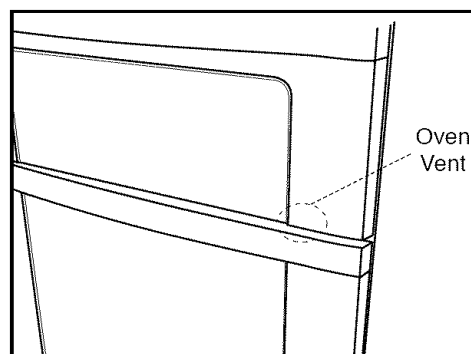

BEFORE USING OVEN

REMOVING AND REPLACING OVEN RACKS

The standard rack has stops so that when placed correctly on the supports it will stop before coming completely out and will not tilt.

To remove, pull the rack forward until it stops. Lift front of rack up and slide out.

To replace, fit the rack onto the guides on the oven walls. Tilt the front of the rack upward and slide the rack back into place.

Directions for removing and replacing the EZ Pull rack are packed with it. Read instructions completely and save.

AIR CIRCULATION IN THE OVEN

Baking results will be better if baking pans are centered in the oven as much as possible. If baking four cake layers at the same time, place two layers on rack #1 and two layers on rack #3. Stagger pans on the rack so one is not directly above the other. For best air circulation and baking results allow 2-4 inches around the cookware and be sure pans and cookware do not touch each other, the oven door, sides or back of the oven cavity. The hot air must circulate around the pans and cookware in the oven for even heat to reach around the food.

ALUMINUM FOIL

Do not place aluminum foil on the oven bottom. It is not recommended to use aluminum foil to line the broiler pan and broiler grid. If you would like to use it to make cleaning easier, you must mold the foil tightly to the grid and cut slits in it just like the grid. Without the slits, the foil will prevent fat and meat juices from draining into the broiler pan, and then the juices could become hot enough to catch on fire.

RECOMMENDED RACK POSITION

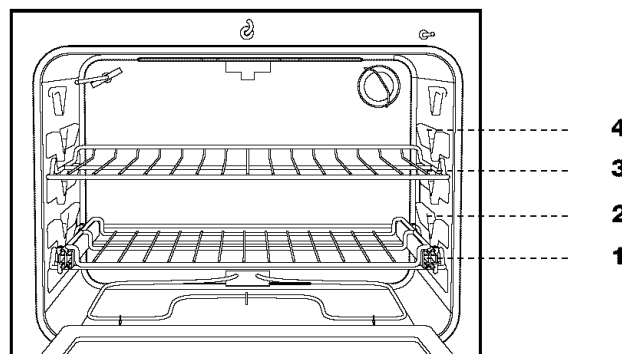

FOOD	RACK POSITION
Toasting bread	4
Broiling meats, chicken or fish	2 or 3
Baking cookies, cakes, pies, biscuits or muffins	2 or 3
Baking frozen pies, angel food cake, yeast bread or casseroles	1
Roasting poultry	1
Roasting meats	1
Baking on 2 racks at the same time	1 and 3

Note:

- Follow package instructions and recipe times. The cooking times and temperatures needed to bake a product may vary slightly from your previously owned appliance.

OVEN COOKING

HOW TO SET OVEN TEMPERATURE

SET TEMP

- 1 Touch **Bake** pad.
- 2 Touch the number pads to set the desired oven temperature between 90°F and 550°F. For example:
- 3 Touch **START** pad.

When the oven reaches the programmed temperature, a signal will sound.

TO CHANGE SET TEMPERATURE DURING PREHEATING:

- 1 Touch **Bake** pad twice.
- 2 Enter the new temperature using the number pads.
- 3 Touch **START** pad.

TO CHANGE SET TEMPERATURE AFTER OVEN IS PREHEATED:

- 1 Touch **Bake** pad.
- 2 Enter the new temperature using the number pads.
- 3 Touch **START** pad.

QUICK SET TEMP

You can quickly set the oven for warm (170°), medium (350°) or hot (450°) by touching the **Bake** pad repeatedly.

To Quick Set the oven to a moderate 350° F:

- 1 Touch **Bake** pad.
- 2 Touch **Bake** pad two more times for 350°F.
- 3 Touch **START** pad.

When the oven reaches the programmed temperature, a signal will sound.

HOW TO PROOF

The oven can be set from 90-100°F for proofing bread dough. If you have just finished using the oven and the residual temperature is 105°F or higher, when you enter 90-100°F and touch the **START** pad, the oven will display TOO HOT. The oven will not start until it cools below 105°F, a safe temperature for yeast. When the oven cools, the oven display will change to . Simply touch the **START** pad and the oven will maintain 90-100°F for proofing.

HOW TO SET TIMED COOK

The oven will turn on immediately and cook for a selected length of time. At the end of the cooking time the oven will turn off automatically.

BAKE

- 1 Touch **Bake** pad.

2 Touch the number pads to set the desired oven temperature.

3 Touch **Timed Cook** pad.

4 Touch the number pads to enter cooking time in hours and minutes. For example, 1 hour 45 minutes:

5 Touch **START** pad.

Cooking time begins counting down. When the oven preheats to the programmed temperature, a signal will sound. When cooking time is completed, a signal will sound and will appear in the display. Oven will turn off.

Note:

- The oven will cook for the set amount of time, then turn off automatically. The oven will remain hot even though the oven has turned off, so remove food promptly to avoid overcooking.

HOW TO SET DELAY START

The oven will turn on at the time of day you set, cook for a specific length of time and then turn off automatically.

Make sure the clock on the right-hand display shows the correct time of day. To set correct time, see page 11.

Foods that spoil easily such as dairy products, pork, poultry or seafood are not recommended for delay start cooking.

BAKE

1 Touch **Bake** pad.

2 Touch the number pads to set the desired oven temperature.

3 Touch **Delay Start** pad.

4 Touch the number pads to set the time for cooking to begin.

5 Touch **Timed Cook** pad.

6 Touch the number pads to enter cooking time in hours and minutes.

7 Touch **START** pad.

Note:

- The oven will cook for the set amount of time, then turn off automatically.
- If your recipe requires preheating, you may need to add additional cooking time.
- Baked items that require a preheated oven, such as cakes, cookies and breads, are not recommended to be cooked with the delay start feature.

HOW TO SET BROIL

Leave the door open to the broil stop position. Place the food on the broiler grid in the broiler pan.

Follow suggested rack positions in the BROILING GUIDE. Preheating is suggested for rare steaks. To preheat, touch **Broil** and wait 2 to 3 minutes before putting broiler pan with food into the oven.

OVEN COOKING

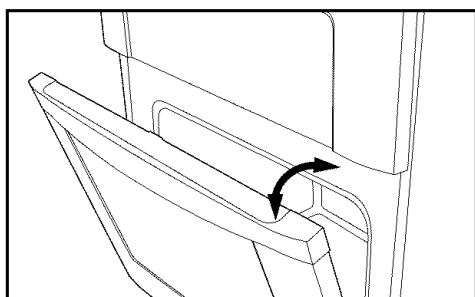

Use the following table for approximate broiling times. Increase or decrease broiling times or move the broiling pan to a different rack position to suit for doneness.

High broil is used for most broiling. Use Medium or Low broil to cook foods such as thick cuts of meat thoroughly without excessive browning.

Broil will automatically turn off after 5 hours if it was accidentally left on. This feature can be cancelled. See 12 HOUR SHUT OFF on page 25.

TO BROIL

1 Touch **Broil** pad.

2 Touch **START** pad.

Touch **Broil** pad once for High.

Twice for Medium.

Three times for Low.

TO CHANGE TEMPERATURE DURING BROILING:

1 Touch **Broil** pad until the desired setting appears.

2 Touch **START** pad.

BROILING GUIDE

FOOD	AMOUNT	DONENESS	BROIL SETTING	SHELF POSITION FROM BOTTOM	FIRST SIDE TIME (MIN.)	SECOND SIDE TIME (MIN.)
BEEF						
Hamburgers	1/4 lb. each (1" thick)	Medium Well Done	High High	3 2 or 3	7 - 10 9 - 11	6 - 8 7 - 9
Rib-eye steak	3/4 - 1" thick (7 - 8 oz. each)	Rare Medium Well Done	High High High	3 3 3	5 - 7 6 - 8 8 - 9	3 - 5 4 - 6 9 - 11
Steaks: Sirloin, Porterhouse, T-bone	1 - 1 1/2"	Rare Medium Well Done	High High Medium	3 3 3	5 - 7 6 - 8 8 - 10	3 - 5 8 - 10 11 - 13
Chuck Steak	1"	Rare Medium Well Done	High High High	3 3 3	5 - 7 7 - 9 9 - 11	6 - 8 8 - 10 11 - 13
London Broil	1 - 1 1/4" 2 1/2 - 3 lb.	Rare Medium	High High	2 2	11 - 13 12 - 14	12 - 14 14 - 16
PORK						
Chops: loin or center	3/4 - 1"	Well Done	High	3	7 - 9	9 - 11
Bacon	Regular sliced Thick sliced	Well Done Well Done	Medium High	4 3	5 - 6 7 - 8	No turnover No turnover
Sausage	Patties or Links	Well Done	High	3	3 - 5	4 - 6
Ham slice, fully cooked	3/4"	Well Done	High	3	10 - 12	No turnover
Frankfurters			High	3	5 - 7	No turnover
LAMB						
Chops: rib, loin or center	3/4" 3 - 4 oz. each	Medium Well Done	High High	3 3	5 - 7 7 - 9	6 - 8 8 - 10
CHICKEN						
Broiler-Fryer, halved, quarter	1 - 3 lb.	Well Done	High	2	12 - 14	17 - 19

OVEN COOKING

BROILING GUIDE CONT.

FISH

Fillets	1/4 - 3/4"	Well Done	High	3	10 - 12	No turnover
Steaks	3/4"	Well Done	High	3	12 - 14	No turnover
TOAST - No preheat			High	4	2 - 3	

Note: The broiling times will be longer and browning will be lighter if appliance is connected to 208 volts.

OTHER FEATURES

HOW TO START SELF-CLEAN

Remember to allow time for the oven to cool down and the oven door to unlock (approx. 1 hour) if you are planning to use the oven after a self-clean cycle. Remove the broiler pan and broiler grid, all utensils and any foil. We recommend removing the oven racks. If they go through the clean cycle, they will darken, lose their luster and become hard to slide. With soap and water, clean any soil from the oven frame and the area outside the gasket on the door. These areas heat during self-cleaning cycle so soil could be burned on. To avoid heavy smoke or fire when subjected to high temperature, remove heavy spillovers in the oven using hot soapy water and cloth before cleaning cycle.

We recommend venting your kitchen with an open window or using a ventilation fan during the self-cleaning cycle.

1 Touch **Self Clean** pad.

2 Touch **START** pad.

Oven locks automatically. Cleaning time appears and begins counting down. When self cleaning time is completed, a signal will sound and will appear in the display. It will not be possible to open the door until the temperature drops below the lock temperature and indicator goes off.

Touch **Self Clean** pad once for Normal (4 hours) or twice for Light (2 1/2 hours).

After a self-clean cycle, you may notice some white ash in the oven. Wipe it up with a damp cloth after the oven cools. Gently lift the bottom element to wipe underneath it. It cannot be removed.

If the racks become hard to slide, apply a small amount of cooking oil to a paper towel and wipe the edges of the oven racks.

Note:

- The health of some birds is extremely sensitive to the fumes given off during the self-cleaning cycle of any range. Move birds to another well-ventilated room.

During the self-cleaning cycle, the outside of the oven can become very hot to touch. Do not leave small children unattended near the appliance.

If heavy spillovers are not wiped up before the self-cleaning cycle, they may flame and cause more smoke and odor than usual. This is normal and safe and should not cause alarm.

The glass ceramic cooktop and the Microwave Drawer can be used while the oven is self-cleaning.

OVEN LIGHT

The oven light automatically comes on when the door is opened. When the door is closed, press **Oven Light** pad on the control panel to turn the light on or off.

The oven light will not operate during a self-clean cycle. The oven light will come on automatically one minute before the end of a time controlled oven cooking operation.

TIMER

See page 11.

1 Touch **Timer/3 Min Plus** pad.

2 Touch the number pads to enter time in hours and minutes. For 30 minutes, enter .

3 Touch **Timer/3 Min Plus** pad. Timer will count down in minutes and seconds for times under one hour.

To cancel, touch and hold Timer/3 Min Plus pad for 3 seconds.

3 MINUTE PLUS

3 Minute Plus allows you to set 3 minutes quickly. You can also extend time in multiples of 3 minutes for Timer or Timed Cook.

1 Touch **Timer/3 Min Plus** pad.

2 Touch **Timer/3 Min Plus** pad again.

3 Touch **Timer/3 Min Plus** pad again.

CONTROL LOCK

The Control Lock prevents unwanted oven / drawer operation such as by small children. The oven and Microwave Drawer can be set so that the control panel is deactivated or locked.

TO LOCK

Touch **Control Lock** pad and hold for 3 seconds. The display shows **LOCK ON**.

TO UNLOCK

Touch **Control Lock** pad and hold for 3 seconds. The display shows **LOCK OFF**.

SETUP/CUSTOM HELP

AUDIBLE SIGNAL ELIMINATION

At the end of timed cook or when the oven temperature reaches set temperature, beeps will sound. If you wish to have the appliance with no audible signals, you can turn the audible signals off.

TO TURN SOUND OFF

- 1 Touch **Setup/Custom Help** pad. **TOUCH** **AGAIN**
- 2 Touch **Setup/Custom Help** pad again. **SOUND** **OFF ?**
TOUCH **START**
- 3 Touch **START** pad. The display shows **SOUND** **OFF**

TO RESTORE SOUND

- 1 Touch **Setup/Custom Help** pad. **TOUCH** **AGAIN**
- 2 Touch **Setup/Custom Help** pad again. **SOUND** **ON ?**
TOUCH **START**
- 3 Touch **START** pad. The display shows **SOUND** **ON**

END OF COOKING REMINDER

At end of timed cooking, the oven or microwave will signal every 10 seconds for the first minute; then every 3 minutes until **Stop/Clear** pad is touched, up to one hour.

TO TURN REMINDER OFF

- 1 Touch **Setup/Custom Help** pad three times. The display shows **REMINO** **SIGNAL** **OFF ?** **TOUCH** **START**.
- 2 Touch **START** pad. The display shows **REMINO**
SIGNAL **OFF**.

TO TURN REMINDER SIGNAL BACK ON

- 1 Touch **Setup/Custom Help** pad three times. The display shows **REMINO** **SIGNAL** **ON ?** **TOUCH** **START**.
- 2 Touch **START** pad. The display shows **REMINO**
SIGNAL **ON**.

AUTO START for Microwave Drawer - see page 20.

ADJUSTING OVEN TEMPERATURE

Your new oven may cook differently than your previous oven. For the first few weeks, use suggested package times and temperatures. Should you determine that an adjustment is desirable, try a few recipes or prepared foods to determine the number of degrees for the actual oven adjustment.

TO RAISE OR LOWER OVEN TEMPERATURE

- 1 Touch **Setup/Custom Help** pad five times. **ADJUST**
OVEN **TEMP** **TOUCH** **START**.
- 2 Touch **START** pad. The display shows **RAISE** **TOUCH 1**
LOWER **TOUCH 2**.
- 3 Touch desired number pad. Repeat touching the number pad to increase or decrease 5 degrees. **TOUCH** **START**
- 4 Touch **START** pad.

12 HOUR SHUT OFF

Oven will automatically turn off after 12 hours of operation for baking or after 5 hours for broil if it is accidentally left on. This feature can be deactivated, if desired. Default is 12 Hour Automatic Shut-off ON.

TO DEACTIVATE 12 HOUR SHUT OFF

- 1 Touch **Setup/Custom Help** pad six times. The display shows **CANCEL** **12 HOUR** **SHUTOFF** **TOUCH** **START**.
- 2 Touch **START** pad. The display shows **12 HOUR** **SHUTOFF**
IS OFF.

TO RE-ACTIVATE 12 HOUR SHUT OFF

- 1 Touch **Setup/Custom Help** pad six times. The display shows **TURN ON** **12 HOUR** **SHUTOFF** **TOUCH** **START**.
- 2 Touch **START** pad. The display shows **12 HOUR** **SHUTOFF**
IS ON.

DEMONSTRATION MODE

TO SELECT DEMO MODE

- 1 Touch **Setup/Custom Help** pad seven times. The display shows **DEMO ON?** **HOLD** **START** **3 SEC**.
- 2 Hold **START** pad for 3 seconds. The display shows **DEMO ON**.

TO CANCEL DEMO MODE

- 1 Hold **Setup/Custom Help** pad seven times. The display shows **DEMO** **OFF ?** **TOUCH** **START**.
- 2 Touch **START** pad. The display shows **DEMO** **OFF**

Note:

- Neither Microwave Drawer nor Oven heats in Demo Mode.
- Display counts down quickly.



OTHER FEATURES

LOCK LOWER OVEN

Door of lower oven can be locked for safety.

TO LOCK OVEN DOOR

1 Touch **Setup/Custom Help** pad eight times.     .

2 Touch **START** pad. The display shows   .

CLEANING AND CARE

Before cleaning any part of the range, be sure all controls are turned OFF and all surfaces are cool.

NON-COOKTOP SURFACES

EXTERIOR

The outside surface is precoated metal and plastic. Clean the outside with mild soap and water; rinse and dry with a soft cloth. Do not use any type of household or abrasive cleaner.

STAINLESS STEEL SURFACE (SELECT MODELS)

The exterior should be wiped often with a soft damp cloth and polished with a soft dry cloth to maintain its beauty. There are also a variety of products designed especially for cleaning and shining the stainless exterior of the oven. We recommend that the cleaner be applied to a soft cloth and then carefully used on the stainless exterior rather than sprayed directly on to it. Follow package directions carefully.

OUTSIDE OF THE DOOR

Wipe the window on both sides with a soft damp cloth to remove any spills or splatters. Metal parts will be easier to maintain if wiped frequently with a soft damp cloth. Avoid the use of spray and other harsh cleaners as they may stain, streak or dull the door surface.

CONTROL KNOBS

The control knobs may be removed for easier cleaning. Before removing the knobs, make sure the knobs are in the OFF position. Clean with a soft cloth dampened with mild soap and water; rinse and dry with a soft cloth. When replacing the knobs, check the OFF position to insure proper placement.





TOUCH CONTROL PANEL



If desired, the touch pads may be deactivated before cleaning. See the Control Lock information on page 25 of this manual. Wipe the panel with a cloth dampened slightly with water only. Dry with a soft cloth. Do not scrub or use any sort of chemical cleaners. Close door and touch **STOP/CLEAR**.

COOKTOP

If the cooktop should crack or break, do not use or attempt to clean it. Call an authorized servicer.

TO UNLOCK OVEN DOOR

1 Touch **Setup/Custom Help** pad eight times. The display shows     .

2 Touch **START** pad. The display shows   .

NORMAL DAILY USE CLEANING

Only use cleaning products that have been specifically designed for glass ceramic cooktops. Read and follow all instructions and warnings on the cleaning cream label. A sample cleaner cream is supplied with your range.

Before using the cooktop, clean the cooktop with the cleaner cream. To avoid possible damage to the cooking surface, do not apply cleaning cream to the glass surface when it is hot.

We recommend that you avoid wiping any surface unit areas until they have cooled and the hot surface indicator light has gone off. Sugar spills are the exception to this.

1 Apply a few drops of cleaner cream to the cooktop that is not hot.

2 Dampen clean paper towel and clean top.

3 Wipe off with another clean, damp paper towel, then wipe dry.

Note:

- Make sure bottom of cookware and cooking area are clean and dry before turning on the cooktop.
- Wipe up food spills and splatters before they burn on the surface.
- Do not mix cleaning products. Mixtures may interact and damage the surface.

SUGARY SPILLOVERS (JELLIES, FUDGE, CANDY, SYRUPS ETC.), MELTED PLASTICS OR HEAVY BURNED ON RESIDUE

Sugary spillovers, melted plastics or heavy burned on residue can cause pitting of the surface of your cooktop unless the spill is removed while still hot.

You must begin cleaning the spills while the cooktop is still hot.

1 Turn off all surface units and remove all pans immediately.

2 Wearing an oven mitt, use a razor blade scraper at a 30 degree angle against the glass ceramic surface and scrape from hot surface to a cooler area.

3 Remove the spills with paper towels.

Note:

- Do not use a dull or nicked blade. Be sure to use a new, sharp razor scraper.

- Do not use the razor blade for daily cleaning as it may wear the pattern on the glass.

METAL MARKS OR BURNED ON RESIDUE

Metal marks and burned on residue should be removed immediately after the cooktop has cooled. Metal marks can become permanent if not removed prior to future use.

1 Dampen a “scratchless” or “never scratch” pad that is safe for non-stick cookware. The pattern and glass will be damaged if the pad is not damp or is soiled or if another type of pad is used. Apply a cleaner cream for glass ceramic cooktops.

2 Scrub to remove as much soil as possible.

3 Apply the cleaner cream over the soil, cover with a damp paper towel and let stand 30 minutes to 1 hour. Keep moist by covering the paper towel with plastic wrap.

4 Scrub again and wipe off with another clean, damp paper towel. Then wipe dry.

Note:

- Do not use aluminum foil on the cooktop.
- If pots or pans of aluminum or copper are allowed to boil dry, permanent damage may affect the ceramic glass surface.
- Do not slide pots and pans across the cooktop surface.
- Cookware with rough bottoms can mark or scratch the cooktop surface.
- Do not use a dull or nicked blade. Be sure to use a new, sharp razor scraper.

MICROWAVE DRAWER

INTERIOR

Cleaning is easy because no heat is generated to the interior surfaces; therefore, there is no baking and setting of spills or spattering. To clean the interior surfaces, including drawer sealing surfaces, wipe with a soft damp cloth. **DO NOT USE ABRASIVE OR HARSH CLEANERS OR SCOURING PADS.** For heavier soil, use mild soap; wipe clean with a soft damp cloth. Do not use any chemical oven cleaners.

MICROWAVE DRAWER GUIDES

Remove the food crumbs from the Microwave Drawer guides. Wipe with a soft dry cloth in order to keep the Microwave Drawer opening and closing easily.

WAVEGUIDE COVER

ATTENTION The waveguide cover (located on the inside top of the microwave drawer area) is made from mica, so it requires special care. Keep the waveguide cover clean to assure good microwave performance. Carefully wipe with a soft damp cloth any food spatters from the surface of the cover immediately after they occur. Built-up splashes may overheat and cause smoke or possibly catch fire. Do not remove the waveguide cover.

ODOR REMOVAL

Occasionally, a cooking odor may remain in the Microwave Drawer. To remove, combine 1 cup water, grated peel and juice of one lemon and several whole cloves in a 2-cup glass measuring cup. Boil for several minutes using 100% power. Allow to set in the Microwave Drawer until cool. Wipe interior with a soft cloth.

OVEN

CAUTION Before cleaning any part of the oven, be sure the oven is turned off. If not, press **Stop/Clear**.

Allow the oven to cool before cleaning.

INSIDE OF THE DOOR

You do not need to clean the area inside the gasket by hand since the area is cleaned during the self-clean cycle.

Do not rub, clean or move the door gasket. Replace gasket when it is worn or frayed.

The area outside the gasket and the door liner can be cleaned with a soap-filled steel wool or plastic pad, hot water and detergent. Rinse well with a vinegar and water solution.

INSIDE OF THE OVEN (SELF-CLEANING)

See page 24.

REMOVE AND REPLACE OVEN DOOR

1 Open the door to the fully opened position.

2 Pull the lock located on both hinge supports up and engage in the hook of the hinge levers. You may have to apply a little downward pressure on the door to pull the locks fully over the hooks.

3 Grab the door by the sides, pull the bottom of the door up and toward you to disengage the hinge supports. Keep pulling the bottom of the door toward you while rotating the top of the door toward the range to completely disengage the hinge levers.

4 Proceed in reverse to reinstall the door.

Make sure the hinge supports are fully engaged before unlocking the hinge levers.

CAUTION The door is very heavy. For safe, temporary storage, lay the door flat with the inside of the door facing down.

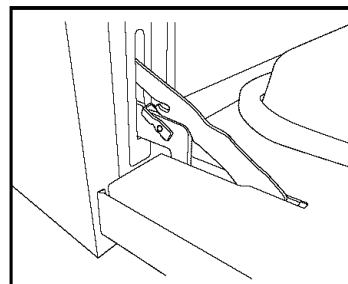

Lock in normal position.

CLEANING AND CARE

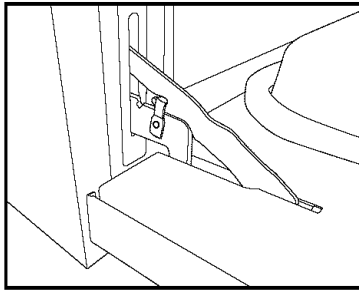

Lock engaged for door removal.

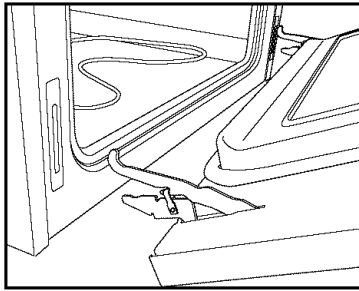

Door removed from the range.

OVEN RACKS

Clean with soap and water, rinse and polish dry.

To remove stubborn soil, use an abrasive cleanser or steel wool. After cleaning, rinse the racks with clean water and dry with a clean cloth.

Note:

- If the racks become hard to slide, apply a small amount of cooking oil to a paper towel and wipe on the edges of the oven racks.
- Do not leave in oven during self-cleaning cycle.

BROILER PAN AND GRID

Remove from oven at end of broiling. Drain away fats and accumulated juices. Sprinkle the grid with detergent and cover with wet paper towels or wet dish cloth. Allow to cool.

Wash in hot soapy water and scrub any remaining food particles with a soap filled pad or plastic scouring pad. Rinse and polish dry with a soft cloth.

The broiler pan and grid can be washed in the dishwasher.

Note:

- Do not leave in oven during self cleaning cycle.

OVEN LIGHT REPLACEMENT

CAUTION Be sure the oven is unplugged and all parts are COOL before replacing the oven lightbulb. Do not turn the oven light on during the self-cleaning cycle. The high temperature will reduce lamp life.

The interior oven light will turn on automatically when the oven door is opened.

The oven light may be turned on when the door is closed by using the oven light switch located on the control panel.

The bulb is covered with a glass shield held in place by a wire holder.

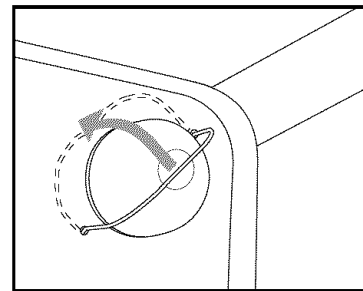

This glass shield must be in place whenever the oven is in use.

TO REPLACE THE LIGHT BULB

- 1** Turn the power off at the main source.
- 2** Wear a glove with leather palm for protection against possible broken glass.
- 3** Replace bulb with a 40 watt appliance bulb only.
- 4** Press wire holder to one side to release glass shield. Replace glass shield.

BEFORE YOU CALL FOR SERVICE

Please check the following before calling for service. It may save you time and expense.

PROBLEM	POSSIBLE CAUSE	SOLUTION
1 Part or all of range does not operate.	<ul style="list-style-type: none"> • Power cord of range is not completely connected to the electrical outlet. • Power outage. • Fuse/circuit breaker at home doesn't work. • Range is in Demo Mode. 	<ul style="list-style-type: none"> • Make sure the power cord is tightly connected to the outlet. • Check house lights to be sure. Call your local electric company for service. • Replace the fuse or reset the circuit breaker. • See page 25 for how to cancel Demo Mode.
2 Surface units do not heat.	<ul style="list-style-type: none"> • No power to the appliance. • Surface controls improperly set. 	<ul style="list-style-type: none"> • See SOLUTION for PROBLEM 1. • Check if the controls have been properly set. See page 13.
3 Surface units too hot or not hot enough.	<ul style="list-style-type: none"> • Improper cookware being used. 	<ul style="list-style-type: none"> • Use pans which are flat and match the diameter of the surface unit selected.
4 Surface unit stops glowing.	<ul style="list-style-type: none"> • It is normal when turned to a lower setting. 	
5 Scratches on glass ceramic cooktop.	<ul style="list-style-type: none"> • Incorrect cleaning methods were used. • Cookware with rough bottom has been used. 	<ul style="list-style-type: none"> • Use the recommended cleaning procedure. See page 26. • Use smooth, flat-bottomed cookware.
6 Areas of discoloration on the cooktop.	<ul style="list-style-type: none"> • Food spillovers not cleaned before next use. 	<ul style="list-style-type: none"> • Use the recommended cleaning procedure. See page 26.
7 Metalmarks on cooktop.	<ul style="list-style-type: none"> • Sliding or scraping of metal pans on top. 	<ul style="list-style-type: none"> • Do not slide metal pans. When cool, clean with cooktop cleaning cream to remove the marks.
8 Brown streaks or specks on cooktop glass surface.	<ul style="list-style-type: none"> • Boilovers are cooked onto surface. 	<ul style="list-style-type: none"> • Use the recommended cleaning procedure. See page 26.
9 Food in Microwave Drawer is not heated.	<ul style="list-style-type: none"> • No power to the appliance. • Drawer controls improperly set. • Range is in Demo Mode. 	<ul style="list-style-type: none"> • See SOLUTION for PROBLEM 1. • Check if the controls have been properly set. See page 16. • See page 25.
10 Microwave Drawer light does not work.	<ul style="list-style-type: none"> • Light bulb is loose or burned out. 	<ul style="list-style-type: none"> • Call for service.
11 Oven does not work.	<ul style="list-style-type: none"> • No power to the appliance. • Oven controls improperly set. • Oven too hot. • Range is in Demo Mode. 	<ul style="list-style-type: none"> • See SOLUTION for PROBLEM 1. • Check if the controls have been properly set. See page 21. • Allow the oven to cool below locking temperature and then reset to the desired setting/temperature. • See page 25.
12 Oven light does not work.	<ul style="list-style-type: none"> • Light bulb is loose or burned out. 	<ul style="list-style-type: none"> • Tighten or replace the bulb.
13 Touch controls will not operate.	<ul style="list-style-type: none"> • Control Lock is on. 	<ul style="list-style-type: none"> • See page 25 to unlock.
14 Lower oven will not open.	<ul style="list-style-type: none"> • Lower oven door is locked. 	<ul style="list-style-type: none"> • See page 26 to unlock oven door.

BEFORE YOU CALL FOR SERVICE

PROBLEM	POSSIBLE CAUSE	SOLUTION
15 Poor baking results.	<ul style="list-style-type: none"> • Oven controls improperly set. • Rack position is incorrect. • Incorrect cookware is used. • Pan warped. • Oven thermostat needs adjustment. • Range not level. • Oven door opened too frequently. 	<ul style="list-style-type: none"> • Check if the controls have been properly set. See page 22. • See page 21. • Use cookware suggested in recipe. • Do not use pans that are dented or warped. • See page 25. • Place a marked glass measuring cup filled with water on the center of the oven rack. If the water level is uneven, refer to the Installation Manual for leveling the range. • Open oven door only after shortest recommended baking time. Use Oven Light pad to see the food in the oven.
16 Food does not broil properly or smokes excessively.	<ul style="list-style-type: none"> • Oven controls improperly set. • Improper rack position being used. • Aluminum foil was incorrectly used. • Oven door was closed during broiling. 	<ul style="list-style-type: none"> • Check if the controls have been properly set. See page 22-23. • See page 23. • See page 21. • Leave the door open to broil stop position.
17 Self-cleaning cycle does not work.	<ul style="list-style-type: none"> • The oven temperature is too high to set a self-cleaning cycle. • Oven controls improperly set. 	<ul style="list-style-type: none"> • Allow the oven to cool and reset the controls. • Check if the controls have been properly set. See page 24.
18 Oven door does not open after a clean cycle.	<ul style="list-style-type: none"> • Oven too hot. 	<ul style="list-style-type: none"> • Allow the oven to cool below locking temperature.
19 Strong odor or light smoke when oven is turned on.	<ul style="list-style-type: none"> • This is normal for a new range. • Excessive food soils on the oven bottom. 	<ul style="list-style-type: none"> • It will disappear after a few uses. Ventilate the room to remove odors more quickly. • Use a self-cleaning cycle. See page 24.
20 Display flashes.	<ul style="list-style-type: none"> • Power failure. 	<ul style="list-style-type: none"> • Press Clear pad and reset the clock. If the oven was in use, you must reset the cooking function.
21 Steam from the vent.	<ul style="list-style-type: none"> • When using the bake or microwave feature, it is normal to see steam from the food coming out of the vent. 	

For more complete information and safety precautions, refer to your Operation Manual.

MICROWAVE DRAWER

SET CLOCK

- 1 Touch **Timer/Clock** pad and number **2**.
- 2 Touch number pads for correct time of day and touch **Timer/Clock** pad again.

If the electrical power supply to your range should be interrupted, the display will intermittently show:

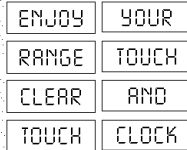

TIME COOKING

High Power Cooking

- 1 Enter cooking time by touching number pads. (Ex: 5 minutes)

5.00	TOUCH
START	OR
TOUCH	POWER
LEVEL	
- 2 Touch **START/Minute Plus** pad.

Variable Power Cooking

- 1 After step 1 above, touch **Power Level** pad until desired power level is in the display.
- 2 Touch **START/Minute Plus** pad.

SENSOR COOK

Sensor Cook automatically computes the correct time and power level to cook foods on the Menu Label perfectly.

- 1 Touch **Sensor Cook** pad once.

SEE	LABEL
SELECT	FOOD
NUMBER	
- 2 See Menu Label. Select desired food by touching number pad. Ex: Touch **5** for baked potatoes.
- 3 Touch **START/Minute Plus** pad.

SENSOR POPCORN/SENSOR REHEAT

- 1 Touch **Sensor Reheat** or **Sensor Popcorn** and **START/Minute Plus** pad.

REHEAT

Reheat automatically computes the correct warming time and microwave power level for foods shown on the Menu Label.

- 1 Touch **Reheat** pad once.

SEE	LABEL
SELECT	FOOD
NUMBER	
- 2 See Menu Label. Select desired food by touching the number pad. Ex: Touch **2** for frozen rolls or muffins.

FROZEN	ROLLS
ENTER	QTY

- 3 Touch the number pad to select quantity.

2

Ex: Touch **2** for 2 rolls or muffins.

- 4 Touch **START/Minute Plus** pad.

DEFROST OPERATION

Use this feature to defrost the foods shown on the Menu Label.

- 1 Touch **Defrost** pad.

SEE	LABEL
SELECT	FOOD
NUMBER	
- 2 See Menu Label. Select desired food by touching the number pad. Ex: Touch **2** for steaks/chops.

STEAKS	CHOPS
ENTER	WEIGHT
- 3 Enter weight by touching number pads.

1.0

- 4 Touch **START/Minute Plus** pad.
- 5 Microwave will stop to allow food to be turned over, shielded and/or removed. Close the Microwave Drawer. Touch **START/Minute Plus** pad.

MICRO WARM

Micro Warm allows you to keep food warm up to 30 minutes.

Direct Use

- 1 Touch **Micro Warm** pad.

ENTER	TIME
UP TO	30
MINUTES	
- 2 Enter desired time by touching the number pads. To enter 30 minutes, touch **3|0|0|0**.

30:00	TOUCH
START	
- 3 Touch **START/Minute Plus** pad.

With Manual Cooking

- 1 Enter desired cooking time and power level.
- 2 Touch **Micro Warm** pad.
- 3 Enter desired warming time up to 30 minutes.
- 4 Touch **START/Minute Plus** pad.

TIMER

- 1 Touch **Timer/Clock** pad and number **1**.
- 2 Enter time.
- 3 Touch **Timer/Clock** pad again.
To cancel timer, touch **STOP/Clear**.

MINUTE PLUS

Touch **START/Minute Plus** for one minute at 100% microwave power or to add a minute during manual cooking. Continue to touch for additional minutes.

AUTO-TOUCH GUIDE

For more complete information and safety precautions, refer to your Operation Manual.

LOWER OVEN



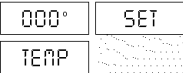
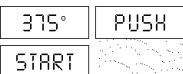

BAKE

- 1 Touch **Bake** pad. 
When the oven reaches the programmed temperature, a signal will sound.
- 2 Touch the number pads to set the desired oven temperature between 90°F and 550°F. For example: 
- 3 Touch **START** pad.

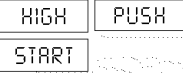

QUICK SET TEMP

- 1 Touch **Bake** pad. 
Twice for Warm 170°.
Three times for Med 350°.
Four times for Hot 450°.

BROIL

- 1 Touch **Broil** pad. 
Touch **START** pad.
- 2 Touch **START** pad.
Touch **Broil** pad once for High. 
Twice for Medium. 
Three times for Low. 

SELF CLEAN

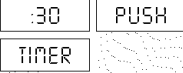

- 1 Touch **Self Clean** pad once for Normal (4 hours) or twice for Light (2 1/2 hours). 
- 2 Touch **START** pad. When self cleaning time is completed, a signal will sound and  will appear in the display.

TIMER

- 1 Touch **Timer/3 Min Plus** pad. 
- 2 Touch the number pads to enter time in hours and minutes. For 30 minutes, enter 3, 0. 
- 3 Touch **Timer/3 Min Plus** pad. Timer will count down in minutes and seconds for times under one hour. **To cancel, touch and hold Timer/3 Min Plus pad for 3 seconds.**

3 MIN PLUS

3 Minute Plus allows you to set 3 minutes quickly. You can also extend time in multiples of 3 minutes for Timer or Timed Cook.

- 1 Touch **Timer/3 Min Plus** pad. 
 - 2 Touch **Timer/3 Min Plus** pad again. 
 - 3 Touch **Timer/3 Min Plus** pad again. 
- To cancel, touch and hold Timer/3 Minute Plus pad for 3 seconds.**

OTHER FEATURES

CONTROL LOCK

The Control Lock prevents unwanted oven/drawer operation such as by small children. The oven and Microwave Drawer can be set so that the control panel is deactivated or locked.

To Lock

- 1 Touch **Control Lock** pad and hold for  3 seconds.

To Unlock

- 1 Touch **Control Lock** pad and hold for  3 seconds.

CUSTOM HELP

Check operation manual for specific details.

- 1 Touch **Setup/Custom Help** pad.
 - 2 times for **Sound Off/On.**
 - 3 times for **End of Cooking Reminder.**
 - 4 times for **Auto Start.**
 - 5 times for **Adjusting Oven Temperature.**
 - 6 times for **12-Hour Shut Off/On.**
 - 7 times for **Demonstration Mode.**
 - 8 times for **Lock Lower Oven.**

