

SEC. WORK	가 BRAND	나 MODEL	다 P/NO.	PRINTING DEGREE		MATERIAL AND PRINTING DESCRIPTION	LG MODEL 명	LANGUAGE	PAGE	REMARK
				EXTERIER	INTERIER					
P	LG	LDF7811WW LDF7811BB LDF7811ST	3828DD3002P	1	1	SNOW WHITE 100g OFFSET 인쇄	LD-6100WB LD-6100BB LD-6100TB	ENGLISH SPANISH	44	EUS 향

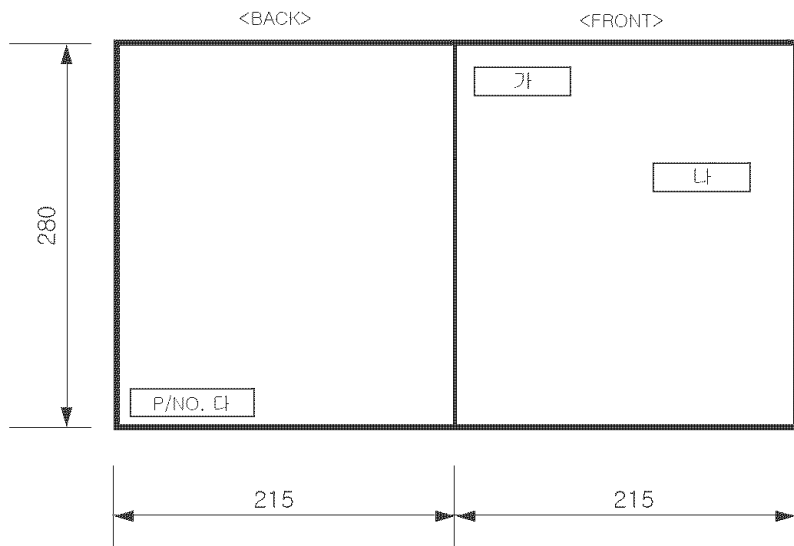

<< 주 기 >>

1. 재질, 인쇄방법, 인쇄도수, 외곽치수등은 작업표에 준한다.
2. 인쇄내용, 문자크기 및 형상, 선의 굵기 등은 설계에서 제시된 FILM에 준함.
3. 외곽치수는 절단후 치수임.
4. 양산전에 설계 한도를 득할 것.
5. 본 부품에 금지물질이 포함되지 않도록 하고, 상세 내용은 LG(63)-A-5501-34를 만족할 것.

<< NOTES >>

1. Material, printing and exterier size are refer to work tables.
2. Printing, text size and line are based on LG design film.
3. Exterier size on the drawing is cutting line.
4. Before product controlled by criteria sample.
5. The part should not contain prohibited substances(Pb,Cd,Hg,Cr+6,PBB,PBDE) and details should comply with LG standard of LG(63)-A-5501-34.

PDF ILLUSTRATOR DR COMPLETED 도면 DR 완료 완료일: 05.01.21

REV. NO. 기호	REVISION DESCRIPTION 변경 사항	REF. NO. 시방 번호	DATE 년/월/일	PREPARED 시방자	APPROVED 승인자
△					
△					
△					
△					

TRIG.	UNIT	mm	SCALE	1/1
MODELING	DESIGNED	REVIEWED	CHECKED	APPROVED
X	홍영민 05.01.21	X	신갑수 05.01.21	정해덕 05.01.21
LG 전자 (주) LG Electronics Inc.			RELATED DWG.	DWG. No.

MANUAL, OWNER'S
UDDY-FULLY 1/1
3828DD3002P



Owner's Manual

Dishwasher

MODEL : LDF 7811WW / LDF 7811BB / LDF 7811ST

Please read this manual carefully. It provides instructions on safe installation, use, and maintenance. Retain it for future reference.

Record the model and serial numbers of your machine and report this information to your dealer if your machine requires service.

To obtain nearest authorized service center or sales dealer, or to obtain product, customer, or service assistance. Call 1-800-243-0000 (24 hours a day, 7 days per week) and choose the appropriate prompt from the menu and have your product type, model number, serial number and Zip code; or visit our web site at <http://www.lgservice.com> or <http://us.lgservice.com>

D

■ Ultra Big Capacity

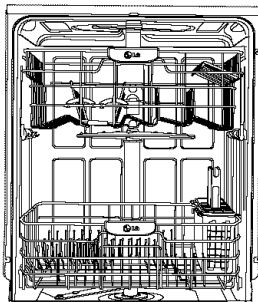

If you raise the Upper Rack, you can load large dishes in the Lower Rack. (Max. 14 in.)

The tall tub provides large dishes loading as well as large capacity.

LG dishwashers let you load oversized items in the lower and upper rack.

■ Slim Direct Inverter Motor

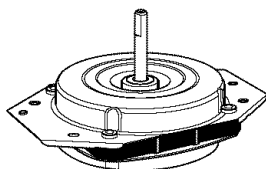

Newly introduced Slim Direct Inverter motor is inverter-controlled. Speed is controlled based on program selection. It also offers high energy efficiency to minimize energy loss.

■ Hybrid Drying System

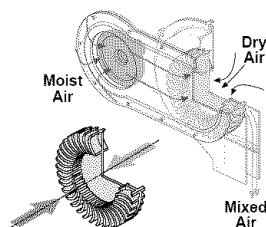

This is one of the best performance solutions for drying dishes because it minimizes venting humid air to the outside of the dishwasher. In addition, this system ensures better drying results compared to the condensing drying system.

■ Vario Spray System

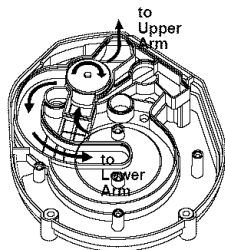

Because of alternating water spray between the upper and lower racks, the water pressure allows superior performance and reduced consumption of water and electricity.

■ Self Cleaning Filter

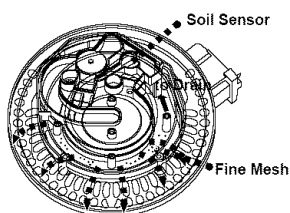

For best wash results, the self-cleaning filter system continuously cleans the water as it circulates. Your LG dishwasher has a self-cleaning filter that grinds food in to small particles before it goes down the drain.

C ONTENTS

PART 1. SAFETY AND CAUTION	3~6
PART 2. PARTS OF YOUR DISHWASHER	7
OPERATING INSTRUCTIONS	
PART 3. FUNCTIONS OF CONTROL BUTTON	8~9
PART 4. USING YOUR DISHWASHER	10~14
PART 5. CARE & MAINTENANCE	15
PART 6. OPERATING SEQUENCE	16
PART 7. PROGRAM	17
PART 8. TROUBLESHOOTING	18

S AFETY AND CAUTION

IMPORTANT SAFETY INSTRUCTIONS

Serious injury or death may occur when not observing the following rules.

WARNING - To reduce any risk of electric shock, fire or other personal or property injury when using your dishwasher, please follow basic precautions, including the following :

- This manual contains very important notes regarding the installation, use and maintenance of your dishwasher.
- The manufacturer can not be responsible for problems caused by ignoring these safety and caution instructions.
- Read all instructions (manuals) carefully before using the dishwasher.
- Use the dishwasher only for its intended function, or household use.
- Use only detergents or wetting agents recommended for use in a dishwasher and keep them out of the reach of children.
- The appliance is not intended for use by young children or unqualified persons without supervision.
- When loading items to be washed :
 - 1) locate sharp items so that they are not likely to damage the door seal ; and
 - 2) load sharp knives with the handles up to reduce the risk of cut-type injuries.
- Do not wash plastic items unless they are marked dishwasher safe or the equivalent.
For plastic items not so marked, check the manufacturer's recommendations.
- Do not touch the heating element during or immediately after use.
- Do not operate your dishwasher unless all enclosure panels are properly in place.
- Do not tamper with controls.
- Do not abuse, sit on, or stand on the door or dish rack of the dishwasher.
- To reduce the risk of injury, do not allow children to play in or on a dishwasher.
- Under certain conditions, hydrogen gas may be produced in a hot-water system that has not been used for two weeks or more. **HYDROGEN GAS IS EXPLOSIVE.** If the hot-water system has not been used for such a period, turn on all hot-water faucets and let the water flow for several minutes. This will release any accumulated hydrogen gas. As the gas is flammable, do not smoke or use an open flame during this time.
- Remove the door to the washing compartment when disposing of an old dishwasher.

S SAFETY AND CAUTION

SAVE THESE INSTRUCTIONS

For a permanently connected dishwasher:

This appliance must be connected to a grounded metal, permanent wiring system or an equipment-grounding conductor must be run with the circuit conductors and connected to the equipment-grounding terminal or lead on the appliance.

⚠ WARNING



Tip Over Hazard

Do not put excessive downward force on the open door as this could cause damage to the unit. The dishwasher can be used on completion of the installation.

⚠ WARNING



Electrical Shock Hazard

Not following these instructions can result in death, fire or electrical shock. Electrically ground dishwasher. Connect ground wire to green ground connector in terminal box. Do not use an extension cord.

⚠ WARNING Serious injury or death may occur when not observing the following Instructions.

Installation

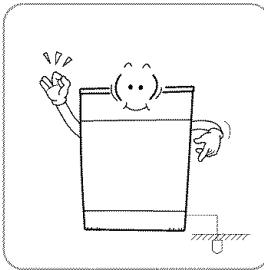

Your Dishwasher is only for 120V. Before electrical power connection, make sure cord is grounded and connected to a circuit breaker.

No grounding may cause breakdowns or electric shocks.

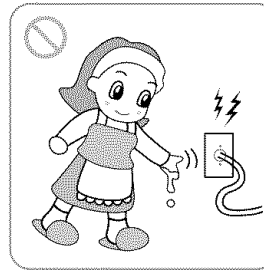

Do not grasp the electrical cable or switch with wet hands. Do not use a damaged electrical cable, power plug or socket.

It may cause electric shock.



Do not install or store the dishwasher where it will be exposed to the weather.

It may cause an electric shock, fire, malfunctions and deformation.

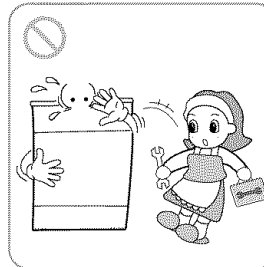

Disassembly or revision should be conducted by experienced service persons.

It may cause breakdowns, fire and electric shock.

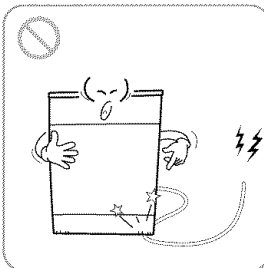

Do not damage electrical cable itself or place heavy objects on the cable.

Electrical cable damage may cause fire and electric shock.

SAFETY AND CAUTION

! WARNING Serious injury or death may occur when not observing the following rules.

Use and Maintenance

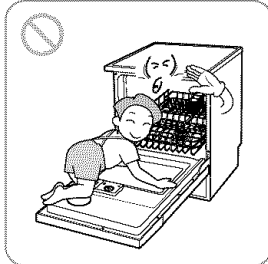

Do not allow children or pets to play on the door or inside the dishwasher. Do not allow children to hang on the door because the door may fling open and they may be injured.

Children may fall off. Pets or children may be wounded by rotating parts or suffocated inside tub.



Don't leave racks out of dishwasher.

Children may play inside a dishwasher.

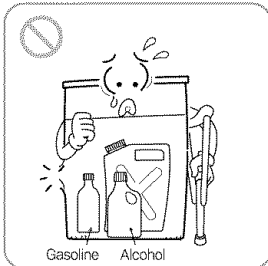

Do not store or use combustible materials, gasoline or other flammable vapors and liquids in or around dishwasher.

It may cause fire.

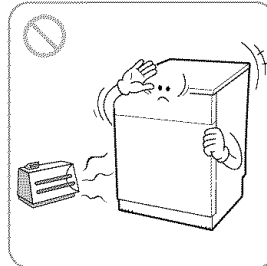

Keep the dishwasher away from electric stove, candle and any inflammable Objects.

It may cause melting of some parts or fire.



Do not splash water on to the dishwasher.

It may cause fire and electric shock.

! CAUTION concerning the Power Cord

Most appliances should be connected to a dedicated circuit; that is, a single outlet circuit which powers only that appliance and has no additional outlets or branch circuits. Check the specification page of this owner's manual to be certain (See page 7). Do not overload wall outlets. Overloaded wall outlets, loose or damaged wall outlets, extension cords, frayed power cords, or damaged or cracked wire insulation are dangerous. Any of these conditions could result in electric shock or fire. Periodically examine the cord of your appliance, and if its appearance indicates damage or deterioration, unplug it, discontinue use of the appliance, and have the cord replaced with an exact replacement part by an authorized service person. Protect the power cord from physical or mechanical abuse, such as being twisted, kinked, pinched, closed in a door, or walked upon. Pay particular attention to plugs, wall outlets, and the point where the cord exits the appliance.

Child Safety

- Controls may be locked using Child Lock mode to prevent settings from being changed by children.
- Keep children away from detergents and rinse-aids.
- Do not allow children to operate the dishwasher.
- Young children should be supervised to ensure that they do not play with the appliance.

S SAFETY AND CAUTION

! CAUTION Injury, malfunction or poor performance may occur when not observing the following instruction.

Installation

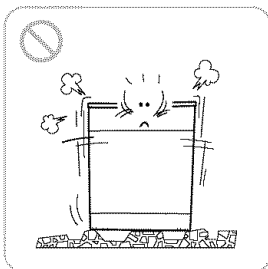

Place dishwasher on even and solid floor.

Uneven surface may cause abnormal noise and vibration.

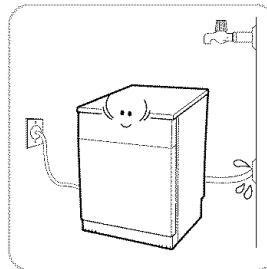

After installation, make sure of hose connection.

Loosened connection may cause water leakage leading to property damage.

Use and Maintenance

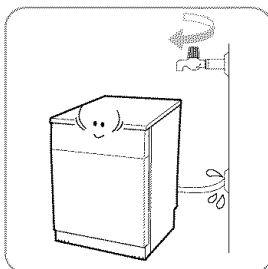

When dishwasher is not in use for a long time, close water valve.

It may cause water leakage.

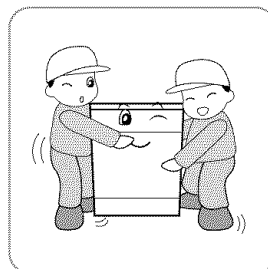

Dishwasher should be unpacked and moved by 2 or more persons due to its of heavy weight.

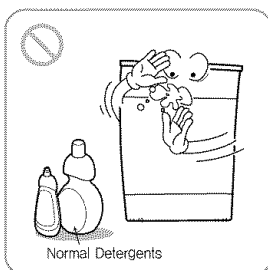

Use only detergents or wetting agents recommended for use in a dishwasher and keep them out of the reach of children.

Improper detergents may cause malfunctions, electric shock or fire due to excessive suds.

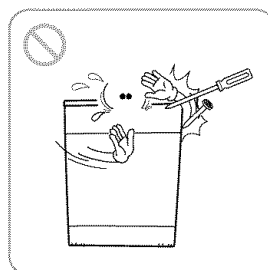

Do not press the button with sharp edged devices like a screwdriver or a pin.

It may cause electric shock or malfunctions.

P ARTS OF YOUR DISHWASHER

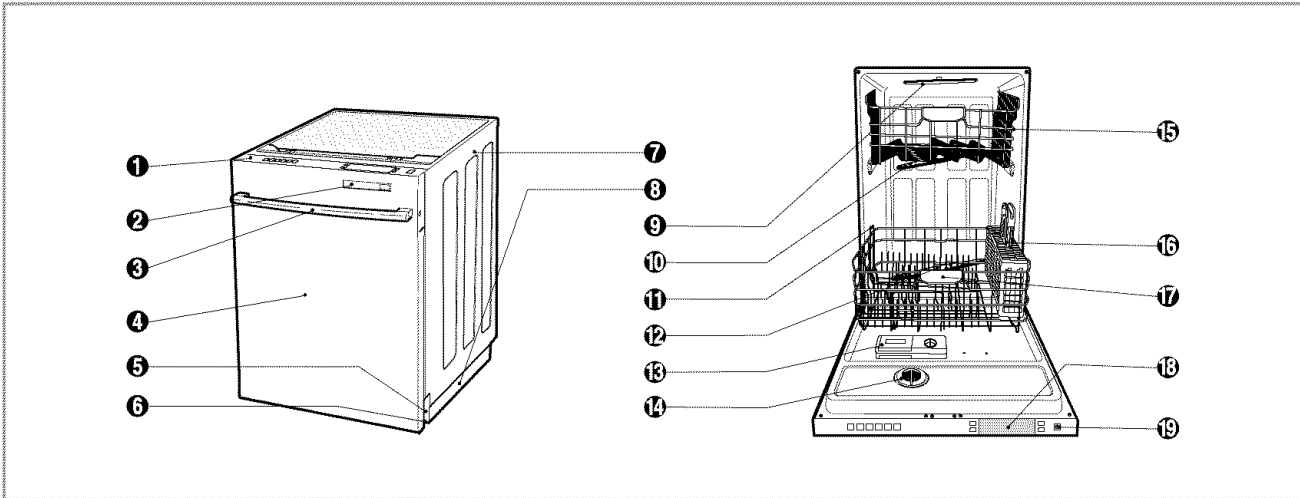

- | | |
|-------------------|-----------------------------------|
| ① Control Panel | ⑪ Removable Tines |
| ② Front Display | ⑫ Lower Spray Arm |
| ③ Door Handle | ⑬ Detergent & Rinse Aid Dispenser |
| ④ Front Cover | ⑭ Vapor Vent Cover |
| ⑤ Lower Cover | ⑮ Upper Rack |
| ⑥ Leveling Foot | ⑯ Cutlery Basket |
| ⑦ Side Cabinet | ⑰ Lower Rack |
| ⑧ Base | ⑱ Top Display |
| ⑨ Top Spray Arm | |
| ⑩ Upper Spray Arm | |

Specifications

- Power supply: 120V, 60Hz AC only
- Water Pressure: 20 - 120 psi (140 - 830 kPa)
- Size (WxDxH): 23 7/8" x 25" x 33 7/8"
(606mm x 635mm x 860mm)
- Inlet Water Temperature: 120°F (49°C)
- Weight: 115 lbs. (52 kg)

The appearance and specifications are subject to change without manufacturer's notice

FUNCTIONS OF CONTROL PANEL

■ Control panel may vary on some models.

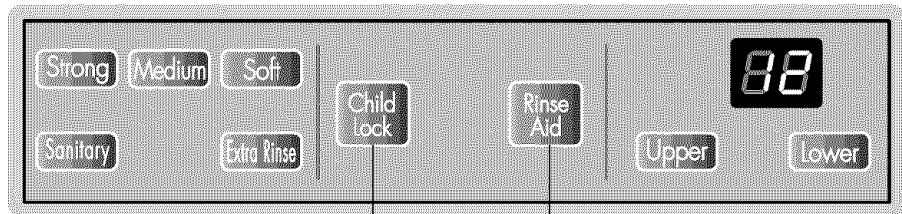

INDICATOR

- Child lock: Lamp will turn on when **Child Lock** setting is on.
- Rinse Aid: Refill with Rinse aid when Lamp turns on.

PROGRAM

- Press the program that corresponds to your desired wash cycle.

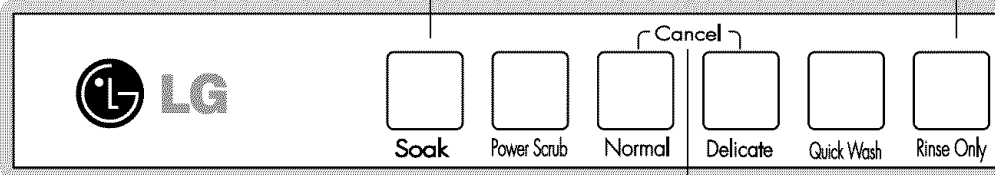

CANCEL

- To cancel a running program, open the door, then press and hold the **Normal** and **Delicate** buttons for 3 seconds.

- Soak** This program is for very heavily soiled loads including pots, pans and casserole dishes which may have dry food residue.
- Power Scrub** This program is for very heavily soiled loads
- Normal** This program is for normally soiled everyday loads.
- Delicate** This program is for washing delicate items like glasses.
- Quick Wash** This program is for that quick wash of lightly soiled recently used dishes and cutlery.
- Rinse Only** This program is for very lightly soiled loads.

SPRAY

- Repeated pressing of the Spray button will select **Strong, Medium** or **Soft**.

DELAY START

- If you want to delay the start of a selected program, press the **Delay Start** button.
- Each press of **Delay Start** will delay the start of the cycle by one hour.
- The delay start time can be adjusted from 1 to 24 hours in one-hour increment.

POWER

- For operating, press this button first for power on.
- After operating, the power automatically switches off for safety and economy.
- In case of an unusual Power surge or disturbance, the power may be automatically turned off for safety.

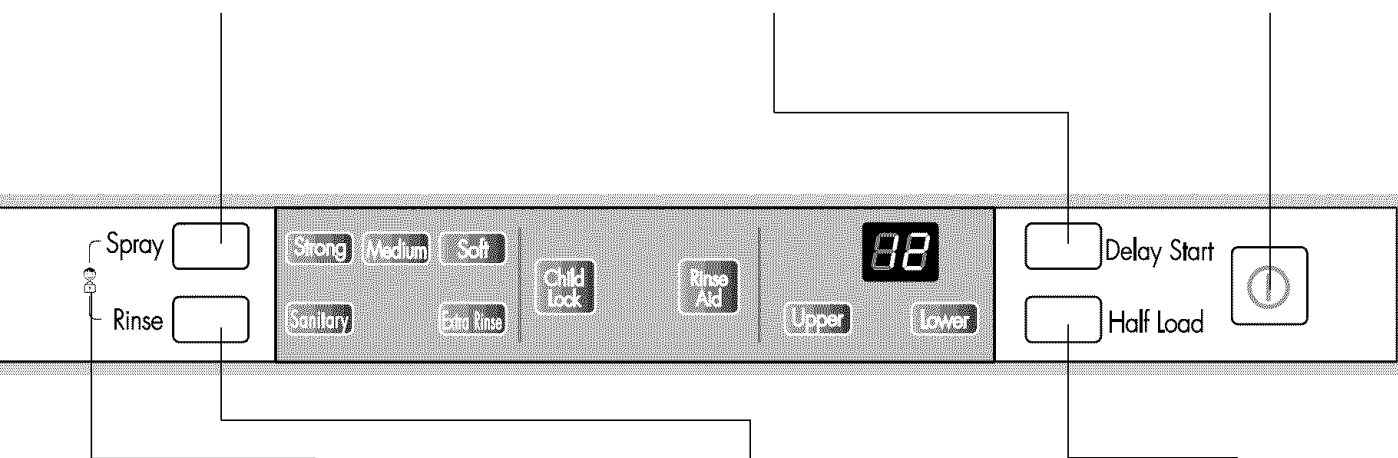

CHILD LOCK

- Lock the control buttons to prevent the settings from being changed.
- To lock/unlock, press **Spray** and **Rinse** buttons simultaneously for 3 seconds with door open.

SANITARY/ EXTRA RINSE

- Repeated pressing of the Rinse button will select **Sanitary, Extra Rinse** or both.
- If you select the **Sanitary** function, the temperature of Heating Rinse can reach 161°F (72°C)
- When you select **Extra Rinse**, an additional rinse cycle is added.

HALF LOAD

- In case of a small load, use the upper or lower rack only to save energy.
- Each press of the **Half Load** button cycles between upper rack only and lower rack only.
- If you don't press **Half Load**, the dishwasher runs normally, i.e. operation of upper and lower spray arm alternating periodically.

USING YOUR DISHWASHER

Before using the dishwasher, please read Important Safety Instructions.

Water supply temperature should be 120°F (49°C) for better washing and reasonable cycle time. For this reason, use hot water faucet only. It is also important that the dishwasher is loaded according to instructions for the effective cleaning.

When loading your dishwasher, make sure that insoluble items such as bones, toothpicks and pieces of paper have been removed.

When loading the dishwasher, observe the following general guidelines;

1. Deep based items should be placed at an angle to help water run off and dry properly.
2. Remove solid, burnt-on scraps from dishes prior to loading in the dishwasher.
3. Load only items which are dishwasher safe.

NOTE Please avoid utensils that are non-heat resistant, metal decorated, etc.

Loading the Lower Rack

This lower rack allows max. 14 in. (355mm) plates, pans or any utensils which mean the size of rack is bigger and is higher than industry standard thanks to super big tub capacity.

NOTE Do not obstruct the rotation of the spray arms. Make sure large items do not prevent the detergent dispenser from opening.

The lower rack is best loaded with dinner plates, soup bowls, dishes, pots, pans, lids and even a grill tray. Plates should be positioned upright and facing the center of the rack. Pots, pans and large dishes must be turned upside down.

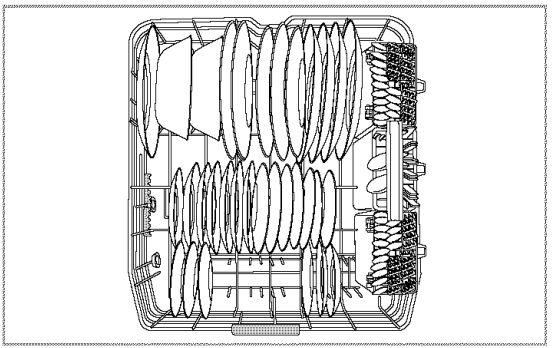

10 place setting, lower rack

Basically the lower rack is not meant to load small items like cups, wine glasses or small plates. These items should be loaded on the upper rack for proper distribution.

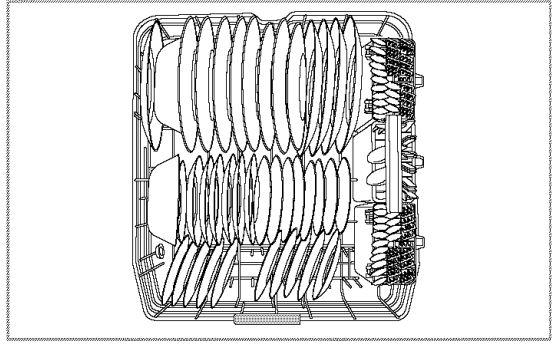

12 place setting, lower rack

Cutlery Basket

Racks are designed to hold even the most delicate items securely in place as well as tall items. In addition, our extra cutlery and knife rack has separators to avoid scratching and tarnishing of your delicate cutlery basket can be divided into three separate baskets which can be used on both the upper and lower levels. If you only have a small load of cutlery, the baskets can be removed leaving extra space for other plates.

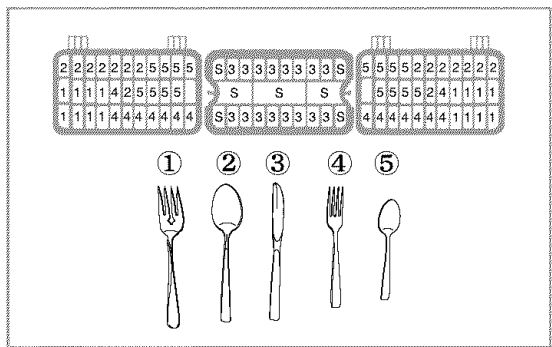
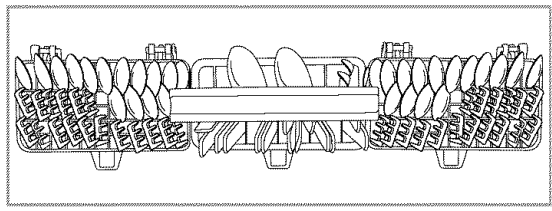

NOTE Be careful when loading and unloading sharp-edged items. Load sharp knives with the handles up in order to reduce the risk of cut-type injuries.

U SING YOUR DISHWASHER

Removable Tines

If you need to wash large items, you can remove these tines from the main rack.

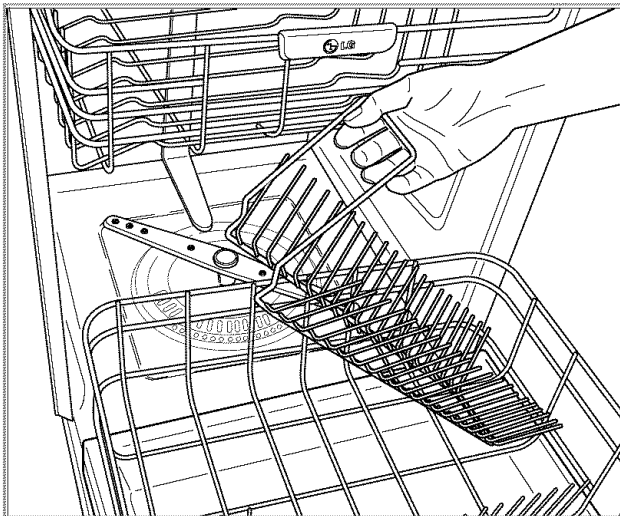

Adjustable angular tines

The plate supports in the lower and upper racks can be folded down. Based on the size and shape of the dishes, you can adjust the angle of the tines to five different levels.

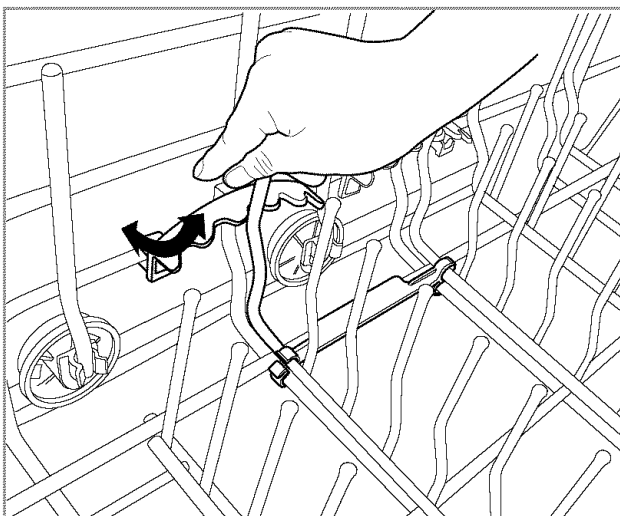

NOTE

Be careful when adjusting angular tines and apply gentle force.

Loading the Upper Rack

The upper rack is best loaded with more delicate items, small plates, cutlery basket, cups, glasses and dishwasher safe plastic items. Plates should be positioned upwards with the plate bottom facing the front of the rack. Cups, glasses and bowls must be positioned upside down. Extra cups or cooking utensils can be laid on the fold down cup racks which may also provide support for long stem glasses. Take care not to obstruct the rotation of the spray arm under the upper rack.

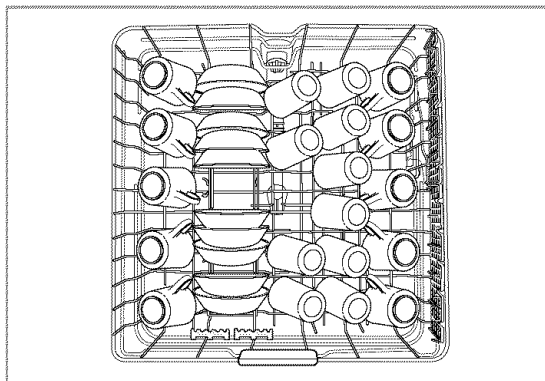

10 place setting, upper rack

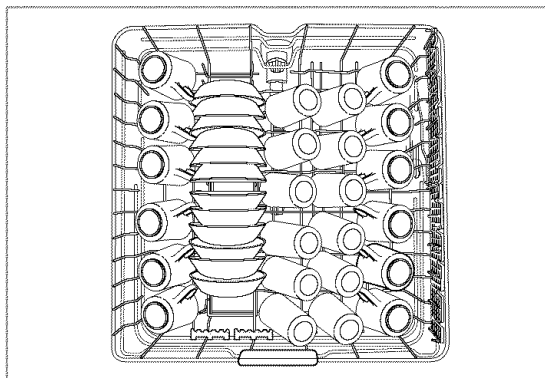

12 place setting, upper rack

U SING YOUR DISHWASHER

Height Adjustable Upper Rack for 14 in. (355mm) loading (on some models)

LG dishwasher proudly introduces the ability to load 14 in. (355mm) dishes. An upper rack that moves up and down lets you put tall and oversized items on it. LG dishwashers adjust enough to allow 14 in. (355mm) dinner plates on the lower and 12 in. (305mm) plates on the upper rack.

To raise the rack

Pull the rack upward holding the middle location of the upper rack ( marked position) until the rack locks.

To lower the rack

Pull the two levers on the left and right sides of the rack until rack is level for smooth operation.

When you pull the levers upward, hold the middle location of the upper rack.

( marked position).

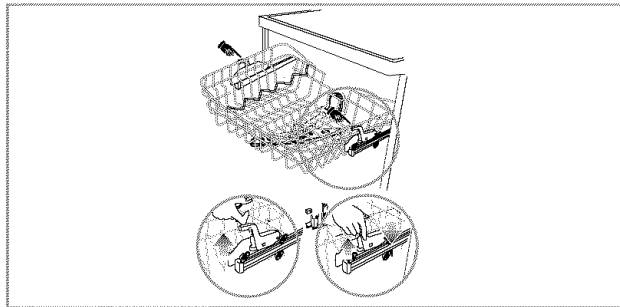

NOTE

After adjusting, check that the spray arm is free to rotate without being stopped by dishes loaded on the upper rack. Do not adjust racks when dishes are loaded.

Caution

Non Dishwasher Safe Items

The combination of high water temperature and dishwasher detergents may damage particular items, therefore we do not recommend using the dishwasher to wash the following items:

- Hand painted silver or gold leaf crockery
- Wood or bone handled utensils
- Iron or non rustproof utensils
- Plastic items which are not dishwasher safe.

Half Loading Option

In case you do not have enough dishes for a full load you can simply load dishes in the upper rack or in the lower rack only. You can then wash either rack separately by selecting the half load option. This will bring about a savings in hot water, electricity, and time.

Removing the Upper Rack

The upper rack can be removed to make more room in the lower rack.

To remove the upper rack

1. Pull the upper rack out until it stops.
2. Pull the upper rack upward gently from slides.

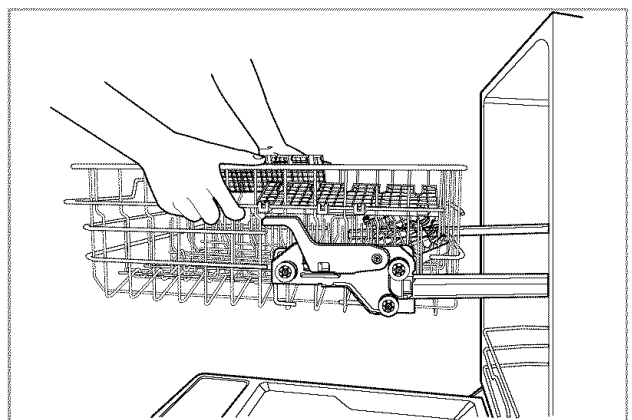
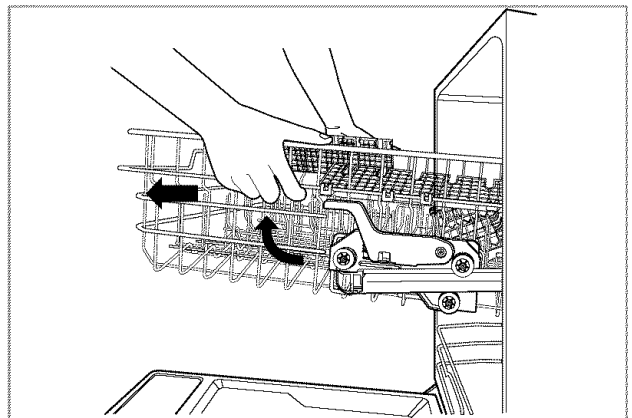

NOTE

Always remove dishes from the upper rack before removing the rack.

U SING YOUR DISHWASHER

Adding detergent to dispenser

- Detergent must be put into the detergent chamber before starting every program except the Pre-Wash.
- Please follow the manufacturer's instructions printed in the manual when determining the correct amount of detergent.
- If your dishes are only moderately dirty, you may be able to use less detergent than recommended.
- The detergent chamber holds 1.4 oz (40g) max.
- The amount of detergent depends on the program and dish loads. Refer to the guide table.

PROGRAM	AMOUNT OF DETERGENT
Soak	0.9oz (25g)
Power Scrub	0.9oz (25g)
Normal	0.7oz (20g)
Delicate	0.7oz (20g)
Quick Wash	0.7oz (20g)
Rinse Only	No detergent

! Caution

Detergent Information

Use only the detergent intended for household dishwashers or the dishwasher may fill with suds during operation. Suds may reduce washing performance and could cause the unit to leak. (Hand-Wash detergent is not allowed for this dishwasher.)

Filling the dispenser

1. Push latch to open.

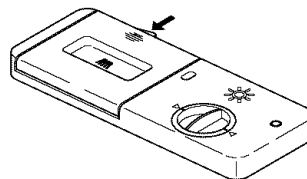

2. Add detergent to the main wash compartment. (See the table for the amount of detergent.)

NOTE

Do not add detergent for a rinse cycle.

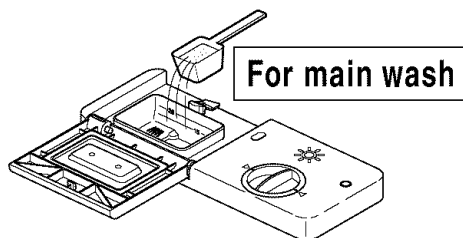

3. If needed, add detergent to pre wash compartment.

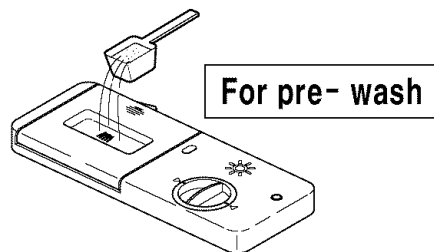

4. Close the cover. (You can hear cover latch click.)

NOTE

Too much detergent can leave a film on dishes.

U SING YOUR DISHWASHER

Adding Rinse Aid to dispenser

The purpose of rinse aids is to prevent possible spots on dishes formed from droplets during drying operation. By removing them, drying performance will be increased.

NOTE

Only liquid rinse aids can be used for this dishwasher.

• Filling Rinse Aid

1. Rotate the round cap counterclockwise and remove it.

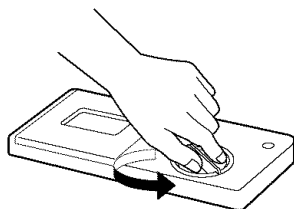

2. Add a liquid rinse aid to the maximum level. (Max. 4.8 oz (145mL))

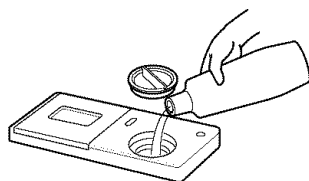

3. Replace and lock the cap.

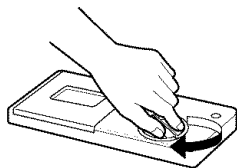

4. Rinse aid will be automatically dispensed during the final rinse cycle.

• Rinse Aid Amount Setting

The factory setting is at level 3 which is where you can expect the best performance under a normal condition. After a cycle is done, if you notice some spots, streaks or water marks on the dishes, adjust to a higher setting. If you notice foam present on the bottom of the glasses or tub bottom, change to a lower setting.

1. Remove the cap.
2. Rotate adjuster to the desired setting.

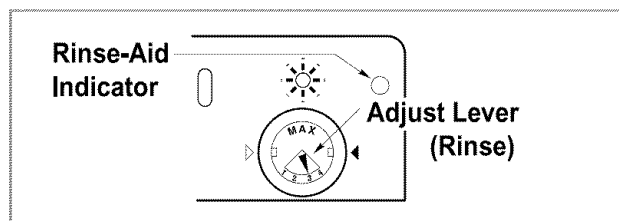

• Refilling Rinse Aid

4.8 oz (145mL) is the capacity of the rinse aid dispenser. The refilling period totally depends on your washing habits such as the number of washes per month and which rinse aid setting you adjust to your washing conditions. The indicator light will inform you when there is insufficient rinse aid in the dispenser. The indicator light will stay on when you close the door to start a cycle.

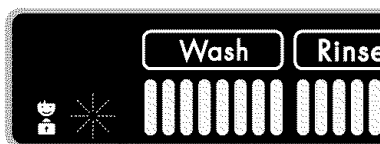

When the  lamp is on, it indicates the rinse-aid reservoir is almost empty.

- Black indicates sufficient Rinse Aid
- Clear indicates Rinse Aid required

CARE & MAINTENANCE

For best results, it is important to periodically check and care for the filters and spray arms.

Cleaning metallic parts

With a cloth or sponge, you can clean some parts such as exterior or interior parts.

Stainless steel tub has a tendency to build up cloudy film on its surface especially when using hard water.

Cleaning Spray Arms

- Lower Spray Arm

- Check that the water jet holes are not blocked by food particles.
- When cleaning is necessary, remove the Spray arm by pulling up.
- Clean the spray arm and replace it pushing down.

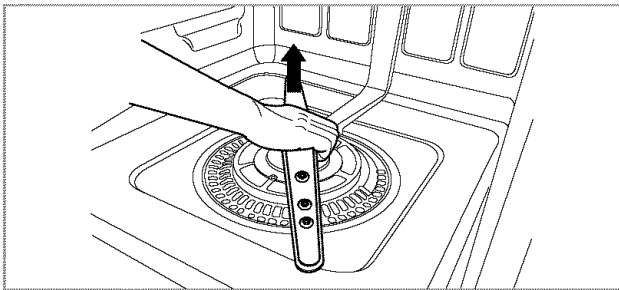

- Upper Spray Arm

- Pull the upper rack forward. Make sure the water jet holes are not blocked by food particles.
- When cleaning is necessary, remove the arm by unscrewing the nut.
- Clean the spray arm and replace it in the reverse order. Make sure the nut is tight!

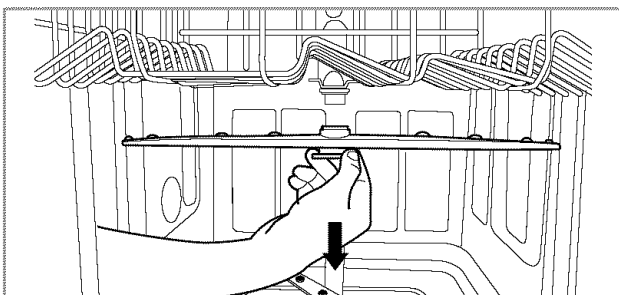
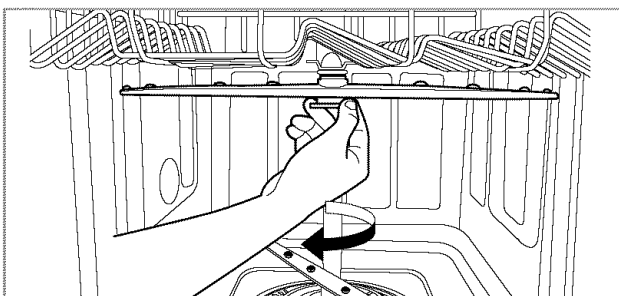

- Top Spray Arm

- Make sure the water jet holes are not blocked by food particles.
- When cleaning is necessary, remove the arm by disassembling the hook from the bracket which holds the Top Spray Arm assembly to the tub.
- Clean the spray arm and replace it.

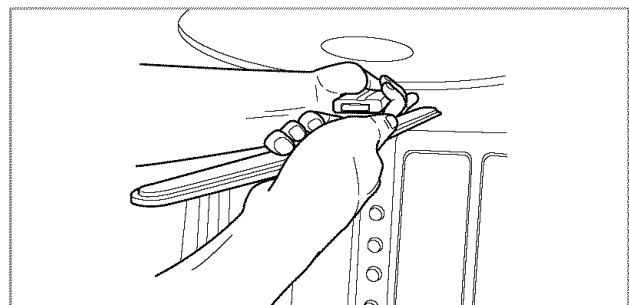
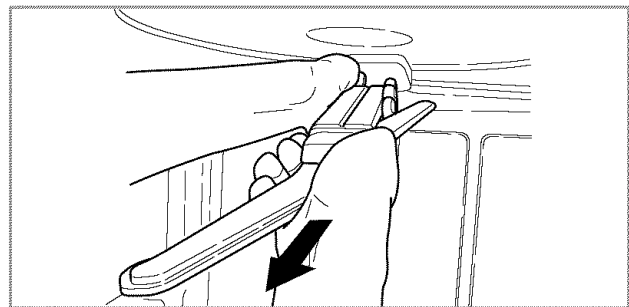
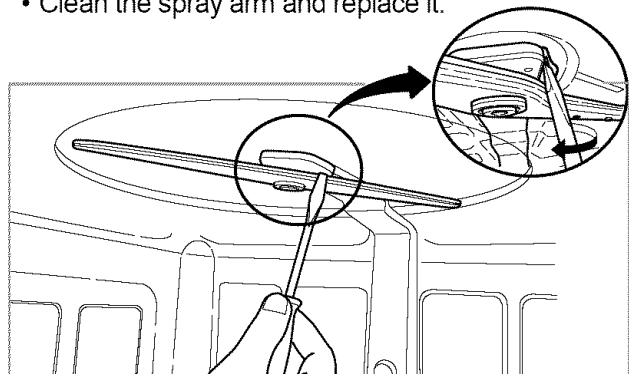

Maintenance by seasons

- To prevent possible problems, be sure to follow procedures below.
- During the summer season If you are absent for extended periods of time, it is recommended that you close the water valve and unplug power cord.
- During the winter season, if room temperature where dishwasher is located is exposed to freezing, it is recommended that you winterize the water supply lines and product itself.

OPERATING SEQUENCE

1. Open the door and press the power button.

Open the door. Press the power button to see the default setting.

2. Check rinse-aid.

The indicator lights will illuminate if refilling is necessary.

3. Load the dishes after first removing any scraps of food.

Remove any scraps of food in advance. Pull the lower rack out and load the dishes and cutlery in and push it all the way back. Pull the upper rack out and load the cups, glasses, etc.

4. Ensure that the spray arms can rotate freely.

5. Measure the detergent.

Add the required amount of detergent into the dispenser. Close the detergent dispenser lid.

6. Setting the program.

Select desired program and options. Before starting, the display window will show the estimated running time of the selected program. If the number of dishes only fill one rack, you can use the Half Load option. For example, if you load dishes only on the upper rack, you adjust the **Half Load** button to the upper rack.

Remember to load all dishes into the selected rack.

The estimated remaining time will be displayed.

If the door is opened during operation, the dishwasher stops.

Once the door is closed, the program will restart from the point where it's stopped.

7. Close the door. The dishwasher will start automatically.

8. At the end of the Program.

End is displayed on the digital display for a few seconds and a tone will sound signaling the program completion. The dishwasher automatically switches off for safety and energy savings.

Caution

Empty the lower rack first and then the upper one, this will avoid water dripping from the upper rack onto the dishes in the lower one.

Warning

In general, it is not advisable to open the door while the dishwasher is running. If the door is opened, a safety device stops the machine. Care should be taken when opening the door immediately following the cycle, as steam may escape.

Auto-Off

When the power is turned on, if you don't select program or if you don't close the door after selecting a program, your dishwasher will automatically turn off in 10 minutes.

P PROGRAM

Program	WASH		RINSE				DRY	Water (gal/L)	Time (min)
	Pre Wash	Main Wash	Rinse 1	Rinse 2	Rinse 3	Heating Rinse			
Soak	120°F	140~149°F				162°F		5.5~9.2/ 21~35	143~191
	49°C	60~65°C				72°C			
Power Scrub		134~145°F				154°F		5.5~9.2/ 21~35	123~171
		57~63°C				68°C			
Normal		140°F				149°F		5.5~7.9/ 21~30	101~135
		60°C				65°C			
Delicate		115~120°F				154°F		5.5~7.9/ 21~30	103~120
		46~49°C				68°C			
Quick Wash		115°F				140°F		4.2 / 16	74
		46°C				60°C			
Rinse Only								1.3 / 5	14

Soak

This program is for very heavily soiled loads including pots, pans and casserole dishes which may have dry food residue.

Power Scrub

This program is for very heavily soiled loads.

Normal

This program is for normally soiled everyday loads.

Delicate

This program is for washing delicate items like glasses.

Quick Wash

This program is to wash lightly soiled dishes and cutlery and wash them immediately after use.

Rinse Only

This program is for very lightly soiled loads.

TROUBLESHOOTING

Problem	Causes	Recommended Actions
Dishwasher does not operate	Door is not completely closed.	Check the door is completely closed and latched.
	Cycle is not selected.	Select the desired cycle.
	Power supply is not connected.	Connect power supply properly.
	Water is not supplied.	Check water faucet.
	Fuse is blown out.	Replace fuse or reset circuit breaker.
Too long operation	Cold water is supplied.	Check hot water faucet is connected (Heating water takes it longer).
Odor	Remaining water inside from the last cycle	Use a RINSE ONLY cycle until dishes are fully loaded.
Water remains after a cycle finishes	Drain hose is bent or clogged.	Straight hose.
Food Soil remains on dishes	Improper cycle selection	Select right cycle based on dish types and soil toughness.
	Water temperature is low.	Use hot water faucet.
	Dishwashing detergent was not used.	Use recommended detergents.
	Low inlet water pressure	Water pressure should range between 20 ~ 120psi.
	Water jet holes of spray arms blocked.	Clean the arm.
	Improper dish loading	Dishes shouldn't interrupt arm rotation and detergent dispensing.
Spots and filming on dishes	Low water temperature	Supplied water temperature should be 120°F for the best washing performance.
	Proper detergent amount used	Use the recommended amount of detergent.
	Overloading	Load the proper amount of dishes.
	Improper loading	Rearrange dish loading referring to photo at page 10 & 11.
	Insufficient water pressure	Adjust water pressure between 20 and 120 psi.
	Insufficient detergent	Add the recommended amount of detergent referring to detergent instructions.
	Rinse aid dispenser empty.	Refill the Rinse aid dispenser.
	Extremely hard water	Install home water softener.
Noise	This is normal.	Detergent cover opening. Drainage Sound at the early stage.
	Your Dishwasher isn't horizontal.	Reposition your dishwasher.
	Nozzle arm knocks against the dishes.	Reposition your dishes.
Cloudiness on glassware	Combination of excessive detergent and soft water	Underload the dishwasher and use a rinse aid to minimize this process.
Black or gray marks on dishes	Aluminum items rub dishes during cycle.	Remove aluminum markings with a mild cleaner.
Yellow or brown film on inside surfaces	Coffee or tea soils	Eliminate the soil by using a stain removal product.
Dishes don't dry	Rinse agent dispenser empty.	Check and refill the rinse agent if empty.
The lamps don't illuminate	Power is not connected.	Connect power supply.
	Fuse is blown out or circuit breaker is tripped.	Replace fuse and repair circuit breaker.
Spray arms don't rotate smoothly	The holes of spray arms is blocked by food particles.	Clean the holes of the spray arms.
Upper rack crooked after loading	Rack is poorly adjusted.	Adjust the upper rack properly referring to page 10.
IE Error	Water inlet trouble	Check clogging of water inlet hose (or hose twist or freezing).
		Check water supply.
OE Error	Drainage trouble	Check clogging of water drain hose (or twist or freezing).
FE Error	Excessive water supplied	Please call your Authorized Service Center or LGE Customer Service at 1-800-243-0000.
E1 Error	Water leakage trouble	
HE Error	Heater Circuit Failure	
TE Error	Thermistor trouble or very high inlet water temperature. (over 194°F)	

If you can't fix problems with the above actions or you have different problems which are not mentioned in the manual, please call LGE Customer Service at 1-800-243-0000.

WARRANTY



LG ELECTRONICS, INC. LG Washing Machine Limited Warranty - USA

Your LG Dishwasher will be repaired or replaced, at LG's option, if it proves to be defective in material or workmanship under normal use, during the warranty period ("Warranty Period") set forth below, effective from the date ("Date of Purchase") of original consumer purchase of the product. This warranty is good only to the original purchaser of the product and effective only when used in the United States, including Alaska, Hawaii, and U.S. Territories.

WARRANTY PERIOD:

LABOR: One Year from the Date of Purchase.

PARTS (except as listed below): One Year from the Date of Purchase.

Electronic Control Board: 5 Years from the Date of Purchase.

Dishwasher Rack: 5 Years from the Date of Purchase.

Stainless Steel Door Liner and Tub: Lifetime (as long as owned by the original purchaser)

Replacement Units and Repair Parts may be new or factory remanufactured.

Replacement Units and Repair Parts are warranted for the remaining portion of the original unit's warranty period.

HOW SERVICE IS HANDLED:

In-Home Service: Please retain dealer's dated bill of sale or delivery ticket as evidence of the Date of Purchase for proof of warranty, and submit a copy of the bill of sale to the service person at the time warranty service is provided.

Please call 1-800-243-0000 and choose the appropriate option to locate your nearest LG Authorized Service Center.

Or visit our website at : <http://www.lgservice.com>.

THIS WARRANTY IS IN LIEU OF ANY OTHER WARRANTY, EXPRESS OR IMPLIED, INCLUDING WITHOUT LIMITATION, ANY WARRANTY OF MERCHANTABILITY OR FITNESS FOR A PARTICULAR PURPOSE. TO THE EXTENT ANY IMPLIED WARRANTY IS REQUIRED BY LAW, IT IS LIMITED IN DURATION TO THE EXPRESS WARRANTY PERIOD ABOVE. NEITHER THE MANUFACTURER NOR ITS U.S. DISTRIBUTOR SHALL BE LIABLE FOR ANY INCIDENTAL, CONSEQUENTIAL, INDIRECT, SPECIAL, OR PUNITIVE DAMAGES OF ANY NATURE, INCLUDING WITHOUT LIMITATION, LOST REVENUES OR PROFITS, OR ANY OTHER DAMAGE WHETHER BASED IN CONTRACT, TORT, OR OTHERWISE. Some states do not allow the exclusion or limitation of incidental or consequential damages or limitations on how long an implied warranty lasts, so the above exclusion or limitation may not apply to you. This warranty gives you specific legal rights and you may also have other rights that vary from state to state.

THIS LIMITED WARRANTY DOES NOT APPLY TO:

- Service trips to your home to deliver, pick up, and/or install the product, instruct, or replace house fuses or correct wiring, or correction of unauthorized repairs.
- Damages or operating problems that result from misuse, abuse, operation outside environmental specifications or contrary to the requirements of precautions in the Operating Guide, accident, vermin, fire, flood, improper installation, acts of God, unauthorized modification or alteration, incorrect electrical current or voltage, or commercial use, or use for other than intended purpose.

The cost of repair or replacement under these excluded circumstances shall be borne by the consumer.

CUSTOMER INTERACTIVE CENTER NUMBERS

To obtain Customer Assistance, Product Information. Or Dealer or Authorized Service Center location.

Call 1-800-243-0000 (24 hours a day, 365 days per year) and select the appropriate option from the menu. Or visit our website at : <http://www.lgservice.com>

TO CONTACT LG ELECTRONICS BY MAIL:

LG Customer Interactive Center
P.O. Box 240007
201 James Record Road
Huntsville, Alabama 35824
ATTN: CIC



LG Electronics Inc.